



Lumin Smart Panel

DOCUMENTATION AND INSTALLATION MANUAL



U.S. Patent No. 10,109,987

U.S. Patent No. 10,467,712

Canadian Patent No. 3,050,702

U.S. and International Patent Applications Pending.

® U.S. Registered Trademark.

Copyright © 2022 Coulomb, Inc. (DBA Lumin). All rights reserved.

TABLE OF CONTENTS

INTRODUCTION.....	1
READ BEFORE USE	2
Warnings	2
SYSTEM DESIGN CONSIDERATIONS	3
INSTALLATION.....	4
Items in the Box.....	4
Required Materials (Not Included).....	5
Required Tools.....	6
Hardware Installation Overview.....	7
Hardware Installation Steps	8
Configuration and Account Setup.....	32
TROUBLESHOOTING AND REPAIRS	33
End User	33
Qualified Installer	33
OPERATIONAL INFORMATION	34
PRODUCT SPECIFICATIONS.....	35
LIMITED WARRANTY FOR LUMIN SMART PANEL.....	36
RADIO FREQUENCY STATEMENT	37



This page intentionally left blank

INTRODUCTION

Welcome! The Lumin Smart Panel (LSP) is a standalone product that extends the capability of an existing circuit breaker panel (or “electrical panel”) by providing measurement and remote control of up to twelve (12) circuits in a home or building. The function of the circuit breaker panel remains the same and is not impacted. The LSP securely and safely transmits real-time consumption information to the cloud via Ethernet connection (preferred) or customer Wi-Fi.

Data and system controls can be accessed via the Lumin mobile app or the web-based Lumin dashboard (app.luminsmart.com). The Lumin app gives customers insights into their energy consumption and energy costs, as well as providing the user with the ability to control or automate their energy use remotely.

NOTE: A Lumin Smart Panel will not function as designed until it is fully commissioned. It is generally the responsibility of the installer to perform both the physical installation and the online setup/commissioning process. Refer to pg. 32 to begin the setup process. All personnel installing this product should complete Lumin Certified Installer Training prior to installation. Scan below to register for training.



Need help? For installation assistance please contact Lumin by e-mail at support@luminsmart.com or by phone at 1-888-421-0616 (North America).



DANGER: HAZARDOUS VOLTAGES PRESENT DURING INSTALLATION AND SERVICING. PRECAUTIONS AND QUALIFICATIONS REQUIRED. REFER TO THE FOLLOWING PAGE.



DANGER: TENSIONS DANGEREUSES PRÉSENTES LORS L'INSTALLATION ET L'ENTRETIEN. PRÉCAUTIONS ET QUALIFICATIONS REQUISES. REPORTEZ-VOUS À LA PAGE SUIVANTE.



READ BEFORE USE

The LSP is compatible with both flush-mounted (i.e., set within drywall) existing electrical panels and surface-mounted electrical panels. Please determine which electrical panel type the LSP will be connecting to and follow the corresponding installation steps outlined in this manual. Devices with LSP-12-IR and TPU-IR model numbers must be installed indoors. Please review the product's technical ratings and specifications (pg. 35) to confirm it is suitable for your application prior to installation.

NOTE: The *LSP Circuit Label & CT Table* (provided with the LSP) must be completed and delivered to the home/building owner upon the successful installation of the LSP. A completed *LSP Circuit Label & CT Table* is required in order to complete LSP setup.



Warnings

LSP installation and servicing involves dangerous voltages that can cause injury or death. In addition to specific instructions accompanied by the  symbol throughout this booklet and product labeling, observe the following safety precautions:

- Installation and servicing must be conducted by a qualified professional, according to local and national electrical codes
- Lumin Certified Installer training is required for installation and servicing
- Review entire manual before starting the installation or servicing
- Personal protective equipment should be worn when installing or servicing the product
- Do not install or operate the LSP other than intended or outside the conditions specified on pg. 35
- Do not open, attempt to access, or touch any internal product parts — dangerous voltages would be exposed even if main service feed is disconnected
- Do not use the product if it is damaged or appears to be damaged
- Use only the wires and cables supplied with the product
- Power relays are evaluated for 100,000 cycles at a 1.5 HP inductive load (e.g., motors) — larger loads of this type may result in premature relay failure
- The product warranty does not cover damage due to lightning. Lumin recommends the installation of a whole-house surge protector to prevent product damage due to lightning strike

SYSTEM DESIGN CONSIDERATIONS

- The LSP should be mounted so that the connected electrical panel is within reach of the LSP's flexible conduit nipple. Depending on orientation, the nipple extends between 7" and 17" beyond the edge of the LSP enclosure. Ensure that the load center has adequate wiring space for LSP conductors and connections. Suitable junction boxes and conduit may be used to route and/or extend LSP conductors if needed. For voltage drop calculations, assume LSP conductors add 15 one-way-feet to the circuit.
- An LSP requires an always-on internet connection, either via **Ethernet (preferred if available)** or 2.4 GHz Wi-Fi.
- When used for energy management, the LSP will be most effective when used to shed heavy discretionary loads. These are loads greater than 15 amps that may be desired during grid outages or other energy-constrained situations. Lumin can shed such loads automatically while permitting a user to manually re-enable them at their discretion. **More information about circuit selection is provided in the required Lumin Certified Installer Training.** In order to shed discretionary loads in response to grid conditions, a **connection to non-backed-up utility grid power** is required for the LSP grid detection circuit. See pg. 28. This will require **wiring beyond the LSP's connected electrical panel.**
- The LSP does not replace the need for standard circuit breakers. Lumin does not provide overcurrent protection, ground fault protection, arc fault detection, or other safety functionality that circuit breakers provide.
- The LSP uses current transformers (CTs) to measure overall power flows. Correct placement of these CTs may require **wiring beyond the LSP's connected electrical panel/s.** See pg. 23.
- If the LSP is configured to automatically shed loads exceeding backup capacity following a grid outage, a Temporary Power Unit (TPU) accessory device may be required if the transfer to backup power takes more than 70 ms. Without the TPU, the LSP could lose power before backup transfer completes, and circuit disconnection would be delayed until after the LSP powers on with the backup source. If unsure about transfer times, **contact Lumin to determine if a given system requires a TPU.** The TPU is surface-mounted near the LSP and connected with an included cable.

Need help? For system design and installation assistance please contact Lumin by e-mail at support@luminsmart.com or by phone at 1-888-421-0616 (North America).

INSTALLATION

Items in the Box

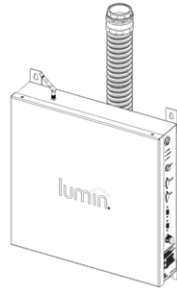

1 LSP with Conduit, Conduit Bushings & Wire Whips Attached

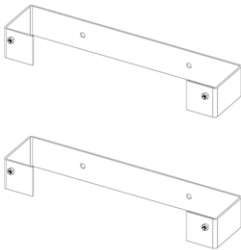

2 Mounting Brackets
(Surface-mounted installation)

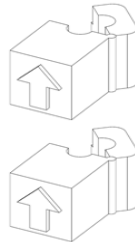

1 Pair of 200A Current Transformers
(A second pair is optional)



1 Temporary Power Unit (TPU) & LSP-TPU Connection Cable
(Optional equipment; see pg. 3)

NOTE: Additional items include an antenna, installation hardware, *Lumin Identifier Sticker Sheet*, and an *LSP Circuit Label & CT Table*.

Required Materials (Not Included)



Wire splice connectors



Pen or marker

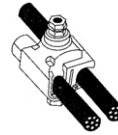

Supply-side/line-side tap
(Optional)



Cable ties (Optional)



Electrical tape (Optional)

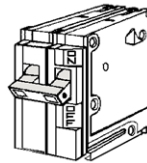

Dual-pole breaker: 15 to 20 amps
(Optional)

NOTE: Additional supplies may be required depending on the existing electrical panel installation. A NON-GFCI dual-pole breaker of 15 to 20 amps may be required to power the LSP. Appropriately rated, NON-GFCI breakers may be double-tapped depending on local electrical codes. See pg. 17 for more details. A supply-side connection (line-side tap) and/or wire extension may be required for the LSP's Grid Detection Circuit (see pg. 28). Specific wire extension supplies may be required for current transformers (see pg. 26).

Required Tools



Drill

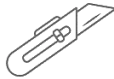

Utility knife

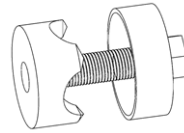

**2" Knockout punch
(2-3/8" hole size)**

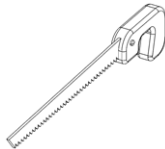

Drywall saw (optional)



Tape measure

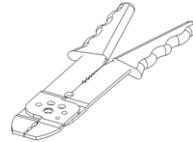

Wire stripper

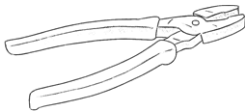

Pliers



Stud-finder (optional)



Fish tape (optional)

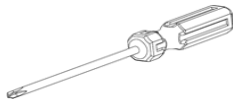

Phillips screwdriver

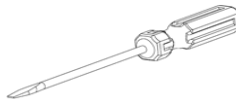

Flathead screwdriver

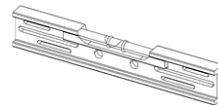

Level (optional)

NOTE: A multimeter may be required for determining current transformer placement (see pg. 25).

Hardware Installation Overview

- STEP 1. Turn Off Main Feed and Remove Electrical Panel Cover
- STEP 2. (Flush-Mount Only) Cut and Remove Drywall
- STEP 3. Knock Out or Punch One Hole for 2" Conduit Fitting
- STEP 4. Measure and Mark Hole Locations for Mounting
- STEP 5. (Surface-mount Only) Secure Mounting Brackets to Wall
- STEP 6. Attach LSP Antenna and Guide LSP Wire Whip into Electrical Panel
- STEP 7. Secure LSP to Wall/Bracket and Electrical Panel
- STEP 8. Connect LSP Equipment Grounding Conductor (EGC) to Ground Bar
- STEP 9. Identify A-Row and B-Row Breakers
- STEP 10. Connect LSP Power Circuit and Label Breaker
- STEP 11. Select Circuit Breaker to Connect to LSP, Turn Off, and Disconnect Load
- STEP 12. Connect One LSP Wire Labeled "Line # Breaker" to Circuit Breaker
- STEP 13. Connect Corresponding LSP Wire Labeled "Line # Load" to Load and Turn Circuit Breaker Back On
- STEP 14. Record Circuit Label/Name and Breaker Row (A/B) With Corresponding LSP Wire Number
- STEP 15. Repeat Steps 11-14 Until All LSP Line # Wires Are Connected
- STEP 16. Determine Placement of Current Transformers (CTs)
- STEP 17. Phase Conductors Monitored by Current Transformers
- STEP 18. Testing for Crossover before Current Transformer Placement
- STEP 19. Connecting Current Transformers
- STEP 20. Record Line Name(s) of Corresponding Current Transformers
- STEP 21. Connect the LSP's Grid Detection Circuit (GDC) Wires to the Grid Side of an Automatic Transfer Switch (ATS) or Microgrid Interconnect Device (MID)
- STEP 22. Connect TPU to LSP (Optional)
- STEP 23. Replace Electrical Panel Cover and Turn On Main Feed
- STEP 24. Circuit Labeling (Optional)



Hardware Installation Steps

STEP 1. Turn Off Main Feed and Remove Electrical Panel Cover

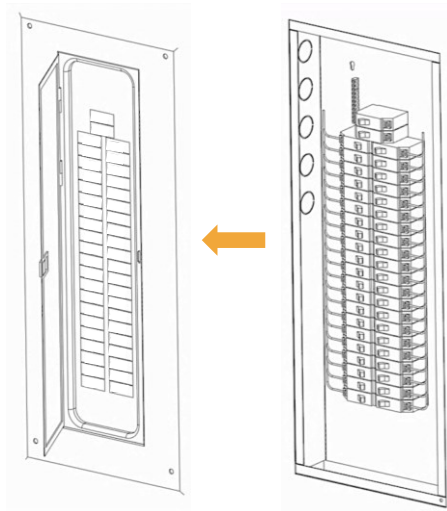

WARNING: HIGH VOLTAGE. ENSURE MAIN BREAKER IS OFF. MAIN SERVICE LINES ARE ALWAYS LIVE.
AVERTISSEMENT: HAUTE TENSION. ASSUREZ-VOUS QUE LE DISJONCTEUR PRINCIPAL EST ÉTEINT. LES CONDUCTEURS DE SERVICE PRINCIPAUX SONT TOUJOURS SOUS TENSION.

Tools: Screwdriver

STEP 2. (Flush-Mount Only) Cut and Remove Drywall

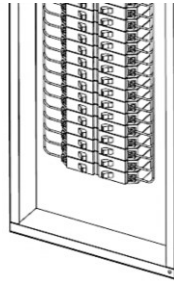

Drywall Cutout Option A

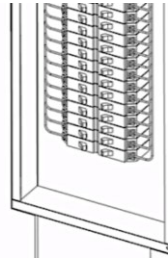

Drywall Cutout Option B



WARNING: HIGH VOLTAGE. ENSURE MAIN BREAKER IS OFF. ENSURE CUTTING PATH IS FREE OF ELECTRICAL CONDUCTORS.

AVERTISSEMENT: HAUTE TENSION. ASSUREZ-VOUS QUE LE DISJONCTEUR PRINCIPAL EST ÉTEINT. ASSUREZ-VOUS QUE LE CHEMIN DE COUPE EST EXEMPT DE CONDUCTEURS ÉLECTRIQUES.

Tools: Tape measure, level (optional), stud finder (optional), and drywall saw or suitable alternative

NOTE: Cut and remove enough wall material to accommodate the LSP's wire whips. Consider drywall cutout "Option B" if additional space is required to accommodate the LSP's wire whips and properly access the electrical panel for Step 3.

STEP 3. Knock Out or Punch One Hole for 2" Conduit Fitting

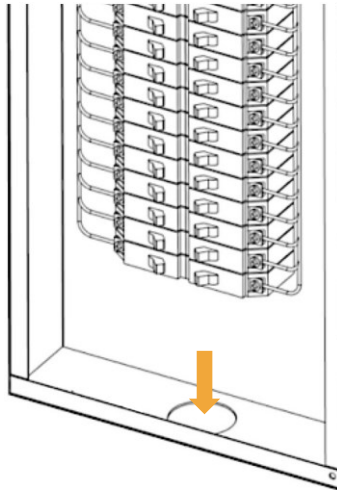

 **WARNING: HIGH VOLTAGE. ENSURE MAIN BREAKER IS OFF. MAIN SERVICE LINES ARE ALWAYS LIVE.**
AVERTISSEMENT: HAUTE TENSION. ASSUREZ-VOUS QUE LE DISJONCTEUR PRINCIPAL EST ÉTEINT. LES CONDUCTEURS DE SERVICE PRINCIPAUX SONT TOUJOURS SOUS TENSION.

Tools: Screwdriver, pliers, drill (optional), and knockout punch (optional)

NOTE: Hole location in electrical panel may vary depending on spacing constraints. The installer should choose a location that avoids existing obstructions and provides adequate clearance for routing of the LSP wire whips. The hole location can be below as shown, above, or to either side of the electrical panel as appropriate. Use of existing pre-stamped 2" knockouts are acceptable provided there is sufficient clearance. Otherwise, a 2" knockout punch (2-3/8" hole) will be required to attach the LSP conduit.

STEP 4. Measure and Mark Hole Locations for Mounting

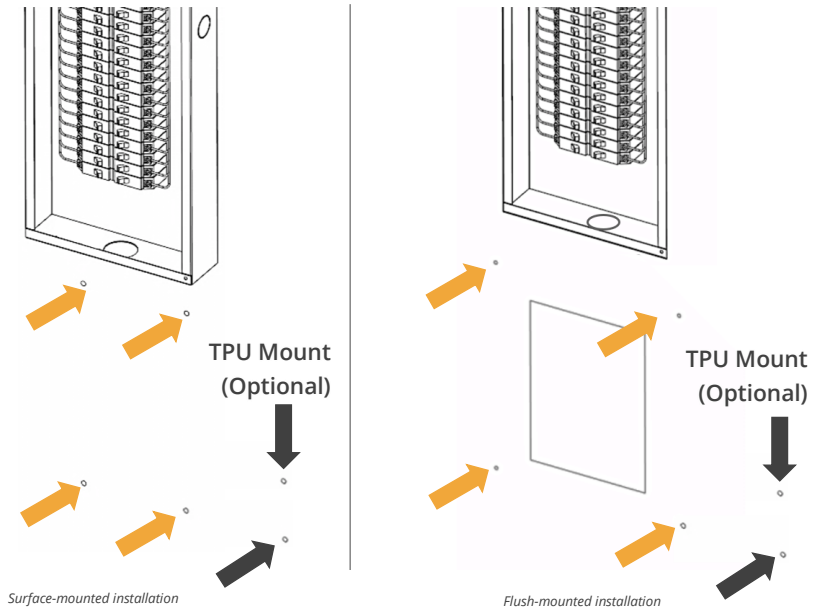

Tools: Tape measure, marker, stud-finder (optional), and level (optional)

NOTE: Mark the applicable hole locations for the installation type (flush-mount vs. surface-mount with mounting brackets). Exact hole locations may vary depending on existing conditions. Qty 4 holes are required for the LSP. Qty 2 additional holes are required if the optional TPU was purchased (see pg. 3).

NOTE: Alternative Installation Method: Installers may find it easier to route the wire whip into the electrical panel and attach the conduit to the electrical panel before determining the mounting hole locations. See Steps 6 and 7 for more details.

STEP 5. (Surface-mount Only) Secure Mounting Brackets to Wall

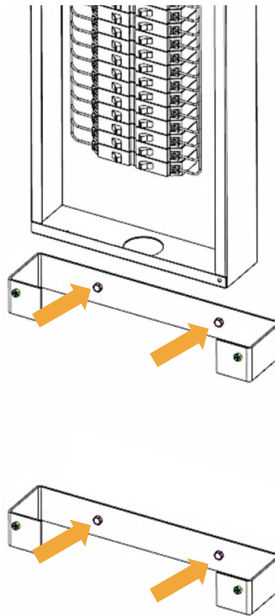

Tools: Drill, stud-finder (optional), screws (x4), and washers (x4)

NOTE: Ensure all screws are securely threaded into studs or suitable anchor systems.

STEP 6. Attach LSP Antenna and Guide LSP Wire Whip into Electrical Panel

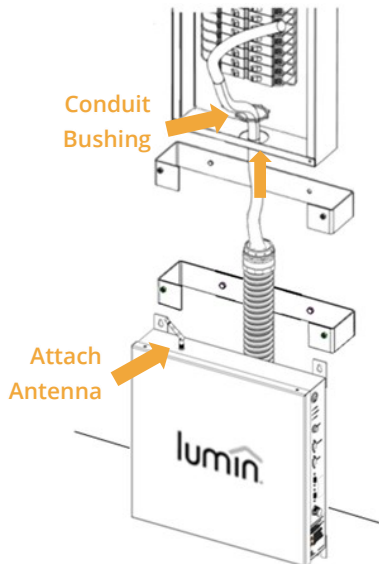

Surface-mounted installation

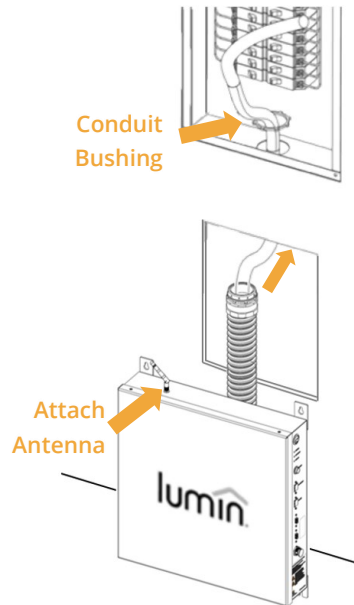

Flush-mounted installation



WARNING: HIGH VOLTAGE. ENSURE MAIN BREAKER IS OFF. MAIN SERVICE LINES ARE ALWAYS LIVE.
AVERTISSEMENT: HAUTE TENSION. ASSUREZ-VOUS QUE LE DISJONCTEUR PRINCIPAL EST ÉTEINT. LES CONDUCTEURS DE SERVICE PRINCIPAUX SONT TOUJOURS SOUS TENSION.

NOTE: Attach the antenna provided with the LSP and then guide the wire whip through the hole in the electrical panel. Remove the conduit bushing before guiding the wire whip through the hole.

STEP 7. Secure LSP to Wall/Bracket and Electrical Panel

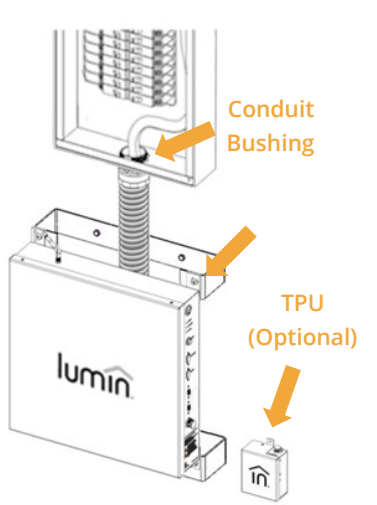

Surface-mounted installation

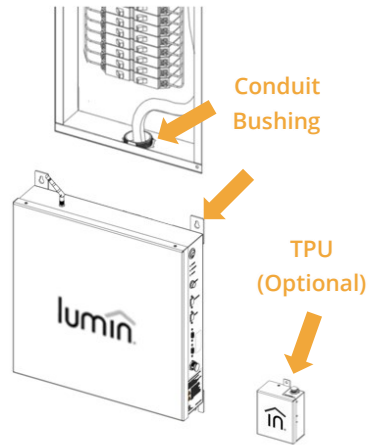

Flush-mounted installation



WARNING: HIGH VOLTAGE. ENSURE MAIN BREAKER IS OFF. MAIN SERVICE LINES ARE ALWAYS LIVE.
AVERTISSEMENT: HAUTE TENSION. ASSUREZ-VOUS QUE LE DISJONCTEUR PRINCIPAL EST ÉTEINT. LES CONDUCTEURS DE SERVICE PRINCIPAUX SONT TOUJOURS SOUS TENSION.

Tools: LSP: Drill, screws (x4), washers (x4), and nuts (x4; surface-mount only)
 TPU: Drill and screws (x2) (optional)

NOTE: Lift the LSP to align with the mounting holes and secure it directly to the wall (flush-mount installation — ensure all screws are securely threaded into studs or suitable anchor systems) or mounting brackets (surface-mount installation) utilizing the hardware provided. Secure the LSP to the electrical panel with the 2" conduit bushing provided. For the optional TPU (see pg. 3), align with the mounting holes and secure it directly to the wall (ensuring both screws are securely threaded into studs or suitable anchor systems) utilizing the hardware provided.

STEP 8. Connect LSP Equipment Grounding Conductor (EGC) to Ground Bar

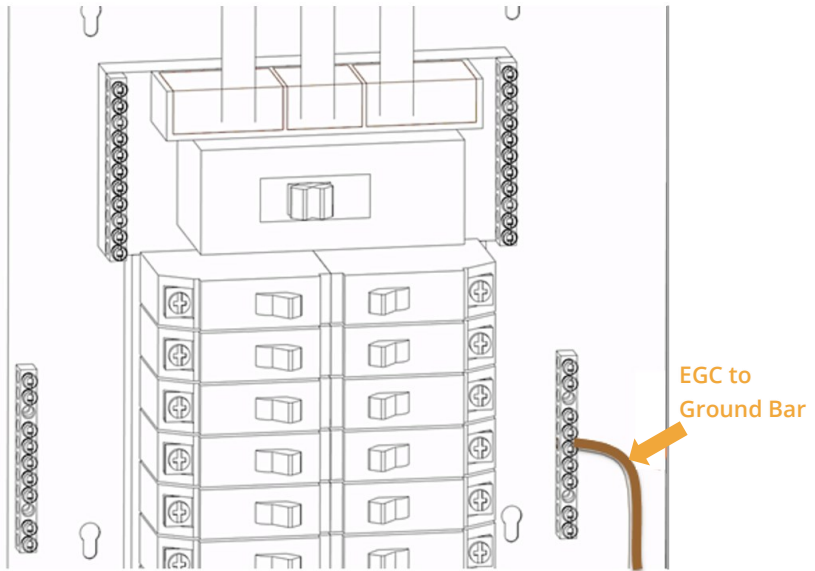

WARNING: HIGH VOLTAGE. ENSURE MAIN BREAKER IS OFF. MAIN SERVICE LINES ARE ALWAYS LIVE. GROUND WIRE MUST BE INSTALLED FOR SAFETY.

AVERTISSEMENT: HAUTE TENSION. ASSUREZ-VOUS QUE LE DISJONCTEUR PRINCIPAL EST ÉTEINT. LES CONDUCTEURS DE SERVICE PRINCIPAUX SONT TOUJOURS SOUS TENSION. UN FIL DE TERRE DOIT ÊTRE INSTALLÉ POUR LA SÉCURITÉ.

Tools: Screwdriver and pliers (optional)

NOTE: Connect the EGC (bare copper wire) from the LSP to the existing ground bar in the electrical panel (exact location of ground bar may vary).

STEP 9. Identify A-Row and B-Row Breakers

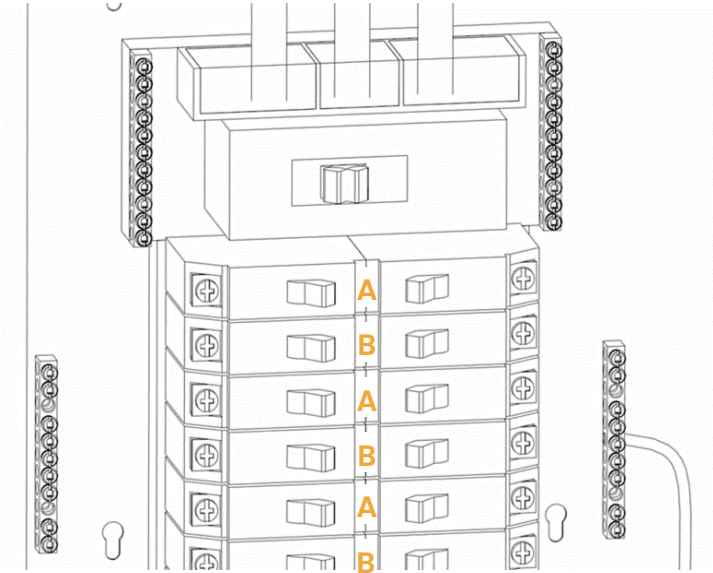

NOTE: For purposes of Lumin installation, the top row of breakers will *always* be classified as “A”. The second row of standard breakers will be “B”. The alternating A-B-A-B pattern continues down the rows of breakers. **Exception:** All breaker rows are designated “A” in panels with two-wire single-phase power rather than three-wire single-phase (split phase).

NOTE: If the load center contains tandem or “skinny” breakers, there will be two breakers in a standard breaker space. Thus, the top-to-bottom breaker panel will be A-A-B-B-A-A-B-B.

STEP 10. Connect LSP Power Circuit and Label Breaker

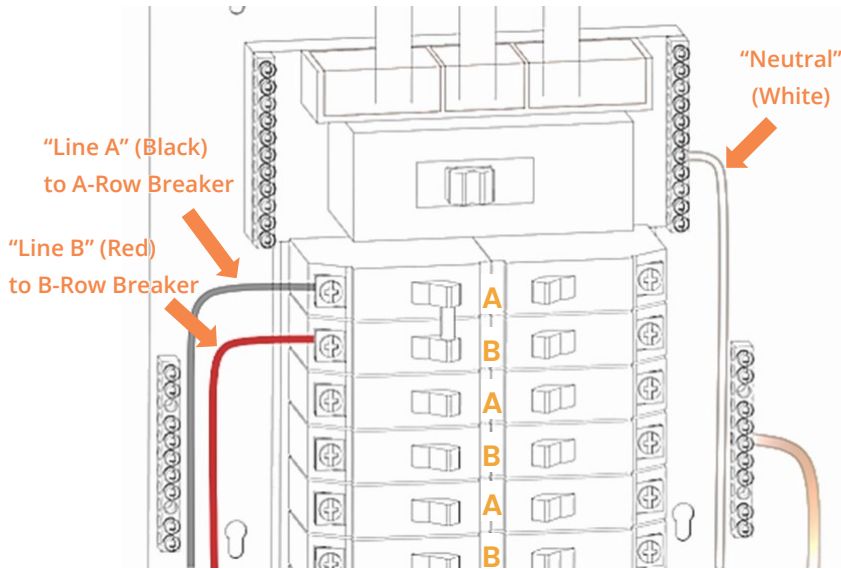

WARNING: HIGH VOLTAGE. ENSURE MAIN BREAKER IS OFF. MAIN SERVICE LINES ARE ALWAYS LIVE.
AVERTISSEMENT: HAUTE TENSION. ASSUREZ-VOUS QUE LE DISJONCTEUR PRINCIPAL EST ÉTEINT. LES CONDUCTEURS DE SERVICE PRINCIPAUX SONT TOUJOURS SOUS TENSION.

Tools: Screwdriver, pliers, and wire stripper

NOTE: Connect the LSP wires as pictured to the existing neutral bar and a double-pole 15- to 20-amp breaker, landing Line A on an A-row breaker terminal and Line B on a B-row breaker terminal.

Exception: Use a single-pole breaker for "Line A" and securely cap "Line B" in panels with two-wire single-phase power rather than three-wire single-phase (split phase). Mark the breaker with a clearly identifying label (ex. "Lumin Smart Panel Power"). **DO NOT CONNECT THESE CONDUCTORS TO GFCI BREAKERS.** Do not double-tap breakers unless they are appropriately rated.

STEP 11. Select Circuit Breaker to Connect to LSP, Turn Off, and Disconnect Load

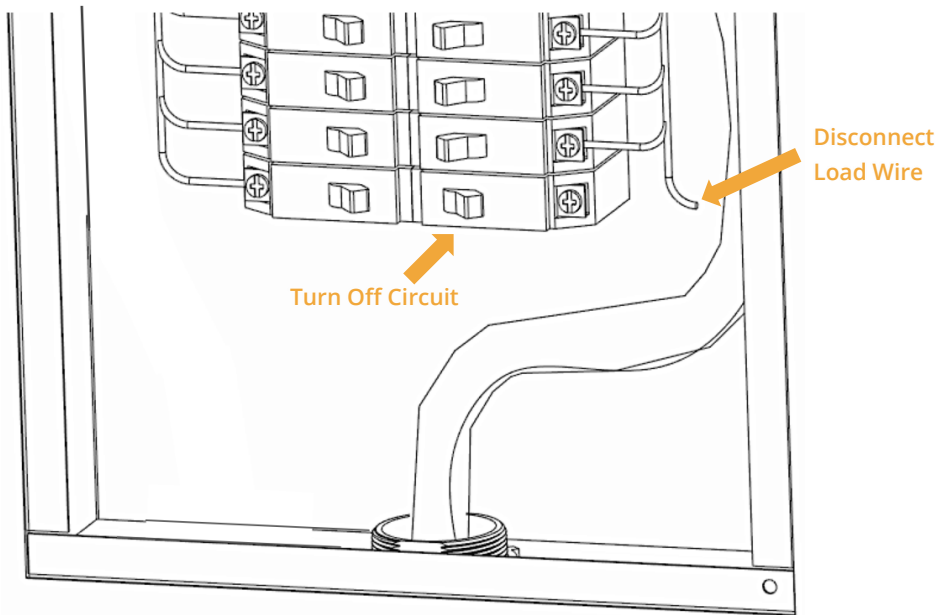

⚠ WARNING: HIGH VOLTAGE. ENSURE MAIN BREAKER IS OFF. MAIN SERVICE LINES ARE ALWAYS LIVE.
AVERTISSEMENT: HAUTE TENSION. ASSUREZ-VOUS QUE LE DISJONCTEUR PRINCIPAL EST ÉTEINT. LES CONDUCTEURS DE SERVICE PRINCIPAUX SONT TOUJOURS SOUS TENSION.

Tools: Screwdriver

NOTE: Breaker labels should be marked to indicate that the load connects to the LSP. **In typical applications, do not connect breakers that power the router(s)/modem(s) that provide the LSP internet connection.**

STEP 12. Connect One LSP Wire Labeled “Line # Breaker” to Circuit Breaker

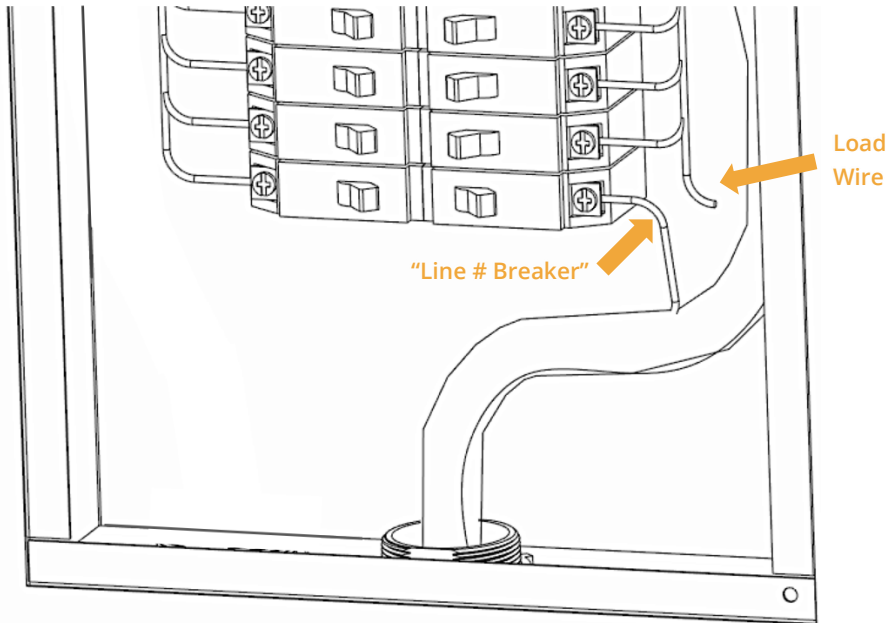

WARNING: HIGH VOLTAGE. ENSURE MAIN BREAKER IS OFF. MAIN SERVICE LINES ARE ALWAYS LIVE.
AVERTISSEMENT: HAUTE TENSION. ASSUREZ-VOUS QUE LE DISJONCTEUR PRINCIPAL EST ÉTEINT. LES CONDUCTEURS DE SERVICE PRINCIPAUX SONT TOUJOURS SOUS TENSION.

Tools: Screwdriver and wire stripper

NOTE: All LSP wires labeled “Line # Breaker” must connect to a breaker or be safely terminated with a wire connector/cap. Lines 1-6 (6 AWG wire) can connect to circuit breakers rated up to 60 amps and lines 7-12 (10 AWG wire) can connect to circuit breakers rated up to 30 amps (see pg. 35).

STEP 13. Connect Corresponding LSP Wire Labeled “Line # Load” to Load and Turn Circuit Breaker Back On

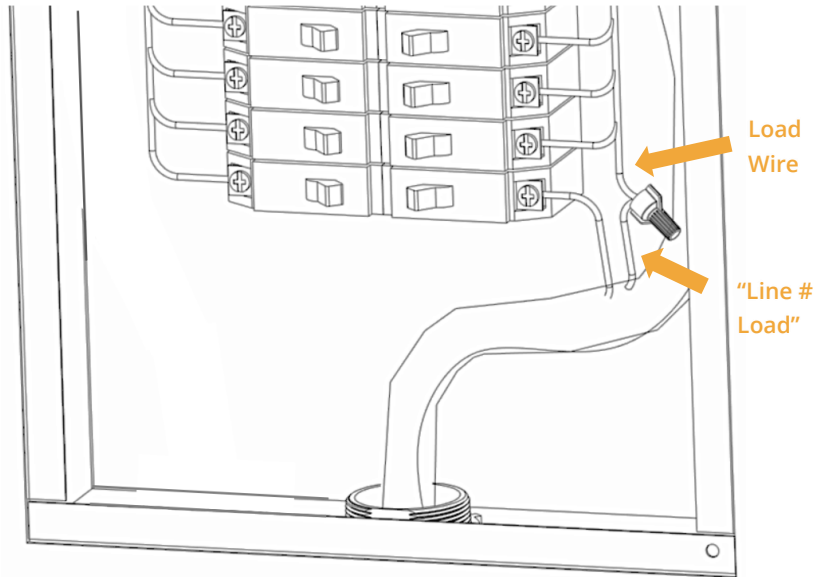

WARNING: HIGH VOLTAGE. ENSURE MAIN BREAKER IS OFF. MAIN SERVICE LINES ARE ALWAYS LIVE.
AVERTISSEMENT: HAUTE TENSION. ASSUREZ-VOUS QUE LE DISJONCTEUR PRINCIPAL EST ÉTEINT. LES CONDUCTEURS DE SERVICE PRINCIPAUX SONT TOUJOURS SOUS TENSION.

Tools: Wire stripper and wire splice connector

NOTE: All LSP wires labeled “Line # Load” must connect to a load wire via a wire splice connector (ensuring a tight connection) or be safely terminated with a Wire Connector. The LSP wire line number must match the line number used in the previous step (ex. “Line 3 Breaker” connects to a breaker and “Line 3 Load” connects to that breaker’s load).

STEP 14. Record Circuit Label/Name and Breaker Row (A/B) With Corresponding LSP Wire Number

LSP LINE #	BREAKER ROW (circle one)	CIRCUIT BREAKER LABEL/NAME	LSP LINE #	BREAKER ROW (circle one)	CIRCUIT BREAKER LABEL/NAME
1	A	<i>Refrigerator</i> Single-pole circuit	7	A	
	B				
2	A	<i>Range</i> Double-pole circuit	8	A	
	B				
3	A	<i>Range</i>	9	A	
	B				
4	A		10	A	
	B				
5	A		11	A	
	B				
6	A		12	A	
	B				
		CURRENT TRANSFORMER (CT)			CURRENT TRANSFORMER (CT)
Line A/B CTs			Aux. A/B CTs (Optional)		

NOTE: Record the circuit label/name and breaker row (A or B) with the corresponding LSP line number in the *LSP Circuit Label & CT Table* provided with the LSP (ex. record “Refrigerator” next to LSP Line 1 and circle Breaker Row “B” if the circuit labeled “Refrigerator” is connected to a B-row breaker and is connected to LSP Line 1). Double-pole circuit breakers will require two LSP wiresets, and thus two LSP line numbers.

STEP 15. Repeat Steps 11-14 Until All LSP Line # Wires Are Connected

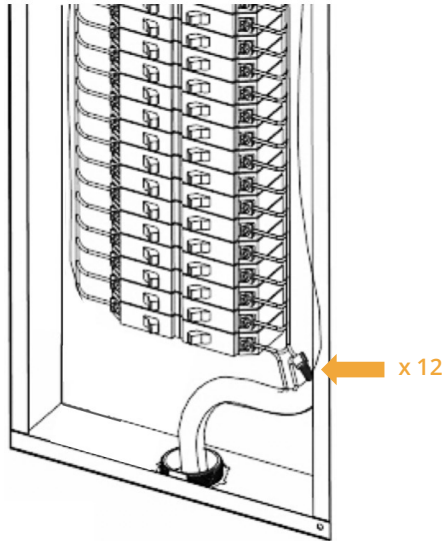

WARNING: HIGH VOLTAGE.
AVERTISSEMENT: HAUTE TENSION.

Tools: Screwdriver, wire stripper, and wire splice connectors

NOTE: All LSP wires labeled “Breaker” must connect to a breaker. Lines 1-6 (6 AWG wire) can connect to circuit breakers rated up to 60 amps and lines 7-12 (10 AWG wire) can connect to circuit breakers rated up to 30 amps (see pg. 35).

NOTE: The LSP can connect to up to 12 single-pole (or six double-pole) circuit breakers. Each hot leg of a double-pole circuit must be connected to its own numbered Lumin wireset (ex. LSP controls a clothes dryer. Dryer Leg “A” is connected to LSP Line 3. Dryer Leg “B” is connected to LSP Line 4).

STEP 16. Determine Placement of Current Transformers (CTs)

DO NOT INSTALL CTs UNTIL PROPER LOCATION AND PHASING HAVE BEEN DETERMINED.

Each LSP is supplied with one set of two (2) 200-amp current transformers (CTs). The LSP is equipped with leads for these main CTs as well as leads for an optional set of auxiliary CTs which is available for purchase from Lumin. Most LSP installations do not utilize auxiliary CTs and use the main CTs to measure the total consumption of the electrical panel(s) backed up by a battery. In this typical installation, the CTs are placed on the feeders from the Microgrid Interconnect Device (MID) or Automatic Transfer Switch (ATS) to the electrical panel, as shown in Figure A.

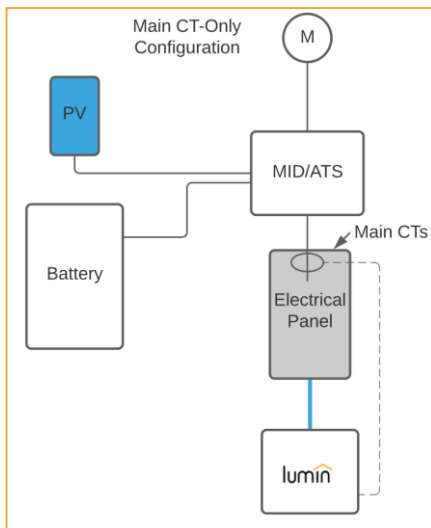
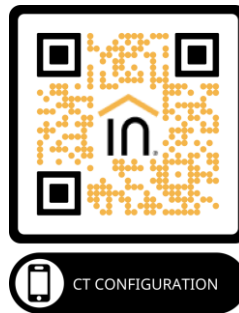

Figure A – Typical CT Configuration

If your installation is configured differently than shown in Figure A or if your installation will utilize auxiliary CTs, consult the Lumin CT configuration guide for CT placement information.



STEP 17. Phase Conductors Monitored by Current Transformers

REMINDER: For the purpose of a Lumin installation, the top* row of breakers in an electrical panel is *always* designated “A”. Whichever feeder leg supplies breaker Row A will be designated “A.”

NOTE: Lumin CTs are designated either “A” or “B”. Placing them on the incorrect leg of a circuit will result in erroneous consumption data.

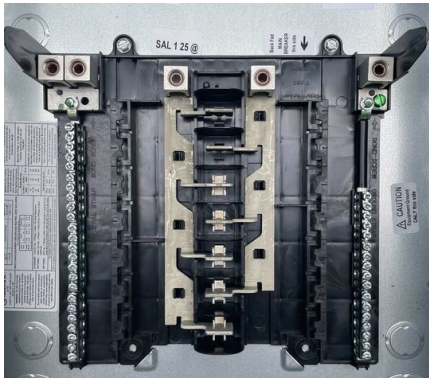

Figure B - Typical Main-Lug-Only Electrical Panel Busing

If the panel is a main-lug-only type as shown in Figure B (no main circuit breaker) then the feeder on the left will be Lumin Leg “A”.

If the panel includes a main circuit breaker, note that the main breaker may contain crossover busing, with the result that the feeder on the left feeds the right-side bus bar and the feeder on the right feeds the left-side bus bar. To identify A/B feeders when a main breaker is present, consult the following page.

* All descriptions assume a top-fed electrical panel.

STEP 18. Testing for Crossover before Current Transformer Placement

To determine A and B feeders when a main circuit breaker is present, test for AC voltage between the left lug and the left bus bar*. If the bus bar is not accessible, test between the left lug and the terminal on the top left circuit breaker. See Figure C.

If V between these points ≈ 240 , the main breaker is a crossover type. Place CT - A on the right and CT - B on the left.

If V between these points ≈ 0 , the main breaker is a standard type. Place CT - A on the left and CT - B on the right.

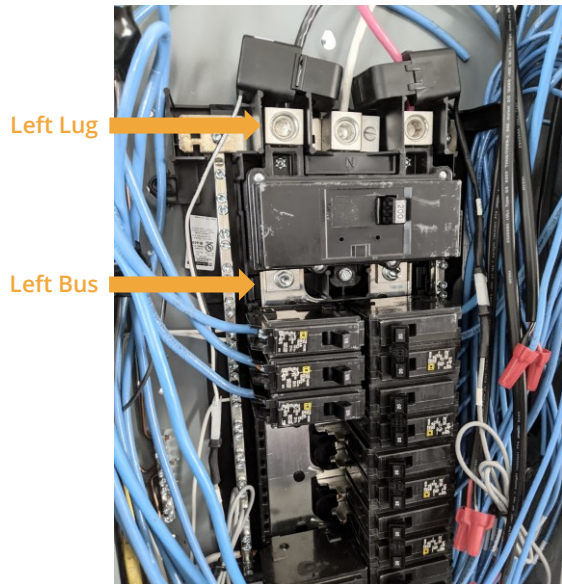

Figure C – Typical Main Breaker Electrical Panel



WARNING: HIGH VOLTAGE.
AVERTISSEMENT: HAUTE TENSION.

Tools: Multimeter

* All descriptions assume a top-fed electrical panel.

STEP 19. Connecting Current Transformers

Prior to installation, measure the CT leads' routing path(s) in the electrical panel. If the provided leads are not long enough, fashion CT wire extensions in the field. Refer to the following documentation for proper extension procedures:



When installing CTs, connect CTs labeled “Line A/B CT” to the 2-pin connector on the corresponding LSP lead **first**. Then clamp the CT around the corresponding feeder leg as determined in the previous steps. The CT marked with “A” should attach to Leg A and the CT marked with “B” should attach to Leg B. Ensure the sticker on the CT reading “This side toward grid” is facing toward the grid/utility meter.



WARNING: HIGH VOLTAGE. MAIN SERVICE LINES ARE ALWAYS LIVE.

AVERTISSEMENT: HAUTE TENSION. LES CONDUCTEURS DE SERVICE PRINCIPAUX SONT TOUJOURS SOUS TENSION.

CAUTION: A CT SHOULD NEVER BE LEFT CLAMPED ON A CONDUCTOR WHEN THE CT WIRING IS DISCONNECTED. SATURATION AND DESTRUCTION OF THE CT CORE MAY RESULT. CONNECT CT WIRING BEFORE CLAMPING. UNCLAMP BEFORE DISCONNECTING CT WIRING.

ATTENTION: UN TRANSFORMATEUR DE COURANT NE DOIT JAMAIS ÊTRE LAISSÉ SERRÉ SUR UN CONDUCTEUR LORSQUE LES FILS DU TRANSFORMATEUR DE COURANT SONT DÉCONNECTÉS. LA SATURATION ET LA DESTRUCTION DU NOYAU PEUVENT EN RÉSULTER. CONNECTER LES CÂBLES DU TRANSFORMATEUR DE COURANT AU LSP AVANT L'INSTALLATION. DÉINSTALLER LE TRANSFORMATEUR DE COURANT AVANT DE DÉBRANCHER SON CÂBLE.

STEP 20. Record Line Name(s) of Corresponding Current Transformers

LSP LINE #	BREAKER ROW (circle one)	CIRCUIT BREAKER LABEL/NAME	LSP LINE #	BREAKER ROW (circle one)	CIRCUIT BREAKER LABEL/NAME
1	A		7	A	
	B			B	
2	A		8	A	
	B			B	
3	A		9	A	
	B			B	
4	A		10	A	
	B			B	
5	A		11	A	
	B			B	
6	A		12	A	
	B			B	
		CURRENT TRANSFORMER (CT)			CURRENT TRANSFORMER (CT)
Line A/B CTs		<i>Ex. Main Service Lines</i>	Aux. A/B CTs (Optional)		<i>Ex. Solar Output</i>

NOTE: Record the line name of the corresponding attached CTs in the *LSP Circuit Label & CT Table*. For example, record "Main Service Lines" next to "Line A/B CTs" if the CTs were attached to main feeders.

STEP 21. Connect the LSP's Grid Detection Circuit (GDC) Wires to the Grid Side of an Automatic Transfer Switch (ATS) or Microgrid Interconnect Device (MID)

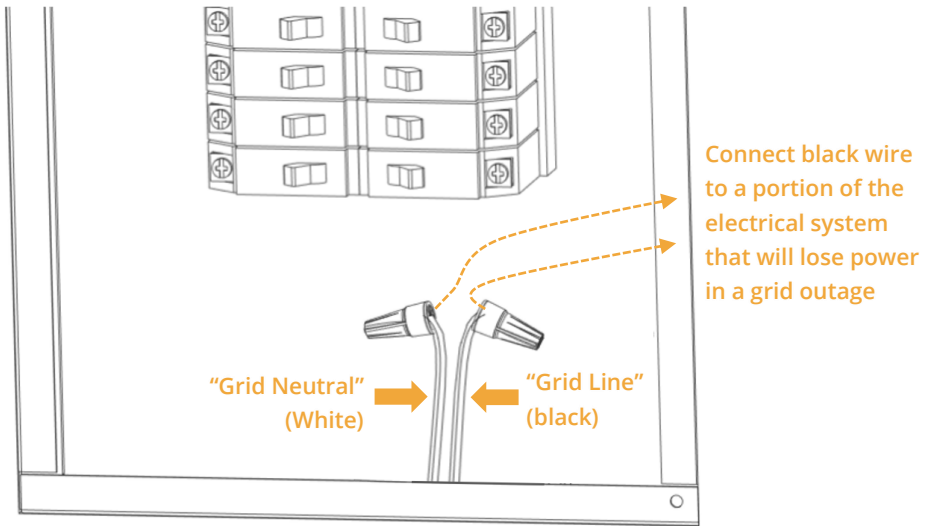

WARNING: HIGH VOLTAGE. ENSURE MAIN BREAKER IS OFF. MAIN SERVICE LINES ARE ALWAYS LIVE.
AVERTISSEMENT: HAUTE TENSION. ASSUREZ-VOUS QUE LE DISJONCTEUR PRINCIPAL EST ÉTEINT. LES CONDUCTEURS DE SERVICE PRINCIPAUX SONT TOUJOURS SOUS TENSION.

Tools: Wire stripper and wire splice connectors

NOTE: The GDC monitors the presence of grid voltage. The GDC must be installed so that it is not backed up by storage. Land the “Grid Neutral” wire at the most upstream neutral bar or terminal possible. Extend the “Grid Line” wire via suitable wire splice connector and land it on non-backed-up circuit breaker or perform a supply-side connection (or “line-side tap”) on a wire that will lose power in a grid outage. **The 12 AWG wires in this circuit must have overcurrent protection per local code.**

STEP 22. Connect TPU to LSP (Optional)

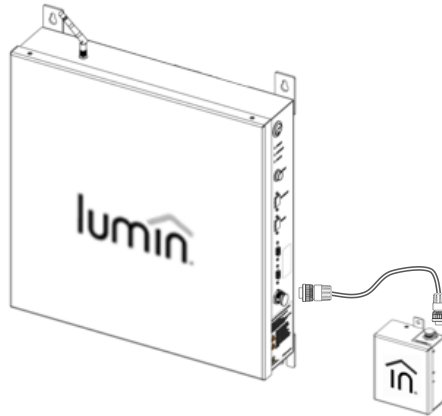

Tools: Cable ties (optional)

NOTE: Connect the TPU to the LSP using the LSP-TPU Connection Cable provided in the TPU kit. Plug the male connector into the TPU and then connect the female connector to the LSP. Tighten the retaining collar on each connector to secure in place. Optional: Coil excess cable and secure with cable ties. After completing the remainder of the installation process, wait until the indicator on the TPU labeled “Charged” is lit before testing system functionality. Charging time is approximately 10 minutes.

STEP 23. Replace Electrical Panel Cover and Turn On Main Feed

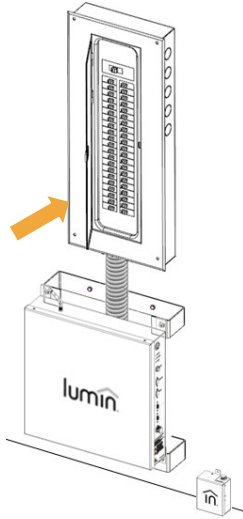

Surface-mounted installation

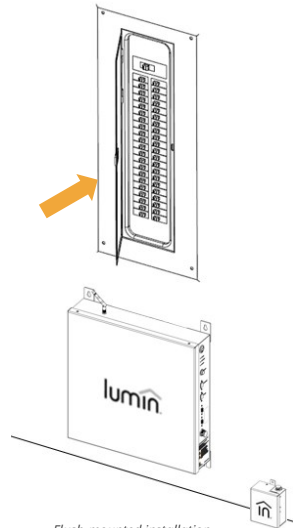

Flush-mounted installation



WARNING: HIGH VOLTAGE. ENSURE MAIN BREAKER IS OFF. MAIN SERVICE LINES ARE ALWAYS LIVE.
AVERTISSEMENT: HAUTE TENSION. ASSUREZ-VOUS QUE LE DISJONCTEUR PRINCIPAL EST ÉTEINT. LES CONDUCTEURS DE SERVICE PRINCIPAUX SONT TOUJOURS SOUS TENSION.

Tools: Screwdriver

NOTE: Please make any necessary drywall repairs (if applicable) and clean up the area around the circuit breaker panel once the LSP installation is completed. Make sure the LSP's antenna is securely attached prior to powering on the device.

STEP 24. Circuit Labeling (Optional)

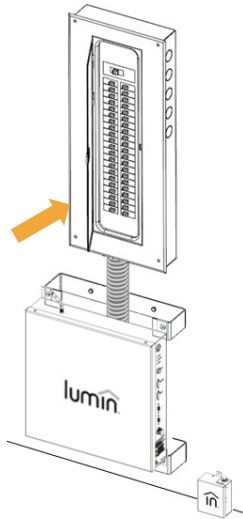

Surface-mounted installation

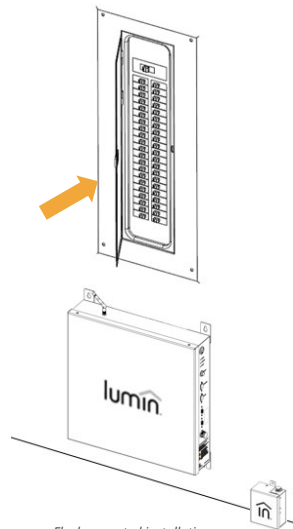

Flush-mounted installation



WARNING: ELECTRICAL CODES MAY REQUIRE ADDITIONAL LABELING.

AVERTISSEMENT: LES CODES ELECTRIQUES PEUVENT NECESSITER UN ETIQUETAGE SUPPLEMENTAIRE.

Tools: Screwdriver

NOTE: Electrical codes (depending on the installation location) may require additional labeling for energy management systems such as the LSP. The provided installation materials include labels to identify the LSP-managed circuits in the electrical panel, LSP electrical conduit/raceway, and informational QR code labels.



Configuration and Account Setup

1. After completing the hardware installation, flip the LSP power switch to the “on” position (“I”). The blue and green indicator lights will begin blinking in unison, indicating that the LSP is ready for commissioning.
2. If feasible, make an Ethernet connection between the Lumin Smart Panel’s Ethernet port and a LAN port on the location’s router. This Ethernet connection is more reliable than a Wi-Fi connection and is not affected by replacing the router or resetting the Wi-Fi network password.
3. Download the Lumin mobile app. In the Apple App Store or Google Play Store, search for "Lumin Smart".
4. Log in with an existing account or create a new account.
5. Expand the ☰ menu (upper left of screen) and select "Set up a new Lumin Smart Panel".
6. Follow the in-app instructions to set up your Lumin Smart Panel (**completed LSP Circuit Label & CT Table required**). Invite users to grant access to the commissioned LSP.

Need help? For account setup assistance or troubleshooting, please call 1-888-421-0616 (North America) or e-mail support@luminsmart.com.

TROUBLESHOOTING AND REPAIRS

End User

If the LSP is not functioning as expected, ensure that the power switch is on, Internet service is available, antenna/ethernet connection is secure, and breakers are switched on. See Operational Information (pg. 34) on how to read the LSP indicators for internet connectivity status. It is best to obtain assistance from a qualified installer for further troubleshooting of hardware issues. The installer's familiarity with Lumin products and ability to perform electrical work will help resolve issues effectively. Alternatively, contact Lumin directly for assistance.

Qualified Installer

Observe all safety precautions listed on page 2. Never use the LSP to de-energize circuits to perform electrical work. The LSP is not designed for safety disconnecting means; lock-out/tag-out is not possible. Additionally, when not properly connected, the app may incorrectly indicate that a circuit is de-energized, so always assume that the LSP circuits are enabled, and conductors are live. Ensure that the power switch is on, Internet service is available, antenna/ethernet connection is secure, and breakers are switched on. Inspect the system for installation and wiring faults (e.g., loose wire connections). If the issue is not resolved, contact Lumin.

Lumin Certified Installer training is required before Lumin will authorize work on an existing LSP. Case-specific authorization and instruction will be provided by Lumin if applicable. Do not open cover or attempt repairs otherwise — even with the LSP power switch and main feed breakers off, the Grid Detection Circuit (GDC) is connected to hazardous voltages. **The LSP power switch does not de-energize the internal product components.** *Fuses: LSP Power – non-replaceable 2.5 A; GDC – 1 A, slow blow; TPU – 5 A, slow blow.*



DANGER: HAZARDOUS VOLTAGES PRESENT DURING INSTALLATION AND SERVICING. DO NOT OPEN LSP COVER, INSPECT INSTALLATION WIRING, OR ATTEMPT REPAIRS WITHOUT REQUIRED QUALIFICATIONS AND LUMIN AUTHORIZATION. ALWAYS DISCONNECT ELECTRICAL SUPPLY BEFORE PERFORMING REPAIRS.



DANGER: TENSIONS DANGEREUSES PRÉSENTES LORS L'INSTALLATION ET L'ENTRETIEN. NE PAS OUVRIR LE COUVERCLE DU LSP, INSPECTER LE CÂBLAGE D'INSTALLATION OU ESSAYER DE RÉPARER SANS QUALIFICATIONS REQUISES ET AUTORISATION DE LUMIN. TOUJOURS DÉBRANCHER L'ALIMENTATION ÉLECTRIQUE AVANT D'EFFECTUER DES RÉPARATIONS.

OPERATIONAL INFORMATION

LED Indicator	Off	Both Blinking	Just One Blinking	Both Solid
Green	Lumin Server Disconnected	Setup Mode. Wi-Fi connectivity is disabled. Press and release "Setup" button to exit	(When blue is solid) Lumin server error	Fully connected via Wi-Fi
Blue	No Internet Connection via Wi-Fi		Attempting to connect to the internet	

NOTE: Simultaneous blue and green blinking lights indicate that the LSP is in Setup Mode. This is the required mode for initial setup and commissioning, however the LSP does not connect to the internet via Wi-Fi in this mode. If both lights are seen blinking during normal operation, it is likely that the "Setup" button was pressed, taking the LSP offline. In most instances, an additional press-and-release of the "Setup" button will bring the LSP back online. Note that it may take about 45 seconds to restore the connection and display two solid unblinking indicator lights.

NOTE: During an internet outage local connection can be made between an LSP and user's mobile device as long as the device and the LSP are connected to the same network. Ensure that the LSP is not in Setup Mode and that Wi-Fi connectivity is enabled on the mobile device.

NOTE: In the unlikely event that the LSP cannot be controlled via the mobile app or web interface, all Lumin-controlled circuits can be enabled by toggling the Lumin power rocker switch in a particular sequence. To bypass the system, turn LSP power off ("O"), then on ("I"), then off again ("O"). Please contact Lumin support as soon as possible so we can help resolve your issue.



Need help? For additional support documentation, visit <http://luminsmart.freshdesk.com/support/solutions> or scan the code at right:

PRODUCT SPECIFICATIONS

INSTALLATION	
Type	Wall-Mount; Indoor Only
Installer Qualification	Local Electrical Codes and Lumin Certified Installer
Typical Time Required	1.5–4 Hours
Temperature	0°C to 60°C (32°F to 140°F)
Humidity	< 80% RH (Non-Condensing)
Altitude	< 3000 m
Pollution Level	Degree 2
Dimensions	44.6 cm × 44.6 cm × 10.1 cm (17.5 in × 17.5 in × 4.0 in)
Weight	12 kg (27 lb)
Conductor Length	All Extend 76 cm (30 in) Beyond Conduit End
Additional Units	Use of Multiple Lumin Smart Panels Supported
CONNECTIVITY & SECURITY	
Connection Options	Wi-Fi or Ethernet
Internet Bandwidth	Approx. 0.02 Mbps
Wi-Fi Protocols	802.11 b/g/n, 2.4 GHz
Wi-Fi Encryption	WPA and WPA2 Methods
Ethernet Port	1×RJ-45 (10/100/1000 Mbps)
IP Addressing	Dynamic (DHCP)
Cryptographic System	TLS 1.2 (Minimum)
Firewall Outbound Access Required	Ports 53, 123, 443–444, and 50050–50059
USER ACCESS	
Local Network	Live Data and Controls
Applications	iOS, Android, and Web
Data	1-Second Granularity (Averaged from 16 kHz)
Load Controls	Manually/Directly, Automated Schedules, and Automated Modes

ELECTRICAL SYSTEM	
AC Voltage	120/240 VAC Split-Phase, 50–60Hz
Supply Breaker Rating	15–20 A (non-GFCI)
Supply Amperage	0.4 A (Maximum)
Standby Power	6 W
Voltage Fluctuations	±10% from Nominal
Overvoltage	Category III (Building Wiring)
TPU (Optional)	Load Shedding; Supports Toggling All Lines a Minimum of Once During a Power Outage
MANAGED LOADS	
Max. Load Breaker	60 A per Line × 6 Lines and
Ratings up to 50 °C	30 A per Line × 6 Lines
Load Breaker Ratings at 50-60 °C	50 A per Line × 6 Lines and 20 A per Line × 6 Lines
Breaker Types	Single Pole (1 Line) and Dual Pole (2 Lines)
MEASUREMENT	
Accuracy	±0.5% of Load
Monitoring Type	Separate Measurement of Lines (Including Dual-Pole)
Split-Phase Voltage	Separate Line-to-Neutral Potential Measurement
Current Transformers	2 Split-Core 200 A Included; Up to 2 Additional Available
Measurement Category	Loads: CAT III (Mains Distr.) GDC: CAT IV (Mains Source)
SUPPORT & COMPLIANCE	
Warranty	10-Year Limited
Compatible Equipment	All Makes/Models/Brands of Electrical Panels and Breakers
Safety Compliance	Listed to UL and CSA C22.2: 61010-1 & 61010-2-030
Radiofrequency Compliance	47 CFR 15 (FCC) RSS-Gen and RSP-100 (ISED)



LIMITED WARRANTY FOR LUMIN SMART PANEL

This Limited Warranty gives you specific legal rights and you may also have other rights, which vary from state to state. We warrant that during the warranty period, the product will be free from defects in materials and workmanship. We limit the duration and remedies of all implied warranties, including without limitation the warranties of merchantability and fitness for a particular purpose to the duration of this express limited warranty. Some states do not allow limitations on how long an implied warranty lasts, so the above limitations may not apply to you. Our responsibility for defective goods is limited to repair, replacement, or refund as described below in this warranty statement.

Who May Use This Warranty? Coulomb Inc. (d/b/a Lumin), a Delaware corporation located at address 501 Locust Ave, Suite 2, Charlottesville, VA 22902 (“we”) extends this limited warranty only to the consumer who originally activated the product and connected it to a Lumin Account (through <https://www.luminsmart.com/>) and to any subsequent owner or other transferee of the product (“you”).

What Does This Warranty Cover? This limited warranty covers defects in materials and workmanship of the Lumin Smart Panel (the “product”) for the Warranty Period as defined below.

What Does This Warranty Not Cover? This limited warranty does not cover any damage due to: (a) transportation; (b) storage; (c) improper installation; (d) improper use; (e) failure to follow the product instructions; (f) failure to adhere to the product’s technical specifications, including the product’s environmental and electrical ratings; (g) modifications; (h) unauthorized opening of the product’s cover; (i) tampering with the product’s internal components; (j) unauthorized repair; (k) normal wear and tear; or (l) external causes such as accidents, abuse, flooding, lightning strikes, storms, or other actions or events beyond our reasonable control. This limited warranty also does not apply to the software, mobile applications, technology and services provided by Lumin which enable you to remotely access and view data that is collected, stored and transmitted by the product concerning electricity consumption and/or to remotely control electrical circuits which the product is connected to (the “Lumin Service”). Use of the Lumin Service is subject to and governed by the terms of the Lumin Service User Agreement, a copy of which can be accessed at <https://www.luminsmart.com/consent-documentation>. Any warranties provided by Lumin with respect to the Lumin Service are only those warranties expressly set forth in the Lumin Service User Agreement.

What Is the Period Of Coverage? The “Warranty Period” for this limited warranty starts on the date the product is first activated and connected to a Lumin Account through <https://www.luminsmart.com/>) and lasts (a) for two years for the product’s sensor boards and the processor board, including the individual components that makeup the sensor boards and processor board, and (b) for ten years for all other components of the product. The Warranty Period is not extended if we repair or replace the product. We may change the availability of this limited warranty at our discretion, but any changes will not be retroactive.

What Are Your Remedies Under This Warranty? With respect to any defective product during the applicable Warranty Period, we will, in our sole discretion, either: (a) repair or replace such product (or the defective part) free of charge or (b) refund the purchase price of such product. We will also pay for shipping and handling fees to return the repaired or replacement product to you if we elect to repair or replace the defective product.

How Do You Obtain Warranty Service? To obtain warranty service, you must call 1-888-421-0616 or e-mail support@luminsmart.com during the Warranty Period to obtain a Defective Merchandise Authorization (“DMA”) number. No warranty service will be provided without a DMA number.

Limitation of Liability. The remedies described above are your sole and exclusive remedies and our entire liability for any breach of this limited warranty. Our liability shall under no circumstances exceed the actual amount paid by you for the defective product, nor shall we under any circumstances be liable for any consequential, incidental, special or punitive damages or losses, whether direct or indirect. Some states do not allow the exclusion or limitation of incidental or consequential damages, so the above limitation or exclusion may not apply to you.

RADIO FREQUENCY STATEMENT

This device complies with Part 15 of the FCC rules and with Innovation, Science and Economic Development Canada's licence-exempt RSS(s). Operation is subject to the following two conditions:

1. This device may not cause interference.
2. This device must accept any interference, including interference that may cause undesired operation of the device.

L'émetteur/récepteur exempt de licence contenu dans le présent appareil est conforme à la partie 15 des règles de la FCC et aux CNR d'Innovation, Sciences et Développement économique Canada applicables aux appareils radio exempts de licence. L'exploitation est autorisée aux deux conditions suivantes:

1. L'appareil ne doit pas produire de brouillage;
2. L'appareil doit accepter tout brouillage radioélectrique subi, même si le brouillage est susceptible d'en compromettre le fonctionnement.

There is no guarantee that interference will not occur in a particular installation. If it does cause interference, we recommend reorienting the receiving antenna, increasing the separation between the device and the receiver, or consulting an experienced radio/TV technician for help.



**501 Locust Ave, Floor 1, Suite 2
Charlottesville, VA 22902**

**SUPPORT@LUMINSMART.COM
1-888-421-0616
WWW.LUMINSMART.COM**

U.S. Patent No. 10,109,987
U.S. Patent No. 10,467,712
Canadian Patent No. 3,050,702
U.S. and International Patent Applications Pending.
® U.S. Registered Trademark.
Copyright © 2022 Coulomb, Inc. (DBA Lumin). All rights reserved.