

Vision Refined



# OUR COMMITMENT IS YOUR SUCCESS

In a world of supply mediocrity 20/20 strives to provide exceptional quality products and exemplary customer service at reasonable prices. Our customers appreciate this commitment. As the internet and low price only sellers try to commoditize optical products as all being the same, 20/20 uniquely stands in a category on its own. Protect your clinic brand while mitigating “Big Box” comparison and experience the 20/20 advantage.

Our continuing commitment of providing true B2B online is evident at [Shop2020as.com](http://Shop2020as.com). This platform allows 24/7 access and ultimate ease of use, saving both time and money.

Look forward to new products, services and programs in the future. Like to see something specific, contact me directly.

Robert G. Begg,  
President

# TABLE OF CONTENTS

Eyeglass Cleaning Supplies.....	5
Cases.....	15
Sun & UV Protection.....	23
Readers.....	49
Active Lifestyle.....	59
Chains & Cords.....	71
Lab Supplies.....	77
Displays.....	93
Promotional.....	109

# EYEGLOSS CLEANING SUPPLIES

Lens Cleaning Cloths  
Microfiber Gloves & Eye-Patch  
Lens Cleaners  
Wipes & Anti-Fog  
Combination Kits



★ **ULTRA - SOLID**

High-tech lens cleaning cloth composed of 70% polyester, 30% nylon and knit with ultra fine micro fibers using the most advanced technology. This cloth cleans all types of lenses and coatings, with or without a liquid cleaner. To rejuvenate the ultra cloth, just wash it in warm water with detergent, rinse and air dry. Available in 10x15 cm & 15x18 cm, rounded edges or 10x18 cm, zig zag edges.



\* Only available in 15x18 cm rounded and 10x18 cm Zig Zag



Fashion Woman



Optic Illusion

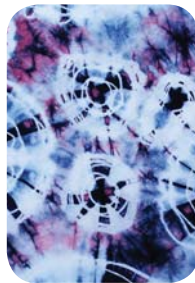

Tie Dye

**ULTRA - FASHION**

Same features as the Ultra-Solid cloth, with bold new digitally printed patterns. Available in 10x15 cm & 15x18 cm, rounded edges.

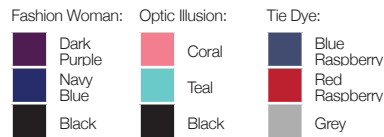

10 x 18 cm zig zag

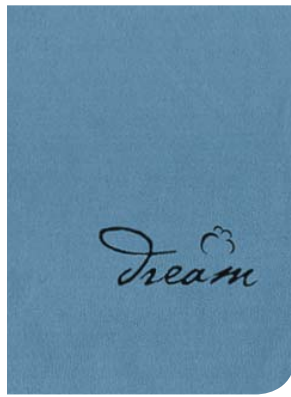

15 x 18 cm rounded

**ULTRA - INSPIRATIONAL**

Same features as the Ultra-Solid cloth, with inspirational messages. Available 10x18 cm with zig zag edges or 15x18 cm with rounded edges which comes in a clear resale pouch.



Wish

Wish

Wish

Wish



★ **ANTIMICROBIAL**

Our most advanced lens cleaning cloth with antimicrobial technology built-in during the manufacturing process and lasting for up to 30 wash cycles. Highly advanced protection prevents bacteria and microbe build up without any special cleaning solutions. Fights the transfer of contaminants from surface to skin. Available in 15x18 cm, zigzag edges.



**GK SHAMMY**

Composed of a shammy material (70% polyester, 30% polyamide) this cloth has excellent absorbency for streak free cleaning. Available in 15x18 cm or 30x30 cm (grey only), rounded edges.



**CUSTOM PRINTING**  
**AVAILABLE ON ALL CLEANING CLOTHS**  
 Minimum quantities of 100 per color



**GK WEAVE**

Economical option for high volume and basic eyeglass cleaning needs. Available in 15x15 cm, zig zag edges.

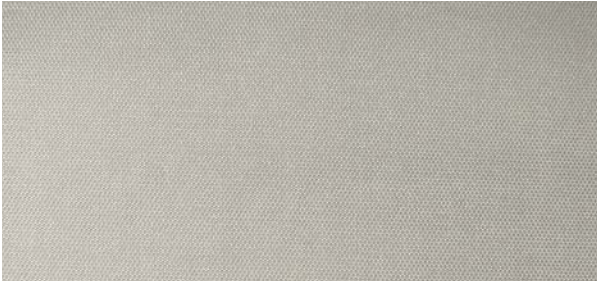

★ **MIKRŌ DIGITAL - EYE OF THE STORM**

Using the same material as the Ultra cloth, this unique digitally printed cloth can be custom branded to your specifications on the reverse side. Available in 15x15 cm.



**MIKRŌ DIGITAL - CUSTOM ARTWORK**

Using the same material as the Ultra cloth, with the option for full customization in a digital print. Available in 15x15 cm. Send us your artwork.





★ **ULTRA - SOLID, BOX-25, BLACK POUCH**

An assortment of some of our most popular colors in the Ultra cloth. Individually packaged in a black pouch for retail, or as a custom branded promotional item. Available in 15x18 cm, rounded edges.



**ULTRA - PATTERN, BOX-25, BLACK POUCH**

An assortment of fun patterns in the Ultra cloth. Individually packaged in a black pouch for retail, or as a custom branded promotional item. Available in 15x18 cm, rounded edges.



**CUSTOM PRINTING AVAILABLE ON ALL CLEANING CLOTHS**



★ **ULTRA - JUMBO LAB**

The largest size of our Ultra cloth. Perfect for use in the lab or as a unique retail item. Available in 30x30 cm.



**ANTIMICROBIAL - JUMBO LAB**

The largest size of our Antimicrobial cloth. Perfect for use in the lab or as a unique retail item. Available in 28x30 cm.





**EYE-PATCH MOBILE**

Size 1" x 1"  
 Customizable patch to advertise your business  
 and to clean mobile device screens.



**SAVE  
 MONEY TIME  
 AND STORAGE SPACE  
 WITH OUR  
 AUTO RELEASE PROGRAM**

**Call our  
 Customer Service Team  
 for more information**

**EYE-PATCH TABLET**

Size 2" x 2"  
 Customizable patch to advertise your business  
 and clean mobile device screens.  
 Stock colour options: Blue, green, grey or pink;  
 Custom colours available.



**MICROFIBER CLEANING GLOVES**

Made of high quality Diamond microfiber, (70% polyester, 30% nylon), these gloves are soft and flexible. A stylish and efficient way to clean your glasses in the dispensary and a unique retail item.

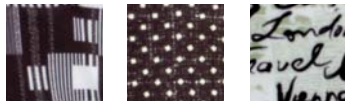

Abstract      Chameleon      Paris



**BLOWOUT  
 PRICING  
 AVAILABLE**

# PROTEKT™



PROTEKT™ A/R Lens Cleaner, backed by several coating labs, has been safety tested and is not harmful to any lens coating. Although specifically developed for anti-reflective lenses, it can be used on all plastic and glass lenses. Certified by Colts laboratories.

# ECO-20

Eco-20 A/R Lens Cleaner features a virtually odourless eco-based A/R formula. Safe to use on any lens type. Complementary with our Antimicrobial cloth.

**FREE PRINTING  
AVAILABLE**  
Minimum  
quantities apply



★ **PROTEKT™ A/R LENS CLEANER - PREMIUM**

Custom printing available on all bottle sizes - 30 ml, 120 ml & 240 ml  
Available in 30 ml/240 ml & 30 ml/120 ml combo packs.



**ECO-20 A/R LENS CLEANER**

Custom printing available on all bottle sizes - 30 ml, 125 ml



**PUMP, FITS 4 L JUG**  
Make your bottle refills quick and easy.

**PROTEKT™ A/R LENS CLEANER CONCENTRATE - 456 ml**

An economical and green friendly option to replenish your solution. Simply mix into a 4 L container with distilled or deionized water and save.



**ECO-20 A/R LENS CLEANER - 7 ml**

Compact and colourful, these refillable bottles are great for everyday use and quick cleaning. Assorted box of 60. Custom printing available.

- Cobalt
- Green
- Red
- Clear
- Light Blue
- Yellow

**RECEIVE THIS DISPLAY FREE WITH THE PURCHASE OF 300 PIECES**  
One display per customer



**PROTEKT™ A/R LENS CLEANER REFILL, 3.79 L JUG**



**ECO-20 A/R LENS CLEANER - 20 ml**

Compact flat pack bottles that just slip into a pocket or purse. Great for daily use. Custom printing applies. Available in a box of 36.



**LENS CLEANING WIPES**

Designed for one-time use, these pre-moistened wipes are perfect for all hi-tech lens coatings, will not scratch or leave any residue. Available in a box of 60 or a box of 180 (counter display).



**FOG DEFENCE**

The ultimate in anti-fog treatments, this formula cleans easily, leaving no residue. Safe to apply on any lens type, with each application lasting 24-72 hours. 50 wipes per box.



**EK CAT CRAP ANTI-FOG PASTE**

Prevents fogging of the lenses while repelling dust and dirt. Cleans and polishes glass and plastic. Safe on all lenses and coatings. **Carded individually or Kitty Litter 24 pcs.**



**EK CAT CRAP ANTI-FOG SPRAY GEL**

Prevents fogging of the lenses while repelling dust and dirt. Cleans and polishes glass and plastic. Safe on all lenses and coatings. **Carded individually or Kitty Litter 15 pcs.**

**30 ml PROTEKT OR ECO-20 KIT - ULTRA OR ANTIMICROBIAL**

Our premium kit includes a 10x15 cm rounded Ultra cloth and an ergonomic 30 ml bottle of Protekt™ cleaning solution. Custom printing available. Inquire about custom colour combinations and in-stock colour options.



- 10 x 15 cm
- 15 x 18 cm



★ **7 ml ECO-20 KIT - ULTRA OR ANTIMICROBIAL**

Ultra Kit includes a 7 ml bottle of our Eco-20 cleaner and a 10x15 cm rounded Ultra cloth. Custom printing available. Inquire about custom colour combinations and in-stock colour options.



**ULTRA KIT CHIC - 7 ml**

Chic Ultra Kit includes a 7 ml bottle of our Eco-20 cleaner and a 10x15 cm rounded Ultra cloth in a sleek pouch. Custom printing available. Inquire about colour combinations.



**ULTRA KIT KIDS - 7 ml**

Kids Ultra Kit includes a 7 ml bottle of our Eco-20 cleaner and 10x15 cm rounded Ultra cloth. Custom printing available. Inquire about custom colour combinations.



**CUSTOM PRINTING AVAILABLE ON ALL CLEANING KITS**  
Minimum quantities apply

RECEIVE  
THIS DISPLAY  
FREE WITH THE  
PURCHASE OF 500  
KITS FOR A SMALL  
DISPLAY  
AND 1000 KITS  
FOR A LARGE  
DISPLAY



10 PC



36 PC

★ ECO-20 FLAT PACK KIT - 20ml

Contains 20 ml Eco-20 cleaner and a 15x18 cm Antimicrobial cloth. Small or large displays are available for purchase. Custom printing applies. Inquire about custom and stock colour combinations.

- Black
- Orange
- Red
- Green
- Plum
- Violet

- ULTRA CLOTH
- ANTI-MICROBIAL
- 10 x 15 cm
- 15 x 18 cm



Build your own fully customizable kit. Choose a cloth from our premium Ultra cloth, or Antimicrobial collections, then select your cleaner from our wide range of sizes. You can also add a key chain screwdriver. Contact our Customer Service team for more information.

# CASES

Ladies

Mens

Unisex

Kids & Teens

Custom Printing



★ **MANTA**  
159-66-40  
90 cases per box  
IN | LABEL

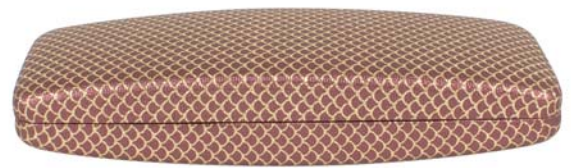

★ **KOI**  
152-55-32  
90 cases per box  
IN | LABEL



★ **ELEMENT**  
160-58-37  
90 cases per box  
IN | LABEL



**REPTILE**  
160-63-37  
90 cases per box  
IN | LABEL



★ **NOUVEAU**  
160-55-42  
90 cases per box  
LABEL



★ **STARBURST**  
162-59-40  
50 cases per box  
IN | OUT | LABEL | EMOSS



**CANDY**  
163-60-32  
100 cases per box  
IN | LABEL



★ **INFINITY**  
153-73-33  
90 cases per box  
IN | LABEL







**JAPANESE PRINT II**

170-80-10

Coin purse top  
40 cases per box

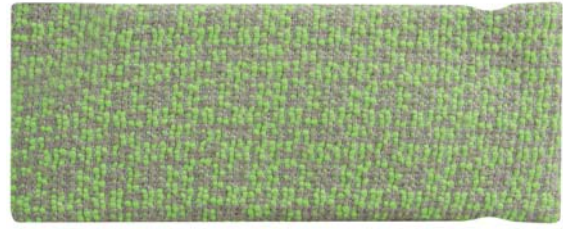

**CHANTEL**

170-80-10

Coin purse top  
40 cases per box



**JAPANESE PRINT I**

165-65-35

40 cases per box  
**LABEL**



**PLUSH II**

165-70-22

40 cases per box,  
10 of each

**LABEL**



Hard

Soft

**SAVE  
MONEY TIME  
AND STORAGE SPACE  
WITH OUR  
AUTO RELEASE PROGRAM**

**Call our  
Customer Service Team  
for more information**

\* Please refer to the back of case section for custom printing legend

\*\* Case sizing is listed after item name as follows in mm: Length-Width-Height

\*\*\* All cases with more than one colour option listed come in an assorted box

ALL MEN'S CASES HAVE A PREMIUM METAL STITCHED CLIP FOR ENSURED QUALITY



★ SLIP W/CLIP & PEN POCKET LARGE

160-83

25 cases per box  
OUT | LABEL



SLIP W/CLIP LARGE

160-83

25 cases per box  
OUT | LABEL



SLIP W/CLIP & FULL FLAP EXTRA LARGE  
ALSO AVAILABLE IN MEDIUM SIZE

200-90

25 cases per box  
OUT | LABEL



★ SLIP W/CLIP & HALF FLAP LARGE

162-82

25 cases per box  
OUT | LABEL



★ SEMI-HARD W/CLIP & FULL FLAP SMALL

160-72

25 cases per box  
OUT | LABEL



★ SEMI-HARD W/CLIP & FULL FLAP LARGE

165-80

25 cases per box  
OUT | LABEL



SLIP W/BELT LOOP & FULL FLAP (SAFETY) X-LARGE

192-98

25 cases per box  
OUT | LABEL



★ HARD WITH STITCH CLIP MEDIUM

163-30-65

25 cases per box  
OUT | LABEL



★ **FLAIR**  
160-60-34  
50 cases per box  
IN | OUT | LABEL



★ **METAL**  
160-60-34  
50 cases per box  
IN | OUT | LABEL



★ **FLAIR W/CLIP FLAP**  
160-60-38  
50 cases per box  
OUT | LABEL



★ **CONTOUR**  
160-58-38  
40 cases per box  
IN | OUT | LABEL | EMBOSS



**URBAN**  
165-65-43  
45 cases per box  
IN | OUT | LABEL



**CLASSIC**  
156-58-45  
50 cases per box  
IN | OUT | LABEL



★ **WRAP LARGE**  
165-68-51  
20 cases per box  
IN | OUT | LABEL



**PREMIUM BLACK LARGE**  
160-65-42  
50 cases per box  
IN | OUT | LABEL

★ **BESTSELLER** \* ★ **NEW PRODUCT**

\* Please refer to the back of case section for custom printing legend  
\*\* Case sizing is listed after item name as follows in mm: Length-Width-Height  
\*\*\* All cases with more than one color option listed come in an assorted box



★ **MARQUIS**  
162-67-42  
90 cases per box  
IN | OUT | LABEL



**DARK GREEN**  
158-52-35  
50 cases per box  
LABEL



★ **FLAIR ECONOMY**  
160-60-34  
50 cases per box  
IN | OUT | LABEL



**SMOKE**  
155-60-40  
50 cases per box  
LABEL



★ **ECONOMY MEDIUM**  
155-60-33  
50 cases per box  
IN | OUT | LABEL | EMBOSS



★ **PLASTIC LARGE**  
158-66-35  
50 cases per box  
IN | OUT | LABEL



**ECCO-01**  
155-50-35  
25 cases per box  
IN | LABEL



**TRI**  
150-70-40  
40 cases per box  
LABEL



**CLIP-ON MEDIUM**

133-65-21

10 cases per box  
IN | OUT | LABEL



**MICROFIBER POUCH - SMALL & LARGE**

193-95

1 each  
OUT | LABEL

**CASES | KIDS**



★ **NEW STARZ**

137-60-35

60 cases per box  
IN | LABEL



**FLASH**

160-66-33

30 cases per box  
IN | LABEL



**CASES | CLIPS**



**VISOR CLIP**

Clips onto the flip down visor in your car and opens to place the temples of your glasses inside. \*Custom printing available.

★ **NEW PRODUCT**

- \* Please refer to the back of case section for custom printing legend
- \*\* Case sizing is listed after item name as follows in mm: Length-Width-Height
- \*\*\* All cases with more than one color option listed come in an assorted box



Pad Printing (Interior) - **IN**



Labeling - **LABEL**



Pad Printing (Exterior) - **OUT**



Embossing - **EMBOSS**



**CUSTOM LOGO PRINTING GUIDELINES**

- A separate plate/dye is required for embossing or pad printing orders.
- Artwork is required for labeling orders.
- Allow 2 to 4 weeks delivery on all new orders which require new graphics.
- Allow 1 week delivery for re-orders using existing graphics.
- An initial, one time dye charge will apply to all orders which require a new embossing and/or printing plate.
- Each case in our catalogue is labeled with printing capabilities (IN, LABEL, OUT, EMBOSS)
- Minimum quantities apply

# SUN & UV PROTECTION

Overglasses

Clip-Ons

Flip-Ups

Instant Sunglasses

Bifocal Sunglasses

Plano Sunglasses

Sunglasses & Lens Packages

Kids Sunglasses



20/20, the original distributor of overglasses in Canada introduces Overcoats. Made of TR90 with polarized lenses, all Overcoat models feature “temple tunnel technology” and are “engineered for a better fit”. They are available in S and F series.

**FEATURES AND BENEFITS**

- TR90 frame
- Polarized triacetate lenses, UV400
- Mirrored lens options
- Optics by 20/20
- Replacement lenses available for all models
- Microfiber pouch included with every pair of Overcoats



★ **OVERCOATS S-SERIES REC** 64-13-137

TR90 frame with polarized triacetate lenses.

Lens Colours:  Grey  Yellow  
 Brown



Black Tortoise Navy



**OVERCOATS F-SERIES REC** 62-14-140

TR90 frame with polarized triacetate lenses.

Lens Colours:  Grey  
 Brown



Purple Blue Grey



★ **OVERCOATS F-SERIES ROUND REC** 62-14-140

TR90 frame with polarized triacetate lenses.

Lens Colours:  Grey  
 Brown



Purple Blue Grey

\*Lens colours are not available with all frame colours



Now with a new lightweight design and 2 new shapes, these Overcoats models feature a TR90 frame and polarized TAC lenses. All models have a soft touch finish.

**FEATURES AND BENEFITS**

- New lightweight design
- TR90 frame
- Polarized triacetate lens, UV400
- Microfiber pouch is included with every pair of Overcoats
- Optics by 20/20

★ **OVERCOATS F-SERIES MINI REC** 58-17-140

TR90 frame with polarized triacetate lenses.



Black/Grey

Brown/Brown



★ **OVERCOATS F-SERIES CATEYE** 56-18-140

TR90 frame with polarized triacetate lenses.



Black/Grey

Brown/Brown



# solehs

Perfected to protect from the sun and be worn over prescription eyewear, these classic Soleh models feature a TR90 frame and polarized TAC lenses. All models have a soft touch finish unless stated otherwise.

## FEATURES AND BENEFITS

- TR90 frame
- Polarized triacetate lens, UV400
- Mirrored lens options
- Optics by 20/20
- Replacement lenses are available for some models
- Microfiber pouch is included with every pair of Solehs



### ★ SOLEHS SLIM REC 60-17-130

TR90 frame with polarized triacetate lenses.

Lens Colours: \*  
 Grey, Yellow, Green Mirror, Grey Photochromic  
 Brown, Driver, Blue Mirror, Brown Photochromic



Black



Brown



Slate



Olive



Burgundy



### SOLEHS ROUND REC 61-17-130

TR90 frame with polarized triacetate lenses.

Lens Colours: \*  
 Grey, Yellow, Grey Photochromic  
 Brown, Driver, Brown Photochromic



Black



Brown



Shiny Black



Shiny Brown



### SOLEHS SQUARE 64-15-125

TR90 frame with polarized triacetate lenses.

Lens Colours: Yellow, Grey Photochromic



Black

\*Lens colours are not available with all frame colours

# SOLEHS-LITE

Polarized • Polarisé

Now with a new lightweight design and 2 new shapes, these Solehs-Lite models feature a TR90 frame and polarized TAC lenses. All models have a soft touch finish.

## FEATURES AND BENEFITS

- New lightweight design
- TR90 frame
- Polarized triacetate lens, UV400
- Microfiber pouch is included with every pair of Solehs
- Optics by 20/20

### ★ SOLEHS-LITE REC 65-18-135

TR90 frame with polarized triacetate lenses.



Black/Grey

Brown/Brown



### ★ SOLEHS-LITE ROUND 65-19-135

TR90 frame with polarized triacetate lenses.



Black/Grey

Brown/Brown





OVERGLASSES FLOOR DISPLAY, 18PC

RECEIVE AN 18PC  
FLOOR DISPLAY  
WITH THE PURCHASE  
OF 48 ASSORTED  
SOLEHS/OVERCOATS

RECEIVE THIS DISPLAY  
with the purchase of 12 assorted  
Solehs/Overcoats



OVERGLASSES COUNTER DISPLAY, 12PC

# Perception®

20/20 is proud to be the exclusive Canadian distributor of Perception® mirrored clip-ons from Shade Control®. The clip-ons are available with a copper driving lens and a bronze frame in our most popular shapes and sizes. Perception® clip-ons are available in a 20 piece fitting kit for easy storage and organization. Ask how you can become a Perception® mirror lens clip-on dealer.



Made in USA

### SELECTING A SIZE:

- Use the size guide provided on following pages. All outlines are actual size for accurate sizing.
- Lay your glasses face down onto the outlines of the clip-on sunglasses and select whichever size is the closest match.

### HOW THE CLIP-ONS ATTACH TO YOUR GLASSES:

- This type of clip-on sunglass is held in place by the tension from the spring-bridge and four small, plastic coated clips, two on either side of each lens.
- The clips will fit over glasses with metal, plastic, or rimless frames with lenses up to 5 mm thick at the edges.

**BUY 15  
PRE-SELECTED  
PERCEPTION CLIP-ONS  
RECEIVE AN  
ADDITIONAL 5 FOR  
FREE AND  
A FITTING KIT**



### PERCEPTION FITTING KIT, 20PC

Keep your clip-ons organized and maximize your sales. Size & style availability ensures an accurate fit for your customer's frame.

**TRU REC**

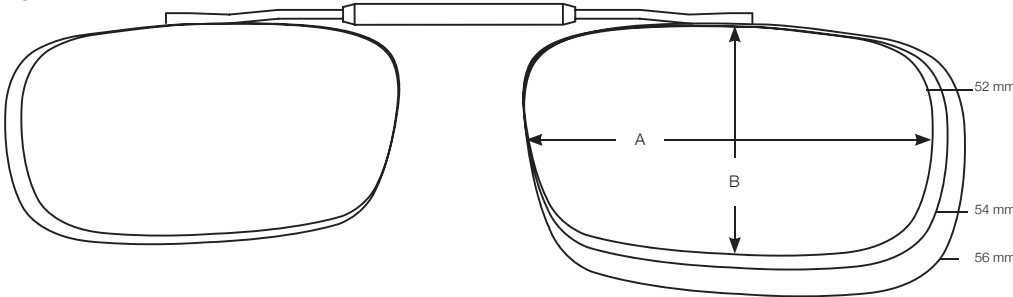

Size	A	B
52 mm	52	29
54 mm	54	30
56 mm	56	30

**SLIM REC**

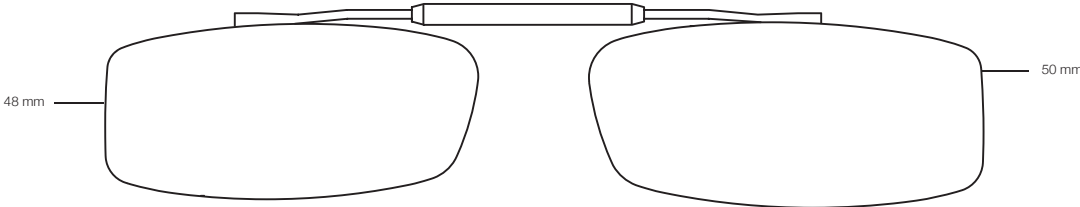

Size	A	B
48 mm	48	22
50 mm	50	23

**REC**

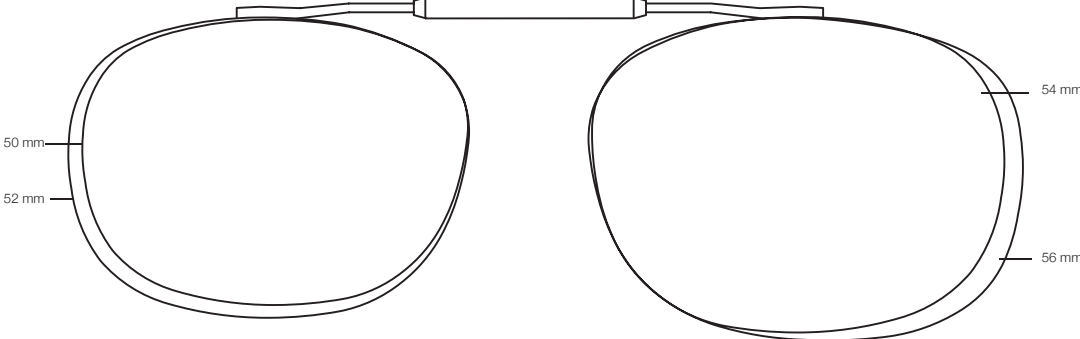

Size	A	B
50 mm	50	37
52 mm	52	39
54 mm	54	40
56 mm	56	43

**DEEP REC**

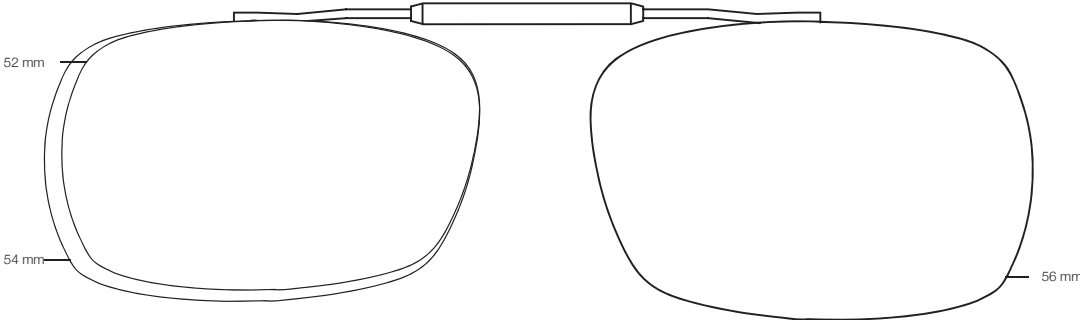

Size	A	B
52 mm	52	33
54 mm	54	35
56 mm	56	38



Size	A	B
50 mm	50	29
52 mm	52	31

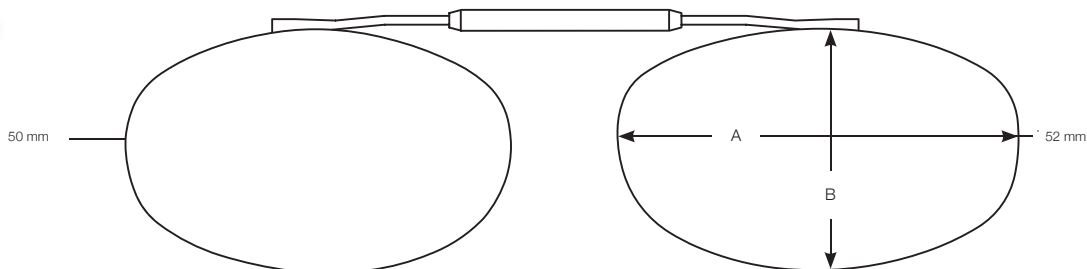

Size	A	B
48 mm	48	27
50 mm	50	29
52 mm	52	29
54 mm	54	30
56 mm	56	30

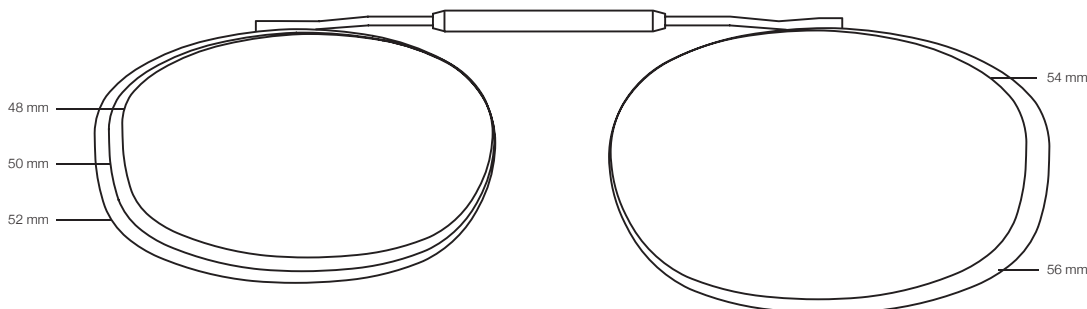

Size	A	B
52 mm	52	29
54 mm	54	31

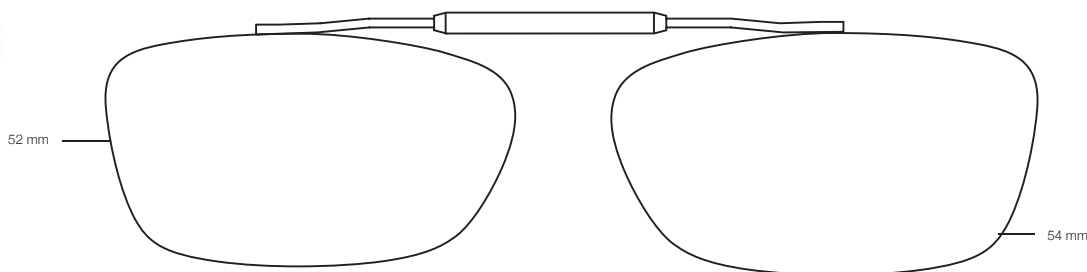



Made in USA

**FEATURES AND BENEFITS**

- Polarized lenses
- Shade Control clips are designed to ensure that the polarized horizontal axis is never compromised
- Stainless steel patented construction
- Functioning rim locks
- All sun lenses filter 100% of ultraviolet light up to 400 nm and meet or exceed all local and international standards pertaining to optical clarity, durability, and safety, including but not limited to ANSI Z80.3:2008, EN1836:2005, and AS/NZS 1067:2003.

**PRICE MATCH PRODUCT**

**SELECTING A SIZE:**

- Use the size guide provided on following pages. All outlines are actual size for accurate sizing.
- Lay your glasses face down onto the outlines of the clip-on sunglasses and select whichever size is the closest match.

**HOW THE CLIP-ONS ATTACH TO YOUR GLASSES:**

- This type of clip-on sunglass is held in place by the tension from the spring-bridge and four small, plastic coated clips, two on either side of each lens.
- The clips will fit over glasses with metal, plastic, or rimless frames with lenses up to 5 mm thick at the edges.



**RECEIVE THIS  
CLIP-ON FITTING  
KIT FREE  
Minimum  
quantities apply**

**VISIONARIES FITTING KIT, 42PC**

Keep your clip-ons organized and maximize your sales. Size & style availability ensures an accurate fit for your customer's frame.





Size	A	B
48 mm	48	27
50 mm	50	28
52 mm	52	29
54 mm	54	30
56 mm	56	34
58 mm	58	35.2

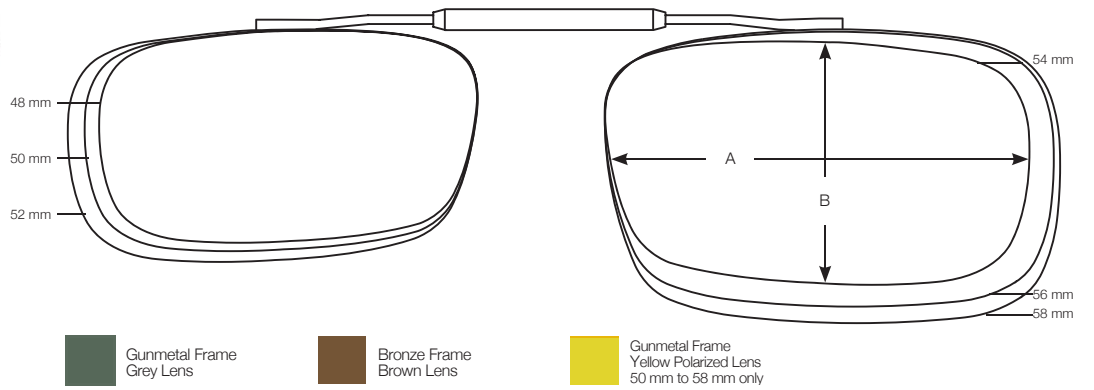

Size	A	B
48 mm	48	27
50 mm	50	28
52 mm	52	29
54 mm	54	30
56 mm	56	35.2

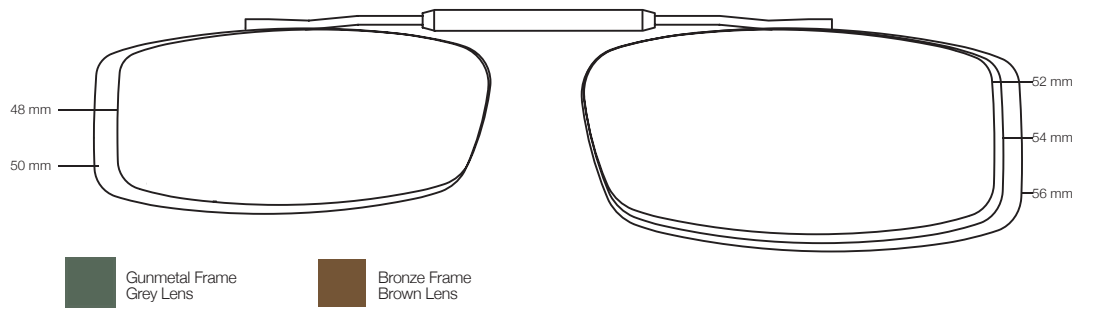

Size	A	B
52 mm	52	33
54 mm	54	35
56 mm	56	38

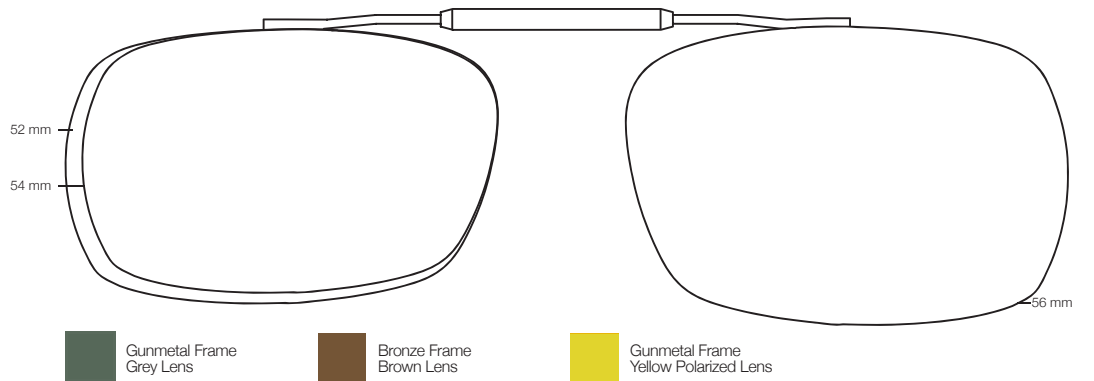

Size	A	B
55 mm	55	26.5
57 mm	57	27

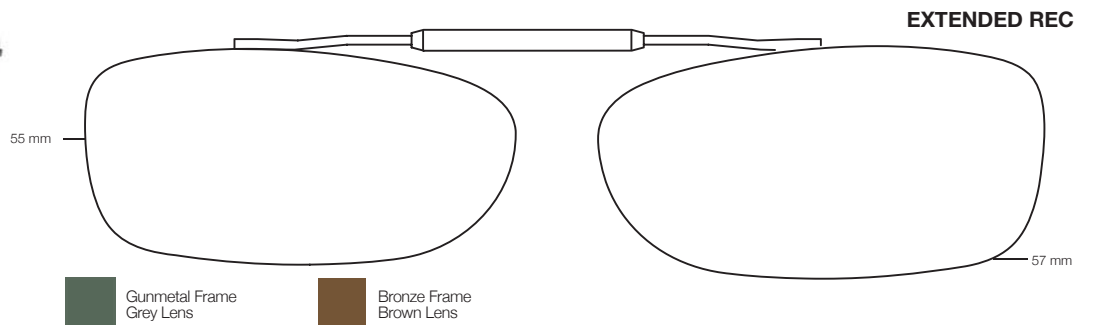

**REC**

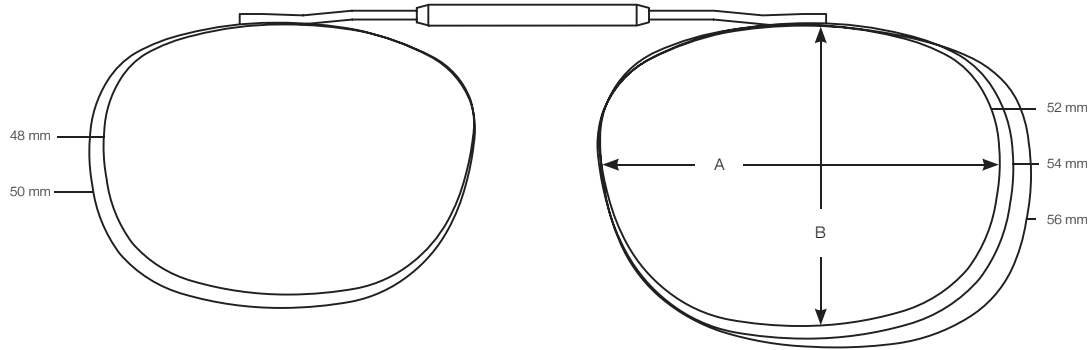

Size	A	B
48 mm	48	35
50 mm	50	37
52 mm	52	39
54 mm	54	40
56 mm	56	43



**MOD REC**

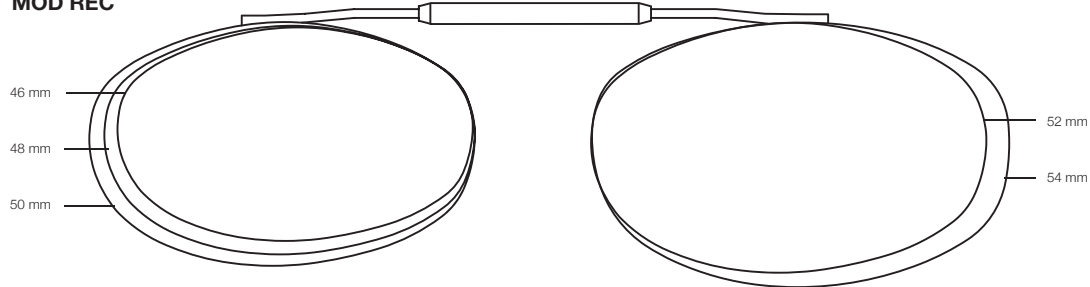

Size	A	B
46 mm	46	26
48 mm	48	28
50 mm	50	29
52 mm	52	31
54 mm	54	33



**LO REC**

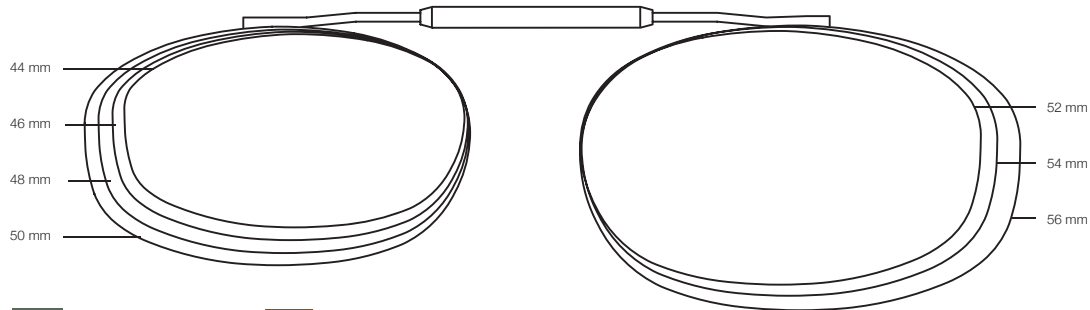

Size	A	B
44 mm	44	27
46 mm	46	29
48 mm	48	30
50 mm	50	32
52 mm	52	32
54 mm	54	35
56 mm	56	35





Size	A	B
44 mm	44	34
46 mm	46	36
48 mm	48	37
50 mm	50	39
52 mm	52	41

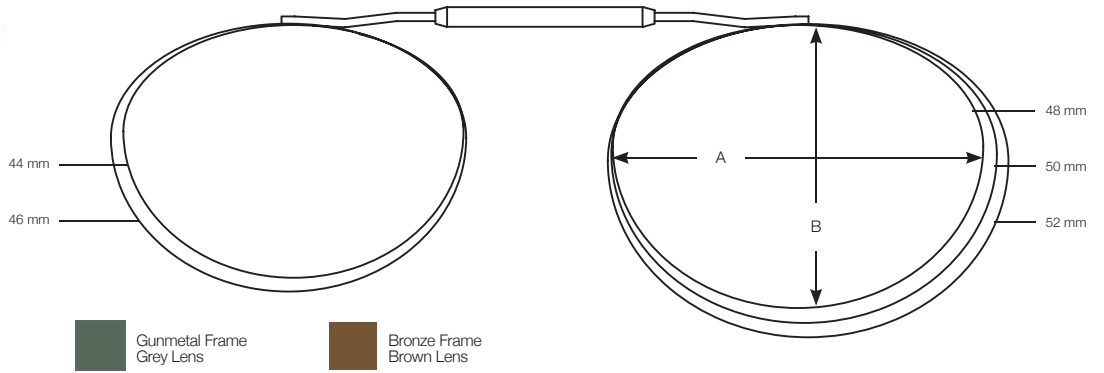

Size	A	B
50 mm	50	28
52 mm	52	29

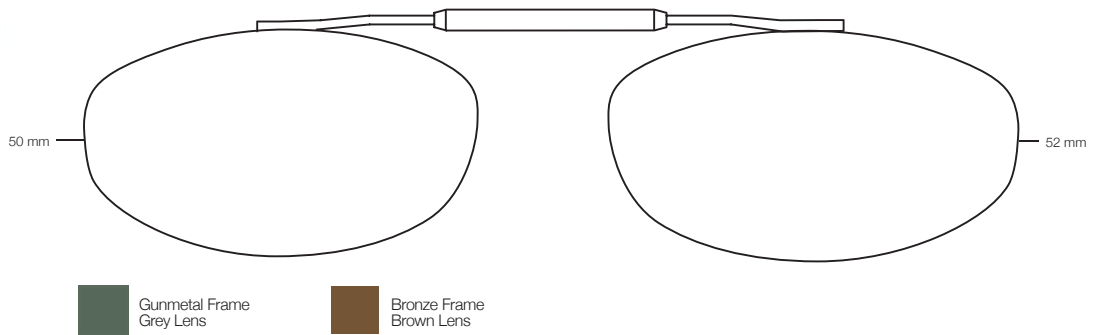

Size	A	B
42 mm	42	26
44 mm	44	27
46 mm	46	30
48 mm	48	30

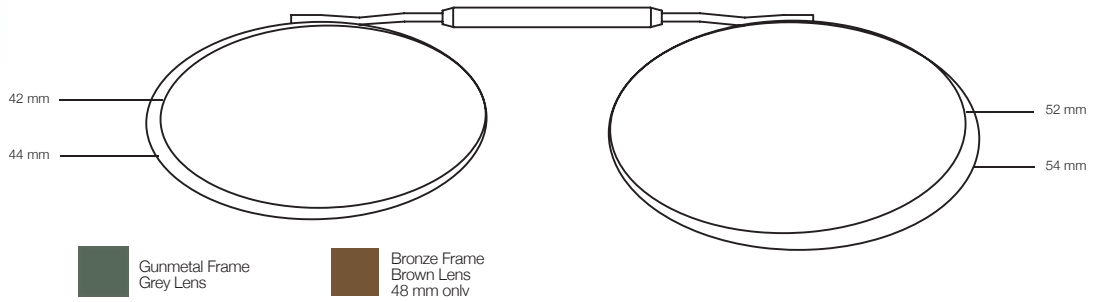

Size	A	B
48 mm	48	29
50 mm	50	30
52 mm	52	31

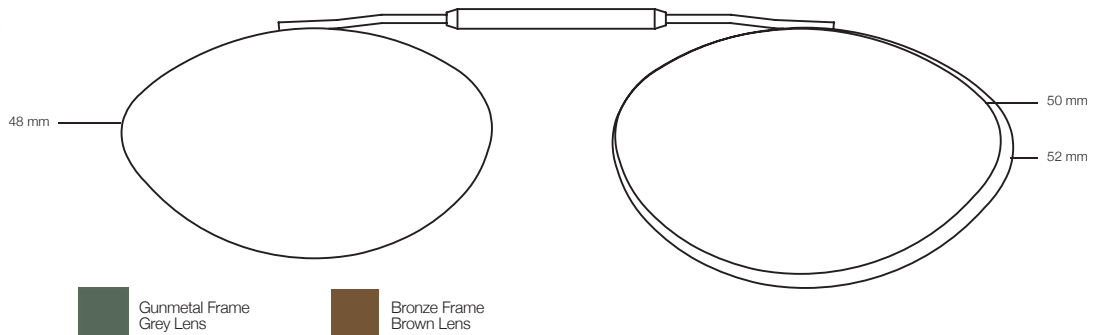

**SQUARE**

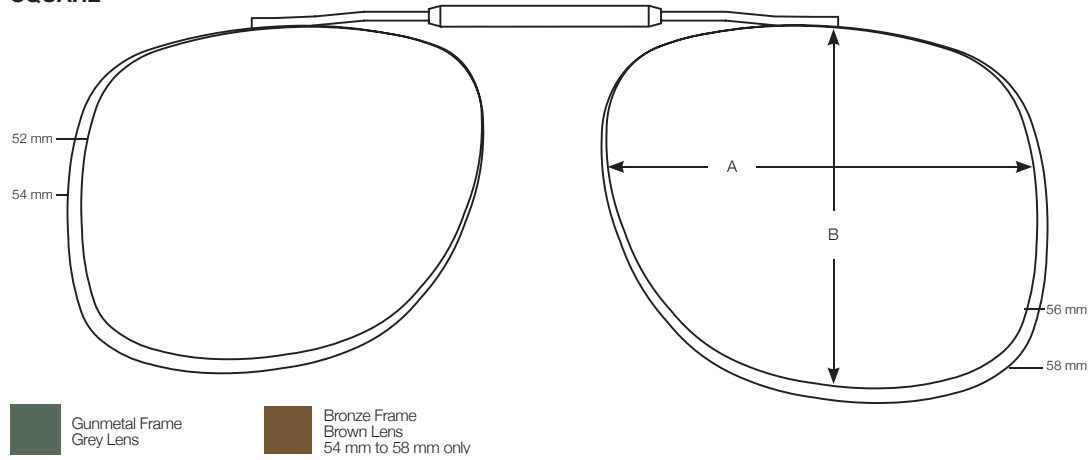

Size	A	B
52 mm	52	45
54 mm	54	46
56 mm	56	48
58 mm	58	49

**WAY**

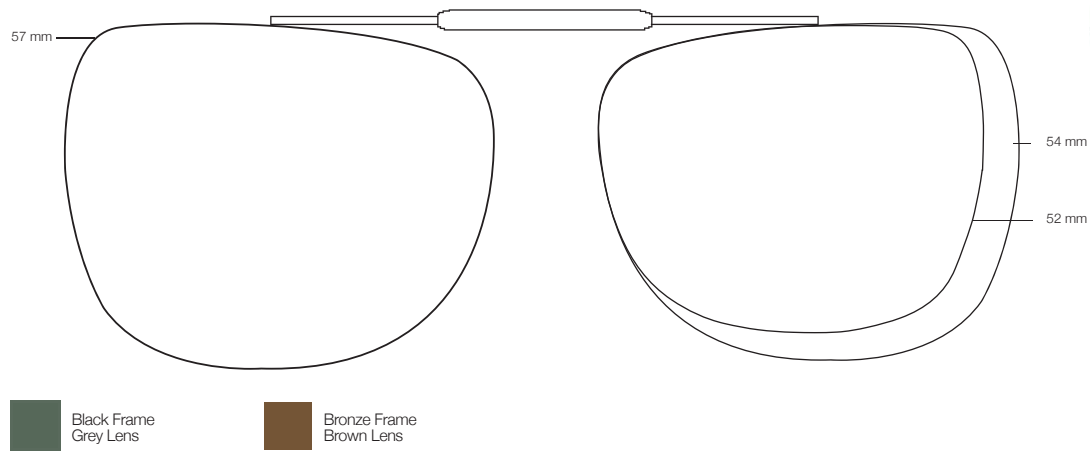

Size	A	B
52 mm	52	45
54 mm	54	46
57 mm	56	47

**ROUND**

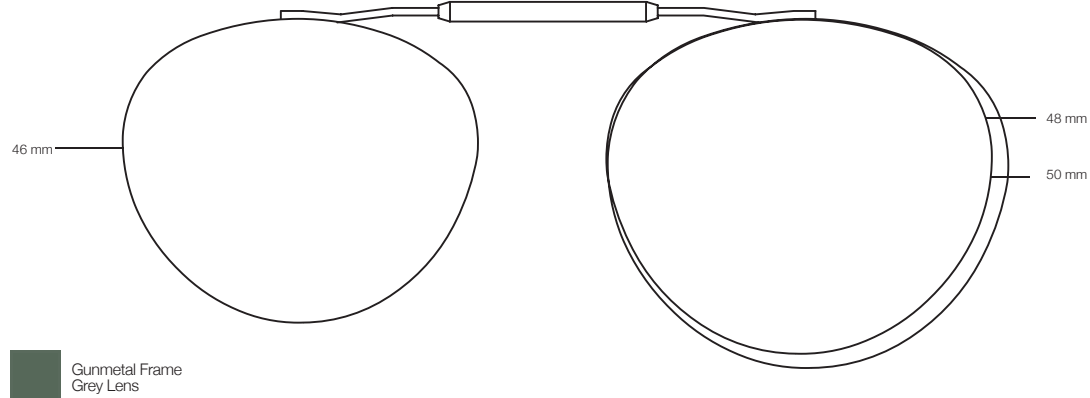

Size	A	B
46 mm	46	42
48 mm	48	43
50 mm	50	45



Size	A	B
52 mm	52	29
54 mm	54	31
56 mm	56	32

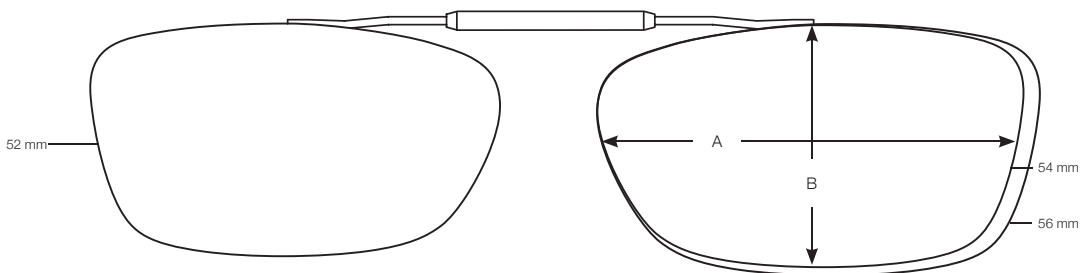

Gunmetal Frame  
Grey Lens



Bronze Frame  
Brown Lens



Gunmetal Frame  
Yellow Polarized Lens  
54 mm only



Size	A	B
52 mm	52	26
54 mm	54	27

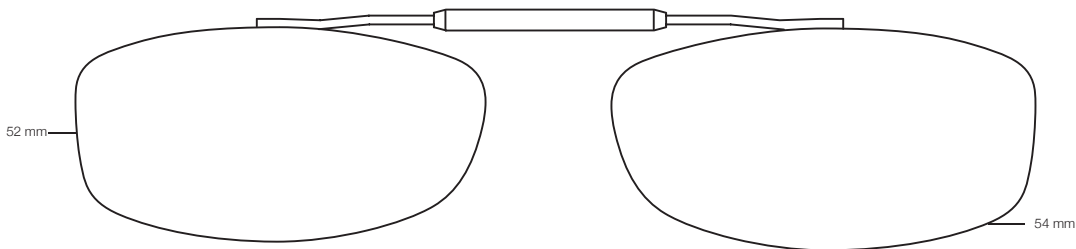

Gunmetal Frame  
Grey Lens



Bronze Frame  
Brown Lens



**KIDS LO REC**

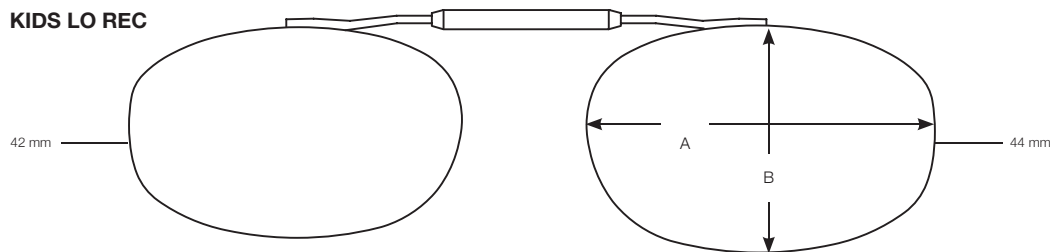

Size	A	B
42 mm	42	26
44 mm	44	26

 Rootbeer Frame  
Grey Lens

 Blueberry Frame  
Grey Lens

**KIDS LO OVAL**

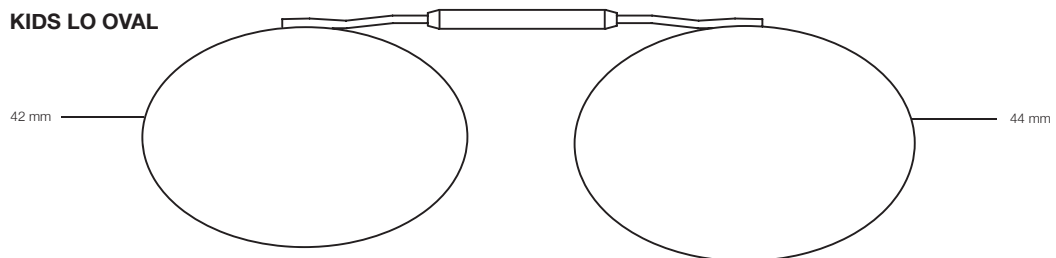

Size	A	B
42 mm	42	27
44 mm	44	28

 Rootbeer Frame  
Grey Lens

 Blueberry Frame  
Grey Lens

**KIDS HEXAGON**

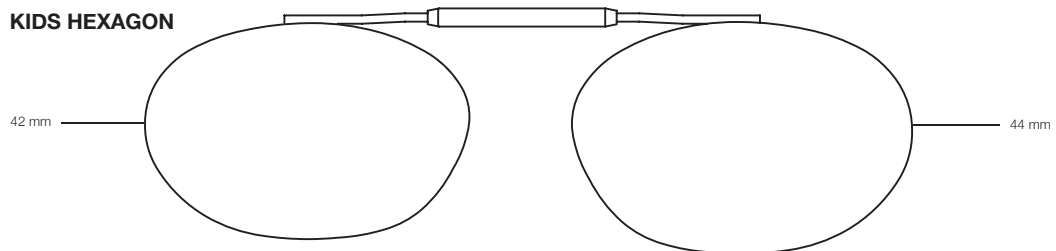

Size	A	B
42 mm	42	25
44 mm	44	26

 Rootbeer Frame  
Grey Lens

 Blueberry Frame  
Grey Lens

# PROTEKT™ Flip-Ups

## FEATURES & BENEFITS

- Silicone dipped tips to protect prescription lenses from scratching
- All metal clip mechanism
- Polarized lenses where specified
- Limited lifetime manufacturers warranty



Made in USA



**SQUARE SMALL** A=55 mm B=46 mm



**RECTANGLE SMALL** A=53 mm B=35 mm



**OVAL SMALL** A=52 mm B=37 mm



**SQUARE MEDIUM** A=59 mm B=54 mm



**ROUND MEDIUM** A=57 mm B=48



**OVAL MEDIUM** A=57 mm B=40 mm



**SQUARE LARGE** A=63 mm B=58 mm



## SUN & UV | INSTANT SUNGLASSES



**POST MYDIATRIC, SLIP-IN**

Box of 100



**POST MYDIATRIC**

Adjustable temples, Box of 100



★ **HANG RETRO** 46-17-165

Polycarbonate soft touch frame with spring hinges, polycarbonate bifocal lenses.

**+1.50, +2.00, +2.50**



Light Blue /Green



Blue Green /Green



Blue /Mirror



Turquoise /Mirror



★ **RETRO HIPSTER** 48-16-145

Polycarbonate frame with spring hinges, polycarbonate bifocal lenses.

**+1.50, +2.00, +2.50**



Crystal Blue Two Tone



Crystal Yellow Two Tone



**GOLFOCAL - GREEN LENS** 67-16-120

Ultra light TR-90 frame, polycarbonate bifocal lenses with A/R and scratch-resistant coating. Case, cleaner and cloth included.

**+1.50, +2.00, +2.50**



Black



Slate



**GOLFOCAL - BROWN LENS** 67-16-120

Ultra light TR-90 frame, polycarbonate bifocal lenses with A/R and scratch-resistant coating. Case, cleaner and cloth included.

**+1.50, +2.00, +2.50**



Brown



White







★ **GK MARLIN** 64-19-126

An excellent choice for fishing enthusiasts with an ultra-light TR-90 frame, polarized bifocal polycarbonate lenses with flash mirror & oleo phobic coatings on the front and an A/R purple back coat. Case, cleaner and cloth included. **Plano, +1.50, +2.00, +2.50**



Black/Grey

Tortoise/Brown



**GK SPORT** 64-19-126

Ultra light, rimless TR90 frame and bifocal polycarbonate lenses. Non-polarized unisex style. Case, cleaner and cloth included. **Plano, +1.50, +2.00, +2.50**



Crystal Grey /Grey

Tortoise/Brown



★ **GK RAY** 51-19-140

Unisex, non-polarized bifocal sunglass with classic, retro frame style. Microfiber pouch included. **+1.50, +2.00, +2.50**



Black/Clear /Grey

Tortoise/Brown

Black/Tortoise /Grey





**GK MARLIN - POLARIZED** 64-19-126

An excellent choice for fishing enthusiasts with an ultra-light rimless TR-90 frame, polarized polycarbonate lenses with flash mirror & oleophobic coatings on the front and an A/R purple back coat. Case, cleaner and cloth included.



Crystal Grey/  
Grey



Tortoise/Driver



**GK SPORT - RIMLESS** 64-19-126

Ultra light, TR90 frame and polycarbonate lenses. Non-polarized unisex style. Case, cleaner and cloth included.



Tortoise/Yellow



Tortoise/Brown



Crystal Grey/  
Grey



**GK HELIUM** 65-13-127

TR90 frame with polycarbonate lenses. Complete with three sets of lenses in grey, brown and clear. Case, cleaner and cloth included.



Black/Grey



Lavender/Grey



**★ WAVE - POLARIZED** 51-21-142

Polycarbonate frame with polarized triacetate lenses. Microfiber pouch included.



Black/Grey



Black/Driver



Tortoise/Grey



Tortoise/Driver

**GK PLEIN AIR PACKAGE OPTION 67-16-120**

GK™ Plein Air sunglasses are designed for individuals, who like to call the great outdoors their home. Photochromic polarized TAC lenses provide consistent UV protection and clarity as light levels fluctuate. Case, cleaner and cloth included. Tortoise PC frame plus two pairs of photochromic polarized TAC lenses in grey and brown.



**GK PERSONAL PACKAGE OPTION 67-16-120**

Create your package with a frame and two pairs of lenses to make a complete set. These sunglasses will meet the needs for your everyday activities, from the water to the slopes and all the fairways in between. Case, cleaner and cloth included.



Brown TR    White TR    Black TR    Slate TR



**SELECT A FRAME COLOR, THEN CHOOSE ONE LENS FROM EACH GROUP IN THE FOLLOWING.**

Packages include: case, cleaner, cloth and two pairs of lenses.

**GROUP 1 - FAIRWAY LENS (PLANO POLARIZED)**

Outdoor polarized with A/R back coat reduces glare and improves visual acuity. Optimal for on the water or the slopes.

**Plano / Polarized**

Brown Golf, Green Golf or Driver Golf

**GROUP 2 - FAIRWAY LENS (BIFOCAL)**

Eclipse Technology renders the 'add' virtually invisible. Golfocals with Eclipse Technology will let you enjoy your outdoor activities without the hassle of changing your glasses. Ideal for perfecting your golf game.

**Eclipse Technology / Non-Polarized**

Green or Brown Golf

**+1.50, +2.00, +2.50** with Eclipse Technology and A/R back coat

**OR**

**Plano / Non-Polarized**

Brown Golf, Green Golf or Driver Golf

All with A/R back coat.



# Charlie Sun

CHARLIE SUN is our newest line of children's sunglasses constructed with a durable TR90 frame, 180° hinges, polarized triacetate lenses with a mirror coating and 8 layer backside A/R.

Minimum orders of an 12 piece fitting kit receive 4 of each style, Aubrey, Jayden and Skye, 2 of each colour and a display stand with a branded features plaque. Each unit includes a silicone cord and microfiber pouch.



★ **AUBREY** 41-17-118

Suitable for kids 1-3 years.



Matte Red



Matte Dark Blue



★ **JAYDEN** 45-17-124

Suitable for kids 3-9 years.



Dark Blue



Dark Grey



★ **SKYE** 48-18-122

Suitable for kids 9+ years.



Black



Dark Blue



**180°  
FLEX HINGES**  
**8 LAYER  
BACKSIDE A/R  
COATING**  
MINIMUM ORDER  
OF 12 PCS.



# PROTEKT™ SUPER KIDS

PROTEKT™ SUPER KIDS is our premium line of children's sunglasses constructed of durable TR-90 material with polycarbonate lenses transmitting a minimum of 80% of visible light. The low bridge design on the smaller sizes is ideal for the underdeveloped bridge on small children.



**STING** 48-110

Suitable for kids 6-9 years. TR90 frame with polarized polycarbonate lenses.

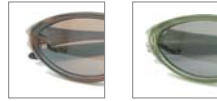

Crystal Brown    Crystal Green



★ **SHOTZ** 40-110

Suitable for kids 0-3 years. TR90 frame with polycarbonate lenses.



Crystal Green    Pearl Green



**RILEY** 44-110

Suitable for kids 0-3 years. TR90 frame with polycarbonate lenses.



Crystal Orange



**SKEETER** 38-110

Suitable for kids 0-3 years. TR90 frame with polycarbonate lenses.



Crystal Green    Pearl Green

★ **JACQUELINE** 44-110

Suitable for kids 3-6 years. TR90 frame with polycarbonate lenses.



Black/Black    Pink/Purple    Red/Blue



★ **BUBBLEZ** 42-110

Suitable for kids 1-3 years. TR90 frame with polycarbonate lenses.



Black/Black    Pink/Purple    Red/Blue



★ **SPIDER** 44-110

Suitable for kids 3-6 years. TR90 frame with polycarbonate lenses.



Blue/Blue    Black/Black    Red/Red



★ **SLING** 52-120

Suitable for kids 6-9 years. Polycarbonate frame.



Matte Clear    Crystal Pink    Crystal Purple





★ **SEEKERS SMALL** 39-17-110

Suitable for kids 0-3 years. Silk matte frame with 100% UV polycarbonate lenses. Promotional item - minimum order of 12 pcs per colour per style.



Pink/Blue



Teal/Orange



★ **SEEKERS MEDIUM ROUND** 43-15-130

Suitable for kids 3-6 years. Silk matte frame with 100% UV polycarbonate lenses. Promotional item - minimum order of 12 pcs per colour per style.



Black/Neon Orange



Blue/Yellow



Navy Blue Neon Green



★ **SEEKERS MEDIUM** 45-16-125

Suitable for kids 6-10 years. Silk matte frame with 100% UV polycarbonate lenses. Promotional item minimum order of 12 pcs per colour per style.



Black/Neon Orange



Blue/Yellow



Navy Blue Neon Green



★ **SEEKERS LARGE** 44-20-125

Suitable for kids 6-10 years. Silk matte frame with 100% UV polycarbonate lenses. Promotional item minimum order of 12 pcs per colour per style.



Black/Neon Orange



Blue/Yellow



Navy Blue Neon Green



# READERS

Ladies

Mens

Unisex

Hydrotac



★ **AUDREY** 51-18-135

Ophthalmic metal reader with spring hinges and smooth temple detail. Stainless steel, semi-rimless frame and acrylic lenses. **+1.00 to +3.00 in quarter diopters**



Matte Black



★ **MOSAIC** 52-17-140

Geometric-shaped readers with silver accent plaques and mosaic patterned temples. Spring hinges, polycarbonate frame & acrylic lenses. **+0.75 to +3.00 in quarter diopters, +3.50**



Blue



Orange



Pink



★ **FERN** 50-16-140

Beautifully crafted, trendy and comfortable with spring hinges, silver accent plaques, and fern patterned temples. Polycarbonate frame & acrylic lenses. **+0.75 to +3.00 in quarter diopters, +3.50**



Blue



Brown



Purple



**LOTUS** 50-18-140

Attractively styled to assist patients with makeup application. The single lens flips from eye to eye for easy use. Nickel/Silver frame & acrylic lenses. **+3.50**



Purple



Detail

**CASE INCLUDED WITH ALL READERS**

★ **TRUMAN** 54-18-140

Ophthalmic metal reader with spring hinges and smooth temple detail. Stainless steel frame and acrylic lenses. **+1.00 to +4.00 in quarter diopters**



Gunmetal Matte Grey



★ **MAGNUM** 55-17-140

Ophthalmic semi-rimless reader. Stainless steel frame and CR-39 A/R back coat lenses. **+0.75 to +3.00 in quarter diopters**



Black

Brown

Gunmetal



**STEALTH** 53-19-140

Ophthalmic metal reader with spring hinges and ridged temple detail. Stainless steel frame and acrylic lenses. **+1.00 to +3.00 in quarter diopters**



Bronze

Gunmetal



**GENT** 53-19-133

Ophthalmic quality reader. Stainless steel frame with TR-90 temples and acrylic lenses. **+1.00 to +3.00 in quarter diopters**



Brown

Gunmetal



★ **BENZ** 47-22-151

European style, stainless steel frame and acrylic lenses. **+1.00 to +3.00 in quarter diopters**



Black/Black

Brown/Black

Silver/Black



**CASE INCLUDED WITH ALL READERS**

★ **BESTSELLER** ★ **NEW PRODUCT**



★ **MAJOR SPRING** 50-17-135

Classic style stainless steel frame with acrylic lenses.  
**+1.00 to +3.00 in quarter diopters, +3.50, +4.00, +4.50 & +5.00**



Brown



Gunmetal



★ **JAG** 48-17-135

Rectangular ophthalmic frame with hand-made acetate temples and spring hinges. Stainless steel frame with acrylic lenses.  
**+0.75 to +3.00 in quarter diopters**



Black



Blue



Gunmetal



**CRUSH** 50-18-138

Extremely durable ophthalmic reader. Polycarbonate frame and acrylic lenses.  
**+1.00 to +3.00 in quarter diopters**



Purple



Red



**ROGUE** 53-16-140

With smooth lines, pleasing aesthetics, and light-as-a-feather construction, the Rogue frame is easy to forget you have on. TR-90 frame with polycarbonate reading lenses.  
**+1.00 to +3.00 in quarter diopters**



Black/Grey



Blue/Light Blue

**PRE-CUT  
 READING LENSES  
 WITH A/R BACK COAT  
 AVAILABLE FOR  
 EACH ROGUE  
 READER**

**CASE INCLUDED WITH ALL READERS**

★ **CAMBRIDGE** 47-20-145

Classic and stylish reader that is lightweight and comfortable. Spring hinges, metal accents, and soft touch polycarbonate frame with acrylic A/R back coat lenses.

**+1.00 to +3.00 in quarter diopters, +3.50**



Black      Brown      Grey      Red      Tortoise



★ **YALE** 51-20-142

Beautifully designed unisex frame that is both fashionable and comfortable. Spring hinges, metal accents and a tortoise patterned soft touch polycarbonate frame with acrylic A/R back coat lenses. **+0.75 to +3.00 in quarter diopters, +3.50**



Black      Blue      Green      Purple      Red



★ **DEX** 53-19-134

Modern rectangular frame with wood grain pattern temples and spring hinges. Polycarbonate frame with acrylic lenses.

**+1.00 to +3.00 in quarter diopters**



Black/Grey



★ **KENNEDY** 53-19-143

Classic Style. Polycarbonate frame with acrylic lenses.

**+1.00 to +3.00 in quarter diopters**



Black



**CASE INCLUDED WITH ALL READERS**

★ **BESTSELLER**



★ **HANG 20** 54-17-135

Hang 20 readers include a second sunglass UV400 reading lens at no charge. Polycarbonate frame with acrylic lenses.  
**+1.00 to +3.00 in quarter diopters**



Tortoise    Clear/Black    Black/Burberry



**HANG 22** 52-18-150

Available in bright fun colors with interchangeable frame fronts and temples. Purchase multiple pairs to change your color combination daily, reflecting your mood or style. Polycarbonate frame with acrylic lenses.  
**+1.00 to +2.50 in quarter diopters, +3.00**



Blue/Green    Clear/Purple    Green/Orange    Orange/Blue    Orange/Orange    Red/Purple



★ **HANG 23** 45-17-165

Polycarbonate soft touch frame with spring hinges. Polycarbonate blue light filter lenses.  
**+0.75 to +3.00 in quarter diopters**



Dark Blue    Dark Brown    Purple    Blue Green



★ **LENNON** 43-17-140

Polycarbonate frame with Polycarbonate blue light filter lenses.  
**+0.75 to +3.00 in quarter diopters**



Dark Brown    Olive    Dark Blue

**CASE INCLUDED WITH ALL READERS**

**DILIGENT** 50-15-145

Unisex semi-rimless classic European style reader with ultra light TR-90 temples. Stainless steel frame with acrylic lenses.

**+1.00 to +3.00 in quarter diopters**



Gunmetal    Navy    Purple



**UNI SPEC** 52-18-135

Light rimless unisex reader, polycarbonate frame and lens.

**+1.00, +1.25, +1.50, +1.75, +2.00, +2.50, +3.00**



Black    Brown    Lemon    Purple    Tortoise



**FLASH** 54-17-135

Wonderful for camping trips, boating, or just maintenance in your home when low light is a factor. Polycarbonate frame with acrylic lenses. A set of spare batteries included.

**+1.00, +1.50, +2.00, +2.50**



Black    Tortoise



**CLIP-ON READERS** A=58 mm, B=30 mm

Clips on to patients' existing frames to provide reading powers. Ideal for computer use.

**+1.00 to +3.50 in quarter diopters**



Made in USA





Merge style and flexibility with the innovative Fusion Reader Collection. Each frame comes with a set of multi-coloured temples and includes a case. Additional lenses and temples can be purchased separately. An ideal reader or RX frame.

**FUSION READER**

**Option 1**

Fusion or Fusion II frame, 4 temples, custom case

**Option 2**

Fusion or Fusion II frame, 2 temples, custom case

**FUSION FITTING KIT, 6PC**

4 Fusion frames, 2 temples for each frame, custom case  
2 Fusion II frames, 2 temples for each frame, custom case

**FUSION LENS KIT, 20PC**

Fusion lens kit, 20 prs pre-cut Fusion and Fusion II reading glass lenses.

**+1.00, +1.25, +1.50, +1.75, +2.00, +2.25, +2.50, +2.75, +3.00**  
**+1.00, +1.25, +1.50, +1.75, +2.00, +2.25, +2.50, +2.75, +3.00**  
**+1.50, +1.75**



**FUSION 53-17-140**

Semi-rimless ophthalmic frame with interchangeable reading lenses  
Monel frame with polycarbonate A/R back coat lenses and TR-90 temples. **+1.00, +1.25, +1.50, +1.75, +2.00, +2.75**



Brown Brown Gunmetal Red



**FUSION II 50-18-135**

Semi-rimless ophthalmic frame with interchangeable reading lenses  
Monel frame with polycarbonate A/R back coat lenses and TR-90 temples. **+1.00 to +3.50 in quarter diopters**



Black Gunmetal

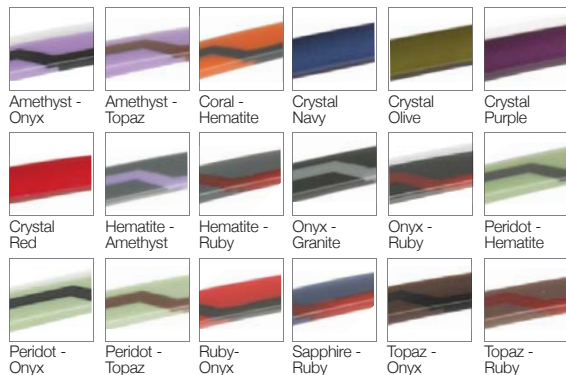

**REPLACEMENT  
TEMPLES**

Switch the look of your Fusion frames with our TR-90 interchangeable temples







Transforms any eyewear into an instant bifocal reading glass. Hydrotac® Stick-On Bifocal Lenses adhere with water, are removable, reusable and provide optically correct magnification on any eyewear.

Hydrotac® Stick-On Bifocal Lenses are a smart alternative to prescription eyewear. Lightweight, ultra-thin pliable lenses in **+1.50, +1.75, +2.00, +2.50, +3.00** diopters.

**FEATURES**

- Fits all eyewear
- Sticks anywhere on your eyewear
- Easy to install and position
- Leaves no residue
- Removable and reusable
- Just add water to adhere
- Can be trimmed for custom applications
- Distortion-free magnification from edge-to-edge

**EASY TO APPLY:**

Clean lens and apply water



Position Hydrotac® Lens



Wipe dry with a cloth



**HYDROTAC® FITTING KIT, 30PC**  
(5 of each power)



**HYDROTAC® FITTING KIT, 12PC**  
(2 of each power)





**ZWICKERS** 

# ACTIVE LIFESTYLE

Progear Optical  
Progear Optical Flex  
Progear Eyeguard  
Swim/Dive  
Safety Eyewear

**Specially designed Bayonet mount** for easy interchange of end-tip and headband (patent pending)



**Screw-less hinge,** easy assembling with no special tools required



**Wide adjustable headband** angles for ergonomic fit



**Neoprene headband** with washable Velcro fastener for easy adjustment

**Adjustable metal core co-molded in TR-90 temple,** double injected with anti-slip, hypoallergenic rubber

**3-D Ball-Joint nose pads,** unlimited angles, fitting every nasal contour easily



**3 front constructions** compression mount rimless, full metal rim and nylon half-eye in stainless steel with nickel-free coating



**Earphone cable holder,** rotate to adjust fitting angle (patent pending)

**Temple hinge precision** molded in wear-free TR-90 material to ensure constant tension



Imagine eyewear so versatile that shifting from office to the outdoors is seamless. With Progear®'s line of active eyewear, you can look as stylish at the gym as you do at work, without ever changing your eyewear. Perfect for nearly all types of casual, non-contact sports, the Progear® Optical Collection offers casual styling suitable for both work and play.

Alternatively, choose the Progear® Flex series for maximum safety and comfort. The Progear® Flex series features shock-dampening and impact-resistant frames.

**FEATURES AND BENEFITS**

- World's first single piece press-formed memory metal top bar, flexible with soft-touch ergonomic fit
- Self adjusting
- Allows easy servicing and maintenance
- Keeps ear buds in place
- Quick and effortless strap mount conversion
- Ultimate comfort and flexibility
- Strength and durability

**OPT-1101**

				<b>6C</b>	<b>CE</b>
56 mm	33.5 mm	16 mm	140 mm		
Gold Light Matte	Black Matte	Dark Gunmetal Shiny	Gunmetal Matte		
Black Matte	Silver Matte	Black Matte	Black Matte		
Brown Rubber	Black Rubber	Blue Rubber	Red Rubber		



**OPT-1102**

				<b>6C</b>	<b>CE</b>
55 mm	30 mm	16 mm	145 mm		
Brown Matte	Black Matte	Silver Matte	Gunmetal Matte		
Grey Metallic	Red Matte	Pearl White Matte	Black Matte		
Brown Rubber	Black Rubber	Grey Rubber	Red Rubber		



\* Top colour in swatch denotes frame colour, bottom colours together denote temple colours



**OPT-1103**

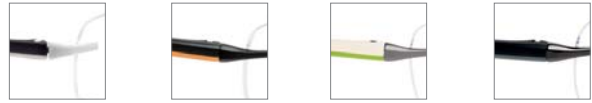

- |              |               |                   |                     |
|--------------|---------------|-------------------|---------------------|
| White Matte  | Black Matte   | Gunmetal Matte    | Gunmetal Dark Matte |
| Black Matte  | Black Matte   | Pearl White Matte | Black Matte         |
| White Rubber | Orange Rubber | Lime Rubber       | Grey Rubber         |



**OPT-1104**

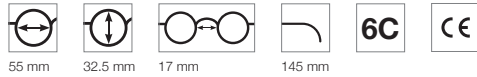

- |                     |              |                |                     |
|---------------------|--------------|----------------|---------------------|
| Gunmetal Dark Shiny | Brown Matte  | Gunmetal Matte | Black Matte         |
| Black Matte         | Black Matte  | Black Matte    | Grey Metallic Matte |
| Black Rubber        | Brown Rubber | Blue Rubber    | Black Rubber        |



**OPT-1105**

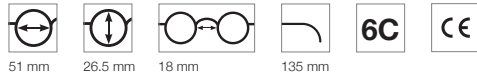

- |             |                     |              |                     |
|-------------|---------------------|--------------|---------------------|
| Black Matte | Gunmetal Dark Matte | Brown Matte  | Gunmetal Matte      |
| Black Matte | Black Matte         | Black Matte  | Grey Metallic Matte |
| Lime Rubber | Orange Rubber       | Brown Rubber | Red Rubber          |



**OPT-1106**

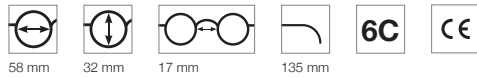

- |              |                          |                   |              |
|--------------|--------------------------|-------------------|--------------|
| Black Matte  | Brown Matte              | Gun Matte         | Silver Matte |
| Black Matte  | Champagne Metallic Matte | Pearl White Matte | Black Matte  |
| White Rubber | Brown Rubber             | Lime Rubber       | Red Rubber   |

\* Top colour in swatch denotes frame colour, bottom colours together denote temple colours

**OPT-1107**



- |                  |              |                   |               |
|------------------|--------------|-------------------|---------------|
| Olive Dark Matte | Silver Matte | Gunmetal Matte    | Black Matte   |
| Black Matte      | Black Matte  | Pearl White Matte | Black Matte   |
| Grey Rubber      | Lime Rubber  | Grey Rubber       | Orange Rubber |



**OPT-1108**



- |                          |                   |              |                     |
|--------------------------|-------------------|--------------|---------------------|
| Brown Shiny              | Silver Matte      | Black Matte  | Gunmetal Matte      |
| Champagne Metallic Matte | White Pearl Matte | Black Matte  | Grey Metallic Matte |
| Brown Rubber             | Grey Rubber       | White Rubber | Red Rubber          |



**OPT-1109**



- |                     |               |             |                     |
|---------------------|---------------|-------------|---------------------|
| Gunmetal Dark Matte | Silver Matte  | Black Matte | Brown Matte         |
| Silver Matte        | Black Matte   | Black Matte | Grey Metallic Matte |
| Black Rubber        | Orange Rubber | Lime Rubber | Brown Rubber        |



\* Top colour in swatch denotes frame colour, bottom colours together denote temple colours



**OPT-1111**

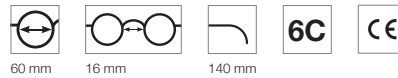

- |                     |                |                     |
|---------------------|----------------|---------------------|
| Gunmetal Dark Matte | Gunmetal Matte | Brown Matte         |
| Black Matte         | Silver Matte   | Grey Metallic Matte |
| Blue Rubber         | Black Rubber   | Brown Rubber        |



**OPT-1112**

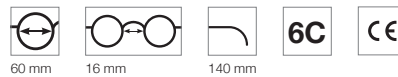

- |              |                |              |
|--------------|----------------|--------------|
| White Matte  | Gunmetal Matte | Silver Matte |
| Black Matte  | Black Matte    | Black Matte  |
| White Rubber | Grey Rubber    | Red Rubber   |



**OPT-1113**

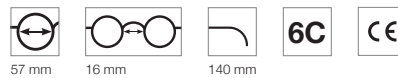

- |                     |              |                   |
|---------------------|--------------|-------------------|
| Gunmetal Dark Matte | Silver Matte | Gunmetal Matte    |
| Silver Matte        | Black Matte  | Pearl White Matte |
| Black Rubber        | Blue Rubber  | Lime Rubber       |



**OPT-1114**



- |               |                |                     |
|---------------|----------------|---------------------|
| Black Matte   | Gunmetal Matte | Silver Matte        |
| Black Matte   | Silver Matte   | Blue Metallic Matte |
| Orange Rubber | Black Rubber   | Black Rubber        |





The first Rx-able safety sports frame that passes all three international safety standards: ASTM F803 (USA), EN166 (Europe) and JIS T8147 (Japan). All Progear® products include a case and microfiber cleaning cloth with a one year warranty against manufacturer's defects.

**FEATURES AND BENEFITS**

- V-shaped groove (1.6 mm high towards the inside) for lens safety in the event of impact
- Solid polycarbonate frame for increased impact protection
- Hypo-allergenic, expanded thermoplastic rubber (TPR) nose pad for additional protection
- Removable and adjustable neoprene band with washable Velcro fastener
- Anti-slip TPR temple pad
- Rimlock barrel and screws made of high quality stainless steel to prevent corrosion with a built-in lockable spacer make Rx glazing easy
- Detachable front shock damper and inner safety side-cushion to absorb impacts
- High viscosity polycarbonate lens with 3 mm center thickness, Plano Anti-fog, scratch-resistant hard coating and UV protection

Progear® Eyeguards meet or exceed ASTM F803-03 impact resistance for several sports. Also meets EN-166 (Europe) and JIS T8147.5.1d (Japan) safety standards.

Sports	Sustains Impact Speed at (m/sec)	Sustains Impact Speed at (mph)
Squash, Badminton, Handball, Basketball, Volleyball, & Soccer	40	90
Racquetball & Paddle ball	40	90
Baseball & Softball	18 (for age < 9) 25 (for age 9-14) 31 (for age >14)	40 55 70

**KIDS - TEMPLE MODEL 48-18-117**  
SUITABLE FOR AGES 6-10 YEARS

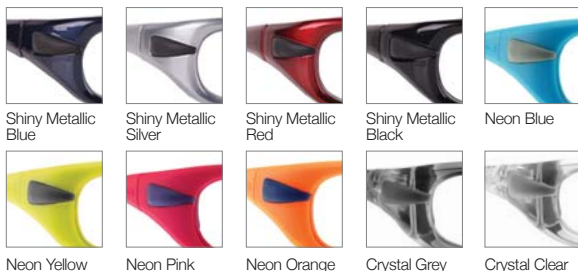

**KIDS - FULL STRAP 48-18**  
SUITABLE FOR AGES 6-10 YEARS





★ **YOUTH - TEMPLE MODEL** 52-18-122  
SUITABLE FOR AGES 11 TO 16 YRS

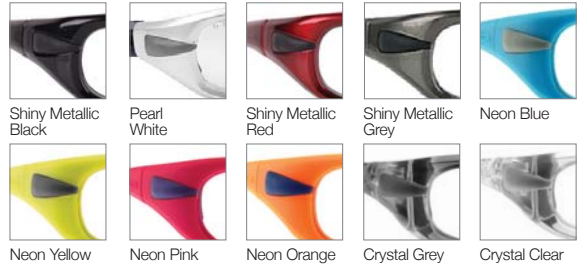

**YOUTH - FULL STRAP** 52-18  
SUITABLE FOR AGES 11 TO 16 YRS



★ **ADULTS - TEMPLE MODEL** 55-19-122



**ADULTS - FULL STRAP** 55-19



**ADULTS X-LARGE - TEMPLE MODEL 57-19-122**

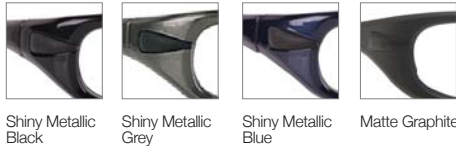

**ADULTS X-LARGE - FULL STRAP 57-19**

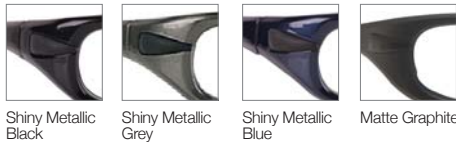

**WINDGUARDS SPONGE**

Designed with sweat absorbing material, excellent for high intensity sports and wind protection. Available in all sizes.

**WINDGUARDS EVA**

Perfect for sports such as cycling, motorcycling, boating and other leisure activities requiring wind protection. Available in all sizes.



**ADDITIONAL ACCESSORIES AND REPLACEMENT PARTS AVAILABLE FOR ALL PROGEAR® EYEGUARD PRODUCTS**

- Full head straps
- Temple straps
- Rubber temple pads and nose pads
- Cases



**STOCK LENSES**

2.0 mm (center thickness) Polycarbonate HMC (Hard Multi-Coat A/R) lenses. Available from **+3.00 to -6.00 with a cylinder range from 0 to -2.00.**

**PROGEAR®  
EYEGUARD FRAME  
& LENS PACKAGE**

**OPTION 1 - Frame Only**  
**OPTION 2 - Frame & Stock Lenses**  
**OPTION 3 - Frame & Stock Lenses w/ Edging and Shipping**



**FITTING KIT, 7PC** Official FIFA soccer ball included



Progear<sup>®</sup> H2O can accommodate a power range of **+6.00 to -11.00, up to 3.00 cyl** and works with any lens material, clear, tinted, anti-fog coated, etc.. Progear<sup>®</sup> H2O has a patented lens glazing structure that uses conventional V-bevel lenses and is water-sealed with a rubber “O-ring”.

Available in two models, standard and large, both manufactured with hypo-allergenic, latex-free, silicone eye-seals and straps. All models come in three frame colours (smoke, indigo and violet). Three bridge sizes are included for a perfect fit, along with a soft neoprene pouch for easy storage and protection after use.

**FEATURES AND BENEFITS**

- Accommodates a power range of **+6.00 to -11.00**
- Completely water tight for leakage prevention
- Hypo-allergenic & Latex free
- Multiple bridge sizes included for optimum PD adjustment
- Soft neoprene pouch for convenient storage
- Replacement parts available



★ **SWIM GOGGLE** HSV-1301

Standard cup size



★ **SWIM GOGGLE** HSV-1302

Large cup size





Recognized by pro and elite triathletes and competitive swimmers for their precise optics, comfort and safety, Sable Swim Goggles are the best choice for the individual professional athlete or for recreational swimmers.

Sable Swim Goggles are available in prescription (advanced, thin-lens aspheric technology for prescriptions **-1.50 to -10.00**.) and non-prescription styles. Flat Lens technology offers spectacular sighting in open water with an Anti-Fog guarantee.

**FEATURES AND BENEFITS**

- Unchanged vision above or underwater. Contact surface with water is absolutely flat. Non-distortion, high precision lenses. Refraction minimized to within 0.125 D.
- Conforms to pupil distance of most near-sighted people. Oval lens. Focal point is offset 4 mm to give a wider field of view. Small, medium or large size bridge available. Small fits PD 61 mm, medium fits 64 mm, large fits 67 mm. 3 mm tolerance creates effective PD range of 58 mm to 70 mm.
- One-touch buckle design. Goggle can be removed without hair tangling.
- 100% silicone gasket and head strap are non-toxic, and non-allergenic. Flexibility of parts extends product life and silicone material provides a superior seal.
- Polycarbonate optical lens is virtually unbreakable with a high gloss, hard coating with UV protection.

**SOAP OR ANTI-REFLECTION SPRAY CLEANERS SHOULD NOT BE USED ON THE LENSES AS THE ANTI-FOG COATING WILL BE DAMAGED**

★ **SABLE SWIM GOGGLE**

Available with black or clear strap option. Separate eye cups are available to match different powered prescriptions. Note: If swim goggles are custom made per customer's request, they will be non-returnable.  
**-1.50 to -6.50 in half diopters, -7.00 to -10.00 in full diopters.**



**DIVE MASK**

Lightweight with an adjustable head strap for comfort. This dive mask is extremely durable with an exceptional field of vision for both snorkeling and diving. Comes equipped with glass lenses. Available in both plano and Rx. Rx model is non-returnable after Rx insertion.  
**-1.50 to -6.50 in half diopters, -7.00 to -10.00 in full diopters.**



Blue/Grey

Black/Yellow



# PROTEKT™

The name says it all for first class safety on the job. Keep yourself safe with clear vision and industry leading protection with Protekt™.

**PROTEKT™ safety frames are available in:**

- Standard Plano
- Adjustable Plano (with adjustable temples)
- Bifocal models



★ **GHOST - PLANO** 80-16-130 ANSI Z87+

Flash mirror and A/R back coating. Meets safety standards as rated by ANSI. Includes a microfiber pouch.



**GHOST - BIFOCAL** 80-16-130 ANSI Z87+

A/R back coating. Meets safety standards as rated by ANSI. Includes a microfiber pouch. **+1.50, +2.00, +2.50**



**PHANTOM - PLANO** 70-15-135 ANSI Z87.1

Flash mirror and A/R back coating, length adjustable temples. Meets safety standards as rated by ANSI. Includes a microfiber pouch.



**MAG 1 - RX-ABLE SAFETY FRAME**

Slim design is ideally suited for use under air packs or helmets. It is manufactured of a high grade DuPont® Nylon and it is ANSI Z87.1 approved. 25mm bridge and short bridle kit available by special order.

Sizes: 46 mm, 48 mm & 50 mm



# CHAINS & CORDS

Fashion Chains  
Eye Glass Loupes  
EK Cat Straps  
Protekt & Ziko Cords  
Croakies

**20/20 FASHION CHAINS**

Our large selection of chains is always available to keep your stock fresh and contemporary with something for every customer.



**RECEIVE  
A FREE  
DISPLAY WITH A  
FASHION CHAIN  
PURCHASE  
OVER \$250**

**FASHION CHAIN COLLECTION**

**LINK CHAIN**  
Multi-coloured beads



★ **BALI CHAIN**  
Silver with aqua beads



**BOHEMIAN CHAIN**  
Silver with beads



**LUCY & BETTY**  
6/pkg, 3 PCS of each colour



**THIN CLASSIC CHAIN**  
6/pkg, 2PCS of each colour



**THICK CLASSIC CHAIN**  
6/pkg, 2PCS of each colour



★ **TWISTER CHAIN**  
6/pkg, 2PCS of each colour

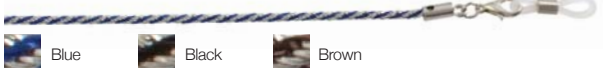

★ **REFLEX CHAIN**  
6/pkg, 2PCS of each colour

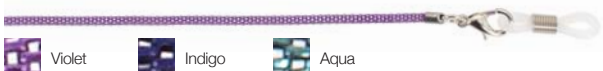

**CAROLINE ABRAM - PARIS CHAIN COLLECTION**

Maroon - Small round

Square 1

Rouge 1

**EUROPEAN CHAIN COLLECTION**

Chain 1-7

★ Chain 1-11

★ Chain 1-13

**"NEK ART" CHAIN COLLECTION**

Chain 2-4

Chain 2-5

Chain 2-6

Chain 2-7

Chain 2-8

Chain 2-9

Chain 2-10

Chain 2-11

Chain 2-12



**"NEK ART" CHAIN COLLECTION - LOUPES**



Chain 2-1



Chain 2-2

RECEIVE  
A T-STAND DISPLAY  
WITH YOUR PURCHASE  
Minimum purchase of  
12 PCS with the 'Nek Art'  
Collection  
& minimum purchase of 24  
PCS with the European  
Collection



**GK STERLING 92.5 SILVER BALI COLLECTION**

Our GK™ Bali Collection. Handcrafted in Bali, these sterling silver 92.5 holders are available in two different pendant styles and come in four different ultra-suede cord colours.



**EYEGLASS HOLDER**



**EYEGLASS HOLDER GK**

Cord Colours:

- Blue
- Green
- Brown
- Black

**CAROLINE ABRAM LOUPES**



★ LOUPES 1



LOUPES 3





**CAT STRAPS**®  
Eyewear Retainers



★ **FAT CATS 3-WAY**

Our 3-Way Eyewear Retainer over sized! The Fat Cat is made with 3mm rope and rubber ends, designed specifically for those extra large earpieces and temples.



★ **THIN CATS 3-WAY**

A thinner version of the original Cat Strap in a 3mm rope made with the same great quality and features. Rubber tubing in a slimmed down style and includes the rubber adjustable slider.



★ **3-WAY**

This retainer can be worn straight off the temple tip or in a spectacle position worn off the temple.



★ **CUSANO LEATHER ELITE- 3-WAY**

Genuine napa leather with enhanced stitching and pewter finished slide adjuster. This eyewear retainer combines fashion and function while keeping eyewear secure. The patented 3-way connector allows you to attach the retainer with three different options; straight, angles, or as a spec attachment. The Cusano Leather 3-Way is available in five colour combinations.

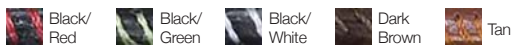

★ **TECH 3-WAY**

Features a revolutionary transparent material designed to stay off your neck and collar for a low profile, comfortable fit. The 3-way end can be worn straight off the earpiece, in a spectacle position, or at an angle.



# ZIKO™

Ziko™ cords are made with the finest quality materials.

## TRAKZ STRAIGHT

Made with 4 mm thick cord and fitted with our custom made Trakz temple grips to fit medium and large frames.

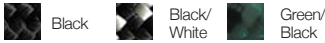

## TRAKZ FAT

Made with 4 mm thick cord and fitted with our custom made Trakz temple grips to fit medium and large frames.



## ★ TRAKZ THIN

Made with 3 mm cord, silicone tube designed to grip sleek wire frames.



## TRAKZ LOOP

Made with the finest quality mountaineering 3 mm cord, fitted with a zero UV resistant end.



## ★ GHOST

Almost invisible but they are always reliable.



## SKINZ ORIGINAL

In top quality full grain leather.



## ★ MICROWINDER

Nylon cord made with basic simplicity. Fun, bright, lightweight and come in a variety of colours.

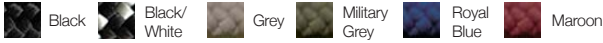

## ★ KIDZ GHOST

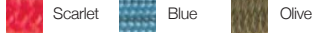

## ★ KIDZ MICRO



## ★ KIDZ SHORTY

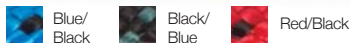

# PROTEKT™

Protekt™ is our economical 20/20 option with quality production and great colour options.

★ **PROTEKT™ SLIDER** takes retainers to a new level, allowing infinite adjustment between 10"-16". Close to the head for a secure fit or off the neck, your choice. Coated cable. Custom printing available.

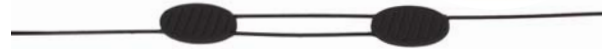

## PROTEKT™ SPORT



★ **PROTEKT™ SPORT ELASTIC**, Latex free ends, Black 12/pkg



★ **PROTEKT™ PREMIUM NYLON**, pkg of 12 per colour



★ **PROTEKT™ WAX DARK**, 6/pkg, 2PCS of each colour



★ **PROTEKT™ WAX NEUTRAL**, 6/pkg, 2PCS of each colour



★ **PROTEKT™ PRO STRETCH**, 6/pkg, 2PCS of each colour

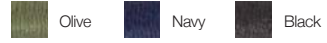

★ **PROTEKT™ PRO SPORT**, 6/pkg, 2PCS of each colour



## PROTEKT™ NEW COLLECTION



## PROTEKT™ LEATHER



## PROTEKT™ APACHE

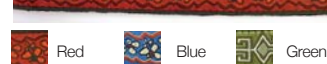



The ARC is Croakies® most technically advanced line of sport retainers, with a sleek and modern look. The ARC stands apart from other cable retainers with superior quality and advanced adjust-ability. The ARC Endless also features Croakies® Endless length adjustment technology.

Ends are available as replacements and in combo packs. Choose your cord and choose your ends for optimum security of your valuable eyewear.

**ARC ENDLESS**

Stainless steel cable with adjustable lengths. Available in:  
 14" Kids - extends to 14" shortens to 9"  
 16" - extends to 16" shortens to 10"  
 18" - extends to 18" shortens to 11"



★ Black with black cones and Silver with white cones available

**TERRA ENDLESS**

15" long & 3.2 mm diameter. Durable woven cord with endless adjustment system.





 Navy
  Brown
  Black

★ **TERRA ENDLESS, LONG**

33" long & 3.2 mm diameter. Durable woven cord with endless



 Navy
  Brown
  Black

**FLOAT KIT**

Includes 4 individual floating buoys in beacon yellow. Easy attachment tool included.



★ **LYCRA® SUITER FLOATER\***

28" long & 0.5" wide. Closed cell foam with adjustable soft foam bead. High-quality, non-absorbent, quick dry Lycra®.



\*Flotation Factor = CFF +1: smaller plastic frames (.04kg - .06kg) & smaller metal frames (.02kg - .03kg)



**SPECIAL OFFERS FOR STARTER KIT**  
 Minimum quantities apply

**ARC END**

Molded UV resistant ends that snap on and off. Available in a package of two.

SIZE	SHAPE
<b>XXL</b> 9-15 mm	
<b>XL</b> 6-9 mm	
<b>REG</b> 3-5 mm	
<b>MICRO</b> 2-4 mm	
<b>XL TITE</b> 7-10 mm	
<b>REG TITE</b> 6-7 mm	

# LAB SUPPLIES

Hand Tools

Tag & Label

Equipment

Lab Consumables

Chemicals

Contact Lens Accessories

Lenses

Repair Parts

**RIMLESS ADJUSTING PLIER**



★ **NYLON ADJUSTING PLIER ROUND / SQUARE**

Nylon pad jaw is 8 mm. Round nose tip diameter 2 mm. Used on semi-rimless cord suspension.

Round or Square Jaw



★ **NARROW DOUBLE NYLON PLIER**

Metal and plastic frames are held firmly without marring or marking. 5 mm wide, ideal for tight spots. Replaceable jaws.



**DOUBLE NYLON PLIER**

10 mm wide jaws.



**LONG NOSE PLIER**

All purpose plier for holding and shaping. Smooth jaw and radius-tapered edges.



★ **SLIMLINE NOSE PAD ADJUSTING PLIER**

Designed so that the hollow side of plier fits around pad receiver on the opposite side of plier. Holds the pad and arm firmly.



**PAD ADJUSTING PLIER**

Designed so that hollow side of plier fits around pad receiver on the opposite side of plier. Holds the pad and arm firmly.



**CARBIDE END CUTTING PLIER, DOUBLE LAP HINGE**

Blades angled at 10 degrees. Length of blades 19 mm for general cutting and to reach in difficult areas with better visibility. Carbide blades designed to effectively cut stainless steel and other hard metals up to 2.1 mm diameter. Dual leaf spring handles.



★ **MINI CARBIDE END CUTTING PLIERS**

Double jointed for extra leverage and strength. Carbide blades designed to effectively cut stainless steel and other hard metals up to 2.1 mm diameter. Dual leaf spring handles.



**SIDE CUTTER**

Durability, strength and power. Carbide blades designed to effectively cut stainless steel or hard metal up to 2.1 mm diameter. Dual leaf-spring handles.



**1 YEAR WARRANTY**  
on all Value tools  
**2 YEAR WARRANTY**  
on all European tools  
for manufacturer defects

**RIMLESS DISASSEMBLY PLIER**

For use with silhouette style mountings.



★ **DOUBLE NYLON JAW EYEWIRE SHAPER**

Adjusts the curvature of the eyewire to the appropriate curvature of the lens.



**RIMLESS MOUNTING PLIER**

For use with silhouette style mountings.



**LENS AXIS ALIGNING PLIER**

Rubber pads are 23 mm long, oval shaped. Self-swiveling pads.



**THREE POINT PLIER**



**BLOCKING PAD REMOVAL PLIER**



**RIMLESS CUTTING PLIER**

Suitable for rimless screws. Allows user to cut screws close to lens surface without scratching. Dual leaf spring handles.



**PEENING PLIER**



**EYEWIRE SIZING PLIER**

Tips are tapered to very fine points and are offset to the side and front of plier jaw. Will access to all types of eye wire hinge barrels.



**PROTEKT™ DISPENSING TOOL RACK 6"**



- ★ BESTSELLER
- EUROPEAN MADE
- VALUE

● **SCREWDRIVER BALL BEARING**



● **★ SCREWDRIVER ALUMINUM**



● **BLADE EXTRACTOR 1.1 mm**



● **BLADE EXTRACTOR 1.5 mm**



● **BLADE EXTRACTOR 2.0 mm**



● **BLADE PHILLIPS 0.062 X 0.062 "**



● **BLADE FLAT 0.040 X 0.040 "**



● **BLADE FLAT 0.062 X 0.072 "**



● **BLADE FLAT 0.062 X 0.087 "**



● **BLADE WRENCH 2.25 mm**



● **BLADE WRENCH 2.0 mm**



● **FILE FLAT, 15 cm**



● **FILE HALF ROUND, 15 cm**



● **FILE EXTRA NARROW, 15 cm**



● **★ STAINLESS STEEL RULER, 15 cm**



● **★ SCREWDRIVER WITH BALL BEARING HEAD**

Knurled body and screw fitting for the blade.  
Diameter of body: 9 mm, Total length: 127 mm



● **BLADE FLAT 1.0 mm**



● **BLADE FLAT 1.5 mm**



● **BLADE FLAT 1.8 mm**



● **BLADE FLAT 2.3 mm**



● **BLADE PHILLIPS**



● **KNOCK OUT WRENCH, 2.0 mm and 2.25 mm**



● **FILE SCREW HEAD SLOTTING**



● **NOSE PAD POPPER**

Notched to slide between pad and pad arm to pop pad off.  
Illustrated instructions included. 2-1/2" L





**PICKUP SCREWDRIVERS**

Jaws automatically adjust by spring tension. Holds screws securely while removing or inserting. Chrome top and handle.



**HEXAGONAL AND STAR WRENCH**

Wrench with spring ejection. Makes the removal of nut easy.



★ **SCREW PICK-UP TWEEZERS, 5.5"**

Locking and holding in one motion. Stainless steel construction. Built in grooves at tip.



**SCREW HOLDING TWEEZERS**



**FINE POINT TWEEZERS**



**PAD REMOVAL TWEEZERS, 6"**

Stainless steel. Push on pad removal tweezers.



- ★ **BESTSELLER**
- **EUROPEAN MADE**
- **VALUE**

**WOODEN BLOCK WITH SCREWDRIVERS**

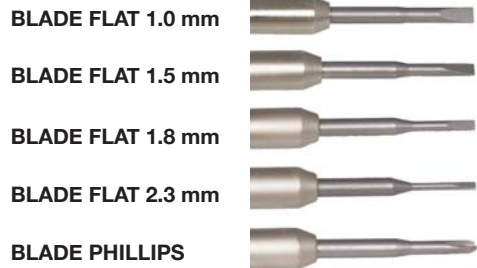

**NUT GRABBER**

Durable stainless steel construction. For easy nut and bolt assembly.



**MOUNTING RIMLESS HOOK**

Hook for use with nylon semi-rimless style mountings.



**RIMLESS MOUNTING HOOK REPLACEMENTS**

Replacement hooks for use with mounting hook. 3pcs

★ **MAGNETIC TOOL BAR, 18"**

Double bar magnetic holder. Holds metal tools firmly, yet releases without effort.





**DISTOMETER**

Measures the distance between the cornea and spectacle or trial lenses (vertex distance). This becomes especially sensitive above plus or minus five diopters.



**LENS CLOCK**

Measures base curve for 1.49 or 1.6 index lenses.



**LENS THICKNESS CALIPER**

Very precise. Measures lens thickness up to 10 mm with an accuracy of 0.01 mm.



**LENS CALIPER**

Gives accurate readings for all lens blanks up to 15 mm. Graduated in 1/10 mm with nylon tips. Throat depth 43 mm.



**SALT PAN WARMER**

Adjustable temperature control, indicator light, 4' grounded power cord and rubber feet. Max temperature 400°F. 6-1/2"(w) x 4-1/4"(h) x 10-5/8"(l).



**GLASS BEADS FOR SALT PAN**

Available in regular & large sizes.



★ **ULTRASONIC CLEANER, 1000ml**

Stainless steel tank, holds multiple pairs of glasses.



**ULTRASONIC CLEANER, 500ml**

Stainless steel tank, holds one pair of glasses.



★ **ULTRASONIC CLEANING SOLUTION**

0.95 L / 32 oz

**FURTHER  
DISCOUNTS  
ON NEW STORE  
OPENINGS**



**HOT AIR WARMER**

Quiet & compact with 6 amps. Reduces danger of burning or drying out frames. Generates both warm and cool air.



★ **FRAME WARMER VUP** 

- ~ 120°C with closed lid
- ~ 150 °C with hot air concentrator inserted.
- Cut-out switch for overheat protection.
- Metal housing.
- 350 W (+5%/-10%).
- 3 Year Warranty



★ **FRAME WARMER FUP PLUS** 

- ~ 150°C with closed lid
- ~ 190 °C with hot air concentrator inserted
- ~ 190 °C with concentrator extension inserted.
- Cut-out switch for overheat protection.
- Electronic heating regulator.
- Cold air option.
- Aluminium housing.
- 350 W (+5%/-10%).
- 3 Year Warranty



★ **HYGIENE BOX** 

Uses a UV-C lamp with high germicide power to destroy bacteria, germs, spores, molds and other micro-organisms from the surface of frames in just a few seconds.

- 3 Year Warranty



★ **TENSIOMETER** 

Tension is applied when mounting a lens. If wrongly applied, such stress can cause distortion and, in glass lenses, chips. Any excessive tensioning on fitted lenses, identified by the tensiometer, should be eliminated.

- 3 Year Warranty



★ **PD METER**

Digital PD meter with a high level of precision. Displays left and right eye measurements with a range from 22.5 mm to 41mm. Near, intermediate and far viewing distance. Measures vertex distance.



**FEATURE  
PRODUCT  
HYGIENE BOX  
SEE NEXT  
PAGE**

**VOLUME  
PRICING ON  
ALL BLOCKING  
PADS**



★ **PROTEKT™ HYDROPHOBIC  
BLOCKING PADS**

18 mm, Full Eye/1000



**PROTEKT™ POWER GRIPPER  
BLOCKING PADS**

Round Blue/1000



**PROTEKT™ POWER GRIPPER  
BLOCKING PADS**

1/2 Eye/1000



**PROTEKT™ JOB TRAYS**

6" W x 1.5" H x 9" D, 26/box, Grey  
6" W x 1.5" H x 9" D, 26/box, White  
Reusable tray labels white bag/100



**LIQUID DISPENSER**

4 oz. Polyethylene bottle with stainless steel pump action lid. One way pump holds flux in well of cap and prevents contamination.



**LENS HOLDER**

High quality polypropylene will not scratch lenses. Lens held in place with snug tension holders. Available in Black & White.



**PROTEKT™ EASY CUT  
PATTERN BLANKS**

Oversize Grey/100



**PATTERN BLANKS**

Oversize or Large White/100



★ **UNIVERSAL SOLDER**

Package of 6. White (Silver) or Yellow (Gold) with flux core. Swiss made.



**WHITE LABELS**

105 pcs - Suitable for plastic frame tags.



**PLASTIC FRAME TAGS**

Bag of 100

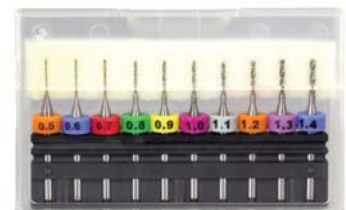

**KIT DRILL BIT 0.5MM-1.4MM**

Also available in individual sizes.



★ **GERMICIDE UV LAMP TO SANITIZE GLASSES AND TRIAL FRAMES**

- Ideal for the optician that wishes to sanitize trial glasses without using water, cleansers or heat
- Through the use of a UV-C lamp with high germicide power it destroys the bacteria, germs, spores, molds and other micro-organisms from the surface of glasses in just a few seconds
- 3 Year Warranty

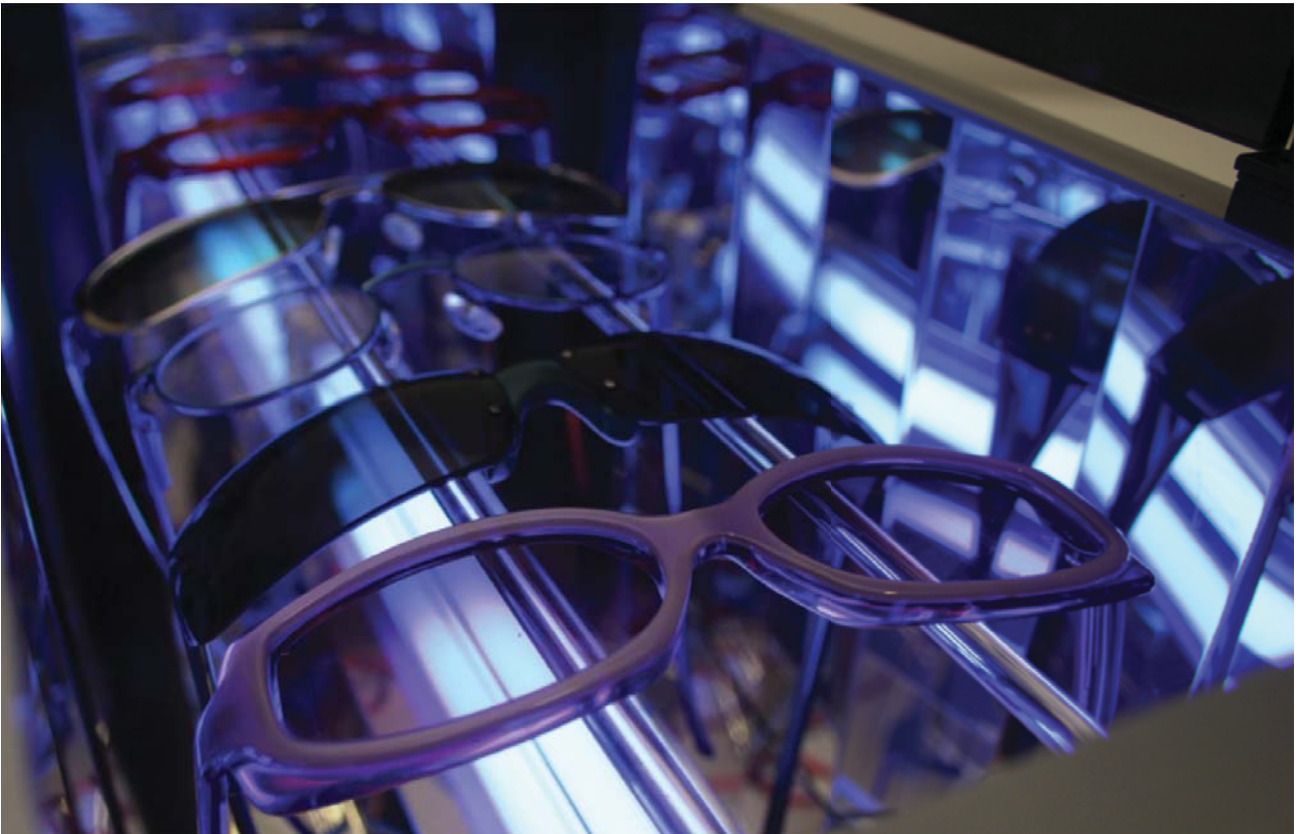



**PROTEKT™ LIQUID DYE**, 114 ml

- Blue
- Charcoal
- HD Black
- Cool Grey
- G15
- Green
- Pink
- Sunglass Brown
- HD Brown
- Top Gun Grey
- Yellow



**PROTEKT™ BLUE BLOCKER**, 114 ml



**UV SHIELD CONCENTRATE**  
250 ml



★ **ALL OFF**  
Ink remover, 16 oz



★ **LOCTITE**, 10 ml  
Available in Purple (Nickel Silver) and Blue (Stainless Steel).



**A/R STRIPPER**  
250 ml



**HEAT TRANSFER FLUID**  
1 L/4 L



**NEUTRALIZER**  
1 L/4 L



**LOCTITE SUPER BONDER**, 3 ml



**POLISHING COMPOUND CR39**



**POLISHING COMPOUND POLYCARBONATE**

LAB SUPPLIES | CONTACT LENS ACCESSORIES



**OVERNIGHT TRAY**



**CONTACT LENS MAILER**, 100PC



**LARGE TWEEZERS**



**PLUNGER**

<p><b>CR-39 POLARIZED</b> 2.1 x 70 mm Made in Japan</p>	 <p>★ Grey</p>	 <p>★ Brown</p>	<p>ALL LENSES PACKAGED IN OUR NEW LENS BOX FOR EASY STORAGE Inquire about volume pricing</p>	
<p><b>CR-39</b> 1.8 x 74 mm</p>	 <p>Grey</p>	 <p>G15</p>		
<p><b>CR-39 GRADIENT</b> 1.9 x 72 mm</p>	 <p>Grey w/Silver Mirror</p>	 <p>Grey</p>	 <p>Brown</p>	 <p>Brown w/Silver Mirror</p>
<p><b>POLYCARBONATE POLARIZED</b> 1.5 mm (50 x 70 mm) Made in Japan</p>	 <p>Grey</p>	 <p>G15</p>	 <p>Brown</p>	
<p><b>POLYCARBONATE</b> 1.8 x 74 mm</p>	 <p>Grey</p>	 <p>G15</p>	 <p>Brown</p>	
<p><b>TRI-ACETATE POLARIZED</b> 0.8 mm (66 x 60 mm) Made in Japan</p>	 <p>Dark Grey</p>	 <p>★ Light Grey</p>	 <p>★ Brown</p>	



Screw it in, snap it off, frame repairs in a snap. Snap-it™ stainless steel screws with thread lock have a unique, extra-long feeder tab that makes handling screws a cinch. After a screw is inserted into a hinge or eyewire, the long feeder tab simply snaps off. The screw is left with a smooth finish to eliminate clipping and filing.

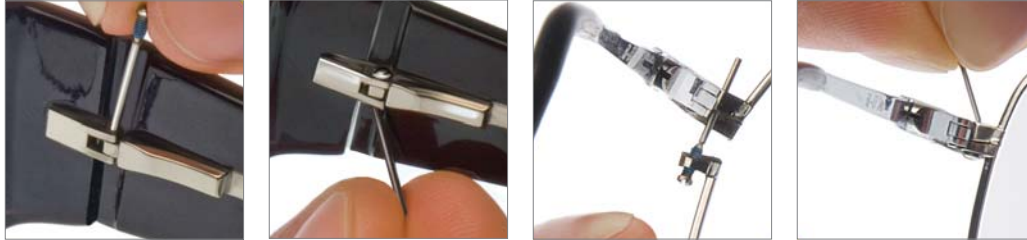

**ASSORTED SNAP-IT SCREW KIT**

Contains 250PC - 10 sizes 25 screws each



★ Silver

Gold

**SNAP-IT HINGE**

50 PC/pkg

Thread x Length x Head	PART #
1.3 x 3.5 x 2.0 mm	9133520
1.4 x 3.5 x 2.0 mm	9143520
★ 1.4 x 4.0 x 2.0 mm	9144020
1.4 x 4.8 x 2.0 mm	9144820
1.4 x 5.5 x 2.0 mm	9145520
1.4 x 4.0 x 2.5 mm	9144025
1.4 x 4.8 x 2.5 mm	9144825
1.4 x 5.5 x 2.5 mm	9145525
1.5 x 3.5 x 2.0 mm	9153520
1.5 x 4.0 x 2.0 mm	9154020
1.5 x 4.8 x 2.0 mm	9154820
1.5 x 5.5 x 2.0 mm	9155520
1.5 x 4.0 x 2.5 mm	9154025
1.5 x 4.8 x 2.5 mm	9154825
1.5 x 5.5 x 2.5 mm	9155525

**SNAP-IT EYEWIRE**

50 PC/pkg

Thread x Length x Head	PART #
1.3 x 3.0 x 1.8 mm	9133018
1.4 x 3.0 x 1.8 mm	9143018
1.5 x 3.0 x 1.8 mm	9153018
1.2 x 4.0 x 1.8 mm	9124018
★ 1.3 x 4.0 x 1.8 mm	9134018
★ 1.4 x 4.0 x 1.8 mm	9144018
1.5 x 4.0 x 1.8 mm	9154018
1.2 x 4.8 x 1.8 mm	9124818
1.3 x 4.8 x 1.8 mm	9134818
1.4 x 4.8 x 1.8 mm	9144818
1.5 x 4.8 x 1.8 mm	9154818

\*Please specify Gold as "G" or Silver as "S" after code number.



★ PREMIUM SCREW KIT

Contains 1000PC - 10 skus 100 of each



PREMIUM SCREW HALF KIT

Contains 500PC - 10 skus 50 of each



★ STANDARD SCREW KIT

Contains 1000PC - 10 skus 100 of each



SPECIALTY NOSE PAD KIT

Contains 100pairs - 10 skus 10 pairs of each



★ EYEWIRE - STAINLESS STEEL

100 PC/pkg, Made in Germany

★		1.2 x 4.4 mm
		1.4 x 3.0 mm
		1.4 x 3.5 mm
★		1.4 x 4.0 mm
		1.4 x 4.5 mm
		1.4 x 2.8 mm (safety)
		1.4 x 3.3 mm (safety)
★		1.4 x 3.8 mm (safety)
★		1.4 x 4.3 mm (safety)
		1.6 x 5.8 mm

★ HINGE - STAINLESS STEEL

100 PC/pkg, Made in Germany

★		1.2 x 3.1 mm Spring Hinge (safety)
★		1.3 x 3.1 mm Spring Hinge (safety)
		1.4 x 3.5 mm Spring Hinge (safety)
★		1.4 x 4.0 mm Spring Hinge (safety)
		1.4 x 4.5 mm (safety)
		1.4 x 4.4 mm

★ SELF TAPPING - STAINLESS STEEL

100 PC/pkg, Made in Germany

		1.3 mm Small Head
★		1.4 mm Small Head
★		1.5 mm Large Head

★ NOSE PAD - NICKEL SILVER

100 PC/pkg, Made in Germany

★		1.0 x 4.1 mm
		1.1 x 5.5 mm



★ NUTS & BOLTS

100 PC/pkg, Made in Germany





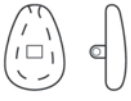
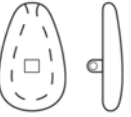
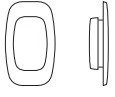

		1.4 x 10.5 mm Silver 1.4 mm Hexnut Silver
★		1.2 x 10.6 mm Silver 1.2 mm Hexnut Silver
		1.16 x 9.35 mm Gold 1.16 mm Hexnut Gold

		1.4 mm Hexnut Plastic Coated
		Bushing Plastic
		Washer Plastic
		Cap Silicone

**SPECIALTY NOSE PADS**

SIZE & SHAPE	SCREW-IN	SNAP-IN
<b>10 mm AIR PADS</b> Silicone 20 prs/pkg		N/A
<b>13 mm AIR PADS</b> Silicone 20 prs/pkg		N/A
<b>10.5 mm MONO</b> Silicone 25 prs/pkg	N/A	
<b>9 mm ROUND</b> Gel 5 prs/pkg		



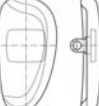
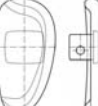
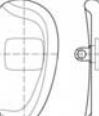
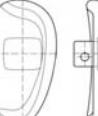



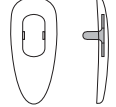
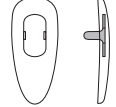

**PVC GERMAN NOSE PADS - 25 prs/pkg**

SIZE & SHAPE	SCREW-IN	SNAP-IN
<b>11 mm OVAL</b> PVC		
★ <b>13 mm OVAL</b> PVC		
★ <b>15 mm D-SHAPED</b> PVC		
<b>17 mm D-SHAPED</b> PVC		
<b>19 mm D-SHAPED</b> PVC		

**SPECIALTY B&L NOSE PADS - 20 prs/pkg**

SIZE & SHAPE	SILVER	GOLD
<b>15 mm B&amp;L</b> PVC - Crimp-On		N/A
★ <b>14.5 mm B&amp;L</b> Silicone - Crimp-On 10 prs/Silver & 10 prs/Gold		

**SILICONE PREMIUM GERMAN NOSE PADS - 25 prs/pkg**

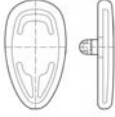
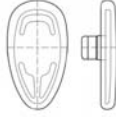
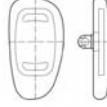
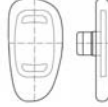
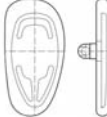
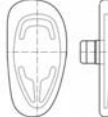
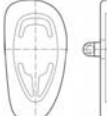
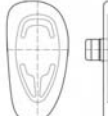







SIZE & SHAPE	SCREW-IN	SNAP-IN
<b>7.5 mm ROUND</b> Phthalate & Latex free		
<b>9 mm ROUND</b> Phthalate & Latex free		
<b>10 mm SYMMETRICAL</b> Phthalate & Latex free		
★ <b>13 mm SYMMETRICAL</b> Phthalate & Latex free		
<b>16 mm SYMMETRICAL</b> Phthalate & Latex free		
★ <b>15 mm D-SHAPED</b> Phthalate & Latex free		
<b>17 mm D-SHAPED</b> Phthalate & Latex free		
<b>19 mm D-SHAPED</b> Phthalate & Latex free		

\* All Images not actual size





**SPECIALTY GERMAN NOSE PADS**

SIZE & SHAPE	SCREW-IN	SNAP-IN
<b>9 mm ALT. BASE</b> Silicone Phthalate & Latex free 25 prs/pkg	N/A	
<b>12 mm ALT. BASE</b> PVC 25 prs/pkg	N/A	
<b>11 mm AIR PADS</b> Silicone Phthalate & Latex free 5 prs/pkg		N/A
<b>14.5 mm AIR PADS</b> Silicone Phthalate & Latex free 5 prs/pkg		N/A
<b>13 mm PRIMADON-NA</b> Silicone 25 prs/pkg	N/A	
<b>15 mm PRIMADON-NA</b> Silicone Phthalate & Latex free 25 prs/pkg	N/A	
★ <b>14.5 mm WAVE</b> Ultra-Comfort Pad Silicone 5 prs/pkg		
<b>13 mm SLIM</b> Titanium 5 prs/pkg		
★ <b>13 mm THIN</b> PVC Phthalate & Latex free 25 prs/pkg		

**STRAP BRIDGES - 5/pkg**

SIZE & SHAPE	SCREW-IN	SNAP-IN
<b>38.8 mm</b> PVC	N/A	
★ <b>28.5 mm</b> Silicone		
<b>30.5 mm</b> Silicone Phthalate & Latex free		
★ <b>36.8 mm</b> Silicone Phthalate & Latex free		
<b>38.8 mm</b> Silicone Phthalate & Latex free	N/A	

**SADDLE BRIDGES - 3/pkg**

<b>14.9 mm GOLD</b> Silicone		
<b>16.9 mm GOLD</b> Silicone		

★ **STICK ON NOSE PADS - Silicone, 24 prs/pkg**

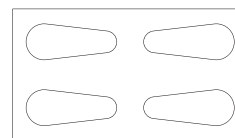

**VALUE PACK NOSE PADS - 100 prs/pkg**



SIZE	7.5 mm ALT. BASE PVC, Snap Only	9 mm ROUND Silicone	★ 13 mm SYMM. Silicone	★ 15 mm SYMM. Silicone	15 mm D-SHAPED Silicone	17 mm SYMM. Silicone
<b>SHAPE</b> - available in snap and screw type unless noted.						

\* All Images not actual size

★ **BESTSELLER**

**ROUND TEMPLE TIPS**

5 prs/pkg

<b>1.2 x 65 mm</b> Butyrate	 Black	 Tortoise
<b>1.4 x 65 mm</b> Silicone	 Black	 Brown

**PVC ROUND TEMPLE TIPS**

10 prs/pkg

<b>1.2 x 65 mm</b>	 Black	 Brown
<b>1.3 x 65 mm</b>	 Black	 Brown
<b>1.4 x 65 mm</b>	 Black	 Brown
★ <b>1.5 x 65 mm</b>	 Black	 Brown
★ <b>1.6 x 65 mm</b>	 Black	 Brown

★ **TEMPLE TIP REPAIR KIT**

Assortment of black and brown PVC temple tips in 1.2 - 1.6 mm core sizes. Five pairs of each color and size.



★ **TEMPLE LOCKS**

One size silicone temple locks. Available in clear or brown. Minimum five pairs per colour.



**CONVERSION ENDS**



**1.25 mm ROUND KIDS**    **1.4 mm ROUND**

Silicone

Silicone

**PROTEKT™ CLEAR HEAT SHRINK**



★ 3 mm = 0.5 mm when shrunk  
★ 5 mm = 1.0 mm when shrunk  
★ 7 mm = 1.5 mm when shrunk

**PROTEKT™ HEAT SHRINK TUBING**



2.36 mm = 1.17 mm when shrunk, 10PC  
5 mm = 2.5 mm when shrunk, 10PC

★ **DELUXE KEYCHAIN SCREWDRIVER**



★ **RIMLESS CORD**  
0.5 mm or 0.6 mm



**FIGURE 8 LINER**  
0.47 mm, 0.51 mm or 0.6 mm



**FLAT LINER (T-Bar)**



★ **LENS LINER**  
0.010 or 0.020 gauge



**LENS TITE**



\* All Images not actual size

# DISPLAYS

Display Rods  
Display Rod Accessories  
Locking Rods  
Display Panels  
Mobile Displays  
Storage Solutions  
Accessory Display Center  
Counter Displays  
Mirrors

**CONTACT US  
FOR ALL YOUR  
DISPLAY NEEDS**

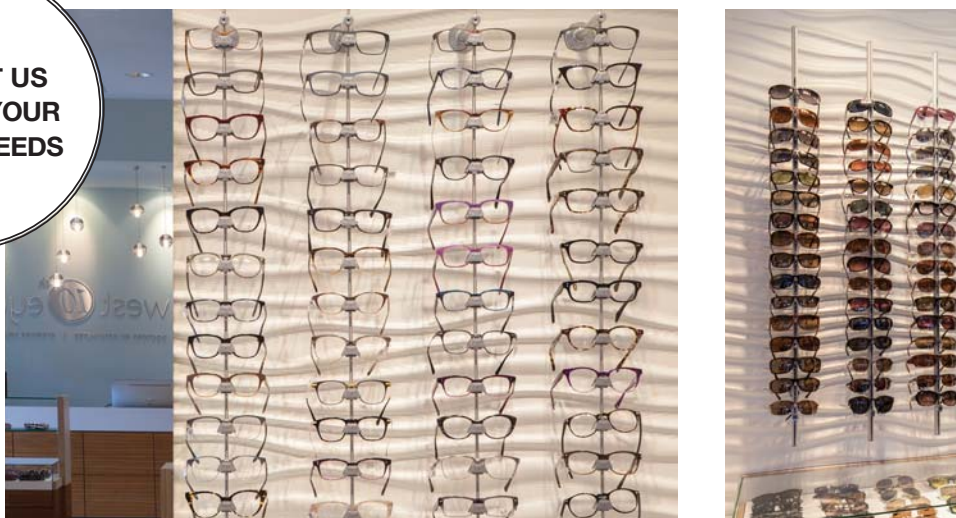

## **TIPS FOR A SUCCESSFUL DISPENSARY**

Use subtle display systems that showcase the product, not the system.

Never devalue your products by displaying them on low-quality systems.

Use efficient lighting that will draw attention of passers-by and entice them inside.

Create a lighting angle that effectively showcases your frames.

Energize your presentation with lit posters and graphic design elements.

Keep your space neat and uncluttered. Avoid using too many displays as this will only make it look disorganized.



The patented FixX™ Display System utilizes stainless steel and anodized aluminum components to create an updated and contemporary dispensary look. Frames are held by the patented Eyeglass Support Pod (ESP) which allows frames to be displayed in several different ways. This flexibility combined with various mounting options allow a dispensary to be re-created and refreshed at no additional cost.

**Choose your mounts - available in two lengths 2" or 7"**

316 Marine grade stainless steel rods for exceptional strength and durability allow two different mounting methods, wall or counter/valance mount. Twelve grey display pods come with each display rod.

Typically, frame rods are anchored by two mounting points. Our wall mounts allow the rods to be mounted dually or by one center point. Mounting by one center point gives great flexibility in varying rod placement.



**WALL MOUNT, 2"**

Anodized aluminum finish.



**DUAL MOUNT  
FRAME ROD,  
42" or 48"**



**SINGLE MOUNT  
FRAME ROD,  
42" or 48"**



**WALL MOUNT, 7"**

Anodized aluminum finish.



**COUNTER / VALANCE MOUNT, 2"**

Anodized aluminum finish.



**Pod Display Options:**

Three different looks for thousands of pairs of glasses.



**DISPLAY PODS**

Display pods are available in clear, grey or copper.



**OVAL MAGNIFYING MIRROR**



**PLEXI SHELF, 5.5" D x 10" W**



**DISPLAY ROD MIRRORS**

Attaches to frame rods.

Mirror Sizes:  
6.75" W x 11" H  
6.75" W x 23" H



**ACCESSORY POST, 3"**



**ROD LOGO HOLDER**

Plexi glass logo holder 4" W x 2" H.  
Fits Avery labels 05163.  
Slides onto an ESP pod.







**LOCKING ROD, 48"**

Bridge gap when closed 15 mm.  
Holds 16 frames.

**LOCKING ROD LOGO HOLDER**

4" W x 2" H. Fits Avery labels 05163.  
Attaches to locking frame rod.



**LOCKING ROD MIRROR**

5.75" W x 3.875" H. Clean cut rectangular  
mirror. Attaches to locking frame rod.



Open



Closed



**DISPLAY PANEL, 36" X 48"**

Fits four frame rods. Frosted clear finish.  
Rods not included.

**FULLY  
CUSTOMIZABLE  
PANELS**

**DISPLAY PANEL, 20" X 80"**

Fits two frame rods. Frosted clear finish.  
Rods not included.

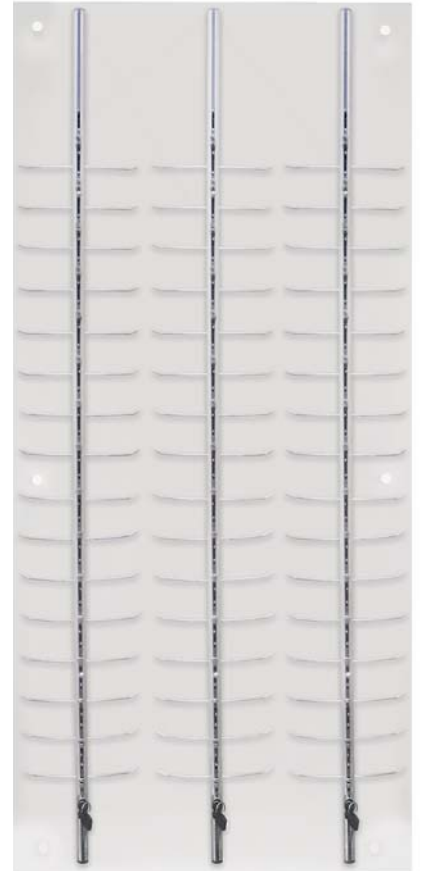

**DISPLAY PANEL, 28" X 80"**

Fits three frame rods. Frosted clear finish.  
Rods not included.

**PANEL WALL MOUNTS, 2" & 4"**

Aluminum



**STAINLESS STEEL FRAME HOLDER**

Stainless steel mounts available upon request.





**EYE-CENTER SINGLE**

24.5" W x 78" H, Foot print - 24.5" W x 16" D  
Holds 64 frames, locking or non-locking rods.  
Available in black or silver.

**EYE-CENTER DUAL**

45" W x 78" H, Foot print - 45" W x 16" D  
Holds 128 frames, locking or non-locking rods.  
Available in black or silver.

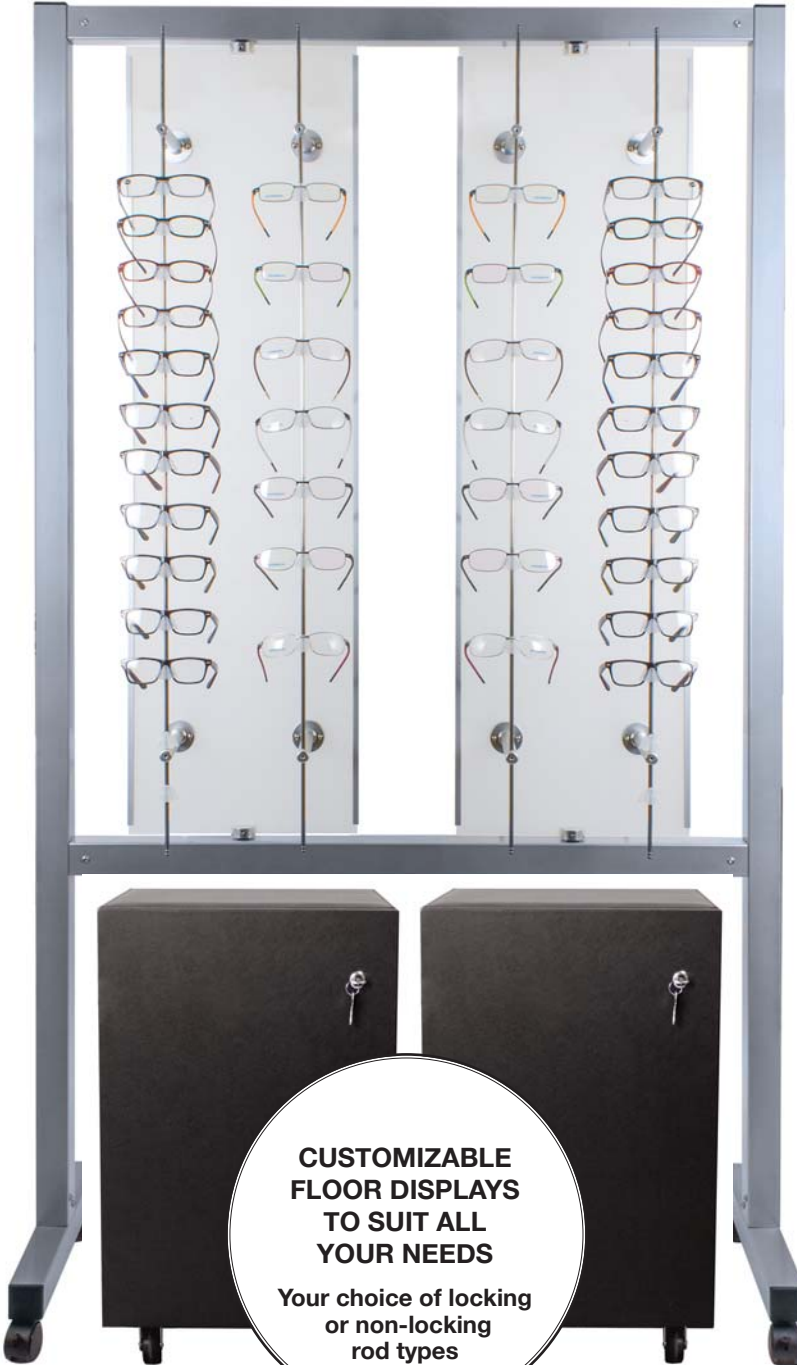

**CUSTOMIZABLE  
FLOOR DISPLAYS  
TO SUIT ALL  
YOUR NEEDS**  
Your choice of locking  
or non-locking  
rod types

See Storage Solutions for this specific unit.

The FiXX™ mobile locking & non locking frame rod displays allow for complete flexibility in deciding the optimum display for your practice.

Choose the type and number of rods per panel to create a custom floor display unit suited uniquely to your dispensary. Inquire about pricing.

**DOUBLE YOUR  
FRAME COUNT  
WITHOUT DOUBLING  
WALL SPACE**



**WALL MOUNT DISPLAY**

15" W x 52.5" L x 22" D.  
Rotating wall mount. Locking or non-locking display holds 64 frames within 15" of wall space. Two rods per side, 16 frames per rod.



**EYE-TREE,  
18" X 18" FOOT PRINT**

Locking & non-locking available.  
Holds 64 frames.  
Available in silver.

Organize your dispensary with some of these great FIXX™ storage solutions. Configured to optimize space and reduce clutter, these organizers are an ideal way to store extra frame stock, sunglasses or excess manufacturer's cases. Castors allow the units to be moved to a secure location if required. Drawers pull out completely to act as a display case.



### ROLLING STORAGE AND DISPLAY CABINET, 14 DRAWERS

15" W x 34.5" H x 15" D

14 drawers -168 places for ophthalmic frame display and storage. Faux leather finish, padded top. Available in black only.



### ROLLING STORAGE AND DISPLAY CABINET, 10 DRAWERS

15" W x 34.5" H x 15" D

10 drawers -100 places for sunglass frame display and storage. Faux leather finish, padded top. Available in wenge and black.



Present patients' new eyewear in these elegant FIXX™ presentation trays. Use these stylish boxes to store overstock frames, to send home with customers viewing multiple frames or as a retail item. Custom logoing available for this product.

**FRAME STORAGE AND OVERNIGHT BOX**

6.25" W x 9" L x 2" H  
Custom logoing available for this product.



**FRAME "SAFE"**

6.875" W x 1.625" H x 4" D  
Convenient and stylish - keep your glasses out of harms way with the Frame "Safe". One for the office, night stand and car. Features strong magnetic closure and sturdy construction. Easily accepts today's larger frame styles.



**PRESENTATION TRAY**

6.25" W x 9" L x 2" H



**LEATHER RECTANGULAR MIRROR**

8" W x 13" H x 7" D



**PROTEKT™ EYE-CENTER CABINET**

15" W x 24" H x 15" D  
Perfect for cases, extra inventories or accessories. Features two compartments and locking door.



Use this display center to promote and easily access specific categories of products in your practice. This unit can conveniently showcase readers, frames, sunglasses or overglasses.



**Step 1  
Pick Your Cabinet**

Storage Options  
Style (Ophthalmic or Sunglass)  
Colour (Black or Wenge)

**Step 2  
Pick Your Display Panel**

Panel (12 pieces or 24 pieces)

**OR**

**Customize Your Own**

Style of panel  
Number of display pods





## CLEAN & CRISP ACCESSORY CENTRE

Wall mount & mobile units available. Inquire further.

DESIGN YOUR  
ACCESSORY  
DISPLAY



With the FIXX™ Eyewear Support Pod (ESP) System, you have the flexibility to display your frames in three different ways; by the bridge with temples open, by the bridge with the temples closed or by the temples themselves. The ESP's are completely modular so you can have your frames facing straight ahead or slightly twisted to one side. You can also increase and decrease the spacing between your frames on the rods.

The ESP's are removable, so once a frame is sold, its pod can be removed so there is no misconception of theft. You also have the choice of how many frames you wish to display from season to season, without having open gaps in your dispensary.



**DISPLAY PEDESTALS**

Rod lengths:  
 2PC - 6", 3PC - 9", 4PC - 12", 5PC - 15"  
 Pod colour choices, grey, copper and clear.  
 See Display Rod Accessories page.



**DISPLAY ROCKS**

9" and 12" rod lengths. Each base is unique.  
 Pod colour choices, grey, copper and clear. See Display Rod Accessories page.



**PALM**  
4" W x 8.25" H x 4.25" D  
Hand carved individual frame display.  
Custom colours available.



**NOSE**  
2.25" W x 6" H x 2.5" D  
Hand carved individual frame display.  
Custom colours available.



**MANNEQUIN HEAD, MALE**  
7" W x 5.5" H x 8.75" D



**MANNEQUIN HEAD, FEMALE**  
6" W x 5" H x 8.25" D



**EYESTEIN DISPENSING ACCESSORY CENTRE**  
Inquire with our Customer Service team.

## DISPLAYS | MIRRORS

Add style to your dispensary with our beveled counter and wall-mount mirrors with a polished chrome finish. Counter mirrors feature weighted and padded bases for extra stability, while the wall-mount mirrors come equipped with a tilting rod to keep fingerprints off the glass. Choose from a traditional oval shape or an inverted trapezoid shape which is perfect to frame a face for eyeglass dispensing.

### OVAL WALL MOUNT MIRROR

10.5" W x 15" H



### ILLUMINATED RECTANGULAR DISPENSING MIRROR

11" W x 5.75" H



### TRAPEZOID WALL MOUNT MIRROR

10.5" W (Top) x 12.5" H  
6.5" W (Bottom)



### TRAPEZOID DISPENSING MIRROR

10.5" W (Top) x 12.5" H  
6.5" W (Bottom)



### LARGE OVAL DISPENSING MIRROR

10.5" W x 15" H



### MEDIUM OVAL DISPENSING MIRROR

8" W x 10.5" H



### HAND-HELD MIRROR

5.1" W x 7" H  
2x magnification front mirror  
1x magnification back mirror



# PROMOTIONAL

Eye-Patch  
Accessories



The Eye-Patch mobile and Eye-Patch tablet are customizable microfiber cleaners, excellent for advertising your business and cleaning the screen of any mobile device - tablets, cell phones, e-readers and the list goes on. Delivered to you in as little as two business days\*. Give away this marketing tool to everyone who walks through the door. The more you give, the more exposure you will receive. Just like a tweet, the Eye-Patch Mobile and Eye-Patch tablet will give you more exposure than a newspaper ad at a fraction of the price.

\*Pertains to Eye-Patch tablet and upon approval of artwork.

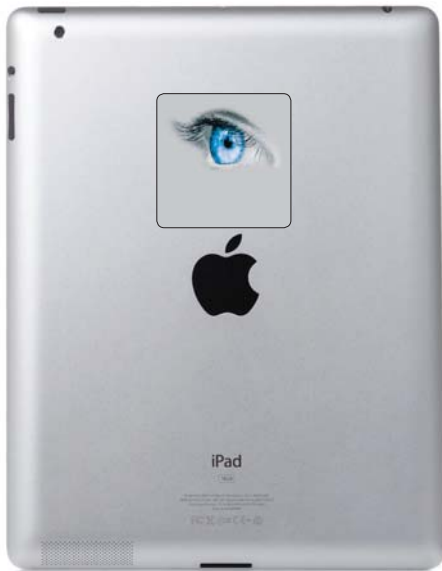

**EYE-PATCH TABLET, 2" X 2"**

Customizable microfiber patch to advertise your business and clean mobile device screens. Colour options: Blue, Green, Grey or Pink.



**EYE-PATCH MOBILE, 1" X 1"**

Customizable microfiber patch to advertise your business and clean mobile device screens.



STANDARD VERSION



CUSTOMIZE WITH YOUR COMPANY INFORMATION



**MINI EYEGLASSES**

Size 2.5" W x 1" H.  
Minimum 1 pkg of 30 pcs.



**OPTEGO READER**

A completely clear and portable reader in **+2.75** power. Use alone or over current glasses and contact lenses. \*Custom printing available.



**SCARAB VISOR CLIP**

\*Custom printing available.  
Minimum 20 pcs. 10 of each colour.



YOUR LOGO HERE



**UNI READER**

Light rimless unisex reader with polycarbonate frame front and slim temples. **+1.00, +1.25, +1.50, +1.75, +2.00, +2.50 & +3.00**

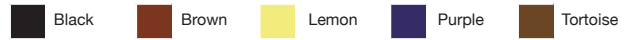

**BOOKMARK MAGNIFIER W/CLIP**

2.5x magnification, pocket size magnifier with a clip. Comes with a carrying case to prevent scratches. \*Custom printing available.



**VISOR CLIP**

Clips onto the flip down visor in your car and opens to place the temples of your glasses inside. \*Custom printing available.



\*Custom printing available on minimum 200 piece orders.

**ACCOUNT TERMS**

A signed credit application is required for all accounts. Account payments are net 30 days from invoice date. Interest of 2% per month will be charged on all overdue accounts.

**SHIPPING & HANDLING**

Shipping & handling will apply to orders of \$100.00 net or less, special order items and all display items. Carriers will be assigned at the discretion of 20/20 Accessory Source Ltd. unless otherwise requested.

**RETURNS**

All products are returnable for a period of six months from invoice date due to manufacturer's defects. Products may be exchanged or credited during this period at the discretion of 20/20 Accessory Source Ltd. All returns must be accompanied by a valid RMA# (return number) and original packaging. To obtain an RMA#, please contact Customer Service. Returns without a valid RMA# may be subject to a 25% restocking fee. Personal misuse not covered.





**20**  
TWENTY  
Accessory Source Ltd.



T 604.465.3469 | 1.800.265.3937 | F 604.465.0164 | 1.888.497.3937  
20165 113B Ave, Maple Ridge BC V2X 0Z1 | [www.2020as.com](http://www.2020as.com)