



# **MATE**

## **System Controller and Display**

Installation and User Manual

for the OutBack MATE and MATE2

# Warranty

*Dear OutBack Customer,*

Thank you for your purchase of OutBack products. We make every effort to assure our power conversion products will give you long and reliable service for your renewable energy system.

As with any manufactured device, repairs might be needed due to damage, inappropriate use, or unintentional defect. Please note the following guidelines regarding warranty service of OutBack products:

- Any and all warranty repairs must conform to the terms of the warranty.
- All OutBack equipment must be installed according to their accompanying instructions and manuals with specified over-current protection in order to maintain their warranties.
- The customer must return the component(s) to OutBack, securely packaged, properly addressed, and shipping paid. We recommend insuring your package when shipping. Packages that are not securely packaged can sustain additional damage not covered by the warranty or can void warranty repairs.
- There is no allowance or reimbursement for an installer's or user's labor or travel time required to disconnect, service, or reinstall the damaged component(s).
- OutBack will ship the repaired or replacement component(s) prepaid to addresses in the continental United States, where applicable. Shipments outside the U.S. will be sent freight collect.
- In the event of a product malfunction, OutBack cannot bear any responsibility for consequential losses, expenses, or damage to other components.
- Please read the full warranty at the end of this manual for more information.

## About OutBack Power Systems

OutBack Power Systems is a leader in advanced energy conversion technology. Our products include true sine wave inverterchargers, maximum power point charge controllers, system communication components, as well as breaker panels, breakers, accessories, and assembled systems.

## Notice of Copyright

MATE System Controller and Display Installation and User Manual © 2004 All rights reserved.

## Disclaimer

UNLESS SPECIFICALLY AGREED TO IN WRITING, OUTBACK POWER SYSTEMS:

(a) MAKES NO WARRANTY AS TO THE ACCURACY, SUFFICIENCY OR SUITABILITY OF ANY TECHNICAL OR OTHER INFORMATION PROVIDED IN ITS MANUALS OR OTHER DOCUMENTATION.

(b) ASSUMES NO RESPONSIBILITY OR LIABILITY FOR LOSS OR DAMAGE, WHETHER DIRECT, INDIRECT, CONSEQUENTIAL OR INCIDENTAL, WHICH MIGHT ARISE OUT OF THE USE OF SUCH INFORMATION. THE USE OF ANY SUCH INFORMATION WILL BE ENTIRELY AT THE USER'S RISK.

## Date and Revision

October 2008, REV C  
Software Version 4.1.4

## Contact Information

OutBack Power Systems  
19009 62nd Ave. NE  
Arlington, WA 98223  
Phone (360)435-6030  
Fax (360)435-6019  
outbackpower.com

# Contents

	<b>INTRODUCTION</b> .....	7
	MATE Specifications and Features .....	8
	Manual Setup .....	10
	Installation .....	10
<b>1</b>	<b>Basic Operation</b> .....	<b>12</b>
	Power Up .....	13
	MAIN Screen.....	15
	How to Read a MATE Screen.....	17
	Screen Types .....	19
<b>2</b>	<b>MATE Setup</b> .....	<b>20</b>
	Set Up the MATE .....	21
	Setting the Clock .....	22
	Contrast Adjustment .....	24
	Backlight Adjustment .....	25
<b>3</b>	<b>MATE Summary Screens</b> .....	<b>27</b>
	<b>Summary Screen Overview</b> .....	<b>28</b>
	FX Summary Screen .....	29
	Charge Controller Summary Screen .....	29
	Summary Screen Options .....	29
<b>4</b>	<b>MATE Communications Options</b>	
	Communications Options .....	34
	Communications Errors.....	37
	Errors and Debugging .....	37
<b>5</b>	<b>MATE Status Screens</b> .....	<b>39</b>
	<b>Status Screen Overview</b> .....	<b>40</b>
	Reading a Status Screen.....	41
	FX Status Screens .....	42
	Status Mode.....	42
	Status Meter .....	43
	Status Battery .....	44
	Status Error .....	45
	Status Warning .....	46
	Status Disconnect .....	47
	Charge Controller Screens .....	48
	Status Mode.....	48
	Status Meter .....	49
	Status Setpoint .....	50
<b>6</b>	<b>MATE Hot Keys</b> .....	<b>51</b>
	INV Hot Key .....	52
	AC In Hot Key .....	53
	AC Input Control .....	53
	Gen Start Control.....	54
	Charger Control .....	54
	Charger Mode Control.....	55
	Equalization .....	56

7	<b>Advanced MATE Menus</b> .....	58
	MATE Control Modes.....	59
	The Advanced Menu.....	60
	FLEXnet DC.....	62
	HBX Mode.....	63
	Grid-Use Mode.....	69
	Weekday Grid-Use Start.....	71
	Weekday Grid-Use Stop.....	72
	Weekend Grid-Use Start.....	73
	Weekend Grid-Use Stop.....	73
	Automatic Generator Start (AGS) Mode.....	74
	AGS Setup.....	75
	Quiet Time.....	80
	Voltage Start.....	85
	Load Start.....	86
	Must Run.....	89
	State of Charge.....	93
	Timers.....	94
	Generator Exercise.....	96
	Exercise Period.....	98
	<b>MATE DEFAULTS</b> .....	<b>99</b>
8	<b>MATE Menu Map</b> .....	<b>104</b>
	Menu Structure.....	105
	MATE Menus.....	109
	Menu Map Overview.....	123
	MATE Menu Map Overview.....	124
	<b>APPENDIX</b> .....	<b>125</b>
	Troubleshooting.....	128
	User Information and Settings.....	129
	Warranty.....	130
	Product Registration.....	131



# Introduction

The OutBack Power Systems MATE serves several functions:

- Displays and configures the system and its components—the FX Series Inverter/Charger, the FLEXmax 80 and FLEXmax 60 Charge Controllers\*, and the FLEXnet DC
- Coordinates system operation, maximizes performance, and prevents multiple products from conflicting
- Permits adjustments of your power system through a series of convenient display screens, which allow switching among different components, viewing the status of each and changing settings

\* MX60 Charge Controller—remote controls the AUX function and displays, but does not control, all other functions

When connected to an OutBack HUB communications manager, a single OutBack MATE can:

- Link to as many as ten FX Series Inverters/Chargers, OutBack Charge Controllers and additional future OutBack Power System products.
- Issue a global Bulk or EQ recharging command which includes the Charge Controller's charging function.

This manual will show step-by-step use of the OutBack MATE to best run a power system.

## MATE At a Glance

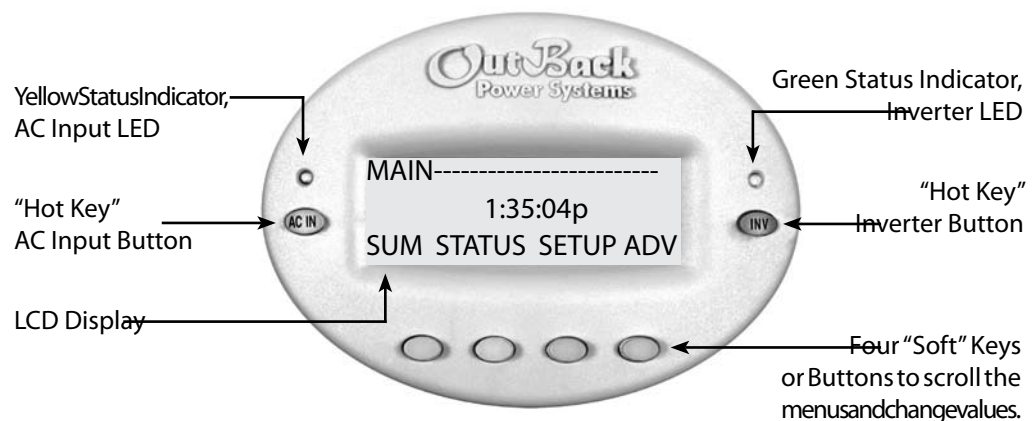

## MATE Specifications

- Communication Protocol: proprietary OutBack multi-drop network
- Interconnecting Cable: CAT 5 (8 IATIA 518B) PC non-crossover network cable
- Maximum Tested Cable Length: 1000 feet (300 meters) of cable in an office/commercial building



---

NOTE: Signal degradation can result if cable is run in conduit with AC wiring or in other electronically “noisy” environments; these can affect the maximum length the cable can run without incurring transmission errors.

- PC computer interface: RS232 Opto-Isolated DB9 serial communication port



---

NOTE: OutBack Power Systems does not produce or technically support any PC computer software programs compatible with its products. The following companies sell compatible software:

RightHand Engineering LLC (Winverter software)  
19310 226th Ave NE Woodinville, WA 98077  
(425) 844-1291  
Info@RightHandEng.com

Intellact (WattPlot software)  
57 Mary Street, Alton, Ontario, Canada L7K 0E3  
416-907-2076  
wattplot@intellact.ca

---

## OutBack MATE Functions

*Why use a MATE with your OutBack Power System FX Series Inverter/Chargers and Charge Controllers? What exactly does it do?*

A typical power system providing utility-supplied electricity requires very little from a user. Other than flipping an occasional tripped circuit breaker back on due to an overload and paying a monthly bill, there is little to monitor or adjust. A renewable energy (RE) system requires more diligence and attention, including battery maintenance and setting various times and voltages for the system to act efficiently and economically.

Utility-supplied power is generated, monitored, and controlled by systems you neither see nor maintain. An RE system requires some combination of inverter/chargers, batteries, charge controllers, and an RE power source, often including a generator, all of which need monitoring and adjusting for optimum performance. The OutBack MATE provides a window to your system and allows setting each OutBack component for its best and most efficient usage according to your power needs and living conditions.

The MATE’s functions occur in to two general areas:

1. The display of information about or the status of different system components and actions
2. Enabling the user to control certain system functions, e.g., the times or the conditions under which they will occur



With the MATE, a user can know the system's activity and conditions at any given time. Sometimes, after careful observations, a user might want to change the conditions or set points which cause an action to occur.

## What is a set point?

A set point is a condition, measurement, or baseline a user establishes in order for something else to happen. A home thermostat offers a simple example. When predetermined temperatures and times are set for weekdays and weekends, the thermostat signals to a heating/cooling system to turn on at one time until a certain temperature is reached, maintain that temperature, and finally shut off at a later time, usually during sleep hours to conserve energy. Otherwise, the user would have to manually control the system. An outdoor light connected to a timer turns on when its set point—a certain time of the night—occurs. You can set various set points for your power system, such as when a generator turns on and shuts off, using the MATE.

### Among other functions, the OutBack MATE:

- Displays FX Series Inverter/Charger functions and allows the user to establish the conditions—time of day or the voltage of the battery, for instance—that initiate or shut off these functions.
- Shows FX AC current and AC and DC voltage-related information including the source (AC input, load, or batteries), the voltage levels of the batteries, and recharging voltages.
- Instantly displays any FX or Charge Controller errors as well as the specific component affected for easier troubleshooting.
- Displays Charge Controller modes, programs the FLEXmax 60 and FLEXmax 80 Charge Controllers and allows control over their AUX functions.
- Using the AGS function, the MATE will start a two-wire generator at pre-set times, including different settings for weekdays and weekends, as well as *exercise* periods for generator maintenance.
- Displays all readings of the FLEXnet DC.

The MATE allows a user to view, monitor, and establish all the pertinent settings and values that occur while the system is running. From time to time, these settings and values might be adjusted as components are added or upgraded, electrical loads increase, or patterns of usage change. Making these adjustments using the MATE is similar to adjusting any number of electronic devices we all use every day, such as a clock radio whose wake-up time and stations are pre-set.

Programming the start and stop times for different sources of energy (when to use grid-supplied power, stored battery power, or generator-supplied power) and determining the frequency and duration of battery recharging are highly recommended with any RE system. Many settings are based on battery voltage. Certain voltages, for example, will trigger battery recharging (a low voltage, as recommended by the battery manufacturer) while others stop recharging (a high voltage value, also recommended by the battery manufacturer). The OutBack MATE accommodates a wide range of time-based and voltage-level functions and conditions for maximum control of your power system while working through the FX Series Inverter/Chargers and OutBack Charge Controllers.

As you go through the manual, start with the simple functions, such as setting the system's clock and calendar, to familiarize yourself with the OutBack MATE's feel and capabilities. While using your system, you might change settings from time to time depending on the season of the year and the cost of grid-supplied power during peak and off-peak hours. For additional information and discussion on the OutBack MATE, please go to [www.outbackpower.com](http://www.outbackpower.com) and join our forum discussions.

## Manual Setup

The MATE is a micro-computing device which means it is less powerful and smaller in size than a personal computer. A user will often scroll through a series of MATE screens in order to view the system status or change system conditions. This manual will show all the MATE screens and tell what they do.

- Chapters 1-5: setting basic items and display options (when, how, and what you want to view) with the “soft keys,” enabling the user to get around the MATE and change its settings.
- Chapters 6-7: changing the settings of MATE specific critical functions such as battery recharging (HBX), generator usage (AGS), and using grid-supplied power (Grid Use modes).
- Chapter 8 and the Appendix: lists and explains all the MATE menus. Some functions are not MATE-specific functions and are placed at the end of the manual for easy searching. Values for MATE specific functions, such as FX or OutBack Charge Controller specific functions, are covered in their respective manuals.

The MATE displays three kinds of screens:

- Screens pertinent to the MATE’s own functions, such as its clock and display
- FX function screens which deal with its inverting and charging processes
- Screens showing Charge Controller modes and status
- FLEXnet DC functions

Although the MATE displays values and functions for the FX and OutBack Charge Controller (shown as “CC” on the screens), the values reside within the components themselves.

## Installation

The OutBack MATE:

- Designed for surface mounting in an indoor location, just below the eye level of a typical user (the MATE 2 is designed for recessed installation, requiring a 13.97 cm X 10.16 cm (5 1/2” X 4”) opening to be cut in a wall and four drywall screws or other fasteners to secure it)
- Readability of the display is affected by direct sunlight
- Connects to other OutBack devices using standard non-crossover Cat5 or Cat5e cable
- Has voltage less than 30 VDC and is thus considered a “limited energy circuit” normally requiring no conduit (consult your local inspector for specific installation requirements)



---

NOTE: The MATE is shipped with (1) OBCAT 3 and (1) OBCAT 10 Cat5 cables with the correct RJ45 connectors already installed. Longer (up to 1000’) or shorter cables can be purchased (at home improvement and computer stores) pre-made or custom length cable can be made on site. Follow the cable manufactures’ instructions when choosing connectors, punch-down tools, and crimping tools. Incorrect crimping or handling of Cat5 cable can negatively affect the operation of the MATE. Cat5 cable is not as robust as standard house wiring and must be handled carefully. Avoid kinking the cable or tearing its outer sheathing. Use plastic stand-off cable staples, J-hooks, or cable trays to support long runs of Cat5 cable. Do not splice cables. Cable runs must be protected and runs must be in approved conduit and not exposed to the weather.

---

## To Install the MATE:

- Install all other OutBack components first.
- Run the CAT 5 cable from the source (HUB, FX or Charge Controller) to the MATE's location. Connect the CAT5 cable to the source but not to the MATE just yet.
- If connecting a computer to the MATE or MATE2, run a serial cable from the computer to the MATE's location, but do not connect the cable at this time.
- Unsnap the MATE's back plate and find the four screw holes. If a MATE2 version is used, the back cover need not be removed.
- The MATE and MATE2 are designed for easy wall mounting using appropriate fasteners (molly bolts, screws, etc.).
- Power up every OutBack device connected directly or indirectly (through the HUB) to the MATE and then connect the CAT5 cable to the jack and, if used, the computer serial cable to the RS-232 port, on the back MATE or MATE2.
- If installing the MATE, snap the MATE onto the back plate and push any excess cable back into the wall. If installing the MATE2 version, secure its four corners to the wall.

## MATE2 Dimensions

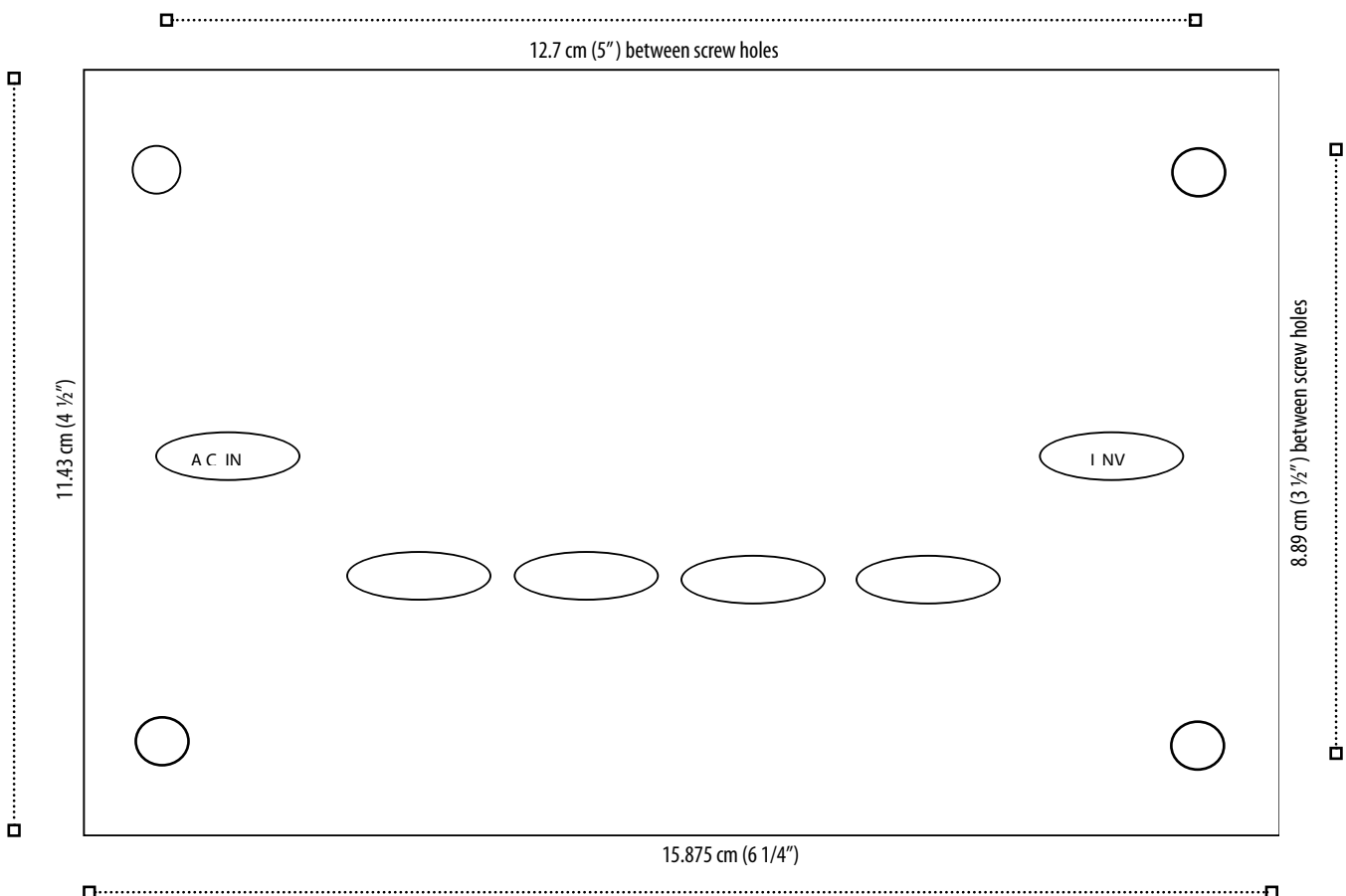

# 1 Basic Operation



---

NOTE: For a viewing of all MATE screens, please see pages 110-124 at the end of this manual.

---

## Power Up

As soon as the MATE cable is plugged into a powered OutBack product, the MATE itself will power-up and display several information screens.

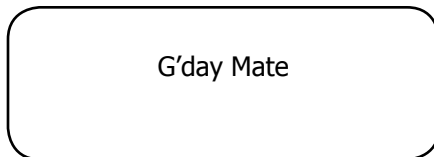

**First Screen**

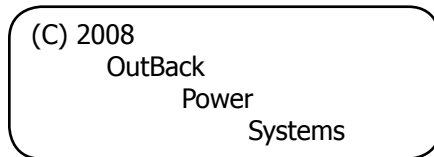

**Second Screen**

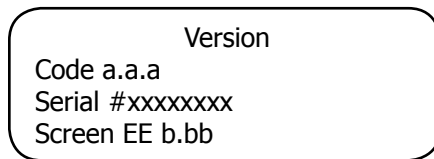

**Third Screen**

- “Code” dictates the MATE’s operation and features\*
- Serial #” matches the bar code sticker inside the MATE on its circuit board
- “Screen EE” refers to the MATE’s menu system



---

NOTE: you will need the code and serial number of the MATE if contacting OutBack Power Systems regarding its operation

---

Searching for Devices  
FX Found



Fourth screen (one of the following):

- The MATE found an FX Series Inverter/Charger

Searching for Devices  
CC Found



- The MATE has found a Charge Controller.

Searching for Devices  
HUB Found



- The MATE has found the HUB.

Searching for Devices  
DC Found



The MATE has found the FLEXnet DC.

Port Assignment  
1> FX 2> FX 3> CC 4> CC  
5> 6> 7> 8>  
9> 10> 2M>



- Port Assignment screen follows the HUB Found screen
- Each Port used will show its connected component.

Searching for Devices  
No Devices Found



- The MATE has not found an OutBack product. If the MATE does not find the connected device, refer to page 129, Troubleshooting

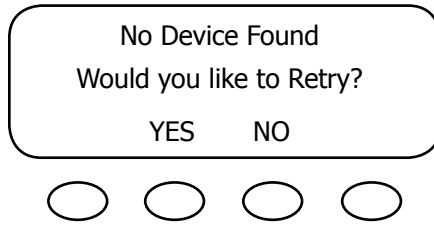

MAIN Screen

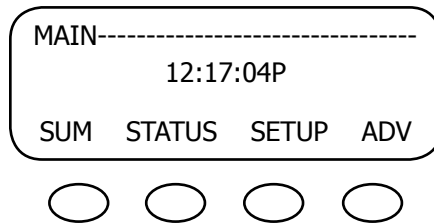

The MAIN screen appears after the MATE detects the HUB (and any devices connected to it) or detects a single device if a HUB is not in use. The MAIN screen is always the same with the exception of the time display. At the bottom of the MAIN screen are the four soft key commands.

<SUM>

SUMMARY shows the direction and amount of power flow in regard to inverting, charging, selling, and/or pass through. It also shows the voltage of the battery. Please see the *FX and VFX Series Inverter/Charger Programming Manual* for a description of these functions.

<STATUS>

The STATUS screen is the first step in viewing the status of either the OutBack Charge Controller or FX Series Inverter/Charger and any of their meters and conditions.

<SETUP>

The SETUP screen leads to additional screens showing some common set points and parameters of either the MATE or an FX Series Inverter/Charger. These screens allow adjustments to such features as the MATE's clock and background lighting or whether the power input to the FX is coming from a grid or a generator.

<ADV>

The ADVANCED screen leads to screens for the FX Series Inverter/Charger, the OutBack Charge Controller, and the MATE itself that allow for changing each component's advanced settings.



Press the first two soft keys from any screen to return to the MAIN screen.

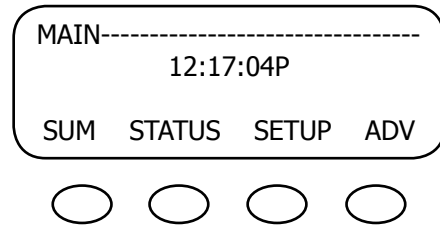

## Navigation

This section of the manual will cover how to use the buttons on the MATE to navigate the menus.

## MATE Buttons



Six buttons or keys navigate the MATE and change its settings:

### HOT KEYS

- Two FX dedicated “hot” keys are labeled **AC IN** and **INV**.
- Pushing **AC IN** will return to the first of four AC input “hot” screens. Repeated pushing cycles through the four AC input screens.
- Pushing the **INV** hot key will return to its “hot” screen to control the FX inverting function.

### SOFT KEYS

- Each soft key corresponds to the word on the screen directly above it unless you are on the Summary screen.
- The soft keys navigate the menus (<UP>, <DOWN>, <NEXT>, <BACK>, or <TOP>).
- They can change settings (<OFF>, <AUTO>, <ON>, <INC> to increase values and <DEC> to decrease values).
- The soft keys perform other functions depending on the individual menu screen.



NOTE: Pressing and holding the two lower left keys at the same time will always bring up the MAIN screen. Pressing one key sooner than the other may lead to a different screen.



## How To Read a MATE Screen

MATE screens will either show values that can be changed or navigate to value screens. The information on the MATE's screen is segregated by type or task and distinguished by location on the screen and the choice of lowercase or uppercase letters. Occasionally it can be misread by a user. The following example is shown for clarification.

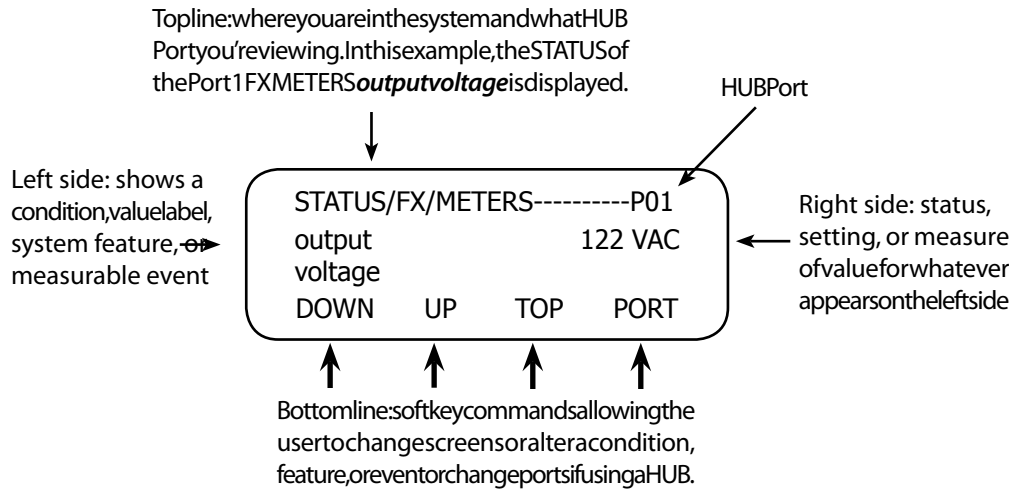

### Soft Key Related Abbreviations

ADV - Advanced	INC - Increase
AGS - Advanced Generator Start	INV - Inverter
AUX - Auxiliary Output	MIN - Minutes
BATT - Battery	PG1, PG2, PG3, PG4 - Page One, Page Two, etc.
CAL - Calibration	RSET - Reset
CHGR - Charger	SETP - Setup
CNT - Contrast	SRCH - Search
COMM - Communication	STAT - Status
DEC - Decrease	SUM or SUMRY - Summary
DISCON - Disconnect	TMRS - Timers
EQ - Equalize	WARN - Warning
GEN - Generator	P01 - Master FX
HBX - High Battery Transfer	PO2, PO3, etc. - Slave FXs

- **LOCATION**—the top line, STATUS/FX/METER-----P01 (the HUB’s first Port) indicates STATUS then FX then METER have been selected from the MAIN screen. Pressing the <DOWN> or <UP> soft keys displays the different METER screens. Pressing the <PORT> soft key advances the Port number if there are other devices connected to the HUB. If no HUB is present, this will read “P00”.
- **LABEL**—the screen’s left side shows a condition, system feature, or measurable event. If the text forms too long a statement across the screen, the words will be stacked one above the other such as “output voltage” above. When misread, it’s viewed as “output...122 vac... voltage” when in fact this screen is stating the output voltage is 122 VAC.
- **VALUE SETTING**—the right side of this screen states the output voltage at 122 VAC. Some screens allow adjustment of this value setting when appropriate.
- **SOFT KEYS**—the bottom line, DOWN UP TOP PORT, are the soft key commands which facilitate either a change of screens in the METER menu using <DOWN>, <UP> or <TOP> soft keys or a change of HUB ports using the <PORT> soft key.

In other cases, a MATE navigation screen leads to a screen that can require a user’s action. The screen below, for instance, asks you to choose a category—HBX, GRIDUSE, AGS, or ADV. Once chosen, you often are given the choice to change or alter part of your system’s functioning, such as the voltage level the batteries must drop to before automatically recharging or the times the generator runs.

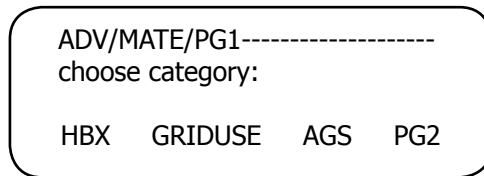

On All Screens:

- Lowercase letters normally show a condition or system item that can be altered or otherwise adjusted.
- Uppercase letters identify a screen’s name or indicate a step to follow to arrive at a screen with these values.

### Key to the Example Diagrams



Soft keys



Solid black indicates key can be pressed

↓ Down arrow will lead to the next screen

↑ Up arrow points to one or more keys that will change a value

**DOWN**



Pressing <DOWN> leads to the next menu

**UP**



Pressing <UP> leads to the previous menu

Although the OutBack MATE menu display screens vary depending on the unit's software version, the menu structures and navigation are the same for all versions. The MATE uses a branching menu structure to display various OutBack products' operation modes and statuses. The menus are divided by product type and are categorized by either type of settings or the information being displayed as shown in the following example.

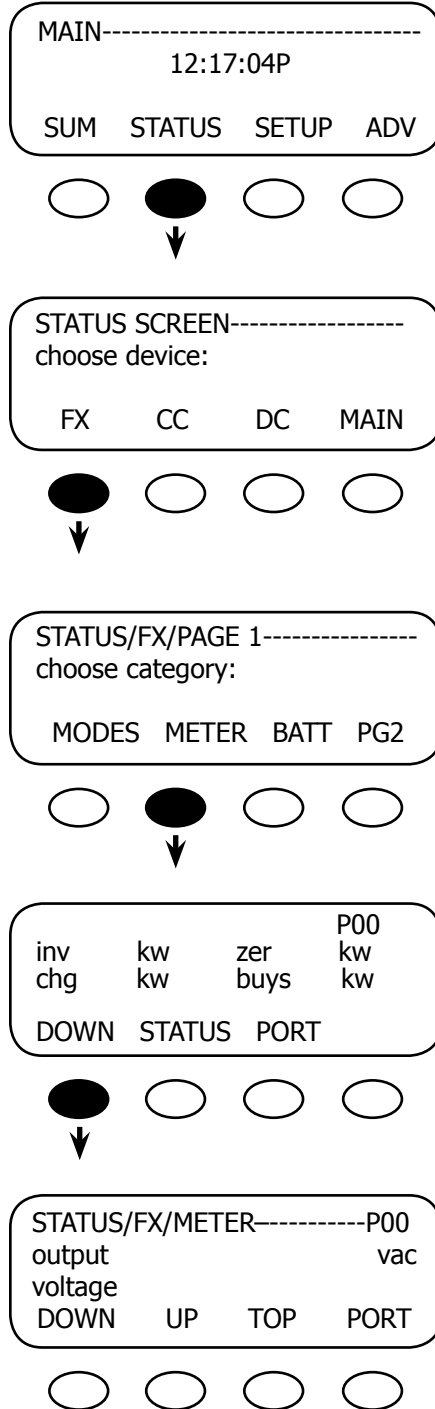

All the screens showing the FX's AC meters are grouped together in one menu branch allowing the user to find the required meter with a minimum of key presses.

# 2 MATE Setup

## Set Up the MATE

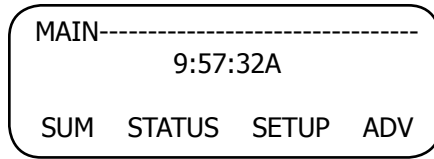

Start with the <MAIN> screen, which appears after the power-up screens, and press the <SETUP> soft key.

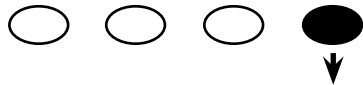
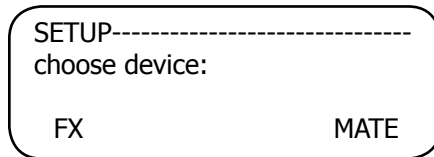

Press the <MATE> soft key.

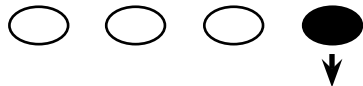
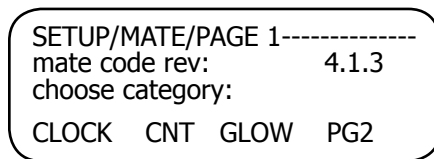

This screen displays the MATE's code version and leads to the CLOCK display, CONTRAST (CNT), and GLOW or back lighting.\* Press the <PG2> soft key for a second screen of SETUP choices.

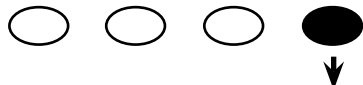
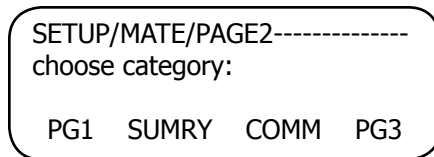

Press the <PG1> soft key to return to the previous screen, SETUP/MATE/PAGE1. This screen leads to the SUMMARY (SUMRY) screens, which control how information is displayed. The COMMUNICATION (COMM) screens display MATE communication options.\* Press the <PG3> soft key to advance to the next SETUP screen.

\*For SUMMARY screens, please see pages 27-29. See pages 33-37 for COMMUNICATION screens.

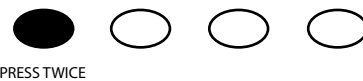
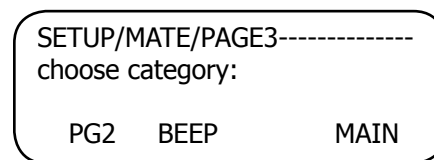

PRESS TWICE

PAGE 3 allows the user access to the BEEP function (the noise made when any key is pressed). See page 26 to activate or deactivate this function. Press the first soft key twice to return to the CLOCK function.



Note: To return the MATE to its factory default settings, please see page 100.

## Setting the Clock

*Why you want to do it:* Certain functions—such as when to use grid-supplied power (Grid-Use Mode) or generator (Advanced Generator Start Mode)—are dependent on accurate time and date settings. Otherwise, the system will never work optimally.

SETUP/MATE/PAGE1-----  
 mate code rev: 4.1.3  
 choose category:  
 CLOCK    CNT    GLOW    PG2

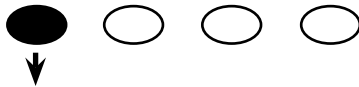

Choose **<CLOCK>** from the SETUP/MATE/PAGE1 SETUP choices screen.

SETUP/MATE/CLOCK-----  
 Tu 1/01/03  
 12:00:00P  
 BACK    DATE    TIME



**<DATE>** and **<TIME>** adjust the MATE's clock and calendar functions. The correct time and date are required for some MATE Control Modes to operate correctly. Pushing the **<BACK>** soft key returns you to the previous screen.



---

NOTE: The MATE clock does not automatically adjust for daylight savings time or leap year.

---

Current Day  
 Tu 9/26/07  
 INC DAY                      SET MONTH



To adjust the date, press the **<DATE>** soft key to bring up the Current Day menu.

**<INC DAY>** changes the day (Monday-Sunday). Press the **<SET MONTH>** soft key after changing the day. The next screen, which shows automatically after hitting **<SET MONTH>**, adjusts the month.

Current Month  
 Mo 9/26/07  
 INC MONTH                      SET DATE



**<INC MONTH>** changes the month.

Press the **<SET DATE>** soft key after changing the month. The next screen adjusts the date.

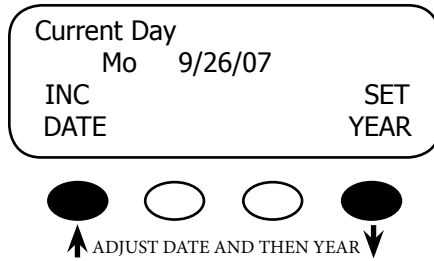

<INC DATE> changes the day of the month. Press the <SET YEAR> soft key after changing the date. The next screen adjusts the year

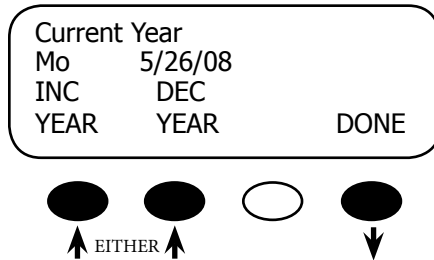

<INC YEAR> or <DEC YEAR> changes the year setting. Press the <DONE> soft key after the date change is final. This returns the MATE to the SETUP/MATE/CLOCK screen.

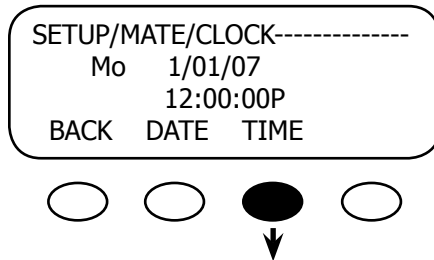

<TIME> sets the MATE's time. Pressing the <TIME> soft key leads to the *Current Hour* screen.

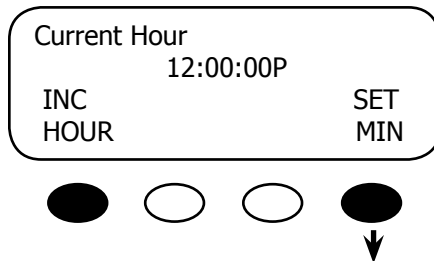

<INC HOUR> sets the correct hour. Press the <SET MIN> soft key when finished to return to the Current Minute screen.

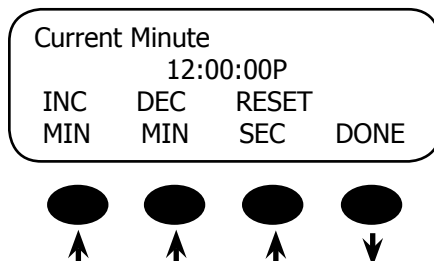

Adjust the minutes by pressing the <INC MIN> or <DEC MIN> soft keys as needed. Pressing the <RESET SEC> soft key begins the seconds count at zero. Pressing the <DONE> soft key returns the MATE to the SETUP/MATE/CLOCK screen.

## Contrast Adjustment

*Why you want to do it:* Everyone has different eyesight and ambient lighting varies with every location of a MATE. Like any other monitor, you may want to adjust the lighting and contrast for easier reading.

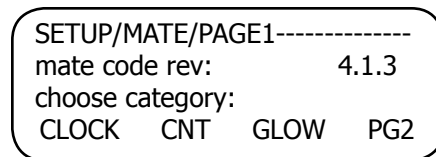
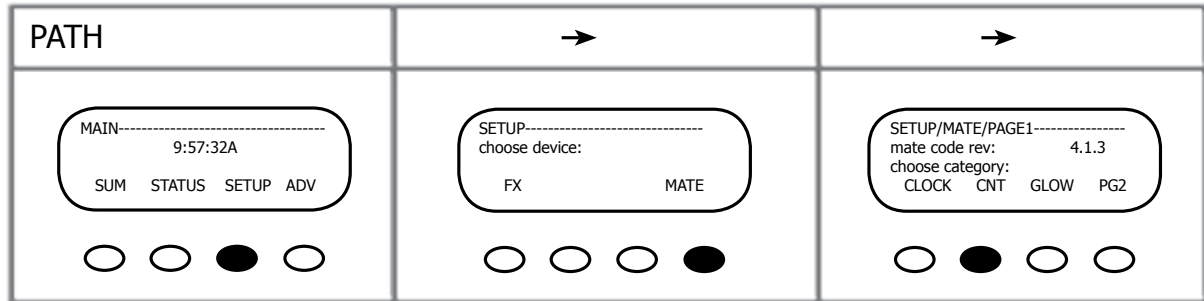

Press the **<CNT>** (**CONTRAST**) soft key from the **SETUP/MATE/PAGE** Setup choices screen. **<CNT>** sets the desired contrast level.

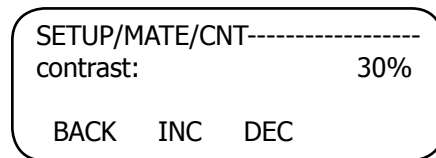
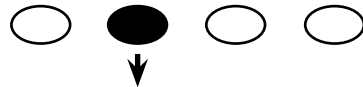

**<INC>** increases the contrast level and **<DEC>** decreases the contrast level. After adjusting the contrast, press the **<BACK>** soft key to return to the previous **SETUP/MATE/PAGE 1** screen.





## Backlight Adjustment

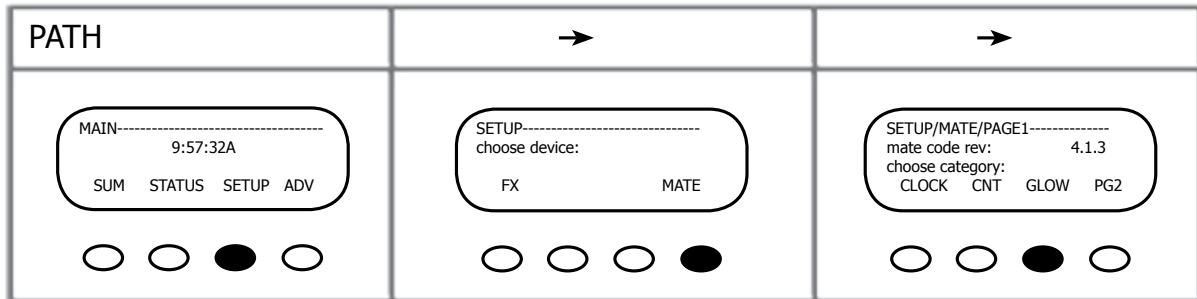

Choose **<GLOW>** from the SETUP/MATE/PAGE 1 Setup choices screen:

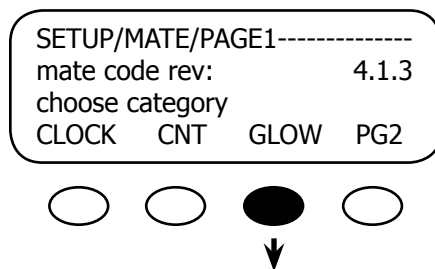

On the SETUP/MATE/GLOW screen, pressing the **<GLOW>** soft key brings up three backlight settings:

- LEVEL
- MODE
- TIME

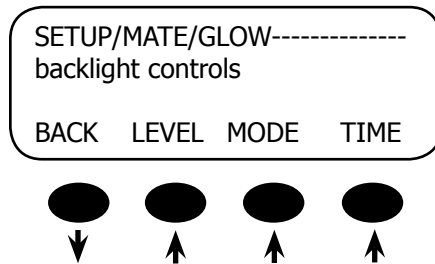

**<LEVEL>** controls the backlight brightness and is adjustable from 0% to 100% using **<INC>** and **<DEC>** soft keys.

**<MODE>** allows user to set the backlight to always off, auto-off after a time, or always on by selecting **<OFF>**, **<AUTO>**, or **<ON>**, respectively.

**<TIME>** sets the auto-off time limit from 1 to 60 minutes using **<INC>** and **<DEC>** soft keys. This is how long the MATE waits after the last button press to turn off the backlight. Once the backlight has turned off, any button press on the MATE will turn it back on.

**<BACK>** returns to the previous screen(s) and back to the SETUP/MATE/PAGE 1 screen.

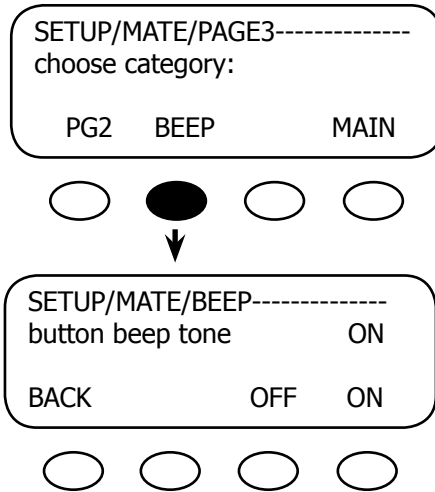

The <**BEEP**> soft key leads to a screen controlling the MATE's beep tone, which is made whenever a key is pressed.

The beep tone refers to a sound made every time a MATE soft or hot key is pushed. Press the <**ON**> or <**OFF**> key for this function.

# 3 MATE Summary Screens

## Summary Screen Overview

The Summary screens provided by the MATE:

- Summarize the current status of any FX, OutBack Charge Controller and/or FLEXnet DC connected to it.
- Can be accessed from the <MAIN> screen by pressing the <SUM> soft key and can be set to pop up like a screen saver after a delay (See Summary Screen Options on the next page for more setup information).

Any MATE soft key pressed while the Summary screen is being displayed returns you to the screen that was active before the Summary screen was displayed. Pressing the two lower left soft keys at the same time opens the MAIN Menu screen.

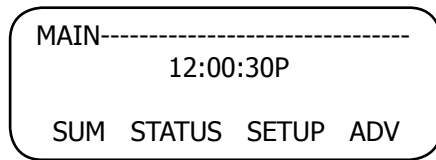

If the MATE has a FLEXnet DC connected to it, an initial FLEXnet DC screen will be displayed as the Summary default screen.

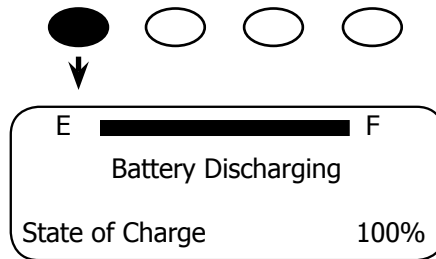

Pressing the second soft key brings up the next three FLEXnet DC summary screens as well as the FX and Charge Controller summary screens.

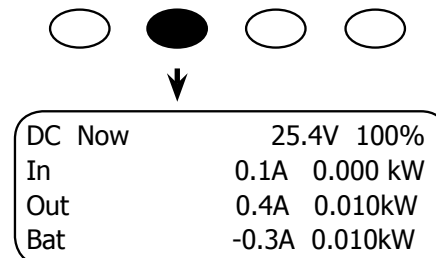

The FLEXnet DC summary screens display the battery state of charge, including the day's minimum, the current DC voltage, and the in and out kilowatt hours and amp hours. All the FLEXnet DC summary screens are explained in the *FLEXnet DC User's Guide* which comes with that component.

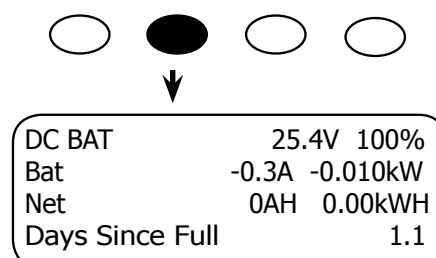
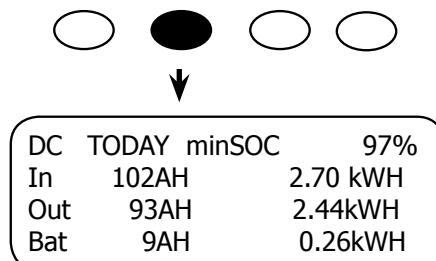

## FX Summary Screen

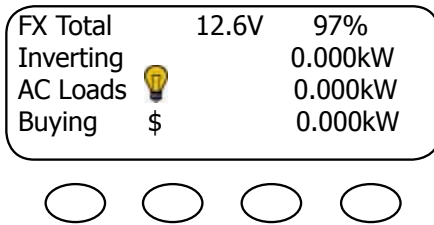

If the MATE has one or more FXs connected to it and does not have a FLEXnet DC as part of the system, an FX Summary screen will be displayed as the Summary default screen. Otherwise, it will follow the FLEXnet DC summary screens.

The FX summary screen's values summarize power flow in an FX system as well as the non-temperature compensated battery voltage.

## OutBack Charge Controller Summary Screen

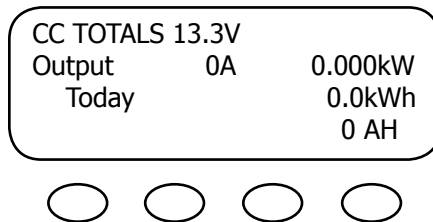

The CC summary applies to all OutBack Charge Controllers. Its screen shows the voltage level of the battery (also non-temperature-compensated) and the amount of power being supplied to the battery. This screen is the default Summary screen if the Charge Controller is directly connected to the HUB. The AH value applies only to the FLEXmax 80 and FLEXmax 60 Charge Controllers.

## Summary Screen Options

*Why you might want them:* Summary screens show the current status of one or more FXs or Charge Controllers. Given that each user and system is different, the MATE offers the choice of viewing the status of either component as well as the timing of those displays.

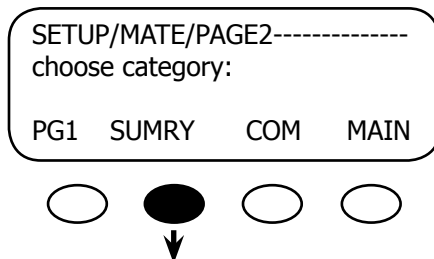
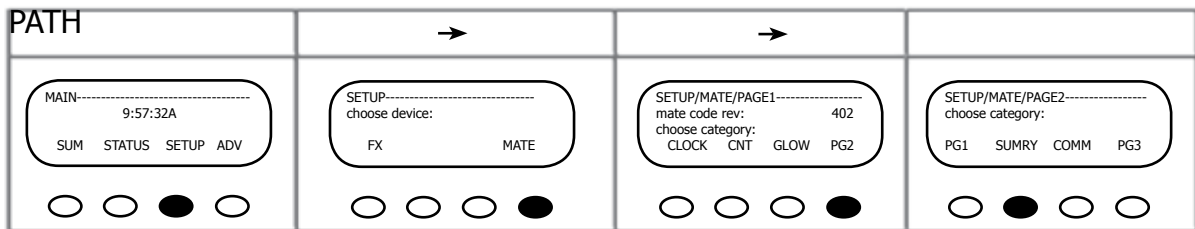

Press the <SUMRY> soft key from the <SETUP MATE/PAGE2> Setup choices screen.

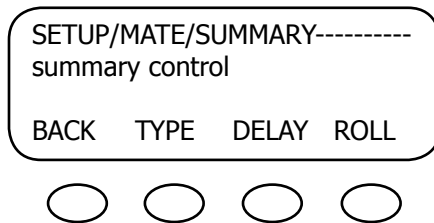

Pressing the <SUMRY> soft key brings up the SETUP/MATE/SUMMARY (summary control) screen options <TYPE> and <TIME>.

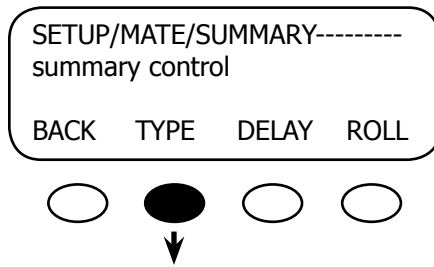

To choose the SUMMARY screen you want to view automatically and also view via the MAIN menu, press the <TYPE> soft key on the SETUP/MATE/SUMMARY screen.

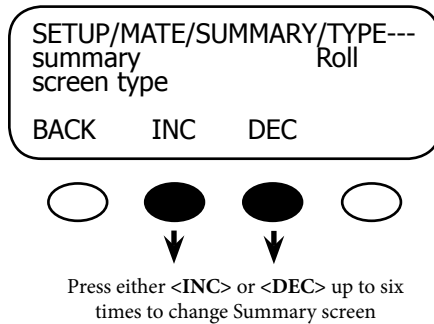

Press either the <INC> and <DEC> soft keys to change the summary screen

**Roll**—switches among the FX, CC (Charge Controller), DC Only, and DC Simple *summary* screens automatically if an FX, Charge Controller, and FLEXnet DC are connected to the MATE through an OutBack Power Systems HUB.

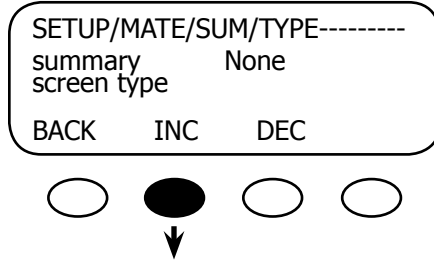

**None**—disables the SUMMARY screen from automatically opening; the SUMMARY screen can still be accessed via the <SUM> soft key on the MAIN screen.

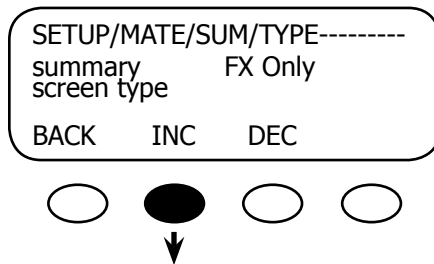

**FX Only**—displays the FX SUMMARY screen.

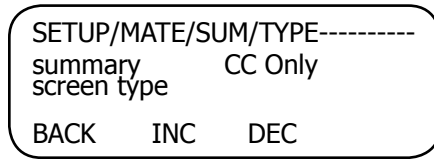

**CC Only**—displays the CC SUMMARY screen. Pressing the <INC> opens the *DC Only summary* screen.

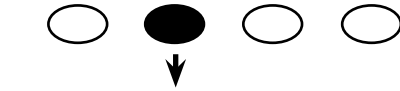

**DC Only**—displays the DC SUMMARY screen. Pressing the <INC> soft key opens the *DC Only Simple* screen.

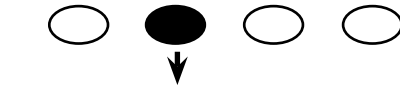

From the DC OnlySimple screen, press the <BACK> soft key to return to the *summary control* screen.

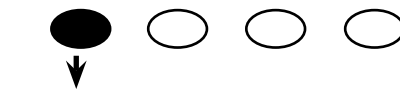
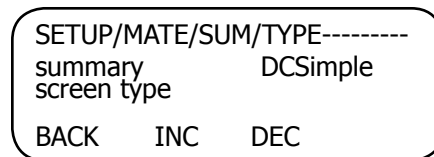

**Having chosen a Summary type—None, Roll, FX Only, CC Only, DC Only or DCSimple:**

1. After exiting that screen, the SUMMARY screen will automatically appear whenever the MATE has been inactive for the <TIME> set point (very much like a screensaver on a computer monitor).
2. The chosen SUMMARY type will also be the SUMMARY manually called up by pushing the <SUM> soft key on the MAIN menu.
3. If the MATE is connected to a HUB with a Charge Controller, an FX, and a FLEXnet DC, it will switch among the CC, FX, DC SUMMARY, and DCSimple screens every 20 seconds when in “Roll” mode.
4. If you choose “None,” the MATE continues to display the last active screen viewed; if you press the <SUM> soft key on the MAIN menu when “None” is chosen, the FX SUMMARY screen appears.

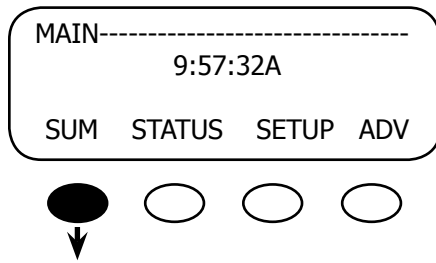

Pressing the <SUM> soft key in the MAIN menu brings up your chosen SUMMARY screen or, if None is chosen, it will bring up the FX SUMMARY screen as a default. To adjust the timing of the SUMMARY screen display, see the next section.

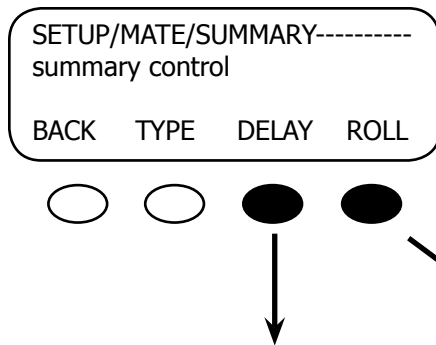
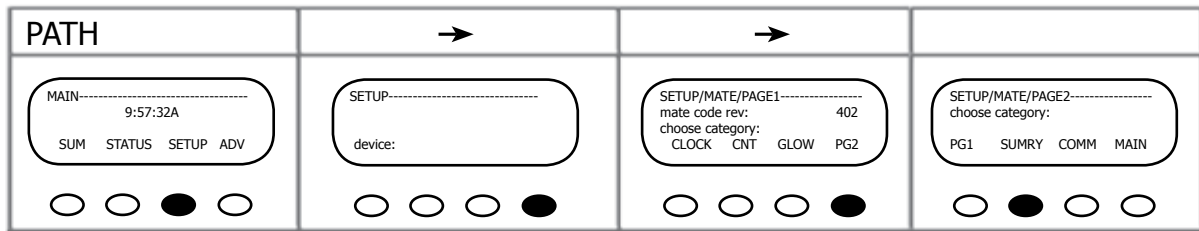

In the SETUP/MATE/SUMMARY screen, press the <DELAY> soft key; this will take you to the *sum screen delay time* screen. Pressing the <ROLL> soft key leads to the *sum screen roll rate* screen.

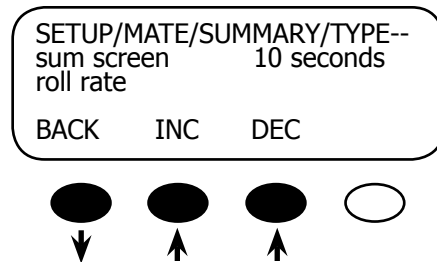
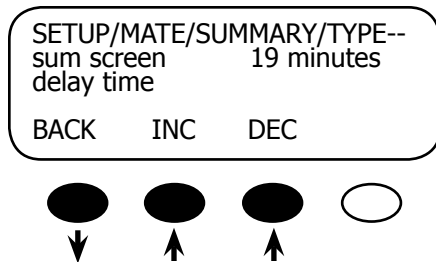

<DELAY> in SUMMARY mode shows how long it takes for a SUMMARY screen to be automatically displayed. This time can be increased or decreased by pressing the <INC> and <DEC> soft keys. After the SUMMARY screen delay time is chosen, press the <BACK> soft key to return you to the SETUP/MATE-SUMMARY screen.

The roll rate is how often the MATE switches between the FX and CC summary screens. The rate can be adjusted with the <INC> and <DEC> soft keys. Pressing the <BACK> soft key returns to the SETUP/MATE-SUMMARY screen.



# 4 MATE Communications Options

## Communications Options

*Why you want them:* The MATE communicates commands to different components. It needs to be aware of any newly added or moved devices so it can recognize them. An error reading doesn't mean the system is failing, but that the MATE is looking for a component that has been moved from one HUB Port to another or has been disconnected completely. The MATE is trying to account for the system components.

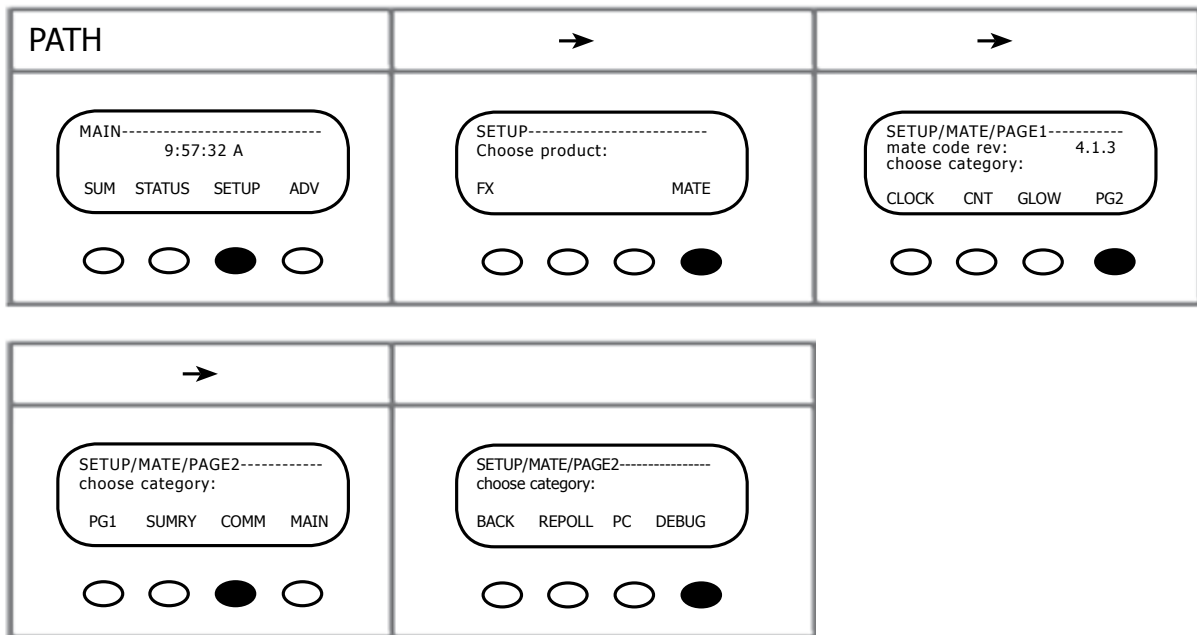

Press the <COMM> soft key from the <PAGE 2> Setup choices screen for MATE communications options:

- <RE POLL> forces the MATE to “rediscover” all the OutBack devices it is connected to. This must be used any time an OutBack device is moved or added to a HUB.
- <PC> will allow you to enable or disable the MATE’s RS232 communications port. This setting must be enabled if you use any third party logging or control software.
- <DEBUG> tracks communication errors involving the OutBack HUB.

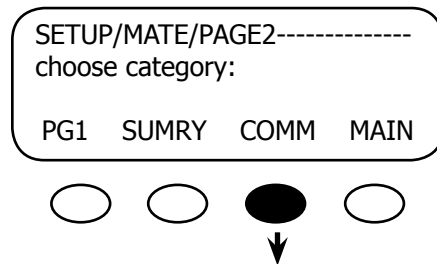

From the SETUP/MATE/PAGE2 screen, press the <COMM> soft key.

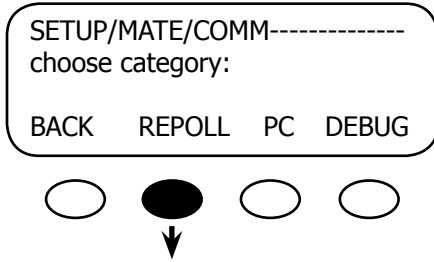

Press the <REPOLL> soft key after a device is added to, moved, or removed from the HUB.

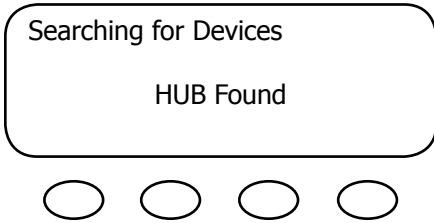

The MATE has found the HUB and will automatically go to the Port Assignment screen.

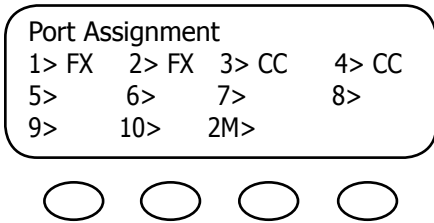

After displaying the devices connected to each Port, the MATE returns to the *choose category* screen on its own.



NOTE: Disconnecting the MATE's CAT5 cable and then reconnecting it also performs the re-poll task, but the cable can be inconvenient to remove from a mounted MATE.

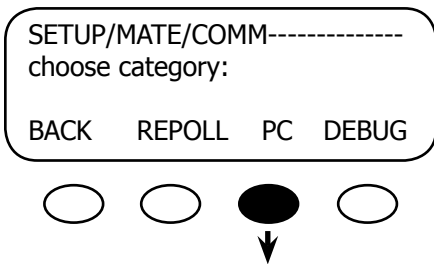

The next communication function deals with the MATE/personal computer interface. Press the <PC> soft key to enable or disable the MATE's RS232 communications port.

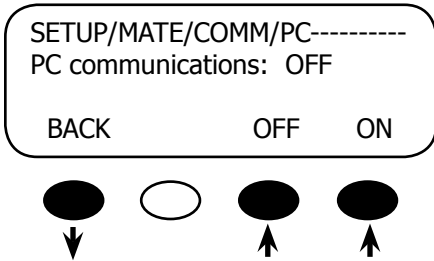

In the PC communications screen, choose ON or OFF by pressing the respective soft key. Press the <BACK> soft key to return to the *choose category* screen.

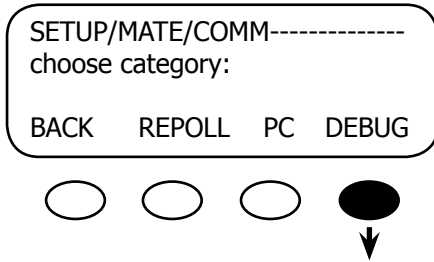

To debug the system, press the <DEBUG> soft key.

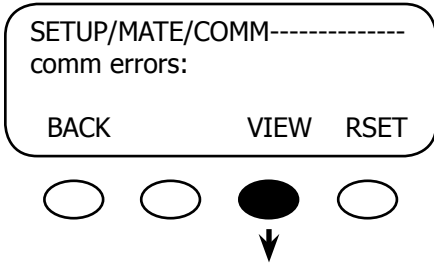

On the DEBUG screen, first press the <VIEW> soft key to bring up a list of HUB ports with a count of communications errors for each port; <RESET> allows you to reset the error counting display (see next screen).

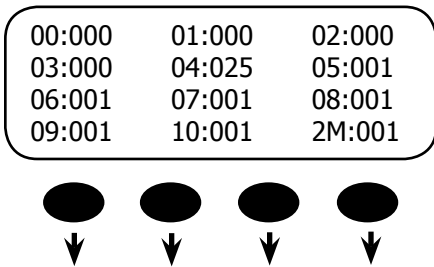

This is a typical VIEW screen showing the HUB Ports and any communication errors in the system. The numbered port with more than one error will need correcting. After the errors are corrected, all the used ports will return to 000 or 001 values after pushing the <RESET> soft key. Press any soft key to return to the SETUP/MATE/COMM screen. To correct errors, please see “Errors and Debugging” in the section that follows. If no errors are present, pressing any soft key returns to the previous SETUP/MATE/COMM screen.

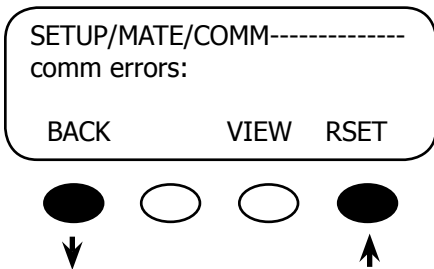

Press the <RSET> soft key to clear the error-counting display. Press the <BACK> soft key to return to the “choose category” screen. Press <VIEW> to return to the previous screen.

## Communication Errors

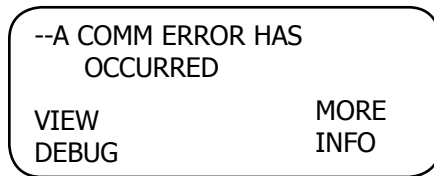

The A COMM (communication) ERROR HAS OCCURRED screen appears when a communication error among the components occurs.

## Errors and Debugging

Communication errors (COMM ERR) that occur with OutBack Power Systems components are often the result of loose, damaged, or unplugged cables. They can also occur if AGS (Advanced Generator Start) Mode is used and the wrong port is designated for the generator or if the system is damaged by a lightning strike. When a communication error occurs, the COMM ERR message will appear on any MATE screen in view.

A sample DEBUG screen looks like this:

```
00:000  01:000  02:000
03:000  04:025  05:001
06:001  07:001  08:001
09:001  10:001  2M:001
```



**NOTE:**

- Port 00 is a MATE connected directly to an FX, no HUB is used.
- Port 2M is the “2nd MATE” Port and is inoperable.

**Explanation of Ports**

01:000 ← Port Status

↑

Port Number

- Port 00 is the MATE Port
- Port 2M is inoperable.
- 01—10: FX or CC Ports
- 000: a device is present.
- 001: no device present.
- Any other status number means a device was previously present and lost contact, resulting in errors.

Here’s how to read the DEBUG screen:

01:000 → Number of errors (zero in this case) present at this port.  
 ↓  
 Port 01

*An unused port will show one error:*

09:001    Port 09 has no component; the single error is the system default.

*A port with a large number of errors requires action. In this example, Port 4 needs attention.*

04:025    Port 04 shows 25 errors.

Advancing errors (the count is increasing on the DEBUG screen) mean the HUB is not finding a device that was previously there. In order, try the following:

1. Check that the device's DC breaker is on and operating correctly, that the device itself is on, and that the CAT5 cable connecting the device to the HUB is plugged in at both ends. Then re-poll the system (SETUP → MATE → PG2 → COMM → REPOLL, see page 34)
2. Check the DEBUG screen to confirm the problem is solved.
3. Swap HUB ports with another device, each using its own CAT5 cable. Re-poll the system and check for errors on each port. If the error moved, the problem is with the device or the cable between the Port and the device. If the error remains on the same Port, then the problem is with the HUB.
4. Try connecting the MATE directly to the device. If the MATE recognizes the device, the problem could lie with the cable connecting the device to the HUB or with the HUB port itself. An unrecognized device could itself be damaged.

# 5 MATE Status Screens

## STATUS Screen Overview

*Why you want them:* Status screens give the user a breakdown of individual activities of the FX Series Inverter/Charger(s) and the Charge Controller(s), including AC and DC voltage and AC and FLEX net DC current meters. It is these individual readings that combine to produce the Summary screens noted earlier and allow monitoring of the system operation.

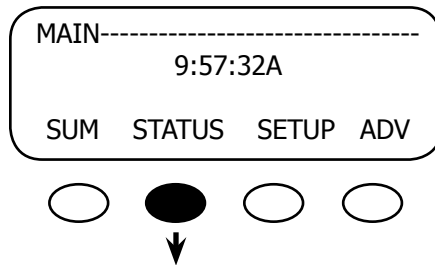

Press <STATUS> on the Main menu to access the STATUS menu. STATUS contains all the meters and mode displays for OutBack products connected to the MATE.

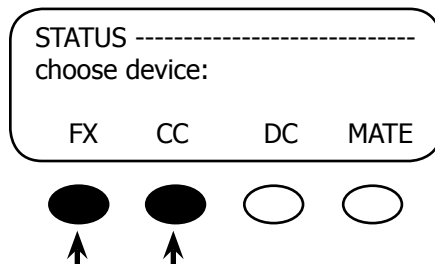

The STATUS menu is divided first by product and then into menu categories, such as meter, modes, and statuses.



NOTE: Not all STATUS screens are applicable to all FX models. The screens differ by product type and revision. See the Menu Map at the end of the manual for locations of all of the status screens available. Consult your specific OutBack product owner manual for an explanation of all the operating modes and meters.

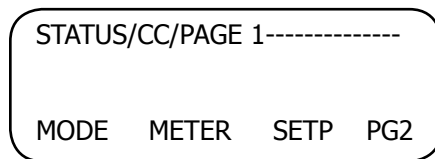

Typical CC Status Screen

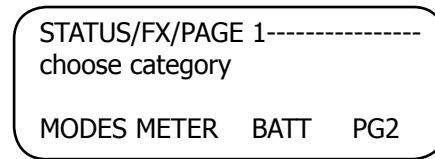

Typical FX Status Screen



NOTE: Other than offering manual on/off control of its AUX relay, the MATE has no control over the workings of the CC Charge Controller except when the system is undergoing a global EQ charger mode. At this time, the system uses both the FX and the Charge Controller(s) to charge the batteries.



## Reading a STATUS Screen

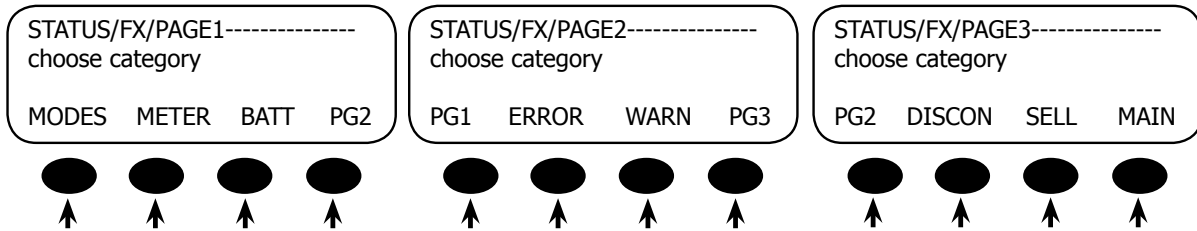

- **MODE**: a functioning condition or state of operation
- **METER**: displays inverter and charger activity, including output and input AC voltage, and AC inverter, charger, and input current
- **BATT**: displays the battery temperature, voltage and the various set points for the different recharging cycles as well as the time remaining to complete any of those cycles
- **PG2**: pressing the <PG2> soft key opens the next selection of STATUS screens
- **ERROR**: various FX errors and their causes; an error can shut the FX down
- **WARN(ING)**: FX warning situations; warnings will not shut the FX down
- **PG3**: Pressing the <PG3> soft key opens the last STATUS screen
- **DISCON**: lists the reasons the FX disconnects from an AC source
- **SELL**: displays a number representing the reason the FX stops selling power to the grid; this number is used by technicians for troubleshooting grid-tied FX units

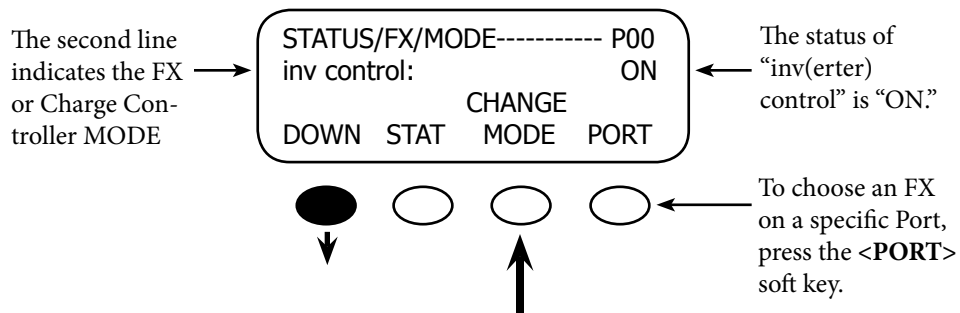

Pressing the <CHANGE MODE> soft key changes the operation of the mode shown on the screen; it does not change to another mode altogether. To change modes, press the <DOWN> soft key.

## FX STATUS MODE Screens

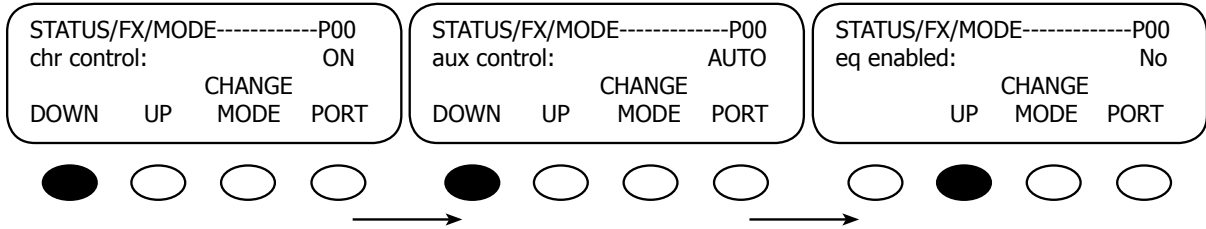
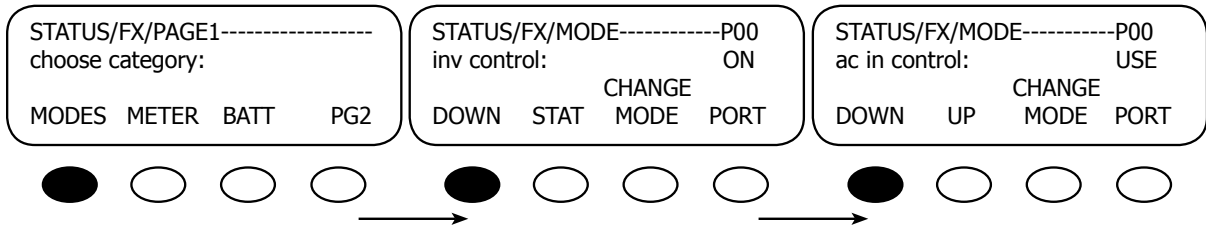

Push <UP> until the *inv control* screen appears.

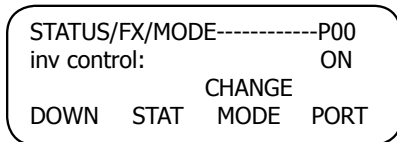

Push <STAT> to return to the choose category STATUS page.

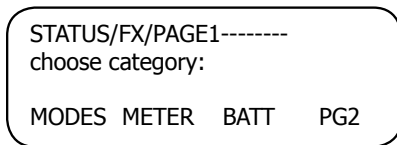

Pressing the <METER> soft key brings up the first METER screen.

### MODE Screens

- Pressing the <CHANGE MODE> soft key on any MODE screen allows the user to change the operation of that individual mode, i.e., activate the function, shut it off, etc. After changing the operation (or leaving it alone), the user presses the <OK> soft key to return to the MODE screen whose operation was changed. Press the <DOWN> soft key to view the next mode.
- *inv control*: shows the status of the inverter function\*
- *AC in control*: the FX accepts or drops an AC source\*
- *chr control*: shows charger activity\*
- *aux control*: controls 12 VDC and 0.7 ADC loads which can be used to run a fan, activate an alarm, signal a generator start and other low-power functions\*
- *eq enabled*: shows status of the equalize recharging cycle and allows user to start or stop the cycle\*

\* These modes can be controlled and adjusted in greater detail in the INVERTER, CHARGER, and AUXILIARY menus and through the AC IN hot key respectively.

## FX STATUS METER Screens

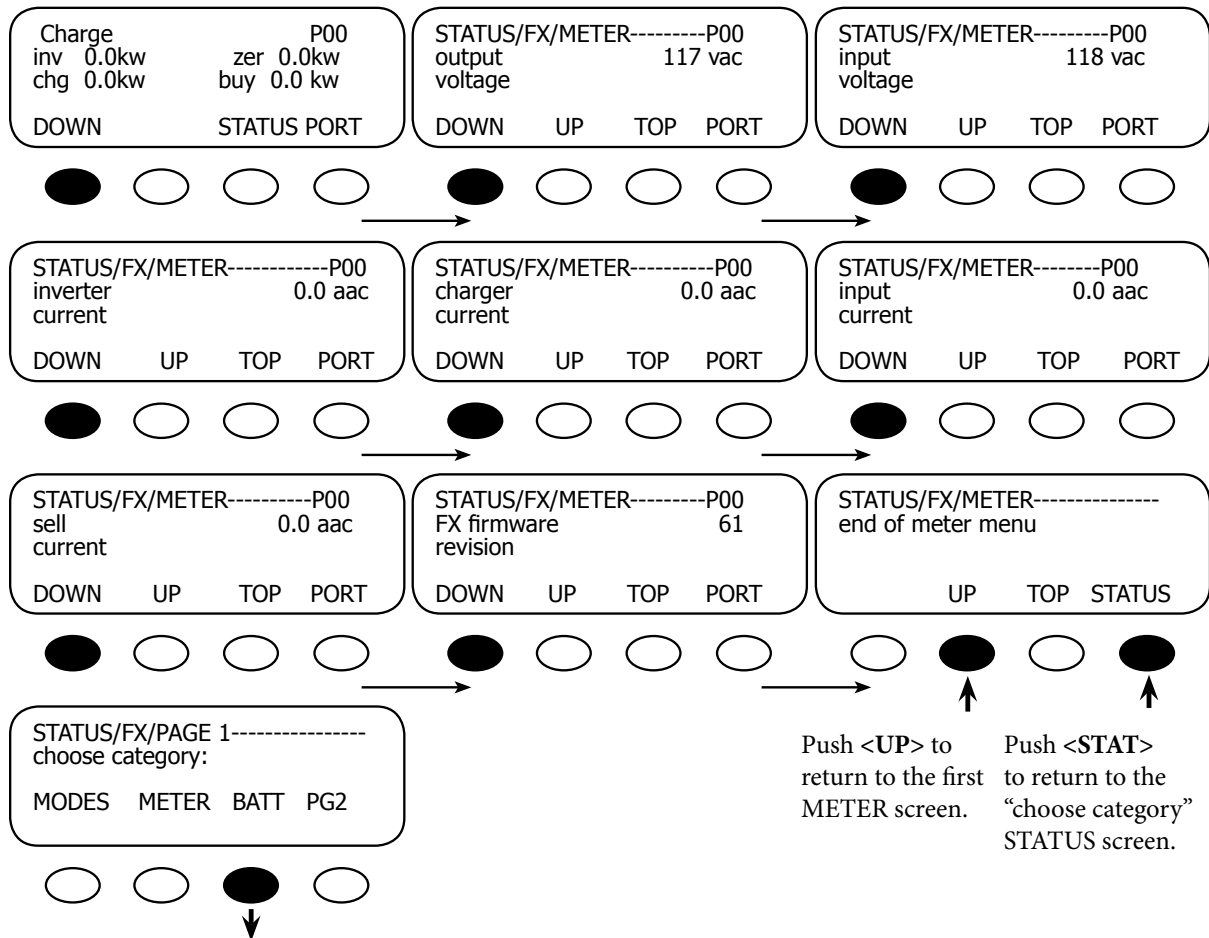

Pressing the <BATT> soft key brings up the first FX BATT screen.

**The first METER screen shows what the inverter is doing at the time this screen is viewed. A grid-tied FX will also show any target activity. The lists below show the possible activities and target activities. An off-grid FX will only show the current activity.**

Activity	Target Activity
Off	Sell
Search	RE
On	Float
Charge	Bulk EQ
Silent	
Float	
EQ	
Chr Off	
Support	
Sell	
Passthru	

### METER Screens

The METER screens display current and voltage measurements and the version of FX software.

- **charge:** the current FX mode
- **output voltage:** available AC at the FX AC output
- **input voltage:** available AC at the FX AC input, normally from a utility or a generator
- **inverter current:** available current at FX AC output terminals when the inverter is ON and no AC source is connected
- **charger current:** shows the amount of AC current used by the FX charger
- **input current:** AC current flowing into the FX AC input
- **sell current:** AC current being sold to the grid
- **FX firmware:** current FX software version

The METER MODE values cannot be changed in the STATUS screens.

## FX STATUS Batt(ery) Screens

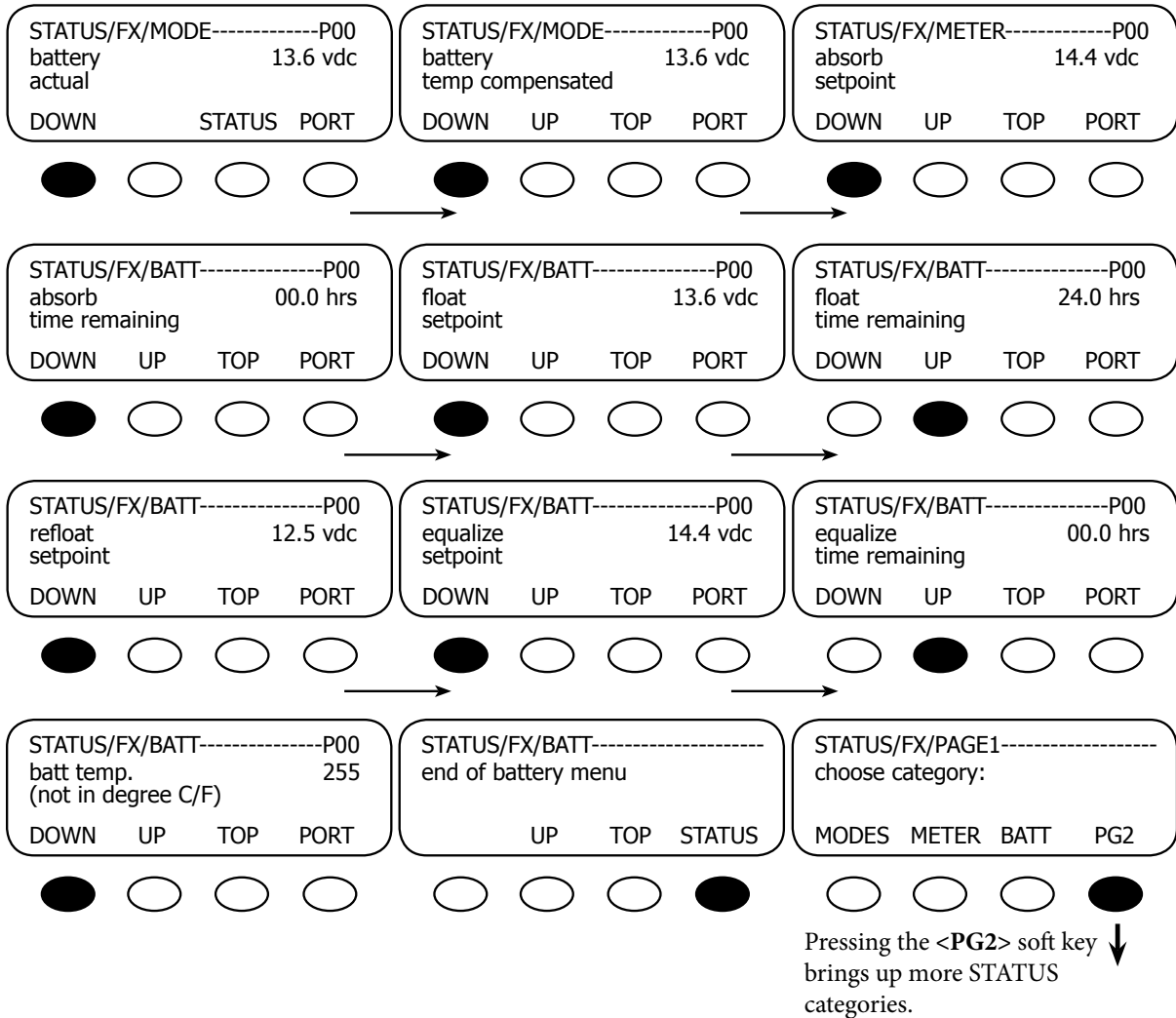

### BATT(ERY) Screens

- **battery actual:** battery voltage as measured by the FX
- **battery temp compensated:** the Remote Temperature Sensor (RTS) must be connected to this value to be measured
- **absorb set point:** charger set point for absorb recharging cycle
- **absorb time remaining:** time remaining in absorb recharging cycle
- **float set point:** battery set point for float recharging cycle
- **refloat set point:** at this battery voltage, the charger restarts the float recharging cycle
- **equalize set point:** charger set point for equalize recharging cycle
- **equalize time remaining:** time remaining in equalize recharging cycle
- **batt temp:** this value, which reflects the battery temperature, is used by the charger when an RTS is connected to the FX

The BATT MODE values cannot be changed in the STATUS screens.

## FX STATUS ERROR Screens

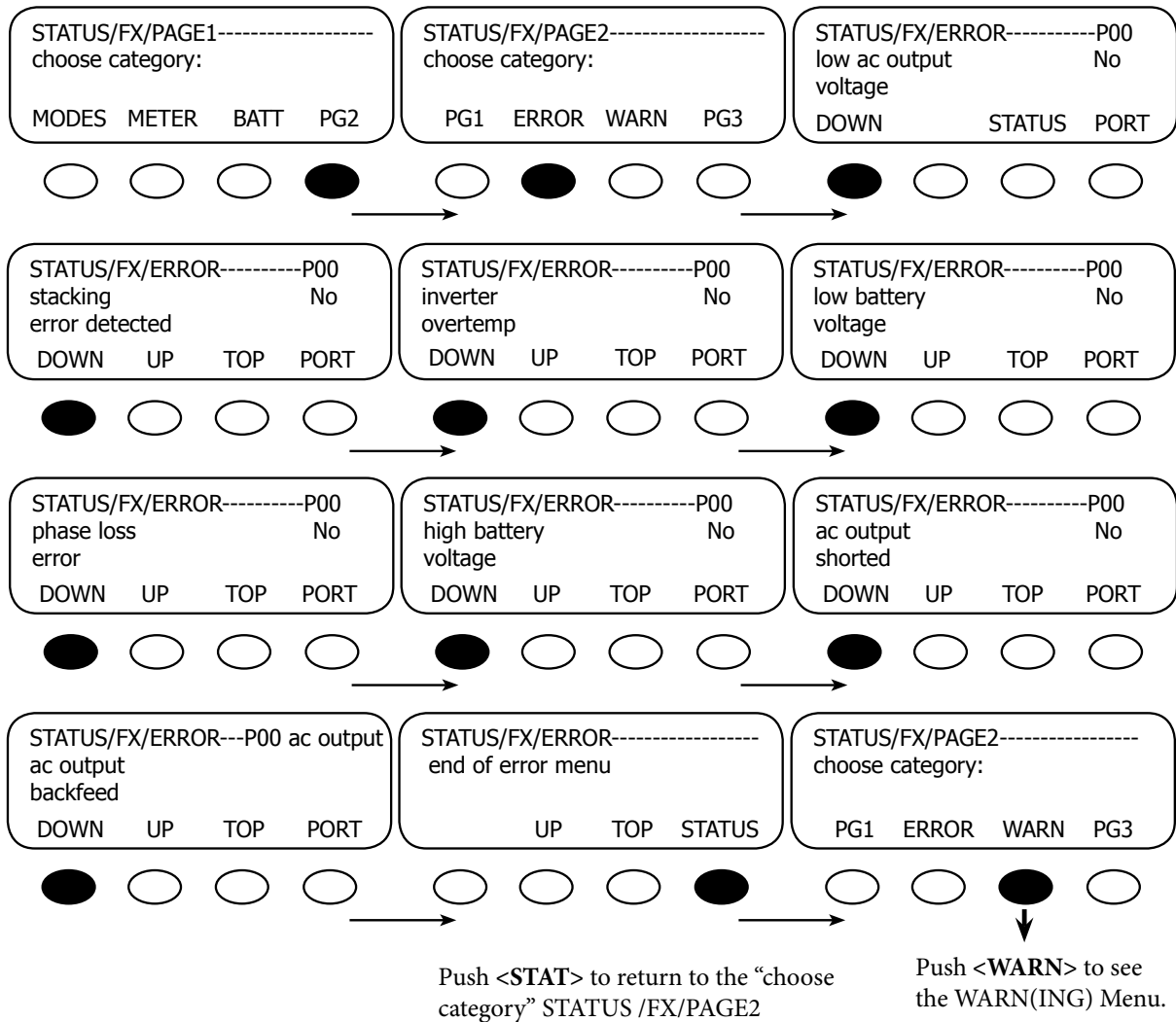

### ERROR Screens

- **low ac output voltage:** inverter could not supply enough AC voltage to meet demand
- **stacking error detected:** communication problem among stacked FXs
- **inverter overtemp:** FX has reached its maximum allowed operating temperature
- **low battery voltage:** battery voltage is below the LOW BATTERY CUT-OUT VOLTAGE set point (this is a common error and will light up even with low AC out or AC shorted)
- **phase loss error:** not operational
- **high battery voltage:** battery voltage rose above the safe high battery voltage level for 10 seconds
- **ac output shorted:** inverter reached its maximum current and shutdown
- **ac output backfeed:** usually indicates another AC power source was connected to the FX’s AC output

ERROR screens can only display errors; they do not offer any means to correct them. These are hard faults. The LED is solid and the inverter must be turned off and then on to reset.

## FX STATUS WARN(ING) Screens

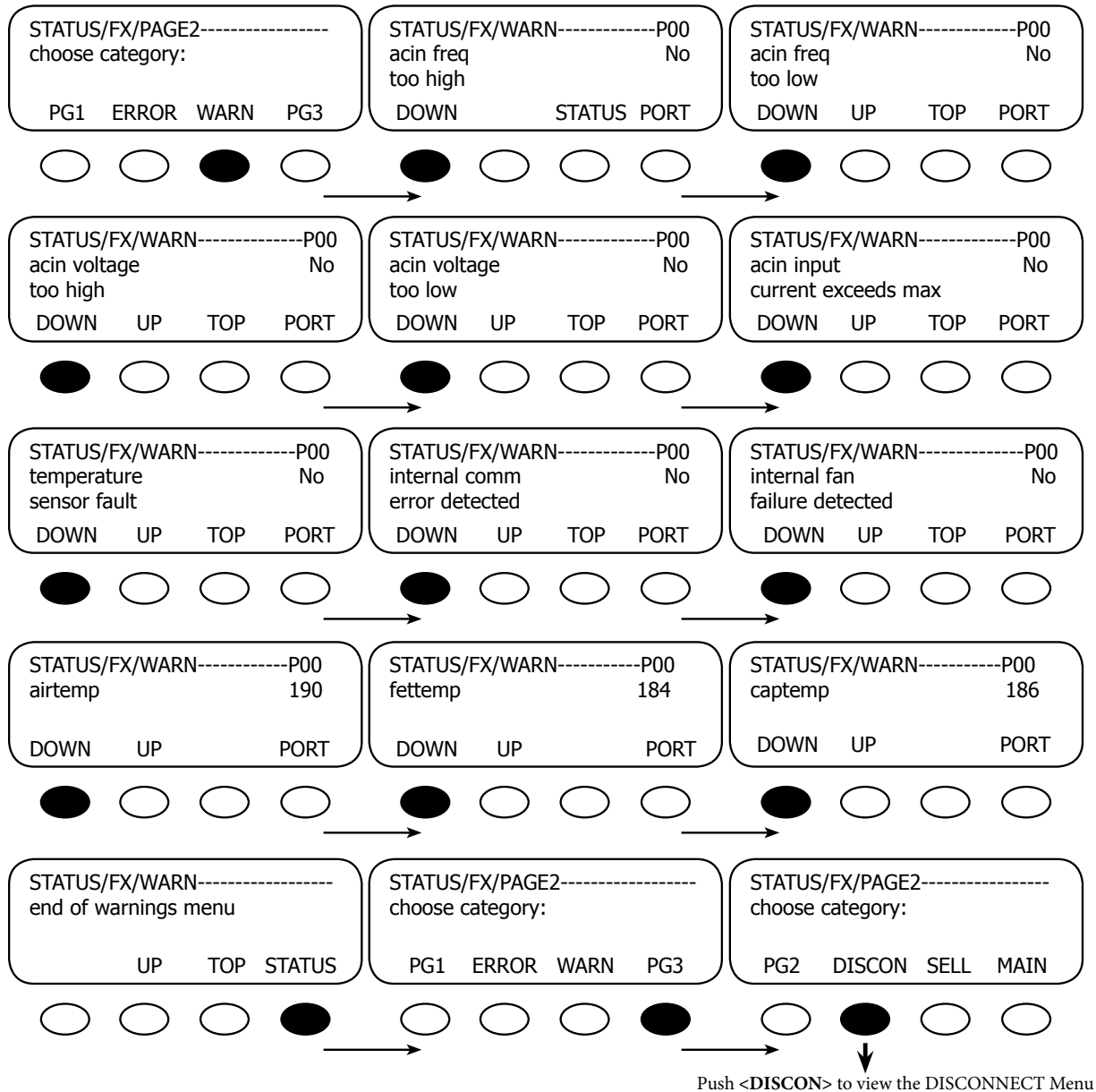

### WARN(ING) Screens

- **acin freq too high:** AC source is above 66 Hz\* (upper limit) and will be dropped if frequency gets much higher
- **acin freq too low:** AC source is under 54 Hz\*\* (lower limit) and will be dropped if frequency gets much lower
- **acin voltage too high:** AC source's voltage is over 140VAC\*\*\* (default limit) and risks loss of FX connection
- **acin voltage too low:** AC source's voltage is under 108VAC\*\*\*\* (default limit) and risks loss of FX connection
- **acin input current exceeds max:** AC loads are drawing more current than the rating of the FX allows
- **temperature sensor fault:** an internal FX temperature sensor is malfunctioning
- **internal comm error detected:** there is a communication problem between the MATE and the FX
- **internal fan failure detected:** the FX's internal cooling fan is not operating properly
- **airtemp:** displays a numeric value representing the air temperature around the FX\*
- **fettemp:** displays a numeric value representing the temperature of the FETs (Field Effect Transistors)\*
- **captemp:** displays a numeric value representing the temperature of the ripple capacitors

(These values are used for troubleshooting purposes. The higher the numerical value, the cooler the temperature.)

International FX \*56 Hz \*\*44 Hz \*\*\*270 VAC \*\*\*\*207

## FX DISCON(NECT) Screens

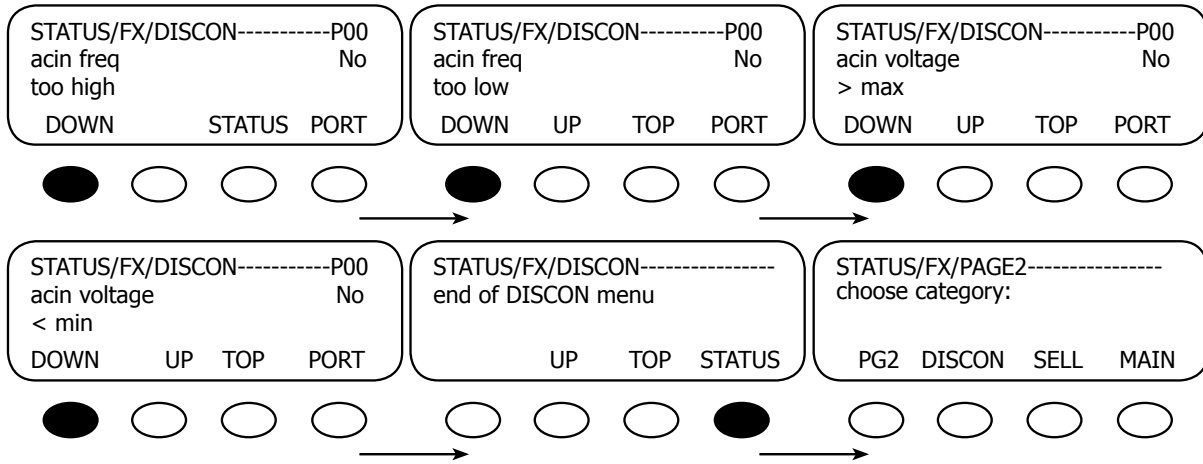

### DISCON(NECT) Screens

- **acin freq too high:** screen displays “Yes” if the AC source exceeds 69 Hz\* and the FX disconnects from the source
  - **acin freq too low:** displays “Yes” if the FX disconnects from an AC source below 51 Hz\*\*
  - **acin voltage > max:** the source of the AC voltage exceeds the FX maximum of 140VAC\*\*\*(default value)
  - **acin voltage < min:** the source of the AC voltage falls below the FX minimum of 108VAC\*\*\*\*(default)
- International FX \*56 Hz \*\*44 Hz \*\*\*270VAC \*\*\*\*207VAC

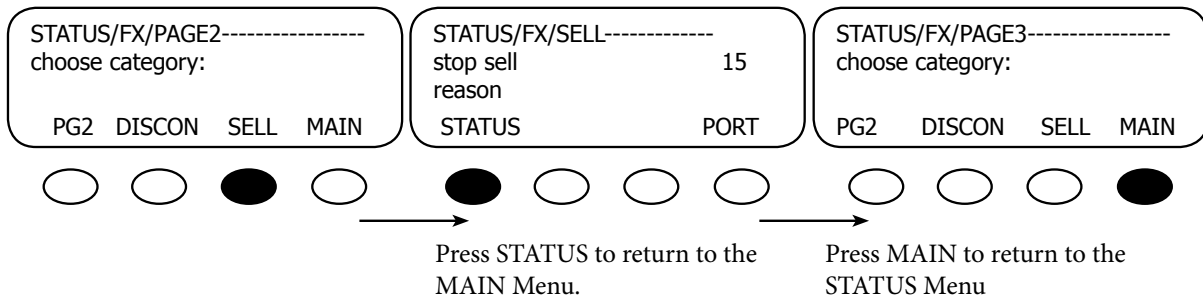

### FX SELL Screen

- **stop sell reason:** displays a numerical value (15 in sample screen shown here) indicating a reason a grid-tied FX has stopped selling power to the utility grid; this screen is used for troubleshooting by OutBack Power System technicians.

### Stop SELL Reasons

- 0
- 1 Frequency shift greater than limits
- 2 Island-detected wobble
- 3 VAC over voltage
- 4 Phase lock error
- 5 Charge diode battery volt fault
- 6
- 7 Silent command
- 8 Save command
- 9 R60 off at go fast
- 10 R60 off at silent relay
- 11 Current limit sell
- 12 Current limit charge
- 13
- 14 Back feed
- 15 Brute sell charge VAC over

## OUTBACK CHARGE CONTROLLER STATUS MODE Screens

To view the CC STATUS screens, return to the MAIN Menu, press the <STATUS> soft key and then choose the CC on the STATUS choose product screen. The STATUS screens include MODE, METER, and SET (SET POINT). In STATUS Mode, these Charge Controller functions can be viewed by the MATE, but not changed.

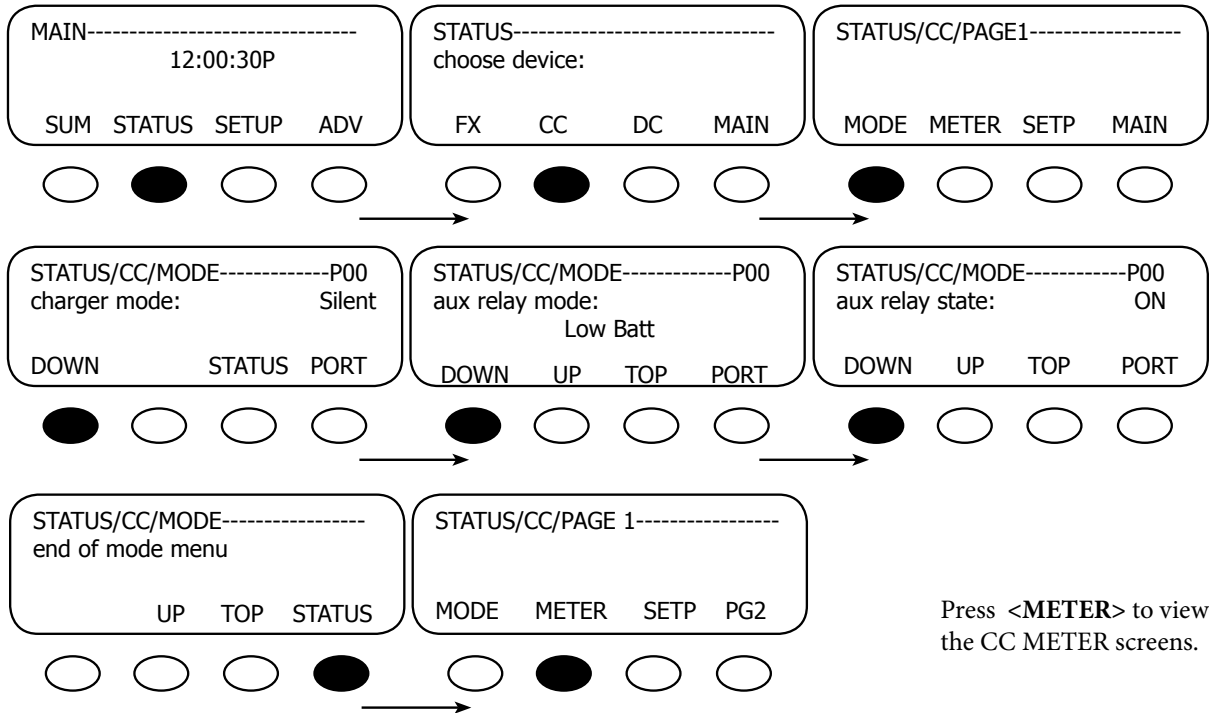

NOTE: All OutBack Charge Controller screens are displayed as CC screens on a MATE with software code revision 4.02 and higher.

### CHARGE CONTROLLER MODE Screens

- **charger mode:** displays one of five charging stages (Bulk, Absorption, Float, Silent, or Equalization)
- **aux relay mode:** displays one of eight Charge Controller AUX modes (Vent Fan, PV Trigger, ERROR OUTPUT, Night Light, Float, Diversion:Relay, Diversion:Solid St, Low Batt(ery) Disconnect, or Remote)
- **aux relay state:** indicates if the AUX is ON or OFF



## OUTBACK CHARGE CONTROLLER STATUS METER Screens

To view the CC STATUS screens, return to the MAIN Menu, press the <STATUS> soft key and then choose the CC on the STATUS *choose product* screen. The STATUS screens include MODE, METER, and SETP (SET POINT). In STATUS Mode, these Charge Controller functions can be viewed by the MATE, but not changed.

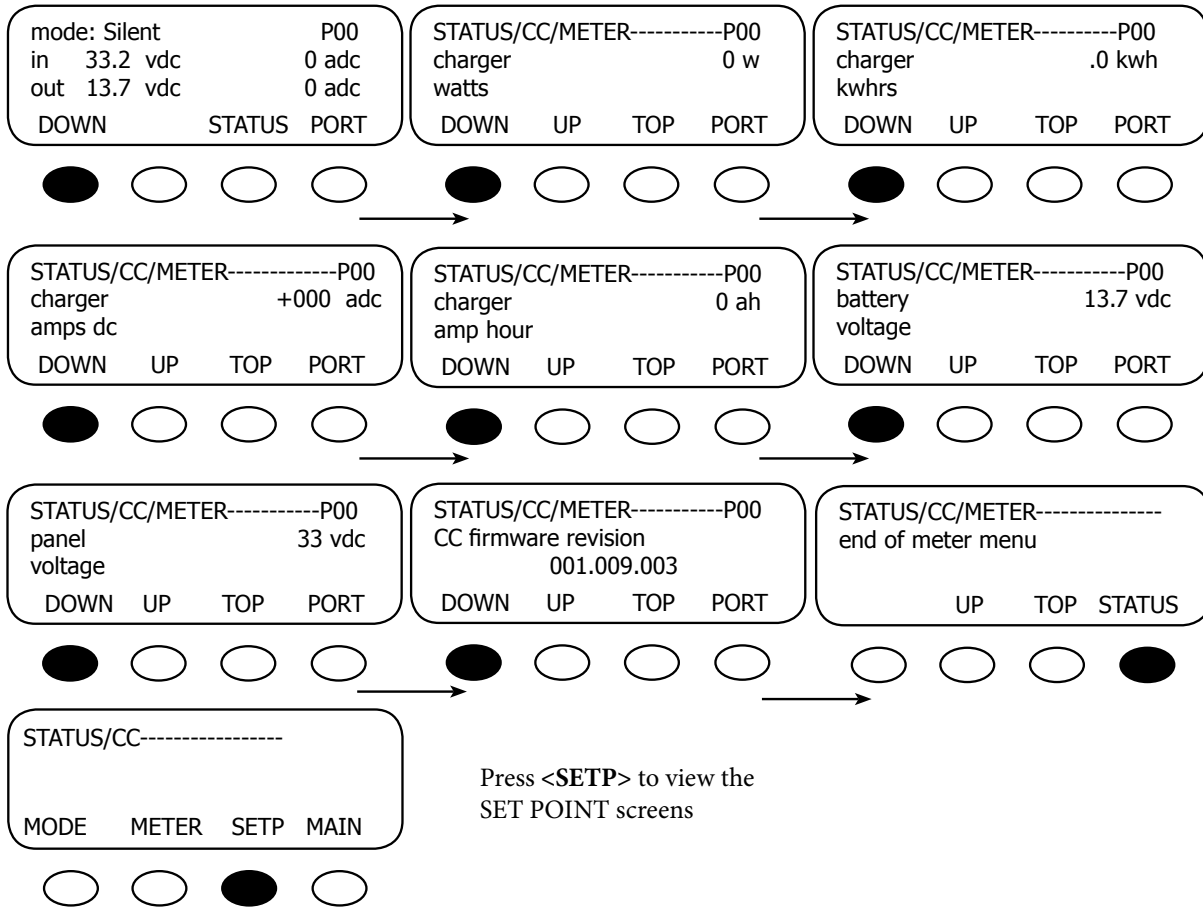

NOTE: All OutBack Charge Controller screens are displayed as CC screens on the MATE.

### CHARGE CONTROLLER METER Screens

- *Mode/pv/in/bat/out*: displays the charger mode, the PV array voltage, the incoming PV amps, the battery voltage, and the outgoing amps to the battery
- *charger watts*: charger output measured in watts
- *charger kWhrs*: kilowatt hours produced today by the Charge Controller
- *charger amps dc*: the amount of amperage the Charge Controller is sending to the battery
- *battery voltage*: current battery voltage
- *panel voltage*: current voltage from the PV array

## OUTBACK CHARGE CONTROLLER STATUS SETP(OINT) Screens

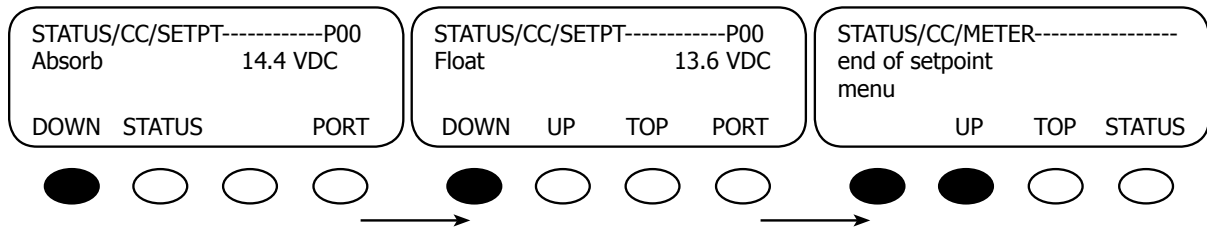

Press the first two soft keys simultaneously to return to the MAIN Menu or press <STATUS> and then press <MAIN> on the STATUS screen.



NOTE: All OutBack Charge Controller screens are displayed as CC screens on the MATE.

### CHARGE CONTROLLER SETP(OINT) Screens

- *Absorb*: displays the voltage that initiates and maintains the Absorb cycle
- *Float*: displays the voltage that begins the Float cycle and is maintained during this cycle

# 6 MATE Hot Keys

## HOT KEYS

### INV Hot Key

The **INV** “hot” key takes you to the **INVERTER CONTROL** screen allowing direct control of the FX’s inverter from anywhere in the menu system.

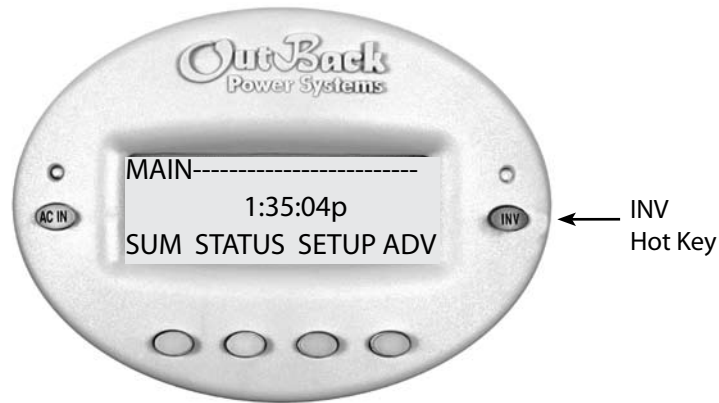

*The green LED indicator above the INV has three modes:*

- **Flashing**—the inverter is either in the search or power save modes
- **Continuously On**—DC battery power is converted to AC power and the FX is supplying loads or selling to the grid
- **Off**—the inverter is not converting DC power to AC power or when the AC input source is powering the loads

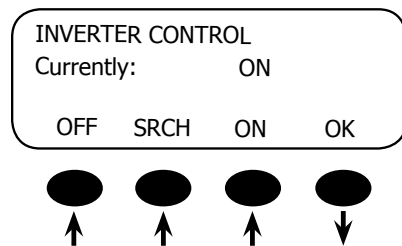

PRESS ONCE: **INV**

**<OFF>** —turns off all the FX inverters connected to the MATE

**<SRCH>** —the inverter begins search mode if the AC load connected is smaller than allowed by the programming of the search function.

**<ON>** —turns on all the FX inverters connected to the MATE.

**<OK>** —returns to the point in the menu system where you entered the **INVERTER CONTROL** screen.

## AC IN Hot Key

The AC IN “hot” key allows direct control of the AC input from anywhere in the menu system.



The yellow LED indicator above the AC IN “hot” key has three settings:

- **Flashing** - an AC source is available, but not connected
- **Continuously On** - the AC source is connected and in use
- **Off** - no AC source is present

The number of AC IN key presses determines which menu is called up.

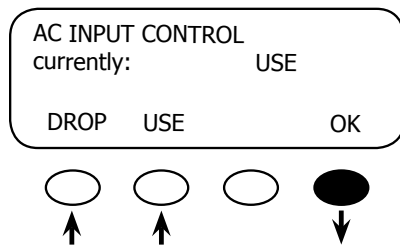

PRESS ONCE: **AC IN**

- The AC INPUT CONTROL screen is called up, allowing the user to connect or disconnect the FX to an AC input source.
- If a HUB is employed, AC INPUT CONTROL only affects the Master FX connected to PORT 1; the Master FX then gives the same command to the Slave FXs

<USE> enables the FX to connect to an AC input source.

<DROP> disconnects the AC input source but will allow it to be reconnected if the “low battery cut-off set point” occurs or the FX is overloaded.

<OK> returns to the point in the menu system before you entered the AC INPUT CONTROL menu cycle.

*If HBX Mode is enabled, the AC INPUT CONTROL will read:*

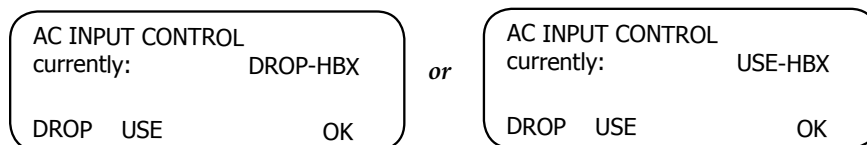

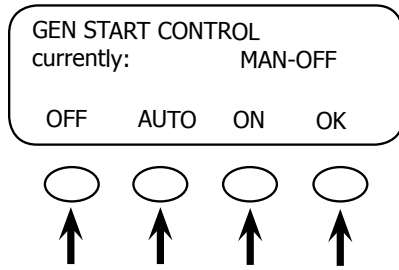

PRESS TWICE: **AC IN** **AC IN**

- The GEN START CONTROL screen allows changes to the *Advanced Generator Start* (AGS) mode.
- The AGS settings only take effect when *Advanced Generator Start* is enabled (See the AGS Mode section for more information).



NOTE: This does not control the *GenAlert* function.

- When an OutBack HUB is employed, the GEN START CONTROL only affects the FX programmed as the AGS PORT in the AGS setup. This is the HUB Port connected to the FX with the generator start relay.

<OFF> manually overrides AGS mode. Pressing <OFF> brings up MAN-OFF indicating the user manually shut off the generator.

<AUTO> allows the MATE to automatically start and stop the generator according to the settings programmed in the ADVANCED AGS menu. Pressing <AUTO> brings up either AUTO-OFF or AUTO-ON depending on the FX programming.

<ON> manually overrides AGS mode. Pressing it brings up MAN-ON indicating the user manually turned the generator ON)

<OK> Returns to the point in the menu system where you entered the GEN START CONTROL screen.



NOTE: To reset an AGS error, press <OFF> and then press <AUTO>.

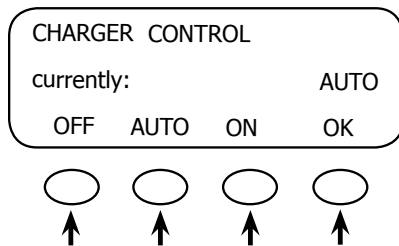

PRESS THREE TIMES: **AC IN** **AC IN** **AC IN**

- The CHARGER CONTROL screen appears.
- This allows the operation of the FX battery charger to be preset for an available AC source.
- When an OutBack HUB is employed, the CHARGER CONTROL only affects the Master FX connected to PORT 1. The Master FX then gives the same command to all slave FXs.



NOTE: The charger's operation is independent of the inverter. With the inverter in OFF mode, the charger can be set to come on when AC is available, but have the inverter stay off when AC is disconnected.

<OFF> disables all charger functions in the FX.

<AUTO> enables automatic battery charging, silent, and "re-float" when an AC input source is connected.

<ON> also recharges the batteries, but eventually remains in the "float" charging stage (and eliminates silent mode) until the AC input is disconnected.

<OK> returns to the point in the menu system where you entered the CHARGER CONTROL screen.

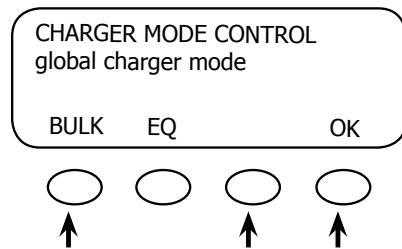

PRESS FOUR TIMES: (AC IN) (AC IN) (AC IN) (AC IN)

- The CHARGER MODE CONTROL screen appears allowing the MATE to issue system (global) recharging commands.



NOTE: Global commands apply to the Charge Controllers and FXs connected to a HUB.

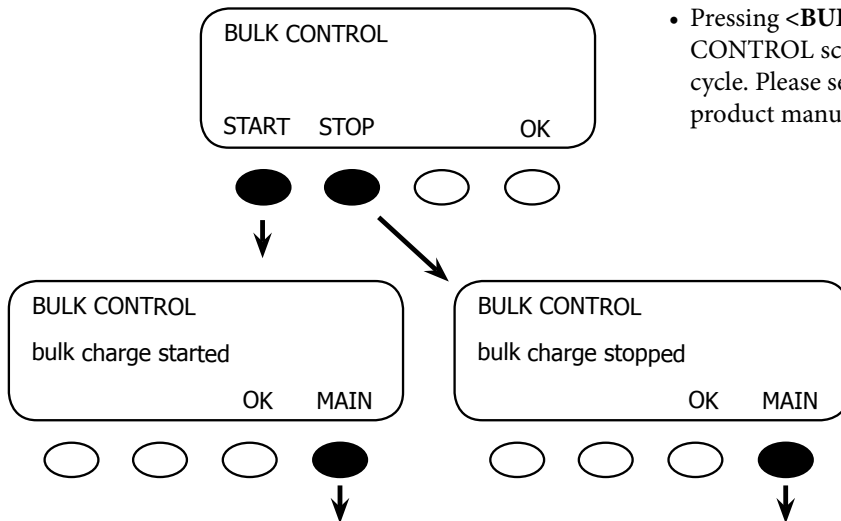

- Pressing <BULK> brings up the BULK CONTROL screen and starts a new recharging cycle. Please see the FX and Charge Controller product manuals for more information.

The BULK CONTROL screen allows the user to manually start or stop a bulk charge cycle by pressing the <START> or <STOP> soft keys respectively.



NOTE: Both Outback Charge Controller and FX products connected to the HUB will respond to global EQ and BULK charger commands.

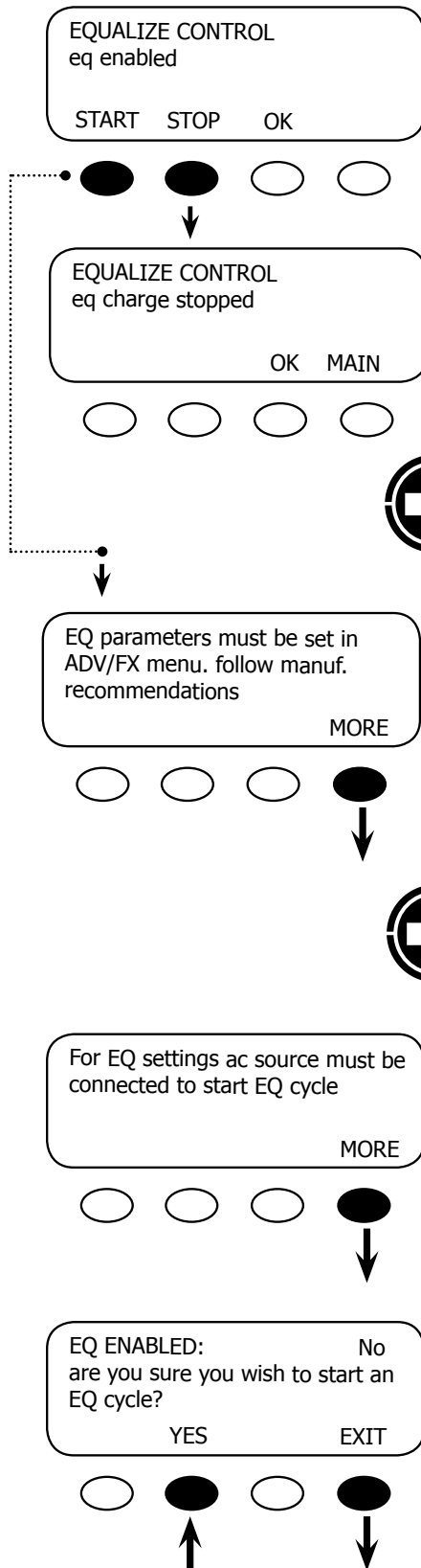

Pressing <EQ> on the CHARGER MODE CONTROL screen brings up the EQUALIZE CONTROL screen

When <STOP> has been selected, the EQ charge has stopped.

When <START> has been selected, two informational screens are displayed. The user must push the <MORE> soft key before an equalizing cycle can begin.

---

NOTE : EQ (EQUALIZE) is not an automatic part of the FX's charge cycle. With the AC input already connected to the FX system, an EQ charge must be manually started from this menu. The EQ cycle ends after the time it takes to charge the batteries to the EQ voltage and the EQ time limit or by manually stopping the EQ charge from this menu.

---



---

NOTE: Start the generator or check that the grid is connected before starting an EQ cycle. The AC IN status LED on the FX must be solid yellow.

---

The EQ ENABLED screen allows an equalize charging cycle or an exit. Press the <YES> soft key to enable and then press <EXIT>.



To stop an equalizing process, return to the EQUALIZE CONTROL screen and press the <STOP> soft key. To return to the EQUALIZE CONTROL screen:

- Press the <AC IN> hot key four times.
- Press the <EQ> soft key.
- Press the <STOP> soft key on the EQUALIZE CONTROL screen.

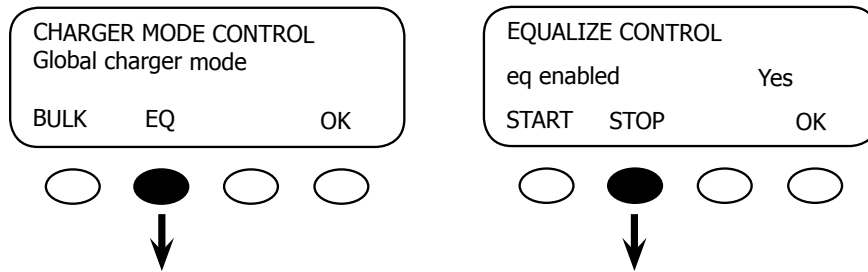
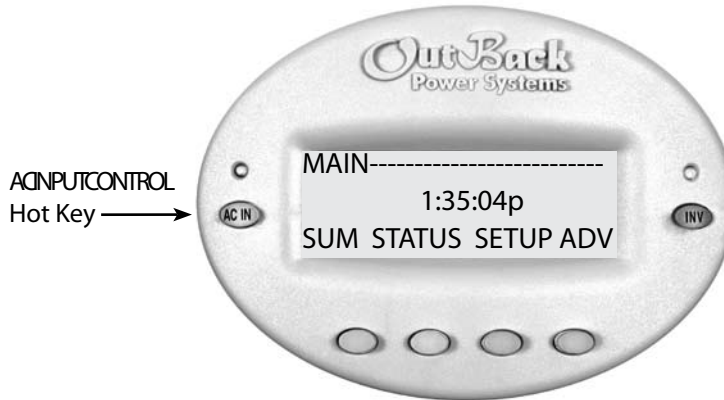

---

NOTE: For a global charger command to work, all of the OutBack products must be connected to a HUB. The CHARGER MODE CONTROL affects both FX Series Inverters/Chargers and OutBack Charge Controllers. This requires that the FX and OutBack Charge Controller firmware versions support this feature (See page 129, *Troubleshooting*, if this command fails to function).

---

# 7 Advanced MATE Menus

## MATE Control Modes

The MATE, when connected to at least one FX Series Inverter/Charger, offers more sophisticated controls than basic debugging and system displays. With the MATE, you can:

- Program when an FX connects to an AC source based on time, battery voltage, or time-of-day grid usage
- Start a generator using Advanced Generator Start (AGS) Mode
- Control auxiliary AC or DC loads such as cooling fans and relays
- Sell power back to the utility grid
- Set up the stacking of multiple FXs, the FLEXmax 80, and the FLEXnet DC

The following chapters detail the MATE Control Modes. Please note whenever a password is called for, the system password is:

The following chapters detail the MATE Control Modes.

Please note whenever a password is called for, the system password is:

**141**

## The ADVANCED Menus

The MATE must be connected to an OutBack system for the Advanced features to function.

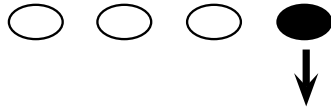
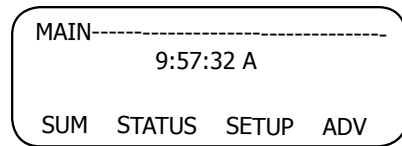

To access the MATE's Advanced Mode settings, go to the MAIN menu and push the <ADV> soft key.

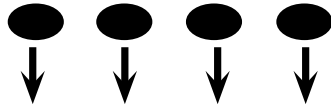
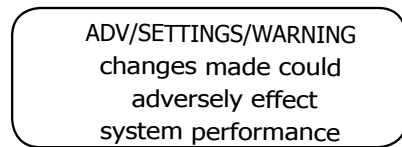

The next screen is a warning screen intended to keep those unfamiliar with an OutBack system from altering the settings. Push any key to advance to the next screen to input the password (141).

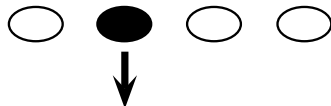
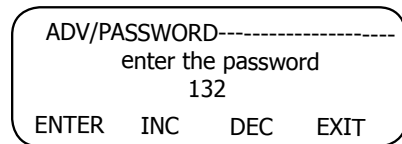

The screen displays 132. Push the <INC> soft key until it scrolls to 141.

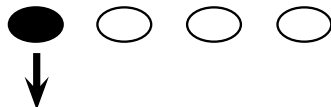
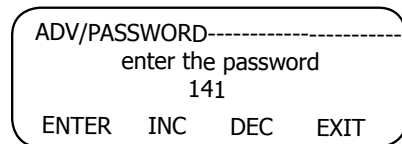

With the password 141 on the screen, push the <ENTER> soft key.

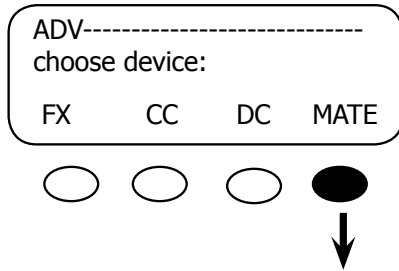

In the ADV menu, push the <MATE> soft key to view the Advanced MATE functions.

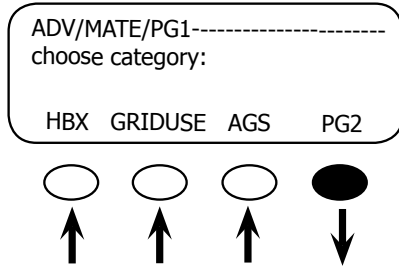

Pressing the <HBX>, <GRIDUSE>, or <AGS> soft keys open their specific advanced functions. Pressing the <PG2> soft key opens the next MATE advanced screen.

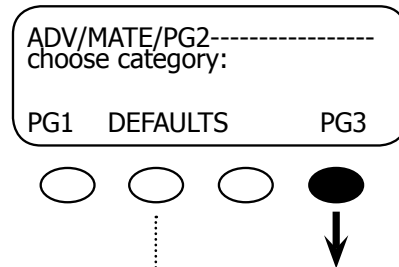

Pressing the <DEFAULTS> soft key brings up the ADV/MATE/DEFAULT screen which allows the user to re-establish all the MATE's factory default values (see pages 96-98). Press the <PG3> soft key to view the next MATE advanced screen.

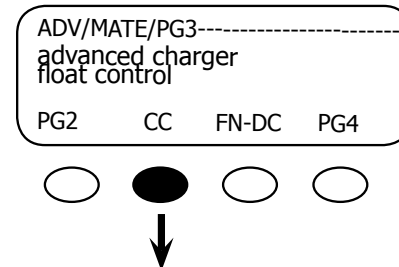
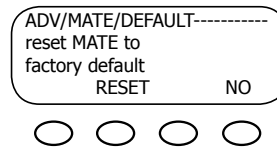

Pressing the <CC> soft key enables charge controller *float state coordination*. This means when a charge controller finishes a bulk charge and moves into float charge, the MATE directs any other charge controllers into a float charge as well. Pressing the <NO> soft key disables *float state coordination*.

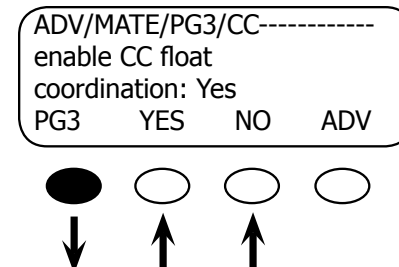

Press the <PG3> soft key to return to the previous screen.

## FLEXnet DC\*

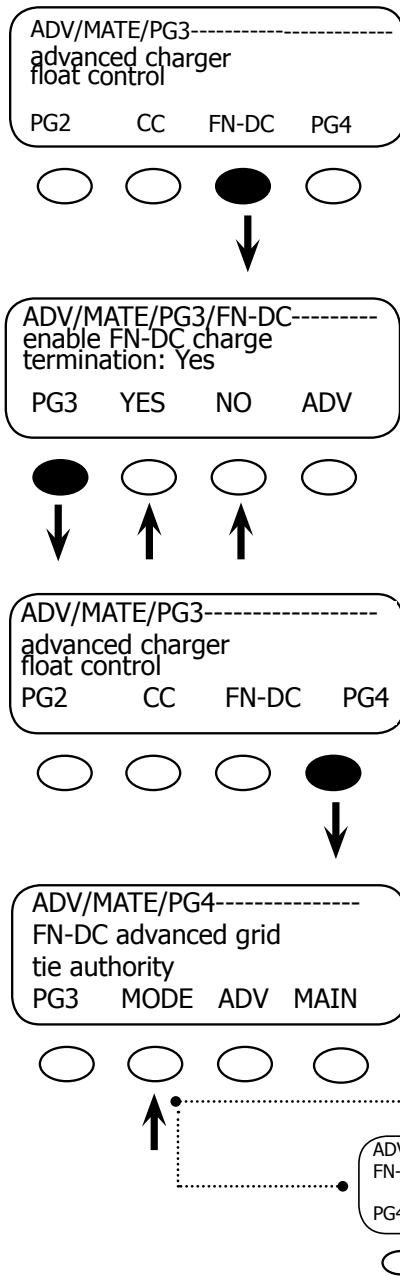

Pressing the <FN-DC> soft key brings up the FLEXnet DC *charge termination* screen.

Pressing the <YES> soft key enables the (FLEXnet) *FN-DC charge termination*. The FN-DC determines the batteries are fully charged when *Charge parms met* is satisfied. The MATE then commands all inverters and charge controllers to terminate their charge cycle. Pressing the <NO> soft key disables the *FN-DC charge termination*. Press the <PG3> soft key to return to the previous screen.

Press the <PG4> soft key to advance to the next ADV screen.

The *FN-DC advanced grid tie authority* screen leads to screens allowing the FN-DC limited control over the GTFX (grid-tie inverter/charger). Pressing the <MODE> soft key leads to those controls—*disabled* or *Charge parms met*. This is the last MATE ADV FN-DC screen.

In *Charge parms met mode*, the FN-DC determines if the batteries are fully charged, signaling the MATE to enable the Master GTFX to sell power to the grid (the GTFX must be gridtie mode enabled first). At midnight every day, the MATE disables the GTFX's grid-tie mode. When a renewable energy source is available later during daylight hours and the batteries are charged, sell mode returns.

Pressing the <INC> or <DEC> soft keys toggles the mode between *Charge parms met* and *disabled*, which shuts off *FN-DC gridtie enable*.

\*Please see the FLEXnet DC User's Guide for all related MATE screens.

## HBX Mode

*What it does:* HBX Mode allows control over the use of grid-supplied power based on user-determined battery voltage and time set points. A user can maximize renewable energy use and minimize the use of grid-supplied power through careful HBX usage.

The OutBack default values\* for HBX (24V system) are the following:

- High voltage—26 volts
- Low voltage—24 volts
- Time for both high and low settings—one hour

\* Double these values for a 48V system; divide them by one half for a 12V system. These values are not temperature compensated.

When the battery voltage remains at 26 volts for one hour, the FX will disconnect from the grid and the system will run on battery-supplied power. If the battery voltage falls to 24 volts for one hour, the FX connects to the grid. During this connected period, the grid-supplied AC current will power the loads and recharge the batteries unless the user manually shuts off the FX charging function off. With the charger off, the grid will only power the loads, allowing renewable energy sources to recharge the batteries. This avoids running the loads from the batteries and repeatedly charging and discharging them using more expensive utility power.

To shut the charger function off:

- Press the <AC IN> hot key three times until the CHARGER CONTROL screen appears.
- Press the <OFF> soft key.

HBX Mode:

- Stands for *high battery transfer*
- Is used with grid-connected FX Series Inverter/Chargers that have utility power as their AC input
- Is a mode primarily used in applications that have enough renewable energy (RE) power production to meet the needs of the loads most of the time
- Allows the FX to connect to an AC source if the battery voltage has fallen below a programmable set point for a user configurable amount of time (MATE will then allow the FX to remain connected to the AC source until the battery voltage has risen above a second set point for a programmable amount of time)

The MATE detects when the battery is truly low and needs charging as opposed to a sudden and momentary drop caused by a sizable demand for power from a device such as a motor. At these times, the MATE directs the FX to use AC power until the battery is fully charged again. The user programs in the amount of time a battery can be below the low voltage and the amount of time after it's fully charged before the MATE starts issuing its commands. The MATE uses these times to switch back and forth between AC and battery power. Additionally, in HBX mode, the FX charging function can be shut off to allow the alternative energy source to recharge the batteries while the loads are powered by the utility grid.

Press <INC> until 141, then press enter

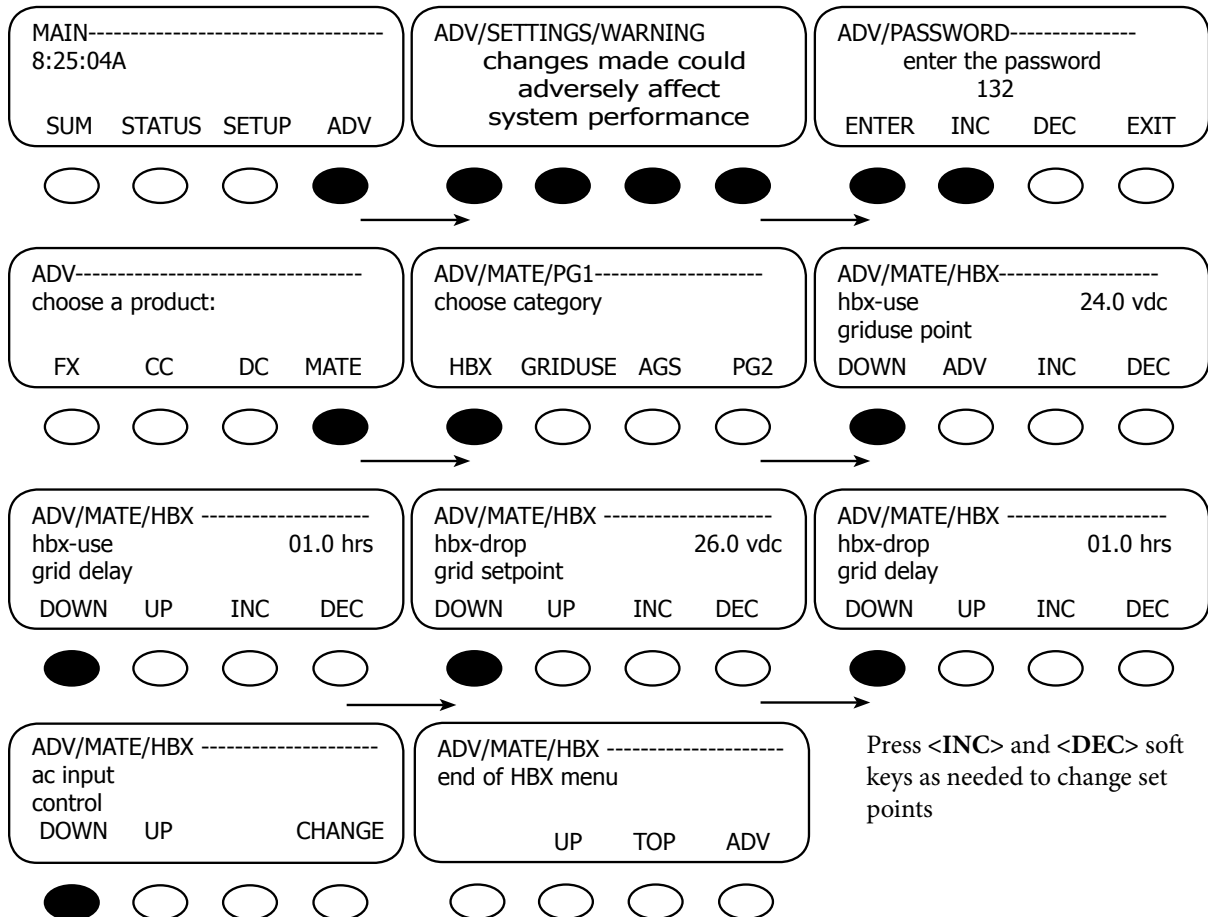





NOTE: HBX Mode will control the Master FX Series Inverter/Charger in Port 1 of a HUB-4 or HUB-10. The Master will then instruct any stacked Slaves to USE or DROP the AC input source (please see appropriate the FX programming manual for stacking instructions).

Before starting HBX Mode, set or reset the established values on the four MATE set point modes shown on the following screens:

- The first screen, HBX-USE GRID SET POINT appears when the HBX soft key is pressed on the previous ADV/MATE screen.
- Each successive screen appears by pressing the <DOWN> key on the previous menu.
- With these screens, the user sets the battery voltages and the amount of time these voltages must remain in order for the grid-supplied AC power to both recharge the battery and to disconnect. Since power demand surges can briefly affect a battery's voltage level, establishing voltage and time limits can prevent a premature or inappropriate connection to grid-supplied AC power that can occur due to a momentary change.

#### HBX-Use Grid Set Point

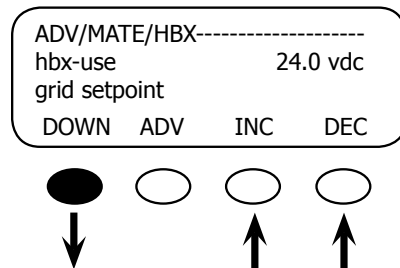

This is the voltage set point that allows the FX to connect to (USE) AC power. The battery voltage must remain below the voltage listed on the screen—24.0 vdc in this case—for the amount of time programmed by the HBX-USE GRID DELAY (see next screen) before a USE command is issued. Use the <INC> and <DEC> soft keys to change the voltage set point. Press the <DOWN> soft key to proceed to the next screen.

#### HBX-Use Grid Delay

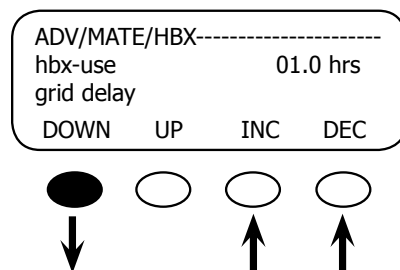

This set point—01.0 hrs in this example—is the amount of time the battery voltage must remain below the HBX-USE GRID SET POINT (above) before a USE command is sent. It can range from 00.1 hrs to 24.0 hrs in 0.1 hour increments. Times are adjusted using the <INC> and <DEC> soft keys. Press the <DOWN> soft key to proceed to the next screen.

### HBX-Drop Grid Set Point

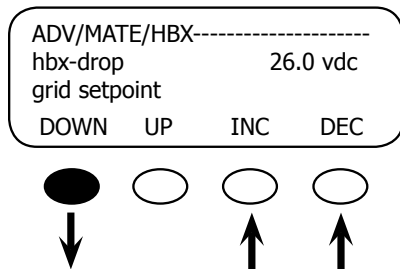

This set point shows the voltage—26.0 VDC is the default for a 24V system—at which the FX will DROP its AC input source. The battery voltage must remain above this voltage for the amount of time set by HBX-DROP GRID DELAY (next screen) for a DROP to be issued. Press the <DOWN> soft key to proceed.

### HBX-Drop Grid Delay

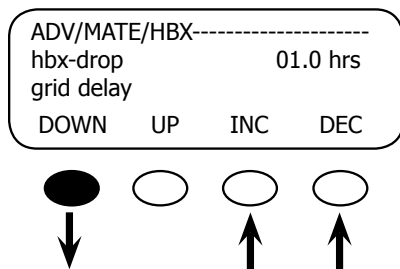

This set point is the amount of time—01.0 hrs in this case—battery voltage must remain above the HBX-DROP GRID SET POINT (see previous screen) before a DROP command is sent. It can range from 00.1 hrs to 24.0 hrs in 0.1 hour increments. These increments are adjusted using the <INC> and <DEC> soft keys. Press the <DOWN> soft key to proceed.

### AC Input Control

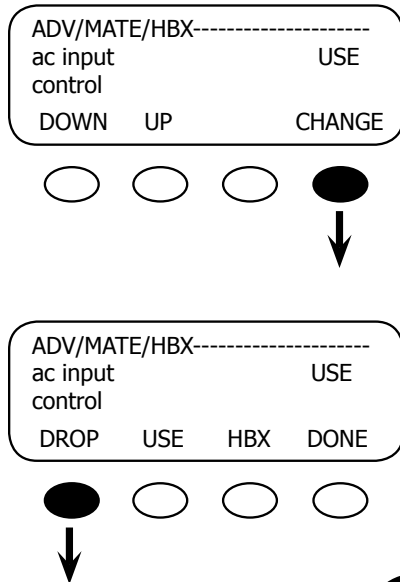

With this screen, HBX Mode can be enabled or disabled. Pressing <CHANGE> allows you to change the current mode in the next screen.



NOTE: Before enabling HBX Mode, make sure the FX is in DROP mode by pressing the <DROP> soft key. The screen will indicate DROP mode, allowing the MATE to reset the HBX values.

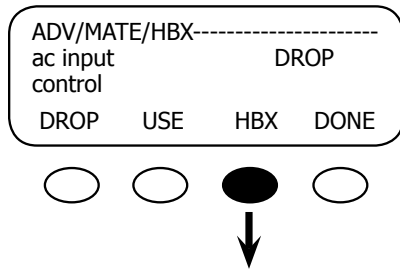

Enable HBX by pressing the <HBX> soft key. The screen now indicates the MATE is running in HBX mode by displaying the current state, USE or DROP followed by HBX.

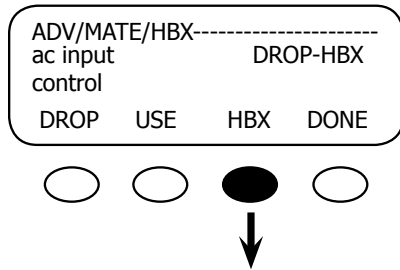

Disable HBX

To disable HBX Mode, press the <HBX> soft key again. After disabling HBX, the system remains in whichever state—DROP or USE—it was in while HBX Mode was active. Be sure to reset the DROP or USE to the desired state once it's out of HBX Mode.

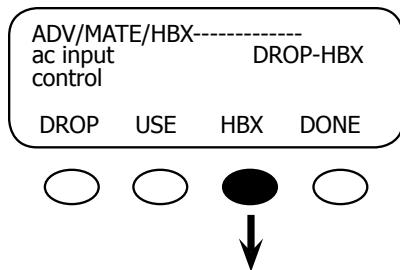

Pressing the <DONE> soft key returns to the last HBX activated USE menu.

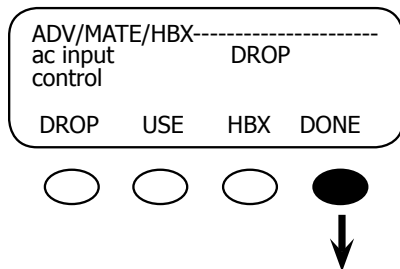

Press the <UP> soft key to return to the *hbx-drop grid delay* screen. Press the <DOWN> soft key to open the *end of HBX menu* screen.

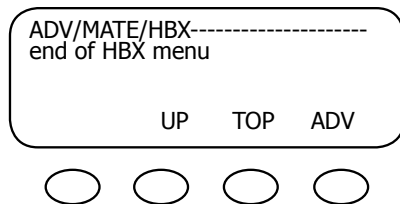
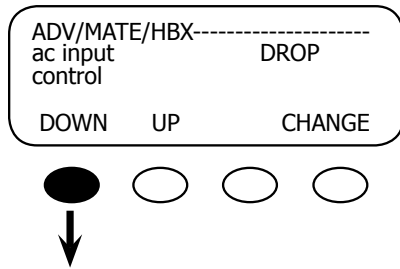

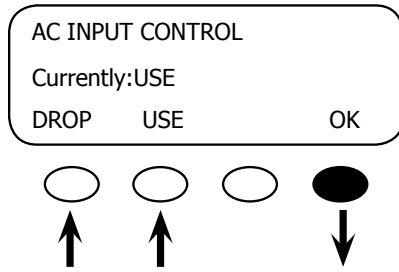

Push the <AC IN> hot key to view the AC status and change to USE or DROP as needed. Pressing the <OK> soft key means you accept the conditions or mode shown on the screen.



---

NOTE: Even with HBX enabled, the user can issue manual DROP or USE commands using the AC INPUT CONTROL found under the ACIN hot key. Once a manual command is issued, the system will remain in that chosen command until the next HBX scheduled cycle normally occurs.

---

Because GRID-USE Mode uses the DROP and USE commands, it cannot be enabled at the same time as HBX Mode. Enabling GRID-USE will automatically disable HBX Mode

## Grid-Use Mode

*Why you might want it:* Grid-connected systems make use of utility-supplied power. The MATE's Grid-Use Mode allows the user to pre-determine the time periods it uses the grid.



NOTE: The FX's default settings are for a generator-supported system. If your system includes a utility's grid, set the FX to Grid by going to SETUP/FX/INPUT *ac transfer control* and pressing the <GRID> soft key. Programming is done in the ADVANCED FX GRID and GEN menus.

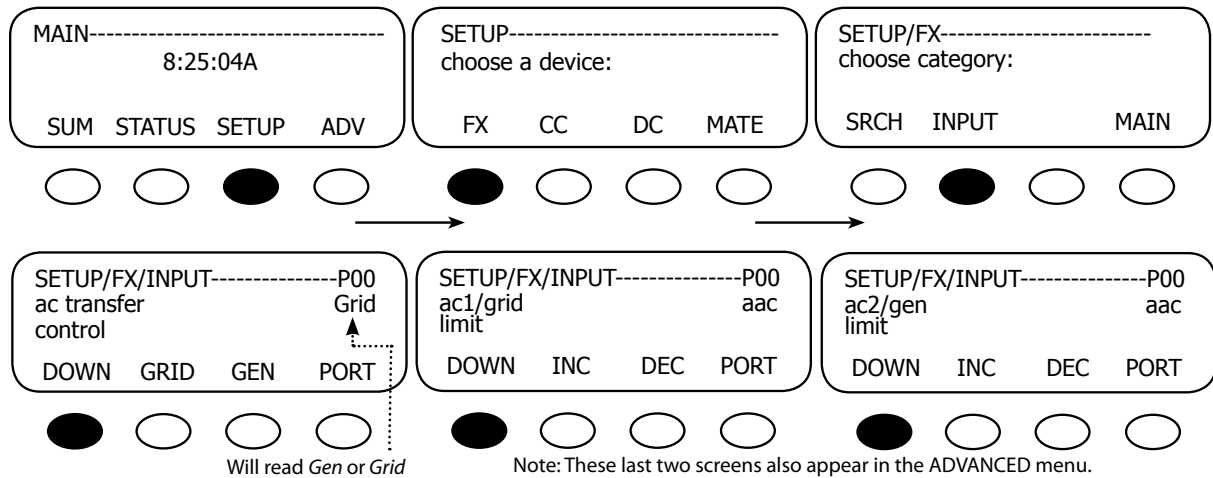

Grid-Use Mode allows programming the times the FX system connects to an AC input source and enables the **USE** mode. The time and date must be accurately programmed for Grid-Use mode to function properly.

Grid-Use Mode is programmed separately for weekday and weekend connect times. Care must be taken when programming weekday and weekend times that encompass USE periods past midnight (12:00 a.m.). The user must take into account weekday USE periods that will end on a Saturday.

### Example #1:

Weekday Start-6:00 p.m.

Press <INC> and <DEC> soft keys as needed to change set points

Weekend Start-12:00 a.m.

Weekend Stop-12:00 a.m.

The weekend USE period has been left at its default (12:00 a.m.). Any time that a *Start* time equals a *Stop* time, no action will be taken and the time period is ignored. The above settings will have the following results:

- Monday—Friday evenings at 6 p.m., the MATE issues a USE command to the FX allowing the AC input source to be used.
- Monday-Friday mornings at 6 a.m., a DROP will be issued.
- On Friday evening at 6 p.m., a USE will be issued but since the *Weekend Start* and *Stop* times are equal, the weekend use time is disabled; no DROP will be issued until Monday morning at 6 a.m.

Example #2:

Weekday Start-6:00 p.m.                      Weekday Stop-6:00 a.m.  
 Weekend Start-4:00 p.m.                      Weekend Stop-8:00 a.m.

- Monday—Thursday evenings at 6:00 p.m., the MATE will issue a USE command to the FX allowing the AC input source to be used.
- Monday—Friday at 6:00 a.m., a DROP will be issued. On Friday evening at 6:00 p.m., a USE will be issued.
- The following morning is a weekend (Saturday) so a DROP command will be issued at 8:00 a.m. During Saturday afternoon at 4:00 p.m., the FX will USE again until Sunday morning at 8:00 a.m. On Sunday evening at 4:00 p.m., a USE time period will start, ending on Monday morning at 6:00 a.m.



NOTE:

- If the battery voltage falls below the FX's Low Battery Cut-Off voltage, the FX will automatically connect to the AC input source regardless of the GRID-USE time of day setting.
- Because GRID-USE Mode uses the DROP and USE commands, it cannot be enabled at the same time as HBX Mode. Enabling GRID-USE will automatically disable HBX Mode.
- GRID-USE Mode only allows one Drop and Use per day. GRID-USE can be affected by the MATE not automatically adjusting its clock for Daylight Savings Time.
- A START time that equals a STOP time disables a change during that period (weekdays or weekends). If disabled, the current USE or DROP command will continue through the disabled period. If both the weekday and weekend periods have START and STOP times that are the same, respectively, the GRID-USE Mode will be completely disabled.

To enter grid use mode:

Press until 141 and then press enter.

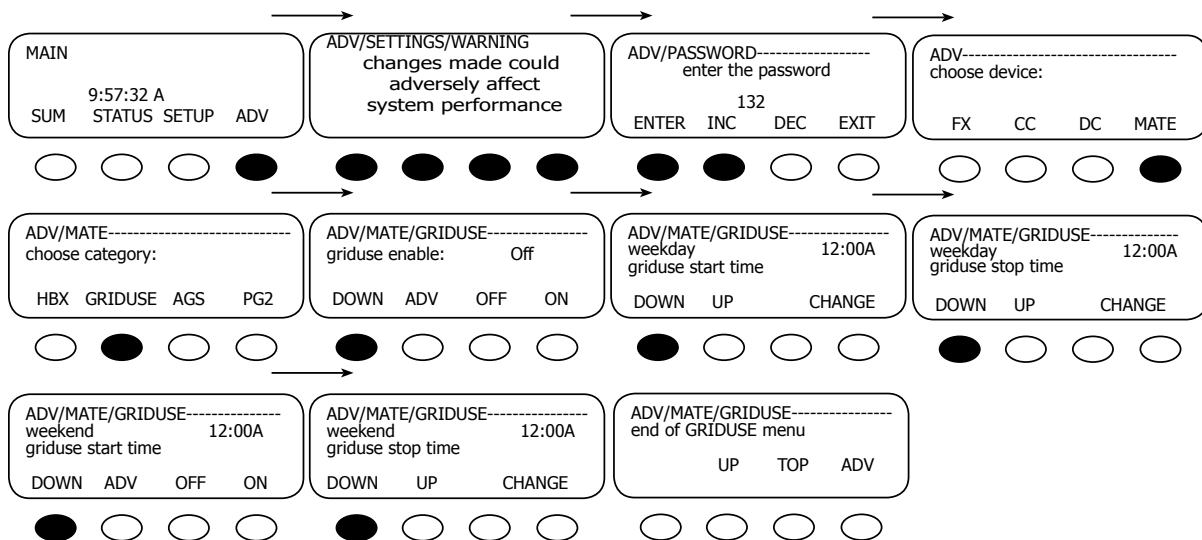

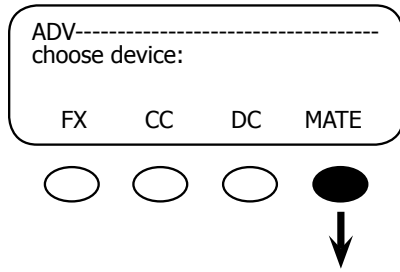

On the ADV menu, push the <MATE> soft key.

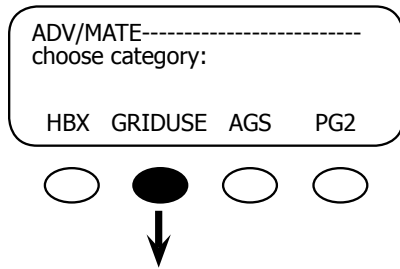

Press the <GRIDUSE> soft key on the <ADV/MATE> screen.

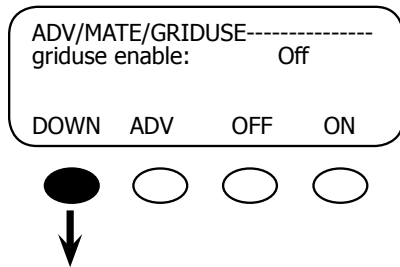

The first GRID-USE screen to appear is the *griduse enable* screen. This screen turns GRID-USE mode ON or OFF.



NOTE: Set all the weekday and weekend timing first before turning the GRID-USE Mode on. The GRID-USE settings can be accessed by pressing the <DOWN> soft key.

### Weekday Grid-Use Start

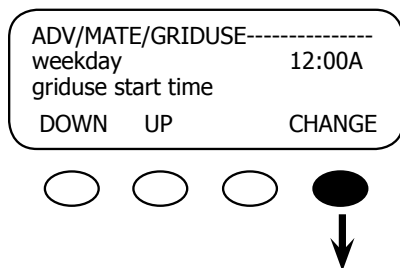

This setting is the time during the week (Monday–Friday) that a USE will be issued to the FX system, allowing it to connect to the AC input source. The time displayed is the default setting. To change the time on the *adj hour* screen, press the <CHANGE> soft key

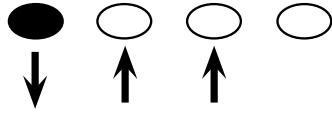
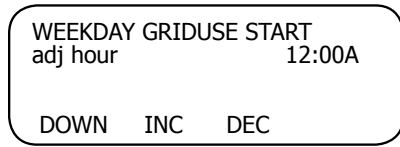

<INC> and <DEC> set the hour to the desired time. Press <DOWN> to access the *adj min* screen.

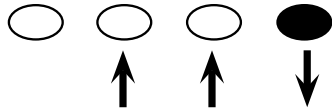
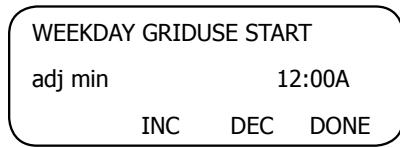

<INC> and <DEC> set the minutes to the desired time. Press the <DONE> soft key to return to the *weekday griduse start* screen.

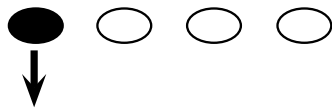
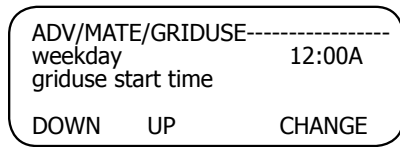

Press the <DOWN> soft key to access the ADV/MATE/GRIDUSE *weekday grid-use stop* screen.

### Weekday Grid-Use Stop

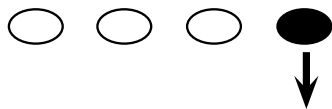
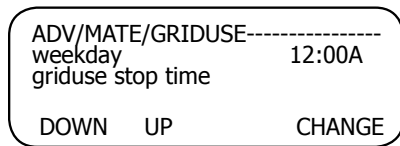

The WEEKDAY GRID-USE STOP setting is the time during the week (Monday-Friday) that a DROP will be issued to the FX system, forcing a disconnect from the AC input source. The time displayed is the default setting. To change the time, press the <CHANGE> soft key and adjust the hour and minute settings on the next screens using the <INC> and <DEC> soft keys. Proceed through the Adjust Hour (adj hour) and Adjust Minutes (adj min) screens in the same manner described in the *weekday grid-use start* section.



### Weekend Grid-Use Start

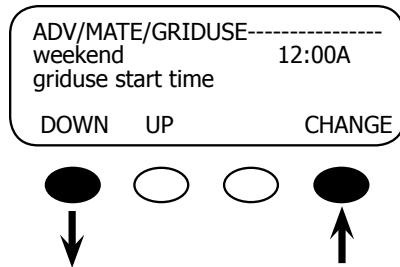

This setting is the time during the weekend (Saturday and Sunday) that a <USE> will be issued to an FX system, allowing the FX to connect to the AC input source. The time displayed is the default setting. To change the time press the <CHANGE> soft key and adjust the time as you would for a weekday setting. Press the <DOWN> soft key to view the *weekend griduse stop* screen.

### Weekend Grid-Use Stop

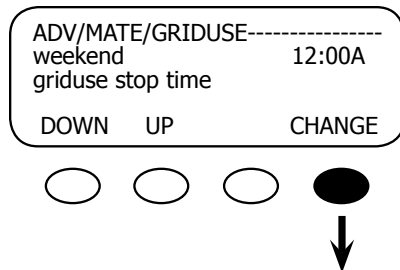

This setting is the time during the weekend (Saturday and Sunday) that a **DROP** will be issued to the FX system, forcing the FXs to disconnect from the AC input source. The time displayed is the default setting. To change the time press the <CHANGE> soft key and adjust the time as you would for a weekday setting.

After setting the START and STOP times, scroll back to the first GRID-USE *enable* screen using the <UP> soft key. Press the <ON> soft key to activate GRID-USE Mode.

## Automatic Generator Start (AGS) Mode

This section applies to off-grid systems which regularly use generator-supplied power.

Why you may want it: Some systems include fuel-powered generators for either back-up or regular usage. Advance Generator Start Mode sets the conditions under which a generator will automatically start and stop, eliminating inconvenient manual starts and stops. If a user isn't at home or near the system, the generator will run anyway, in some cases keeping vital appliances and motors running.

Advanced Generator Start (AGS) Mode utilizes the auxiliary (AUX) output found on each FX and is compatible with any two-wire start generator. AGS offers a variety of conditions that will start a generator by energizing the FX AUX output or the FLEXnet DC relay output.

AGS starts the generator anytime one or more of the Gen Start conditions are true and will stop the generator only when all of the conditions are false except during a programmed *Quiet Time* (normally at night when a noisy generator would be disturbing).



---

NOTE: Low Battery Cut Out overrides Quiet Time.

---

GenAlert is another way to automatically start a generator, but it does not offer the range of programming options as AGS. AGS is a function of the MATE while GenAlert is a function of the FX, which is programmed using the MATE. Information on the GenAlert function can be found in the FX programming and operations manual.



---

NOTE: Choose either AGS or GenAlert to automatically start your generator. Enabling AGS overrides all AUX control functions of that particular inverter.

---

AGS can start a generator under the following variety of settings:

- Voltage Start
- Load Start
- Must Run
- State of Charge % Start (FLEXnet DC)
- Exercise

**SAFETY WARNING: AGS can cause severe damage if the generator and battery bank are not properly maintained.**

# AGS Setup

To enter the AGS setup, go to the <ADV/MATE> screen:

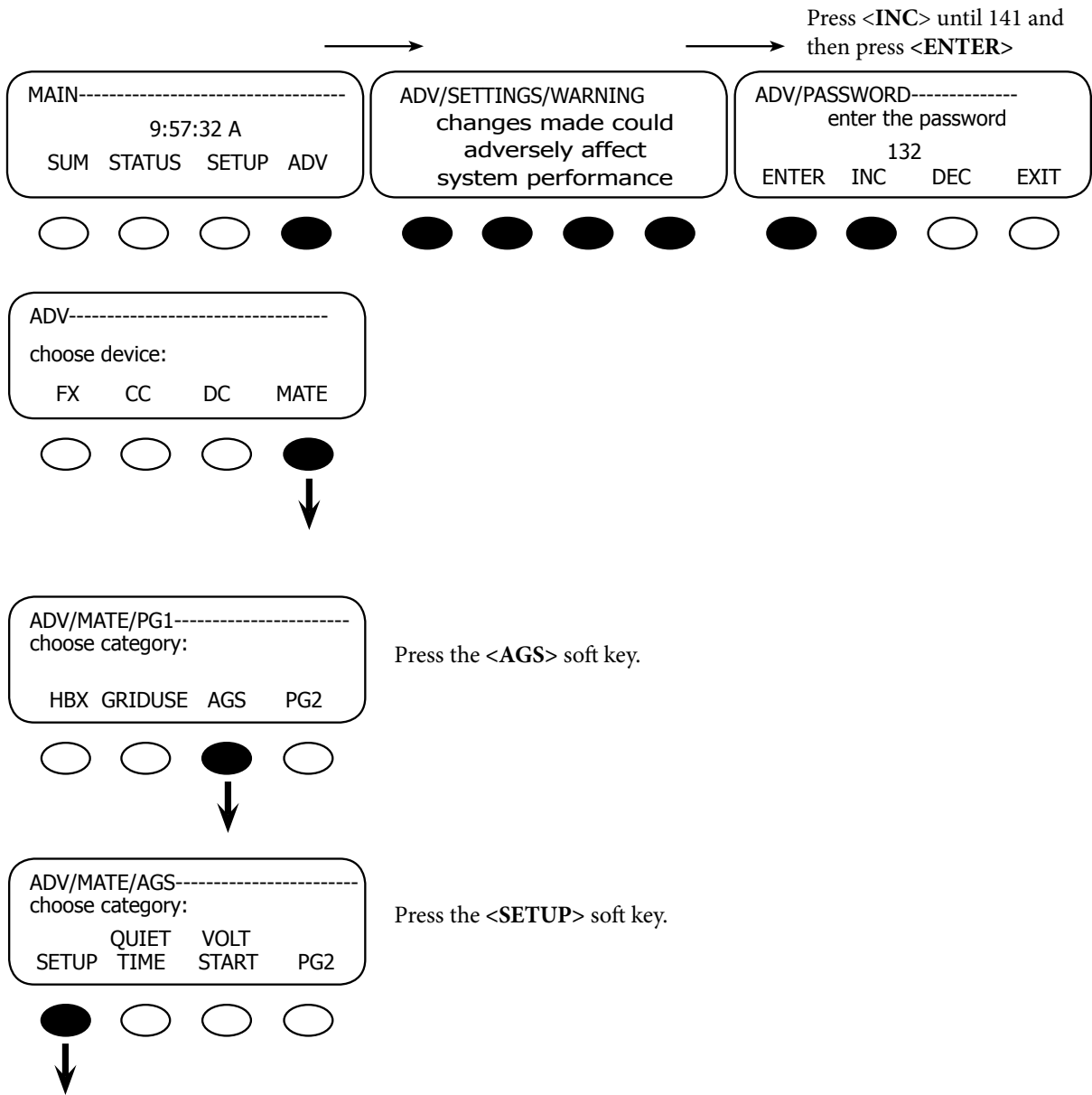

The AGS Setup menu contains the following general settings that define the AGS routines.

## AGS Port

The MATE uses the AUX output of an FX or FLEXnet DC relay to control the generator. The MATE is connected to this FX either directly or through a HUB.

If a HUB is used:

- Use the <INC> and <DEC> soft keys to set the AGS Port value to the HUB FX or FLEXnet DC Port controlling the generator.

If no HUB is used and the MATE is directly plugged into an FX, then the AGS Port needs to be set to 0 (zero).

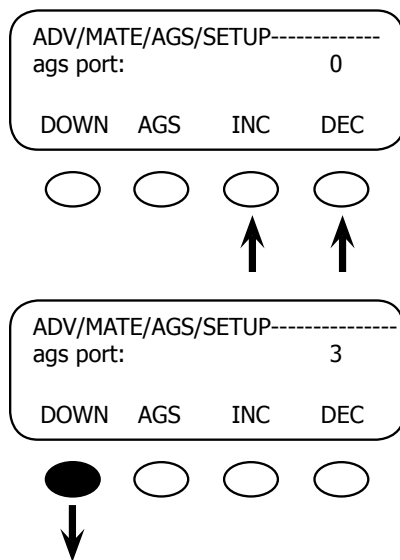

Example:

A MATE is connected to a HUB-10 that has four FXs and three Charge Controllers connected to it. The FXs are plugged into Ports 1 – 4, as labeled on the HUB, and the Charge Controllers are plugged into Ports 5 – 7. Any FX can have its AUX output wired to a relay whose contacts are wired to the starting circuitry of the generator. The AGS Port must be set to the port of the chosen FX.

After setting the AGS Port, press the <DOWN> soft key. The next screen allows you to enable the AGS Mode.

## AGS Enabled

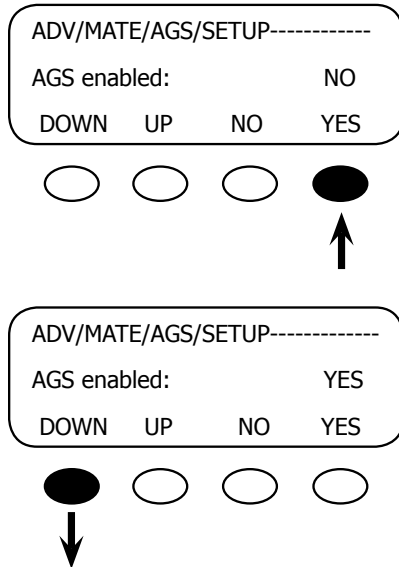

This is the overall control for the AGS Mode. If AGS is not enabled, none of the AGS settings or controls will work. Enable the AGS first by pressing the <YES?> soft key and then establish your settings.

After enabling the AGS Mode, press the <DOWN> soft key to continue to the AGS Control menu.

## AGS Control

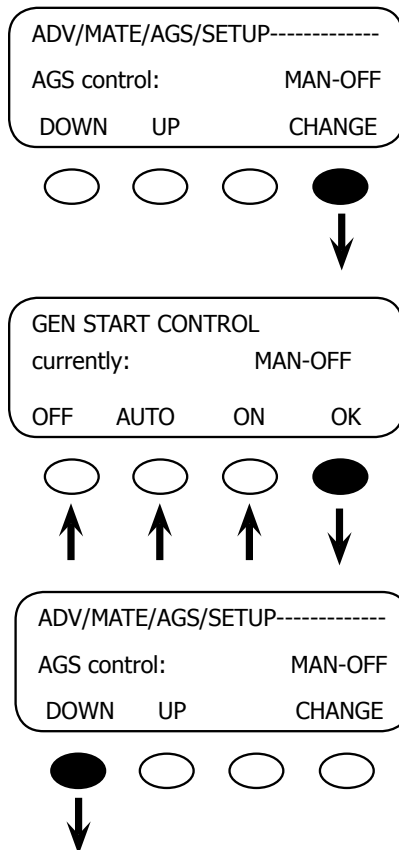

This screen allows the AGS Mode to be changed. Pressing <CHANGE> brings up a screen that allows the user to switch choose from three AGS control modes sown below.

This screen offers three options for AGS control:

- **OFF** manually de-energizes the FX AUX or FLEXnet DC relay output and stops the generator regardless of any AGS setting; this is displayed as **MAN - OFF**.
- **AUTO** allows AGS settings to start and stop the generator automatically and is displayed as either **AUTO - ON** (when the AUX is activated), or **AUTO - OFF** (when the AUX is deactivated).
- **ON** will manually energize the FX AUX output and start the generator regardless of any AGS setting; this is displayed as **MAN - ON**.
- **OFF** and **ON** are considered “manual” selections, hence the **MAN-OFF** and **MAN-ON** screen displays.

Press the <DOWN> soft key to view the next setup screen.

## DC Genset

ADV/MATE/AGS/SETUP			
dc genset			NO
DOWN	UP	NO	YES

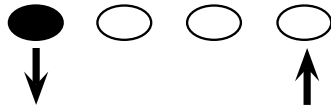

In this screen, YES means a DC generator is present and the AGS routine, which normally stops the generator upon the FX going to Float or Silent, will instead stop the generator when the *vdc genstop* setting is reached.

---

NOTE: If you have a generator that produces AC voltage, maintain the NO status shown on this screen.

---

Press the <DOWN> soft key to go to the *vdc genstop* screen.

## VDC Genstop

ADV/MATE/AGS/SETUP-----			
vdc genstop:			38.0 vdc
DOWN	UP	INC	DEC

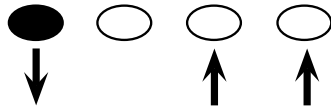

This voltage setting will terminate a Voltage Start command when the battery voltage remains above it for 15 minutes regardless of the DC Genset setting. The setting can be adjusted using the <INC> and <DEC> soft keys. Press the <DOWN> soft key to view the AGS fault time screen.

---

NOTE: The *vdc genstop* will turn off a generator even if the *dc genset* on the previous screen says <NO>.

---

ADV/MATE/AGS/SETUP-----			
AGS fault time			17
minutes			
DOWN	UP	INC	DEC

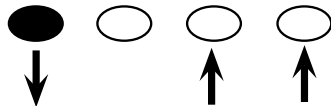

AGS Fault Time is the period the generator is given to connect to the FX system after the AUX output has been activated. If the generator fails to connect and provide AC current, the MATE displays an AGS error. The user can set this time anywhere from 5-30 minutes by pressing the <INC> and <DEC> soft keys. Press the <DOWN> soft key to reach the *cool down time* screen.

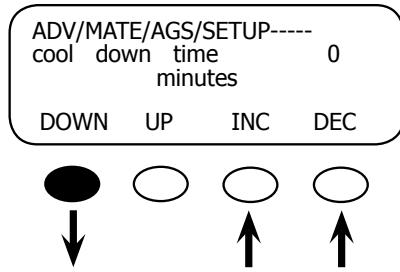

After the FX charging has been disabled, the *cool down time* screen allows the user to adjust the number of minutes the generator will cool down before being shut off. This time should follow the manufacturer's recommendations. Press the <DOWN> key to view the warm up time screen

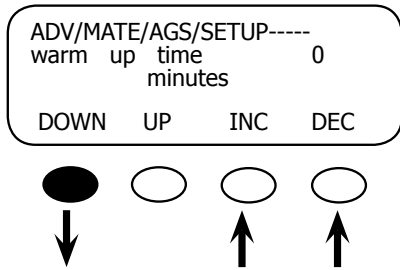

The *warm up time* screen allow the user to adjust the number of minutes the generator will warm up before the FX charging begins. This time should follow the manufacturer's recommendations. Press the <DOWN> key to view the *End of AGS SETUP* time screen

NOTE: Cool down and warm up times are not used when DC generator (*dc genset*) is selected.



NOTE: Cool down and warm up times are not used when DC generator (*dc genset*) is selected.

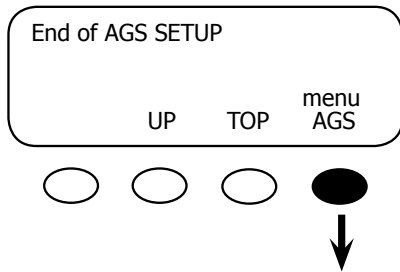



In the End of the AGS SETUP screen Press the <menu AGS> soft key for more AGS programming.

Generators are an integral part of many renewable energy systems. Setting a generator's start and stop times and voltage set points can be confusing. The following test helps assure your generator is properly functioning and the programming is accurate (*AGS must be set up first in order to perform this test*).

Before any further programming, confirm that the generator is working properly by manually turning it on and then shutting it off.

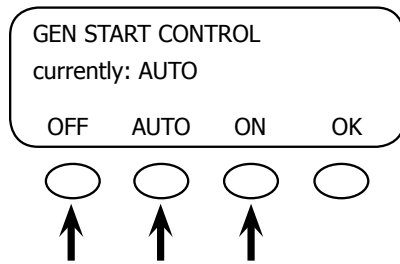
### Advanced Generator Start (AGS) Test



PRESS TWICE:  

- Brings up the GEN START CONTROL screen.
- Press the <ON> soft key and wait for the generator to go on.
- Press the <OFF> soft key to shut the generator off.
- Press the <AUTO> soft key to put the generator in AUTO mode
- Press the <OK> soft key to return to the ADV/MATE/AGS screen.

The AGS test confirms the AGS function works and the generator has been enabled during the AGS programming. Sometimes the GEN ALERT set points and properties get confused with AGS and this test confirms the correct set points are used. GEN ALERT set points should not be used as AGS set points. These are two separate methods for starting a generator automatically.

### Quiet Time

**Why do you might want it:** If *Quiet Time Mode* is set, the MATE will not allow most AGS settings to start the generator during the *Quiet Time* window. This is usually set up during night time when a running generator would be an annoyance. *Quiet Times* can be set individually for weekday and weekend, and consist of a *Quiet Time Start* and a *Quiet Time Stop*.



---

NOTE: The *2-minute Voltage* set point (see page 86) will override *Quiet Time* settings. This is necessary to prevent the battery from falling below an unacceptable voltage.

---

As with GRID-USE settings, if you set the START and STOP modes for the same time (for example, 12:00 a.m.), each will be ignored. To program *Quiet Time Mode*, go to the advanced MATE menu.



PRESS <INC> UNTIL 141 AND THEN PRESS ENTER

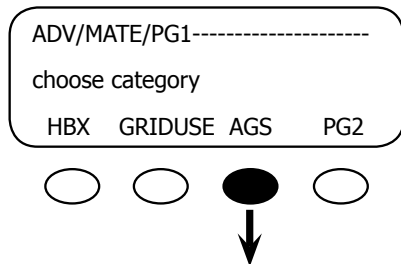
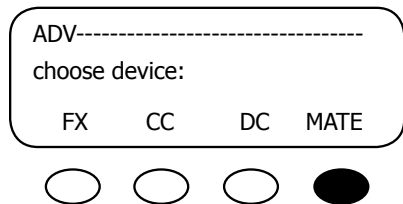
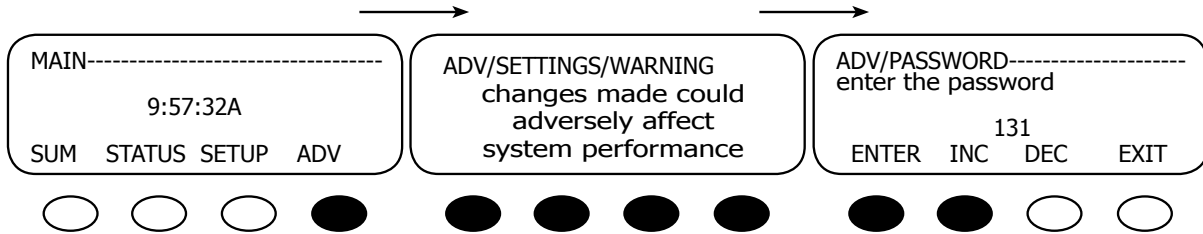

Go to the ADV/MATE screen and press the <AGS> soft key.

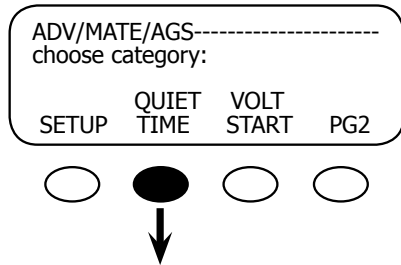

Next, press the <QUIET TIME> soft key.

Weekday Start

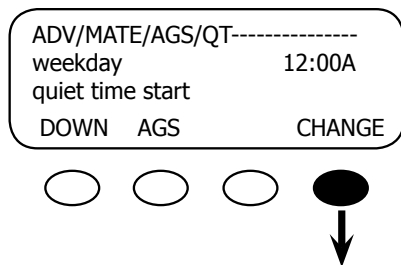

*weekday quiet time* start is the beginning of the Monday-Friday quiet time period. Most AGS start conditions will be stopped during this time. <CHANGE> adjusts the hour and minutes settings.

WEEKDAY QT START		12:00A
adj hour		
DOWN	INC	DEC

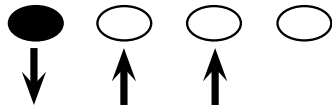

<INC> and <DEC> adjust the weekday start hours. When finished, press the <DOWN> soft key.

WEEKDAY QT START		12:00A
adj min		
	INC	DEC
		DONE

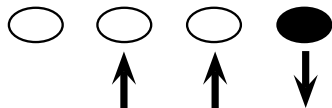

<INC> and <DEC> adjust the weekday start minutes. When finished, press the <DONE> soft key. This will return you to the ADV/MATE/AGS/QT weekday quiet time start menu.

ADV/MATE/AGS/QT-----		
weekday:		12:00A
quiet time start		
DOWN	AGS	CHANGE

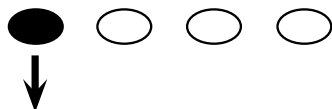

Press the <DOWN> soft key to go to the *weekday quiet time stop* screen.

### Weekday Stop

ADV/MATE/AGS/QT-----		
weekday		12:00A
quiet time stop		
DOWN	AGS	CHANGE

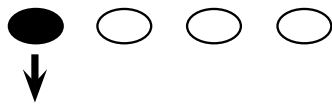

*weekday quiet time stop* is the end of the quiet time period for Monday-Friday. To change the time, press the <CHANGE> soft key and adjust the hour and minute settings on the next screens using the <INC> and <DEC> soft keys. Proceed through the *adj hour* and *adj min* screens in the same manner described in the Weekday Start section. Press the <DOWN> soft key on the final ADV/MATE/AGS/QT weekday quiet time stop screen to open the weekend screens.

## Weekend Start

ADV/MATE/AGS/QT-----		
weekend:		12:00A
quiet time start		
DOWN	UP	CHANGE

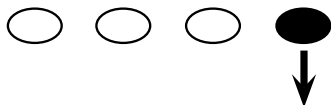

WEEKEND QT START-----		
adj hour		12:00A
DOWN	INC	DEC

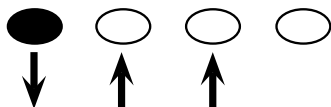

WEEKEND QT START-----		
adj min		12:00A
	INC	DEC
		DONE

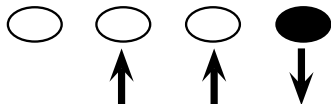

ADV/MATE/AGS/QT-----		
weekend:		12:00A
quiet time start		
DOWN	UP	CHANGE

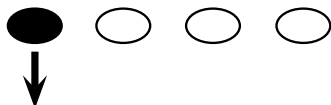

*weekend quiet time* start is the beginning of the quiet time period for Saturday and Sunday. Most AGS start conditions will be stopped during this time. Press the **<CHANGE>** soft key to adjust the hour and minutes settings.

**<INC>** and **<DEC>** adjust the hourly setting for the WEEKEND QT START. Press the **<DOWN>** soft key when finished.

**<INC>** and **<DEC>** adjust the minutes setting for the WEEKEND QT START. Press the **<DONE>** soft key when finished.

If you are satisfied with the *weekend quiet time* start settings, press the **<DOWN>** soft key and go to the weekend stop screen.

## Weekend Stop

ADV/MATE/AGS/QT-----		
weekend		12:00A
quiet time stop		
DOWN	UP	CHANGE

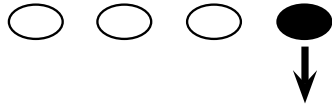

WEEKEND QT STOP-----		
adj hour		12:00A
DOWN	INC	DEC

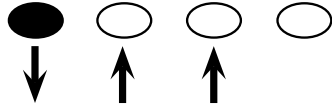

WEEKEND QT STOP-----		
adj min		12:00A
	INC	DEC
		DONE

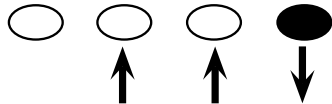

ADV/MATE/AGS/QT-----		
weekend		12:00A
quiet time stop		
DOWN	UP	CHANGE

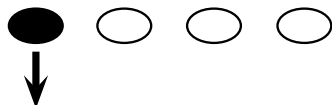

ADV/MATE/QUIET TIME-----		
end of QUIET TIME		
menu		
UP	TOP	AGS

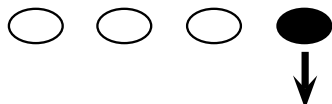

*weekend quiet time stop* is the end of the quiet time period for Saturday & Sunday. **<CHANGE>** adjusts the hour and minutes settings.

**<INC>** and **<DEC>** adjust the hourly setting for the WEEKEND QT STOP. Press the **<DOWN>** soft key when finished.

**<INC>** and **<DEC>** adjust the minute setting for the WEEKEND QT STOP. Press the **<DONE>** soft key when finished.

If you are satisfied with the *weekend quiet time stop* settings, press the **<DOWN>** soft key and go to the end of the *quiet time* menu.

Press the **<AGS>** soft key to return to ADV/MATE/AGS screen.

## Voltage Start

There are three voltage start set points in AGS Mode that the user can adjust. After a generator is started due to a Voltage Start setting, it will be stopped when the FX completes the absorb charge or based on the VDC Genstop setting in the AGS Setup menu previously explained.



NOTE: If the DC Genset is set to YES, the generator will only stop after the battery voltage has reached the VDC Genstop voltage for 15 minutes.

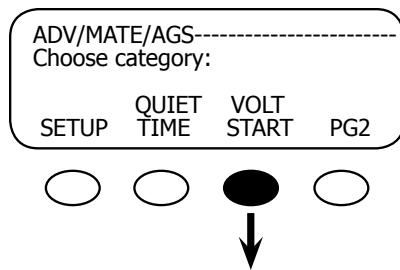

To get to the Voltage Start screen, press the **<VOLT START>** soft key on the ADV/MATE/AGS screen.

### 24-Hour Voltage Set Point

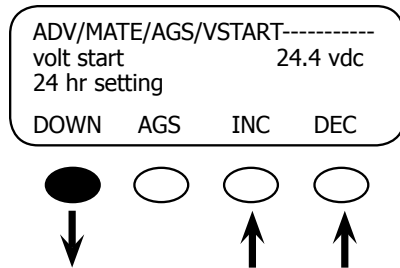

If the battery voltage falls below this set point, a 24 hour timer starts counting down. Upon reaching zero, a start command is sent to the generator unless it is currently Quiet Time. To change the default settings, use the **<INC>** and **<DEC>** soft keys. When finished, press the **<DOWN>** soft key to go to the *volt start 2 hr setting* screen.

### 2-Hour Voltage Set Point

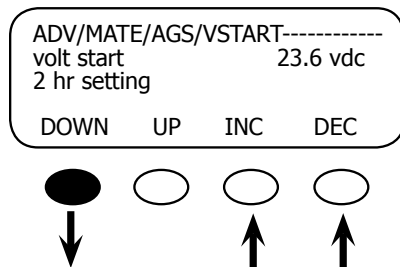

If the battery voltage falls below this set point, a 2 hour timer starts to count down. After reaching zero, a start command is sent to the generator unless it is currently Quiet Time. To change the default settings, use the **<INC>** and **<DEC>** soft keys. When finished, press the **<DOWN>** soft key to go to the *volt start 2 min setting* screen.

## 2-Minute Voltage Set Point

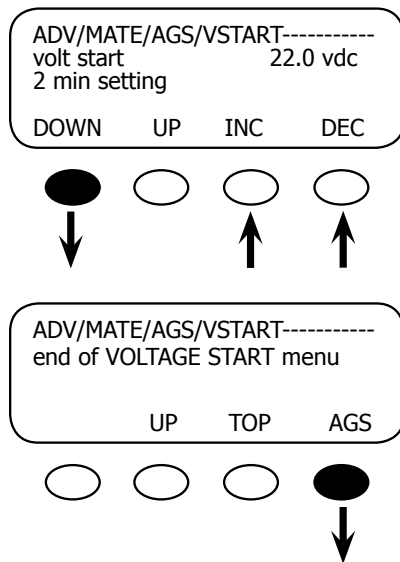

If the battery voltage falls below this set point, a 2-minute timer starts to count down. Upon reaching zero, a start command is sent to the generator even if it is currently Quiet Time. Use the <INC> and <DEC> soft keys to change the default settings. When finished, press the <DOWN> soft key to go to the *end of VOLTAGE START* menu.

Press the <AGS> soft key to return to ADV/MATE/AGS

## Load Start

**Why you might want it:** Instead of the generator starting only at preset times or according to battery voltage conditions, Load Start allows it to start because the demand for electricity is high. This should prevent the batteries from being depleted. As soon as the demand decreases and the batteries can adequately fulfill it, the generator will shut off.

Load Start will start a generator whenever the total system AC Load exceeds the set point for the programmed amount of time. The generator will then be stopped when the AC load has dropped below a Load Stop set point for a programmed amount of time.

When the generator is running because of Load Start, the FX system will charge the batteries. This charge might not be completed if the generator is disconnected because of Load Stop.



---

NOTE: Large instantaneous loads can still overcurrent the inverter prior to the generator starting and getting in sync with the inverter.

---

To open the Load Start screen:

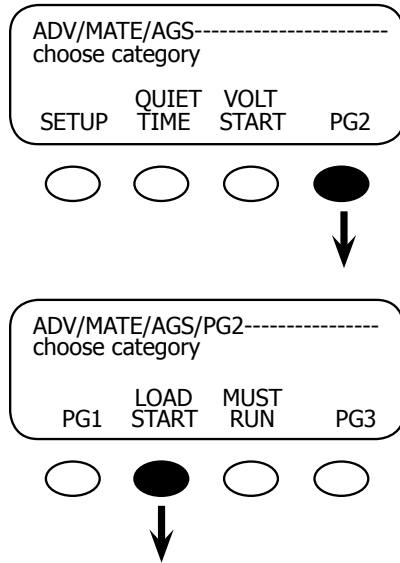

Go to the ADV/MATE/AGS screen and press the <P2> soft key.

At the ADV/MATE/AGS/PG2 screen, press the <LOAD START> soft key.

Load Start KW

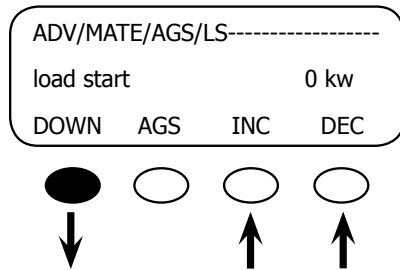

In the *load start kw* screen, an AGS start command will be issued when the total AC load of all the FXs connected to the MATE exceeds this setting for the load start delay (next screen) time. A zero value disables any load start function. <INC> and <DEC> adjusts this setting between 1 - 50kW. After the value has been set, press the <DOWN> soft key to get to the *load start delay* screen.

Load Start Delay

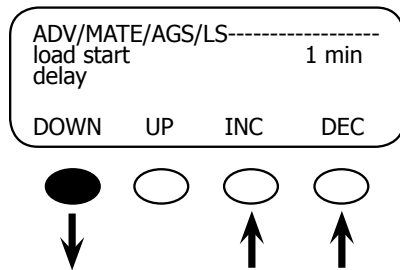

This setting is the delay time that the total system AC load must remain above the load start kw setting (see previous screen), before the generator is started. It is adjustable from 1 to 240 minutes using the <INC> and <DEC> soft keys. After making any adjustments to the delay time, press the <DOWN> soft key to go to the *load stop kw* screen.

## Load Stop KW

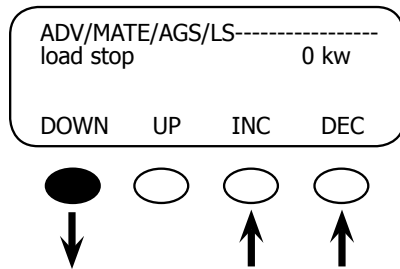

An AGS stop command will be issued when the total AC load of all the FXs connected to the MATE falls below this setting for the amount of time set with *load stop delay* (next screen) as long as the generator was started due to Load Start. This setting excludes any FX charger current for its AC load calculation. The setting can be changed using the <INC> and <DEC> soft keys. Pressing the <DOWN> soft key leads to the *load stop delay* screen.

## Load Stop Delay

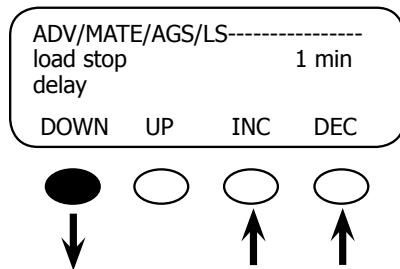

This setting is the delay time the total system AC load must remain below the Load Stop kw before the generator is stopped. It is adjustable from 1 to 240 minutes using the <INC> and <DEC> keys. Pressing the <DOWN> soft key leads to the *end of the VOLTAGE START* menu screen.

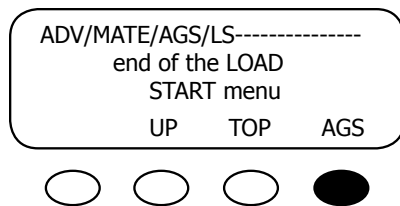

Pressing the <AGS> soft key returns the ADV/MATE/AGS/PG2 screen



## Must Run

**Why you might want it:** In time, a user can determine patterns in energy usage and demands on batteries. Must Run times the generator usage to the heaviest user demands during a day, thus avoiding depleting the batteries or requiring a long recharging period. This might happen in the mornings or early evenings when a family's power demand is higher.

**Must Run Time** is a daily time period when the MATE commands the generator to run. *Must Run Times* can be set individually for weekdays and weekends and consist of a *must run start time* and a *must run stop time*. Setting *must run start* and *stop* times to the same time disables the Must Run function. To go to the Must Run screens, press the **<Must Run>** soft key on the ADV/MATE/AGS/P2 screen.

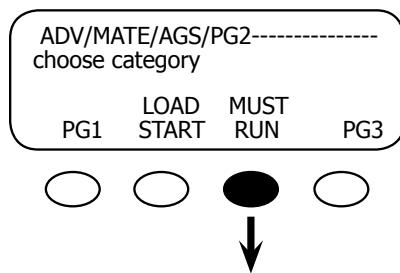

From the ADV/MATE/AGS/PG2 screen, press the **<MUST RUN>** soft key and open the ADV/MATE/AGS/MR *weekday must run start time* screen.

## Weekday Start

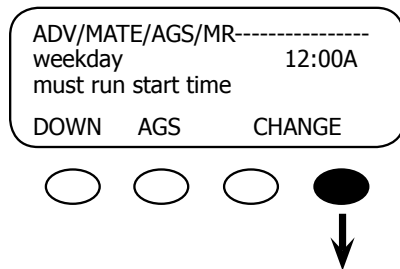

*weekday must run start time* is the beginning of the time period Monday-Friday that the generator will be forced to run. Press **<CHANGE>** to adjust the hour and minutes settings using the **<INC>** and **<DEC>** soft keys.

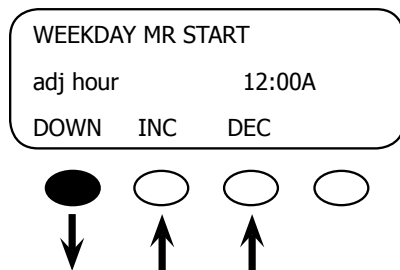

Adjust the weekday must run start time minutes with the **<INC>** and **<DEC>** soft keys. Press the **<DOWN>** soft key to view the *adj min* screen.

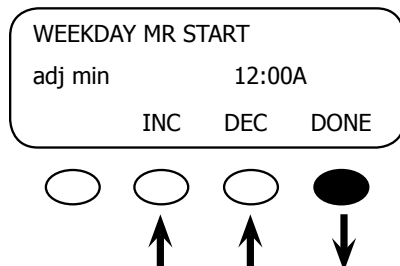

After the minutes have been set, press the **<DONE>** soft key to return to the ADV/MATE/AGS/MR *weekday must run start time* screen.

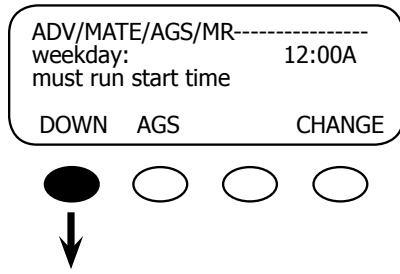

*weekday must run stop time* is the end of the Must Run time period for Monday-Friday. Press the **<DOWN>** soft key to go to the *weekday must run stop* screen.

### Weekday Stop

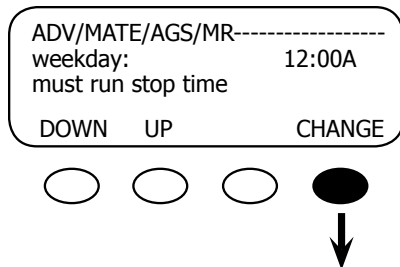

To adjust the start time hour and minute settings, press the **<CHANGE>** soft key.

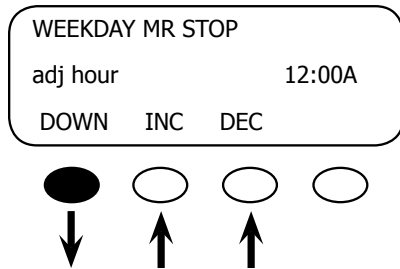

Adjust the hours using the **<INC>** and **<DEC>** soft keys. When finished, press the **<DOWN>** soft key to adjust the minutes.

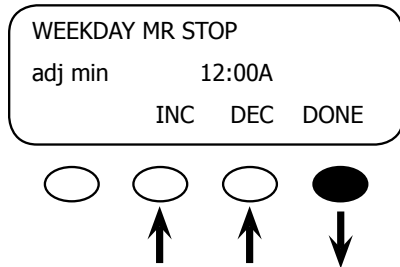

Adjust the minutes using the **<INC>** and **<DEC>** soft keys. When finished, press the **<DONE>** soft key to return to the ADV/MATE/AGS/MR *weekday must run stop time* screen.

## Weekend Start

ADV/MATE/AGS/MR-----	12:00A
weekday	
must run stop time	
DOWN	UP
	CHANGE

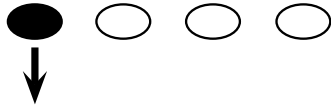

ADV/MATE/AGS/MR-----	12:00A
weekend	
must run start time	
DOWN	UP
	CHANGE

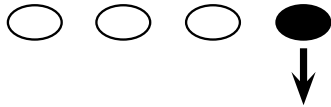

WEEKEND MR START			
adj hour			12:00A
DOWN	INC	DEC	

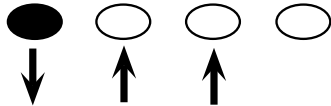

WEEKEND MR START			
adj min			12:00A
	INC	DEC	DONE

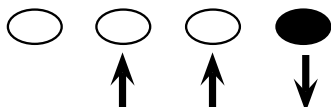

Press the **<DOWN>** soft key in the ADV/MATE/AGS/MR screen to adjust the *weekend must run start time*.

*weekend must run start time* is the beginning of the time period, Saturday and Sunday, that the generator will be forced to run. To adjust the *weekend must run start time*, press the **<CHANGE>** soft key.

Adjust the *weekend must run start time* hours using the **<INC>** and **<DEC>** soft keys. Press the **<DOWN>** soft key when finished.

Adjust the *weekend must run start* minutes using the **<INC>** and **<DEC>** soft keys. Press the **<DONE>** soft key to return to the ADV/MATE/AGS/MR *weekend must run stop time* screen when finished.

Weekend Stop

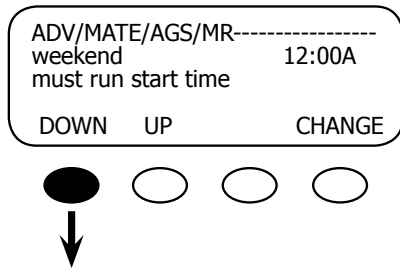

Press the <DOWN> soft key to go to the ADV/MATE/AGS/MR weekend must run stop screen.

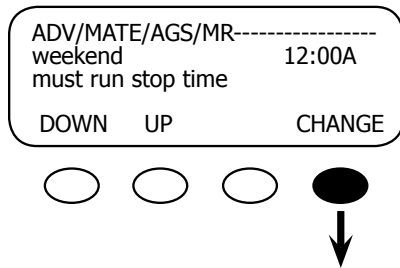

weekend must run stop time is the end of the must run time period for Saturday and Sunday. Press <CHANGE> to adjust the hour and minutes settings.

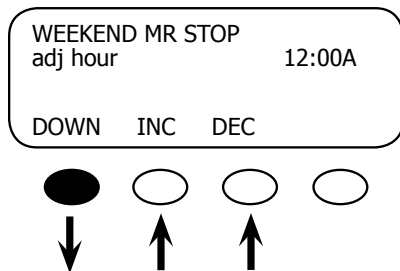

Adjust the hour settings using the <INC> and <DEC> soft keys. Press the <DOWN> soft key when finished to go to adj min screen to change the minutes.

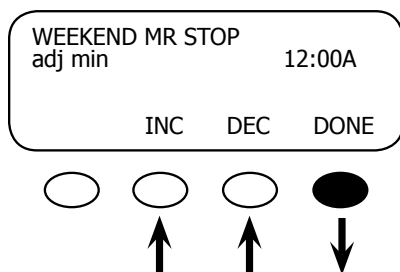

Adjust the minutes settings using the <INC> and <DEC> soft keys. When finished, press the <DONE> soft key to return to the ADV/MATE/AGS/MR weekend: must run stop time screen.

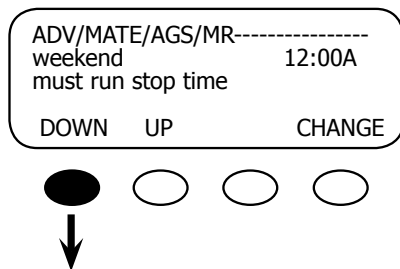

To proceed to the end of MUST RUN menu, press the <DOWN> soft key.

State of Charge

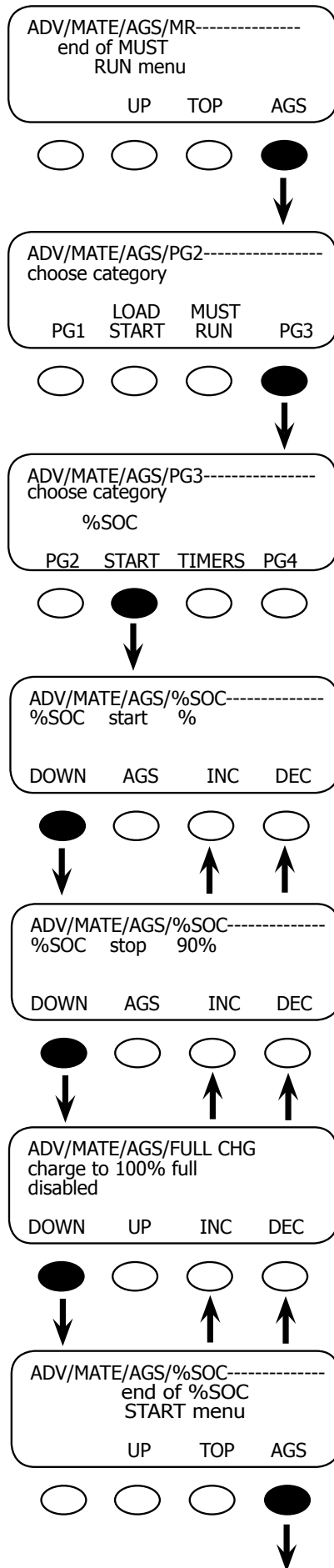

To proceed to the ADV/MATE/AGS/PG2 screen, press the <AGS> soft key

Press the <P3> soft key to access the ADV/MATE/AGS/PG3 screen which includes the EXERCISE option.

Press the <START> soft key.

With a FLEXnet DC, a user can start a generator based on a battery state of charge rather than its voltage, which can be less accurately interpreted depending on loads and surges. Use the <INC> and <DEC> soft keys to adjust this value. Press the <DOWN> soft key to view the %SOC stop screen.

A user can stop a generator based on the percentage of the battery's state of charge using <INC> and <DEC> soft keys. Press the <DOWN> soft key to view the FULL CHG screen.

The FULL CHG (CHARGE) screen overrides the %SOC stop function by establishing a time period from 1-30 days using the <INC> and <DEC> soft keys. When the FLEXnet DC measured days since a full charge exceeds this 1-30 day user-determined time, the %SOC stop is ignored and a full charge takes place. This screen function can be set to disabled as well (no full charge will occur). Press the <DOWN> soft key to view the end of %SOC START menu.

Press the <AGS> soft key to view the ADV/MATE/AGS/PG3 screen.

Timers

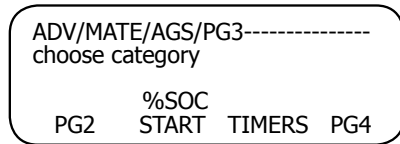

Press the <TIMERS> soft key to view the various AGS timer-related screens.

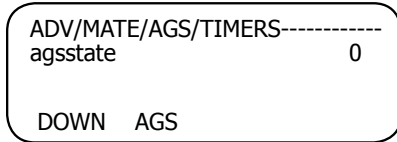

The *agsstate* screen displays a numeric value corresponding to why the generator is or is not running. This is a diagnostic feature for OutBack troubleshooting purposes. Press the <DOWN> soft key to view the next TIMER screen.

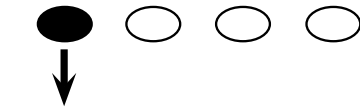

AGS state can be one or more of the following numbers:

- 128—Manual Start
- 64—Exercise
- 32—Time of Day
- 16—Load Start
- 8—Voltage 24 hr/2 hr
- 4—Voltage 2 min
- 2—State of Charge (SOC) Start

An AGS state of 128 means that AGS is active because of a manual start. More than one reason can be true at any one time (e.g., AGS state of 20 would be load start and 2 min voltage timer). The generator will be running any time AGS state is greater than 0.

See page 104 for a table of generator start and stop conditions.

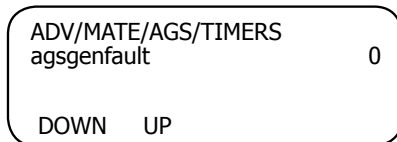

The *agsgenfault* screen displays three states:

- 0 or no generator fault
- 1 indicates the generator did not start and there is no AC input after five minutes
- 2 indicates the generator started, but then stopped (e.g., it ran out of fuel)

Press the <DOWN> soft key to proceed.

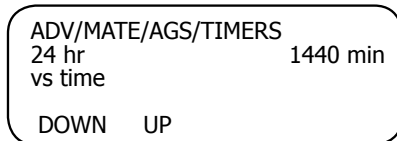

The *24 hr vs time* screen counts down the minutes, starting at 1440, of the 24-hour voltage start set point. After the battery voltage has fallen below its 24-hour set point, the timer starts and is displayed here. Pressing the <DOWN> soft key brings up the *2hr vs time* screen.

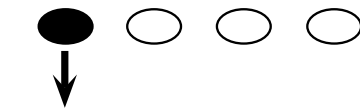

ADV/MATE/AGS/TIMERS  
2hr vs time 120 min  
DOWN UP

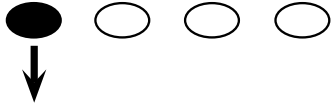

ADV/MATE/AGS/TIMERS  
2 min vs time 2 min  
DOWN UP

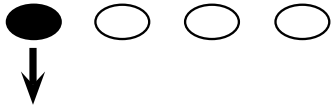

ADV/MATE/AGS/TIMERS  
lsstart timer 0 min  
DOWN UP

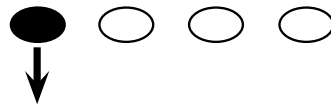

ADV/MATE/AGS/TIMERS  
lsstop timer 0 min  
DOWN UP

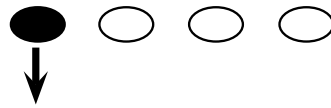

ADV/MATE/AGS/TIMERS  
vdcstop timer 0 min  
DOWN UP

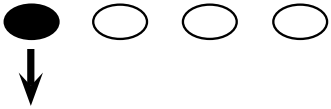

ADV/MATE/AGS/TIMERS  
exstop timer 0 min  
DOWN UP

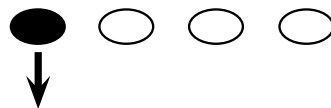

The *2hr vs time* 120 min screen counts down the 2-hour voltage start set point. Pressing the **<DOWN>** soft key leads to the *2 min vs time* screen.

The *2 min vs time* screen counts down the 2-minute voltage start set point. Pressing the **<DOWN>** soft key leads to the *lsstart timer* screen.

This screen displays the load start delay timer which is adjustable up to 240 minutes, counting down. The user determines how many minutes the AC loads must remain above the load start kw set point before starting the generator. Press the **<DOWN>** soft key to view the next TIMERS screen

The *lsstop timer* screen counts down the time the AC load must remain below the load stop kw before the generator stops. Press the **<DOWN>** soft key to view the *vdcstop timer* screen.

The *vdcstop timer* counts down the amount of time a DC generator is allowed to run. Press the **<DOWN>** soft key to view the last TIMERS screen.

The *exstop timer* screen displays the amount of time the generator runs during an exercise period (1-240 minutes). Press the **<DOWN>** soft key to open the end of TIMERS screen.

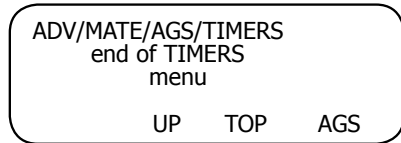

This is the final TIMERS screen. Press the <AGS> soft key to view the final AGS screen.

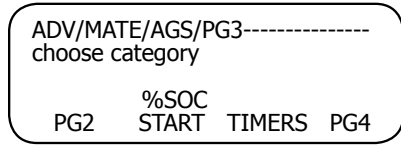

Press the <PG4> soft key

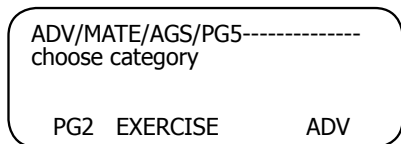

Press the <EXERCISE> soft key.

This takes you to the ADV/MATE/AGS/EX (exercise) screen for running a lightly used generator at least one day a month to assure it's in good working order (see next section).

## Generator Exercise

*Why you might want it:* Exercising a generator prolongs its life and dependability.

Regularly running a generator keeps engine components lubricated, expels excess moisture, charges the starting battery, and helps prevent carbon build-up. Consult your generator owner's manual to find the manufacturer's recommendations for appropriate length and frequency of exercise periods and what load to run during the exercise periods.

An Exercise time can be set by choosing a day of the week (Sun – Sat), a start time of day (12AM – 11:59PM), and an exercise period (1 – 240 minutes). The generator will run once a month at this chosen time during the first occurrence of the chosen day.

**Sample Generator Exercise Schedule**

Day: Saturday  
 Time: 10:00 a.m.  
 Exercise Period: 15 minutes

A fifteen minute exercise period with loads running is a good starting point for most generators.



### Exercise Start Day (exstartday)

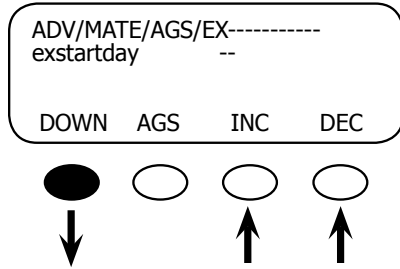

Use the <INC> or <DEC> soft keys to choose the day (Sunday-Saturday) of the week to exercise the generator. To disable the exercise function, push either the <INC> or <DEC> soft keys until a broken line (--) appears. Press the <DOWN> soft key to go to the *ex start time* screen which sets the exercise start time.

### Ex Start Time

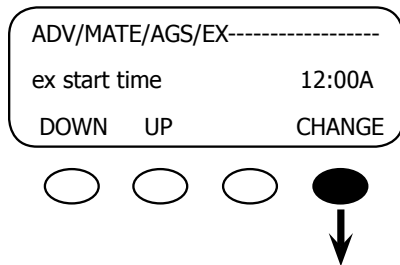

This setting controls the daily exercise start time. Press the <CHANGE> soft key to adjust the hour and minute settings using the <INC> and <DEC> soft keys on the hour and minute screens.

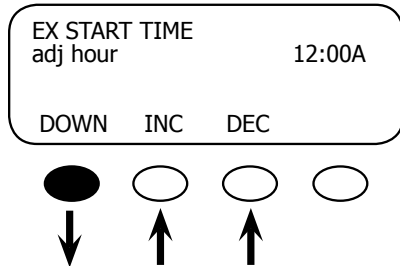

After adjusting the exercise start time hour, press the <DOWN> soft key and go to the *adj min* screen.

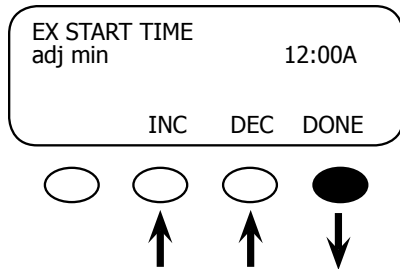

Adjust the minutes and then press the <DONE> soft key to return to the ADV/MATE/AGS/EX *ex start time* screen

Ex Period

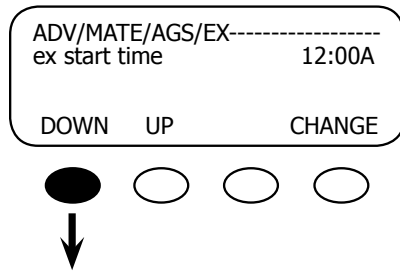

Press the <DOWN> soft key. This takes you to the ADV/MATE/AGS/EX *ex period* screen, which allows you to set the number of minutes your generator will run during its exercise period.

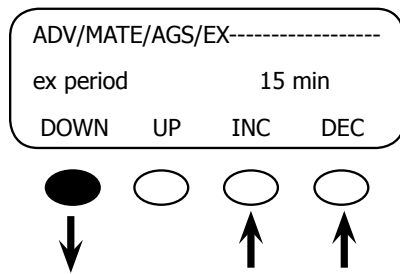

The exercise period screen allows you to set the length of the exercise period using the <INC> and <DEC> soft keys. The MATE offers a range of 1-240 minutes for this period, but check your generator manufacturer's recommendations before setting this period. Press the <DOWN> soft key to exit this screen and go to the ADV/MATE/AGS/EX *end of exercise menu* screen.

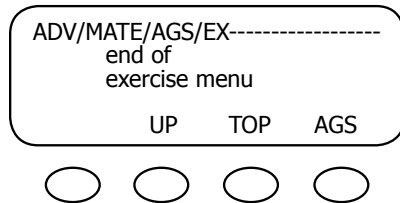

## MATE DEFAULTS

The MATE comes with factory default settings for its various functions. Many of these can be changed depending on a user's preferences. To return the MATE to its default settings, go to the ADV/MATE/DEFAULT screen and press the <RESET> soft key. Press the <YES> soft key in the ADV/MATE/RESET ARE YOU SURE? screen to reset the default values.

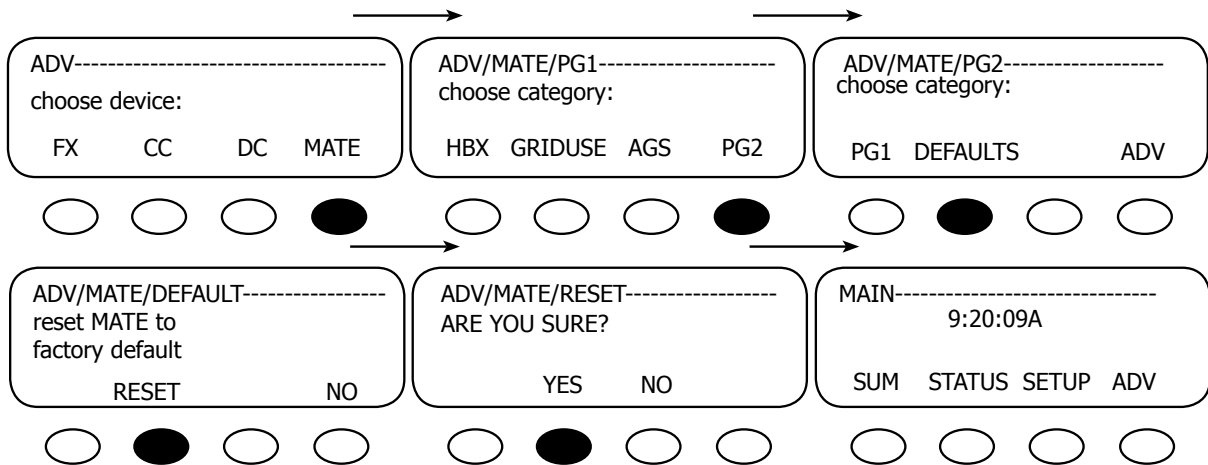

## MATE SETUP Default Values

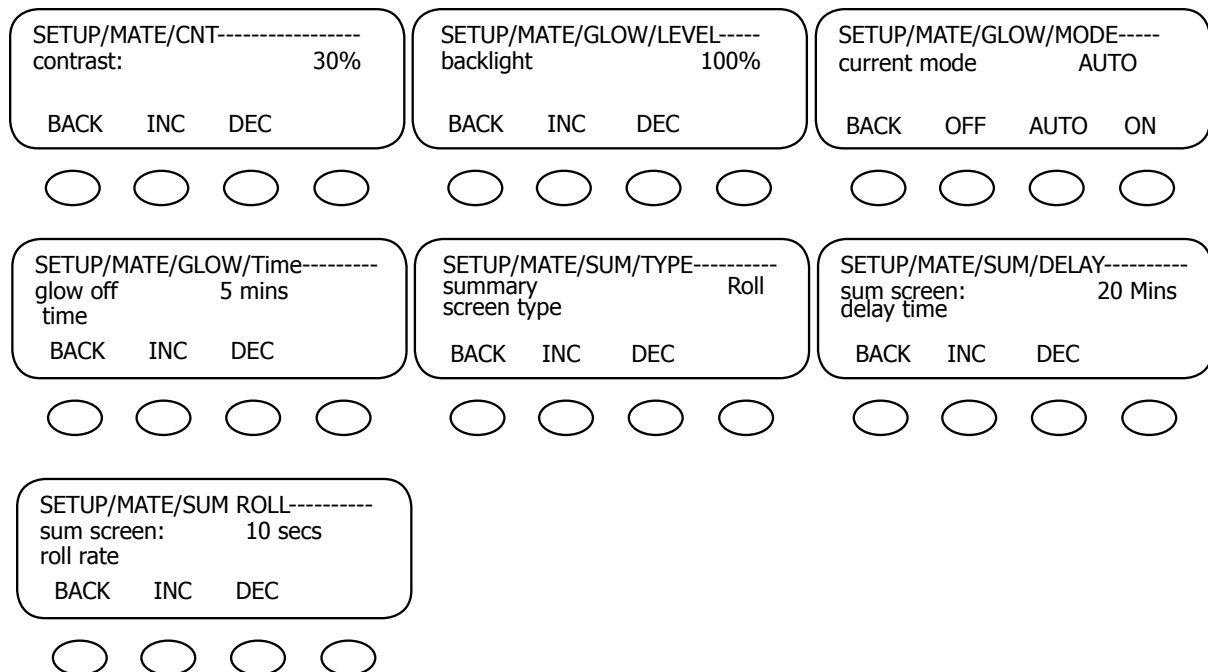

## MATE ADVANCED Default Values

### • HBX Menu

ADV/MATE/HBX----- hbx-use 12.0 vdc grid setpoint DOWN ADV INC DEC ○ ○ ○ ○	ADV/MATE/HBX----- hbx-use 1.0 hrs grid delay DOWN ADV INC DEC ○ ○ ○ ○	ADV/MATE/HBX----- hbx-drop 13.0 vdc grid setpoint DOWN ADV INC DEC ○ ○ ○ ○
ADV/MATE/HBX----- hbx-drop 1.0 hrs grid delay DOWN ADV INC DEC ○ ○ ○ ○	ADV/MATE/HBX----- ac input USE control DOWN UP CHANGE ○ ○ ○ ○	NOTE: The MATE's <i>hbx-use</i> grid setpoint screen vdc value will equal the system's battery voltage. In this case, it reflects 12 VDC batteries. Other values: 24VDC battery—26.0 vdc; 32VDC—34.7 vdc; 36VDC—39.0 vdc; and 48VDC—52 vdc.

### • Griduse Menu

ADV/MATE/GRIDUSE----- griduse enable: OFF DOWN ADV OFF ON ○ ○ ○ ○	ADV/MATE/GRIDUSE----- weekday 12:00A griduse start time DOWN UP CHANGE ○ ○ ○ ○	ADV/MATE/GRIDUSE----- weekday 12:00A griduse stop time DOWN UP CHANGE ○ ○ ○ ○
ADV/MATE/GRIDUSE----- weekend 12:00A griduse start time DOWN UP CHANGE ○ ○ ○ ○	ADV/MATE/GRIDUSE----- weekend 12:00A griduse stop time DOWN UP CHANGE ○ ○ ○ ○	

### • AGS SETUP Menu

MATE/AGS/SETUP----- ags port: 0 DOWN AGS INC DEC ○ ○ ○ ○	ADV/MATE/AGS/SETUP----- AGS enabled: No DOWN UP NO YES ○ ○ ○ ○	ADV/MATE/AGS/SETUP----- AGS control: MAN-OFF DOWN UP CHANGE ○ ○ ○ ○
ADV/MATE/AGS/SETUP----- dc genset:: No DOWN UP NO YES ○ ○ ○ ○	ADV/MATE/AGS/SETUP----- vdc genstop 19.0 vdc DOWN UP INC DEC ○ ○ ○ ○	ADV/MATE/AGS/SETUP----- ags fault 17 min time DOWN UP INC DEC ○ ○ ○ ○
ADV/MATE/AGS/SETUP----- cool down time 0 minutes DOWN UP INC DEC ○ ○ ○ ○	ADV/MATE/AGS/SETUP----- warm up time 0 minutes DOWN UP INC DEC ○ ○ ○ ○	

• AGS QUIET TIME Menu

ADV/MATE/AGS/QT----- weekday 12:00A quiet time start DOWN AGS CHANGE	ADV/MATE/AGS/QT----- weekday 12:00A quiet time stop DOWN UP CHANGE	ADV/MATE/AGS/QT----- weekend 12:00A quiet time start DOWN UP CHANGE
<input type="radio"/> <input type="radio"/> <input type="radio"/> <input type="radio"/>	<input type="radio"/> <input type="radio"/> <input type="radio"/> <input type="radio"/>	<input type="radio"/> <input type="radio"/> <input type="radio"/> <input type="radio"/>
ADV/MATE/AGS/QT----- weekend 12:00A quiet time stop DOWN UP CHANGE		
<input type="radio"/> <input type="radio"/> <input type="radio"/> <input type="radio"/>		

• AGS VOLT START Menu

ADV/MATE/AGS/VSTART----- volt start 12.2 vdc 24 hr setting DOWN AGS INC DEC	ADV/MATE/AGS/VSTART----- volt start 11.8 vdc 2 hr setting DOWN AGS INC DEC	ADV/MATE/AGS/VSTART----- volt start 11.0 vdc 2 min setting DOWN AGS INC DEC
<input type="radio"/> <input type="radio"/> <input type="radio"/> <input type="radio"/>	<input type="radio"/> <input type="radio"/> <input type="radio"/> <input type="radio"/>	<input type="radio"/> <input type="radio"/> <input type="radio"/> <input type="radio"/>
Volt start 24 hr setting: 24 VDC system = 24.4 vdc 32 VDC system = 32.6 vdc 36 VDC system = 36.6 vdc 48 VDS system = 48.8 vdc	Volt start 2 hr setting: 24 VDC system = 23.6 vdc 32 VDC system = 31.5 vdc 36 VDC system = 35.4 vdc 48 VDS system = 47.2 vdc	Volt start 2 min setting: 24 VDC system = 22.0 vdc 32 VDC system = 29.3 vdc 36 VDC system = 33.0 vdc 48 VDS system = 44.0 vdc

• AGS LOAD START Menu

ADV/MATE/AGS/LS----- load start 0 kw DOWN AGS INC DEC	ADV/MATE/AGS/LS----- load start delay 1 min DOWN AGS INC DEC	ADV/MATE/AGS/LS----- load stop 0 kw DOWN AGS INC DEC
<input type="radio"/> <input type="radio"/> <input type="radio"/> <input type="radio"/>	<input type="radio"/> <input type="radio"/> <input type="radio"/> <input type="radio"/>	<input type="radio"/> <input type="radio"/> <input type="radio"/> <input type="radio"/>
ADV/MATE/AGS/LS----- load stop delay 1 min DOWN AGS INC DEC		
<input type="radio"/> <input type="radio"/> <input type="radio"/> <input type="radio"/>		

• AGS MUST RUN Menu

ADV/MATE/AGS/MR----- weekday 12:00A must run start time DOWN AGS CHANGE <input type="radio"/> <input type="radio"/> <input type="radio"/> <input type="radio"/>	ADV/MATE/AGS/MR----- weekday 12:00A must run stop time DOWN UP CHANGE <input type="radio"/> <input type="radio"/> <input type="radio"/> <input type="radio"/>	ADV/MATE/AGS/MR----- weekend 12:00A must run start time DOWN UP CHANGE <input type="radio"/> <input type="radio"/> <input type="radio"/> <input type="radio"/>
ADV/MATE/AGS/MR----- weekend 12:00A must run stop time DOWN UP CHANGE <input type="radio"/> <input type="radio"/> <input type="radio"/> <input type="radio"/>		

• AGS %SOC Menu

ADV/MATE/AGS/%SOC----- %SOC start 0% must run start time DOWN AGS INC DEC <input type="radio"/> <input type="radio"/> <input type="radio"/> <input type="radio"/>	ADV/MATE/AGS/%SOC----- %SOC stop 90% must run start time DOWN AGS INC DEC <input type="radio"/> <input type="radio"/> <input type="radio"/> <input type="radio"/>	ADV/MATE/AGS/FULLCHG charge to 100% full every 15 days DOWN UP INC DEC <input type="radio"/> <input type="radio"/> <input type="radio"/> <input type="radio"/>
---	---	--

• AGS TIMERS Menu

ADV/MATE/AGS/TIMERS agsstate 0 DOWN AGS <input type="radio"/> <input type="radio"/> <input type="radio"/> <input type="radio"/>	ADV/MATE/AGS/TIMERS agsgenfault 0 DOWN UP <input type="radio"/> <input type="radio"/> <input type="radio"/> <input type="radio"/>	ADV/MATE/AGS/TIMERS 24hr 1440 min vs time DOWN UP <input type="radio"/> <input type="radio"/> <input type="radio"/> <input type="radio"/>
ADV/MATE/AGS/TIMERS 24hr vs time 120 min DOWN UP <input type="radio"/> <input type="radio"/> <input type="radio"/> <input type="radio"/>	ADV/MATE/AGS/TIMERS 2 min 2 min vs time DOWN UP <input type="radio"/> <input type="radio"/> <input type="radio"/> <input type="radio"/>	ADV/MATE/AGS/TIMERS 1sstart timer 0 min DOWN UP <input type="radio"/> <input type="radio"/> <input type="radio"/> <input type="radio"/>
ADV/MATE/AGS/TIMERS 1sstop timer 0 min DOWN AGS <input type="radio"/> <input type="radio"/> <input type="radio"/> <input type="radio"/>	ADV/MATE/AGS/TIMERS vdcstop timer 0 min DOWN UP <input type="radio"/> <input type="radio"/> <input type="radio"/> <input type="radio"/>	ADV/MATE/AGS/TIMERS exstop timer 0 min DOWN UP <input type="radio"/> <input type="radio"/> <input type="radio"/> <input type="radio"/>

• AGS EXERCISE Menu

ADV/MATE/AGS/EX----- exstartday ---- DOWN AGS INC DEC <input type="radio"/> <input type="radio"/> <input type="radio"/> <input type="radio"/>	ADV/MATE/AGS/EX----- ex start time 12:00A DOWN UP CHANGE <input type="radio"/> <input type="radio"/> <input type="radio"/> <input type="radio"/>	ADV/MATE/AGS/EX----- ex period 15 min DOWN UP INC DEC <input type="radio"/> <input type="radio"/> <input type="radio"/> <input type="radio"/>
--	---	--

## AGS Start and Stop

AGS state can be one or more of the following numbers:

- 128—Manual Start
- 64—Exercise
- 32—Time of Day
- 16—Load Start
- 8—Voltage 24 hr/2 hr
- 4—Voltage 2 min
- 2—State of Charge (SOC) % Start

### GENERATOR START REASON

AGS State		Global Rebulk*
4	2 Min Batt V	Yes
8	2 hour Batt V	Yes
8	24 Hour Batt V	Yes
2	Start SOC %	Yes
16	Load kW	
64	Exercise	
32	Must Run Start	Yes
128	Manual Start	

\*1 Causes GTFX to start a full bulk charge

### GENERATOR STOP REASON

AGS State	FX in Float or Silent	End SOC %	Below Load kW	Quiet Time	Exercise Time Expires	Manual Stop	High Batt Voltage	Must Run Stop
4	Stop	Charge Parameters Met				Stop	Stop	
8	Stop	Stop		Stop		Stop	Stop	
8	Stop	Stop		Stop		Stop	Stop	
2	Stop	Stop		Stop		Stop	Stop	
16			Stop	Stop		Stop		
64				Stop	Stop	Stop		
32				Stop		Stop		Stop
128						Stop		

# 8 MATE Menu Map



## Menu Structure

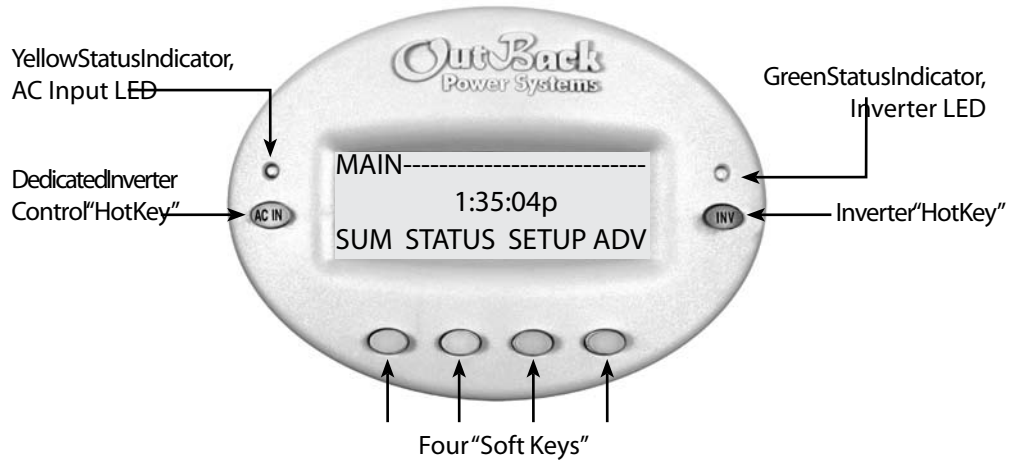

The menu system displayed on the MATE will vary depending on the software version the MATE was programmed with at the time of manufacturing or during its last software upgrade.

The OutBack MATE uses a branching menu structure which:

- Shows various OutBack products' operation modes and status
- Displays by product type
- Categorizes by the type of settings or information being displayed

The following menus show an example of this menu structure. In this example, all the screens that show FX connected batteries are grouped together in one menu tree allowing the user to find the required meter with a minimum of button presses.

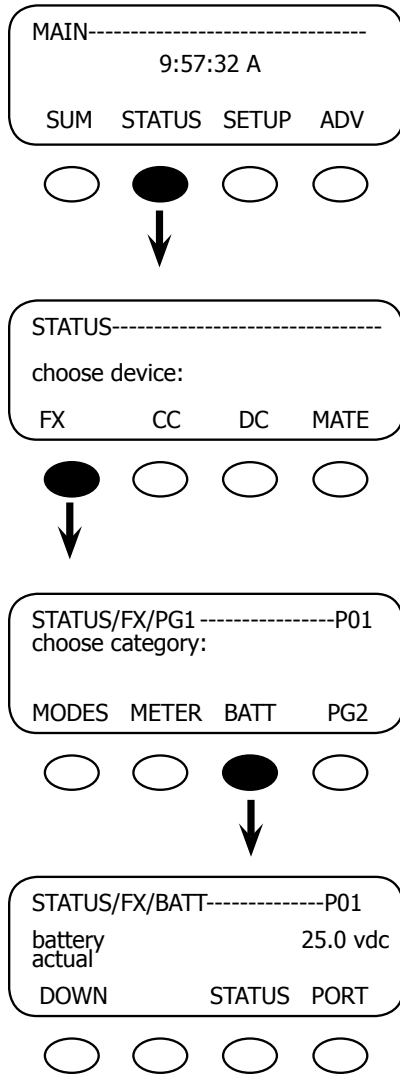

The top line of the MATE display will show the 'path' to the current menu; in this example it is STATUS/FX/BATT-----P01 with "P01" referring to the first port of the HUB.

The MATE features over 400 screens for viewing power system status and adjusting its values. The screens are accessible in a series of categorized menus (for example, METERS, WARNING, BATTERY, etc.). By knowing the categories, it's easier to find a specific screen. Screens display locations within the system, values and set points, some of which can be changed using <DEC> and <INC> commands; ports, to which components are connected; on/off and yes/no options; and initiating or stopping certain functions and activities. The following menu guide offers quick access to the MATE screens.

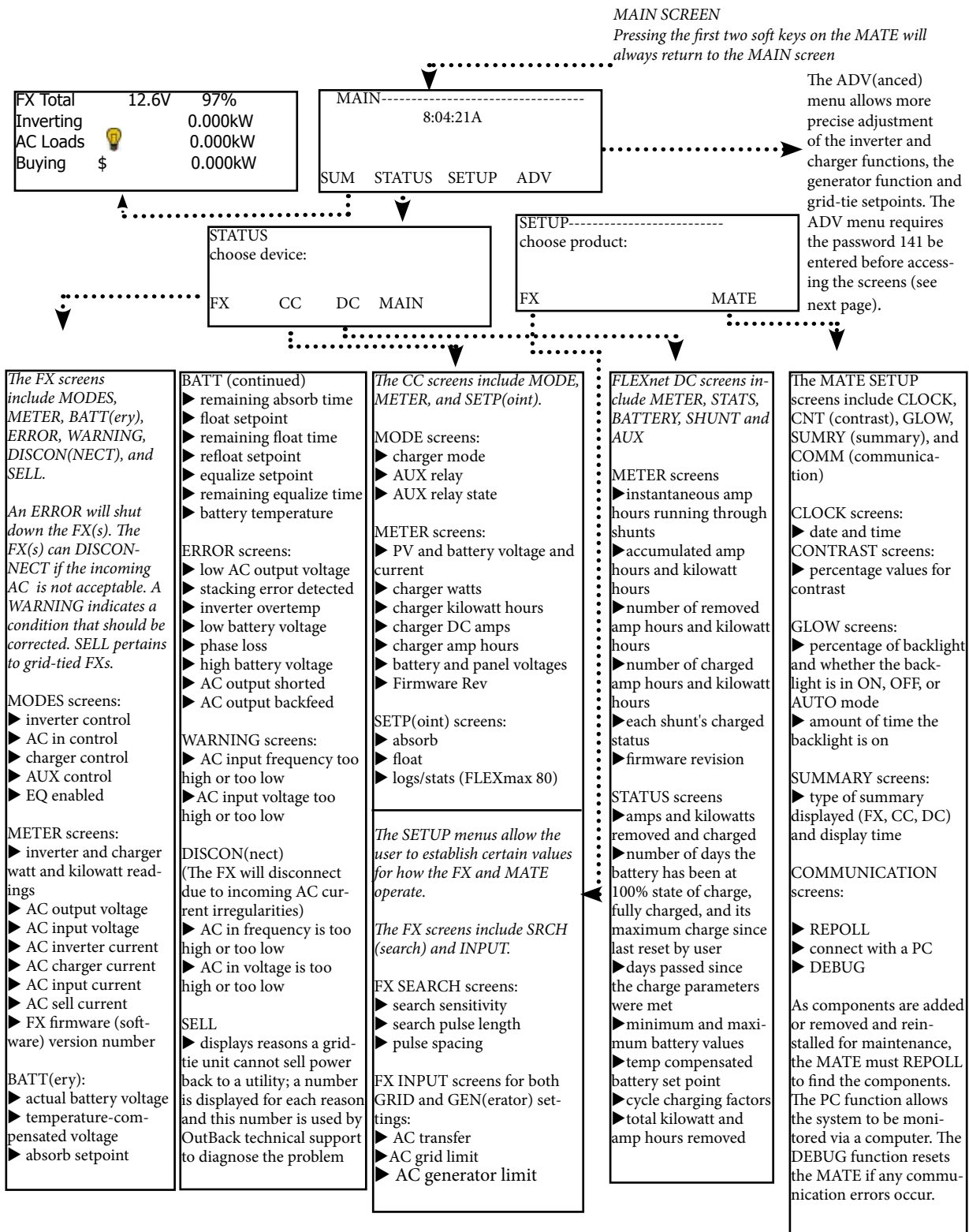

Before entering the ADVANCED screens, a warning message appears. Any changes can always be undone, different values entered, or the MATE can be returned to its factory default settings.

```

ADV/SETTINGS/WARNING
changes made could
adversely effect
system performance
  
```

The ADV(anced) menu allows a user to more precisely adjust the inverter and charger functions as well as the generator function and grid-tie set-points. The ADV menu is password-protected requiring the password 141 be entered before accessing the screens.

After pressing the <INC> soft key until the password number 141 appears, the advanced screens for the FX, Charge Controller, and MATE become available.

```

ADV/PASSWORD
enter the password
141
ENTER INC DEC EXIT
  
```

```

ADV-----
choose product
FX      CC      DC      MATE
  
```

The advanced FX screens include:

- ▶ FX search sensitivity, pulse length, and pulse spacing
- ▶ low battery cut-off and cut-in set points
- ▶ adjustments to the output voltage
- ▶ charger limits
- ▶ absorb, float, refloat, and equalize settings
- ▶ resetting the FX to factory defaults
- ▶ AC grid usage and limits
- ▶ generator usage and limits
- ▶ AUX functions, including genalert, loadshed, vent fan, and diversion functions
- ▶ FX stacking
- ▶ selling voltage and grid tie settings
- ▶ VAC and VDC calibrations

The advanced MATE screens include:

- ▶ HBX grid use and drop setpoints and delays, AC input control
- ▶ GRIDUSE weekday and weekend start and stop times
- ▶ AGS or advanced generator start functions such as SETUP, QUIET TIME, VOLT START, LOAD START, MUST RUN, %SOC, TIMERS, AND EXERCISE
- ▶ resetting the MATE2M to factory default values

The advanced CC screens include:

- ▶ AUX output function
- ▶ AUX output control
- ▶ programming of both the FLEXmax60 and FLEXmax 80 Charge Controllers

The advanced FLEXnet DC screens include:

- ▶ battery bank capacity
- ▶ enable or disable shunts
- ▶ establish the end of charge amps, end of charge voltage, and amount of time the charge parameters must be met
- ▶ AUX functions
- ▶ resetting to factory default and clearing the data log

# MATE MENUS

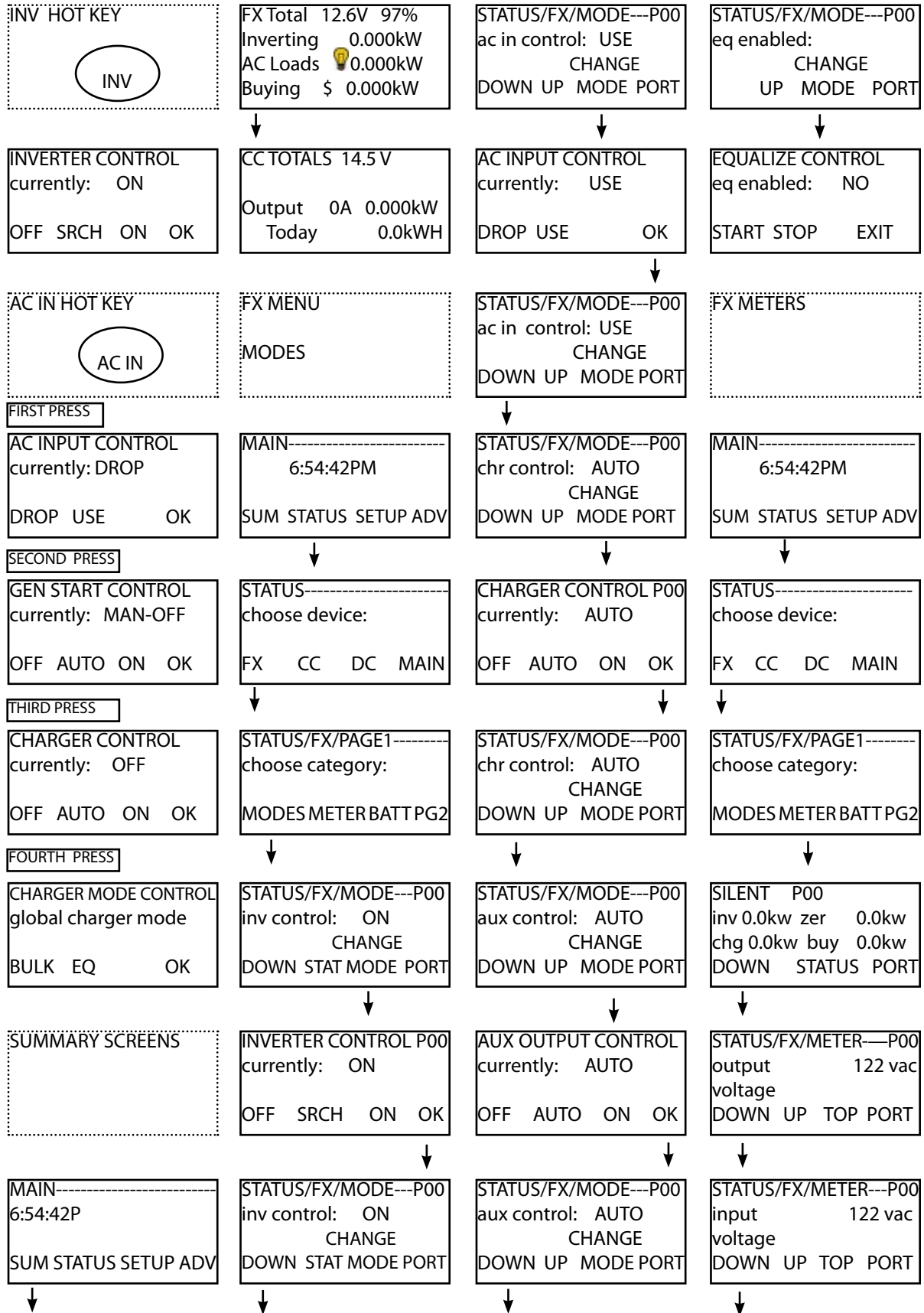

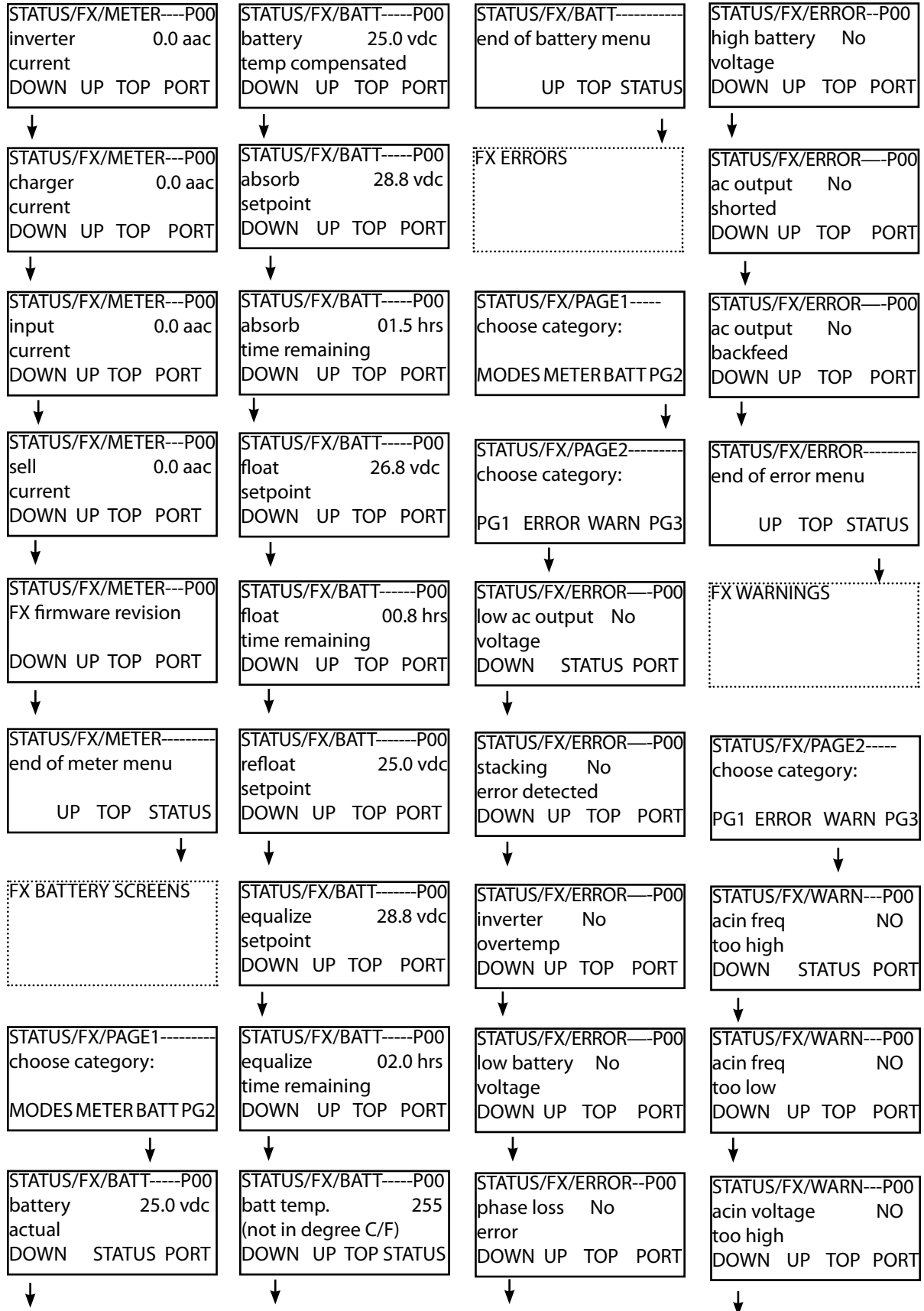

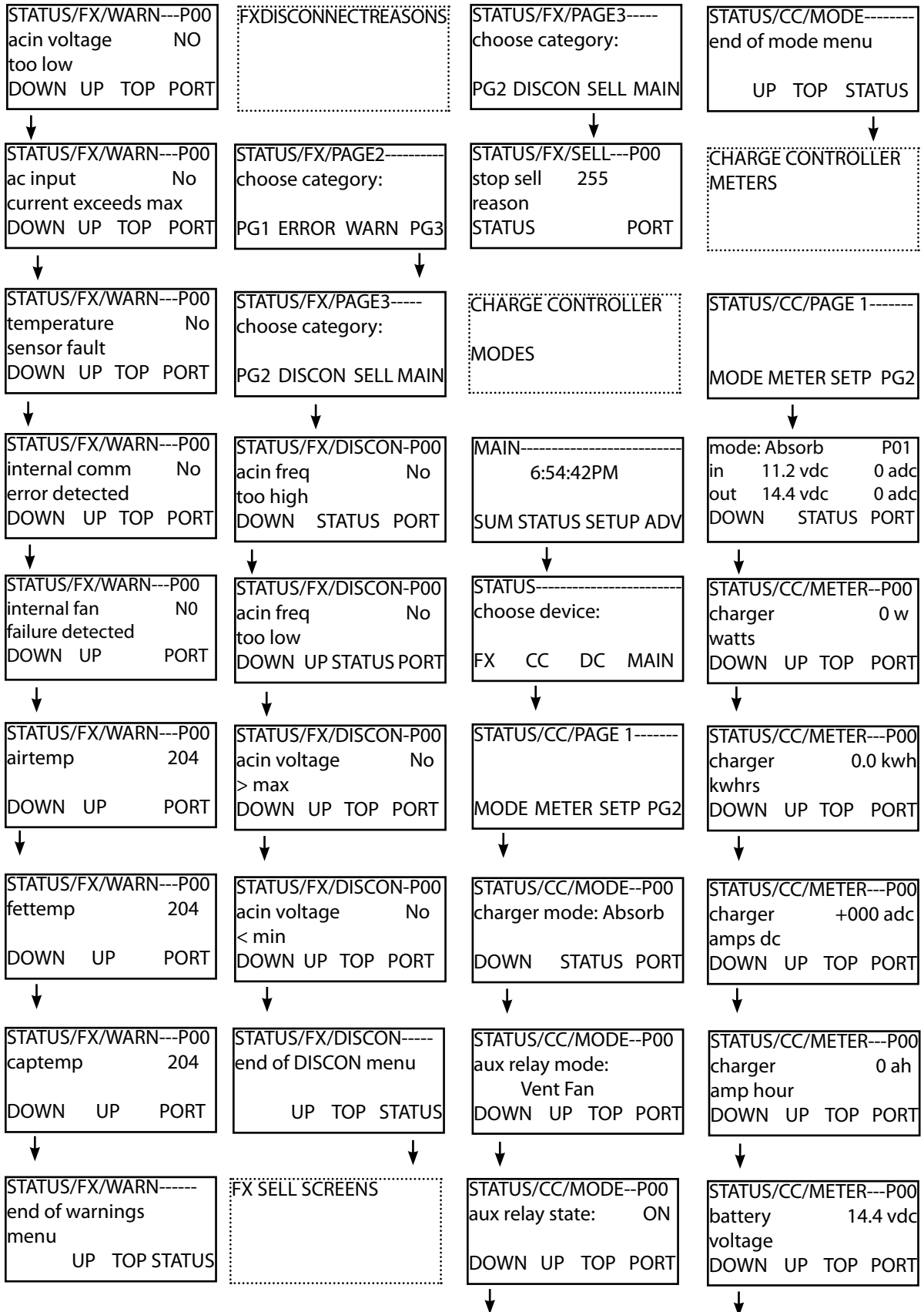







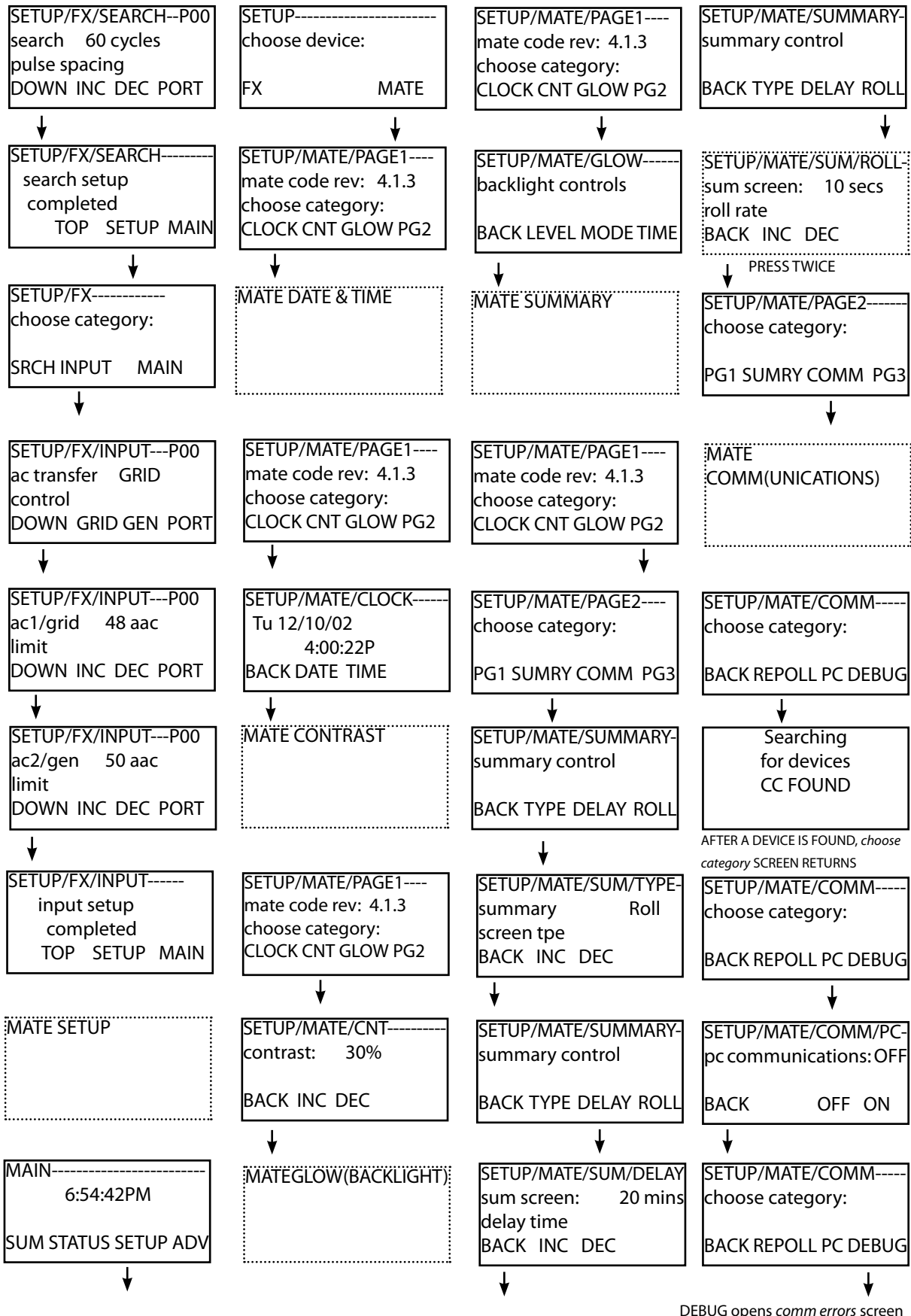

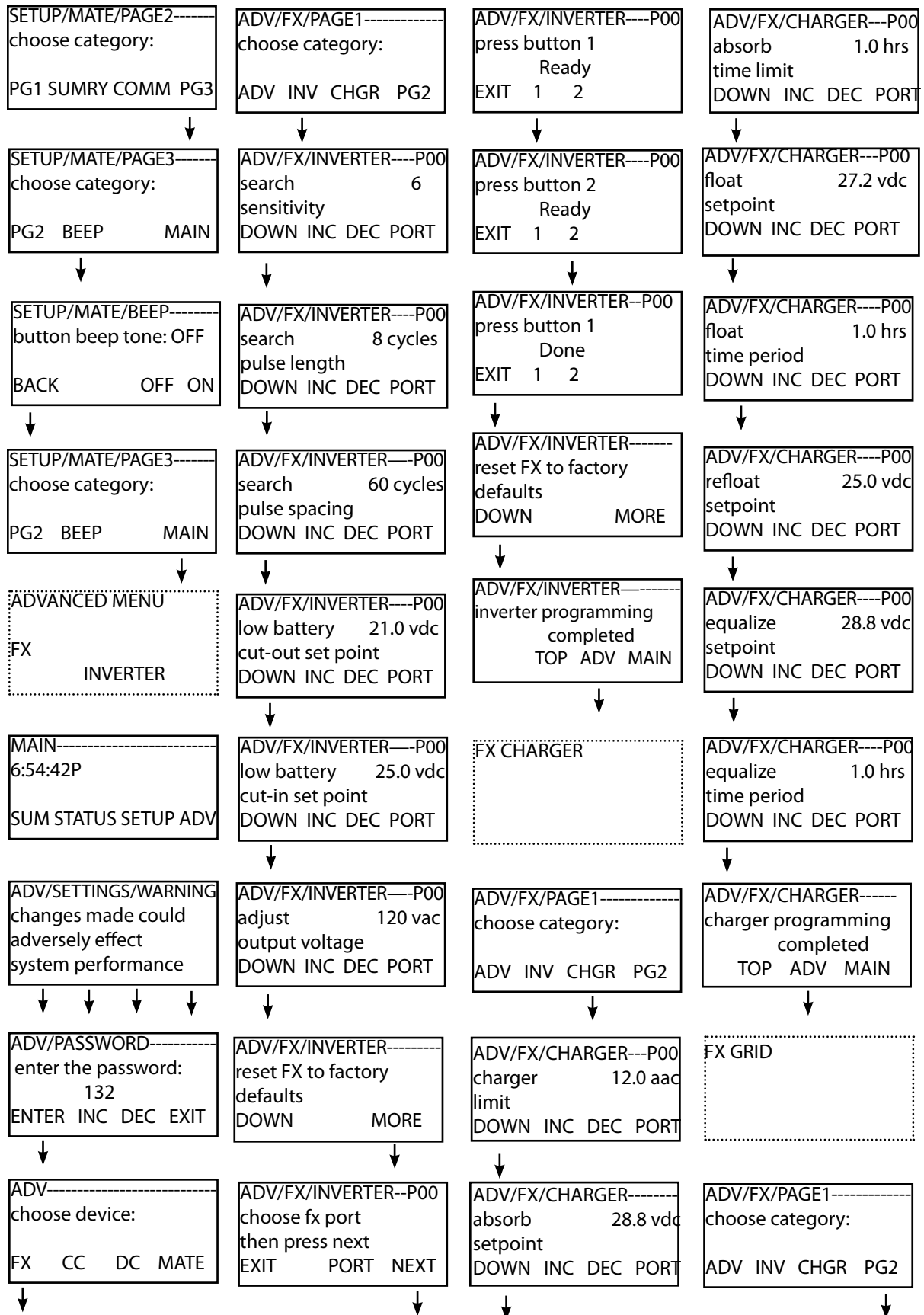

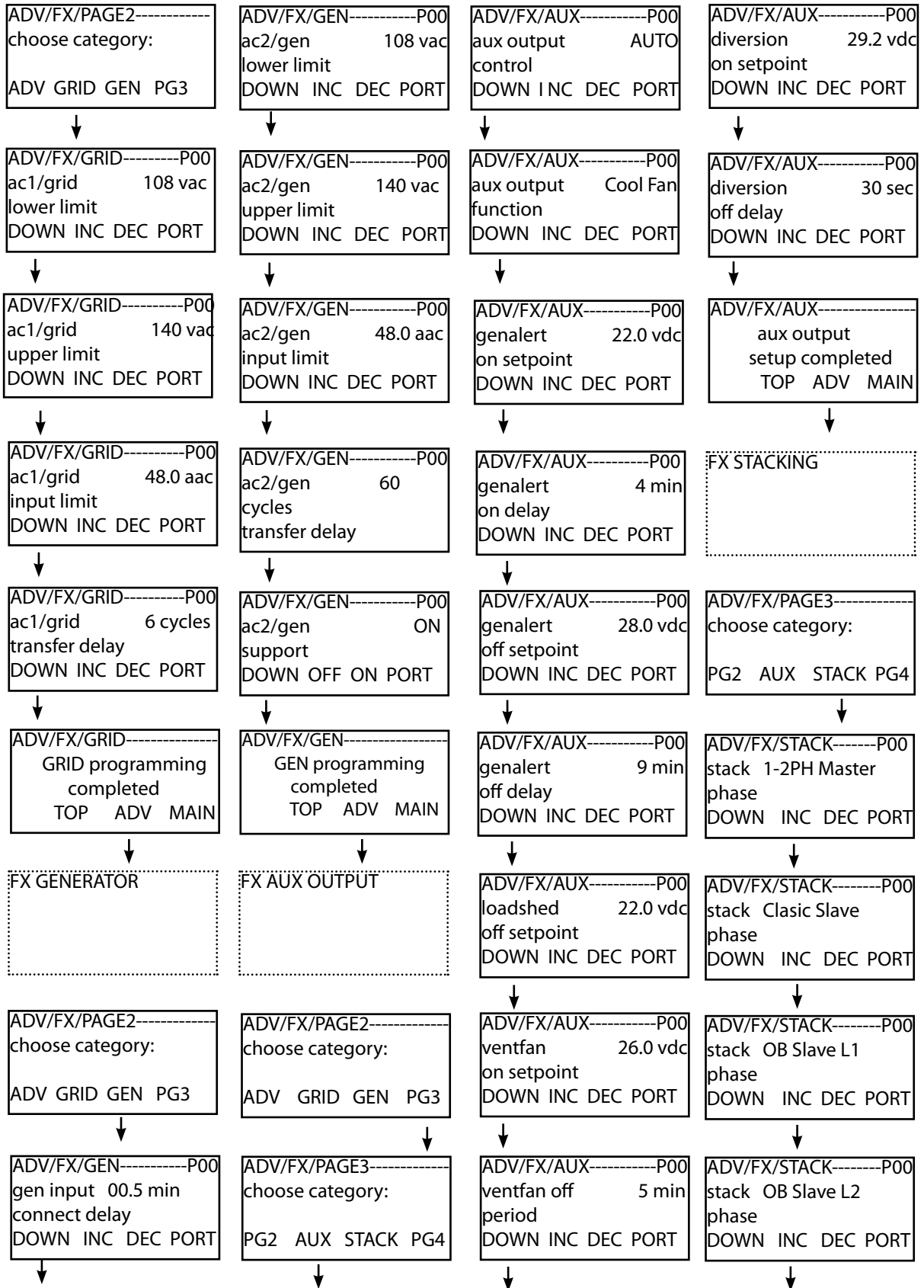

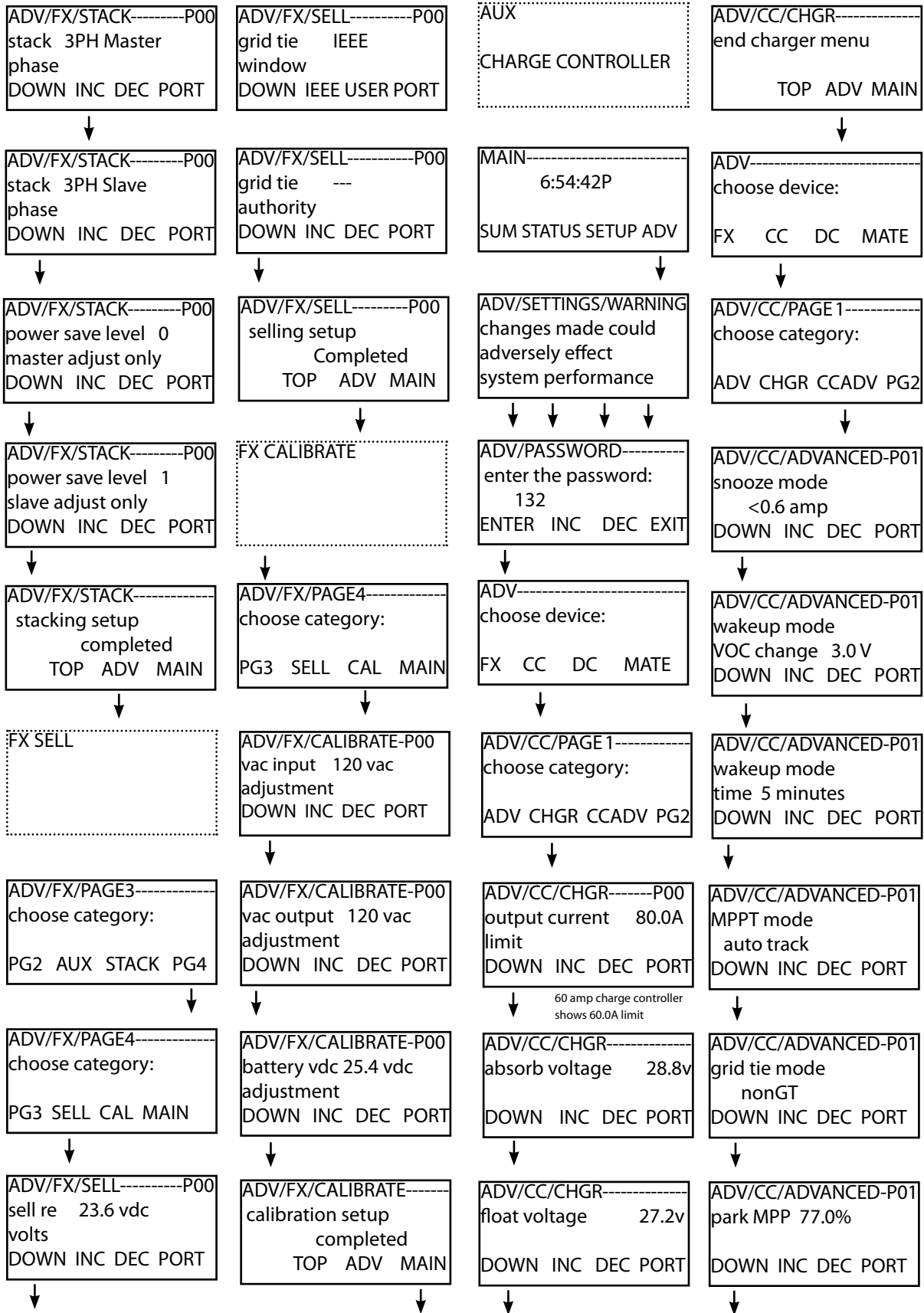

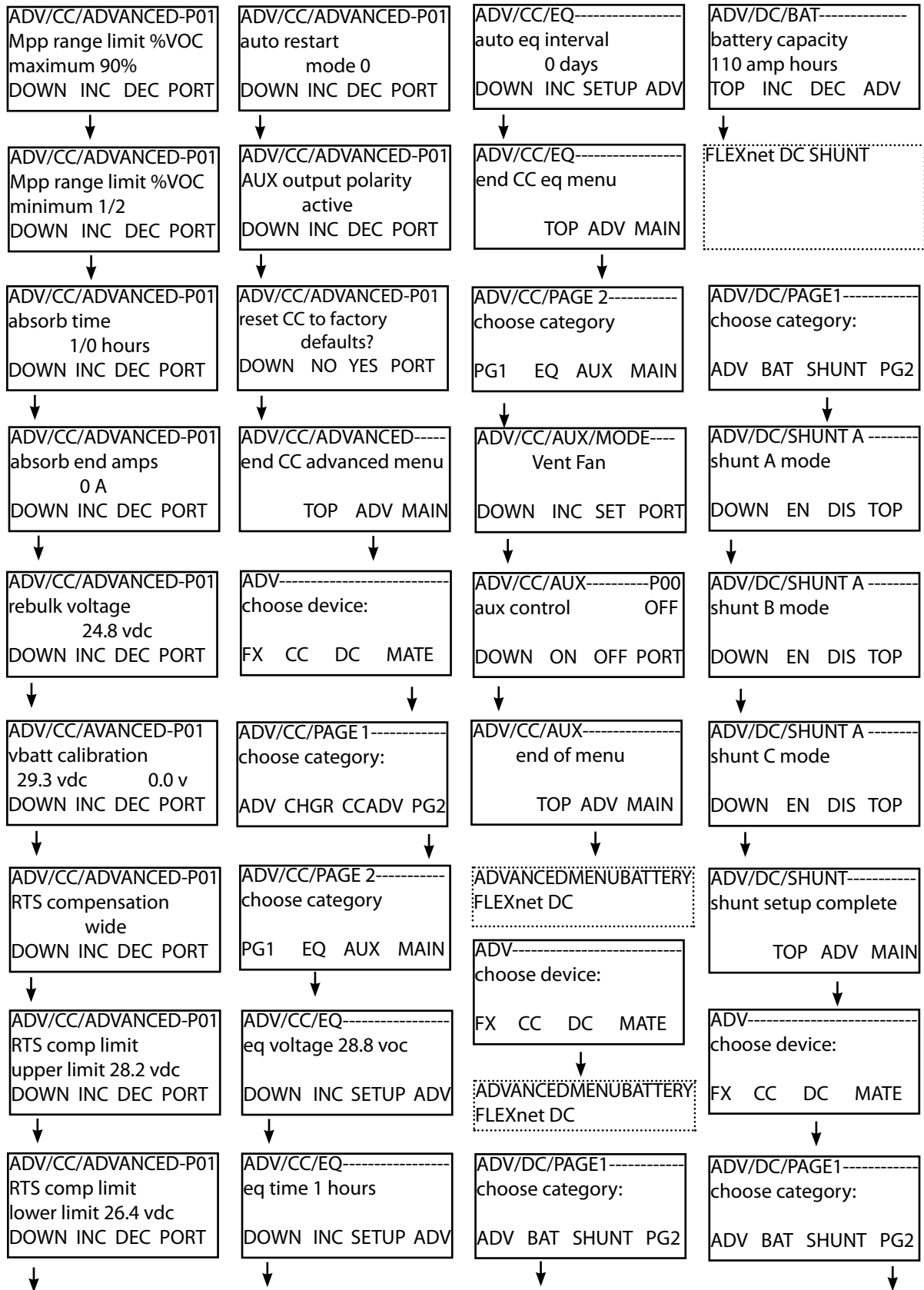

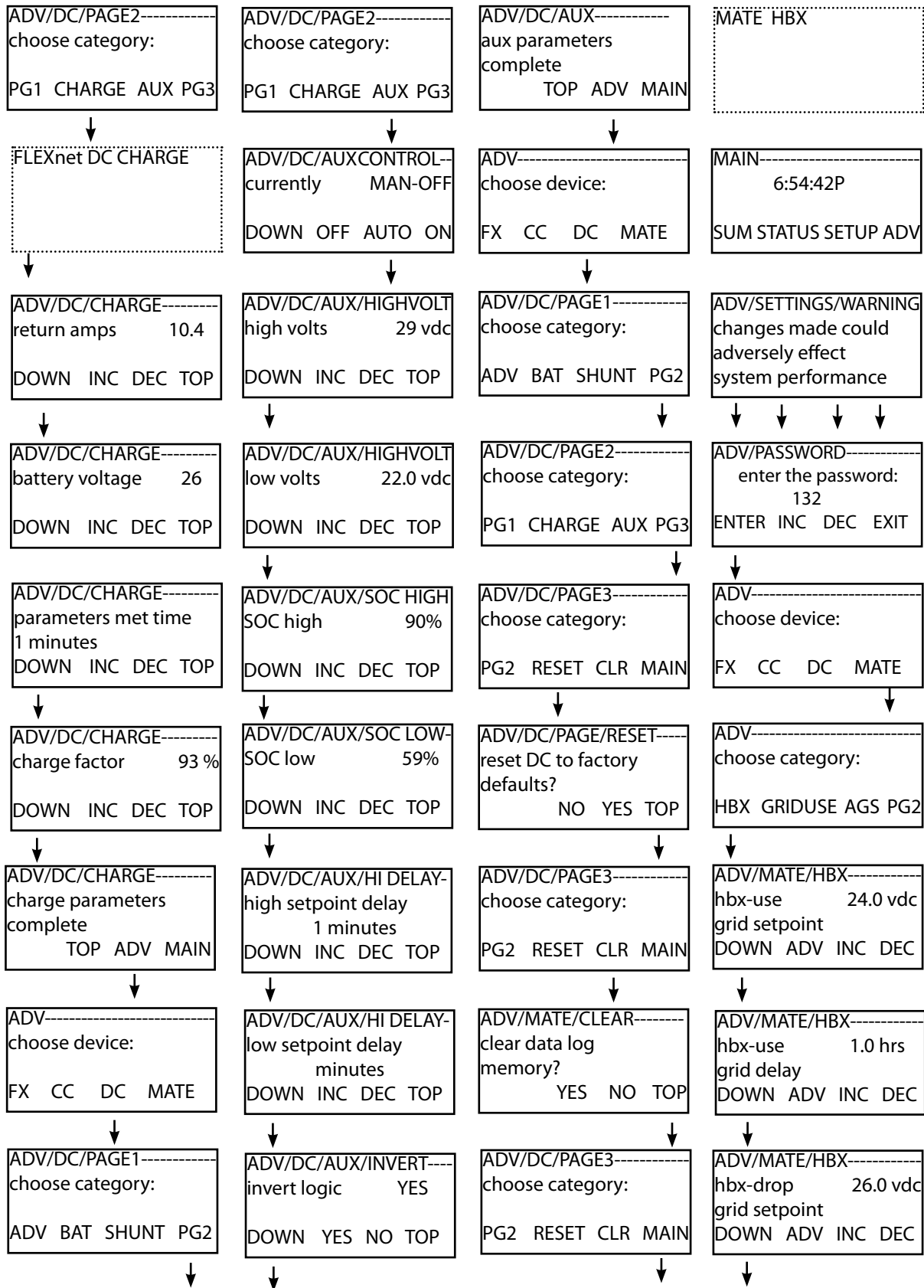

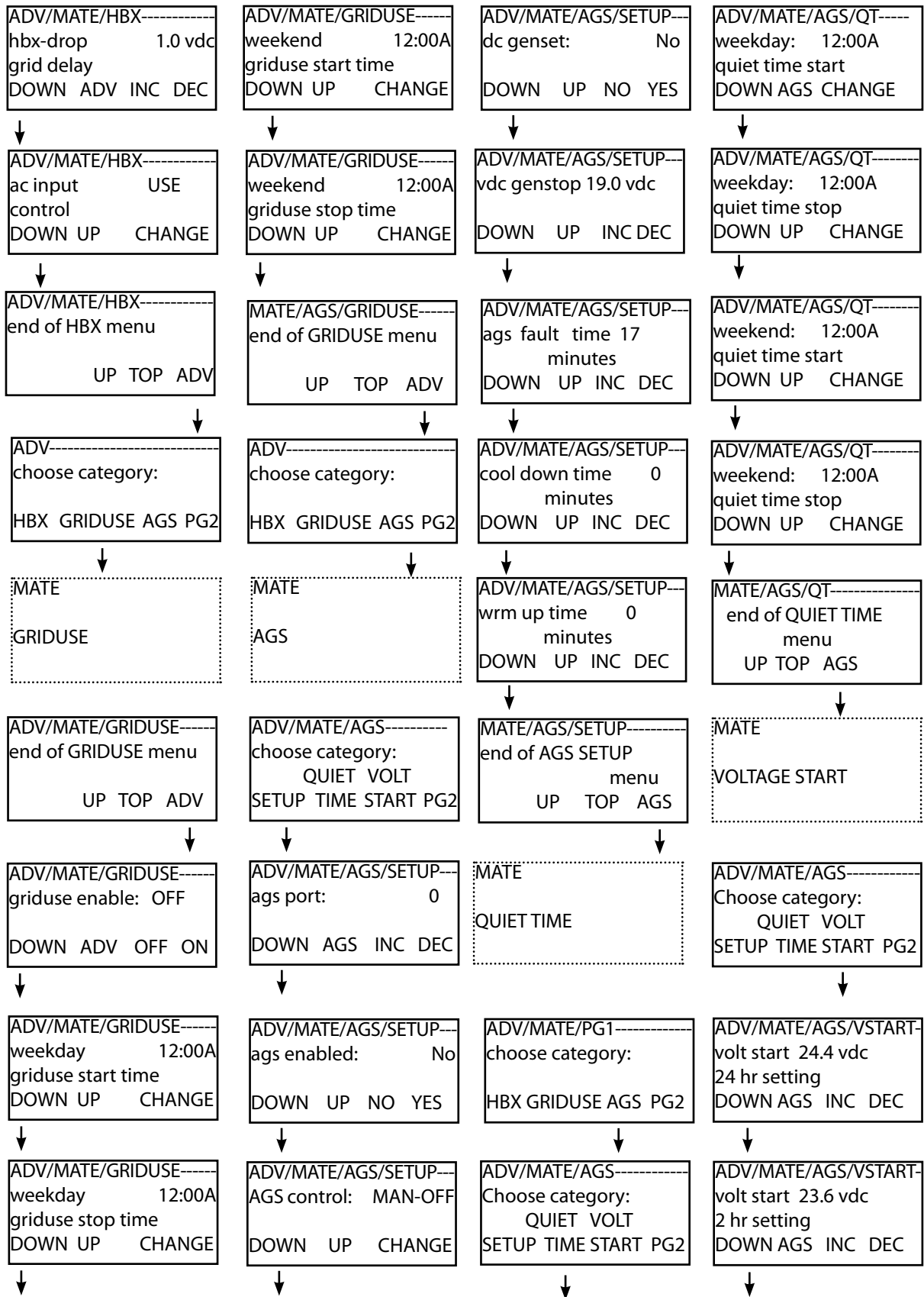



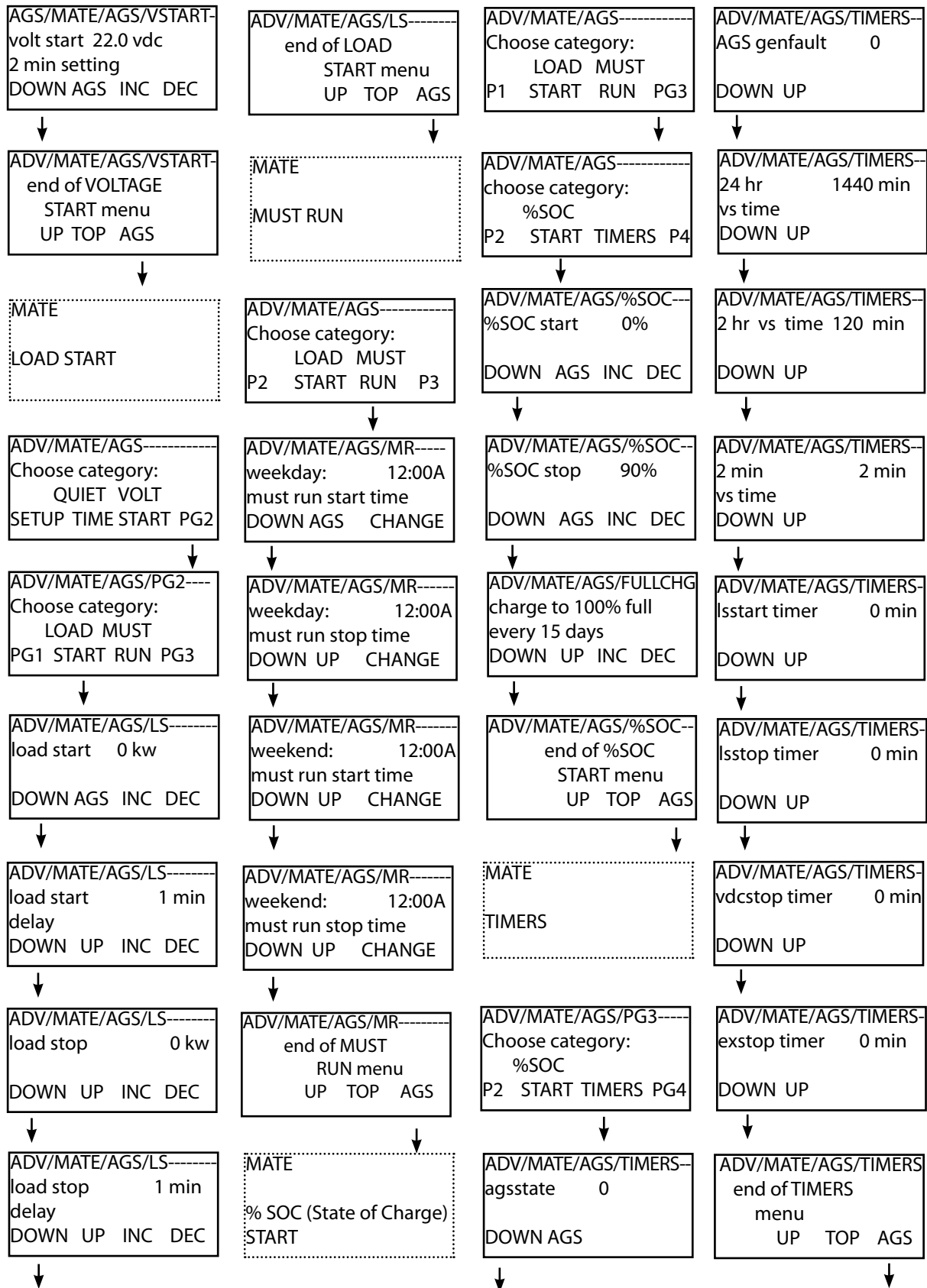

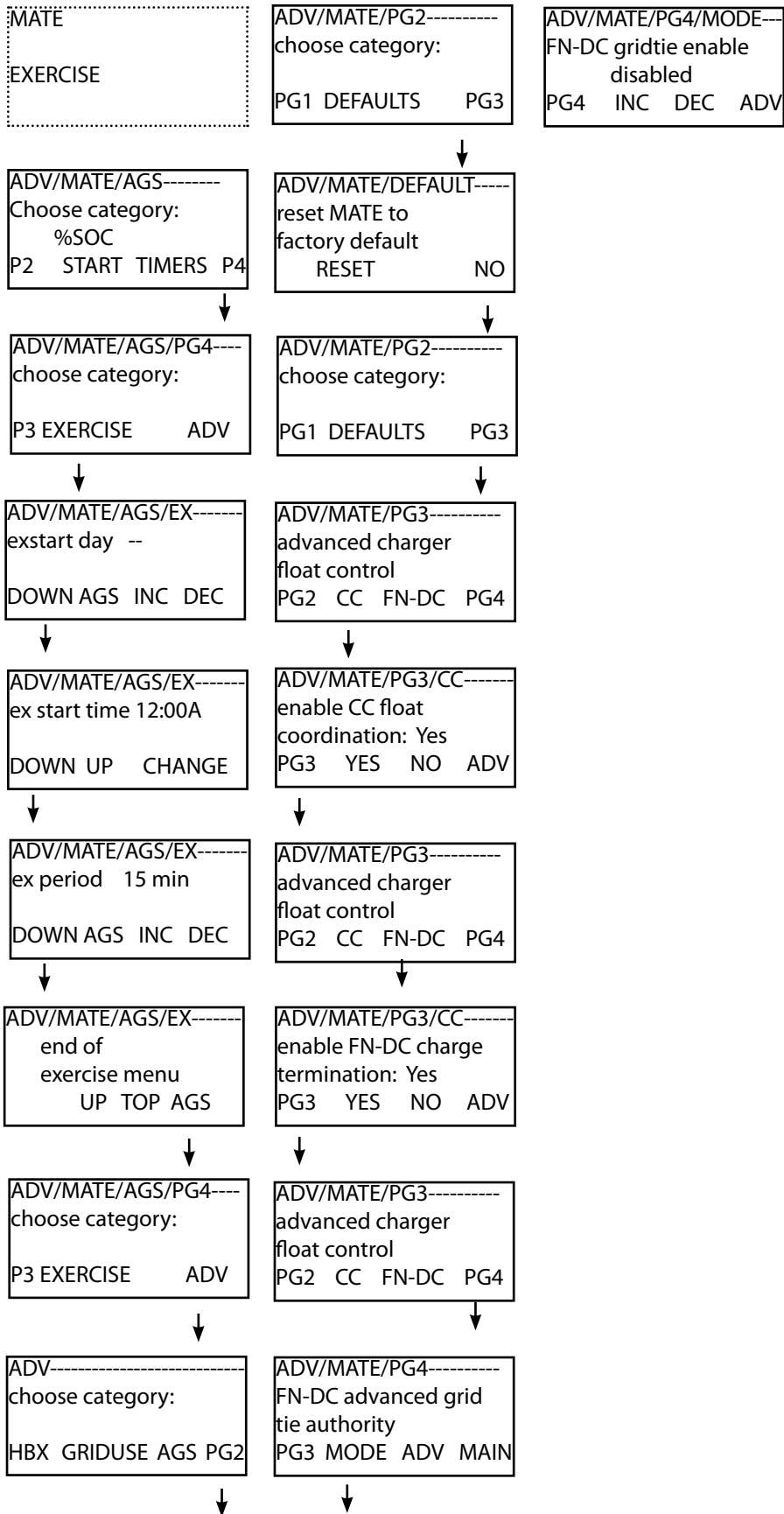

MENU MAP  
OVERVIEW

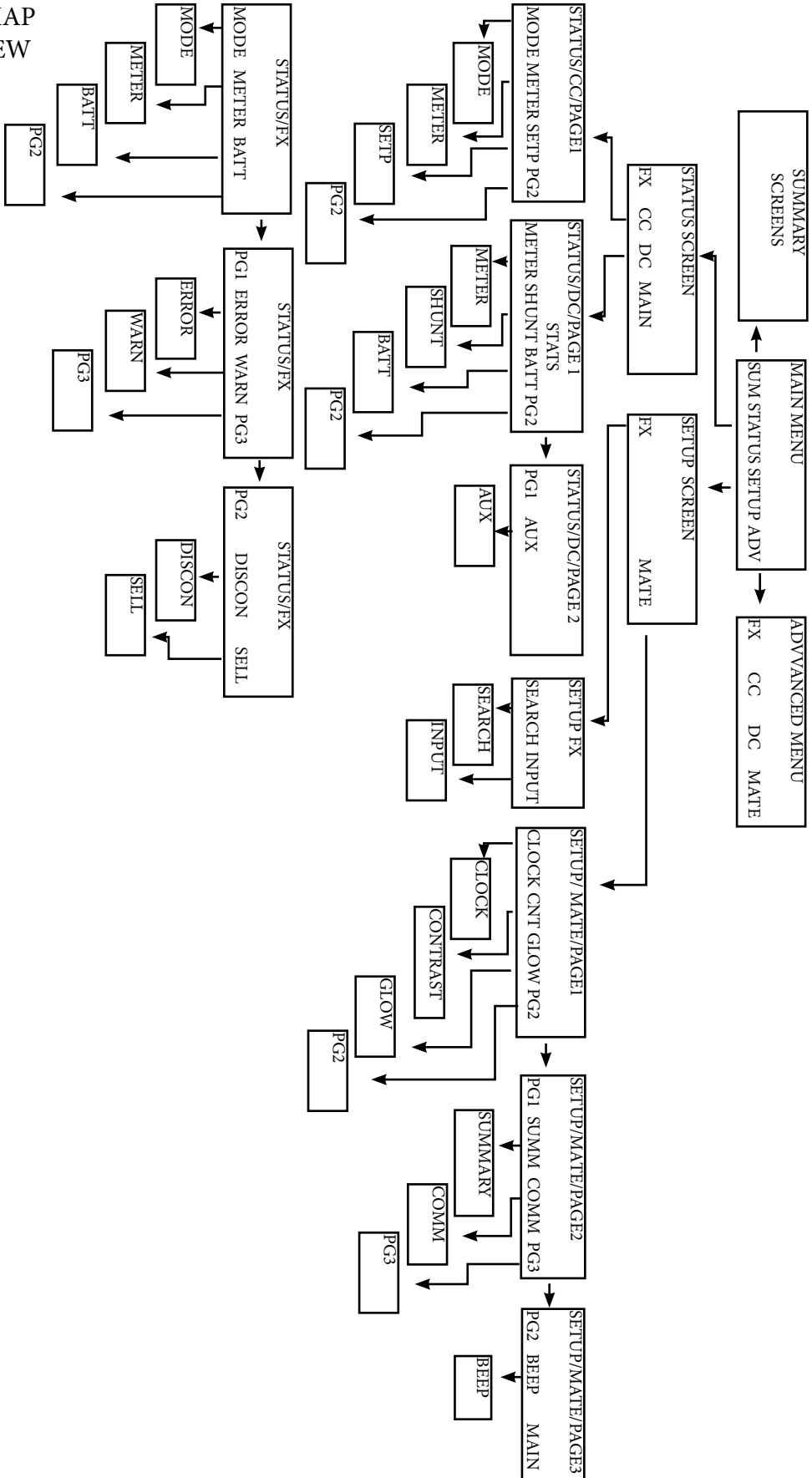

# MENU MAP OVERVIEW

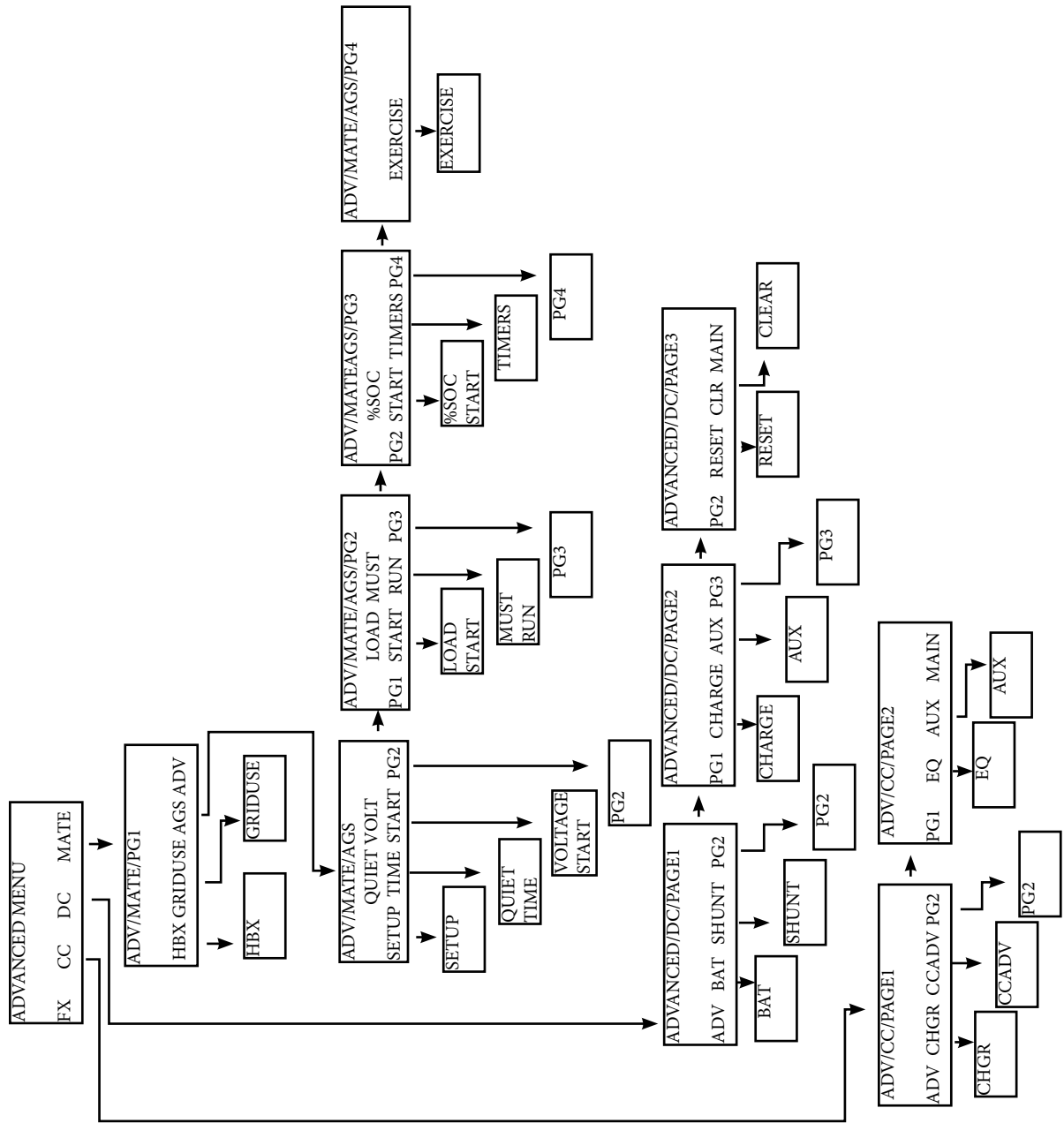

## APPENDIX

### Common Tasks

The following tasks are common to many OutBack Power Systems customers and are viewable and programmable using the MATE. They are fully explained within this manual. The purpose here is to offer an overview of the tasks and put them in an easily understandable context, especially for new users.



---

NOTE: The MATE acts almost exclusively as a display screen only for the *MX60 Charge Controller*. The *MX60* has its own screen and soft keys for its programming.

---

### How to recharge the batteries using an FX Series Inverter/Charger

Go to the CHARGER screens in the ADVANCED menu and set the limits. These limits include:

- *charger limit*—how much charge the FX uses to charge the batteries
- *absorb set point*—voltage level reached during the BULK or first stage of charging
- *absorb set time limit*—amount of time recharging spends at the absorb set point to fully recharge the batteries
- *float set point*—the final charging voltage when the refloat voltage is met
- *float time period*—amount of time the charging process holds at the float set point
- *refloat set point*—when the batteries fall below this voltage, the FX starts a REFLOAT cycle to keep the batteries charged
- *equalize set point*—a high voltage used for occasional equalization recharging
- *equalize time period*—amount of time the batteries are held at the EQ voltage

### Recharge the batteries using HBX—high battery transfer—with a grid-connected FX Series Inverter/Charger

Go to the HBX screens in the ADVANCED menu and establish the voltage and time set points:

- *hbx-use grid set point*: the voltage value that initiates the HBX recharging mode
- *hbx-use grid delay*—the amount of time the battery voltage must remain below the hbx-use grid set point before the charge cycle can begin
- *hbx-drop grid set point*—the voltage value which, when reached, stops the recharging process
- *hbx-drop grid delay*—the amount of time the battery voltage must remain about the hbx-drop grid set point before the recharging stops

## How to connect to an electrical grid

Go to the GRIDUSE screens in the ADVANCED menu. Using these screens, you can set the times of day you want to use grid AC power and the times you want to stop using it. This allows you connect when your batteries will not adequately supply all your loads or take advantage of lower utility rates at certain times of the day.

- *griduse enable*: turns this mode on or off
- *weekday griduse start*: establishes the weekday time the FX Series Inverter/Charger connects to the grid
- *adj hour* and *adj min*: these screens adjust the time
- *weekday griduse stop*: establishes weekday time the FX will disconnect from grid power
- *weekend griduse start*: user can set weekend time to connect to the grid
- *weekend griduse stop*: user can set weekend time to disconnect from grid

For further adjustments, go to the GRID screens in the ADVANCED menu:

- *acl/grid lower limit*—sets the minimum grid-supplied voltage the FX will connect to
- *acl/grid upper limit*—sets the maximum grid-supplied voltage the FX will connect to
- *acl/grid input limit*—the maximum amperage the FX can draw from the grid

## How to start my generator

You can manually start a generator manually or by presetting some time, voltage, or load conditions. To manually start a generator:

- Press the **AC IN** hot key twice (on the left side of the MATE)
- Press the **<ON>** soft key

To preset generator start-up conditions, go to the AGS (Advanced Generator Start) screens in the ADVANCED menu and do the following for time-based start and stops:

- Press **<SETUP>**
- Choose the appropriate HUB port
- *AGS enabled*—press **<YES>**
- Choose from **<AUTO>** or **<ON>** to start
- If **<AUTO>** is chosen, conditions can be set to start the generator
- **<ON>** is a manual start

Further AGS settings:

- *weekday quiet time start*—weekday early time you do not want generator to start
- *adj hour & adj min*—establishes the exact start time when generator should not be running
- *weekday quiet time stop*—ends the quiet period, generator can run again
- *adj hour & adj min*—establishes exact stop time
- Same adjustments are available for weekends

When the battery falls below your established voltage set point for a set amount of time, the generator will start and recharge the batteries. For voltage-based start and stops, go to the AGS screens and press VOLT START:

- 24 hr, 2hr, and 2 min time periods are available
- Choose a time period the battery voltage can fall below your established set point

AC load demands can also start the generator. From the AGS screens in the ADVANCED menu, choose LOAD START:

- *load start*—determine the load in kilowatts that, when exceeded, will start the generator
- *load start delay*—the amount of time the loads must exceed the load start current setting (kw)
- *load stop*—the kilowatt load must fall below this value to shut the generator off
- *load stop delay*—amount of time load must be below load start stop before generator shuts off

For those times you simply want the generator to run, go to the MUST RUN screens in the ADVANCED menu:

- Adjust the weekday and weekend start and stop times

For further generator adjustments, go to the GEN screens in the ADVANCED menu:

- *ac input connect delay*—time period FX delays before accepting a generator-supplied AC source
- *ac2/gen lower limit*—minimum generator-supplied AC voltage the FX will connect to
- *ac2/gen upper limit*—maximum generator-supplied AC voltage the FX will connect to
- *ac1/gen input limit*—maximum amperage FX will accept from a generator before backing off of a charger (if the limit is still exceeded, the error LED displays a warning)
- *ac1/gen transfer delay*—time FX remains connected to generator after input voltage falls below the *ac2/gen lower limit*

## How to Stack FX Series

Determine the best stacking method—1-2 PH Master, Classic Slave, OutBack Series/Parallel—and go to the STACK screens in the ADVANCED menu.

- Choose the stacking method's appropriate screen
- Using the soft keys and screen commands, assign the Master and Slave FX Series Inverter/Chargers
- For complete FX programming information, see the programming manual for your model FX.



## Troubleshooting

### MATE does not power-up

The OutBack MATE is powered by the OutBack product that it is connected to. Make sure that all OutBack Products are powered-up and operating correctly before connecting the MATE. Check or replace the CAT5 cables running from the MATE to the OutBack product.

### MATE does not find a Device

Make sure that all OutBack Products are powered-up and operating correctly before connecting the MATE. Check or replace the CAT5 cables running from the MATE to the OutBack product.

If a HUB is being used, make sure no OutBack products have been moved, unplugged, or added. If they have, follow the instructions in MATE Setup Communications Options to REPOLL for moved or new devices.

### MATE does not display the correct meter or setting

Make sure that all OutBack Products are powered-up and operating correctly before connecting the MATE. Check or replace the CAT5 cables running from the MATE to the OutBack product.

If a HUB is being used, make sure no OutBack products have been moved or unplugged. If they have, follow the instructions in MATE Setup Communications Options to REPOLL for moved or new devices.

### MATE will not EQ my system when I use the EQ function under the <ACIN> button

Older FXs and MXs with a newer MATE will not be able to utilize this system wide command. FXs that do not respond to this command can have an EQ cycle started by using the EQ start function located in the STATUS/FX/MODE menu. From the Main screen press <STATUS>, <FX>, <MODES>. Continue to press <DOWN> until you see the EQ function. If a HUB is used, FXs must have an EQ cycle start individually for each FX on the HUB (Use the <PORT> button to cycle through the available FXs).

### MATE displays a 'COMM ERROR'

If the MATE receives too many interrupted or corrupt communications with OutBack products attached to the HUB, it will display a 'COMM ERROR' screen.

00:000	01:000	02:000
03:000	<b>04:025</b>	05:000
06:000	07:000	08:000
09:000	10:000	2M:000

Choosing 'VIEW DEBUG' takes you to a screen that lists all ports and accumulated errors. Any Port experiencing errors can be found by the error count after the Port number.

In the example to the right, Port 4 has a large number of errors detected (04:025 means Port 4: showing 25 errors).

Pressing any key will take you to the SETUP/MATE/COMM screen, which will allow the error counts to be reset using the 'RSET' button, the Debug screen can be redisplayed by using the 'VIEW' button, or user can get back to the SETUP menu by using the 'BACK' button.

Use the information on the Debug screen to locate the problem device. Make sure that it's DC breaker is on, and that it is operating correctly. Check or replace CAT5 cables running from the HUB to that device.



## USER SYSTEM INFORMATION AND SETTINGS

Date of Installation \_\_\_\_\_

Installer \_\_\_\_\_

Battery Charging\*

Absorb Set point \_\_\_\_\_

Absorb Time Limit \_\_\_\_\_

\*These values are available from the battery manufacturer

### Battery Equalizing (EQ) Recharging Schedule and Checklist

(YEAR)													
EQ	20__	JAN	FEB	MAR	APR	MAY	JUN	JUL	AUG	SEPT	OCT	NOV	DEC
EQ	20__	JAN	FEB	MAR	APR	MAY	JUN	JUL	AUG	SEPT	OCT	NOV	DEC
EQ	20__	JAN	FEB	MAR	APR	MAY	JUN	JUL	AUG	SEPT	OCT	NOV	DEC
EQ	20__	JAN	FEB	MAR	APR	MAY	JUN	JUL	AUG	SEPT	OCT	NOV	DEC
EQ	20__	JAN	FEB	MAR	APR	MAY	JUN	JUL	AUG	SEPT	OCT	NOV	DEC
EQ	20__	JAN	FEB	MAR	APR	MAY	JUN	JUL	AUG	SEPT	OCT	NOV	DEC
EQ	20__	JAN	FEB	MAR	APR	MAY	JUN	JUL	AUG	SEPT	OCT	NOV	DEC
EQ	20__	JAN	FEB	MAR	APR	MAY	JUN	JUL	AUG	SEPT	OCT	NOV	DEC
EQ	20__	JAN	FEB	MAR	APR	MAY	JUN	JUL	AUG	SEPT	OCT	NOV	DEC
EQ	20__	JAN	FEB	MAR	APR	MAY	JUN	JUL	AUG	SEPT	OCT	NOV	DEC

## WARRANTY

### OutBack Power Systems Two Year Limited Warranty

OutBack Power Systems Inc. warrants that the products it manufactures will be free from defects in materials and workmanship for a period of two (2) years subject to the conditions set forth below.

The limited warranty is extended to the original user and is transferable. The limited warranty term begins on the date of invoice to the original user of the product. The limited warranty does not apply to any product or part thereof damaged by a) alteration or disassembly, b) accident or abuse, c) corrosion, d) lightning, e) reverse polarity, f) repair or service provided by an unauthorized repair facility, g) operation or installation contrary to instructions pertaining to the product.

OutBack Power Systems' liability for any defective product or any part thereof shall be limited to the repair or replacement of the product, at OutBack Power Systems' discretion. OutBack Power Systems does not warrant or guarantee the workmanship performed by any person or firm installing its products.

THIS LIMITED WARRANTY GIVES YOU SPECIFIC LEGAL RIGHTS, AND YOU MAY ALSO HAVE OTHER RIGHTS THAT VARY FROM STATE TO STATE (OR JURISDICTION TO JURISDICTION). OUTBACK POWER SYSTEMS' RESPONSIBILITY FOR MALFUNCTIONS AND DEFECTS IN HARDWARE IS LIMITED TO REPAIR AND REPLACEMENT AS SET FORTH IN THIS LIMITED WARRANTY STATEMENT. ALL EXPRESS AND IMPLIED WARRANTIES FOR THE PRODUCT, INCLUDING BUT NOT LIMITED TO ANY IMPLIED WARRANTIES OF AND CONDITIONS OF MERCHANTABILITY AND FITNESS FOR A PARTICULAR PURPOSE, ARE LIMITED IN DURATION TO THE LIMITED WARRANTY PERIOD SET FORTH ABOVE AND NO WARRANTIES, WHETHER EXPRESS OR IMPLIED, WILL APPLY AFTER SUCH PERIOD. SOME STATES (OR JURISDICTIONS) DO NOT ALLOW LIMITATIONS ON HOW LONG AN IMPLIED WARRANTY LASTS, SO THE ABOVE LIMITATION MAY NOT APPLY TO YOU.

OUTBACK POWER SYSTEMS DOES NOT ACCEPT LIABILITY BEYOND THE REMEDIES SET FORTH IN THIS LIMITED WARRANTY STATEMENT OR LIABILITY FOR INCIDENTAL OR CONSEQUENTIAL DAMAGES, INCLUDING WITHOUT LIMITATION ANY LIABILITY FOR PRODUCTS NOT BEING AVAILABLE FOR USE. SOME STATES (OR JURISDICTIONS) DO NOT ALLOW THE EXCLUSION OR LIMITATION OF INCIDENTAL OR CONSEQUENTIAL DAMAGES, SO THE ABOVE EXCLUSION OR LIMITATION MAY NOT APPLY TO YOU.

During the two year period beginning on the invoice date, OutBack Power Systems will repair or replace products covered under this limited warranty that are returned to OutBack Power Systems' facility or to an OutBack Power Systems authorized repair facility, or that are repaired on site by an OutBack Power Systems authorized repair technician. To request limited warranty service, you must contact OutBack Power Systems at 360.435.6030 (North America) or +34.93.654.9568 (Europe) within the limited warranty period. If limited warranty service is required, OutBack Power Systems will issue a Return Material Authorization (RMA) Number. Mark the outside of the package with the RMA number and include a copy of the purchase invoice in the package. You must ship the products back to OutBack Power Systems in their original or equivalent packaging, prepay shipping charges, and insure the shipment or accept the risk of loss or damage during shipment. OutBack Power Systems will ship the repaired or replacement products to you freight prepaid if you use an address in the continental United States, where applicable. Shipments to other locations will be made freight collect.

## REGISTRATION

Your purchase of an OutBack Power Systems product is an important investment. Registering your products will help us maintain the standard of excellence you expect from us in terms of performance, quality and reliability.

*Please take a moment to register and provide us with some important information.*

---

NAME: \_\_\_\_\_ E-MAIL: \_\_\_\_\_  
 ADDRESS: \_\_\_\_\_ SOLD BY: \_\_\_\_\_  
 CITY: \_\_\_\_\_ INSTALLER: \_\_\_\_\_  
 STATE: \_\_\_\_\_ ZIP CODE: \_\_\_\_\_ PURCHASE DATE: \_\_\_\_\_  
 COUNTRY: \_\_\_\_\_ MODEL NUMBER: \_\_\_\_\_  
 TELEPHONE NUMBER: \_\_\_\_\_ SERIAL NUMBER: \_\_\_\_\_

---

Circle all that apply:

- |   |   |   |
|---|---|---|
| <input type="checkbox"/> Off-Grid Installation          | <input type="checkbox"/> Residential Installation | <input type="checkbox"/> North America Location |
| <input type="checkbox"/> Utility Connected Installation | <input type="checkbox"/> Commercial Installation  | <input type="checkbox"/> Other _____            |

.....

### Extended Warranty Application

OutBack Power Systems offers an optional three year extension to the standard two year limited warranty. Purchase of extended warranty coverage is available on products listed below provided conditions shown are met. Extended warranty coverage must be purchased within 90 days of the original sale of the product covered.

<b>PRODUCT</b>	<b>REQUIRED SURGE PROTECTION</b>	<b>EXTENDED WARRANTY COST</b>
Any FX Series Inverter/Charger	AC Input; AC Output, DC Input	\$300.00
MATE	NA	\$50.00
HUB 4	NA	\$35.00
HUB 10	NA	\$50.00

<b>Product Covered</b>	<b>Serial Number</b>	<b>Quantity</b>	<b>Extended Warranty Cost</b>
_____	_____	_____	_____
_____	_____	_____	_____
_____	_____	_____	_____
_____	_____	_____	_____
			<b>Total</b> _____

Send check or money order payable to OutBack Power Systems. Washington residents please include 8.5% sales tax. Include a completed copy of this application and send to:

OutBack Power Systems  
 Extended Warranty Program  
 19009 62nd Ave NE  
 Arlington, WA 98223 USA



**Corporate Headquarters**  
19009 62nd Avenue NE  
Arlington, WA 98223 USA  
Phone: (+1) 360.435.6030

[www.outbackpower.com](http://www.outbackpower.com)

**European Sales Office**  
C/ Castelló, 17  
08830 - Sant Boi de Llobregat  
BARCELONA, España  
Phone: +34.93.654.9568

900-0012-01-00 REV C