

# AUSTRIAN JUNIOR OPEN 2023

2023.06.24 - 2023.06.24

Schulstrasse 17, 5071 Wals

AUSTRIA,AUT



# AUSTRIAN JUNIOR OPEN 2023

AUSTRIA  
Schulstrasse 17, 5071 Wals

2023.06.24 - 2023.06.24

## Participation List (by Club/Team)

#	Code	Club	Male	Female	Total Entries	Total Athletes
1	 AUT	ASK Karate Kara(Kara)	1	5	6	5
2	 AUT	ASK Karate SeiBuKan Neuhofen[1](SeiBuKan Neuhofen[1])	4	3	7	7
3	 AUT	ASK Karate Steyr(Steyr)	2	0	2	1
4	 AUT	Ask SeiBuKan Linz(SBK Linz)	23	3	26	14
5	 AUT	Frieways Karateklub(KC Frieways)	1	4	5	5
6	 AUT	Inoue-ha Karate-do Feldkirchen(KC Feldkirchen)	0	1	1	1
7	 AUT	KARATE VORARLBERG(KARATE VORARLBERG)	28	24	52	27
8	 AUT	Karate Shotokan LORA Zell am See (SHOTOKAN LORA )	4	2	6	11
9	 AUT	Karate Club Langenlois(Karate Club Langenlois)	1	1	2	2
10	 AUT	Karate Leistungszentrum Pinzgau(LZ Pinzgau)	4	6	10	10
11	 AUT	Karate Union Kachikan(KU Kachikan)	1	5	6	6
12	 AUT	Karate Union Shotokan Tirol(Karate St. Johann i.T.)	5	9	14	16
13	 AUT	Karate Union Walserfeld(KU Walserfeld)	24	36	60	36
14	 AUT	Karate Zanshin Koblach/Hard/Bregenz(Karate Zanshin)	8	12	20	8
15	 AUT	Karate-Do Weiz(Karate-Do Weiz)	1	0	1	1
16	 AUT	Karatedo Wels(Wels)	0	3	3	2
17	 AUT	Kyokushin Karate SAMURAI[1](Kyokushin Karate SAMURAI[1])	3	1	4	3
18	 AUT	LZ Obersterreich(LZO)	2	1	3	3
19	 AUT	LZ Steiermark(LZ Stmk)	2	2	4	2
20	 AUT	Leistungszentrum WIEN(LZ-Wien)	15	14	29	20
21	 AUT	Sportunion Mugendo Karate(SMK )	2	0	2	2
22	 AUT	Sportunion Shuhari Graz(Shuhari Graz)	1	1	2	2
23	 AUT	UKA Zen Tai Ryu HAK St. Plten(ZTR HAK StP)	0	1	1	1
24	 AUT	Union Karateclub Grieskirchen(UKC Grieskirchen)	1	1	2	2
25	 CZE	Club karate Plzen(CK Plzen)	0	2	2	2
26	 CZE	Nidoshinkan Dojo(Nidoshinkan)	0	2	2	2
27	 DEN	Sportskarate.dk[4](SPD[4])	0	7	7	3
28	 GER	1. Kemptener Karate Dojo im TV Kempten(TVK)	2	0	2	1
29	 GER	1.CKKS Traunreut(1.CKKS)	12	9	21	14
30	 GER	Asia Sports Karateschule (A.S. Waldkraiburg)	15	28	43	25
31	 GER	Bushido Stollberg e.V.(Bushido STL)	0	2	2	1
32	 GER	Funakoshi Karate Northeim(FKN)	9	4	13	9
33	 GER	Goju-Kai Amtsberg e.V.(Amtsberg)	2	4	6	3
34	 GER	KD Straubing(KD Straubing)	3	1	4	3
35	 GER	Karate-Do Rochlitz e.V.[1](Rochlitz[1])	5	4	9	7
36	 GER	Karate-Sport Milbertshofen(KS Milbertshofen)	1	0	1	1
37	 GER	Kvnnordhorn[3](KVNoh)	2	4	6	4

# AUSTRIAN JUNIOR OPEN 2023

AUSTRIA  
Schulstrasse 17, 5071 Wals

2023.06.24 - 2023.06.24

## Participation List (by Club/Team)

38		GER	LV Brandenburg[1](BRA[1])	2	0	2	1
39		GER	LV Sachsen-Anhalt(SAH)	11	4	15	9
40		GER	Nippon Gotha e.V.[1](Nippon GTH[1])	0	3	3	2
41		GER	Okinawa Karate TSV Feichten(Okinawa Karate Feichten)	4	0	4	4
42		GER	Okinawa Karate Tus Alztal Garching[1](TuS Alztal[1])	3	1	4	4
43		GER	Rhein-Neckar Knights(RNK)	2	2	4	4
44		GER	SEIWAKAI TEAM(SEIWAKAI TEAM)	10	6	16	16
45		GER	SV UNSU Karate Mmlingen e.V.[1](UNSU Team)	0	1	1	1
46		GER	Sen5 Karate Verein e.V.(Sen5)	4	9	13	8
47		GER	TSV Erding[3](TSV Erding[3])	0	3	3	3
48		GER	TSV Grasbrunn-Neukeferloh(Neukeferloh)	8	0	8	4
49		GER	TSV Monheim e.V.(TSVM)	6	5	11	7
50		GER	TSV Vilsbiburg 1883 e.V.[DKV](TSV Vilsbiburg 1883 e.V.[DKV])	0	2	2	1
51		GER	Teikyo Karate Team e.V.(Teikyo Team)	2	0	2	1
52		HUN	DMTK HUN(DMTK HUN)	5	1	6	6
53		ISL	Karateflag Reykjavkur[1][2](KFR[2])	4	9	13	5
54		ITA	A.S.D. Artesport(Artesport)	2	2	4	4
55		ITA	A.S.D. VILLA PIGNA KARATE(A.S.D. VILLA PIGNA KARATE)	1	0	1	1
56		ITA	AKS Firenze(AKS Firenze)	12	4	16	12
57		ITA	ASD CENTRO STUDI KARATE NEGRAR[1](ASD CSK NEGRAR[1])	0	2	2	1
58		ITA	ASD HEIAN BUSHI DO(H.B.DO)	1	2	3	3
59		ITA	ASD RENSHUKAN TORINO(RENSHUKAN)	0	1	1	1
60		ITA	ASD Shotokan Karate Pozzuolo del Friuli(SKZP)	1	2	3	3
61		ITA	ASD TALARICO KARATE TEAM APS(TKT[1])	11	15	26	25
62		ITA	ASD karate Benaco(ASD karate Benaco)	0	4	4	2
63		ITA	Accademia dello Sport Livorno(Accademia dello Sport LI)	8	4	12	8
64		ITA	Bushido Karate Perugia[1](BKP[1])	12	1	13	13
65		ITA	CENTRO KARATE RIMINI[3](CKR[3])	2	0	2	1
66		ITA	GARDA KARATE TEAM[1](GKT[1])	3	6	9	9
67		ITA	Impero del sole a.s.d.[1](ids[1])	10	6	16	6
68		ITA	Karate Mhlbach(Karate Mhlbach)	4	0	4	3
69		ITA	Karate Nakayama[1](Karate Nakayama[1])	5	11	16	13
70		ITA	RYUGIN CODROIPO(RYUGIN)	2	0	2	2
71		KOS	Karate Club Olimp(KC Olimp)	2	0	2	1
72		KOS	Klubi i Karatese Ippon-Prishtine(KK IPPON-Prishtine)	5	2	7	4
73		NED	Unity99[4](Unity99[4])	1	0	1	1
74		SLO	Karate Klub Kovinar Maribor(KK Kovinar Maribor)	3	0	3	3
75		SLO	Karate klub SEKI[1](KK Seki[1])	0	1	1	1

# AUSTRIAN JUNIOR OPEN 2023

AUSTRIA  
Schulstrasse 17, 5071 Wals

2023.06.24 - 2023.06.24

## Participation List (by Club/Team)



76		SUI	EKTS Lausanne Vufflens(EKTS Vaud)	2	1	3	3
77		SUI	Elson Sport & Karate(Elson Sport)	4	0	4	3
78		SUI	Goju Kan Bern(Goju Kan Bern)	1	0	1	1
79		SUI	Karate Do Brugg(KDB)	17	8	25	11
80		SUI	Karate Emme(Karate Emme)	1	4	5	4
81		SUI	Karatecenter Reto Kern Kreuzlingen(KCRK)	8	9	17	9
82		SUI	Karatedo Lyss-Aarberg(KDLyss)	6	19	25	12
83		SUI	Karat Club Jaguar Vallorbe(KCJ)	0	3	3	1
84		SUI	Kashiva Kan Bienne(Kashiva Kan)	2	0	2	1
85		SUI	Kenseikan Karate-Do Thun(Ken Thun)	2	1	3	3
86		SUI	Kimura Shukokai Karate Limmattal(Karate Limmattal)	18	11	29	14
87		SUI	RYUEI-RYU Karate Suisse[5](RKS[5])	0	2	2	2
88		SUI	SSKF Karate Team(SSKF Karate Team)	13	6	19	12
89		SUI	Scuola di Karate YAMA NO KAZE(YAMA NO KAZE)	0	2	2	2
90		SUI	Shorin Ryu Karate Do Kloten[4](ISSKA[4])	1	0	1	1
91		SUI	Shukokai Dojo Wetzikon(Shukokai Wetzikon)	15	15	30	15
92		SUI	Swiss Karate Union[1](SKU[1])	35	28	63	37
93		SUI	karateschule sursee(k.s.sursee)	1	4	5	5
94		SVK	Karate klub KUMADE Topoany(KUMADE TO)	1	1	2	2
95		SWE	Karateklubb Elit(KKELIT)	3	0	3	1
96		UKR	OKINAWA[5](oki[5])	1	1	2	2
97		USA	USA Karate Team(USX Team)	2	10	12	6
<b>Totals:</b>				463	436	899	602

# AUSTRIAN JUNIOR OPEN 2023

AUSTRIA  
Schulstrasse 17, 5071 Wals

2023.06.24 - 2023.06.24

## Tournament Participation (Entries) by Club

 AUSTRIA					
 ASK Karate Kara(Kara)					
ID	Sex	Family Name	Given Name	Category	
1	Female	Lex	Flora	Kumite Individual female U14 -47 kg	
2	Female	Omerovic	Elina	Kumite Individual female U14 -47 kg	
3	Male	Schefbaumer	Franz Mathew	Kata Individual male U12	
4	Female	Wohland	Leonie	Kumite Individual female U18 Open	
5	Female	Wohland	Leonie	Kumite Individual female Juniors -66	
6	Female	zkan-Kleestorfer	Yasmin	Kata Individual female U14	

Entries: 6

# AUSTRIAN JUNIOR OPEN 2023

AUSTRIA  
Schulstrasse 17, 5071 Wals

2023.06.24 - 2023.06.24

## Tournament Participation (Entries) by Club

 ASK Karate SeiBuKan Neuhofen(SeiBuKan Neuhofen)					
ID	Sex	Family Name	Given Name	Category	
7	Male	Hankowetz	Jakob	Kumite Individual male U14 -45 kg	
8	Male	Hüber	Niklas	Kumite male U10 -34kg	
9	Male	Reichl	Finn	kumite male u10 -28 kg	
10	Female	Salzmann	Ida	Kata Individual female U12	
11	Female	Stockhammer	Miriam	Kumite Individual female Juniors -66	
12	Female	Wahl	Sarah	Kata Individual female U14	
13	Male	Wintersperger	Lorenz	Kumite Individual male Cadets -63	

Entries: 7

# AUSTRIAN JUNIOR OPEN 2023

AUSTRIA  
Schulstrasse 17, 5071 Wals

2023.06.24 - 2023.06.24

## Tournament Participation (Entries) by Club

 ASK Karate Steyr(Steyr)					
ID	Sex	Family Name	Given Name	Category	
14	Male	Dramalija	Muhamed	Kumite Individual male Cadets +70	
15	Male	Dramalija	Muhamed	Kumite Individual male U16 Open	

Entries: 2

# AUSTRIAN JUNIOR OPEN 2023

AUSTRIA  
Schulstrasse 17, 5071 Wals

2023.06.24 - 2023.06.24

## Tournament Participation (Entries) by Club

 Ask SeiBuKan Linz(SBK Linz)				
ID	Sex	Family Name	Given Name	Category
16	Male	Ackerbauer	Andreas	Kumite Individual male U14 -45 kg
17	Male	Ackerbauer	Andreas	Kata Individual male U14
18	Male	Beganovic	Sanid	Kumite Individual male Cadets -70
19	Male	Beganovic	Seldin	Kata Individual male U12
20	Male	Beganovic	Seldin	Kata Team male U12
21	Male	Beganovic	Seldin	Kumite Individual male U12 +38 kg
22	Male	Dzafic	Ben	Kata Individual male U12
23	Male	Dzafic	Ben	Kata Team male U12
24	Male	Dzafic	Ben	Kumite Individual male U12 -32 kg
25	Male	Galateanu	David	Kata Individual male Cadets
26	Male	Galateanu	David	Kumite Individual male Cadets -52
27	Female	Galateanu	Evelyn	Kumite Individual female Juniors -48
28	Female	Galateanu	Evelyn	Kata Individual female Juniors
29	Male	Hasani	Luan	Kumite Individual male Juniors -76
30	Male	Heinisch	Leon	Kata Team male U10
31	Male	Heinisch	Leon	Kumite male U10 +34kg
32	Male	Heinisch	Leon	Kata Individual male U10
33	Male	Huskic	Denis	Kumite Individual male U21 -60
34	Female	Huskic	Diana	Kata Individual female U10
35	Male	Mala Hamza	Hem	Kata Individual male U10
36	Male	Mala Hamza	Hem	Kumite male U10 -34kg
37	Male	Mala Hamza	Hem	Kata Team male U10
38	Male	Markovic	Andrej	Kata Team male U10
39	Male	Markovic	Andrej	Kata Individual male U10
40	Male	Markovic	Andrej	Kumite male U10 -34kg
41	Male	Mayr	Werner	Kumite Individual male Cadets +70
42	Male	Mayr	Werner	Kumite Individual male U16 Open
43	Male	Sedeqy	Josef	Kata Individual male U12
44	Male	Sedeqy	Josef	Kata Team male U12
45	Male	Sedeqy	Josef	Kumite Individual male U12 +38 kg

Entries: **30**



# AUSTRIAN JUNIOR OPEN 2023

AUSTRIA  
Schulstrasse 17, 5071 Wals

2023.06.24 - 2023.06.24

## Tournament Participation (Entries) by Club

 Frieways Karateklub(KC Frieways)					
ID	Sex	Family Name	Given Name	Category	
46	Female	Eidler	Elena	Kata Individual female Juniors	
47	Female	Eidler	Elena	Kata Individual female Juniors R3 Bronze Medal Match 2	
48	Female	Eidler	Elena	Kata Individual female Juniors R2-G2	
49	Female	Korner	Leonie	Kata Individual female Cadets R4 Gold Medal Match	
50	Female	Korner	Leonie	Kata Individual female Cadets R3-G2	
51	Female	Korner	Leonie	Kata Individual female Cadets	
52	Female	Korner	Leonie	Kata Individual female Cadets R2-G2	
53	Female	Lehner	Tamara	Kata Individual female Cadets R4 Gold Medal Match	
54	Female	Lehner	Tamara	Kata Individual female Cadets R3-G1	
55	Female	Lehner	Tamara	Kata Individual female Cadets R2-G1	
56	Female	Lehner	Tamara	Kata Individual female Cadets	
57	Female	Trejo	Melanie	Kata Individual female Juniors	
58	Male	Zadina	Emil	Kata Individual male U14	

Entries: 13

# AUSTRIAN JUNIOR OPEN 2023

AUSTRIA  
Schulstrasse 17, 5071 Wals

2023.06.24 - 2023.06.24

## Tournament Participation (Entries) by Club

 Inoue-ha Karate-do Feldkirchen(KC Feldkirchen)					
ID	Sex	Family Name	Given Name	Category	
59	Female	Flaschberger	Sarah	Kata Individual female U21	
60	Female	Flaschberger	Sarah	Kata Individual female U21 R3 Bronze Medal Match 2	
61	Female	Flaschberger	Sarah	Kata Individual female U21 R2-G1	

Entries: 3

# AUSTRIAN JUNIOR OPEN 2023

AUSTRIA  
Schulstrasse 17, 5071 Wals

2023.06.24 - 2023.06.24

## Tournament Participation (Entries) by Club

 Karate Shotokan LORA Zell am See (SHOTOKAN LORA )					
ID	Sex	Family Name	Given Name	Category	
62	Female	Aliji	Rina	Kata Individual female U8	
63	Male	Banic	Sergej	Kata Individual male U10	
64	Male	Banic	Sergej	Kata Team male U10	
65	Male	Bytyqi	Lijon	Kata Individual male Juniors	
66	Female	BYTYQI	LONDRESA	Kata Team female U16	
67	Female	BYTYQI	LORENA	Kata Team female U16	
68	Male	Gasser	Lorenz Noel	Kata Team male U10	
69	Male	GRBIC	ANDRE	Kata Team male U12	
70	Male	Gregor	Viliam	Kata Team male U10	
71	Male	KOTAN	EMIR	Kata Team male U12	
72	Female	LORA	ALIJI	Kata Team female U16	
73	Male	VYSNA	BRYAN	Kata Team male U12	

Entries: **12**

# AUSTRIAN JUNIOR OPEN 2023

AUSTRIA  
Schulstrasse 17, 5071 Wals

2023.06.24 - 2023.06.24

## Tournament Participation (Entries) by Club

 Karate Club Langenlois(Karate Club Langenlois)					
ID	Sex	Family Name	Given Name	Category	
74	Female	Steger	Rosalie	Kata Individual female Juniors	
75	Female	Steger	Rosalie	Kata Individual female Juniors R3 Gold Medal Match	
76	Female	Steger	Rosalie	Kata Individual female Juniors R2-G2	
77	Male	Ullrich	Theodor	Kata Individual male U10	

Entries: 4

# AUSTRIAN JUNIOR OPEN 2023

AUSTRIA  
Schulstrasse 17, 5071 Wals

2023.06.24 - 2023.06.24

## Tournament Participation (Entries) by Club

 Karate Leistungszentrum Pinzgau(LZ Pinzgau)					
ID	Sex	Family Name	Given Name	Category	
78	Male	Blaga	Alexandru	Kumite Individual male U14 -40 kg	
79	Male	Debro	Jakob	Kumite Individual male Cadets +70	
80	Male	Janovcik	Maros	Kumite Individual male U21 -75	
81	Female	Kemetingner	Sarah	Kumite Individual female U14 +52kg	
82	Female	Kemetingner	Sophie	Kumite Individual female U21 -68	
83	Female	Kirisits	Mira Lisa	Kumite Individual female U14 -42 kg	
84	Female	Lederer	Alessandra	Kumite Individual female U21 -50 -55	
85	Male	Sadikovic	Emil	Kumite Individual male U21 -84 +84	
86	Female	Schuster	Nina	Kumite Individual female U21 +68	
87	Female	Vukovic	Marina	Kumite Individual female U21 -68	

Entries: 10

# AUSTRIAN JUNIOR OPEN 2023

AUSTRIA  
Schulstrasse 17, 5071 Wals

2023.06.24 - 2023.06.24

## Tournament Participation (Entries) by Club

 Karate Union Kachikan(KU Kachikan)					
ID	Sex	Family Name	Given Name	Category	
88	Female	Celo	Hilal	Kata Individual female U12	
89	Female	Celo	Isra	Kata Individual female U21 R3 Bronze Medal Match 1	
90	Female	Celo	Isra	Kata Individual female U21	
91	Female	Celo	Isra	Kata Individual female U21 R2-G1	
92	Female	Erpolat	Neyra	Kata Individual female U14	
93	Female	Lena	Jana	Kata Individual female U8	
94	Female	Presl	Lina	Kata Individual female U10	
95	Male	Sadikovic	Muhammed	Kata Individual male U14	

Entries: 8

# AUSTRIAN JUNIOR OPEN 2023

AUSTRIA  
Schulstrasse 17, 5071 Wals

2023.06.24 - 2023.06.24

## Tournament Participation (Entries) by Club

 Karate Union Shotokan Tirol(Karate St. Johann i.T.)					
ID	Sex	Family Name	Given Name	Category	
96	Female	Anderson Pichardo	Alicia	Kata Team female U10	
97	Male	Bicioc	Romeo	Kata Individual male U8	
98	Male	Bicioc	Romeo	Kata Team male U10	
99	Male	Brcina	David	Kata Team male U12	
100	Male	Gherman	Nicolas	Kata Team male U12	
101	Female	Harasser	Marisa	Kata Team female U18	
102	Female	Harasser	Marisa	Kata Individual female Juniors	
103	Female	Harasser	Rosalie	Kata Team female U14	
104	Male	Jantscher	Marcel Joseph	Kata Individual male Cadets	
105	Female	Lasta	Katja	Kata Individual female Juniors	
106	Female	Lasta	Katja	Kata Team female U18	
107	Female	Lasta	Mia	Kata Individual female U12	
108	Female	Lasta	Mia	Kata Team female U14	
109	Female	Nikoli	Ema	Kata Individual female Cadets	
110	Female	Nikoli	Ema	Kata Team female U18	
111	Male	Oberdacher	Markus	Kata Team male U10	
112	Male	Olinici	Eduard	Kata Team male U10	
113	Male	Rigaud	Noel-Leon	Kata Team male U12	
114	Male	Rigaud	Noel-Leon	Kata Individual male U10	
115	Female	Ruzbacka	Viktoria	Kata Team female U10	
116	Female	Vujanovic	Nika	Kata Individual female U8	
117	Female	Vujanovic	Nika	Kata Team female U10	
118	Female	Vujanovic	Teodora	Kata Individual female U14	
119	Female	Vujanovic	Teodora	Kata Team female U14	

Entries: 24

# AUSTRIAN JUNIOR OPEN 2023

AUSTRIA  
Schulstrasse 17, 5071 Wals

2023.06.24 - 2023.06.24

## Tournament Participation (Entries) by Club

 Karate Union Walsersfeld(KU Walsersfeld)					
ID	Sex	Family Name	Given Name	Category	
120	Female	Alic	Ilma	Kumite Individual female U12 -36 kg	
121	Female	Alic	Ilma	Kumite Individual female U12 Open	
122	Female	Armagan	Aleyna	Kata Individual female Juniors	
123	Female	Armagan	Aleyna	Kata Team female U18	
124	Male	Bektic	Armin	Kumite Individual male U14 Open	
125	Male	Bektic	Armin	Kumite Individual male U14 -50 kg	
126	Female	Bektic	Jasmina	Kata Individual female Juniors	
127	Female	Cetin	Ceylin	Kumite Individual female U16 Open	
128	Female	Cetin	Ceylin	Kumite Individual female Cadets -54	
129	Female	Cetin	Meyra	Kumite Individual female U12 Open	
130	Female	Cetin	Meyra	Kumite Individual female U12 -30 kg	
131	Female	Ebner	Lena	Kumite Individual female U12 Open	
132	Female	Ebner	Lena	Kumite Individual female U12 -30 kg	
133	Female	Ebner	Lena	Kata Individual female U12	
134	Male	Ebner	Luca	Kumite Individual male Cadets -70	
135	Male	Ebner	Luca	Kumite Individual male U16 Open	
136	Female	Erlinger	Isabella	Kata Individual female U10	
137	Female	Grtner	Anna	KUMITE INDIVIDUAL FEMALE U10 +33kg	
138	Female	Grtner	Anna	Kata Team female U12	
139	Female	Grtner	Anna	Kata Individual female U10	
140	Female	Grtner	Eva	Kata Team female U12	
141	Female	Grtner	Eva	Kumite Individual female U12 Open	
142	Female	Grtner	Eva	Kumite Individual female U12 +36 kg	
143	Female	Grtner	Eva	Kata Individual female U12	
144	Female	Helmsauer	Marlene	Kata Team female U10	
145	Male	Illic	Marko	Kumite Individual male U18 Open	
146	Male	Illic	Marko	Kumite Individual male Juniors +76	
147	Female	Illic	Martina	Kata Team female U18	
148	Female	Illic	Martina	Kumite Individual female Cadets +61	
149	Female	Illic	Martina	Kata Individual female Cadets	
150	Female	Illic	Martina	Kumite Individual female U16 Open	
151	Male	Kaps	Lukas	Kata Individual male U12	
152	Male	Kaps	Lukas	Kata Team male U14 U16	
153	Male	Kienzl	Fabian	Kata Individual male U12	
154	Male	Khnel	Henrik	Kumite Individual male U18 Open	
155	Male	Khnel	Henrik	Kumite Individual male Juniors -76	
156	Male	Maier	Alexander	Kata Team male U14 U16	
157	Male	Maier	Alexander	Kata Individual male U14	
158	Male	Maric	Bojan	Kumite male U10 +34kg	
159	Female	Marjanovic	Andrijana	Kumite Individual female U21 Open	
160	Female	Marjanovic	Andrijana	Kumite Individual female U21 -61	
161	Female	Marjanovic	Tijana	Kata Individual female U14	
162	Female	Marjanovic	Tijana	Kata Team female U16	
163	Female	Moser	Annabelle	Kata Individual female U8	
164	Female	Moser	Annabelle	Kata Team female U10	
165	Female	Muhr	Lisa-Marie	Kata Individual female U8	
166	Male	Raffler	Dominic	Kata Individual male U8	



# AUSTRIAN JUNIOR OPEN 2023

AUSTRIA  
Schulstrasse 17, 5071 Wals

2023.06.24 - 2023.06.24

## Tournament Participation (Entries) by Club

167	Female	Sacher	Julia	Kata Individual female U12
168	Female	Sacher	Julia	Kata Team female U12
169	Male	Sacher	Thomas	Kata Individual male U14
170	Male	Sacher	Thomas	Kata Team male U14 U16
171	Male	Schachinger	Lorenz	Kata Team male U14 U16
172	Male	Schachinger	Lorenz	Kata Individual male Cadets
173	Male	Selimovic	Armin	Kumite Individual male U18 Open
174	Male	Selimovic	Armin	Kumite Individual male Juniors +76
175	Female	Sturm	Isabell	Kata Team female U16
176	Female	Sturm	Isabell	Kata Individual female U14
177	Female	Topal	Magdalena	Kumite Individual female Juniors -59
178	Female	Topal	Magdalena	Kumite Individual female U18 Open
179	Female	Tschaler	Larissa	Kumite Individual female U16 Open
180	Female	Tschaler	Larissa	Kata Team female U18
181	Female	Tschaler	Larissa	Kumite Individual female Cadets +61
182	Female	Tschaler	Larissa	Kata Individual female Cadets
183	Female	Ventimiglia	Viktoria	Kata Team female U16
184	Female	Voggenberger	Sophia	Kata Team female U10
185	Male	Wallner	Jonas	Kata Individual male Cadets
186	Male	Wallner	Jonas	Kata Team male U14 U16
187	Male	Wallner	Noah	Kumite Individual male U14 -45 kg
188	Male	Wallner	Noah	Kata Individual male U14
189	Male	Wallner	Noah	Kata Team male U14 U16
190	Male	Wallner	Noah	Kumite Individual male U14 Open
191	Male	Wallner	Simon	Kata Individual male Cadets

Entries: **72**

# AUSTRIAN JUNIOR OPEN 2023

AUSTRIA  
Schulstrasse 17, 5071 Wals

2023.06.24 - 2023.06.24

## Tournament Participation (Entries) by Club

 KARATE VORARLBERG(KARATE VORARLBERG)					
ID	Sex	Family Name	Given Name	Category	
192	Female	Albl	Anna	Kumite Individual female U14 -52	
193	Female	Albl	Anna	Kumite Individual female U14 Open	
194	Female	Bayram	Ceylin	Kata Individual female U14	
195	Female	Bayram	Ceylin	Kumite Individual female U14 Open	
196	Female	Bayram	Ceylin	Kumite Individual female U14 +52kg	
197	Female	Bayram	Mira	Kata Individual female U12	
198	Female	Bayram	Mira	Kumite Individual female U12 Open	
199	Female	Bayram	Mira	Kumite Individual female U12 +36 kg	
200	SD31791	Male	Bhler	Yannick Kumite Individual male U21 Open	
201	SD31791	Male	Bhler	Yannick Kumite Individual male U21 -67	
202		Male	Fitz	Diego Kumite Individual male U16 Open	
203		Male	Fitz	Diego Kumite Individual male Cadets -57	
204		Male	Fleisch	Tobias Kumite Individual male Cadets -63	
205		Male	Fleisch	Tobias Kumite Individual male U16 Open	
206		Male	Giesinger	Leon 26.03.21 Kumite Individual male U18 Open	
207		Male	Giesinger	Leon 26.03.21 Kumite Individual male Juniors -76	
208		Male	Jenni	Lorenz[BLZ V] Kumite Individual male U14 -55 kg	
209		Male	Jenni	Lorenz[BLZ V] Kumite Individual male U14 Open	
210	6888	Male	Kleinekathfer	Jakob Kumite Individual male U18 Open	
211	6888	Male	Kleinekathfer	Jakob Kumite Individual male Juniors +76	
212		Male	Kleinekathfer	Vincent Kumite Individual male U18 Open	
213		Male	Kleinekathfer	Vincent Kumite Individual male Juniors +76	
214		Female	Knnz	Jana[BLZ V] Kumite Individual female U16 Open	
215		Female	Knnz	Jana[BLZ V] Kumite Individual female Cadets -54	
216		Male	Mathis	Pascal Kumite Individual male Cadets +70	
217		Male	Mathis	Pascal Kumite Individual male U16 Open	
218		Female	Mayer	Macy Kumite Individual female U12 Open	
219		Female	Mayer	Macy Kumite Individual female U12 -36 kg	
220		Male	Meier	Henri Kumite male U10 -34kg	
221		Female	Mika	Yamaguchi Kumite Individual female U12 Open	
222		Female	Mika	Yamaguchi Kumite Individual female U12 -30 kg	
223		Female	Mhr	Magdalena 26.03.21 Kumite Individual female U18 Open	
224		Female	Mhr	Magdalena 26.03.21 Kumite Individual female Juniors -66	
225	AUT2345	Male	Nigsch	Adrian Kumite Individual male U21 -75	
226	AUT2345	Male	Nigsch	Adrian Kumite Individual male U21 Open	
227		Male	Nitz	Andreas Kumite Individual male U18 Open	
228		Male	Nitz	Andreas Kumite Individual male Juniors -68	
229		Male	Platisa	Pascal Kumite Individual male U16 Open	
230		Male	Platisa	Pascal Kumite Individual male Cadets -70	
231		Female	Sandholzer	Maya Kumite Individual female U14 -47 kg	
232		Female	Sandholzer	Maya Kumite Individual female U14 Open	
233		Male	Schnetzer	Eric Kumite Individual male U12 Open	
234		Male	Schnetzer	Eric Kumite Individual male U12 +38 kg	
235		Female	Schnetzer	Lara[BLZ V] Kumite Individual female U16 Open	
236		Female	Schnetzer	Lara[BLZ V] Kumite Individual female Cadets -54	
237		Female	Skrijelj	Sara Kumite Individual female Juniors -59	
238		Female	Skrijelj	Sara Kumite Individual female U18 Open	

# AUSTRIAN JUNIOR OPEN 2023

AUSTRIA  
Schulstrasse 17, 5071 Wals

2023.06.24 - 2023.06.24

## Tournament Participation (Entries) by Club

239	Female	Sopic	Noemi	Kumite Individual female U14 -52
240	Female	Sopic	Noemi	Kumite Individual female U14 Open
241	Male	Wagner	Emil	Kata Individual male Cadets
242	Male	Wagner	Felix	Kata Individual male Juniors
243	Male	Wagner	Felix	Kata Individual male Juniors R2-G2
244	Male	Wudler	Nathan Liam	Kumite Individual male U12 -32 kg

Entries: **53**

# AUSTRIAN JUNIOR OPEN 2023

AUSTRIA  
Schulstrasse 17, 5071 Wals

2023.06.24 - 2023.06.24

## Tournament Participation (Entries) by Club

 Karate Zanshin Koblach/Hard/Bregenz(Karate Zanshin)					
ID	Sex	Family Name	Given Name	Category	
245	Female	Berchtold	Pauline	Kata Individual female U12	
246	Female	Berchtold	Pauline	Kata Team female U12	
247	Female	Berchtold	Pauline	Kumite Individual female U12 +36 kg	
248	Male	Buttazoni	Hugo	Kumite male U10 +34kg	
249	Male	Buttazoni	Hugo	Kata Team male U14 U16	
250	Male	Buttazoni	Hugo	Kata Individual male U10	
251	Female	Coik	Lilly	Kumite Individual female U12 +36 kg	
252	Female	Coik	Lilly	Kata Individual female U12	
253	Female	Coik	Lilly	Kata Team female U12	
254	Female	Defranceschi	Rebecca	Kata Individual female Juniors	
255	Female	Defranceschi	Rebecca	Kumite Individual female Juniors +66	
256	Female	Defranceschi	Rebecca	Kumite Individual female U18 Open	
257	Male	Fend	Leo	Kata Team male U14 U16	
258	Male	Fend	Leo	Kumite Individual male U12 -38 kg	
259	Male	Fend	Leo	Kata Individual male U12	
260	Female	Jochum	Julia	Kumite Individual female U12 +36 kg	
261	Female	Jochum	Julia	Kata Individual female U12	
262	Female	Jochum	Julia	Kata Team female U12	
263	Female	Nolte	Alexandra	Kata Individual female U12	
264	Female	Nolte	Alexandra	Kumite Individual female U12 +36 kg	
265	Male	Stanikzaie	Hejratullah	Kumite Individual male U16 Open	
266	Male	Stanikzaie	Hejratullah	Kumite Individual male Cadets -57	
267	Male	Stanikzaie	Hejratullah	Kata Team male U14 U16	
268	Male	Stanikzaie	Hejratullah	Kata Individual male Cadets	

Entries: 24

# AUSTRIAN JUNIOR OPEN 2023

AUSTRIA  
Schulstrasse 17, 5071 Wals

2023.06.24 - 2023.06.24

## Tournament Participation (Entries) by Club

 Karate-Do Weiz(Karate-Do Weiz)					
ID	Sex	Family Name	Given Name	Category	
269	SD581336	Male	List	Fabio	Kata Individual male U14

Entries: 1

# AUSTRIAN JUNIOR OPEN 2023

AUSTRIA  
Schulstrasse 17, 5071 Wals

2023.06.24 - 2023.06.24

## Tournament Participation (Entries) by Club

 Karatedo Wels(Wels)					
ID	Sex	Family Name	Given Name	Category	
270	Female	Grandic	Nikolina	Kumite Individual female Juniors -53	
271	Female	Grandic	Nikolina	Kata Individual female Juniors	
272	Female	Popova	Varvara	Kata Individual female U21	

Entries: 3

# AUSTRIAN JUNIOR OPEN 2023

AUSTRIA  
Schulstrasse 17, 5071 Wals

2023.06.24 - 2023.06.24

## Tournament Participation (Entries) by Club

 <b>Kyokushin Karate SAMURAI(Kyokushin Karate SAMURAI)</b>					
ID	Sex	Family Name	Given Name	Category	
273	Male	NEZIRI	Amar	Kata Individual male U8	
274	Male	NEZIRI	Hamza	Kata Individual male U10	
275	Male	NEZIRI	Hamza	Kumite male U10 -34kg	
276	Female	NEZIRI	Melisa	Kata Individual female U12	

Entries: 4

# AUSTRIAN JUNIOR OPEN 2023

AUSTRIA  
Schulstrasse 17, 5071 Wals

2023.06.24 - 2023.06.24

## Tournament Participation (Entries) by Club

 <b>Leistungszentrum WIEN(LZ-Wien)</b>					
ID	Sex	Family Name	Given Name	Category	
277	Male	Anderl	Laurel	Kata Team male U12	
278	Male	Anderl	Laurel	Kata Individual male U8	
279	Male	Anderl	Lionel	Kumite male U10 -34kg	
280	Male	Anderl	Lionel	Kata Team male U12	
281	Male	Anderl	Lionel	Kata Individual male U10	
282	Male	Andraschko	Marcel	Kumite Individual male Cadets -63	
283	Male	Arnaut	Danis	Kata Individual male U14	
284	Male	Arnaut	Danis	Kumite Individual male U14 -40 kg	
285	Female	Asimi	Asma	Kata Team female U14	
286	Female	Asimi	Asma	Kata Individual female U14	
287	Female	Bagheri	Amene	Kata Individual female U12	
288	Female	Bagheri	Amene	Kata Team female U14	
289	Female	Bagheri	Farzana	Kata Individual female Cadets	
290	Male	Ebner	Fabio	Kumite Individual male U12 -38 kg	
291	Male	Ebner	Fabio	Kumite Individual male U12 Open	
292	Male	Ebner	Fabio	Kata Team male U12	
293	Female	Jafari	Fatima	Kata Team female U14	
294	Female	Jafari	Narges	Kumite Individual female U14 +52kg	
295	Female	Kovacevic	Leoni	Kumite Individual female Cadets -61	
296	Female	Kovacevic	Leoni	Kumite Individual female U16 Open	
297	Male	Lang	Marcus	Kumite Individual male Juniors -55	
298	Female	Lehner	Leonie	Kumite Individual female Cadets -61	
299	Female	Lehner	Leonie	Kumite Individual female U16 Open	
300	Male	Lffler	Mario	Kumite Individual male Cadets -63	
301	Male	Mosavi	Abolfasli	Kata Individual male U12	
302	Male	Mosavi	Abolfasli	Kumite Individual male U12 +38 kg	
303	Female	Mosavi	Setayesch	Kata Individual female U8	
304	Female	Neziri	Melisa	Kumite Individual female U12 -36 kg	
305	Female	Neziri	Melisa	Kumite Individual female U12 Open	
306	Female	Olszanska	Wiktoria	Kumite Individual female U16 Open	
307	Female	Olszanska	Wiktoria	Kumite Individual female Cadets -54	
308	Male	Prager	Sebastian	Kumite Individual male U12 -38 kg	
309	Male	Wu	Timon	Kata Individual male Juniors	
310	Male	Wu	Timon	Kata Individual male Juniors R2-G2	
311	Male	Wu	Timon	Kata Individual male Juniors R3 Bronze Medal Match 1	

Entries: 35



# AUSTRIAN JUNIOR OPEN 2023

AUSTRIA  
Schulstrasse 17, 5071 Wals

2023.06.24 - 2023.06.24

## Tournament Participation (Entries) by Club

 LZ Obersterreich(LZO)					
ID	Sex	Family Name	Given Name	Category	
312	Male	CHEBAN	Alexander	Kumite Individual male U14 -55 kg	
313	Male	Grigorasenco	Nichita	Kumite Individual male Juniors -76	
314	Female	KRAVCHENKO	Kateryna	Kumite Individual female Juniors -59	

Entries: 3

# AUSTRIAN JUNIOR OPEN 2023

AUSTRIA  
Schulstrasse 17, 5071 Wals

2023.06.24 - 2023.06.24

## Tournament Participation (Entries) by Club

 LZ Steiermark(LZ Stmk)					
ID	Sex	Family Name	Given Name	Category	
315	Male	Schmelzer	Marius	Kumite Individual male U18 Open	
316	Male	Schmelzer	Marius	Kumite Individual male Juniors -76	
317	Female	Wiesner	Nora	Kumite Individual female U16 Open	
318	Female	Wiesner	Nora	Kumite Individual female Cadets -54	

Entries: 4

# AUSTRIAN JUNIOR OPEN 2023

AUSTRIA  
Schulstrasse 17, 5071 Wals

2023.06.24 - 2023.06.24

## Tournament Participation (Entries) by Club

 Sportunion Mugendo Karate(SMK )					
ID	Sex	Family Name	Given Name	Category	
319	Male	Zchbauer	Samuel	Kata Individual male Juniors R3 Bronze Medal Match 1	
320	Male	Zchbauer	Samuel	Kata Individual male Juniors R2-G1	
321	Male	Zchbauer	Samuel	Kata Individual male Juniors	
322	Male	Zchling	Florian	Kata Individual male Juniors R3 Bronze Medal Match 2	
323	Male	Zchling	Florian	Kata Individual male Juniors	
324	Male	Zchling	Florian	Kata Individual male Juniors R2-G2	

Entries: 6

# AUSTRIAN JUNIOR OPEN 2023

AUSTRIA  
Schulstrasse 17, 5071 Wals

2023.06.24 - 2023.06.24

## Tournament Participation (Entries) by Club

 Sportunion Shuhari Graz(Shuhari Graz)					
ID	Sex	Family Name	Given Name	Category	
325	Male	Grynchak	Oleksandr	Kumite Individual male U14 -55 kg	
326	Female	Kletzenbauer	Alexandra	Kumite Individual female Cadets +61	

Entries: 2

# AUSTRIAN JUNIOR OPEN 2023

AUSTRIA  
Schulstrasse 17, 5071 Wals

2023.06.24 - 2023.06.24

## Tournament Participation (Entries) by Club

 UKA Zen Tai Ryu HAK St. Plten(ZTR HAK StP)					
ID	Sex	Family Name	Given Name	Category	
327	Female	HECK	Gloria	Kata Individual female Cadets R2-G1	
328	Female	HECK	Gloria	Kata Individual female Cadets	

Entries: 2

# AUSTRIAN JUNIOR OPEN 2023

AUSTRIA  
Schulstrasse 17, 5071 Wals

2023.06.24 - 2023.06.24

## Tournament Participation (Entries) by Club

 Union Karateclub Grieskirchen(UKC Grieskirchen)					
ID	Sex	Family Name	Given Name	Category	
329	Male	Flattinger	Clemens	Kata Individual male U14	
330	Female	Hinterberger	Mia	Kata Individual female U12	



Entries: 2

# AUSTRIAN JUNIOR OPEN 2023

AUSTRIA  
Schulstrasse 17, 5071 Wals

2023.06.24 - 2023.06.24

## Tournament Participation (Entries) by Club

 <b>CZECH REPUBLIC</b>					
 <b>Club karate Plzen(CK Plzen)</b>					
ID	Sex	Family Name	Given Name	Category	
331	Female	Kubnov	Anna	Kata Individual female Cadets R3-G2	
332	Female	Kubnov	Anna	Kata Individual female Cadets	
333	Female	Kubnov	Anna	Kata Individual female Cadets R2-G2	
334	Female	Kubnov	Elika	Kata Individual female U10	

Entries: 4

# AUSTRIAN JUNIOR OPEN 2023

AUSTRIA  
Schulstrasse 17, 5071 Wals

2023.06.24 - 2023.06.24

## Tournament Participation (Entries) by Club

 <b>Nidoshinkan Dojo(Nidoshinkan)</b>					
ID	Sex	Family Name	Given Name	Category	
335	Female	Malafov	Natie	Kata Individual female Juniors R2-G1	
336	Female	Malafov	Natie	Kata Individual female Juniors R3 Bronze Medal Match 2	
337	Female	Malafov	Natie	Kata Individual female Juniors	
338	Female	Malafov	Stella	Kata Individual female U10	

Entries: 4





# AUSTRIAN JUNIOR OPEN 2023

AUSTRIA  
Schulstrasse 17, 5071 Wals

2023.06.24 - 2023.06.24

## Tournament Participation (Entries) by Club

 DENMARK					
 Sportskarate.dk(SPD)					
ID	Sex	Family Name	Given Name	Category	
339	Female	Bath	Astamaja	Kumite Individual female Cadets -61	
340	Female	Bath	Astamaja	Kumite Individual female U16 Open	
341	Female	Bath	Astamaja	Kumite Individual female Cadets +61	
342	Female	Bath	Hannah	Kumite Individual female U14 Open	
343	Female	Bath	Hannah	Kumite Individual female U14 +52kg	
344	Female	Bath	Sofia	Kumite Individual female U16 Open	
345	Female	Bath	Sofia	Kumite Individual female Cadets -47	



Entries: 7

# AUSTRIAN JUNIOR OPEN 2023

AUSTRIA  
Schulstrasse 17, 5071 Wals

2023.06.24 - 2023.06.24

## Tournament Participation (Entries) by Club

 GERMANY					
 1. Kemptener Karate Dojo im TV Kempten(TVK)					
ID	Sex	Family Name	Given Name	Category	
346	Male	Bechteler	Lorenz	Kumite Individual male Cadets +70	
347	Male	Bechteler	Lorenz	Kumite Individual male U16 Open	

Entries: 2

# AUSTRIAN JUNIOR OPEN 2023

AUSTRIA  
Schulstrasse 17, 5071 Wals

2023.06.24 - 2023.06.24

## Tournament Participation (Entries) by Club

 1.CKKS Traunreut(1.CKKS)					
ID	Sex	Family Name	Given Name	Category	
348	Male	Boukrouh	Ahmed	Kumite Individual male U14 -55 kg	
349	Male	Boukrouh	Ahmed	Kumite Individual male U14 Open	
350	Female	Cosic	Medina	Kumite Individual female U14 +52kg	
351	Female	Dordevic	Teodoira	Kumite Individual female U14 -52	
352	Female	Dordevic	Teodoira	Kumite Individual female U14 Open	
353	Male	Fellinger	Philipp	Kumite Individual male U12 Open	
354	Male	Fellinger	Philipp	Kumite Individual male U12 +38 kg	
355	Female	Gisser	Isabel	Kumite Individual female Juniors -53	
356	Male	Gruchot	Maximilian	Kumite Individual male U12 -38 kg	
357	Male	Gruchot	Maximilian	Kumite Individual male U12 Open	
358	Female	Holzer	Dietke	Kumite Individual female Juniors -48	
359	Female	Hrvoic	Lana	Kumite Individual female Juniors +66	
360	Female	Hrvoic	Lana	Kumite Individual female U18 Open	
361	Male	Matsangos	Michali	Kata Individual male U10	
362	Male	Matsangos	Michali	Kumite male U10 -34kg	
363	Male	Medwedew	Daniel	Kumite Individual male U12 -38 kg	
364	Male	Menke	Jonathan	Kata Individual male U8	
365	Male	Menke	Jonathan	Kata Team male U10	
366	Male	Milic	Mika	Kata Team male U10	
367	Male	Milic	Mika	Kata Individual male U8	
368	Male	Rauen	Fernando	Kata Team male U10	
369	Female	Shchelkanova	Mascha	Kumite Individual female U12 +36 kg	
370	Female	Shchelkanova	Mascha	Kumite Individual female U12 Open	

Entries: 23

# AUSTRIAN JUNIOR OPEN 2023

AUSTRIA  
Schulstrasse 17, 5071 Wals

2023.06.24 - 2023.06.24

## Tournament Participation (Entries) by Club

 Asia Sports Karateschule (A.S. Waldkraiburg)					
ID	Sex	Family Name	Given Name	Category	
371	Female	Decker	Katharina	Kata Individual female U14	
372	Female	Decker	Katharina	Kumite Individual female U14 -52	
373	Female	Dressler	Lilli	Kata Individual female U14	
374	Female	Dressler	Lilli	Kumite Individual female U14 -52	
375	Female	Dressler	Lilli	Kata Team female U16	
376	Female	Dressler	Lilli	Kumite Individual female Cadets -54	
377	Female	Ehling	Isabella	Kumite Individual female U14 -47 kg	
378	Female	Ehling	Magdalena	Kata Individual female U14	
379	Female	Ehling	Magdalena	Kata Team female U14	
380	Female	Ehling	Magdalena	Kumite Individual female U14 -52	
381	Female	Ehling	Magdalena	Kata Team female U16	
382	Female	Ehling	Magdalena	Kata Individual female Cadets	
383	Male	Fischer	Markus	Kumite male U10 +34kg	
384	Male	Fischer	Markus	Kata Team male U12	
385	Male	Fischer	Markus	Kata Individual male U10	
386	Male	Fischer	Markus	Kata Individual male U12	
387	Female	Hapfelmeier	Louisa	Kata Team female U14	
388	Female	Hapfelmeier	Louisa	Kata Individual female U12	
389	Female	Hapfelmeier	Louisa	Kata Team female U12	
390	Female	Henneberg	Lea	Kata Individual female U10	
391	Female	Henneberg	Lea	Kata Individual female U8	
392	Female	Henneberg	Lea	Kata Team female U10	
393	Male	Htter	Michael	Kata Individual male U12	
394	Male	Htter	Michael	Kata Team male U12	
395	Male	Kolb	Maxim	Kata Individual male U8	
396	Female	Krieger	Lena	Kata Individual female U14	
397	Female	Krieger	Lena	Kata Team female U14	
398	Female	Krieger	Lena	Kumite Individual female U14 -52	
399	Female	Lampersberger	Emilia	Kumite Individual female U14 -42 kg	
400	Female	Lampersberger	Emilia	Kata Individual female U14	
401	Male	Lampersberger	Vincent	Kumite Individual male U14 Open	
402	Male	Lampersberger	Vincent	Kumite Individual male U14 +55 kg	
403	Female	Legler	Julia	Kata Individual female Cadets R3-G1	
404	Female	Legler	Julia	Kata Team female U16	
405	Female	Legler	Julia	Kata Individual female Cadets R2-G1	
406	Female	Legler	Julia	Kata Individual female Cadets	
407	Male	Libik	Daniel	Kata Individual male U14	
408	Male	Libik	Daniel	Kumite Individual male U14 -40 kg	
409	Female	Libik	Tamara	Kata Individual female Cadets	
410	Female	Libik	Tamara	Kumite Individual female Cadets -54	
411	Male	Mehlhaff	Alexander	Kata Individual male U12	
412	Male	Mehlhaff	Alexander	Kata Team male U12	
413	Male	Sauter	Lucas	Kata Individual male U8	
414	Female	Schmidt	Lena	Kata Team female U12	
415	Female	Schmidt	Lena	Kata Individual female U10	
416	Female	Schmidt	Lena	Kata Individual female U8	
417	Female	Schmidt	Lena	Kata Team female U10	

# AUSTRIAN JUNIOR OPEN 2023

AUSTRIA  
Schulstrasse 17, 5071 Wals

2023.06.24 - 2023.06.24

## Tournament Participation (Entries) by Club

418	Female	Schmidt	Lisa	Kata Individual female U10
419	Female	Schmidt	Lisa	Kata Team female U10
420	Female	Schmidt	Lisa	Kata Team female U12
421	Female	Schmidt	Lisa	Kumite individual female U10 +27
422	Male	Schmidt	Maximilian	Kata Individual male U8
423	Male	Schmidt	Maximilian	Kata Individual male U10
424	Male	Schmidt	Maximilian	kumite male u10 -28 kg
425	Female	Vlai	Jessica	Kata Individual female U21
426	Female	Vlai	Jessica	Kata Individual female U21 R2-G1
427	Female	Vlai	Jessica	Kata Individual female U21 R3 Gold Medal Match

Entries: **57**

# AUSTRIAN JUNIOR OPEN 2023

AUSTRIA  
Schulstrasse 17, 5071 Wals

2023.06.24 - 2023.06.24

## Tournament Participation (Entries) by Club

 <b>Bushido Stollberg e.V.(Bushido STL)</b>					
ID	Sex	Family Name	Given Name	Category	
428	Female	Baberske	Fabienne	Kumite Individual female Cadets -47	
429	Female	Baberske	Fabienne	Kumite Individual female U16 Open	

Entries: 2

# AUSTRIAN JUNIOR OPEN 2023

AUSTRIA  
Schulstrasse 17, 5071 Wals

2023.06.24 - 2023.06.24

## Tournament Participation (Entries) by Club

 Funakoshi Karate Northeim(FKN)					
ID	Sex	Family Name	Given Name	Category	
430	Male	Bradler	Luca	Kumite Individual male U14 -55 kg	
431	Male	Friedrich	Andre	Kumite Individual male Juniors -55	
432	Male	Haubold	Janne	Kumite Individual male U21 -84 +84	
433	Male	Haubold	Janne	Kumite Individual male U21 Open	
434	GER03119	Haubold	Mika	Kumite Individual male U18 Open	
435	GER03119	Haubold	Mika	Kumite Individual male Juniors -68	
436	Female	Khalil	Lana	Kumite Individual female U14 -42 kg	
437	Female	Khalil	Lana	Kumite Individual female U14 Open	
438	Male	Kindler	Ian	Kumite Individual male U18 Open	
439	Male	Kindler	Ian	Kumite Individual male Juniors -61	
440	Female	Safi	Dania	Kumite Individual female U12 -36 kg	
441	Male	Safi	Heidar	Kumite Individual male Cadets -57	
442	Female	Safi	Mallak	Kumite Individual female U14 -47 kg	

Entries: **13**

# AUSTRIAN JUNIOR OPEN 2023

AUSTRIA  
Schulstrasse 17, 5071 Wals

2023.06.24 - 2023.06.24

## Tournament Participation (Entries) by Club

 <b>Goju-Kai Amtsberg e.V.(Amtsberg)</b>					
ID	Sex	Family Name	Given Name	Category	
443	Female	Schlegel	Ronja	Kumite Individual female U12 Open	
444	Female	Schlegel	Ronja	Kumite Individual female U12 +36 kg	
445	Female	Voigt	Johanna	Kumite Individual female U12 Open	
446	Female	Voigt	Johanna	Kumite Individual female U12 +36 kg	
447	Male	Voigt	Tilmann	Kumite Individual male Cadets -63	
448	Male	Voigt	Tilmann	Kumite Individual male U16 Open	

Entries: 6



# AUSTRIAN JUNIOR OPEN 2023

AUSTRIA  
Schulstrasse 17, 5071 Wals

2023.06.24 - 2023.06.24

## Tournament Participation (Entries) by Club

 Karate-Do Rochlitz e.V.(Rochlitz)					
ID	Sex	Family Name	Given Name	Category	
449	Female	Fabian	Selina	Kumite Individual female U21 -50 -55	
450	Female	Fabian	Selina	Kumite Individual female U21 Open	
451	Male	Jger	Moritz	Kumite Individual male Cadets -52	
452	Female	Leiner	Lilly	Kumite Individual female Juniors -59	
453	Female	Schaller	Vanessa	Kumite Individual female Cadets +61	
454	Male	Schneider	Jonas	Kumite Individual male Cadets -57	
455	Male	Striesche	Dustin	Kumite Individual male Juniors -55	
456	Male	Striesche	Marvin	Kumite Individual male U16 Open	
457	Male	Striesche	Marvin	Kumite Individual male Cadets -57	

Entries: 9

# AUSTRIAN JUNIOR OPEN 2023

AUSTRIA  
Schulstrasse 17, 5071 Wals

2023.06.24 - 2023.06.24

## Tournament Participation (Entries) by Club

🇩🇪 Karate-Sport Milbertshofen(KS Milbertshofen)					
ID	Sex	Family Name	Given Name	Category	
458	Male	Topic	Ryan	Kumite Individual male U12 -32 kg	

Entries: 1

# AUSTRIAN JUNIOR OPEN 2023

AUSTRIA  
Schulstrasse 17, 5071 Wals

2023.06.24 - 2023.06.24

## Tournament Participation (Entries) by Club

 <b>KD Straubing(KD Straubing)</b>					
ID	Sex	Family Name	Given Name	Category	
459	Male	Circiroglu	Enis	Kumite Individual male Cadets -63	
460	Female	Schtz	Johanna	Kata Individual female U12	
461	Male	Wittmer	Leo	Kata Individual male U14	
462	Male	Wittmer	Leo	Kumite Individual male U14 -45 kg	

Entries: 4

# AUSTRIAN JUNIOR OPEN 2023

AUSTRIA  
Schulstrasse 17, 5071 Wals

2023.06.24 - 2023.06.24

## Tournament Participation (Entries) by Club

 Kvnnoordhorn(KVNoh)					
ID	Sex	Family Name	Given Name	Category	
463	Female	Altenhof	Mira	Kumite Individual female U12 -36 kg	
464	Female	Altenhof	Mira	Kumite Individual female U12 Open	
465	Male	Altenhof	Nico	Kumite Individual male U16 Open	
466	Male	Altenhof	Nico	Kumite Individual male Cadets -52	
467	Female	Satter	Anna	Kumite Individual female U10 -27 kg	
468	Female	Satter	Sara	Kumite Individual female U10 -27 kg	

Entries: 6

# AUSTRIAN JUNIOR OPEN 2023

AUSTRIA  
Schulstrasse 17, 5071 Wals

2023.06.24 - 2023.06.24

## Tournament Participation (Entries) by Club

 LV Brandenburg(BRA)					
ID	Sex	Family Name	Given Name	Category	
469	Male	Tschenisch	Thore	Kumite Individual male U18 Open	
470	Male	Tschenisch	Thore	Kumite Individual male Juniors -76	

Entries: 2

# AUSTRIAN JUNIOR OPEN 2023

AUSTRIA  
Schulstrasse 17, 5071 Wals

2023.06.24 - 2023.06.24

## Tournament Participation (Entries) by Club

 LV Sachsen-Anhalt(SAH)					
ID	Sex	Family Name	Given Name	Category	
471	Male	Ballin	Christopher	Kumite Individual male U18 Open	
472	Male	Ballin	Christopher	Kumite Individual male Juniors -76	
473	Female	Besancon	Joel Josephine	Kata Individual female U14	
474	Male	Heller	Ben	Kumite Individual male U16 Open	
475	Male	Heller	Ben	Kumite Individual male Cadets -63	
476	Male	Karaca	Ilyas	Kumite Individual male U12 Open	
477	Male	Karaca	Ilyas	Kumite Individual male U12 -32 kg	
478	Male	Knopp	Phil	Kumite Individual male U16 Open	
479	Male	Knopp	Phil	Kumite Individual male Cadets -70	
480	Male	Kuchel	Lennox	Kumite Individual male U14 -55 kg	
481	Male	Kuchel	Lennox	Kumite Individual male U14 Open	
482	Female	Olschewski	Hanna	Kumite Individual female U14 -42 kg	
483	Female	Olschewski	Hanna	Kumite Individual female U14 Open	
484	Male	Schmidt	Thorge	Kumite Individual male Juniors -68	
485	Female	Witte	Franziska	Kata Individual female Cadets R2-G1	
486	Female	Witte	Franziska	Kata Individual female Cadets	

Entries: 16

# AUSTRIAN JUNIOR OPEN 2023

AUSTRIA  
Schulstrasse 17, 5071 Wals

2023.06.24 - 2023.06.24

## Tournament Participation (Entries) by Club

 Nippon Gotha e.V.(Nippon GTH)					
ID	Sex	Family Name	Given Name	Category	
487	Female	Mattys	Melina	Kumite Individual female U14 +52kg	
488	Female	Mattys	Melina	Kumite Individual female U14 Open	
489	Female	Wicklein	Amy	Kumite Individual female Cadets -47	

Entries: 3

# AUSTRIAN JUNIOR OPEN 2023

AUSTRIA  
Schulstrasse 17, 5071 Wals

2023.06.24 - 2023.06.24

## Tournament Participation (Entries) by Club

 Okinawa Karate TSV Feichten(Okinawa Karate Feichten)					
ID	Sex	Family Name	Given Name	Category	
490	Male	Luja	Albert	Kata Individual male U14	
491	Male	Mijuskovic	Damian	Kata Individual male Cadets	
492	Male	Reiter	Patrick	Kata Individual male Juniors	
493	Male	Zwirglmaier	Simon	Kata Individual male U12	

Entries: 4



# AUSTRIAN JUNIOR OPEN 2023

AUSTRIA  
Schulstrasse 17, 5071 Wals

2023.06.24 - 2023.06.24

## Tournament Participation (Entries) by Club

 Okinawa Karate Tus Alztal Garching(TuS Alztal)					
ID	Sex	Family Name	Given Name	Category	
494	Male	Cornacchia	Angelo	Kata Individual male U10	
495	Male	Cornacchia	Edoardo	Kata Individual male U14	
496	Male	Pfeiffer	Thomas	Kata Individual male U21 R2 Bronze Medal Match 2	
497	Male	Pfeiffer	Thomas	Kata Individual male U21	
498	Female	Schachner	Claudia	Kata Individual female Juniors	

Entries: 5

# AUSTRIAN JUNIOR OPEN 2023

AUSTRIA  
Schulstrasse 17, 5071 Wals

2023.06.24 - 2023.06.24

## Tournament Participation (Entries) by Club

 Rhein-Neckar Knights(RNK)					
ID	Sex	Family Name	Given Name	Category	
499	Female	Abbas	Fiza	Kumite Individual female U14 +52kg	
500	Female	Camuffo	Debora	Kumite Individual female Cadets -54	
501	Male	Guidouche	Yacoub	Kumite Individual male Cadets -52	
502	Male	Ueberfeld	Fabian	Kumite Individual male Cadets -52	

Entries: 4

# AUSTRIAN JUNIOR OPEN 2023

AUSTRIA  
Schulstrasse 17, 5071 Wals

2023.06.24 - 2023.06.24

## Tournament Participation (Entries) by Club

 SEIWAKAI TEAM(SEIWAKAI TEAM)					
ID	Sex	Family Name	Given Name	Category	
503	Male	Deutsch	Pascal	Kumite Individual male U21 -84 +84	
504	Female	Drehmann	Emily-Chiara	Kumite Individual female Cadets -47	
505	Female	Filina	Amina	Kumite Individual female Juniors -66	
506	Female	Grfe	Lotte	Kumite Individual female Cadets +61	
507	Male	Grfe	Lukas	Kumite Individual male U14 -55 kg	
508	Male	Grnelt	Oliver	Kumite Individual male U14 -45 kg	
509	Female	Heinrich	Elenor	Kumite Individual female Cadets -54	
510	Male	Herzog	Wilhelm	Kumite Individual male Cadets -70	
511	Male	Kolb	Anton	Kumite Individual male U21 -75	
512	Female	Knig	Manja	Kumite Individual female U21 -50 -55	
513	Female	Meinert	Jacqueline	Kumite Individual female Cadets -54	
514	Male	Namyslik	Felix	Kumite Individual male U14 -50 kg	
515	Male	Nicklisch	Emil	Kumite Individual male U12 +38 kg	
516	Male	Stamer	Narvik	Kumite Individual male Juniors -68	
517	Male	Thierbach	Luca	Kumite Individual male Cadets -63	
518	Male	Zeiske	Dominik	Kumite Individual male Cadets +70	

Entries: 16

# AUSTRIAN JUNIOR OPEN 2023

AUSTRIA  
Schulstrasse 17, 5071 Wals

2023.06.24 - 2023.06.24

## Tournament Participation (Entries) by Club

 Sen5 Karate Verein e.V.(Sen5)					
ID	Sex	Family Name	Given Name	Category	
519	Female	Grner	Valentina	Kumite Individual female U12 -36 kg	
520	Female	Hellen	Ili	Kumite Individual female U16 Open	
521	Female	Hellen	Ili	Kumite Individual female Cadets -54	
522	Female	Hellinger	Luisa	Kumite Individual female U21 -50 -55	
523	Female	Muweiler	Mia	Kumite Individual female Cadets -61	
524	Female	Muweiler	Mia	Kumite Individual female U16 Open	
525	Male	Niederelz	Tim	Kumite Individual male U16 Open	
526	Male	Niederelz	Tim	Kumite Individual male Cadets -57	
527	Male	Ruris	Adrian	Kumite Individual male U18 Open	
528	Male	Ruris	Adrian	Kumite Individual male Juniors -61	
529	Female	Schindler	Miley	Kumite Individual female U14 Open	
530	Female	Schindler	Miley	Kumite Individual female U14 +52kg	
531	Female	Sirichenko	Anfissa	Kumite Individual female U12 -36 kg	

Entries: **13**

# AUSTRIAN JUNIOR OPEN 2023

AUSTRIA  
Schulstrasse 17, 5071 Wals

2023.06.24 - 2023.06.24

## Tournament Participation (Entries) by Club

 SV UNSU Karate Mmlingen e.V.(UNSU Team)					
ID	Sex	Family Name	Given Name	Category	
532	Female	Stel	Anna	Kata Individual female Juniors	
533	Female	Stel	Anna	Kata Individual female Juniors R3 Bronze Medal Match 1	
534	Female	Stel	Anna	Kata Individual female Juniors R2-G2	

Entries: 3

# AUSTRIAN JUNIOR OPEN 2023

AUSTRIA  
Schulstrasse 17, 5071 Wals

2023.06.24 - 2023.06.24

## Tournament Participation (Entries) by Club

 <b>Teikyo Karate Team e.V.(Teikyo Team)</b>					
ID	Sex	Family Name	Given Name	Category	
535	Male	Quadt	Lukas	Kumite Individual male U18 Open	
536	Male	Quadt	Lukas	Kumite Individual male Juniors -68	

Entries: 2

# AUSTRIAN JUNIOR OPEN 2023

AUSTRIA  
Schulstrasse 17, 5071 Wals

2023.06.24 - 2023.06.24

## Tournament Participation (Entries) by Club

 TSV Erding(TSV Erding)					
ID	Sex	Family Name	Given Name	Category	
537	Female	Bobbert	Aitana	Kata Individual female Cadets R2-G2	
538	Female	Bobbert	Aitana	Kata Individual female Cadets R4 Bronze Medal Match 2	
539	Female	Bobbert	Aitana	Kata Individual female Cadets R3-G2	
540	Female	Bobbert	Aitana	Kata Individual female Cadets	
541	Female	Bobbert	Isabella	Kata Individual female Juniors R2-G2	
542	Female	Bobbert	Isabella	Kata Individual female Juniors	
543	Female	Maelle	Locoge	Kata Individual female U21	

Entries: 7

# AUSTRIAN JUNIOR OPEN 2023

AUSTRIA  
Schulstrasse 17, 5071 Wals

2023.06.24 - 2023.06.24

## Tournament Participation (Entries) by Club

 TSV Grasbrunn-Neukeferloh(Neukeferloh)					
ID	Sex	Family Name	Given Name	Category	
544	Male	Douchet	Maxim	Kata Individual male U14	
545	Male	Douchet	Maxim	Kumite Individual male U14 -40 kg	
546	Male	Oelmaier	Jonathan	Kata Individual male Cadets	
547	Male	Oelmaier	Jonathan	Kumite Individual male Cadets -52	
548	Male	Probst	Arthur	Kumite Individual male U12 -32 kg	
549	Male	Probst	Arthur	Kata Individual male U12	
550	Male	Shamsi	Daniel	Kumite Individual male Juniors +76	
551	Male	Shamsi	Daniel	Kata Individual male Juniors	

Entries: **8**



# AUSTRIAN JUNIOR OPEN 2023

AUSTRIA  
Schulstrasse 17, 5071 Wals

2023.06.24 - 2023.06.24

## Tournament Participation (Entries) by Club

 TSV Monheim e.V.(TSVM)					
ID	Sex	Family Name	Given Name	Category	
552	Female	Bergmann	Liya	Kumite Individual female U14 Open	
553	Female	Bergmann	Liya	Kumite Individual female U14 +52kg	
554	Female	Gunzner	Katharina	Kata Individual female Cadets	
555	Male	Hurler	Elijah	Kata Individual male U12	
556	Male	Hurler	Elijah	Kumite Individual male U12 -32 kg	
557	Male	Knauer	Benedikt	Kumite Individual male Cadets +70	
558	Male	Knauer	Benedikt	Kumite Individual male U16 Open	
559	Female	Miller	Sarah	Kata Individual female U12	
560	Female	Pfeifer	Andressa	Kata Individual female U14	
561	Male	Rossmann	Leon	Kumite Individual male U14 Open	
562	Male	Rossmann	Leon	Kumite Individual male U14 -55 kg	

Entries: 11

# AUSTRIAN JUNIOR OPEN 2023

AUSTRIA  
Schulstrasse 17, 5071 Wals

2023.06.24 - 2023.06.24

## Tournament Participation (Entries) by Club

 TSV Vilsbiburg 1883 e.V.(TSV Vilsbiburg 1883 e.V.)					
ID	Sex	Family Name	Given Name	Category	
563	Female	Zehentbauer	Tina	Kumite Individual female U21 Open	
564	Female	Zehentbauer	Tina	Kumite Individual female U21 -61	



Entries: 2

# AUSTRIAN JUNIOR OPEN 2023

AUSTRIA  
Schulstrasse 17, 5071 Wals

2023.06.24 - 2023.06.24

## Tournament Participation (Entries) by Club

 HUNGARY					
 DMTK HUN(DMTK HUN)					
ID	Sex	Family Name	Given Name	Category	
565	Male	Czudor	Olivr	Kumite Individual male Cadets +70	
566	Male	Hercz	Bence	Kumite Individual male U14 -45 kg	
567	Female	Lipcsey	Dorottya	Kumite Individual female U21 -61	
568	Male	Ndudvari-Kiss	Ambrus	Kumite Individual male Juniors -68	
569	Male	Pter	Mrton	Kumite Individual male Cadets -57	
570	Male	rkos	Olivr	Kumite Individual male Cadets -70	



Entries: 6

# AUSTRIAN JUNIOR OPEN 2023

AUSTRIA  
Schulstrasse 17, 5071 Wals

2023.06.24 - 2023.06.24

## Tournament Participation (Entries) by Club

 ICELAND					
 Karateflag Reykjavkur(KFR)					
ID	Sex	Family Name	Given Name	Category	
571	Female	Embla Rebekka	Halldrsdttir	Kata Individual female Cadets R2-G2	
572	Female	Embla Rebekka	Halldrsdttir	Kumite Individual female U16 Open	
573	Female	Embla Rebekka	Halldrsdttir	Kumite Individual female Cadets -61	
574	Female	Embla Rebekka	Halldrsdttir	Kata Individual female Cadets	
575	Female	Eyds Magnea	Fririksdtir	Kata Individual female U21	
576	Female	Eyds Magnea	Fririksdtir	Kumite Individual female U21 -68	
577	Female	Eyds Magnea	Fririksdtir	Kumite Individual female U21 Open	
578	Male	Hugi	Halldrsson	Kumite Individual male Juniors +76	
579	Male	Hugi	Halldrsson	Kata Individual male Juniors	
580	Male	Hugi	Halldrsson	Kumite Individual male U18 Open	
581	Female	Ronja	Halldrsdttir	Kumite Individual female U21 Open	
582	Female	Ronja	Halldrsdttir	Kata Individual female U21 R3 Bronze Medal Match 1	
583	Female	Ronja	Halldrsdttir	Kata Individual female U21	
584	Female	Ronja	Halldrsdttir	Kumite Individual female U21 -61	
585	Female	Ronja	Halldrsdttir	Kata Individual female U21 R2-G2	
586	Male	rifur Magni	Halldrsson	Kata Individual male U8	



Entries: **16**

# AUSTRIAN JUNIOR OPEN 2023

AUSTRIA  
Schulstrasse 17, 5071 Wals

2023.06.24 - 2023.06.24

## Tournament Participation (Entries) by Club

 ITALY					
 A.S.D. Artesport(Artesport)					
ID	Sex	Family Name	Given Name	Category	
587	Female	Crucitti	Francesca	Kata Individual female Juniors	
588	Female	Crucitti	Francesca	Kata Individual female Juniors R3 Gold Medal Match	
589	Female	Crucitti	Francesca	Kata Individual female Juniors R2-G1	
590	Female	Crucitti	Sofia	Kata Individual female U14	
591	Male	Ollagnero	Giovanni Sebastian	Kata Individual male Cadets	
592	Male	Ollagnero	Giovanni Sebastian	Kata Individual male Cadets R2-G2	
593	Male	Paschetto	Federico	Kumite Individual male Cadets -63	

Entries: 7

# AUSTRIAN JUNIOR OPEN 2023

AUSTRIA  
Schulstrasse 17, 5071 Wals

2023.06.24 - 2023.06.24

## Tournament Participation (Entries) by Club

A.S.D. VILLA PIGNA KARATE(A.S.D. VILLA PIGNA KARATE)					
ID	Sex	Family Name	Given Name	Category	
594	Male	DAutorio	Igor	Kata Individual male U12	

Entries: 1

# AUSTRIAN JUNIOR OPEN 2023

AUSTRIA  
Schulstrasse 17, 5071 Wals

2023.06.24 - 2023.06.24

## Tournament Participation (Entries) by Club

 <b>Accademia dello Sport Livorno(Accademia dello Sport LI)</b>					
ID	Sex	Family Name	Given Name	Category	
595	Male	AGRUSA	ENEA	Kata Individual male U8	
596	Male	AGRUSA	ENEA	Kata Individual male U10	
597	Female	GRIMALDI	GIUSI	Kumite Individual female U10 -27 kg	
598	Female	Grimaldi	Giusy	Kata Individual female U8	
599	Male	MAGNELLI	EMANUELE	Kumite Individual male U18 Open	
600	Male	MAGNELLI	EMANUELE	Kumite Individual male Juniors +76	
601	Male	MAGNELLI	LEONARDO	Kumite Individual male U12 -38 kg	
602	Male	MAGNELLI	LEONARDO	Kumite Individual male U12 Open	
603	Male	Navacchi	Francesco	Kumite Individual male Cadets -63	
604	Male	PIETRONI	NICOLAS	Kumite Individual male U14 -50 kg	
605	Female	TISAIANU	GIULIA	KUMITE INDIVIDUAL FEMALE U10 -33kg	
606	Female	TISAIANU	GIULIA	Kumite individual female U10 +27	

Entries: **12**

# AUSTRIAN JUNIOR OPEN 2023

AUSTRIA  
Schulstrasse 17, 5071 Wals

2023.06.24 - 2023.06.24

## Tournament Participation (Entries) by Club

 <b>AKS Firenze(AKS Firenze)</b>					
ID	Sex	Family Name	Given Name	Category	
607	Male	Acquaioli	Tommaso	Kata Individual male U21 R2 Bronze Medal Match 2	
608	Male	Acquaioli	Tommaso	Kata Individual male U21	
609	Female	Andreini	Marta	Kata Individual female Cadets R3-G2	
610	Female	Andreini	Marta	Kata Individual female Cadets	
611	Female	Andreini	Marta	Kata Individual female Cadets R4 Bronze Medal Match 1	
612	Female	Andreini	Marta	Kata Individual female Cadets R2-G2	
613	Female	Balloni	Angelica	Kumite Individual female Juniors -59	
614	Male	Capaccioli	Cosimo	Kumite Individual male U14 -50 kg	
615	Male	De Meo	Marco	Kata Individual male U14	
616	Male	De Meo	Marco	Kata Team male U18	
617	Male	Fioravanti	Riccardo	Kata Team male U18	
618	Male	Fioravanti	Riccardo	Kata Individual male Cadets R3 Bronze Medal Match 2	
619	Male	Fioravanti	Riccardo	Kata Individual male Cadets	
620	Male	Fioravanti	Riccardo	Kata Individual male Cadets R2-G1	
621	Male	Mattera	Antonio	Kata Individual male Cadets R2-G2	
622	Male	Mattera	Antonio	Kata Individual male Cadets R3 Bronze Medal Match 1	
623	Male	Mattera	Antonio	Kata Individual male Cadets	
624	Male	Melani	Matteo	Kata Team male U18	
625	Male	Melani	Matteo	Kata Individual male Juniors	
626	Female	Metti	Lucia	Kumite Individual female U21 Open	
627	Female	Metti	Lucia	Kumite Individual female U21 -61	
628	Male	Risito	Matteo	Kumite Individual male Cadets +70	
629	Male	Risito	Matteo	Kumite Individual male U16 Open	
630	466364	Male	Ulqinaku	Leonardo Kumite Individual male U18 Open	
631	466364	Male	Ulqinaku	Leonardo Kumite Individual male Juniors +76	
632		Male	Zecchino	Alan Kumite Individual male Cadets -57	

Entries: **26**



# AUSTRIAN JUNIOR OPEN 2023

AUSTRIA  
Schulstrasse 17, 5071 Wals

2023.06.24 - 2023.06.24

## Tournament Participation (Entries) by Club

 ASD CENTRO STUDI KARATE NEGRAR(ASD CSK NEGRAR)					
ID	Sex	Family Name	Given Name	Category	
633	Female	Salvi	Caterina	Kumite Individual female U16 Open	
634	Female	Salvi	Caterina	Kumite Individual female Cadets -54	

Entries: 2

# AUSTRIAN JUNIOR OPEN 2023

AUSTRIA  
Schulstrasse 17, 5071 Wals

2023.06.24 - 2023.06.24

## Tournament Participation (Entries) by Club

 ASD HEIAN BUSHI DO(H.B.DO)					
ID	Sex	Family Name	Given Name	Category	
635	Male	BORASO	TANCREDI	Kumite Individual male U14 +55 kg	
636	Female	DEL TITO	EMANUELA	Kata Individual female Cadets	
637	Female	DI VIRGILIO	ALICE	Kata Individual female U21	
638	Female	DI VIRGILIO	ALICE	Kata Individual female U21 R2-G2	

Entries: 4

# AUSTRIAN JUNIOR OPEN 2023

AUSTRIA  
Schulstrasse 17, 5071 Wals

2023.06.24 - 2023.06.24

## Tournament Participation (Entries) by Club

 ASD karate Benaco(ASD karate Benaco)					
ID	Sex	Family Name	Given Name	Category	
639	Female	Crosatti	Elisa	Kumite Individual female U16 Open	
640	Female	Crosatti	Elisa	Kumite Individual female Cadets -61	
641	Female	Sartori	Martina	Kumite Individual female U16 Open	
642	Female	Sartori	Martina	Kumite Individual female Cadets -54	

Entries: 4

# AUSTRIAN JUNIOR OPEN 2023

AUSTRIA  
Schulstrasse 17, 5071 Wals

2023.06.24 - 2023.06.24

## Tournament Participation (Entries) by Club

 ASD RENSHUKAN TORINO(RENSHUKAN)					
ID	Sex	Family Name	Given Name	Category	
643	Female	Penso	Isotta	Kumite Individual female Cadets -47	

Entries: 1

# AUSTRIAN JUNIOR OPEN 2023

AUSTRIA  
Schulstrasse 17, 5071 Wals

2023.06.24 - 2023.06.24

## Tournament Participation (Entries) by Club

 ASD Shotokan Karate Pozzuolo del Friuli(SKZP)					
ID	Sex	Family Name	Given Name	Category	
644	Female	CAUFIN	EMMA	Kata Individual female U12	
645	Female	CECCHETTO	LARA	Kata Individual female U14	
646	Male	PAVAN	SEBASTIANO	Kata Individual male U14	

Entries: 3

# AUSTRIAN JUNIOR OPEN 2023

AUSTRIA  
Schulstrasse 17, 5071 Wals

2023.06.24 - 2023.06.24

## Tournament Participation (Entries) by Club

 ASD TALARICO KARATE TEAM APS(TKT)				
ID	Sex	Family Name	Given Name	Category
647	Female	CAPATTI	GIADA	Kumite Individual female Cadets -47
648	Female	CAPPAL	AMBRA	Kumite Individual female Juniors -48
649	Male	CIAVARELLA	NICCOLO	Kumite Individual male U12 +38 kg
650	Male	CIAVARELLA	RICCARDO	Kumite Individual male Cadets -63
651	Female	DI STEFANO	LAVINIA	Kumite Individual female U14 +52kg
652	Female	DUTTO	GIULIA	Kumite Individual female Cadets -61
653	Female	GIRELLO	ALESSANDRA	Kumite Individual female U14 -52
654	Female	GRANATIERO	SOFIA	Kumite Individual female Juniors -59
655	Male	Licata	Andrea	Kumite Individual male U14 -55 kg
656	Female	LICATA	GIULIA	Kumite Individual female U10 -27 kg
657	Female	Lungu	Alessandra	Kumite Individual female Cadets -61
658	Male	Marrucci	Filippo	Kumite Individual male U14 Open
659	Male	Marrucci	Filippo	Kumite Individual male U14 -45 kg
660	Female	Marrucci	Valentina	Kumite Individual female Juniors -53
661	Female	MONTEBELLO	CARLOTTA	Kumite Individual female Juniors +66
662	Male	NASSER	DIEGO	Kumite Individual male U14 -45 kg
663	Male	NASSER	PAOLO	Kumite Individual male Juniors -61
664	Female	Rocca	Margherita	Kumite Individual female Cadets -61
665	Male	SCHICCHI	STEFANO	Kumite Individual male U14 -50 kg
666	Female	SIMONE	SOFIA	Kumite Individual female U12 -30 kg
667	Female	SPAMPINATO	GIADA	Kumite Individual female U12 +36 kg
668	Male	Talarico	Luigi	Kumite Individual male U14 -45 kg
669	Male	TALARICO	MAURIZIO	Kumite Individual male U12 +38 kg
670	Female	TANCAU	ALESSIA	KUMITE INDIVIDUAL FEMALE U10 -33kg
671	Female	TANCAU	SARA	Kumite Individual female Cadets -54
672	Male	VERRASTRO	RICCARDO	Kumite Individual male Cadets +70

Entries: **26**

# AUSTRIAN JUNIOR OPEN 2023

AUSTRIA  
Schulstrasse 17, 5071 Wals

2023.06.24 - 2023.06.24

## Tournament Participation (Entries) by Club

 <b>Bushido Karate Perugia(BKP)</b>					
ID	Sex	Family Name	Given Name	Category	
673	Male	Brilli	Rocco	Kata Individual male Cadets	
674	Male	Crispoliti	Giulio	Kata Individual male U10	
675	Male	Fanali	Andrea	Kata Individual male U12	
676	Male	Fuscagni	Alex	Kata Team male U18	
677	Male	Fuscagni	Alex	Kata Individual male Juniors R3 Gold Medal Match	
678	Male	Fuscagni	Alex	Kata Individual male Juniors	
679	Male	Fuscagni	Alex	Kata Individual male Juniors R2-G2	
680	Female	Gibbs	Kassandra Iohan	Kata Individual female Cadets	
681	Male	Giovagnoni	Gioele	Kata Individual male Juniors R3 Gold Medal Match	
682	Male	Giovagnoni	Gioele	Kata Team male U18	
683	Male	Giovagnoni	Gioele	Kata Individual male Juniors R2-G1	
684	Male	Giovagnoni	Gioele	Kata Individual male Juniors	
685	Male	Magistrato	Nicola	Kata Individual male U14	
686	Male	Marcantonini	Edoardo	Kata Individual male U12	
687	Male	Pecorari	Giovanni	Kata Individual male U12	
688	Male	Romagnoli	Emanuel	Kata Individual male Cadets R2-G2	
689	Male	Romagnoli	Emanuel	Kata Team male U18	
690	Male	Romagnoli	Emanuel	Kata Individual male Cadets	
691	Male	Romagnoli	Emanuel	Kata Individual male Cadets R3 Gold Medal Match	
692	Male	Terelle	Armando	Kata Individual male U12	
693	Male	Zhou	Marco	Kata Individual male Cadets R2-G1	
694	Male	Zhou	Marco	Kata Individual male Cadets R3 Bronze Medal Match 1	
695	Male	Zhou	Marco	Kata Individual male Cadets	

Entries: 23

# AUSTRIAN JUNIOR OPEN 2023

AUSTRIA  
Schulstrasse 17, 5071 Wals

2023.06.24 - 2023.06.24

## Tournament Participation (Entries) by Club

 <b>CENTRO KARATE RIMINI(CKR)</b>					
ID	Sex	Family Name	Given Name	Category	
696	Male	Dan	Christian	Kumite Individual male U16 Open	
697	Male	Dan	Christian	Kumite Individual male Cadets -52	

Entries: 2



# AUSTRIAN JUNIOR OPEN 2023

AUSTRIA  
Schulstrasse 17, 5071 Wals

2023.06.24 - 2023.06.24

## Tournament Participation (Entries) by Club

 GARDA KARATE TEAM(GKT)					
ID	Sex	Family Name	Given Name	Category	
698	Male	Arici	Luca	Kumite Individual male U12 -38 kg	
699	Female	COBELLI	MADDALENA	Kumite Individual female U14 -52	
700	Female	DON	ALICE	Kumite Individual female U21 -61	
701	Male	Favalli	Leonardo	Kumite Individual male U12 -32 kg	
702	Female	MAFFIZZOLI	GAIA	Kumite Individual female Juniors -59	
703	Female	Maffizzoli	Lisa	Kumite Individual female Cadets -61	
704	Female	SPORTELLI	ELISA	Kumite Individual female Juniors +66	
705	Male	Tonni	Alessandro	kumite male u10 -28 kg	
706	Female	Viviani	Francesca Silvia	Kumite Individual female U12 -30 kg	

Entries: 9

# AUSTRIAN JUNIOR OPEN 2023

AUSTRIA  
Schulstrasse 17, 5071 Wals

2023.06.24 - 2023.06.24

## Tournament Participation (Entries) by Club

 Impero del sole a.s.d.(ids)					
ID	Sex	Family Name	Given Name	Category	
707	Male	Camarda	Claudio	Kumite Individual male Cadets -63	
708	Male	Camarda	Claudio	Kumite Individual male U16 Open	
709	Female	Ceriani	Giulia	Kumite Individual female U21 -50 -55	
710	Female	Ceriani	Giulia	Kumite Individual female U21 Open	
711	Female	Ceriani	Giulia	Kata Individual female U21	
712	Male	Eftimie	Eduard	Kumite Individual male Juniors -68	
713	Male	Eftimie	Eduard	Kata Individual male Juniors	
714	Male	Eftimie	Eduard	Kumite Individual male U18 Open	
715	Male	Fastigari	Valerio Luigi	Kumite Individual male U14 +55 kg	
716	Male	Fastigari	Valerio Luigi	Kata Individual male U14	
717	Male	Fastigari	Valerio Luigi	Kumite Individual male U14 Open	
718	Female	Fastigari	Viola Emilia	Kumite Individual female U14 Open	
719	Female	Fastigari	Viola Emilia	Kumite Individual female U14 +52kg	
720	Female	Fastigari	Viola Emilia	Kata Individual female U14	
721	Male	GARIBOLDI	MIRKO	Kumite Individual male U21 -75	
722	Male	GARIBOLDI	MIRKO	Kumite Individual male U21 Open	

Entries: 16

# AUSTRIAN JUNIOR OPEN 2023

AUSTRIA  
Schulstrasse 17, 5071 Wals

2023.06.24 - 2023.06.24

## Tournament Participation (Entries) by Club

 Karate Mhlbach(Karate Mhlbach)					
ID	Sex	Family Name	Given Name	Category	
723	Male	Fischnaller	Florian	Kumite Individual male U21 -75	
724	Male	Fischnaller	Florian	Kumite Individual male U21 Open	
725	Male	Pezzei	Fabian	Kumite Individual male U18 Open	
726	Male	Pezzei	Fabian	Kumite Individual male Juniors +76	

Entries: 4

# AUSTRIAN JUNIOR OPEN 2023

AUSTRIA  
Schulstrasse 17, 5071 Wals

2023.06.24 - 2023.06.24

## Tournament Participation (Entries) by Club

 Karate Nakayama(Karate Nakayama)					
ID	Sex	Family Name	Given Name	Category	
727	Female	Cerqui	Elena	Kumite Individual female U12 -36 kg	
728	Male	CERQUI	STEFANO	Kumite Individual male U14 -55 kg	
729	Female	Cornol	Giada	Kumite Individual female U18 Open	
730	Female	Cornol	Giada	Kumite Individual female Juniors -66	
731	Female	Dobre	Maria	KUMITE INDIVIDUAL FEMALE U10 +33kg	
732	Female	FAPPIANO	ELENA	Kumite Individual female U16 Open	
733	Female	FAPPIANO	ELENA	Kumite Individual female Cadets -54	
734	Male	Franchi	Giuseppe	Kumite Individual male U12 -32 kg	
735	Female	GHIRARDI	MARTINA	Kumite Individual female U14 -52	
736	Female	GIACOMINI	SOPHIA	Kumite Individual female U14 -42 kg	
737	Female	Handrikandu	SARA	Kumite Individual female U12 -36 kg	
738	Female	PALOMBI	SOFIA	Kumite Individual female U12 +36 kg	
739	Male	POPOV	CATALIN	Kumite Individual male Cadets -57	
740	Male	Rizzati	Thomas	Kumite Individual male U18 Open	
741	Male	Rizzati	Thomas	Kumite Individual male Juniors -68	
742	Female	Sanzo	Gloria	Kumite Individual female U12 -36 kg	

Entries: 16

# AUSTRIAN JUNIOR OPEN 2023

AUSTRIA  
Schulstrasse 17, 5071 Wals

2023.06.24 - 2023.06.24

## Tournament Participation (Entries) by Club

 <b>RYUGIN CODROIPO(RYUGIN)</b>					
ID	Sex	Family Name	Given Name	Category	
743	Male	Picogna	Francesco	Kumite Individual male U12 -32 kg	
744	Male	Schena	Mirko	Kumite Individual male U14 -40 kg	



Entries: 2

# AUSTRIAN JUNIOR OPEN 2023

AUSTRIA  
Schulstrasse 17, 5071 Wals

2023.06.24 - 2023.06.24

## Tournament Participation (Entries) by Club

 <b>KOSOVO</b>					
 <b>Karate Club Olimp(KC Olimp)</b>					
ID	Sex	Family Name	Given Name	Category	
745	Male	Gashi	Melos	Kumite Individual male U21 Open	
746	Male	Gashi	Melos	Kumite Individual male U21 -84 +84	

Entries: 2

# AUSTRIAN JUNIOR OPEN 2023

AUSTRIA  
Schulstrasse 17, 5071 Wals

2023.06.24 - 2023.06.24

## Tournament Participation (Entries) by Club

 Klubi i Karatесе Ippon-Prishtine(KK IPPON-Prishtine)					
ID	Sex	Family Name	Given Name	Category	
747	Male	Arifi	Aris	Kumite Individual male U12 -38 kg	
748	Male	Arifi	Aris	Kumite Individual male U12 Open	
749	Male	Arifi	Benet	Kumite male U10 -34kg	
750	KOS2051	Female	Istogu	Elmedina	Kumite Individual female U21 Open
751	KOS2051	Female	Istogu	Elmedina	Kumite Individual female U21 +68
752	Male	Mustafa	Haris	Kumite Individual male Cadets -70	
753	Male	Mustafa	Haris	Kumite Individual male U16 Open	



Entries: **7**

# AUSTRIAN JUNIOR OPEN 2023

AUSTRIA  
Schulstrasse 17, 5071 Wals

2023.06.24 - 2023.06.24

## Tournament Participation (Entries) by Club

 <b>NETHERLANDS</b>					
 <b>Unity99(Unity99)</b>					
ID	Sex	Family Name	Given Name	Category	
754	NED02683	Male	Werff	Kai	Kumite Individual male Juniors -68

Entries: 1





# AUSTRIAN JUNIOR OPEN 2023

AUSTRIA  
Schulstrasse 17, 5071 Wals

2023.06.24 - 2023.06.24

## Tournament Participation (Entries) by Club

 SLOVAKIA					
 Karate klub KUMADE Topoany(KUMADE TO)					
ID	Sex	Family Name	Given Name	Category	
755	Male	Ple	Richard	Kumite Individual male Cadets -57	
756	Female	Pleov	Viktria	Kumite Individual female Juniors -48	



Entries: 2

# AUSTRIAN JUNIOR OPEN 2023

AUSTRIA  
Schulstrasse 17, 5071 Wals

2023.06.24 - 2023.06.24

## Tournament Participation (Entries) by Club

 SLOVENIA					
 Karate Klub Kovinar Maribor(KK Kovinar Maribor)					
ID	Sex	Family Name	Given Name	Category	
757	Male	Bauman	Gal	Kumite Individual male Cadets -70	
758	Male	Rola	Luka	Kumite Individual male Cadets -63	
759	Male	Zari	Vid	Kumite Individual male Juniors -61	

Entries: 3

# AUSTRIAN JUNIOR OPEN 2023

AUSTRIA  
Schulstrasse 17, 5071 Wals

2023.06.24 - 2023.06.24

## Tournament Participation (Entries) by Club

Karate klub SEKI(KK Seki)					
ID	Sex	Family Name	Given Name	Category	
760	Female	KRISTI	KAROLINA	Kata Individual female U12	

Entries: 1

# AUSTRIAN JUNIOR OPEN 2023

AUSTRIA  
Schulstrasse 17, 5071 Wals

2023.06.24 - 2023.06.24

## Tournament Participation (Entries) by Club

### SWEDEN

#### Karateklubb Elit(KKELIT)

ID	Sex	Family Name	Given Name	Category
761	Male	Erhardt	Truls	Kata Individual male U14
762	Male	Erhardt	Truls	Kumite Individual male U14 Open
763	Male	Erhardt	Truls	Kumite Individual male U14 -50 kg



Entries: 3

# AUSTRIAN JUNIOR OPEN 2023

AUSTRIA  
Schulstrasse 17, 5071 Wals

2023.06.24 - 2023.06.24

## Tournament Participation (Entries) by Club

 SWITZERLAND					
 EKTS Lausanne Vufflens(EKTS Vaud)					
ID		Sex	Family Name	Given Name	Category
764	SUI SD47119	Female	SCHADEL	Kaena	Kata Individual female U14
765	SUI02236	Male	SCHADEL	Keni	Kata Individual male U21 R2 Gold Medal Match
766	SUI02236	Male	SCHADEL	Keni	Kata Individual male U21
767	SUI02743	Male	SCHADEL	Nolan	Kata Individual male Cadets

Entries: 4

# AUSTRIAN JUNIOR OPEN 2023

AUSTRIA  
Schulstrasse 17, 5071 Wals

2023.06.24 - 2023.06.24

## Tournament Participation (Entries) by Club

 <b>Elson Sport &amp; Karate(Elson Sport)</b>					
ID	Sex	Family Name	Given Name	Category	
768	Male	Kabashi	Elson Jason	Kumite Individual male Cadets -57	
769	Male	Kabashi	John	Kumite Individual male U21 -84 +84	
770	Male	Sanarica	Niccolo	Kumite Individual male U18 Open	
771	Male	Sanarica	Niccolo	Kumite Individual male Juniors -76	

Entries: 4

# AUSTRIAN JUNIOR OPEN 2023

AUSTRIA  
Schulstrasse 17, 5071 Wals

2023.06.24 - 2023.06.24

## Tournament Participation (Entries) by Club

Goju Kan Bern(Goju Kan Bern)					
ID	Sex	Family Name	Given Name	Category	
772	Male	Schertenleib	Janik	Kata Individual male Juniors	

Entries: 1

# AUSTRIAN JUNIOR OPEN 2023

AUSTRIA  
Schulstrasse 17, 5071 Wals

2023.06.24 - 2023.06.24

## Tournament Participation (Entries) by Club

[+] Karate Do Brugg(KDB)				
ID	Sex	Family Name	Given Name	Category
773	Male	Baranyi	Barnabas	Kumite Individual male U21 Open
774	Male	Baranyi	Barnabas	Kumite Individual male U21 -67
775	Male	Buhurcu	Jiyan	Kumite Individual male U16 Open
776	Male	Buhurcu	Jiyan	Kumite Individual male Cadets -70
777	Female	Caluori	Svenja	Kumite Individual female U18 Open
778	Female	Caluori	Svenja	Kumite Individual female Juniors -66
779	Male	Dobberstein	Lennox	Kumite Individual male U18 Open
780	Male	Dobberstein	Lennox	Kumite Individual male Juniors +76
781	Female	Duperrex	Oksana	Kumite Individual female U18 Open
782	Female	Duperrex	Oksana	Kumite Individual female Juniors -66
783	Female	Fleischmann	Alany Alexa	Kumite Individual female U16 Open
784	Female	Fleischmann	Alany Alexa	Kumite Individual female Cadets -47
785	Male	Lthy	Corsin Dion	Kata Individual male U14
786	Male	Lthy	Corsin Dion	Kumite Individual male U14 -40 kg
787	Male	Lthy	Corsin Dion	Kumite Individual male U14 Open
788	Male	Mateus Gomes	Cristiano	Kumite Individual male Cadets -52
789	Male	Mateus Gomes	Cristiano	Kata Individual male Cadets
790	Male	Mateus Gomes	Cristiano	Kumite Individual male U16 Open
791	Male	Mateus Gomes	Leonardo	Kumite Individual male U14 Open
792	Male	Mateus Gomes	Leonardo	Kata Individual male U14
793	Male	Mateus Gomes	Leonardo	Kumite Individual male U14 -40 kg
794	Female	Vignogna	Vivien	Kumite Individual female U18 Open
795	Female	Vignogna	Vivien	Kumite Individual female Juniors -53
796	Male	Vranjes	Andrej	Kumite Individual male U18 Open
797	Male	Vranjes	Andrej	Kumite Individual male Juniors -68

Entries: 25



# AUSTRIAN JUNIOR OPEN 2023

AUSTRIA  
Schulstrasse 17, 5071 Wals

2023.06.24 - 2023.06.24

## Tournament Participation (Entries) by Club

 <b>Karate Emme(Karate Emme)</b>					
ID	Sex	Family Name	Given Name	Category	
798	Female	Gallimore	Kim	Kata Team female U18	
799	Female	Gallimore	Kim	Kata Individual female Juniors	
800	Male	Mischler	Kevin	Kata Individual male Cadets	
801	Male	Mischler	Kevin	Kata Individual male Cadets R2-G2	
802	Male	Mischler	Kevin	Kata Individual male Cadets R3 Bronze Medal Match 2	
803	Female	Ritz	Lila	Kata Individual female Cadets R3-G1	
804	Female	Ritz	Lila	Kata Individual female Cadets R2-G1	
805	Female	Ritz	Lila	Kata Individual female Cadets	
806	Female	Ritz	Lila	Kata Individual female Cadets R4 Bronze Medal Match 1	
807	Female	Ritz	Lila	Kata Team female U18	
808	Female	Ritz	Maia	Kata Individual female U14	
809	Female	Ritz	Maia	Kata Team female U18	

Entries: **12**

# AUSTRIAN JUNIOR OPEN 2023

AUSTRIA  
Schulstrasse 17, 5071 Wals

2023.06.24 - 2023.06.24

## Tournament Participation (Entries) by Club

 Karatecenter Reto Kern Kreuzlingen(KCRK)					
ID	Sex	Family Name	Given Name	Category	
810	Female	Frischknecht	Jessica	Kumite Individual female U14 -42 kg	
811	Female	Frischknecht	Jessica	Kumite Individual female U14 Open	
812	Male	Frischknecht	Riley	Kumite Individual male U16 Open	
813	Male	Frischknecht	Riley	Kumite Individual male Cadets -52	
814	Female	Huber	Lea	Kumite Individual female U21 -50 -55	
815	Female	Huber	Lea	Kumite Individual female U21 Open	
816	SUI02567	Pelladoni	Gina	Kata Individual female Juniors	
817	SUI02567	Pelladoni	Gina	Kata Individual female Juniors R3 Bronze Medal Match 1	
818	SUI02567	Pelladoni	Gina	Kata Individual female Juniors R2-G1	
819	Male	Sieber	Elija	Kumite Individual male Cadets -63	
820	Male	Sieber	Elija	Kumite Individual male U16 Open	
821	Female	von Klass	Melissa	Kumite Individual female U14 Open	
822	Female	von Klass	Melissa	Kumite Individual female U14 -47 kg	
823	Female	Widmer	Alisha	Kumite Individual female U14 Open	
824	Female	Widmer	Alisha	Kumite Individual female U14 -42 kg	
825	Male	Zurlinden	Benjamin	Kumite Individual male U16 Open	
826	Male	Zurlinden	Benjamin	Kumite Individual male Cadets -63	
827	Male	Zurlinden	Jesse	Kumite Individual male U14 -45 kg	
828	Male	Zurlinden	Jesse	Kumite Individual male U14 Open	

Entries: 19

# AUSTRIAN JUNIOR OPEN 2023

AUSTRIA  
Schulstrasse 17, 5071 Wals

2023.06.24 - 2023.06.24

## Tournament Participation (Entries) by Club

 Karatedo Lyss-Aarberg(KDLyss)					
ID	Sex	Family Name	Given Name	Category	
829	Female	Bosshard	Lea Marie	Kumite Individual female U21 Open	
830	Female	Bosshard	Lea Marie	Kumite Individual female U21 -61	
831	Female	Burri	Liliane	Kumite Individual female Juniors -59	
832	Female	Burri	Liliane	Kumite Individual female U18 Open	
833	Female	Deuble	Sara	Kumite Individual female U21 -68	
834	Female	Deuble	Sara	Kumite Individual female U21 Open	
835	Female	Houthuijse	Melanie	Kumite Individual female U16 Open	
836	Female	Houthuijse	Melanie	Kumite Individual female Cadets -61	
837	Male	Jost	Ruben	Kumite Individual male Juniors -68	
838	Male	Jost	Ruben	Kumite Individual male U18 Open	
839	Female	Mhlemann	Noemi Emma	Kumite Individual female U14 Open	
840	Female	Mhlemann	Noemi Emma	Kumite Individual female U14 +52kg	
841	Female	Pulver	Melina	Kata Individual female U14	
842	Female	Pulver	Melina	Kumite Individual female U14 Open	
843	Female	Pulver	Melina	Kumite Individual female U14 +52kg	
844	Female	Streit	Kim Lara	Kumite Individual female Juniors -59	
845	Female	Streit	Kim Lara	Kumite Individual female U18 Open	
846	Female	Streit	Mila Chiara	Kumite Individual female Cadets -47	
847	Female	Streit	Mila Chiara	Kumite Individual female U16 Open	
848	Female	Tscharner	Anais	Kumite Individual female U16 Open	
849	Female	Tscharner	Anais	Kumite Individual female Cadets -54	
850	Male	Tscharner	Loan	Kumite Individual male U18 Open	
851	Male	Tscharner	Loan	Kumite Individual male Juniors -68	
852	Male	Uva	Nevio	Kumite Individual male Cadets -63	
853	Male	Uva	Nevio	Kumite Individual male U16 Open	

Entries: 25

# AUSTRIAN JUNIOR OPEN 2023

AUSTRIA  
Schulstrasse 17, 5071 Wals

2023.06.24 - 2023.06.24

## Tournament Participation (Entries) by Club

 karateschule sursee(k.s.sursee)					
ID	Sex	Family Name	Given Name	Category	
854	Female	Berisha	Madlene	Kumite Individual female Cadets +61	
855	Male	Cokovic	Benjamin	Kumite Individual male Cadets -63	
856	Female	Gerber	Yara	Kumite Individual female Cadets -47	
857	Female	Sellami	Inshirah	Kumite Individual female Cadets -47	
858	Female	Staub	Nia	Kumite Individual female Cadets +61	

Entries: 5

# AUSTRIAN JUNIOR OPEN 2023

AUSTRIA  
Schulstrasse 17, 5071 Wals

2023.06.24 - 2023.06.24

## Tournament Participation (Entries) by Club

 Karat Club Jaguar Vallorbe(KCJ)					
ID	Sex	Family Name	Given Name	Category	
859	Female	Michaud	Zo	Kumite Individual female U14 -42 kg	
860	Female	Michaud	Zo	Kumite Individual female U14 Open	
861	Female	Michaud	Zo	Kata Individual female U14	

Entries: 3

# AUSTRIAN JUNIOR OPEN 2023

AUSTRIA  
Schulstrasse 17, 5071 Wals

2023.06.24 - 2023.06.24

## Tournament Participation (Entries) by Club

 <b>Kashiva Kan Bienne(Kashiva Kan)</b>					
ID	Sex	Family Name	Given Name	Category	
862	Male	Patricio-Clmont	Johan	Kumite Individual male U14 -45 kg	
863	Male	Patricio-Clmont	Johan	Kumite Individual male U14 Open	

Entries: 2

# AUSTRIAN JUNIOR OPEN 2023

AUSTRIA  
Schulstrasse 17, 5071 Wals

2023.06.24 - 2023.06.24

## Tournament Participation (Entries) by Club

 <b>Kenseikan Karate-Do Thun(Ken Thun)</b>					
ID	Sex	Family Name	Given Name	Category	
864	Male	Ferreira Ribeiro	Deivid	Kumite Individual male Juniors -68	
865	Male	Ott	Simon	Kata Individual male Juniors	
866	Female	Tschanz	Olivia	Kata Individual female U21	
867	Female	Tschanz	Olivia	Kata Individual female U21 R3 Bronze Medal Match 2	
868	Female	Tschanz	Olivia	Kata Individual female U21 R2-G2	

Entries: 5

# AUSTRIAN JUNIOR OPEN 2023

AUSTRIA  
Schulstrasse 17, 5071 Wals

2023.06.24 - 2023.06.24

## Tournament Participation (Entries) by Club

 <b>Kimura Shukokai Karate Limmattal(Karate Limmattal)</b>					
ID	Sex	Family Name	Given Name	Category	
869	Male	Clingo	Elia	Kata Individual male U12	
870	Male	Clingo	Elia	Kumite Individual male U12 -32 kg	
871	Female	Gjergjaj	Amelie	Kata Individual female U10	
872	Female	Gjergjaj	Melisa	Kumite Individual female Cadets -61	
873	Female	Gjergjaj	Melisa	Kata Individual female Cadets	
874	Female	Gjergjaj	Melisa	Kata Individual female Cadets R2-G2	
875	Female	Gjergjaj	Melisa	Kumite Individual female U16 Open	
876	Female	Grossmann	Darja	Kata Individual female Juniors	
877	Female	Grossmann	Darja	Kumite Individual female Juniors -59	
878	Male	Kamilovski	Deny	Kumite Individual male U14 Open	
879	Male	Kamilovski	Deny	Kumite Individual male U14 -50 kg	
880	Male	Kamilovski	Deny	Kata Individual male U14	
881	Male	Kamilovski	Semi	Kata Individual male U10	
882	Female	Karakoc	Soraya	Kata Individual female U21	
883	Male	Kolarov	Maxim	Kata Individual male U8	
884	Female	Kolarova	Viktoria	Kata Individual female U12	
885	Female	Kolarova	Viktoria	Kumite Individual female U12 -36 kg	
886	Male	Komadina	Andrej	Kumite Individual male U14 Open	
887	Male	Komadina	Andrej	Kumite Individual male U14 +55 kg	
888	Male	Komadina	Andrej	Kata Individual male U14	
889	Male	Lim	Hao Yi	Kumite Individual male Cadets -52	
890	Male	Lim	Hao Yi	Kata Individual male Cadets	
891	Male	Loshaj	Murat	Kata Individual male Cadets	
892	Male	Loshaj	Murat	Kumite Individual male Cadets +70	
893	Male	Loshaj	Murat	Kumite Individual male U16 Open	
894	Female	Solazzo	Diamante	Kumite Individual female Cadets -47	
895	Female	Solazzo	Diamante	Kata Individual female Cadets R2-G1	
896	Female	Solazzo	Diamante	Kata Individual female Cadets	
897	Male	Solazzo	Ilario Nazareno	Kata Individual male Juniors R2-G1	
898	Male	Solazzo	Ilario Nazareno	Kata Individual male Juniors	
899	Male	Solazzo	Ilario Nazareno	Kumite Individual male U18 Open	
900	Male	Solazzo	Ilario Nazareno	Kumite Individual male Juniors -68	

Entries: **32**



# AUSTRIAN JUNIOR OPEN 2023

AUSTRIA  
Schulstrasse 17, 5071 Wals

2023.06.24 - 2023.06.24

## Tournament Participation (Entries) by Club

 RYUEI-RYU Karate Suisse(RKS)					
ID	Sex	Family Name	Given Name	Category	
901	SUI2185	Female	Miano	Lanyfer	Kata Individual female U21
902	SUI2185	Female	Miano	Lanyfer	Kata Individual female U21 R2-G1
903		Female	Neuenschwander	Ria	Kata Individual female U14

Entries: 3

# AUSTRIAN JUNIOR OPEN 2023

AUSTRIA  
Schulstrasse 17, 5071 Wals

2023.06.24 - 2023.06.24

## Tournament Participation (Entries) by Club

 Scuola di Karate YAMA NO KAZE(YAMA NO KAZE)					
ID	Sex	Family Name	Given Name	Category	
904	Female	Posavec	Alina Victoria	Kata Individual female U8	
905	Female	Posavec	Amlie Stphanie	Kata Individual female U8	

Entries: 2

# AUSTRIAN JUNIOR OPEN 2023

AUSTRIA  
Schulstrasse 17, 5071 Wals

2023.06.24 - 2023.06.24

## Tournament Participation (Entries) by Club

 <b>Shorin Ryu Karate Do Kloten(ISSKA)</b>					
ID	Sex	Family Name	Given Name	Category	
906	Male	Forgione	Mirco	Kata Individual male U21	
907	Male	Forgione	Mirco	Kata Individual male U21 R2 Bronze Medal Match 1	

Entries: 2

# AUSTRIAN JUNIOR OPEN 2023

AUSTRIA  
Schulstrasse 17, 5071 Wals

2023.06.24 - 2023.06.24

## Tournament Participation (Entries) by Club

 Shukokai Dojo Wetzikon(Shukokai Wetzikon)					
ID	Sex	Family Name	Given Name	Category	
908	Female	Beutler	Elina	Kumite Individual female U18 Open	
909	Female	Beutler	Elina	Kumite Individual female Juniors -59	
910	Female	Dalla Lana	Gianna	Kumite Individual female U14 Open	
911	Female	Dalla Lana	Gianna	Kumite Individual female U14 +52kg	
912	Female	De Carlo	Larissa	Kata Individual female Cadets	
913	Female	De Carlo	Larissa	Kumite Individual female U16 Open	
914	Female	De Carlo	Larissa	Kumite Individual female Cadets -54	
915	Female	Dusa	Natalie	Kata Individual female U10	
916	Female	Dusa	Natalie	KUMITE INDIVIDUAL FEMALE U10 +33kg	
917	Female	Dusa	Natalie	Kata Team female U12	
918	Male	Gubler	Linus	Kumite Individual male U14 -40 kg	
919	Male	Gubler	Linus	Kumite Individual male U14 Open	
920	Female	Keller	Ellie	Kata Team female U12	
921	Female	Keller	Ellie	Kumite Individual female U12 -30 kg	
922	Female	Keller	Ellie	Kata Individual female U12	
923	Female	Keller	Zoe	Kata Team female U12	
924	Female	Keller	Zoe	Kumite Individual female U12 -30 kg	
925	Female	Keller	Zoe	Kata Individual female U12	
926	Male	Logeswaran	Januyan	Kumite Individual male Juniors -61	
927	Male	Maurer	Noah	Kata Individual male U14	
928	Male	Maurer	Noah	Kumite Individual male U14 -40 kg	
929	Male	Mc Guinness	Colin	Kata Individual male U10	
930	Male	Mc Guinness	Colin	Kumite male U10 -34kg	
931	Male	Monteleone	Demetrius	Kata Individual male U10	
932	Male	Monteleone	Demetrius	kumite male u10 -28 kg	
933	Male	Negara	Andrei	Kata Individual male U10	
934	Male	Negara	Andrei	Kumite male U10 -34kg	
935	Male	Ochsner	Elia	Kumite Individual male Cadets -52	
936	Female	Poljak	Nina	Kumite Individual female U21 +68	
937	Male	Ravas	Karl	Kumite Individual male U14 -50 kg	
938	Male	Ravas	Karl	Kata Individual male U14	
939	Male	Ravas	Karl	Kumite Individual male U14 Open	

Entries: 32

# AUSTRIAN JUNIOR OPEN 2023

AUSTRIA  
Schulstrasse 17, 5071 Wals

2023.06.24 - 2023.06.24

## Tournament Participation (Entries) by Club

 SSKF Karate Team(SSKF Karate Team)					
ID	Sex	Family Name	Given Name	Category	
940	Male	Baumgarnter	Cebraill	Kumite Individual male U14 -55 kg	
941	Male	Baumgarnter	Cebraill	Kumite Individual male U14 Open	
942	Male	Cosse	Etienne	Kumite Individual male Juniors -55	
943	Female	Dumitras	Pia	Kumite Individual female U14 -52	
944	Female	Dumitras	Pia	Kumite Individual female U14 Open	
945	Female	Gibril	Hiba	Kumite Individual female Cadets -61	
946	Female	Gibril	Hiba	Kumite Individual female U16 Open	
947	Female	Payziner	Asya	KUMITE INDIVIDUAL FEMALE U10 +33kg	
948	Female	Payziner	Serena	Kumite Individual female U14 -47 kg	
949	Male	Schillaci	Samuele	Kumite Individual male U16 Open	
950	Male	Schillaci	Samuele	Kumite Individual male Cadets -57	
951	Male	Schmid	Samuel	Kumite Individual male Juniors -61	
952	Male	Sparer	Nico	Kumite Individual male U21 -75	
953	Male	Sparer	Nico	Kumite Individual male U21 Open	
954	Male	Tiefenauer	Jonathan	Kumite Individual male U12 Open	
955	Male	Tiefenauer	Jonathan	Kumite Individual male U12 +38 kg	
956	Male	Timmer	Eric	Kumite Individual male U21 -60	
957	Male	Torres	Steven	Kumite Individual male U18 Open	
958	Male	Torres	Steven	Kumite Individual male Juniors -68	

Entries: 19

# AUSTRIAN JUNIOR OPEN 2023

AUSTRIA  
Schulstrasse 17, 5071 Wals

2023.06.24 - 2023.06.24

## Tournament Participation (Entries) by Club

 <b>Swiss Karate Union(SKU)</b>				
ID	Sex	Family Name	Given Name	Category
959	Female	Anderes	Mathilde	Kumite Individual female U21 Open
960	Female	Anderes	Mathilde	Kumite Individual female U21 -61
961	Female	Arifagic	Almina	Kumite Individual female U14 +52kg
962	Female	Arifagic	Almina	Kumite Individual female U14 Open
963	Male	Bandelier	Mathis	Kumite Individual male Cadets +70
964	Male	Bandelier	Mathis	Kumite Individual male U16 Open
965	Female	Bonny	Shana	Kumite Individual female U18 Open
966	Female	Bonny	Shana	Kumite Individual female Juniors -66
967	Female	Bortot	Lucia	Kumite Individual female U21 -50 -55
968	Female	Bortot	Lucia	Kumite Individual female U21 Open
969	Female	Boutracit	Acha	Kumite Individual female Juniors -53
970	Male	Cajri	Milo	Kata Individual male Cadets
971	Male	Cajri	Milo	Kumite Individual male Cadets -57
972	Female	Campell	Larissa	Kata Individual female Cadets R2-G1
973	Female	Campell	Larissa	Kata Individual female Cadets
974	Male	Csurgai	Julien	Kumite Individual male U18 Open
975	Male	Csurgai	Julien	Kumite Individual male Juniors -61
976	Male	Daboubi	Yassine	Kumite Individual male Cadets -63
977	Male	Daboubi	Yassine	Kumite Individual male U16 Open
978	Female	Eiselt	Zoe	Kata Individual female Cadets R2-G2
979	Female	Eiselt	Zoe	Kata Individual female Cadets
980	Female	Fortunato	Emma	Kata Individual female Juniors
981	Male	Grasic	Ivan	Kumite Individual male Juniors -61
982	Female	Guye	Nina	Kumite Individual female Cadets -61
983	Female	Guye	Nina	Kumite Individual female U16 Open
984	Male	Halbich	Nicolas	Kumite Individual male U16 Open
985	Male	Halbich	Nicolas	Kumite Individual male Cadets -70
986	Male	Kury	Tiago	Kumite Individual male Juniors -55
987	Male	Limacher	Ramon	Kumite Individual male U14 -45 kg
988	Male	Limacher	Ramon	Kata Individual male U14
989	Male	Lorenz	Swan	Kumite Individual male U18 Open
990	Male	Lorenz	Swan	Kumite Individual male Juniors -68
991	Male	Marchioni	Matheo	Kumite Individual male U18 Open
992	Male	Marchioni	Matheo	Kumite Individual male Juniors -76
993	Male	Pedro	Tho	Kumite Individual male U16 Open
994	Male	Pedro	Tho	Kumite Individual male Cadets -70
995	Male	Pelivani	Denis	Kata Individual male Cadets
996	Male	Pelivani	Denis	Kata Individual male Cadets R2-G1
997	Male	Petrone	Leandro	Kata Individual male U21 R2 Bronze Medal Match 1
998	Male	Petrone	Leandro	Kata Individual male U21
999	Female	Redzic	Esma	Kumite Individual female U16 Open
1.000	Female	Redzic	Esma	Kumite Individual female Cadets +61
1.001	Male	Rouche	David	Kumite Individual male U21 -84 +84
1.002	Male	Rouche	David	Kumite Individual male U21 Open
1.003	Male	Schertenleib	Lars Noah	Kata Individual male U21 R2 Gold Medal Match
1.004	Male	Schertenleib	Lars Noah	Kata Individual male U21

# AUSTRIAN JUNIOR OPEN 2023

AUSTRIA  
Schulstrasse 17, 5071 Wals

2023.06.24 - 2023.06.24

## Tournament Participation (Entries) by Club

1.005	Female	Sigill	Anastasia	Kata Individual female U14
1.006	Female	Sigill	Anastasia	Kumite Individual female U14 -42 kg
1.007	Male	Soliaryk	Platon	Kata Individual male U14
1.008	Male	Soliaryk	Platon	Kumite Individual male U14 Open
1.009	Male	Soliaryk	Platon	Kumite Individual male U14 -50 kg
1.010	Female	Spielmann	Ilah	Kata Individual female Cadets
1.011	Female	Spielmann	Ilah	Kata Individual female Cadets R2-G2
1.012	Female	Suter	Anina	Kata Individual female U21
1.013	Female	Suter	Anina	Kata Individual female U21 R3 Gold Medal Match
1.014	Female	Suter	Anina	Kata Individual female U21 R2-G2
1.015	Female	Vazquez	Chlo	Kumite Individual female Juniors -48
1.016	Male	Vogel	Kaspar	Kata Individual male Juniors R3 Bronze Medal Match 2
1.017	Male	Vogel	Kaspar	Kata Individual male Juniors R2-G1
1.018	Male	Vogel	Kaspar	Kata Individual male Juniors
1.019	Male	Vogel	Kaspar	Kumite Individual male U18 Open
1.020	Male	Vogel	Kaspar	Kumite Individual male Juniors -76
1.021	Female	Weiss	Tiffany	Kata Individual female U14
1.022	Male	Wenger	Levin	Kumite Individual male U16 Open
1.023	Male	Wenger	Levin	Kumite Individual male Cadets -57
1.024	Female	Wyssbrod	Selin	Kumite Individual female Juniors -48
1.025	Female	Wyssbrod	Selin	Kumite Individual female U18 Open
1.026	Female	Zayed	Fatima	Kata Individual female Juniors
1.027	Female	Zayed	Fatima	Kata Individual female Juniors R2-G1
1.028	Male	Zecca	Lucas	Kumite Individual male U14 Open
1.029	Male	Zecca	Lucas	Kumite Individual male U14 -50 kg
1.030	Female	zdemir	Demet	Kumite Individual female U14 Open
1.031	Female	zdemir	Demet	Kata Individual female U14
1.032	Female	zdemir	Demet	Kumite Individual female U14 -42 kg



Entries: 74

# AUSTRIAN JUNIOR OPEN 2023

AUSTRIA  
Schulstrasse 17, 5071 Wals

2023.06.24 - 2023.06.24

## Tournament Participation (Entries) by Club

 UKRAINE					
 OKINAWA(oki)					
ID	Sex	Family Name	Given Name	Category	
1.033	Male	Hlushchenko	Artur	Kata Individual male Cadets	
1.034	Male	Hlushchenko	Artur	Kata Individual male Cadets R3 Gold Medal Match	
1.035	Male	Hlushchenko	Artur	Kata Individual male Cadets R2-G1	
1.036	Female	Studenkova	Daria	Kata Individual female Cadets R2-G1	
1.037	Female	Studenkova	Daria	Kata Individual female Cadets	
1.038	Female	Studenkova	Daria	Kata Individual female Cadets R4 Bronze Medal Match 2	
1.039	Female	Studenkova	Daria	Kata Individual female Cadets R3-G1	

Entries: 7





# AUSTRIAN JUNIOR OPEN 2023

AUSTRIA  
Schulstrasse 17, 5071 Wals

2023.06.24 - 2023.06.24

## Tournament Participation (Entries) by Club

 <b>UNITED STATES</b>					
 <b>USA Karate Team(USX Team)</b>					
ID	Sex	Family Name	Given Name	Category	
1.040	Female	Arcalean	Mihaela	Kumite Individual female U14 -52	
1.041	Female	Arcalean	Mihaela	Kumite Individual female U14 Open	
1.042	Male	Latty	Jonah	Kumite Individual male U16 Open	
1.043	Male	Latty	Jonah	Kumite Individual male Cadets -70	
1.044	Female	Latty	Kaylin	Kumite Individual female U16 Open	
1.045	Female	Latty	Kaylin	Kumite Individual female Cadets -47	
1.046	Female	Lavarnnway	Sydney	Kumite Individual female U16 Open	
1.047	Female	Lavarnnway	Sydney	Kumite Individual female Cadets -61	
1.048	Lottie Singleton	Female	Singleton	Lottie	Kumite Individual female U16 Open
1.049	Lottie Singleton	Female	Singleton	Lottie	Kumite Individual female Cadets -54
1.050	Female	Singleton	Sophie	Kumite Individual female Juniors -48	
1.051	Female	Singleton	Sophie	Kumite Individual female U18 Open	

Entries: 12

# AUSTRIAN JUNIOR OPEN 2023

---

AUSTRIA  
Schulstrasse 17, 5071 Wals

2023.06.24 - 2023.06.24

## Tournament Participation (Entries) by Club

Total Entries: **1.051**

# AUSTRIAN JUNIOR OPEN 2023

AUSTRIA  
Schulstrasse 17, 5071 Wals

2023.06.24 - 2023.06.24

## Statistics

Participating Countries: 15

Participating Regions: 31

Participating  
Team/Clubs: 97

	Competitors	Entries
Female	293	436
Male	309	463
<b>Total</b>	<b>602</b>	<b>899</b>

### Entries per Category

	Entries	Teams
KUMITE INDIVIDUAL FEMALE U10 +33kg	4	-
KUMITE INDIVIDUAL FEMALE U10 -33kg	2	-
Kata Individual female Cadets	26	-
Kata Individual female Juniors	20	-
Kata Individual female U10	11	-
Kata Individual female U12	22	-
Kata Individual female U14	26	-
Kata Individual female U21	13	-
Kata Individual female U8	11	-
Kata Individual male Cadets	23	-
Kata Individual male Juniors	16	-
Kata Individual male U10	19	-
Kata Individual male U12	20	-
Kata Individual male U14	27	-
Kata Individual male U21	6	-
Kata Individual male U8	12	-
Kata Team female U10	-	3
Kata Team female U12	-	4
Kata Team female U14	-	3
Kata Team female U16	-	3
Kata Team female U18	-	3
Kata Team male U10	-	4
Kata Team male U12	-	5
Kata Team male U14 U16	-	3
Kata Team male U18	-	2
Kumite Individual female Cadets +61	9	-
Kumite Individual female Cadets -47	12	-
Kumite Individual female Cadets -54	18	-
Kumite Individual female Cadets -61	15	-
Kumite Individual female Juniors +66	4	-

# AUSTRIAN JUNIOR OPEN 2023

AUSTRIA  
Schulstrasse 17, 5071 Wals

2023.06.24 - 2023.06.24

## Statistics

Kumite Individual female Juniors -48	7	-
Kumite Individual female Juniors -53	5	-
Kumite Individual female Juniors -59	11	-
Kumite Individual female Juniors -66	8	-
Kumite Individual female U10 -27 kg	4	-
Kumite Individual female U12 +36 kg	11	-
Kumite Individual female U12 -30 kg	7	-
Kumite Individual female U12 -36 kg	11	-
Kumite Individual female U12 Open	12	-
Kumite Individual female U14 +52kg	15	-
Kumite Individual female U14 -42 kg	10	-
Kumite Individual female U14 -47 kg	7	-
Kumite Individual female U14 -52	12	-
Kumite Individual female U14 Open	23	-
Kumite Individual female U16 Open	31	-
Kumite Individual female U18 Open	16	-
Kumite Individual female U21 +68	3	-
Kumite Individual female U21 -50 -55	7	-
Kumite Individual female U21 -61	8	-
Kumite Individual female U21 -68	4	-
Kumite Individual female U21 Open	13	-
Kumite Individual male Cadets +70	12	-
Kumite Individual male Cadets -52	11	-
Kumite Individual male Cadets -57	14	-
Kumite Individual male Cadets -63	18	-
Kumite Individual male Cadets -70	12	-
Kumite Individual male Juniors +76	10	-
Kumite Individual male Juniors -55	5	-
Kumite Individual male Juniors -61	8	-
Kumite Individual male Juniors -68	16	-
Kumite Individual male Juniors -76	10	-
Kumite Individual male U12 +38 kg	9	-
Kumite Individual male U12 -32 kg	10	-
Kumite Individual male U12 -38 kg	8	-
Kumite Individual male U12 Open	8	-
Kumite Individual male U14 +55 kg	4	-
Kumite Individual male U14 -40 kg	9	-
Kumite Individual male U14 -45 kg	12	-
Kumite Individual male U14 -50 kg	10	-
Kumite Individual male U14 -55 kg	11	-

# AUSTRIAN JUNIOR OPEN 2023

AUSTRIA  
Schulstrasse 17, 5071 Wals

2023.06.24 - 2023.06.24

## Statistics

Kumite Individual male U14 Open	21	-
Kumite Individual male U16 Open	34	-
Kumite Individual male U18 Open	31	-
Kumite Individual male U21 -60	2	-
Kumite Individual male U21 -67	2	-
Kumite Individual male U21 -75	6	-
Kumite Individual male U21 -84 +84	6	-
Kumite Individual male U21 Open	9	-
Kumite individual female U10 +27	2	-
Kumite male U10 +34kg	4	-
Kumite male U10 -34kg	10	-
kumite male u10 -28 kg	4	-
<b>Totals:</b>	<b>869</b>	<b>30</b>

# AUSTRIAN JUNIOR OPEN 2023

AUSTRIA  
Schulstrasse 17, 5071 Wals

2023.06.24 - 2023.06.24

## Officials Registration

### Coach

ASK Karate Kara(Kara)					
1		AUT	Michael	Kara	Coach
2		AUT	Franz	Schefbaumer	Coach

Entries: 2

ASK Karate SeiBuKan Neuhofen(SeiBuKan Neuhofen)					
3		AUT	Christian	Ramsebner	Coach

Entries: 1

ASK Karate Steyr(Steyr)					
4		AUT	Dejvid	Omerovic	Coach

Entries: 1

Ask SeiBuKan Linz(SBK Linz)					
5		AUT	Sabine	Ackerbauer	Coach
6		AUT	Hubert	Havlik	Coach
7		AUT	Shiyar	Mala_Hamza	Coach

Entries: 3

Frieways Karateklub(KC Frieways)					
8		AUT	Balazc	Lakner	Coach

Entries: 1

Goju Ryu Karate Kraft Wien(Goju Ryu Wien)					
9		AUT	Zahra	Abedi	Coach

Entries: 1

Karate Shotokan LORA Zell am See (SHOTOKAN LORA )					
10		AUT	Aleksandar	Grbic	Coach
11		AUT	Raphael	Kellner	Coach
12		AUT	Marko	Petrovic	Coach

Entries: 3

Karate Club Langenlois(Karate Club Langenlois)					
13		AUT	Verena	Kfinger	Coach

Entries: 1

KARATE DO WELS(WELS)					
14		AUT	Julia	Pichler	Coach
15		AUT	Ewald	Roth	Coach

Entries: 2

Karate Leistungszentrum Pinzgau(LZ Pinzgau)					
16		AUT	IVO	VUKOVIC	Coach

Entries: 1

Karate Union Kachikan(KU Kachikan)					
17		AUT	Filis	Celo	Coach
18		AUT	Susi	Presl	Coach

Entries: 2

Karate Union Shotokan Tirol(Karate St. Johann i.T.)					
19		AUT	Deni	Juric	Coach
20		AUT	Predrag	Juric	Coach
21		AUT	Matthias	Leitner	Coach

# AUSTRIAN JUNIOR OPEN 2023

AUSTRIA  
Schulstrasse 17, 5071 Wals

2023.06.24 - 2023.06.24

## Officials Registration

Entries: 3

 <b>Karate Union Walsersfeld(KU Walsersfeld)</b>					
22		AUT	Philipp	Khnel	Coach
23		AUT	Andrijana	Marjanovic	Coach
24		AUT	Sasa	Marjanovic	Coach
25		AUT	Claudia	Moser	Coach
26		AUT	Matjaz	Mller	Coach
27		AUT	Stefan	Mller	Coach
28		AUT	Nina	Vorderleitner	Coach
29		AUT	Nina	Wallner	Coach

Entries: 8

 <b>KARATE VORARLBERG(KARATE VORARLBERG)</b>					
30		AUT	Suat	Bayram	Coach
31		AUT	Narin	Bayram	Coach
32		AUT	Daniel	Devigili	Coach
33		AUT	Andrea	Forster	Coach
34		AUT	Fanny	Kellner	Coach
35		AUT	Bernadette	Kleinfurcher	Coach
36		AUT	Sarah	Kchle	Coach
37		AUT	Hermann	Mathis	Coach
38		AUT	Jean-Marc Mathias	Mayer	Coach
39		AUT	Daniel	Meier	Coach

Entries: 10

 <b>Karate Zanshin Koblach/Hard/Bregenz(Karate Zanshin)</b>					
40		AUT	Sabine	Berchtold	Coach
41		AUT	Christian	Buttazoni	Coach
42		AUT	Sanver	Demirtas	Coach
43		AUT	Martina	Fend	Coach
44		AUT	Oliver	Nolte	Coach
45		AUT	Serafettin	Sisman	Coach

Entries: 6

 <b>Karate-Do Weiz(Karate-Do Weiz)</b>					
46	OL/0309/AC RC	AUT	Gnter	List	Coach

Entries: 1

 <b>Karateclub Kleiner Drache, Mder(KC Mder)</b>					
47		AUT	Fanny	Kellner	Coach
48		AUT	Hermann	Mathis	Coach
49		AUT	Alexandra	Mathis	Coach
50		AUT	Nina	Sandholzer	Coach

Entries: 4

 <b>Karateclub SeiBuKan Dornbirn(KC Dornbirn)</b>					
51		AUT	Franziska	Forte	Coach

Entries: 1

 <b>Kyokushin Karate SAMURAI(Kyokushin Karate SAMURAI)</b>					
52		AUT	Bekim	Neziri	Coach

Entries: 1

 <b>Leistungszentrum WIEN(LZ-Wien)</b>					
53		AUT	Zahra	Abedi	Coach
54		AUT	Sonja	Anderl	Coach

# AUSTRIAN JUNIOR OPEN 2023

AUSTRIA  
Schulstrasse 17, 5071 Wals

2023.06.24 - 2023.06.24

## Officials Registration

55	AUT	Thomas	Anderl	Coach
----	-----	--------	--------	-------

Entries: 3

 LZ Steiermark(LZ Stmk)				
56	AUT	Mario	Schmelzer	Coach
57	AUT	Gnther	Stangl	Coach

Entries: 2

 Shotokan Salzburg(Shotokan Salzburg)				
58	AUT	Alisa	Buchinger	Coach
59	AUT	Maria	Lederer	Coach

Entries: 2

 Sportunion Mugendo Karate(SMK )					
60	N41/002	AUT	Monika_Johanna	Schulte	Coach

Entries: 1

 Sportunion Shuhari Graz(Shuhari Graz)				
61	AUT	Senad	Palackic	Coach

Entries: 1

 UKA Zen Tai Ryu HAK St. Plten(ZTR HAK StP)				
62	AUT	Marianne	KELLNER	Coach

Entries: 1

 Union Karateclub Grieskirchen(UKC Grieskirchen)				
63	AUT	Patricia	Reiter	Coach
64	AUT	Manfred	Rodler	Coach
65	AUT	Erna	Scheinecker	Coach

Entries: 3

 Club karate Plzen(CK Plzen)				
66	CZE	Jitka	Trojanova	Coach

Entries: 1

 Nidoshinkan Dojo(Nidoshinkan)				
67	CZE	Michaela	Malafov	Coach
68	CZE	Pavla	Musilova	Coach

Entries: 2

 TARGET SPORT MILOVICE(TSM)				
69	CZE	Vladimr	Ondovk	Coach

Entries: 1

 Sportskarate.dk(SPD)				
70	DEN	Astamaja	Bath	Coach
71	DEN	Mia	Bath	Coach
72	DEN	Chris	Bath	Coach
73	DEN	Hannah	Bath	Coach

Entries: 4

 Alzohour Club Egypt(ZcEgypt)					
74	EGYV0126	EGY	Hany	Abdelbaky	Coach

Entries: 1

 1.CKKS Traunreut(1.CKKS)				
75	GER	Lena	Fellinger	Coach



# AUSTRIAN JUNIOR OPEN 2023

AUSTRIA  
Schulstrasse 17, 5071 Wals

2023.06.24 - 2023.06.24

## Officials Registration

76		GER	Hr	GRUCHOT	Coach
77		GER	Herr	Kallo	Coach
78		GER	Patrick	Schalch	Coach
79		GER	Michael	Schalch	Coach
80		GER	Jaqueline	Schweichat	Coach
81		GER	Vladimir	Terengin	Coach

Entries: 7

### Asia Sports Karateschule (A.S. Waldkraiburg)

82		GER	Adnan	Akgn	Coach
83		GER	Jasmin	Dressler	Coach
84		GER	Marton	Libik	Coach
85		GER	Anika	Schmidt	Coach
86		GER	Ronny	Vlai	Coach
87		GER	Jessica	Vlai	Coach

Entries: 6

### Bushido Stollberg e.V.(Bushido STL)

88		GER	Selina	Fabian	Coach
----	--	-----	--------	--------	-------

Entries: 1

### Funakoshi Karate Northeim(FKN)

89		GER	Mark	Haubold	Coach
90		GER	Haissam	Khalil	Coach
91		GER	Hatam	Safi	Coach

Entries: 3

### Goju-Kai Amtsberg e.V.(Amtsberg)

92	GER03717	GER	Nathalie	Stahr	Coach
93		GER	Tilo	Voigt	Coach

Entries: 2

### Karate-Do Rochlitz e.V.(Rochlitz)

94		GER	Dirk	Schaller	Coach
95		GER	Ralf	Ziezio	Coach

Entries: 2

### KD Straubing(KD Straubing)

96		GER	Serkan	Circiroglu	Coach
97		GER	Markus	Hcherl	Coach

Entries: 2

### Kvnnordhorn(KVNoh)

98		GER	Elena	Altenhof	Coach
99		GER	Patricia	Satter	Coach

Entries: 2

### LV Sachsen-Anhalt(SAH)

100		GER	Christopher	Ballin	Coach
101		GER	Frank	Besancon	Coach
102		GER	Andy	Heller	Coach
103		GER	Michel	Olschewski	Coach
104		GER	Constanze	Olschewski	Coach
105		GER	Jens	Witte	Coach

Entries: 6

### Nippon Gotha e.V.(Nippon GTH)

106		GER	Dirk	Mattys	Coach
-----	--	-----	------	--------	-------

# AUSTRIAN JUNIOR OPEN 2023

AUSTRIA  
Schulstrasse 17, 5071 Wals

2023.06.24 - 2023.06.24

## Officials Registration

107	GER	Stefanie	Wicklein	Coach
-----	-----	----------	----------	-------

Entries: 2

### Okinawa Karate TSV Feichten(Okinawa Karate Feichten)

108	GER	Claudia	Reiter	Coach
-----	-----	---------	--------	-------

Entries: 1

### Okinawa Karate Tus Alztal Garching(TuS Alztal)

109	GER	Manfred	Pfeiffer	Coach
-----	-----	---------	----------	-------

110	GER	Andrea	Pfeiffer	Coach
-----	-----	--------	----------	-------

Entries: 2

### Rhein-Neckar Knights(RNK)

111	GER	Volker	Harren	Coach
-----	-----	--------	--------	-------

Entries: 1

### SEIWAKAI TEAM(SEIWAKAI TEAM)

112	GER	Anton	Kolb	Coach
-----	-----	-------	------	-------

113	GER	Jrg	Stamer	Coach
-----	-----	-----	--------	-------

114	GER	Katja	Thierbach	Coach
-----	-----	-------	-----------	-------

Entries: 3

### Sen5 Karate Verein e.V.(Sen5)

115	GER	Luisa	Hellinger	Coach
-----	-----	-------	-----------	-------

116	GER	Marcel	Schindler-Wei	Coach
-----	-----	--------	---------------	-------

Entries: 2

### Teikyo Karate Team e.V.(Teikyo Team)

117	GER	Matthias	Quadt	Coach
-----	-----	----------	-------	-------

Entries: 1

### TSV Erding(TSV Erding)

118	GER	Irmgard	Borgs	Coach
-----	-----	---------	-------	-------

Entries: 1

### TSV Grasbrunn-Neukeferloh(Neukeferloh)

119	GER	Alexander	Douchet	Coach
-----	-----	-----------	---------	-------

120	GER	Dominik	Schnaus	Coach
-----	-----	---------	---------	-------

121	GER	Esfandiar	Shamsi	Coach
-----	-----	-----------	--------	-------

Entries: 3

### TSV Monheim e.V.(TSVM)

122	GER	Thomas	Brandner	Coach
-----	-----	--------	----------	-------

123	GER	Tim	Brandner	Coach
-----	-----	-----	----------	-------

124	GER	Sarah	Brandner	Coach
-----	-----	-------	----------	-------

125	GER	Claudia	Miller	Coach
-----	-----	---------	--------	-------

Entries: 4

### ATHLITIKOS SYLLOGOS AMAROUSIOU(GR\_482)

126	GRE	KONSTANTINOS	NIKIFOROS	Coach
-----	-----	--------------	-----------	-------

Entries: 1

### DMTK HUN(DMTK HUN)

127	HUN	Bendegz	Kelemen	Coach
-----	-----	---------	---------	-------

128	HUN	Nic	Stanczel	Coach
-----	-----	-----	----------	-------

Entries: 2

# AUSTRIAN JUNIOR OPEN 2023

AUSTRIA  
Schulstrasse 17, 5071 Wals

2023.06.24 - 2023.06.24

## Officials Registration

Karateflag Reykjavkur(KFR)					
129		ISL	Haldr	Stefnsson	Coach

Entries: 1

A.S.D. Artesport(Artesport)					
130		ITA	Andrea	Crucitti	Coach
131		ITA	Vincenzo	Nicastro	Coach
132		ITA	Elena	Zegna	Coach

Entries: 3

A.S.D. VILLA PIGNA KARATE(A.S.D. VILLA PIGNA KARATE)					
133		ITA	Federico	DAutorio	Coach
134		ITA	Magdalena_Anna	DAutorio	Coach

Entries: 2

Accademia dello Sport Livorno(Accademia dello Sport LI)					
135	SMR112	ITA	Magnelli	Alessio	Coach
136		ITA	Rossana	Falco	Coach
137		ITA	Antonio	Magnelli	Coach

Entries: 3

AKS Firenze(AKS Firenze)					
138		ITA	Virginia	Castellucci	Coach
139		ITA	Leonardo	Marchi	Coach
140		ITA	ILARIA	PAOLETTI	Coach
141		ITA	Niccol	Zanella	Coach

Entries: 4

ASD CENTRO STUDI KARATE NEGRAR(ASD CSK NEGRAR)					
142	2598	ITA	Marijan	Pecirep	Coach

Entries: 1

ASD HEIAN BUSHI DO(H.B.DO)					
143		ITA	Alice	Di_Virgilio	Coach

Entries: 1

ASD karate Benaco(ASD karate Benaco)					
144		ITA	Giampaolo	Zacch	Coach

Entries: 1

ASD RENSHUKAN TORINO(RENSHUKAN)					
145		ITA	Michele	Magr	Coach

Entries: 1

ASD Shotokan Karate Pozzuolo del Friuli(SKZP)					
146		ITA	ALBERTO	PAVAN	Coach
147		ITA	PAOLO	ZAINA	Coach

Entries: 2

ASD TALARICO KARATE TEAM APS(TKT)					
148		ITA	MASSIMILIANO	CALDERAZZO	Coach
149		ITA	MATTEO	PUPPO	Coach
150	ITAV0031	ITA	GENNARO	TALARICO	Coach

Entries: 3

Bushido Karate Perugia(BKP)					
-----------------------------	--	--	--	--	--

# AUSTRIAN JUNIOR OPEN 2023

AUSTRIA  
Schulstrasse 17, 5071 Wals

2023.06.24 - 2023.06.24

## Officials Registration

151	ITA	Giovanni	Maurizi	Coach	Entries: 1	
<b>CENTRO KARATE RIMINI(CKR)</b>						
152	ITA	Livio	Montuori	Coach	Entries: 1	
<b>GARDA KARATE TEAM(GKT)</b>						
153	ITA	GIOVANNI	MARCHETTI	Coach	Entries: 1	
<b>Impero del sole a.s.d.(ids)</b>						
154	ITA	MASSIMO	DELLA_PATRONA	Coach	Entries: 1	
<b>Karate Mhlbach(Karate Mhlbach)</b>						
155	ITA	Martin	Pezzei	Coach	Entries: 1	
<b>Karate Nakayama(Karate Nakayama)</b>						
156	ITA	GIADA	CORNOL	Coach	Entries: 2	
157	ITA	ALESSANDRA	HASANI	Coach		
<b>RYUGIN CODROIPO(RYUGIN)</b>						
158	ITA	ADRIANO	MARCOLEONI	Coach	Entries: 1	
<b>Karate Club Olimp(KC Olimp)</b>						
159	KOS	Avni	Gashi	Coach	Entries: 1	
<b>Klubi i Karatese Ippon-Prishtine(KK IPPON-Prishtine)</b>						
160	KOS	Orges	Arifi	Coach	Entries: 1	
<b>Fudoshin Roermond(FUDROER)</b>						
161	NED	Roy	Heiming	Coach	Entries: 1	
<b>Unity99(Unity99)</b>						
162	NED02677	NED	Pieter	Werff	Coach	Entries: 1
<b>Karate Klub Kovinar Maribor(KK Kovinar Maribor)</b>						
163	SLO	Mateja	Zari_Bukovnik	Coach	Entries: 1	
<b>Karate klub SEKI(KK Seki)</b>						
164	SLO	Vladimir	Kristi	Coach	Entries: 1	
<b>EKTS Lausanne Vufflens(EKTS Vaud)</b>						
165	4769	SUI	Jean-Marc	SCHEDDEL	Coach	Entries: 2
166		SUI	Keni	SCHEDDEL	Coach	

# AUSTRIAN JUNIOR OPEN 2023

AUSTRIA  
Schulstrasse 17, 5071 Wals

2023.06.24 - 2023.06.24

## Officials Registration

 <b>Elson Sport &amp; Karate(Elson Sport)</b>					
167		SUI	Elson	Kabashi	Coach

Entries: 1

 <b>Goju Kan Bern(Goju Kan Bern)</b>					
168	4.436/ACRC	SUI	Andrea	Schertenleib	Coach

Entries: 1

 <b>Karate Do Brugg(KDB)</b>					
169		SUI	Silvia	Hirt	Coach
170		SUI	Anna	Hirt	Coach
171		SUI	Daniel	Humbel	Coach
172	SUI02643	SUI	Esther_Andrea	Lthi	Coach
173		SUI	Ramona	Ouchene	Coach
174		SUI	Achraf	Ouchene	Coach

Entries: 6

 <b>Karate Emme(Karate Emme)</b>					
175		SUI	Corinna	Gallimore_ -_Di_Giovanni	Coach
176		SUI	Andrea	Gonzalez	Coach
177		SUI	Pranadee	Mischler	Coach
178		SUI	Giang	Nguyen	Coach
179		SUI	Oliver	Ritz	Coach

Entries: 5

 <b>Karatecenter Reto Kern Kreuzlingen(KCRK)</b>					
180		SUI	Mike	Frischknecht	Coach
181		SUI	Nicole	Frischknecht	Coach
182		SUI	Reto	Kern	Coach
183		SUI	Emanuel	Nf	Coach
184		SUI	Dejan	Pavlovic	Coach
185	SUI02336	SUI	Daniela	Pelladoni	Coach

Entries: 6

 <b>Karatedo Lyss-Aarberg(KDLyss)</b>					
186		SUI	Lea	Bosshard	Coach
187		SUI	Francoise	Burri	Coach
188		SUI	Sara	Deuble	Coach
189		SUI	Ruben	Jost	Coach
190	SUIV0111	SUI	Demian	Seiler	Coach
191		SUI	Rudi	Seiler	Coach

Entries: 6

 <b>karateschule sursee(k.s.sursee)</b>					
192		SUI	Martin	Truttmann	Coach
193	SUI3003	SUI	JUTTA	WIMMER	Coach

Entries: 2

 <b>Karat Club Jaguar Vallorbe(KCJ)</b>					
194		SUI	Umit	Ozdemir	Coach
195		SUI	Donato	Zecca	Coach

Entries: 2

 <b>Kashiva Kan Bienne(Kashiva Kan)</b>					
196		SUI	Frederic	Patricio	Coach

Entries: 1

# AUSTRIAN JUNIOR OPEN 2023

AUSTRIA  
Schulstrasse 17, 5071 Wals

2023.06.24 - 2023.06.24

## Officials Registration

 <b>Kenseikan Karate-Do Thun(Ken Thun)</b>					
197		SUI	Olivia	Tschanz	Coach

Entries: 1

 <b>Kimura Shukokai Karate Limmattal(Karate Limmattal)</b>					
198		SUI	Soraya	Karakoc	Coach
199		SUI	Dangel	Karakoc	Coach
200		SUI	Nina	Schreiner_Karakoc	Coach
201		SUI	Ilario_Nazareno	Solazzo	Coach

Entries: 4

 <b>RYUEI-RYU Karate Suisse(RKS)</b>					
202	SUI02337	SUI	Frederick	Miano	Coach

Entries: 1

 <b>Scuola di Karate YAMA NO KAZE(YAMA NO KAZE)</b>					
203		SUI	Milena	Cekunec_Posavec	Coach

Entries: 1

 <b>Shorin Ryu Karate Do Kloten(ISSKA)</b>					
204		SUI	Ramona	Forgione	Coach

Entries: 1

 <b>Shukokai Dojo Wetzikon(Shukokai Wetzikon)</b>					
205		SUI	Januyan	Logeswaran	Coach
206		SUI	Taamira	Logeswaran	Coach
207		SUI	Peraveen	Raveendran	Coach
208		SUI	Riccardo	Terribilini	Coach

Entries: 4

 <b>SSKF Karate Team(SSKF Karate Team)</b>					
209		SUI	Bahattin	Kandaz	Coach
210		SUI	Patick	Sparer	Coach

Entries: 2

 <b>Swiss Karate Union(SKU)</b>					
211		SUI	Fabrizio	Gelsomino	Coach
212		SUI	Ilias	Graf	Coach
213		SUI	Gkhan	Gldr	Coach
214		SUI	Nomie	Kornfeld	Coach
215		SUI	Simone	Posavec	Coach
216		SUI	Michelle	Saner	Coach

Entries: 6

 <b>Karate klub KUMADE Topoany(KUMADE TO)</b>					
217		SVK	Zaneta	Paleov	Coach

Entries: 1

 <b>Karateklubb Elit(KKELIT)</b>					
218		SWE	Charlotte	Erhardt	Coach

Entries: 1

 <b>USA Karate Team(USX Team)</b>					
219		USA	Ciprian	Arcalean	Coach
220		USA	Denys	Morozov	Coach

Entries: 2

# AUSTRIAN JUNIOR OPEN 2023

AUSTRIA  
Schulstrasse 17, 5071 Wals

2023.06.24 - 2023.06.24

## Officials Registration

### Officials

🇦🇹 Ask SeiBuKan Linz(SBK Linz)					
221		AUT	Hubert	Havlik	Officials
Entries: 1					

🇦🇹 KARATE VORARLBERG(KARATE VORARLBERG)					
222		AUT	Nina	Sandholzer	Officials
223		AUT	Nicole	Schnetzler	Officials
Entries: 2					

🇮🇹 AKS Firenze(AKS Firenze)					
224		ITA	Leonardo	Marchi	Officials
Entries: 1					

🇰🇲 Klubi i Karatese Ippon-Prishtine(KK IPPON-Prishtine)					
225		KOS	Fadil	Arifi	Officials
Entries: 1					

🇨🇭 Independent Sports Photographer(Photographer)					
226		SUI	Marc	McGuinness	Officials
Entries: 1					

🇨🇭 Kimura Shukokai Karate Limmattal(Karate Limmattal)					
227		SUI	Yap	Gek_Leng	Officials
Entries: 1					

🇨🇭 RYUEI-RYU Karate Suisse(RKS)					
228		SUI	Lady	Miano	Officials
Entries: 1					

🇨🇭 Shukokai Dojo Wetzikon(Shukokai Wetzikon)					
229		SUI	Mirco	Dalla_Lana	Officials
Entries: 1					

🇨🇭 SWITZERLAND(SUI)					
230		SUI	DOMINIQUE	SIGILLO	Officials
Entries: 1					

🇺🇸 USA Karate Team(USX Team)					
231	Becky Singleton	USA	Becky	Singleton	Officials
Entries: 1					

# AUSTRIAN JUNIOR OPEN 2023

AUSTRIA  
Schulstrasse 17, 5071 Wals

2023.06.24 - 2023.06.24

## Officials Registration

### Referee

Austria Karate Shotokan LORA Zell am See (SHOTOKAN LORA )					
232		AUT	Afrim	Aliji	Referee
Entries: 1					

Austria Karate Club Langenlois(Karate Club Langenlois)					
233		AUT	Roland	Hsele	Referee
Entries: 1					

Czech Republic Club karate Plzen(CK Plzen)					
234	CZEV0001	CZE	Marek	Kubin	Referee
Entries: 1					

Switzerland Bushido Baden(BB)					
235		SUI	Anushanth	Selvam	Referee
Entries: 1					

Switzerland Karatedo Lyss-Aarberg(KD Lyss)					
236	SUI02732	SUI	Florian	Wernly	Referee
Entries: 1					

Switzerland karateschule sursee(k.s.sursee)					
237		SUI	Raffael	Lthold	Referee
Entries: 1					

Switzerland Shukokai Dojo Wetzikon(Shukokai Wetzikon)					
238		SUI	Loges	Kathirgamu	Referee
Entries: 1					

Switzerland Swiss Karate Union(SKU)					
239		SUI	Mattia	Castellana	Referee
240		SUI	Zeljko	Pesic	Referee
241		SUI	Sophie	Pfister	Referee
Entries: 3					



# AUSTRIAN JUNIOR OPEN 2023

---

AUSTRIA  
Schulstrasse 17, 5071 Wals

2023.06.24 - 2023.06.24

## Officials Registration

Total Entries:**241**

AUSTRIAN JUNIOR OPEN 2023 - 2023-06-24

Kata Individual female Cadets

R1 G1/4 (7) Tatami 1 09:45(2023-06-24)

Competitors	Kata	1	2	3	4	5	6	7	TOTAL	Extra	Total Rank
1 LEHNER TAMARA (KC FRIEWAYS)	047 KURURUNFA	7.7	7.7	(7.1)	(8.6)	7.6			23.0		23.0 2
2 ILIC MARTINA (KU WALSERFELD)	021 GOJUSHIHO SHO	6.3	6.8	(6.1)	(7.0)	6.2			19.3		19.3 6
3 SOLAZZO DIAMANTE (KARATE LIMMATTAL)	092 SUPARINPEI	7.2	7.4	(6.7)	(7.9)	7.3			21.9		21.9 4
4 CAMPPELL LARISSA (SKU)	068 PAPUREN	7.5	(8.3)	7.5	7.6	(7.1)			22.6		22.6 3
5 LEGLER JULIA (A.S. WALDKRAIBURG)	002 ANAN DAI	8.1	(8.5)	7.7	7.8	(7.4)			23.6		23.6 1
6 DE_CARLO LARISSA (SHUKOKAI WETZIKON)	097 TOMARI BASSAI	6.5	7.2	(6.0)	(8.0)	6.9			20.6		20.6 5
7 BAGHERI FARZANA (LZ-WIEN)	091 SOCHIN										-15.0 -15.0

R1 G2/4 (6) Tatami 1 10:15(2023-06-24)

Competitors	Kata	1	2	3	4	5	6	7	TOTAL	Extra	Total Rank
1 RITZ LILA (KARATE EMME)	008 CHATANYARA KUSHANKU	8.3	(7.5)	7.9	8.2	(8.4)			24.4		24.4 2
2 WITTE FRANZISKA (SAH)	078 SANSAI	(8.2)	(7.1)	7.1	7.6	7.2			21.9		21.9 4
3 HECK GLORIA (ZTR HAK STP)	092 SUPARINPEI	8.0	(6.9)	(8.2)	7.0	8.1			23.1		23.1 3
4 DEL_TITO EMANUELA (H.B.DO)	066 PACHU	(7.2)	(6.6)	6.8	6.6	6.9			20.3		20.3 6
5 GUNZNER KATHARINA (TSVM)	041 KANKU SHO	(7.3)	6.7	6.6	(6.2)	7.2			20.5		20.5 5
6 STUDENKOVA DARIA (OKI)	047 KURURUNFA	8.2	(7.3)	8.3	8.4	(8.7)			24.9		24.9 1

R1 G3/4 (7) Tatami 2 09:35(2023-06-24)

Competitors	Kata	1	2	3	4	5	6	7	TOTAL	Extra	Total Rank
1 LIBIK TAMARA (A.S. WALDKRAIBURG)	002 ANAN DAI	7.0	6.8	6.9	(7.1)	(6.5)			20.7		20.7 5
2 GIBBS KASSANDRA LOHAN (BKP)	030 HEIKU	(7.2)	6.6	6.7	(6.5)	6.6			19.9		19.9 6
3 BOBBERT AITANA (TSV ERDING)	008 CHATANYARA KUSHANKU	7.6	(7.8)	7.1	(6.9)	7.0			21.7		21.7 4
4 NIKOLI EMA (KARATE ST. JOHANN I.T.)	040 KANKU DAI	(5.8)	6.4	(6.6)	6.1	6.0			18.5		18.5 7
5 ANDREINI MARTA (AKS FIRENZE)	064 OHAN DAI	(7.8)	7.6	(7.4)	7.5	7.5			22.6		22.6 2
6 KUBINOVA ANNA (CK PLZEN)	067 PAIKU	(7.7)	7.4	7.6	7.7	(7.3)			22.7		22.7 1
7 EISELT ZOE (SKU)	086 SEISAN	7.4	(8.0)	7.2	(6.8)	7.2			21.8		21.8 3

R1 G4/4 (5) Tatami 2 10:05(2023-06-24)

Competitors	Kata	1	2	3	4	5	6	7	TOTAL	Extra	Total Rank
1 EMBLA_REBEKKA HALLDORSDOTTIR (KFR)	047 KURURUNFA	7.0	7.0	(7.1)	7.0	(6.9)			21.0		21.0 2
2 SPIELMANN ILÉAH (SKU)	021 GOJUSHIHO SHO	(6.6)	(7.3)	6.6	7.2	7.2			21.0		21.0 3
3 KORNER LEONIE (KC FRIEWAYS)	002 ANAN DAI	7.4	(7.2)	7.2	(7.5)	7.5			22.1		22.1 1
4 GJERGJAJ MELISA (KARATE LIMMATTAL)	068 PAPUREN	6.8	(7.4)	(6.5)	6.5	7.1			20.4		20.4 4
5 TSCHALER LARISSA (KU WALSERFELD)	021 GOJUSHIHO SHO	(6.3)	6.7	6.3	6.3	(6.8)			19.3		19.3 5

R2-G1

Competitors	Kata	1	2	3	4	5	6	7	TOTAL	Extra	Total Rank
1 RITZ LILA (KARATE EMME)	068 PAPUREN	(8.3)	(7.9)	8.2	8.0	8.0			24.2		24.2 3
2 SOLAZZO DIAMANTE (KARATE LIMMATTAL)	061 NIPAPO	7.5	(6.9)	7.4	(7.7)	7.3			22.2		22.2 6
3 LEGLER JULIA (A.S. WALDKRAIBURG)	009 CHIBANA NO KUSHANKU	(7.9)	(6.6)	7.7	7.9	7.8			23.4		23.4 4
4 CAMPPELL LARISSA (SKU)	047 KURURUNFA	(7.0)	7.2	7.3	(7.8)	7.3			21.8		21.8 8
5 LEHNER TAMARA (KC FRIEWAYS)	068 PAPUREN	8.2	8.3	(8.6)	(7.9)	8.4			24.9		24.9 1
6 HECK GLORIA (ZTR HAK STP)	019 GOJUSHIHO SHO	7.4	(7.6)	7.2	7.6	(7.1)			22.2		22.2 5
7 STUDENKOVA DARIA (OKI)	064 OHAN DAI	8.1	(7.8)	8.2	(8.3)	8.2			24.5		24.5 2
8 WITTE FRANZISKA (SAH)	015 GANKAKU	7.6	7.1	7.2	(8.0)	(6.3)			21.9		21.9 7

R2-G2

Competitors	Kata	1	2	3	4	5	6	7	TOTAL	Extra	Total Rank
1 ANDREINI MARTA (AKS FIRENZE)	002 ANAN DAI	(8.2)	7.6	7.5	7.5	(7.4)			22.6		22.6 1
2 GJERGJAJ MELISA (KARATE LIMMATTAL)	001 ANAN	(6.4)	(6.8)	6.6	6.5	6.8			19.9		19.9 8
3 EISELT ZOE (SKU)	047 KURURUNFA	7.2	(7.3)	7.1	(7.0)	7.0			21.3		21.3 5
4 BOBBERT AITANA (TSV ERDING)	068 PAPUREN	(7.8)	7.4	(7.3)	7.3	7.5			22.2		22.2 3
5 KUBINOVA ANNA (CK PLZEN)	068 PAPUREN	7.4	(6.9)	(7.6)	7.4	7.3			22.1		22.1 4
6 SPIELMANN ILÉAH (SKU)	020 GOJUSHIHO DAI	7.1	7.0	6.8	(6.7)	(7.3)			20.9		20.9 6
7 KORNER LEONIE (KC FRIEWAYS)	092 SUPARINPEI	7.5	(7.8)	(7.0)	7.3	7.6			22.4		22.4 2
8 EMBLA_REBEKKA HALLDORSDOTTIR (KFR)	001 ANAN	6.9	(7.2)	6.9	(6.2)	6.7			20.5		20.5 7

R3-G1

Competitors	Kata	1	2	3	4	5	6	7	TOTAL	Extra	Total Rank
-------------	------	---	---	---	---	---	---	---	-------	-------	------------

AUSTRIAN JUNIOR OPEN 2023 - 2023-06-24

Kata Individual female Cadets

1	RITZ LILA (KARATE EMME)	043 KISHIMOTO NO KUSHANKU	(8.5)	8.5	(7.7)	8.3	8.0					24.8		24.8	2
2	STUDENKOVA DARIA (OKI)	068 PAPUREN	8.3	8.1	(7.3)	(8.5)	8.4					24.8		24.8	3
3	LEGLER JULIA (A.S. WALDKRAIBURG)	068 PAPUREN	7.8	7.7	(7.0)	(8.0)	7.9					23.4		23.4	4
4	LEHNER TAMARA (KC FRIEWAYS)	009 CHIBANA NO KUSHANKU	(8.7)	8.3	8.0	(7.8)	8.5					24.8		24.8	1

R3-G2

Competitors	Kata	1	2	3	4	5	6	7	TOTAL	Extra	Total Rank
1 KUBINOVA ANNA (CK PLZEN)	002 ANAN DAI	7.3	(7.2)	7.4	(7.5)	7.2			21.9		21.9 4
2 BOBBERT AITANA (TSV ERDING)	002 ANAN DAI	7.5	7.4	(7.6)	(7.0)	7.4			22.3		22.3 2
3 ANDREINI MARTA (AKS FIRENZE)	008 CHATANYARA KUSHANKU	7.6	(7.8)	7.2	7.3	(6.9)			22.1		22.1 3
4 KORNER LEONIE (KC FRIEWAYS)	068 PAPUREN	7.7	(8.0)	(7.0)	7.1	7.6			22.4		22.4 1

R4 Bronze Medal Match 1

Competitors	Kata	1	2	3	4	5	6	7	TOTAL	Extra	Total Rank
1 RITZ LILA (KARATE EMME)	002 ANAN DAI	(7.7)	8.0	8.0	8.1	(8.4)			24.1		24.1 1
2 ANDREINI MARTA (AKS FIRENZE)	066 PACHU	(7.4)	7.8	7.5	7.7	(8.0)			23.0		23.0 2





R4 Bronze Medal Match 2

Competitors	Kata	1	2	3	4	5	6	7	TOTAL	Extra	Total Rank
1 STUDENKOVA DARIA (OKI)	092 SUPARINPEI	(8.0)	(7.4)	7.8	7.5	7.6			22.9		22.9 1
2 BOBBERT AITANA (TSV ERDING)	047 KURURUNFA	7.5	7.6	(8.0)	(7.1)	7.4			22.5		22.5 2

R4 Gold Medal Match

Competitors	Kata	1	2	3	4	5	6	7	TOTAL	Extra	Total Rank
1 LEHNER TAMARA (KC FRIEWAYS)	092 SUPARINPEI	(7.3)	7.4	7.5	(8.4)	8.0			22.9		22.9 1
2 KORNER LEONIE (KC FRIEWAYS)	009 CHIBANA NO KUSHANKU	(7.6)	7.6	(7.3)	7.6	7.5			22.7		22.7 2

Results

1	LEHNER TAMARA	FRIEWAYS KARATEKLUB		AUSTRIA
2	KORNER LEONIE	FRIEWAYS KARATEKLUB		AUSTRIA
3	RITZ LILA	KARATE EMME		SWITZERLAND
3	STUDENKOVA DARIA	OKINAWA		UKRAINE

# AUSTRIAN JUNIOR OPEN 2023 - 2023-06-24

## Kata Individual female Juniors

### R1 G1/2 (10) Tatami 1 11:45(2023-06-24)

Competitors	Kata	1	2	3	4	5	6	7	TOTAL	Extra	Total Rank
1 HARASSER MARISA (KARATE ST. JOHANN I.T.)	040 KANKU DAI	(6.0)	5.9	(5.8)	6.0	5.9			17.8		17.8 8
2 TREJO MELANIE (KC FRIEWAYS)											
3 BEKTIC JASMINA (KU WALSERFELD)											
4 ZAYED FATIMA (SKU)	047 KURURUNFA	(7.9)	(6.7)	7.8	7.9	7.3			23.0		23.0 4
5 PELLADONI GINA (KCRK)	002 ANAN DAI	(8.4)	(7.4)	8.1	8.3	7.8			24.2		24.2 3
6 MALAFOVÁ NATALIE (NIDOSHINKAN)	068 PAPUREN	8.5	(7.1)	8.4	8.5	(8.6)			25.4		25.4 1
7 SCHACHNER CLAUDIA (TUS ALZTAL)	036 JION	7.5	(6.4)	7.2	7.2	(7.7)			21.9		21.9 5
8 GROSSMANN DARJA (KARATE LIMMATTAL)	068 PAPUREN	(7.8)	(6.5)	6.8	7.6	7.0			21.4		21.4 7
9 CRUCITTI FRANCESCA (ARTESPORT)	047 KURURUNFA	(8.3)	(7.7)	8.0	8.0	8.2			24.2		24.2 2
10 GRANDIC NIKOLINA (WELS)	036 JION	7.3	7.2	7.0	(7.5)	(6.9)			21.5		21.5 6

### R1 G2/2 (10) Tatami 2 11:45(2023-06-24)

Competitors	Kata	1	2	3	4	5	6	7	TOTAL	Extra	Total Rank
1 GALLIMORE KIM (KARATE EMME)	068 PAPUREN	(7.3)	6.7	7.2	(6.5)	6.8			20.7		20.7 6
2 STÖSSEL ANNA (UNSU TEAM)	068 PAPUREN	7.5	(7.4)	7.8	7.5	(8.2)			22.8		22.8 2
3 GALATEANU EVELYN (SBK LINZ)	054 MEIKYO	(5.9)	6.5	6.0	6.0	(7.0)			18.5		18.5 9
4 DEFRANCESCHI REBECCA (KARATE ZANSHIN)	006 BASSAI DAI	(6.1)	6.2	6.2	6.1	(6.9)			18.5		18.5 8
5 STEGER ROSALIE (KARATE CLUB LANGENLOIS)	002 ANAN DAI	7.7	7.7	(7.6)	(8.0)	8.0			23.4		23.4 1
6 BOBBERT ISABELLA (TSV ERDING)	008 CHATANYARA KUSHANKU	7.1	6.9	(6.6)	7.2	(8.1)			21.2		21.2 4
7 LASTA KATJA (KARATE ST. JOHANN I.T.)	040 KANKU DAI	6.0	6.4	6.4	(5.9)	(7.2)			18.8		18.8 7
8 ARMAGAN ALEYNA (KU WALSERFELD)	005 BASSAI	(5.8)	(6.0)	5.8	5.8	5.8			17.4		17.4 10
9 EIDLER ELENA (KC FRIEWAYS)	092 SUPARINPEI	7.8	7.1	(6.7)	7.7	(8.3)			22.6		22.6 3
10 FORTUNATO EMMA (SKU)	021 GOJUSHIHO SHO	7.0	7.0	(6.5)	(7.3)	7.0			21.0		21.0 5

### R2-G1

Competitors	Kata	1	2	3	4	5	6	7	TOTAL	Extra	Total Rank
1 MALAFOVÁ NATALIE (NIDOSHINKAN)	092 SUPARINPEI	(8.4)	8.0	(7.8)	7.9	8.0			23.9		23.9 3
2 CRUCITTI FRANCESCA (ARTESPORT)	092 SUPARINPEI	(8.7)	8.2	(7.5)	8.2	8.2			24.6		24.6 1
3 ZAYED FATIMA (SKU)	092 SUPARINPEI	(7.8)	7.3	7.3	(7.2)	7.8			22.4		22.4 4
4 PELLADONI GINA (KCRK)	030 HEIKU	(8.6)	8.4	(7.6)	7.7	8.1			24.2		24.2 2

### R2-G2

Competitors	Kata	1	2	3	4	5	6	7	TOTAL	Extra	Total Rank
1 BOBBERT ISABELLA (TSV ERDING)	068 PAPUREN	(7.2)	6.9	7.2	7.1	(6.8)			21.2		21.2 4
2 EIDLER ELENA (KC FRIEWAYS)	009 CHIBANA NO KUSHANKU	7.4	7.5	6.8	(7.8)	(6.6)			21.7		21.7 2
3 STÖSSEL ANNA (UNSU TEAM)	009 CHIBANA NO KUSHANKU	(7.6)	7.2	(7.0)	7.3	7.0			21.5		21.5 3
4 STEGER ROSALIE (KARATE CLUB LANGENLOIS)	064 OHAN DAI	(7.9)	7.8	7.4	7.5	(6.9)			22.7		22.7 1

### R3 Bronze Medal Match 1

Competitors	Kata	1	2	3	4	5	6	7	TOTAL	Extra	Total Rank
1 PELLADONI GINA (KCRK)	064 OHAN DAI	7.8	7.9	(8.1)	8.0	(7.6)			23.7		23.7 2
2 STÖSSEL ANNA (UNSU TEAM)	092 SUPARINPEI	(8.2)	8.2	7.8	(7.6)	8.0			24.0		24.0 1



### R3 Bronze Medal Match 2

Competitors	Kata	1	2	3	4	5	6	7	TOTAL	Extra	Total Rank
1 MALAFOVÁ NATALIE (NIDOSHINKAN)	002 ANAN DAI	(8.2)	(7.0)	7.5	8.0	7.0			22.5		22.5 2
2 EIDLER ELENA (KC FRIEWAYS)	008 CHATANYARA KUSHANKU	7.8	7.2	7.8	(8.3)	(6.4)			22.8		22.8 1

### R3 Gold Medal Match

Competitors	Kata	1	2	3	4	5	6	7	TOTAL	Extra	Total Rank
1 CRUCITTI FRANCESCA (ARTESPORT)	068 PAPUREN	(8.2)	7.6	7.8	8.0	(7.4)			23.4		23.4 1
2 STEGER ROSALIE (KARATE CLUB LANGENLOIS)	068 PAPUREN	8.0	(7.4)	(8.1)	7.8	7.6			23.4		23.4 2

### Results

1 CRUCITTI FRANCESCA	A.S.D. ARTESPORT		ITALY
2 STEGER ROSALIE	KARATE CLUB LANGENLOIS		AUSTRIA
3 STÖSSEL ANNA	SV UNSU KARATE MÖMLINGEN E.V.		GERMANY

AUSTRIAN JUNIOR OPEN 2023 - 2023-06-24

Kata Individual female Juniors

3	EIDLER ELENA	FRIEWAYS KARATEKLUB		AUSTRIA
---	--------------	---------------------	---	---------

# Kata Individual female U10

AUSTRIAN JUNIOR OPEN 2023, Schulstrasse 17, 5071 Wals, AUT

2023-06-24

Tatami  
6 10:40

Pool  
1/1

Henneberg Lea (A.S. Waldkraiburg)  
025 Heian Shodan 5 | Henneberg Lea (A.S. Waldkraiburg)  
026 Heian Nidan 2

Gärtner Anna (KU Walsersfeld) 0 | Kubínová Eliška (CK Plzen) 0

Kubínová Eliška (CK Plzen) 3 | Kubínová Eliška (CK Plzen) 0

Gjergjaj Amelie (Karate Limmattal) 0 | Malafova Stella (Nidoshinkan) 4

Malafova Stella (Nidoshinkan) 5 | Malafova Stella (Nidoshinkan) 5

Huskic Diana (SBK Linz) 1 | Huskic Diana (SBK Linz) 1

Presl Lina (KU Kachikan) 5 | Presl Lina (KU Kachikan) 2

Dusa Natalie (Shukokai Wetzikon) 0 | Schmidt Lena (A.S. Waldkraiburg) 4

Schmidt Lena (A.S. Waldkraiburg) 3 | Schmidt Lena (A.S. Waldkraiburg) 4

Schmidt Lisa (A.S. Waldkraiburg) 5 | Schmidt Lisa (A.S. Waldkraiburg) 1

Erlinger Isabella (KU Walsersfeld) 0 | Erlinger Isabella (KU Walsersfeld) 0

Final

Malafova Stella (Nidoshinkan) 1

Schmidt Lena (A.S. Waldkraiburg)

Schmidt Lena (A.S. Waldkraiburg) 4



- |                                       |
|---------------------------------------|
| 1. SCHMIDT LENA (A.S. WALDKRAIBURG)   |
| 2. MALAFOVÁ STELLA (NIDOSHINKAN)      |
| 3. PRESL LINA (KU KACHIKAN)           |
| 3. KUBÍNOVÁ ELIŠKA (CK PLZEN)         |
| 5. SCHMIDT LISA (A.S. WALDKRAIBURG)   |
| 5. HUSKIC DIANA (SBK LINZ)            |
| 7. GJERGJAJ AMELIE (KARATE LIMMATTAL) |

Referees:			

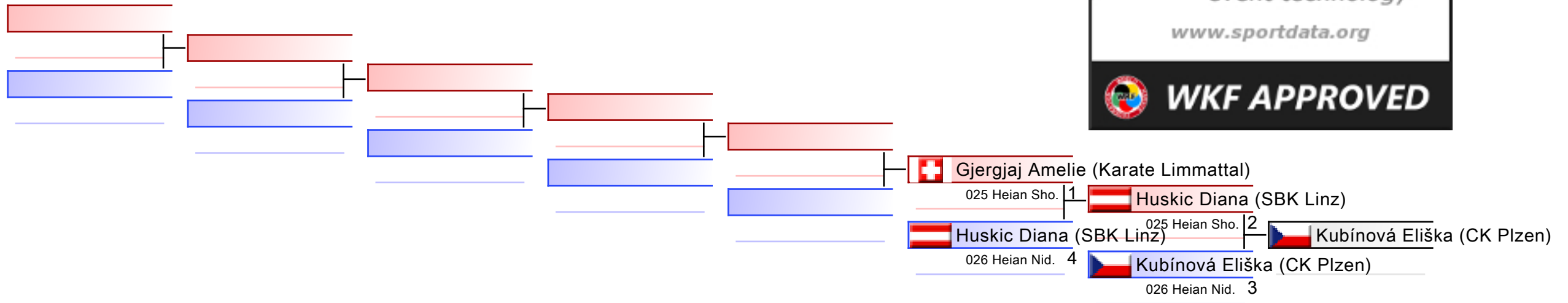

REPECHAGE: (1)

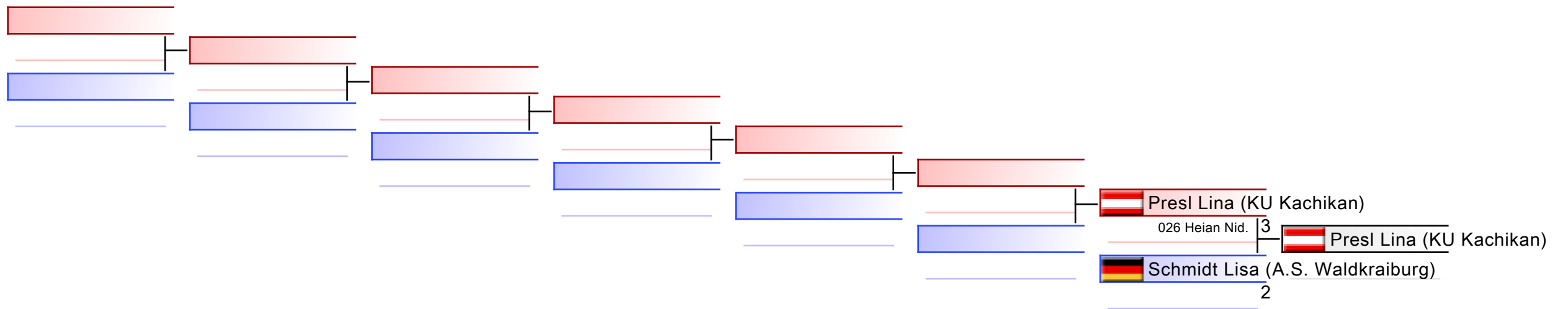

Referees:							
-----------	--	--	--	--	--	--	--

# Kata Individual female U12

AUSTRIAN JUNIOR OPEN 2023, Schulstrasse 17, 5071 Wals, AUT

2023-06-24

Tatami  
5 11:50

Pool  
1/1

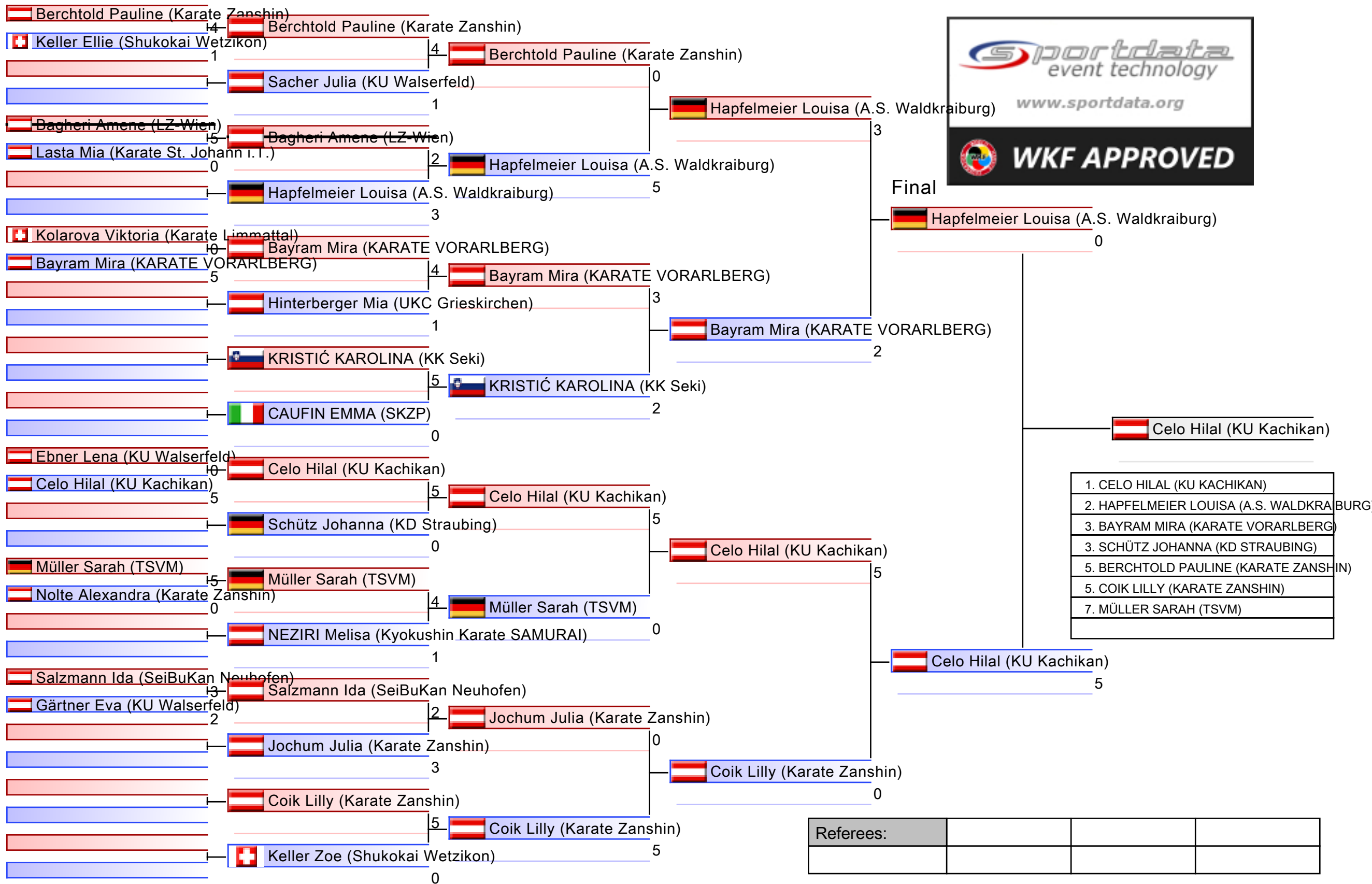



# Kata Individual female U12

AUSTRIAN JUNIOR OPEN 2023

2023-06-24

Tatami  
5 11:50

Pool  
1

(c)sportdata GmbH & Co KG 2000-2023 (2023-06-24 21:05) v 10.0.1 build 1 (2023-05-19 20:00 CET) License: Online\_Event\_ID-6821\_AUSTRIANJUNIOROPEN2023 (expire 2023-07-08)

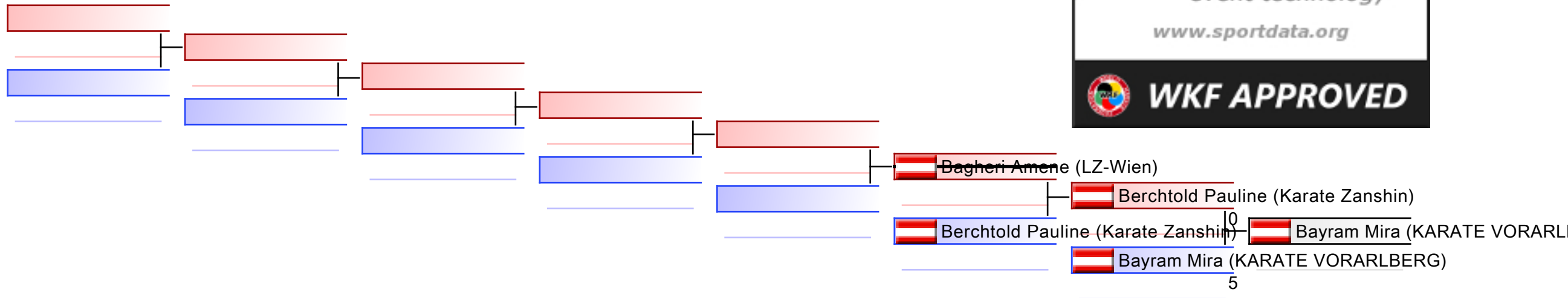

## REPECHAGE: (1)

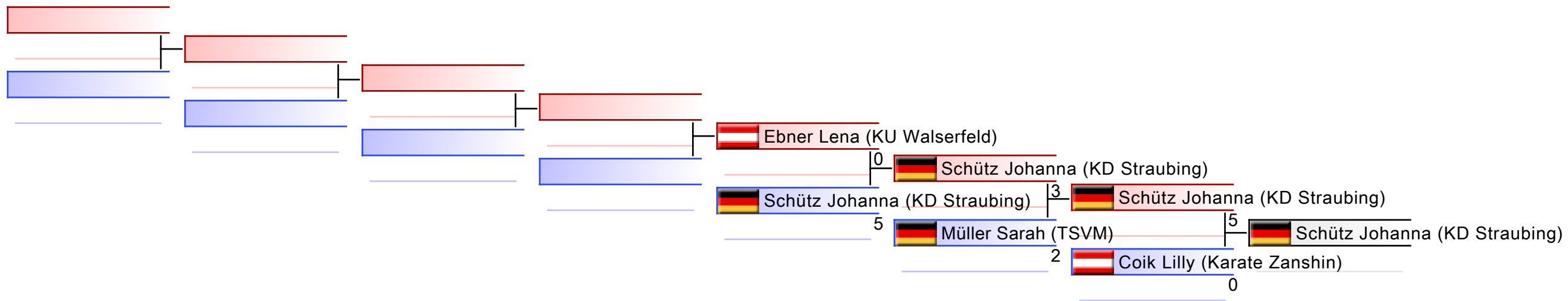

Referees:							
-----------	--	--	--	--	--	--	--

# Kata Individual female U14

AUSTRIAN JUNIOR OPEN 2023, Schulstrasse 17, 5071 Wals, AUT

2023-06-24

Tatami  
6 08:55

Pool  
1/1

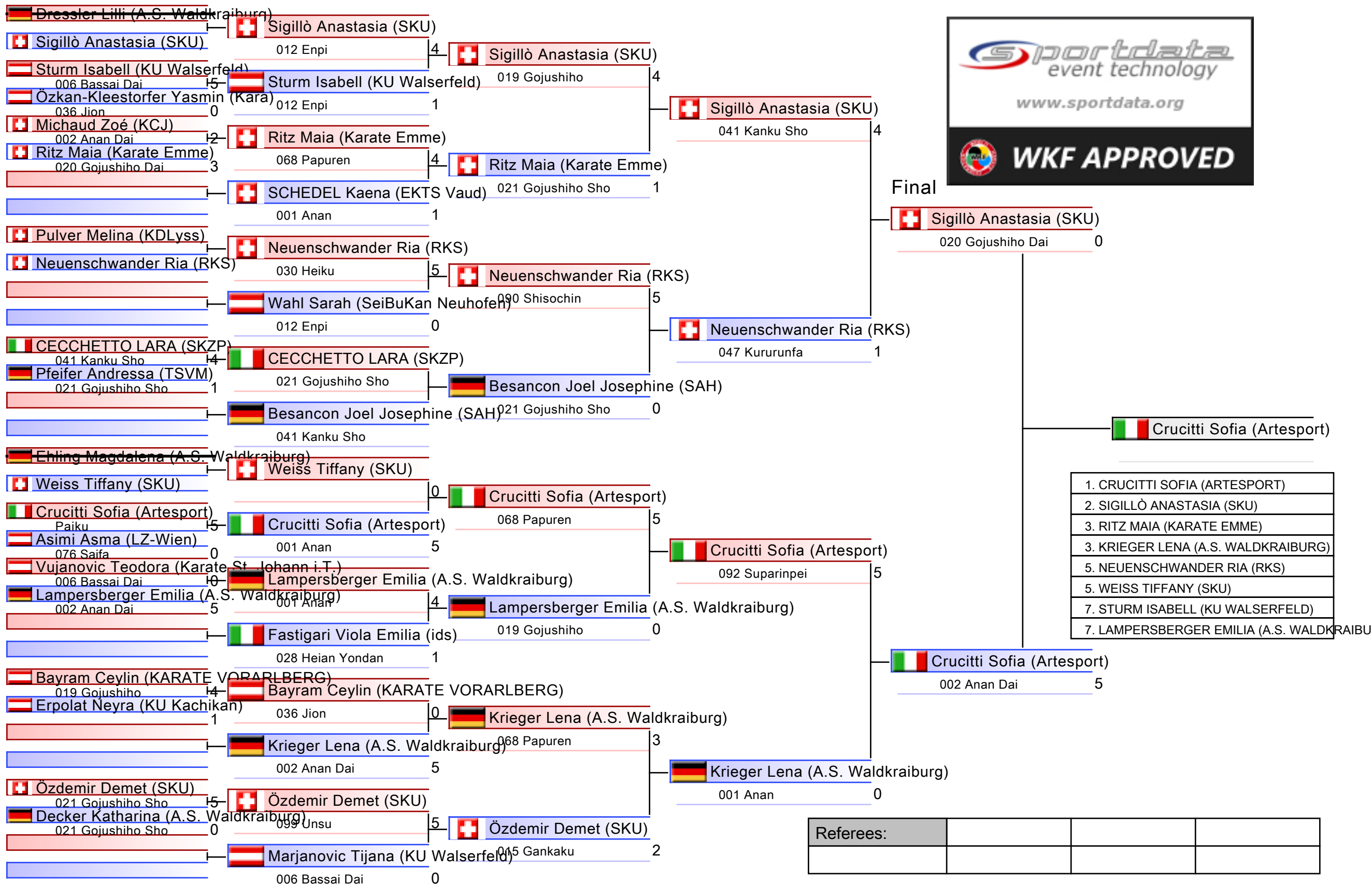

Referees:			

# Kata Individual female U14

AUSTRIAN JUNIOR OPEN 2023

2023-06-24

Tatami  
6 08:55

Pool  
1

(c)sportdata GmbH & Co KG 2000-2023 (2023-06-24 21:05) v 10.0.1 build 1 (2023-05-19 20:00 CET) License: Online\_Event\_ID-6821\_AUSTRIANJUNIOROPEN2023 (expire 2023-07-08)

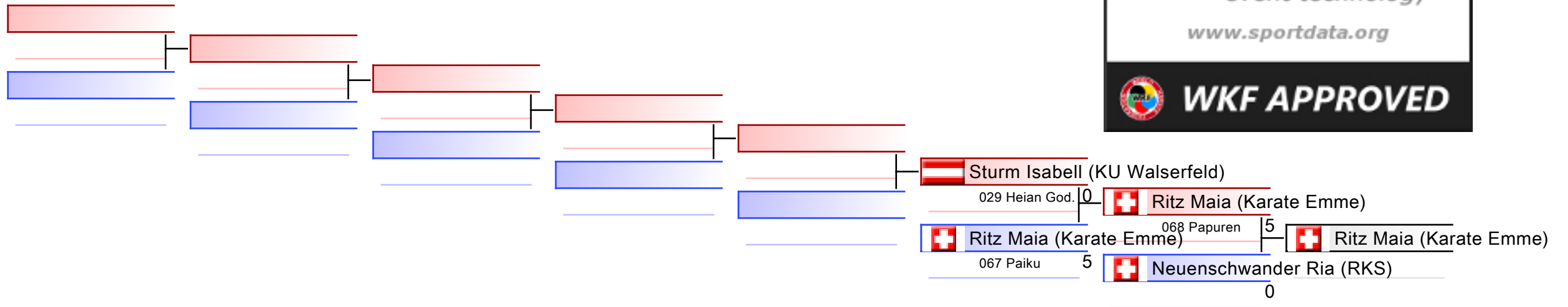

## REPECHAGE: (1)

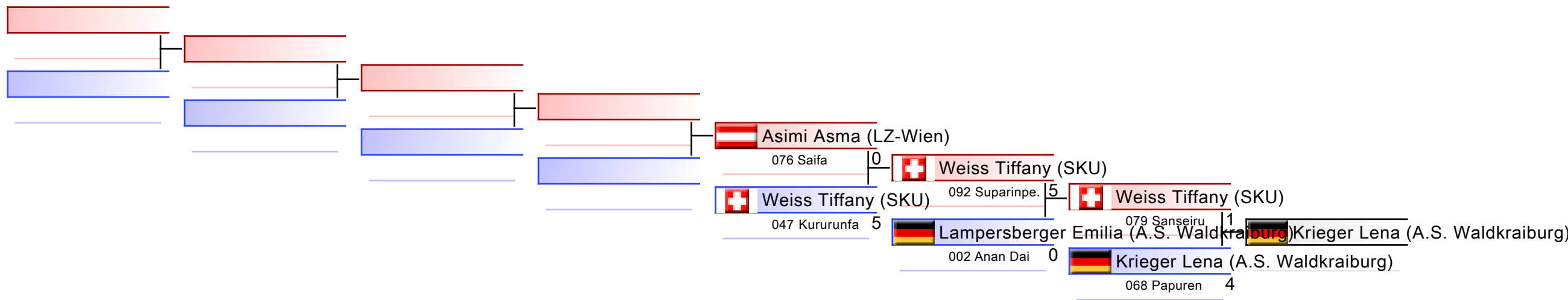

Referees:							
-----------	--	--	--	--	--	--	--

## AUSTRIAN JUNIOR OPEN 2023 - 2023-06-24

## Kata Individual female U21

## R1 G1/2 (7) Tatami 4 11:05(2023-06-24)

Competitors	Kata	1	2	3	4	5	6	7	TOTAL	Extra	Total Rank
1 EYDIS_MAGNEA_FRIDRIKSDOTTIR (KFR)	047 KURURUNFA	7.6	(7.4)	(7.8)	7.4	7.5			22.5		22.5 7
2 MAELLE_LOCOGE (TSV_ERDING)	009 CHIBANA_NO_KUSHANKU	(7.4)	7.7	7.8	7.6	(8.0)			23.1		23.1 5
3 CELO_ISRA (KU_KACHIKAN)	047 KURURUNFA	8.2	(8.0)	8.4	8.2	(8.8)			24.8		24.8 2
4 POPOVA_VARVARA (WELS)	021 GOJUSHIHO_SHO	7.8	7.5	7.7	(7.3)	(8.4)			23.0		23.0 6
5 VLAI_JESSICA (A.S. WALDKRAIBURG)	002 ANAN_DAI	8.4	8.2	8.3	(7.9)	(9.0)			24.9		24.9 1
6 MINANO_LANYFER (RKS)	047 KURURUNFA	(8.0)	8.1	8.0	8.3	(8.6)			24.4		24.4 3
7 FLASCHBERGER_SARAH (KC_FELDKIRCHEN)	064 OHAN_DAI	7.9	(7.7)	8.0	7.9	(8.9)			23.8		23.8 4

## R1 G2/2 (6) Tatami 4 11:35(2023-06-24)

Competitors	Kata	1	2	3	4	5	6	7	TOTAL	Extra	Total Rank
1 SUTER_ANINA (SKU)	047 KURURUNFA	7.6	(7.5)	(7.9)	7.5	7.5			22.6		22.6 1
2 DI_VIRGILIO_ALICE (H.B.DO)	066 PACHU	6.8	(6.5)	(7.0)	6.8	7.0			20.6		20.6 4
3 TSCHANZ_OLIVIA (KEN_THUN)	020 GOJUSHIHO_DAI	(7.0)	7.2	(7.4)	7.3	7.3			21.8		21.8 3
4 KARAKOC_SORAYA (KARATE_LIMMATTAL)	092 SUPARINPEI	(6.6)	6.7	6.6	(7.1)	6.7			20.0		20.0 6
5 CERIANI_GIULIA (IDS)	020 GOJUSHIHO_DAI	(6.4)	6.9	6.8	(7.2)	6.9			20.6		20.6 5
6 RONJA_HALLDORSDDOTTIR (KFR)	047 KURURUNFA	7.4	(7.0)	7.3	(7.8)	7.7			22.4		22.4 2

## R2-G1

Competitors	Kata	1	2	3	4	5	6	7	TOTAL	Extra	Total Rank
1 MINANO_LANYFER (RKS)	064 OHAN_DAI	(7.9)	8.1	8.0	(8.3)	8.0			24.1		24.1 4
2 CELO_ISRA (KU_KACHIKAN)	068 PAPUREN	8.3	(8.4)	8.2	8.2	(7.8)			24.7		24.7 2
3 VLAI_JESSICA (A.S. WALDKRAIBURG)	092 SUPARINPEI	(8.1)	8.2	8.4	8.4	(8.5)			25.0		25.0 1
4 FLASCHBERGER_SARAH (KC_FELDKIRCHEN)	068 PAPUREN	8.0	(7.9)	8.2	8.1	(8.3)			24.3		24.3 3

## R2-G2

Competitors	Kata	1	2	3	4	5	6	7	TOTAL	Extra	Total Rank
1 DI_VIRGILIO_ALICE (H.B.DO)	068 PAPUREN	7.0	(6.7)	6.8	(7.1)	7.0			20.8		20.8 4
2 RONJA_HALLDORSDDOTTIR (KFR)	001 ANAN	7.4	(6.8)	7.2	6.9	(7.6)			21.5		21.5 3
3 TSCHANZ_OLIVIA (KEN_THUN)	021 GOJUSHIHO_SHO	7.6	(7.2)	7.4	7.5	(7.8)			22.5		22.5 2
4 SUTER_ANINA (SKU)	067 PAIKU	(8.0)	(7.5)	7.8	7.9	8.0			23.7		23.7 1

## R3 Bronze Medal Match 1

Competitors	Kata	1	2	3	4	5	6	7	TOTAL	Extra	Total Rank
1 CELO_ISRA (KU_KACHIKAN)	064 OHAN_DAI	8.2	8.0	(8.3)	8.3	(7.6)			24.5		24.5 1
2 RONJA_HALLDORSDDOTTIR (KFR)	083 SEIPAI	7.6	7.1	(7.7)	7.4	(6.9)			22.1		22.1 2





## R3 Bronze Medal Match 2

Competitors	Kata	1	2	3	4	5	6	7	TOTAL	Extra	Total Rank
1 FLASCHBERGER_SARAH (KC_FELDKIRCHEN)	002 ANAN_DAI	(8.2)	7.9	7.8	7.8	(7.5)			23.5		23.5 1
2 TSCHANZ_OLIVIA (KEN_THUN)	015 GANKAKU	(7.7)	7.4	7.7	7.4	(6.8)			22.5		22.5 2

## R3 Gold Medal Match

Competitors	Kata	1	2	3	4	5	6	7	TOTAL	Extra	Total Rank
1 VLAI_JESSICA (A.S. WALDKRAIBURG)	068 PAPUREN	(8.2)	8.0	7.9	(7.7)	8.0			23.9		23.9 2
2 SUTER_ANINA (SKU)	002 ANAN_DAI	(8.4)	(7.7)	8.1	8.1	8.4			24.6		24.6 1

## Results

1	SUTER ANINA	SWISS KARATE UNION		SWITZERLAND
2	VLAI JESSICA	ASIA SPORTS KARATESCHULE		GERMANY
3	CELO ISRA	KARATE UNION KACHIKAN		AUSTRIA
3	FLASCHBERGER SARAH	INOUE-HA KARATE-DO FELDKIRCHEN		AUSTRIA

# Kata Individual female U8

AUSTRIAN JUNIOR OPEN 2023, Schulstrasse 17, 5071 Wals, AUT

2023-06-24

Tatami  
1 09:05

Pool  
1/1

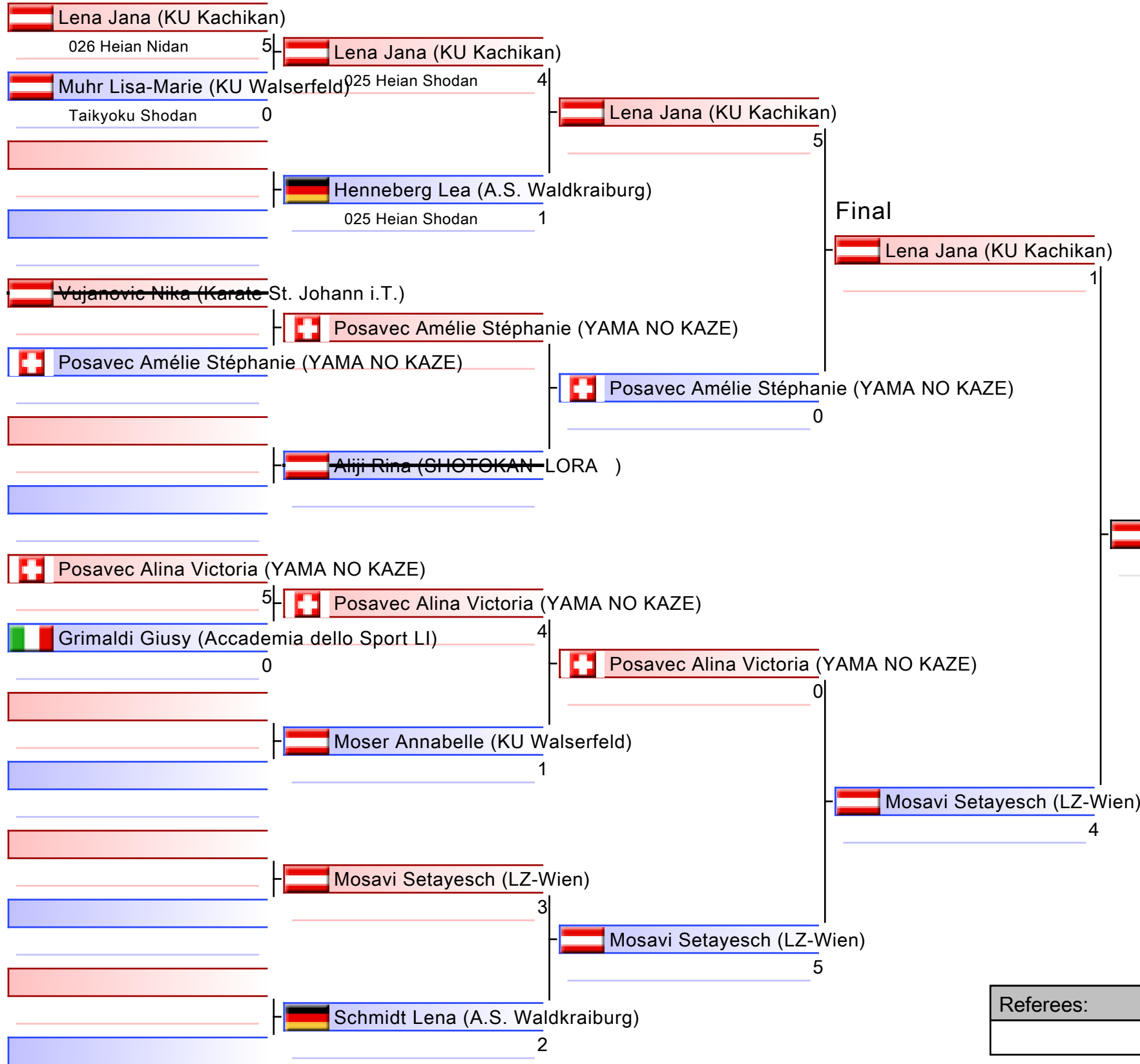

1. MOSAVI SETAYESCH (LZ-WIEN)
2. LENA JANA (KU KACHIKAN)
3. SCHMIDT LENA (A.S. WALDKRAIBURG)
3. HENNEBERG LEA (A.S. WALDKRAIBURG)
5. POSAVEC ALINA VICTORIA (YAMA NO KAZE)
5. POSAVEC AMÉLIE STÉPHANIE (YAMA NO KAZE)
7. MUHR LISA-MARIE (KU WALSERFELD)

Referees:			

# Kata Individual female U8

AUSTRIAN JUNIOR OPEN 2023

2023-06-24

Tatami  
1 09:05

Pool  
1

(c)sportdata GmbH & Co KG 2000-2023 (2023-06-24 21:05) v 10.0.1 build 1 (2023-05-19 20:00 CET) License: Online\_Event\_ID-6821\_AUSTRIANJUNIOROPEN2023 (expire 2023-07-08)

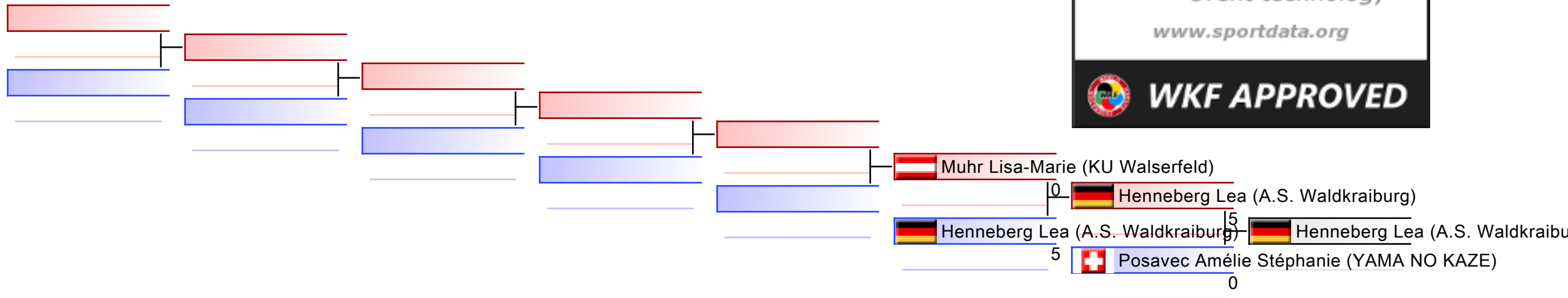

## REPECHAGE: (1)

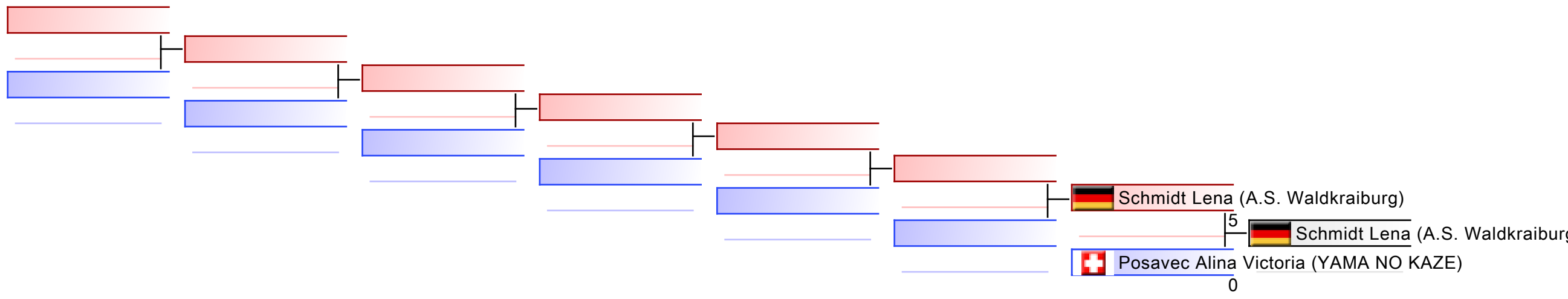

Referees:							
-----------	--	--	--	--	--	--	--

## AUSTRIAN JUNIOR OPEN 2023 - 2023-06-24

## Kata Individual male Cadets

## R1 G1/2 (11) Tatami 3 09:05(2023-06-24)

Competitors	Kata	1	2	3	4	5	6	7	TOTAL	Extra	Total Rank
1 HLUSHCHENKO ARTUR (OKI)	066 PACHU	(7.5)	7.3	(6.9)	7.5	7.5			22.3		22.3 2
2 MATEUS_GOMES CRISTIANO (KDB)	021 GOJUSHIHO SHO	6.3	6.2	(5.6)	5.9	(6.6)			18.4		18.4 9
3 ZHOU MARCO (BKP)	066 PACHU	7.4	(7.1)	7.8	(8.0)	7.7			22.9		22.9 1
4 MIJUSKOVIC DAMIAN (OKINAWA KARATE FEICHTEN)	036 JION	6.5	(6.6)	(6.0)	6.5	6.5			19.5		19.5 7
5 WALLNER SIMON (KU WALSERFELD)	012 ENPI	6.7	(7.2)	(6.6)	6.8	7.0			20.5		20.5 5
6 STANIKZAI HEJRATULLAH (KARATE ZANSHIN)	006 BASSAI DAI	6.4	(6.5)	(6.0)	6.5	6.3			19.2		19.2 8
7 FIORAVANTI RICCARDO (AKS FIRENZE)	021 GOJUSHIHO SHO	7.0	(7.5)	(6.4)	6.9	7.4			21.3		21.3 4
8 LOSHAJ MURAT (KARATE LIMMATTAL)	001 ANAN	6.2	(6.9)	5.9	(5.6)	6.1			18.2		18.2 10
9 JANTSCHER MARCEL JOSEPH (KARATE ST. JOHANN I.T.)	036 JION	6.1	(6.6)	(5.6)	5.9	5.8			17.8		17.8 11
10 PELIVANI DENIS (SKU)	002 ANAN DAI	7.1	(7.6)	(6.8)	7.1	7.4			21.6		21.6 3
11 BRILLI ROCCO (BKP)	064 OHAN DAI	6.8	(7.1)	(5.8)	6.6	6.9			20.3		20.3 6

## R1 G2/2 (11) Tatami 3 09:55(2023-06-24)

Competitors	Kata	1	2	3	4	5	6	7	TOTAL	Extra	Total Rank
1 GALATEANU DAVID (SBK LINZ)	036 JION	6.7	(7.2)	7.2	(6.6)	7.0			20.9		20.9 9
2 SCHEDEL NOLAN (EKTS VAUD)	063 OHAN	(6.5)	6.8	7.4	(7.5)	7.5			21.7		21.7 6
3 WAGNER EMIL (KARATE VORARLBERG)	012 ENPI	(7.2)	(7.4)	7.3	7.3	7.4			22.0		22.0 5
4 WALLNER JONAS (KU WALSERFELD)	012 ENPI	6.6	(6.5)	(7.4)	6.7	6.8			20.1		20.1 10
5 MISCHLER KEVIN (KARATE EMME)	021 GOJUSHIHO SHO	7.9	7.9	(7.5)	7.8	(8.0)			23.6		23.6 1
6 ROMAGNOLI EMANUEL (BKP)	030 HEIKU	(8.3)	7.8	7.5	(7.4)	8.2			23.5		23.5 2
7 CAJÖRI MILO (SKU)	047 KURURUNFA	7.4	(7.7)	7.2	(6.7)	6.9			21.5		21.5 7
8 SCHACHINGER LORENZ (KU WALSERFELD)	006 BASSAI DAI	6.0	6.3	(6.5)	(5.7)	6.0			18.3		18.3 11
9 LIM HAO_YI (KARATE LIMMATTAL)	001 ANAN	7.5	(7.9)	6.7	(6.3)	7.3			21.5		21.5 8
10 OLLAGNERO GIOVANNI_SEBASTIAN (ARTESPORT)	041 KANKU SHO	7.7	(7.8)	7.3	(7.1)	7.6			22.6		22.6 3
11 MATTERA ANTONIO (AKS FIRENZE)	041 KANKU SHO	7.6	(8.0)	7.1	(6.9)	7.4			22.1		22.1 4

## R2-G1

Competitors	Kata	1	2	3	4	5	6	7	TOTAL	Extra	Total Rank
1 ZHOU MARCO (BKP)	064 OHAN DAI	(8.1)	7.4	7.5	7.8	(7.2)			22.7		22.7 2
2 HLUSHCHENKO ARTUR (OKI)	001 ANAN	(8.3)	7.6	(7.2)	7.6	7.5			22.7		22.7 1
3 PELIVANI DENIS (SKU)	001 ANAN	(7.6)	7.3	7.0	7.0	(6.9)			21.3		21.3 4
4 FIORAVANTI RICCARDO (AKS FIRENZE)	099 UNSU	(7.8)	7.4	(7.2)	7.5	7.8			22.7		22.7 3

## R2-G2

Competitors	Kata	1	2	3	4	5	6	7	TOTAL	Extra	Total Rank
1 ROMAGNOLI EMANUEL (BKP)	066 PACHU	7.8	7.8	(7.5)	7.9	(8.4)			23.5		23.5 1
2 OLLAGNERO GIOVANNI_SEBASTIAN (ARTESPORT)	021 GOJUSHIHO SHO	7.3	(7.7)	(7.0)	7.4	7.7			22.4		22.4 4
3 MISCHLER KEVIN (KARATE EMME)	020 GOJUSHIHO DAI	8.0	(8.1)	(7.4)	7.6	7.5			23.1		23.1 2
4 MATTERA ANTONIO (AKS FIRENZE)	021 GOJUSHIHO SHO	(7.1)	(8.0)	7.3	7.5	8.0			22.8		22.8 3

## R3 Bronze Medal Match 1

Competitors	Kata	1	2	3	4	5	6	7	TOTAL	Extra	Total Rank
1 ZHOU MARCO (BKP)	068 PAPUREN	(8.4)	7.8	8.4	7.8	(7.4)			24.0		24.0 1
2 MATTERA ANTONIO (AKS FIRENZE)	012 ENPI	7.9	7.3	(8.0)	(7.0)	7.5			22.7		22.7 2

## R3 Bronze Medal Match 2

Competitors	Kata	1	2	3	4	5	6	7	TOTAL	Extra	Total Rank
1 FIORAVANTI RICCARDO (AKS FIRENZE)	041 KANKU SHO	(7.5)	(8.1)	7.8	7.5	8.0			23.3		23.3 2
2 MISCHLER KEVIN (KARATE EMME)	099 UNSU	7.8	8.2	(7.5)	7.6	(8.4)			23.6		23.6 1

## R3 Gold Medal Match



Competitors	Kata	1	2	3	4	5	6	7	TOTAL	Extra	Total Rank
1 HLUSHCHENKO ARTUR (OKI)	064 OHAN DAI	7.9	8.3	7.8	(7.4)	(8.4)			24.0		24.0 1
2 ROMAGNOLI EMANUEL (BKP)	068 PAPUREN	(7.6)	8.5	7.6	7.6	(8.6)			23.7		23.7 2

## Results

1	HLUSHCHENKO ARTUR	OKINAWA		UKRAINE
---	-------------------	---------	---	---------

AUSTRIAN JUNIOR OPEN 2023 - 2023-06-24

Kata Individual male Cadets

2	ROMAGNOLI EMANUEL	BUSHIDO KARATE PERUGIA		ITALY
3	ZHOU MARCO	BUSHIDO KARATE PERUGIA		ITALY
3	MISCHLER KEVIN	KARATE EMME		SWITZERLAND



AUSTRIAN JUNIOR OPEN 2023 - 2023-06-24

Kata Individual male Juniors

R1 G1/2 (8) Tatami 4 08:50(2023-06-24)

Competitors	Kata	1	2	3	4	5	6	7	TOTAL	Extra	Total Rank
1 GIOVAGNONI GIOELE (BKP)	064 OHAN DAI	(7.5)	7.8	7.6	(8.2)	8.0			23.4		23.4 2
2 ZÖCHBAUER SAMUEL (SMK)	002 ANAN DAI	(8.1)	8.0	8.0	8.0	(7.8)			24.0		24.0 1
3 SOLAZZO ILARIO_NAZARENO (KARATE LIMMATTAL)	008 CHATANYARA KUSHANKU	(7.7)	7.6	(7.4)	7.7	7.5			22.8		22.8 4
4 SHAMSI DANIEL (NEUKEFERLOH)	041 KANKU SHO	(6.7)	6.8	(7.2)	7.2	6.8			20.8		20.8 8
5 HUGI HALLDÖRSSON (KFR)	066 PACHU	(7.4)	7.4	7.5	(7.8)	7.6			22.5		22.5 5
6 MELANI MATTEO (AKS FIRENZE)	021 GOJUSHIHO SHO	7.3	(8.2)	7.5	7.4	(7.1)			22.2		22.2 6
7 VOGEL KASPAR (SKU)	047 KURURUNFA	7.5	(7.4)	7.6	7.8	(7.9)			22.9		22.9 3
8 OTT SIMON (KEN THUN)	021 GOJUSHIHO SHO	7.1	(7.2)	7.1	(7.0)	7.0			21.2		21.2 7

R1 G2/2 (8) Tatami 4 09:25(2023-06-24)

Competitors	Kata	1	2	3	4	5	6	7	TOTAL	Extra	Total Rank
1 SCHERTENLEIB JANIK (GOJU KAN BERN)	068 PAPUREN	(8.3)	(7.4)	7.5	7.6	7.5			22.6		22.6 5
2 BYTYQI LIJON (SHOTOKAN LORA)	021 GOJUSHIHO SHO	(7.0)	6.8	6.8	7.0	(6.6)			20.6		20.6 8
3 EFTIMIE EDUARD (IDS)	006 BASSAI DAI	7.2	(7.3)	6.9	(6.8)	7.2			21.3		21.3 7
4 WU TIMON (LZ-WIEN)	068 PAPUREN	7.9	8.0	(7.7)	(8.2)	8.0			23.9		23.9 3
5 REITER PATRICK (OKINAWA KARATE FEICHTEN)	078 SANSAI	7.4	(7.8)	7.4	(7.1)	7.4			22.2		22.2 6
6 WAGNER FELIX (KARATE VORARLBERG)	041 KANKU SHO	(7.6)	8.1	7.8	8.0	(8.2)			23.9		23.9 4
7 ZÖCHLING FLORIAN (SMK)	068 PAPUREN	(8.4)	(7.8)	8.1	8.4	8.4			24.9		24.9 1
8 FUSCAGNI ALEX (BKP)	066 PACHU	8.5	8.2	(7.4)	7.8	(8.6)			24.5		24.5 2

R2-G1

Competitors	Kata	1	2	3	4	5	6	7	TOTAL	Extra	Total Rank
1 VOGEL KASPAR (SKU)	068 PAPUREN	7.9	(8.0)	(7.4)	7.8	7.6			23.3		23.3 3
2 GIOVAGNONI GIOELE (BKP)	068 PAPUREN	(8.0)	(7.7)	7.9	8.0	8.0			23.9		23.9 1
3 ZÖCHBAUER SAMUEL (SMK)	001 ANAN	(8.2)	(7.6)	8.1	7.6	7.9			23.6		23.6 2
4 SOLAZZO ILARIO_NAZARENO (KARATE LIMMATTAL)	064 OHAN DAI	7.6	(7.8)	(7.0)	7.4	7.8			22.8		22.8 4

R2-G2

Competitors	Kata	1	2	3	4	5	6	7	TOTAL	Extra	Total Rank
1 WAGNER FELIX (KARATE VORARLBERG)	020 GOJUSHIHO DAI	(7.9)	7.8	(7.4)	7.6	7.4			22.8		22.8 4
2 WU TIMON (LZ-WIEN)	001 ANAN	(7.8)	(8.0)	7.8	7.9	8.0			23.7		23.7 3
3 FUSCAGNI ALEX (BKP)	068 PAPUREN	8.3	8.3	(8.1)	8.1	(8.4)			24.7		24.7 1
4 ZÖCHLING FLORIAN (SMK)	008 CHATANYARA KUSHANKU	(8.5)	8.2	(7.6)	8.3	8.0			24.5		24.5 2

R3 Bronze Medal Match 1

Competitors	Kata	1	2	3	4	5	6	7	TOTAL	Extra	Total Rank
1 ZÖCHBAUER SAMUEL (SMK)	064 OHAN DAI	(8.2)	8.0	(7.9)	8.0	7.9			23.9		23.9 1
2 WU TIMON (LZ-WIEN)	021 GOJUSHIHO SHO	7.7	7.5	(7.1)	7.8	(8.0)			23.0		23.0 2





R3 Bronze Medal Match 2

Competitors	Kata	1	2	3	4	5	6	7	TOTAL	Extra	Total Rank
1 VOGEL KASPAR (SKU)	001 ANAN	7.8	(8.0)	(7.5)	8.0	7.8			23.6		23.6 2
2 ZÖCHLING FLORIAN (SMK)	047 KURURUNFA	8.3	(8.5)	(7.8)	8.2	8.2			24.7		24.7 1

R3 Gold Medal Match

Competitors	Kata	1	2	3	4	5	6	7	TOTAL	Extra	Total Rank
1 GIOVAGNONI GIOELE (BKP)	002 ANAN DAI	(7.7)	8.0	8.1	8.2	(8.3)			24.3		24.3 2
2 FUSCAGNI ALEX (BKP)	064 OHAN DAI	(8.0)	(8.5)	8.4	8.5	8.4			25.3		25.3 1

Results

1	FUSCAGNI ALEX	BUSHIDO KARATE PERUGIA		ITALY
2	GIOVAGNONI GIOELE	BUSHIDO KARATE PERUGIA		ITALY
3	ZÖCHBAUER SAMUEL	SPORTUNION MUGENDO KARATE		AUSTRIA
3	ZÖCHLING FLORIAN	SPORTUNION MUGENDO KARATE		AUSTRIA

# Kata Individual male U10

AUSTRIAN JUNIOR OPEN 2023, Schulstrasse 17, 5071 Wals, AUT

2023-06-24

Tatami  
5 10:35

Pool  
1/1

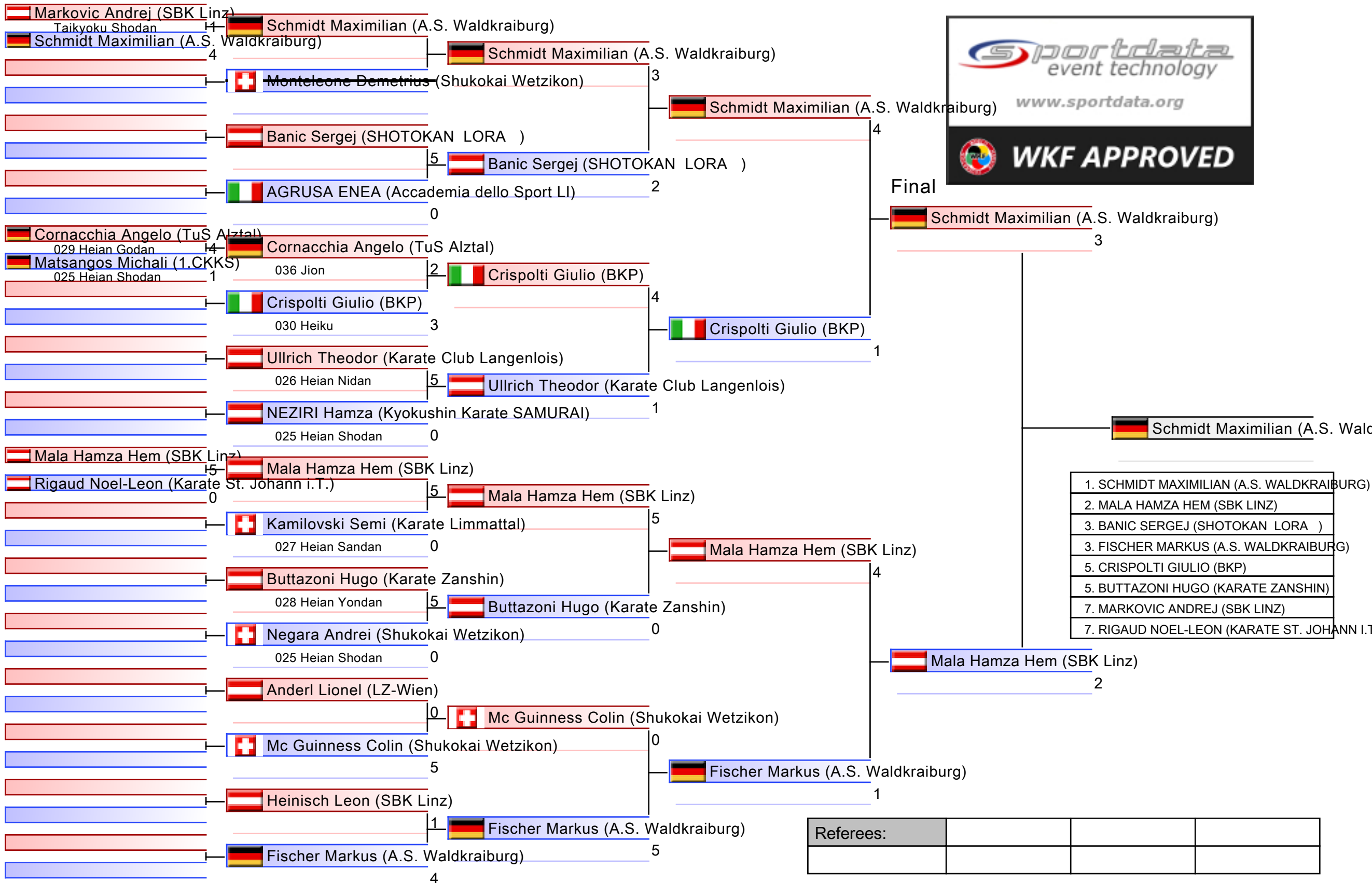

Referees:			

# Kata Individual male U10

AUSTRIAN JUNIOR OPEN 2023

2023-06-24

Tatami  
5 10:35

Pool  
1

(c)sportdata GmbH & Co KG 2000-2023 (2023-06-24 21:05) v 10.0.1 build 1 (2023-05-19 20:00 CET) License: Online\_Event\_ID-6821\_AUSTRIANJUNIOROPEN2023 (expire 2023-07-08)

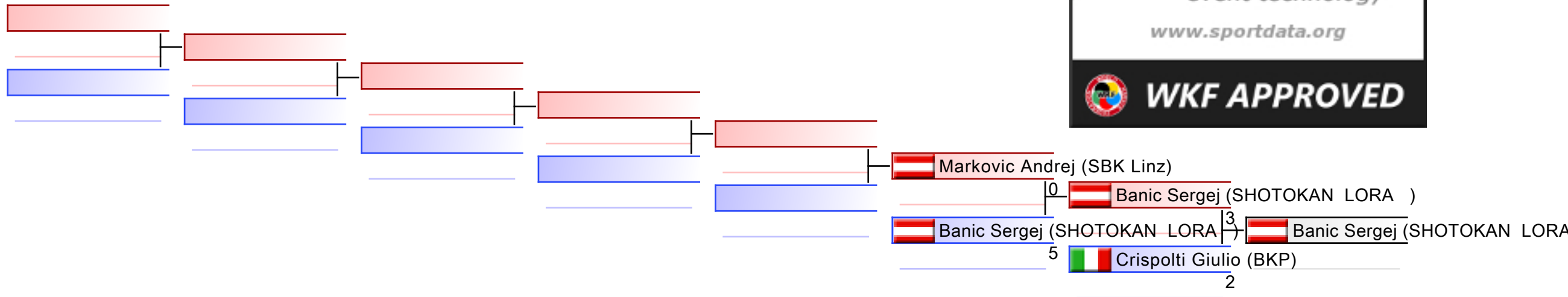

## REPECHAGE: (1)

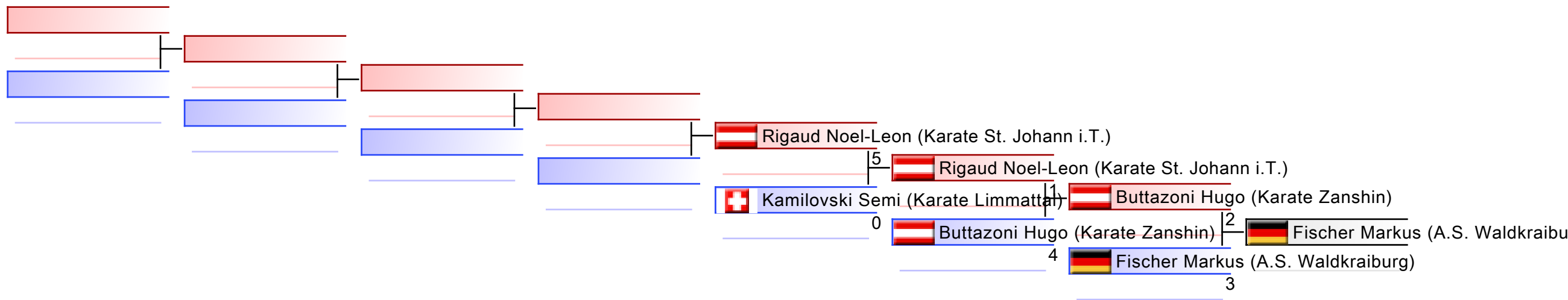

Referees:							
-----------	--	--	--	--	--	--	--

# Kata Individual male U12

AUSTRIAN JUNIOR OPEN 2023, Schulstrasse 17, 5071 Wals, AUT

2023-06-24

Tatami  
6 11:45

Pool  
1/1

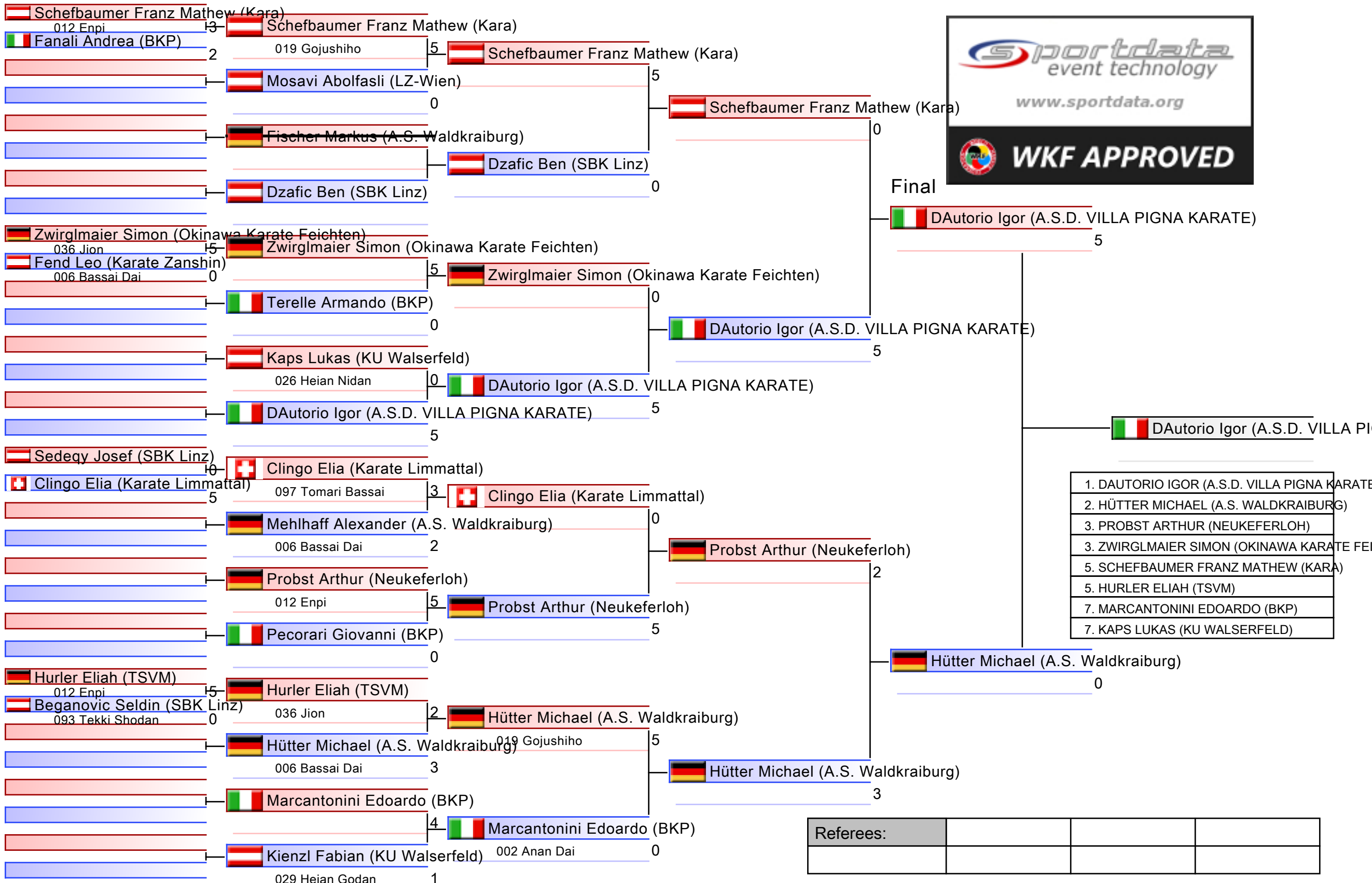

Referees:			

# Kata Individual male U12

AUSTRIAN JUNIOR OPEN 2023

2023-06-24

Tatami  
6 11:45

Pool  
1

(c)sportdata GmbH & Co KG 2000-2023 (2023-06-24 21:05) v 10.0.1 build 1 (2023-05-19 20:00 CET) License: Online\_Event\_ID-6821\_AUSTRIANJUNIOROPEN2023 (expire 2023-07-08)

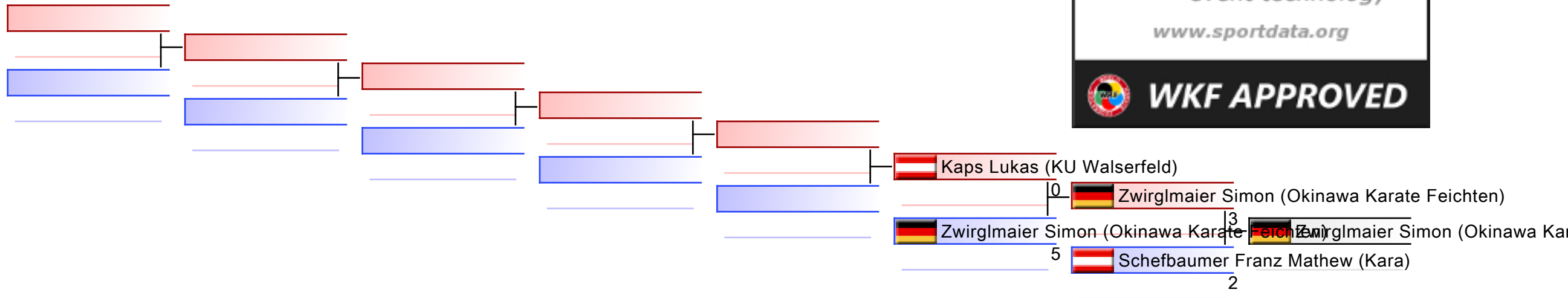

## REPECHAGE: (1)

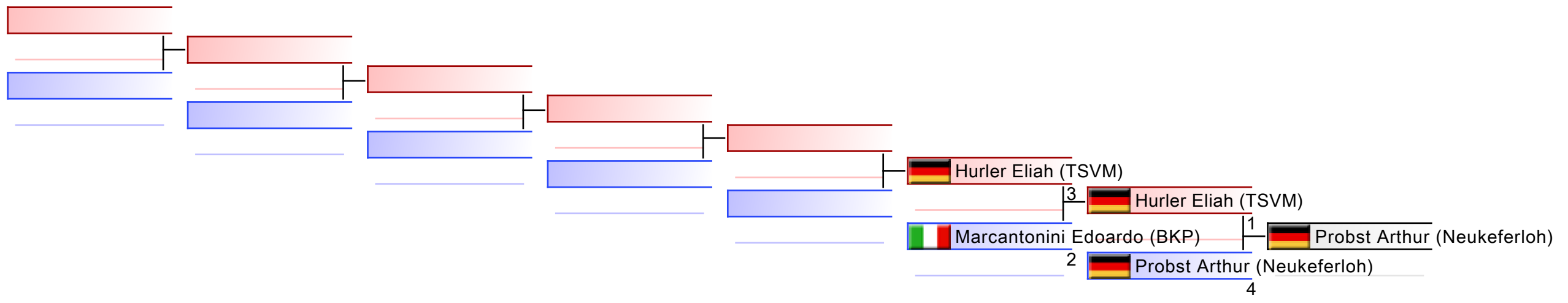

Referees:							
-----------	--	--	--	--	--	--	--

# Kata Individual male U14

AUSTRIAN JUNIOR OPEN 2023, Schulstrasse 17, 5071 Wals, AUT

2023-06-24

Tatami  
5 08:50

Pool  
1/1

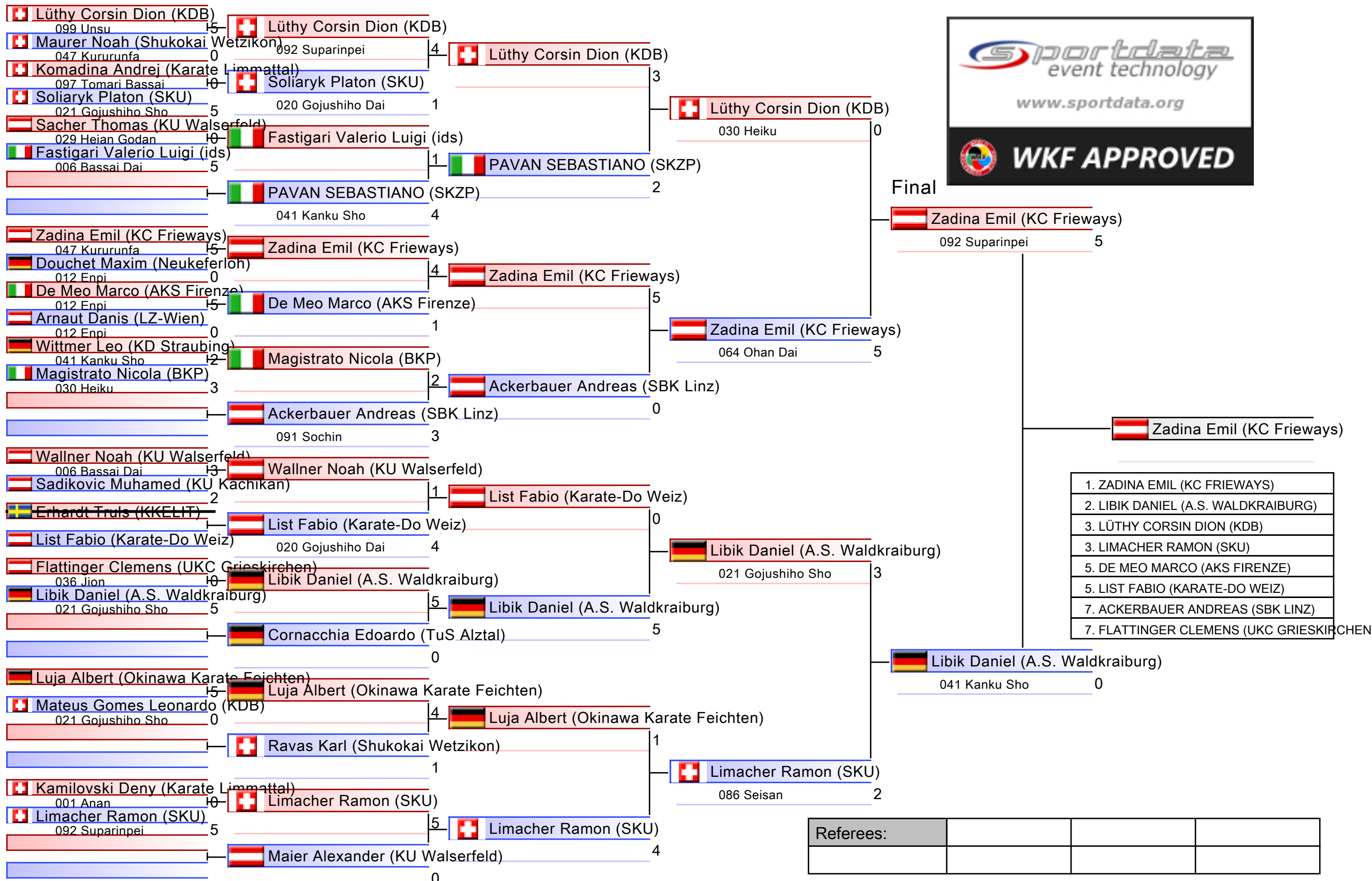

Referees:			

# Kata Individual male U14

AUSTRIAN JUNIOR OPEN 2023

2023-06-24

Tatami  
5 08:50

Pool  
1

(c)sportdata GmbH & Co KG 2000-2023 (2023-06-24 21:05) v 10.0.1 build 1 (2023-05-19 20:00 CET) License: Online\_Event\_ID-6821\_AUSTRIANJUNIOROPEN2023 (expire 2023-07-08)

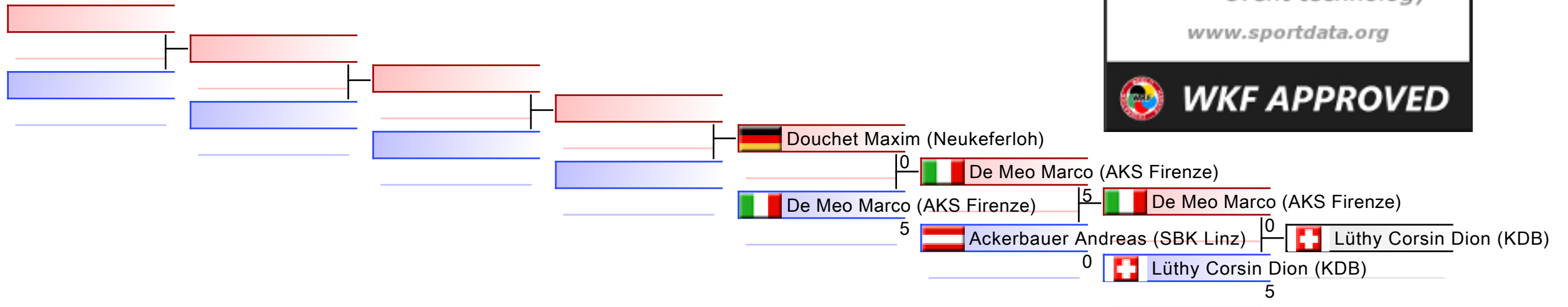

## REPECHAGE: (1)

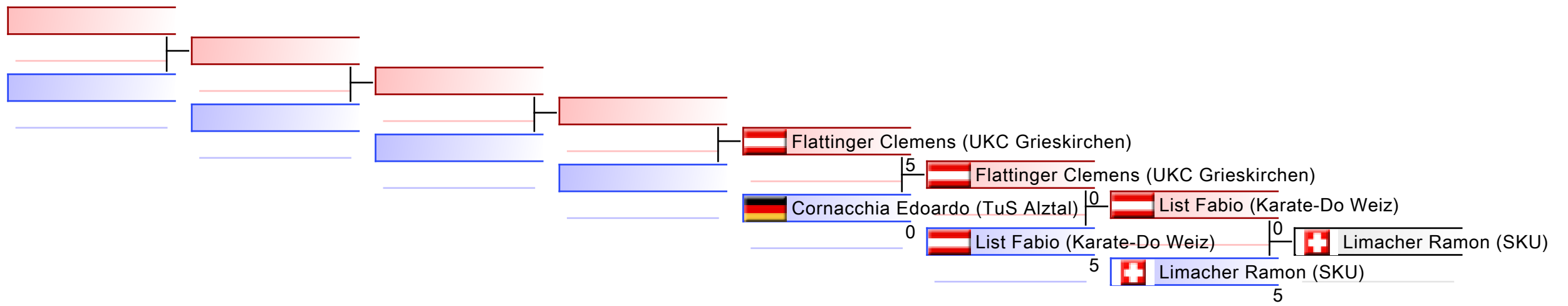

Referees:							
-----------	--	--	--	--	--	--	--

AUSTRIAN JUNIOR OPEN 2023 - 2023-06-24

Kata Individual male U21

R1 G1/2 (3) Tatami 3 11:50(2023-06-24)

Competitors	Kata	1	2	3	4	5	6	7	TOTAL	Extra	Total Rank
1 PETRONE LEANDRO (SKU)	021 GOJUSHIHO SHO	7.4	7.3	(6.9)	(7.6)	7.2			21.9		21.9 2
2 PFEIFFER THOMAS (TUS ALZTAL)	036 JION	(6.7)	6.7	6.8	6.9	(7.0)			20.4		20.4 3
3 SCHEDEL KENI (EKTS VAUD)	078 SANSAI	8.3	7.5	(7.2)	7.4	(8.5)			23.2		23.2 1

R1 G2/2 (3) Tatami 3 12:05(2023-06-24)

Competitors	Kata	1	2	3	4	5	6	7	TOTAL	Extra	Total Rank
1 FORGIONE MIRCO (ISSKA)	021 GOJUSHIHO SHO	7.9	7.2	(7.0)	7.2	(8.4)			22.3		22.3 3
2 ACQUAIOLI TOMMASO (AKS FIRENZE)	021 GOJUSHIHO SHO	(8.2)	7.4	(6.8)	7.4	7.6			22.4		22.4 2
3 SCHERTENLEIB LARS_NOAH (SKU)	068 PAPUREN	(8.4)	7.5	7.7	(6.6)	8.3			23.5		23.5 1

R2 Bronze Medal Match 1

Competitors	Kata	1	2	3	4	5	6	7	TOTAL	Extra	Total Rank
1 PETRONE LEANDRO (SKU)	099 UNSU	7.6	7.5	(7.2)	7.5	(8.0)			22.6		22.6 1
2 FORGIONE MIRCO (ISSKA)	099 UNSU	(7.3)	7.3	7.7	7.4	(8.4)			22.4		22.4 2





R2 Bronze Medal Match 2

Competitors	Kata	1	2	3	4	5	6	7	TOTAL	Extra	Total Rank
1 PFEIFFER THOMAS (TUS ALZTAL)	078 SANSAI	7.1	7.1	(6.9)	6.9	(8.0)			21.1		21.1 2
2 ACQUAIOLI TOMMASO (AKS FIRENZE)	012 ENPI	7.5	(7.4)	7.5	7.5	(8.4)			22.5		22.5 1

R2 Gold Medal Match

Competitors	Kata	1	2	3	4	5	6	7	TOTAL	Extra	Total Rank
1 SCHEDEL KENI (EKTS VAUD)	020 GOJUSHIHO DAI	7.6	7.9	7.8	(7.4)	(8.4)			23.3		23.3 1
2 SCHERTENLEIB LARS_NOAH (SKU)	047 KURURUNFA	(7.5)	7.6	7.6	7.6	(8.0)			22.8		22.8 2

Results

1	SCHEDEL KENI	EKTS LAUSANNE VUFFLENS		SWITZERLAND
2	SCHERTENLEIB LARS NOAH	SWISS KARATE UNION		SWITZERLAND
3	PETRONE LEANDRO	SWISS KARATE UNION		SWITZERLAND
3	ACQUAIOLI TOMMASO	AKS FIRENZE		ITALY



# Kata Individual male U8

AUSTRIAN JUNIOR OPEN 2023, Schulstrasse 17, 5071 Wals, AUT

2023-06-24

Tatami  
2 08:50

Pool  
1/1

Menke Jonathan (1.CKKS)

Menke Jonathan (1.CKKS)

Sauter Lucas (A.S. Waldkraiburg)

Bicioc Romeo (Karate St. Johann i.T.)

Bicioc Romeo (Karate St. Johann i.T.)

NEZIRI Amar (Kyokushin Karate SAMURAI)

NEZIRI Amar (Kyokushin Karate SAMURAI)

Anderl Laurel (LZ-Wien)

NEZIRI Amar (Kyokushin Karate SAMURAI)

Þórólfur Magni Halldórsson (KFR)

Raffler Dominic (KU Walserfeld)

Schmidt Maximilian (A.S. Waldkraiburg)

Schmidt Maximilian (A.S. Waldkraiburg)

Schmidt Maximilian (A.S. Waldkraiburg)

Kolarov Maxim (Karate Limmattal)

AGRUSA ENEA (Accademia dello Sport LI)

AGRUSA ENEA (Accademia dello Sport LI)

Kolb Maxim (A.S. Waldkraiburg)

Milic Mika (1.CKKS)

Milic Mika (1.CKKS)



Final

Bicioc Romeo (Karate St. Johann i.T.)

Schmidt Maximilian (A.S. Waldkraiburg)

- |   |
|---|
| 1. SCHMIDT MAXIMILIAN (A.S. WALDKRAIBURG) |
| 2. BICIOC ROMEO (KARATE ST. JOHANN I.T.)  |
| 3. NEZIRI AMAR (KYOKUSHIN KARATE SAMURAI) |
| 3. KOLAROV MAXIM (KARATE LIMMATTAL)       |
| 5. MENKE JONATHAN (1.CKKS)                |
| 5. MILIC MIKA (1.CKKS)                    |
| 7. RAFFLER DOMINIC (KU WALSERFELD)        |

Referees:			

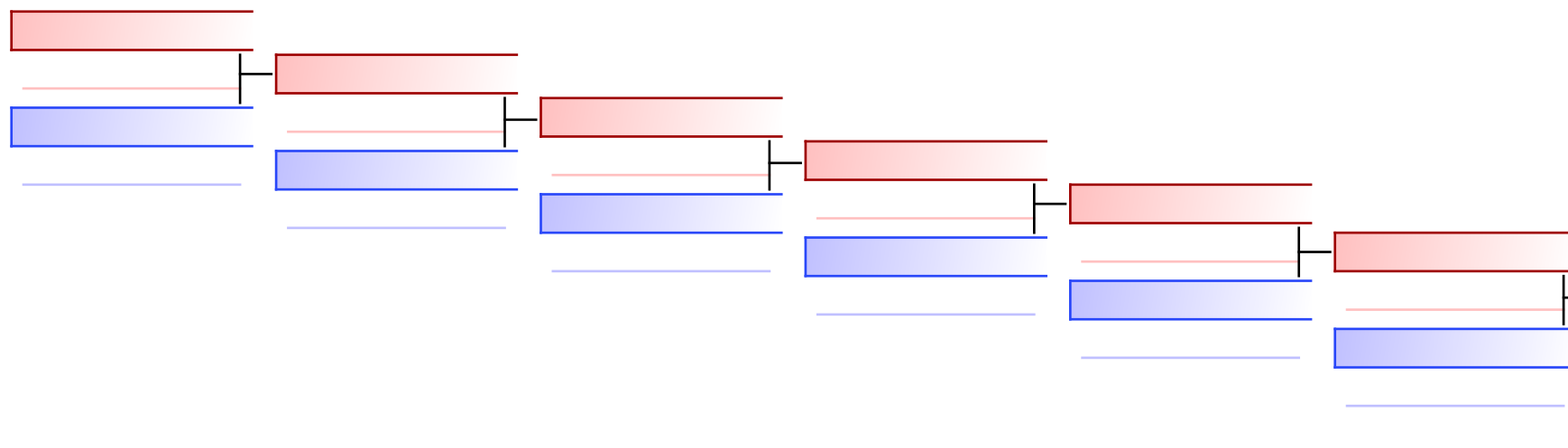

Menke Jonathan (1.CKKS) 0  
 NEZIRI Amar (Kyokushin Karate SAMURAI) 5  
 NEZIRI Amar (Kyokushin Karate SAMURAI) 5

REPECHAGE: (1)

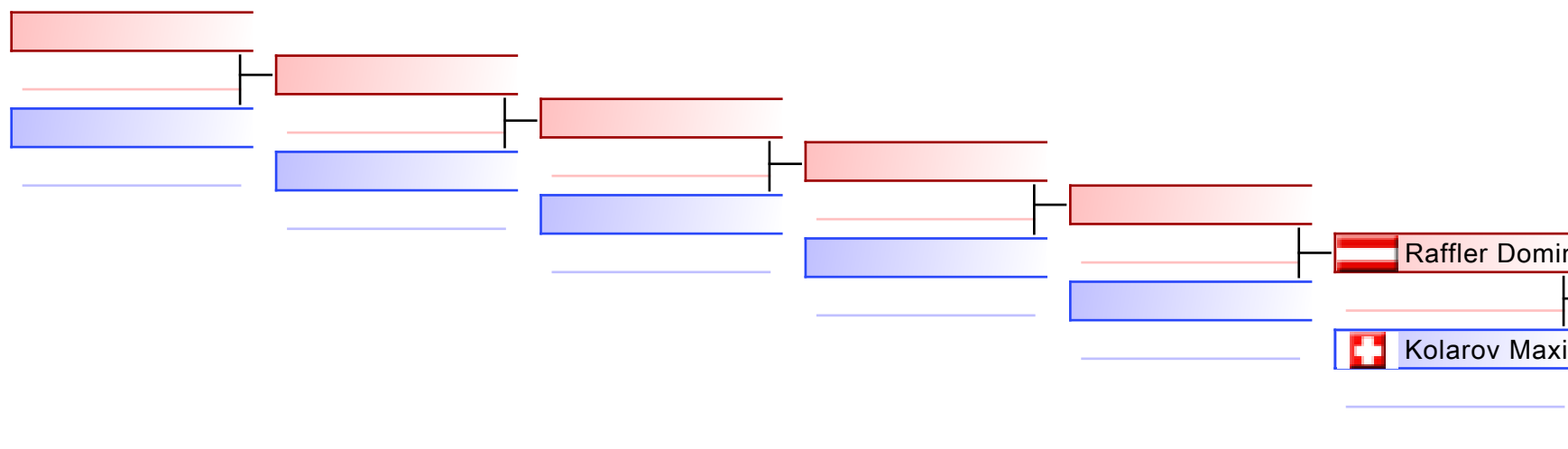

Raffler Dominic (KU Walsertal) 0  
 Kolarov Maxim (Karate Limmattal) 3  
 Kolarov Maxim (Karate Limmattal) 5  
 Kolarov Maxim (Karate Limmattal) 3  
 Milic Mika (1.CKKS) 2

Referees:							
-----------	--	--	--	--	--	--	--



AUSTRIAN JUNIOR OPEN 2023 - 2023-06-24

Kata Team female U10

Pool 1/1 (3) Tatami 1 08:45(2023-06-24)

Competitors	Kata	1	2	3	4	5	6	7	Extra	Total	Rank
1 ASIA SPORTS KARATESCHULE (HENNEBERG, SCHMIDT, SCHMIDT) (A.S. WALDKRAIBURG)	025 HEIAN SHODAN	(1.0)	1.0	1.0	1.0	(1.0)				3.0	2
2 KARATE UNION WALSERFELD (HELMSAUER, MOSER, VOGGENBERGER) (KU WALSERFELD)	TAIKYOKU SHODAN	(2.0)	2.0	2.0	2.0	(2.0)				6.0	1
3 KARATE UNION SHOTOKAN TIROL (ANDERSON_PICHARDO, RUZBACKA, VUJANOVIC) (KARATE ST. JOHANN I.T.)											

Results

1 ASIA SPORTS KARATESCHULE - SCHMIDT LISA - SCHMIDT LENA - HENNEBERG LEA	ASIA SPORTS KARATESCHULE		GERMANY
2 KARATE UNION WALSERFELD - VOGGENBERGER SOPHIA - MOSER ANNABELLE - HELMSAUER MARLENE	KARATE UNION WALSERFELD		AUSTRIA

# Kata Team female U12

AUSTRIAN JUNIOR OPEN 2023, Schulstrasse 17, 5071 Wals, AUT

2023-06-24

Tatami  
5 08:30

Pool  
1/1

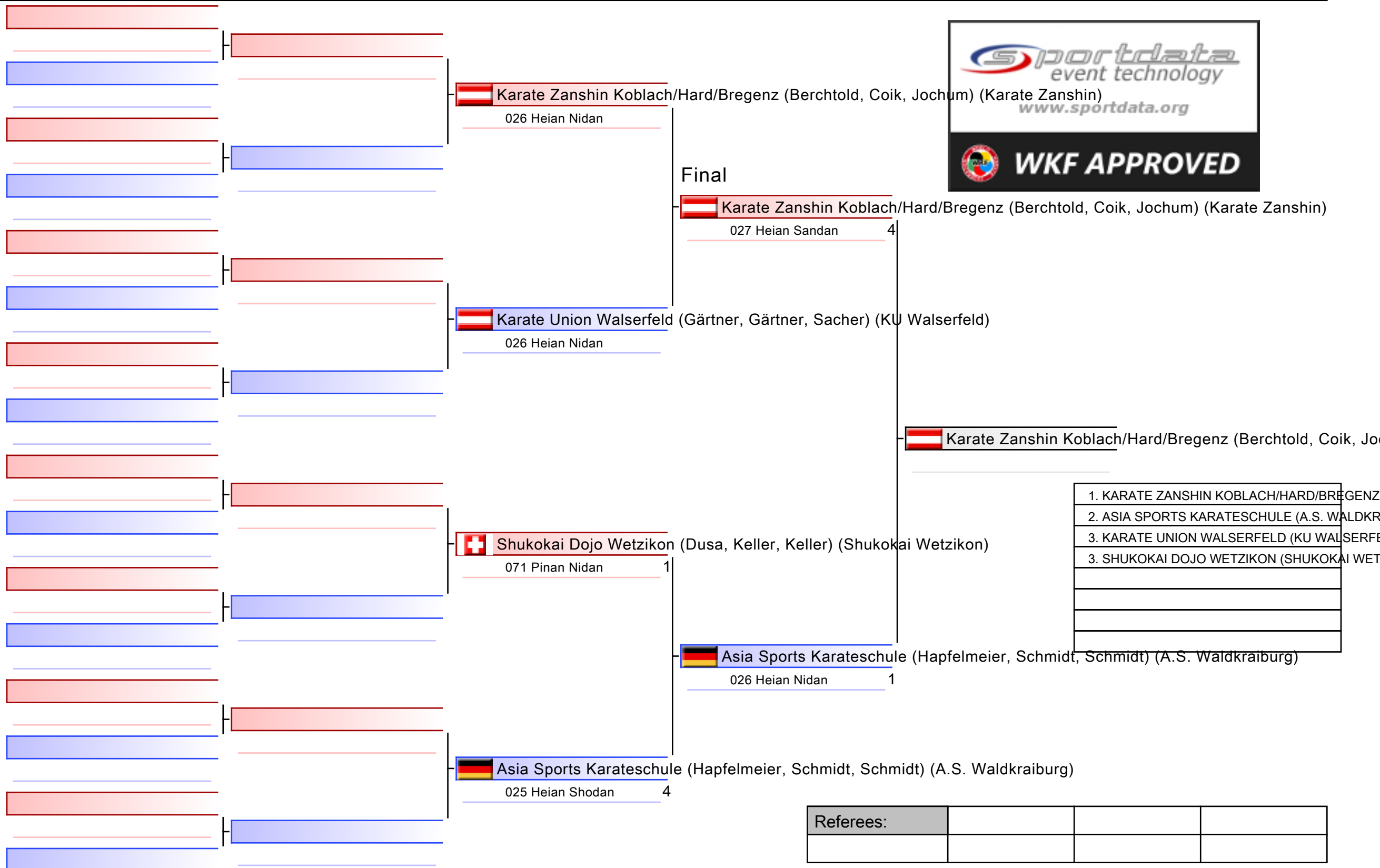

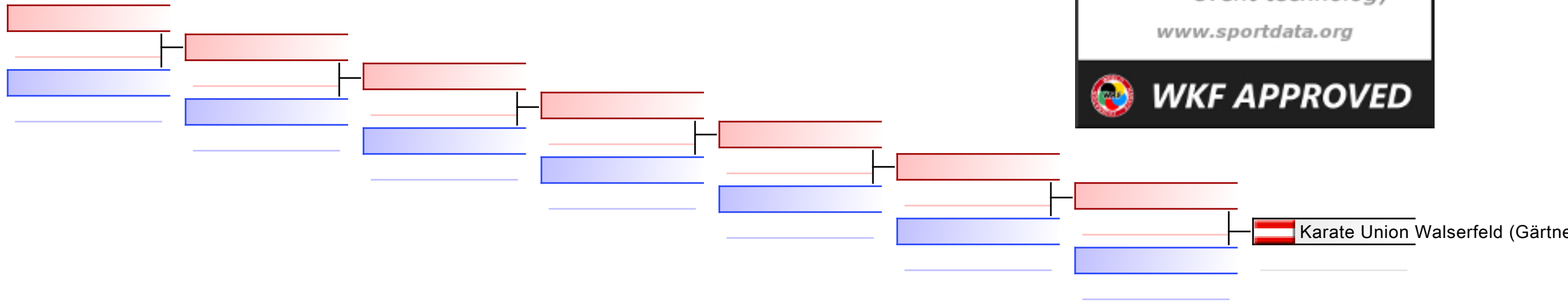

REPECHAGE: (1)

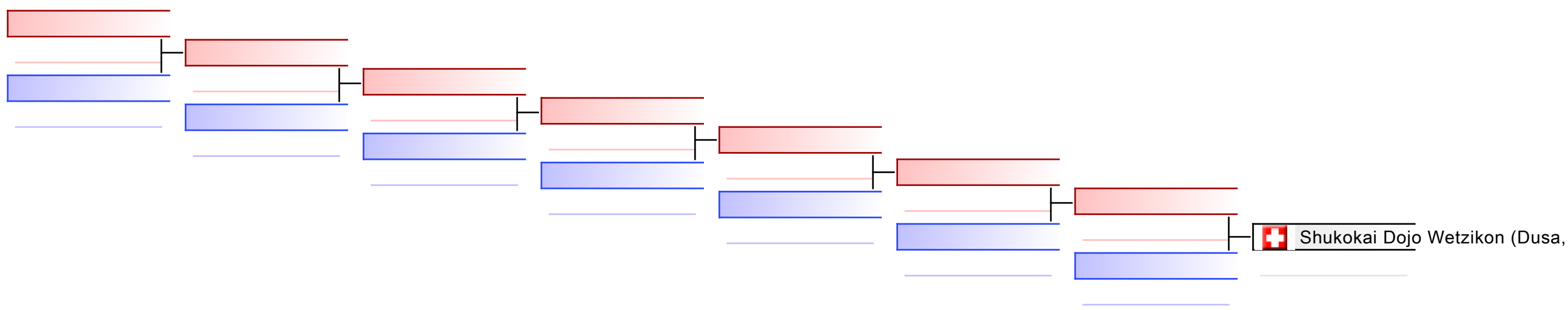

Referees:							
-----------	--	--	--	--	--	--	--



AUSTRIAN JUNIOR OPEN 2023 - 2023-06-24

Kata Team female U14

Pool 1/1 (2) Tatami 3 08:45(2023-06-24)

Competitors	Kata	1	2	3	4	5	6	7	Extra	Total	Rank
1 KARATE UNION SHOTOKAN TIROL (HARASSER, LASTA, VUJANOVIC) (KARATE ST. JOHANN I.T.)	006 BASSAI DAI	(6.2)	6.5	6.6	7.0	(7.0)				20.1	2
2 LEISTUNGSZENTRUM WIEN (ASIMI, BAGHERI, JAFARI) (LZ-WIEN)	017 GEKISAI ICHI	(6.6)	6.8	7.1	7.4	(7.4)				21.3	1

Results

1	LEISTUNGSZENTRUM WIEN - JAFARI FATIMA - BAGHERI AMENE - ASIMI ASMA	LEISTUNGSZENTRUM WIEN		AUSTRIA
2	KARATE UNION SHOTOKAN TIROL - HARASSER ROSALIE - LASTA MIA - VUJANOVIC TEODORA	KARATE UNION SHOTOKAN TIROL		AUSTRIA



AUSTRIAN JUNIOR OPEN 2023 - 2023-06-24

Kata Team female U16

R1 G1/1 (3) Tatami 6 11:30(2023-06-24)

Competitors	Kata	1	2	3	4	5	6	7	TOTAL	Extra	Total	Rank
1 KARATE SHOTOKAN LORA ZELL AM SEE (BYTYQI, BYTYQI, LORA) (SHOTOKAN LORA)	029 HEIAN GODAN	(7.0)	(6.2)	6.5	6.2	6.6			19.3		19.3	2
2 KARATE UNION WALSERFELD (MARJANOVIC, STURM, VENTIMIGLIA) (KU WALSERFELD)	012 ENPI	(8.0)	(6.6)	7.6	6.9	7.4			21.9		21.9	1
3 ASIA SPORTS KARATESCHULE (DRESSLER, EHLING, LEGLER) (A.S. WALDKRAIBURG)												

Results

1	KARATE UNION WALSERFELD - MARJANOVIC TIJANA - VENTIMIGLIA VIKTORIA - STURM ISABELL	KARATE UNION WALSERFELD		AUSTRIA
2	KARATE SHOTOKAN LORA ZELL AM SEE - LORA ALIJI - BYTYQI LORENA - BYTYQI LONDRESA	KARATE SHOTOKAN LORA ZELL AM SEE		AUSTRIA



AUSTRIAN JUNIOR OPEN 2023 - 2023-06-24

Kata Team female U18

R1 G1/1 (3) Tatami 4 08:30(2023-06-24)

Competitors	Kata	1	2	3	4	5	6	7	TOTAL	Extra	Total	Rank
1 KARATE UNION WALSERFELD (ARMAGAN, ILIC, TSCHALER) (KU WALSERFELD)	029 HEIAN GODAN	6.8	6.4	(6.2)	6.5	(7.0)			19.7		19.7	2
2 KARATE EMME (GALLIMORE, RITZ, RITZ) (KARATE EMME)	001 ANAN	7.2	7.1	(6.6)	7.2	(7.8)			21.5		21.5	1
3 KARATE UNION SHOTOKAN TIROL (HARASSER, LASTA, NIKOLI) (KARATE ST. JOHANN I.T.)	040 KANKU DAI	(5.0)	(5.0)	5.0	5.0	5.0			15.0		15.0	3

Results

1	KARATE EMME - RITZ MAIA - RITZ LILA - GALLIMORE KIM	KARATE EMME		SWITZERLAND
2	KARATE UNION WALSERFELD - ILIC MARTINA - TSCHALER LARISSA - ARMAGAN ALEYNA	KARATE UNION WALSERFELD		AUSTRIA
3	KARATE UNION SHOTOKAN TIROL - NIKOLI EMA - LASTA KATJA - HARASSER MARISA	KARATE UNION SHOTOKAN TIROL		AUSTRIA



# Kata Team male U10

AUSTRIAN JUNIOR OPEN 2023, Schulstrasse 17, 5071 Wals, AUT

2023-06-24

Tatami  
3 08:30

Pool  
1/1

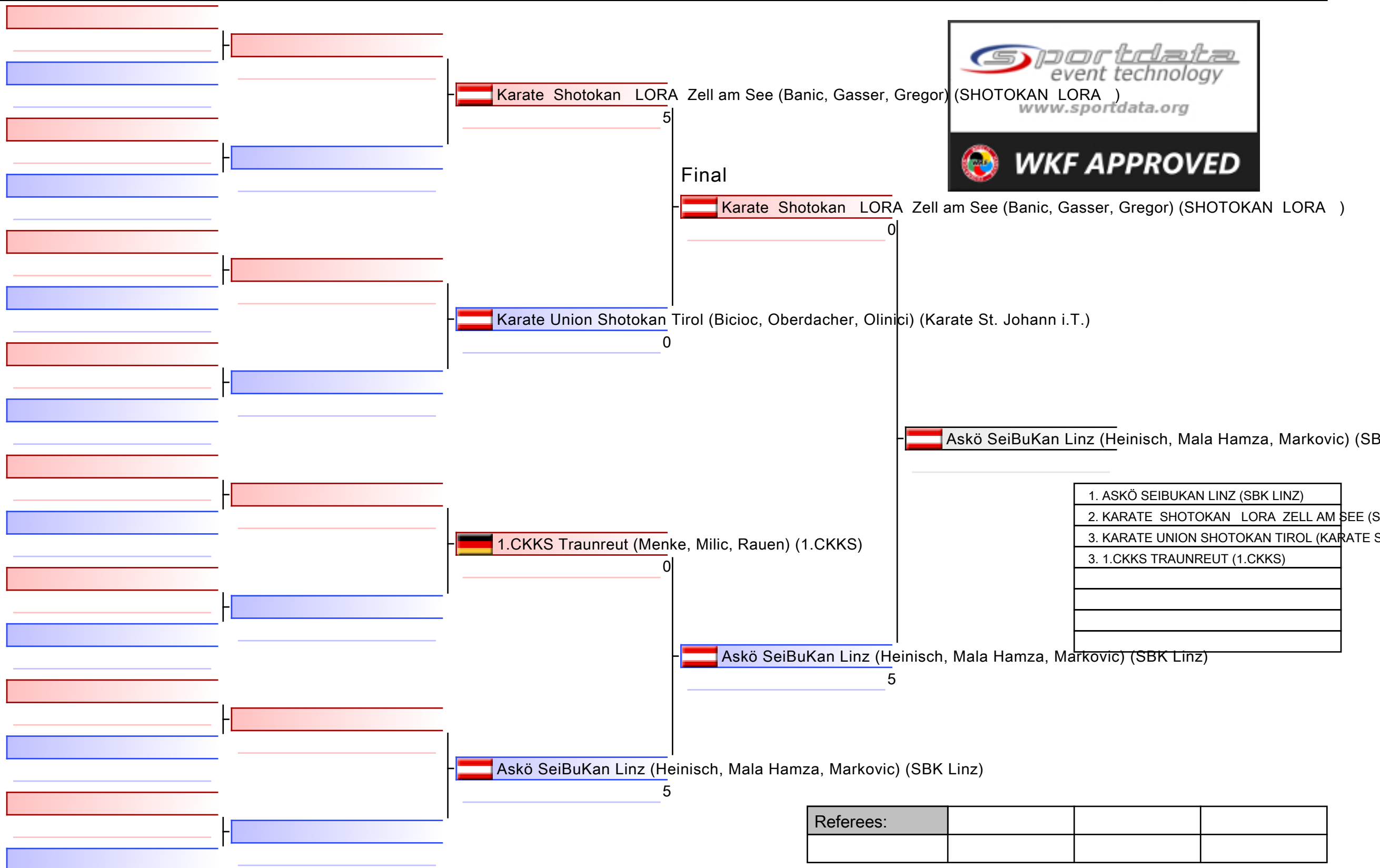

1. ASKÖ SEIBUKAN LINZ (SBK LINZ)
2. KARATE SHOTOKAN LORA ZELL AM SEE (SHOTOKAN LORA)
3. KARATE UNION SHOTOKAN TIROL (KARATE ST. JOHANN I.T.)
3. 1. CKKS TRAUNREUT (1. CKKS)

Referees:			

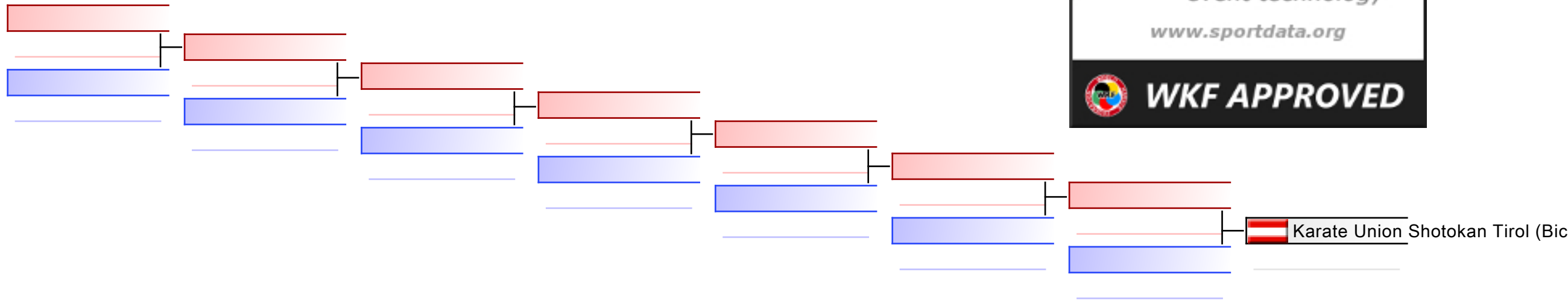

REPECHAGE: (1)

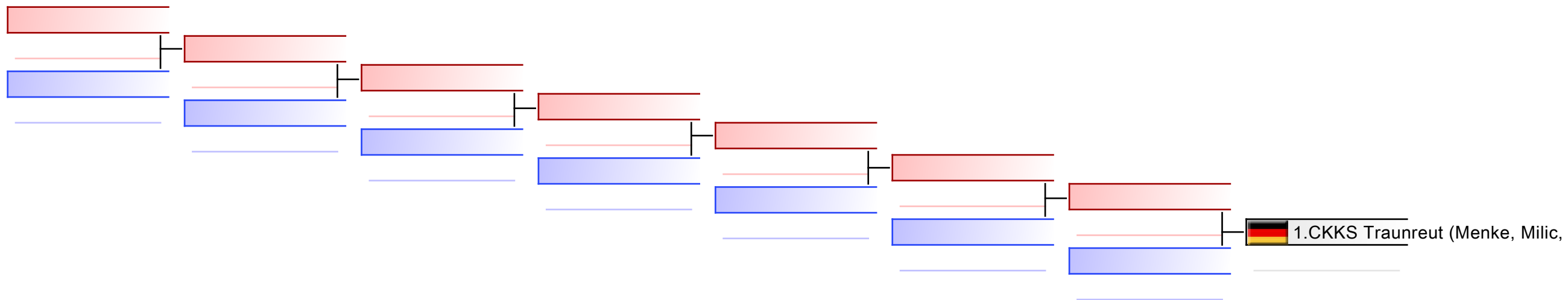

Referees:							
-----------	--	--	--	--	--	--	--

# Kata Team male U12

AUSTRIAN JUNIOR OPEN 2023, Schulstrasse 17, 5071 Wals, AUT

2023-06-24

Tatami  
6 08:30

Pool  
1/1

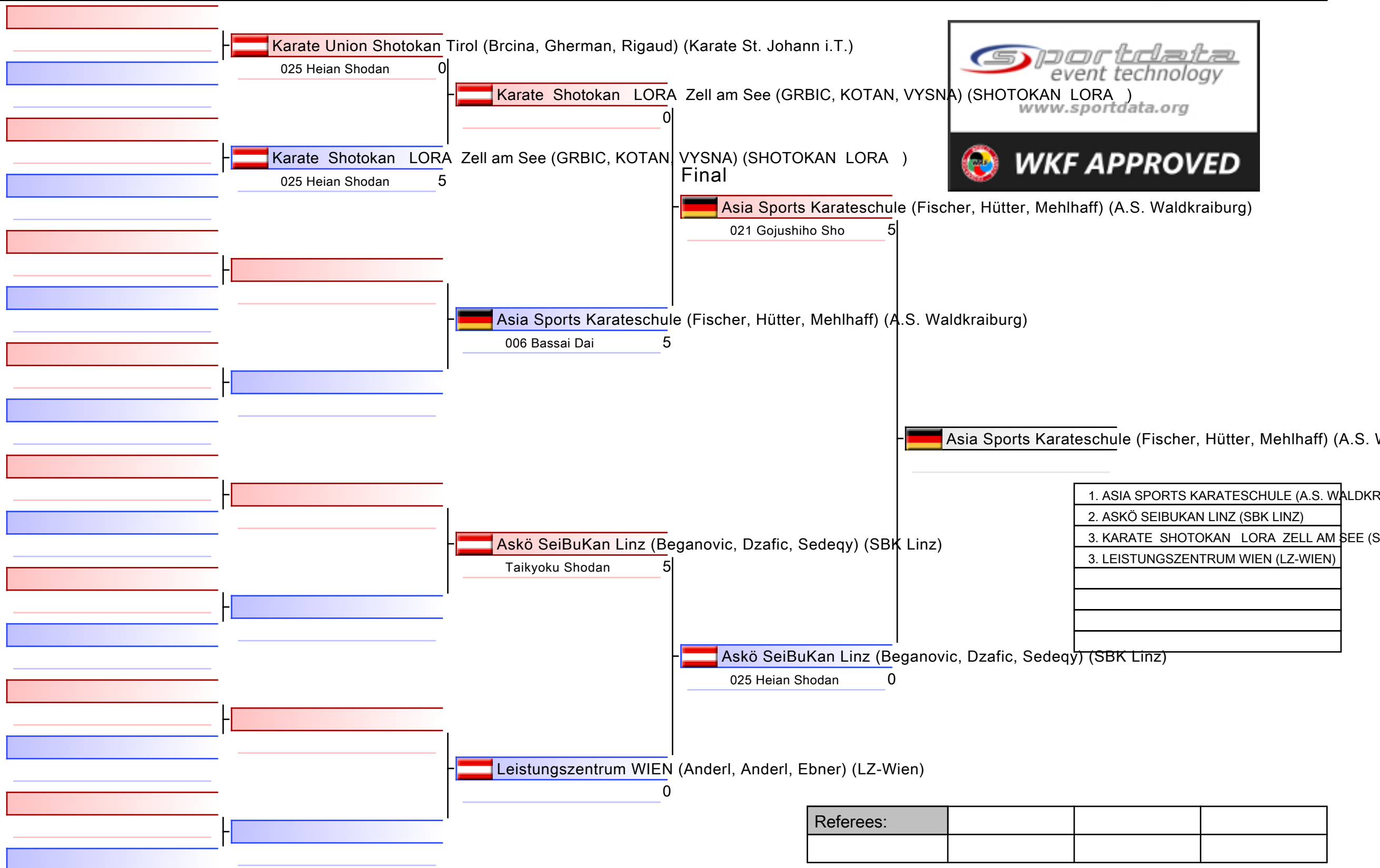

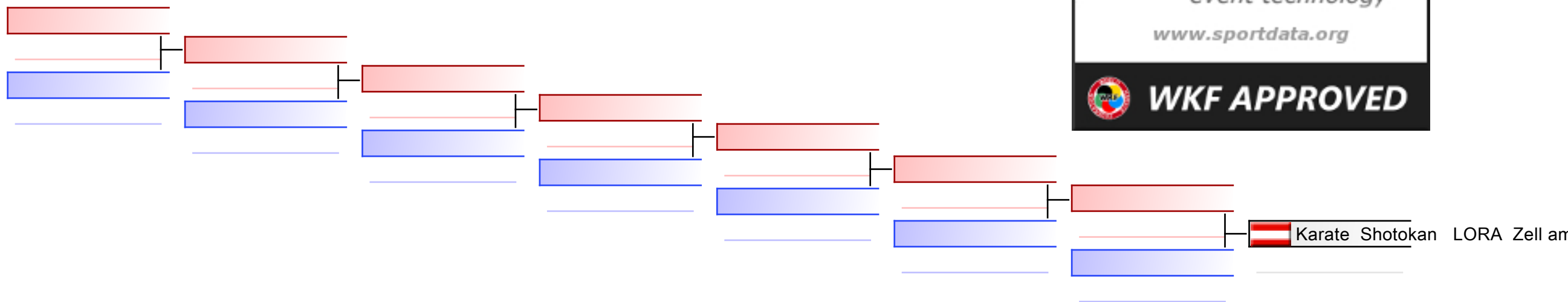

REPECHAGE: (1)

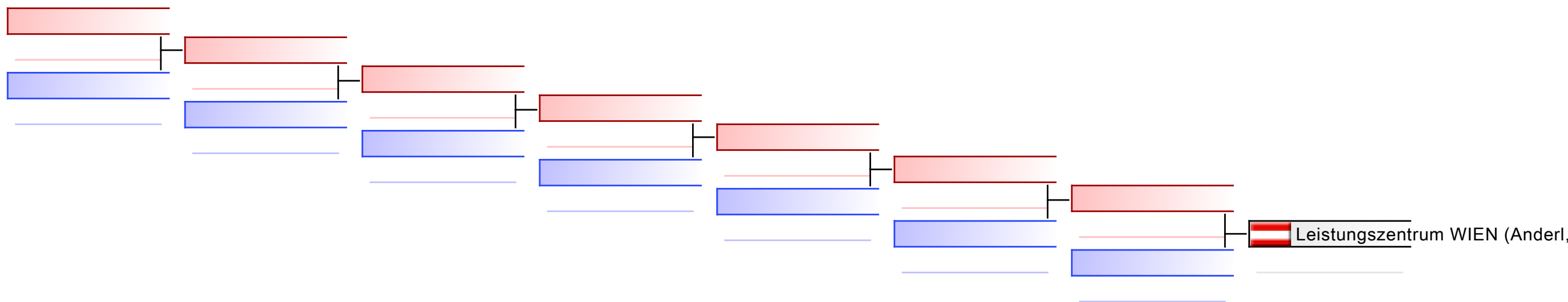

Referees:							
-----------	--	--	--	--	--	--	--



AUSTRIAN JUNIOR OPEN 2023 - 2023-06-24

Kata Team male U14 U16

R1 G1/1 (3) Tatami 1 08:30(2023-06-24)

Competitors	Kata	1	2	3	4	5	6	7	TOTAL	Extra	Total	Rank
1 KARATE UNION WALSERFELD (KAPS, MAIER, SACHER) (KU WALSERFELD)	026 HEIAN NIDAN	(3.0)	(3.0)	3.0	3.0	3.0			9.0		9.0	1
2 KARATE UNION WALSERFELD (SCHACHINGER, WALLNER, WALLNER) (KU WALSERFELD)	006 BASSAI DAI	(1.0)	1.0	(2.0)	1.0	1.0			3.0		3.0	3
3 KARATE ZANSHIN KOBLACH/HARD/BREGENZ (BUTTAZONI, FEND, STANIKZAIE) (KARATE ZANSHIN)	026 HEIAN NIDAN	(2.0)	2.0	(1.0)	2.0	2.0			6.0		6.0	2

Results

1	KARATE ZANSHIN KOBLACH/HARD/BREGENZ - BUTTAZONI HUGO - STANIKZAIE HEJRATULLAH - FEND LEO	KARATE ZANSHIN KOBLACH/HARD/BREGENZ		AUSTRIA
2	KARATE UNION WALSERFELD - SCHACHINGER LORENZ - WALLNER NOAH - WALLNER JONAS	KARATE UNION WALSERFELD		AUSTRIA
3	KARATE UNION WALSERFELD - KAPS LUKAS - SACHER THOMAS - MAIER ALEXANDER	KARATE UNION WALSERFELD		AUSTRIA



AUSTRIAN JUNIOR OPEN 2023 - 2023-06-24

Kata Team male U18

R1 G1/1 (2) Tatami 2 08:30(2023-06-24)

Competitors	Kata	1	2	3	4	5	6	7	TOTAL	Extra	Total	Rank
1 BUSHIDO KARATE PERUGIA (FUSCAGNI, GIOVAGNONI, ROMAGNOLI) (BKP)	067 PAIKU	7.5	(7.2)	(7.9)	7.3	7.4			22.2		22.2	1
2 AKS FIRENZE (DE_MEO, FIORAVANTI, MELANI) (AKS FIRENZE)	012 ENPI	6.8	(6.0)	6.3	(7.0)	6.4			19.5		19.5	2

Results

1	BUSHIDO KARATE PERUGIA - FUSCAGNI ALEX - GIOVAGNONI GIOELE - ROMAGNOLI EMANUEL	BUSHIDO KARATE PERUGIA		ITALY
2	AKS FIRENZE - MELANI MATTEO - DE_MEO MARCO - FIORAVANTI RICCARDO	AKS FIRENZE		ITALY

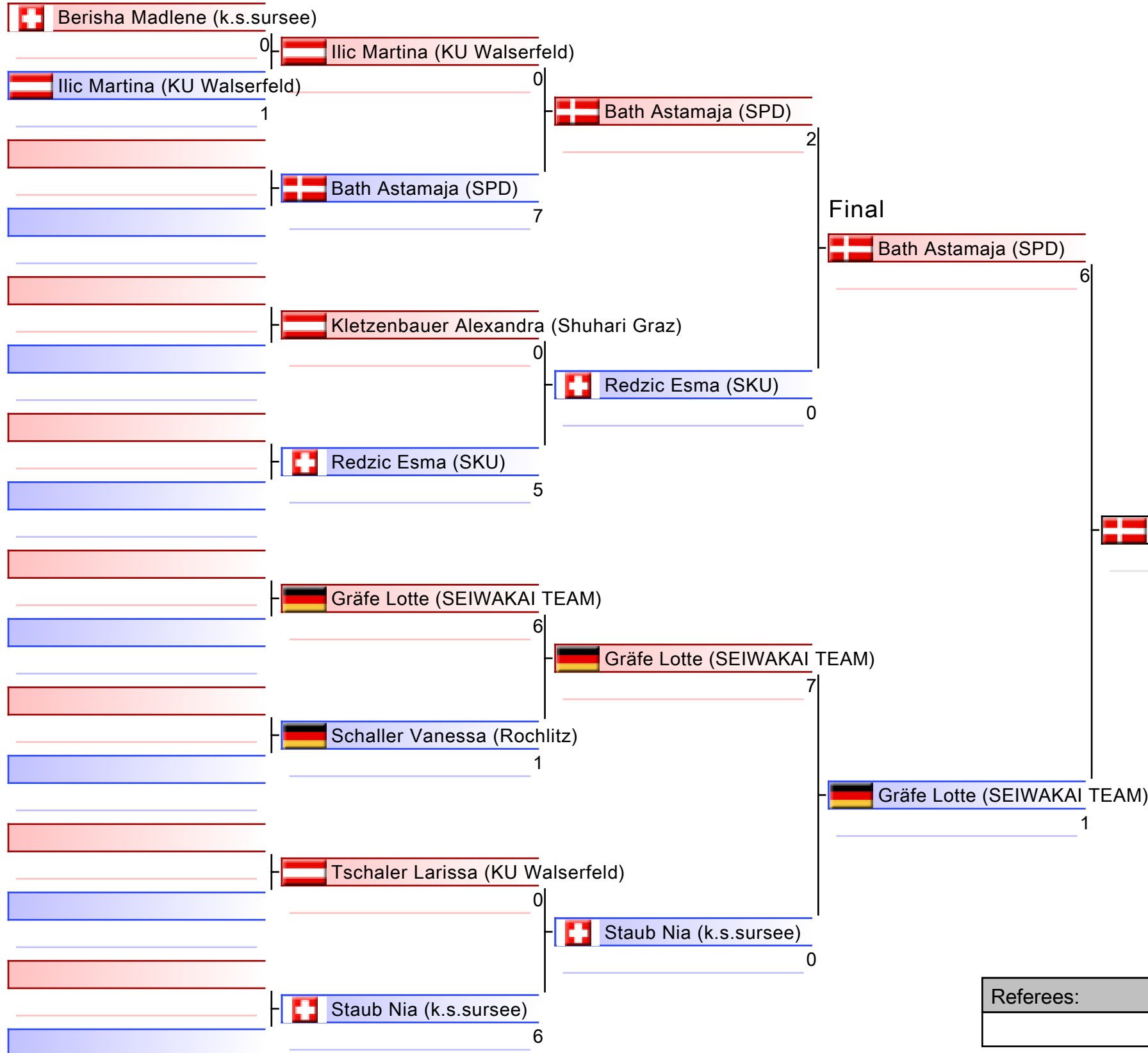

1. BATH ASTAMAJA (SPD)
2. GRÄFE LOTTE (SEIWAKAI TEAM)
3. REDZIC ESMA (SKU)
3. STAUB NIA (K.S.SURSEE)
5. ILIC MARTINA (KU WALSERFELD)
5. SCHALLER VANESSA (ROCHLITZ)

Referees:			

# Kumite Individual female Cadets +61

AUSTRIAN JUNIOR OPEN 2023

2023-06-24

Tatami  
4 15:20

Pool  
1

(c)sportdata GmbH & Co KG 2000-2023 (2023-06-24 21:05) v 10.0.1 build 1 (2023-05-19 20:00 CET) License: Online\_Event\_ID-6821\_AUSTRIANJUNIOROPEN2023 (expire 2023-07-08)

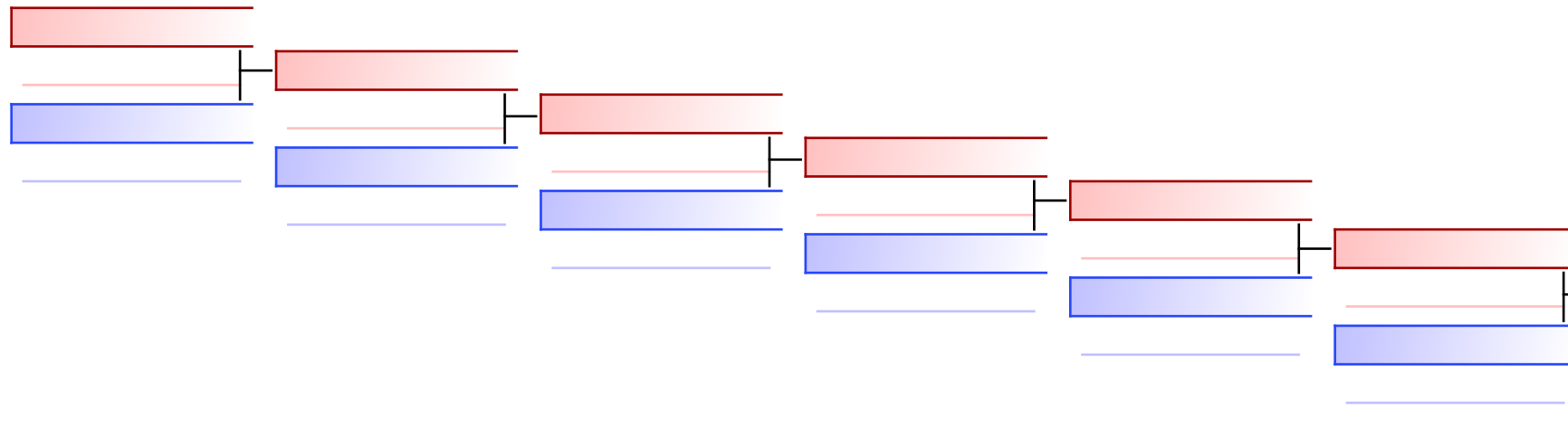

Ilic Martina (KU Walserfeld)  
 0  
 Redzic Esma (SKU)  
 Redzic Esma (SKU)  
 8

## REPECHAGE: (1)

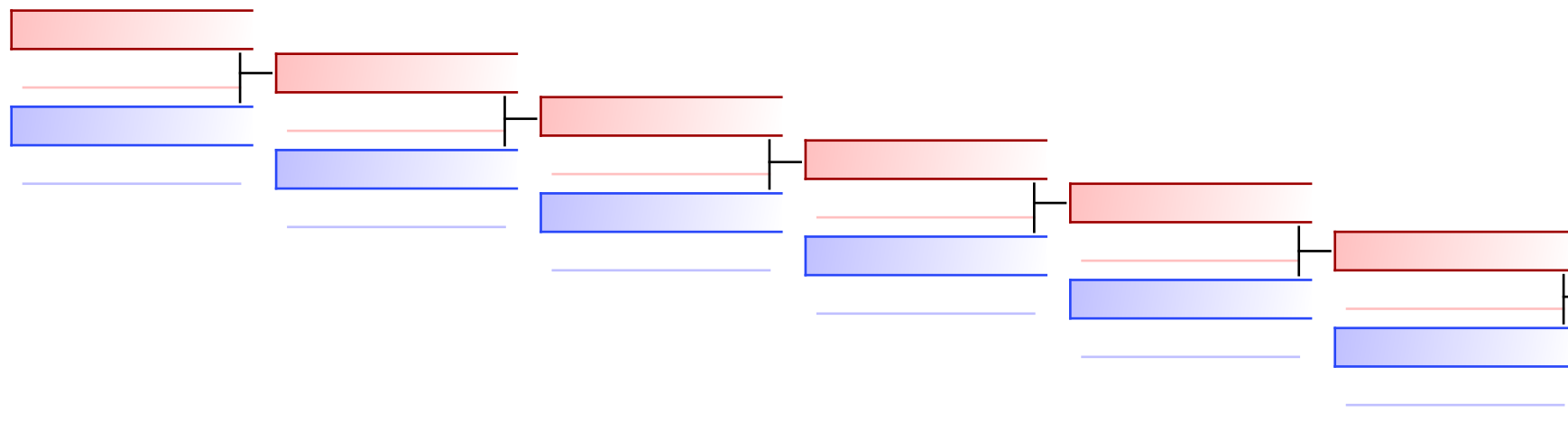

Schaller Vanessa (Rochlitz)  
 1  
 Staub Nia (k.s.sursee)  
 Staub Nia (k.s.sursee)  
 3

Referees:							
-----------	--	--	--	--	--	--	--



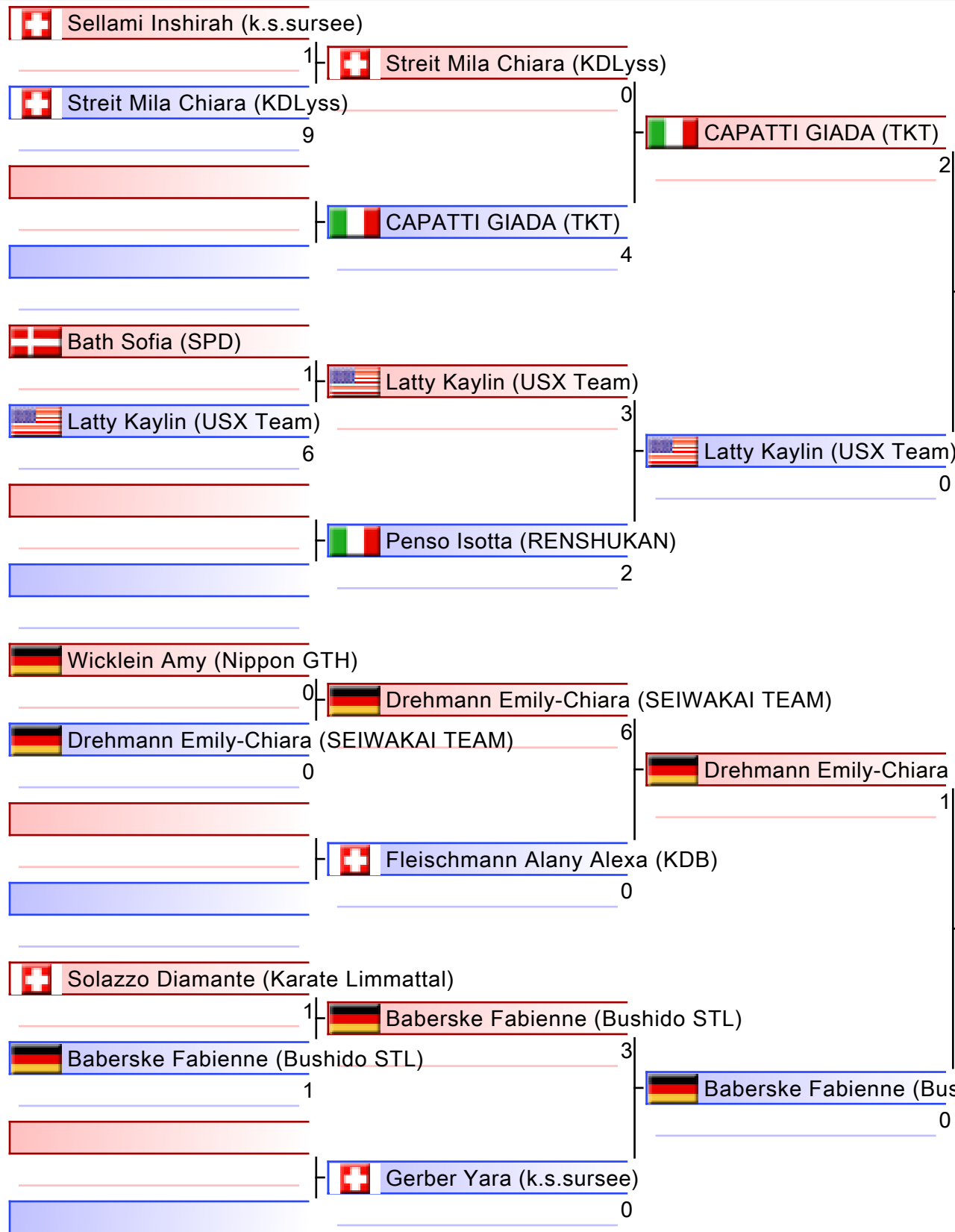

- |  |
|--|
| 1. CAPATTI GIADA (TKT)                   |
| 2. DREHMANN EMILY-CHIARA (SEIWAKAI TEAM) |
| 3. LATTY KAYLIN (USX TEAM)               |
| 3. BABERSKE FABIENNE (BUSHIDO STL)       |
| 5. STREIT MILA CHIARA (KDLYSS)           |
| 5. WICKLEIN AMY (NIPPON GTH)             |
| 7. FLEISCHMANN ALANY ALEXA (KDB)         |

Referees:			

# Kumite Individual female Cadets -47

AUSTRIAN JUNIOR OPEN 2023

2023-06-24

Tatami  
4 16:05

Pool  
1

(c)sportdata GmbH & Co KG 2000-2023 (2023-06-24 21:05) v 10.0.1 build 1 (2023-05-19 20:00 CET) License: Online\_Event\_ID-6821\_AUSTRIANJUNIOROPEN2023 (expire 2023-07-08)

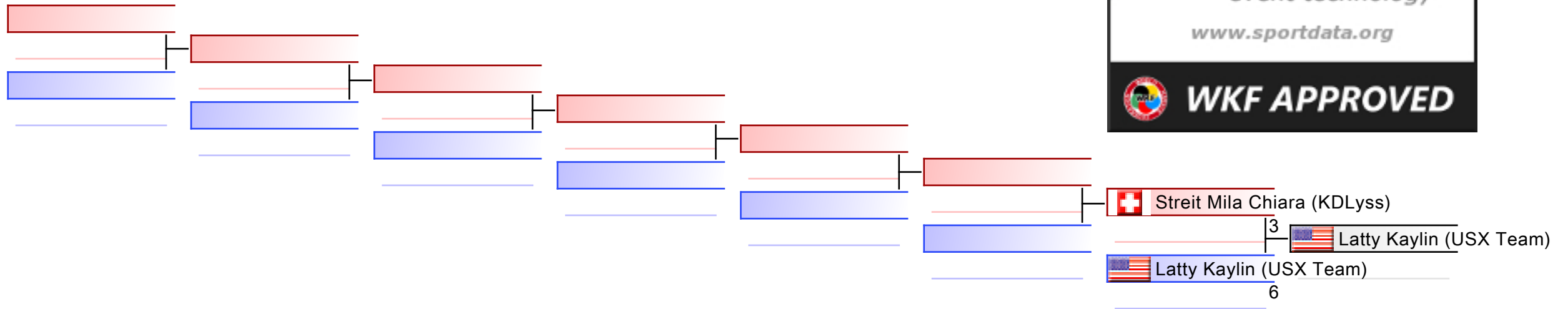

## REPECHAGE: (1)

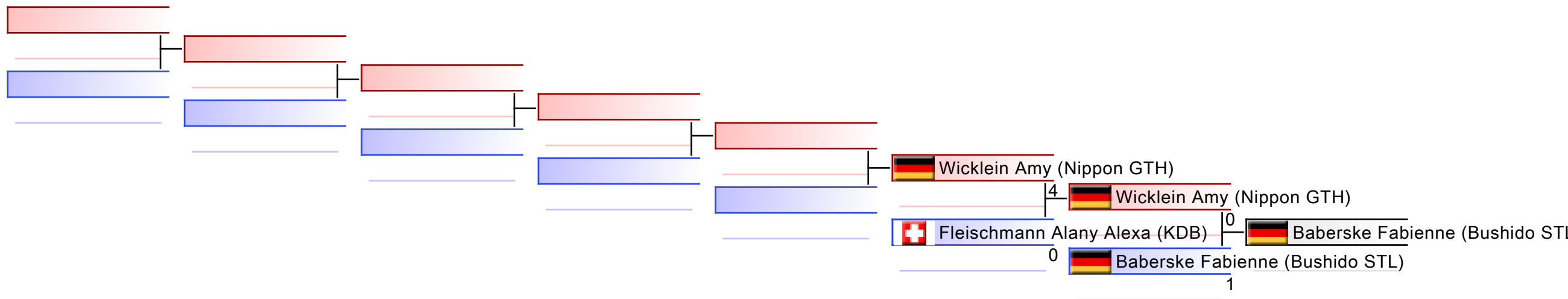

Referees:							
-----------	--	--	--	--	--	--	--

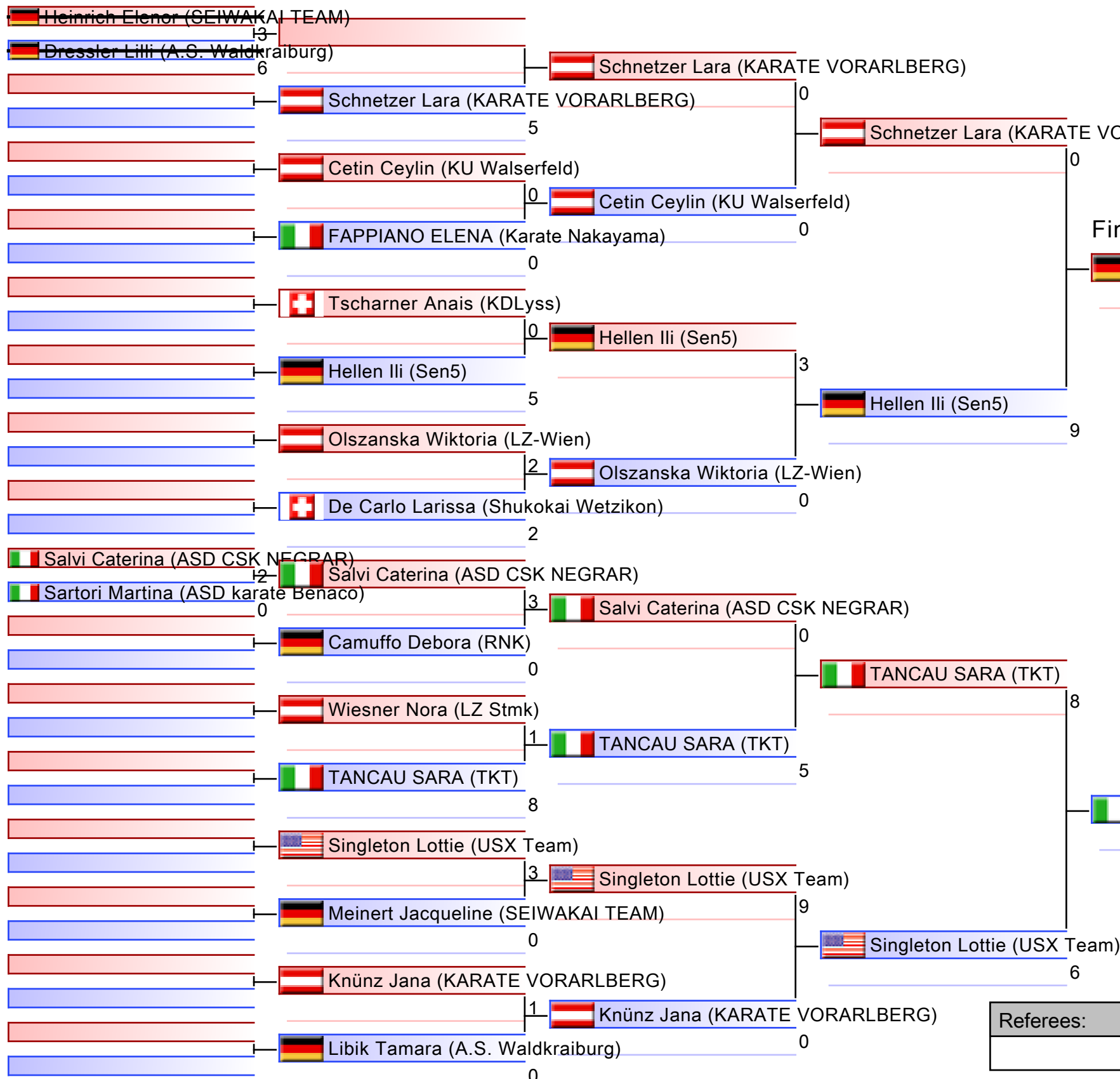

- |                                       |
|---------------------------------------|
| 1. HELLEN ILI (SEN5)                  |
| 2. TANCAU SARA (TKT)                  |
| 3. SCHNETZER LARA (KARATE VORARLBERG) |
| 3. SINGLETON LOTTIE (USX TEAM)        |
| 5. TSCHARNER ANAIS (KDLYSS)           |
| 5. WIESNER NORA (LZ STMK)             |
| 7. OLSZANSKA WIKTORIA (LZ-WIEN)       |
| 7. SALVI CATERINA (ASD CSK NEGRAR)    |

Referees:			

# Kumite Individual female Cadets -54

AUSTRIAN JUNIOR OPEN 2023

2023-06-24

Tatami  
2 13:10

Pool  
1

(c)sportdata GmbH & Co KG 2000-2023 (2023-06-24 21:05) v 10.0.1 build 1 (2023-05-19 20:00 CET) License: Online\_Event\_ID-6821\_AUSTRIANJUNIOROPEN2023 (expire 2023-07-08)

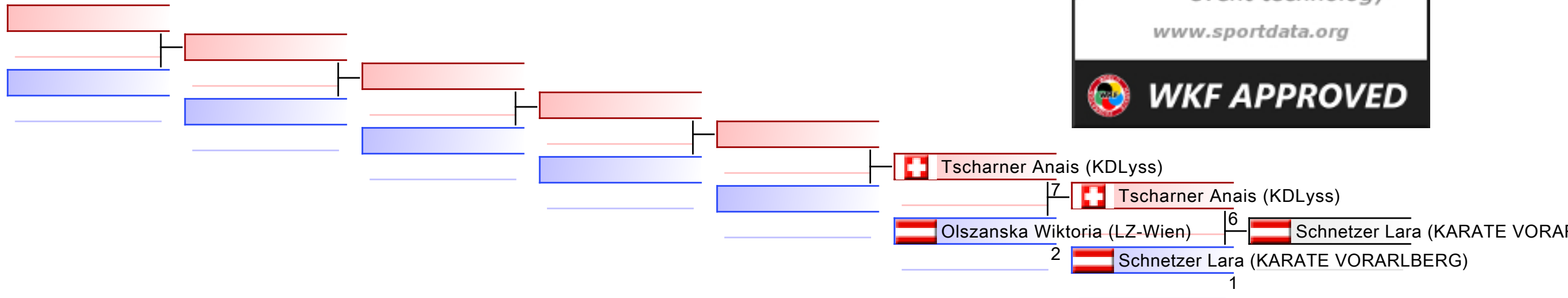

## REPECHAGE: (1)

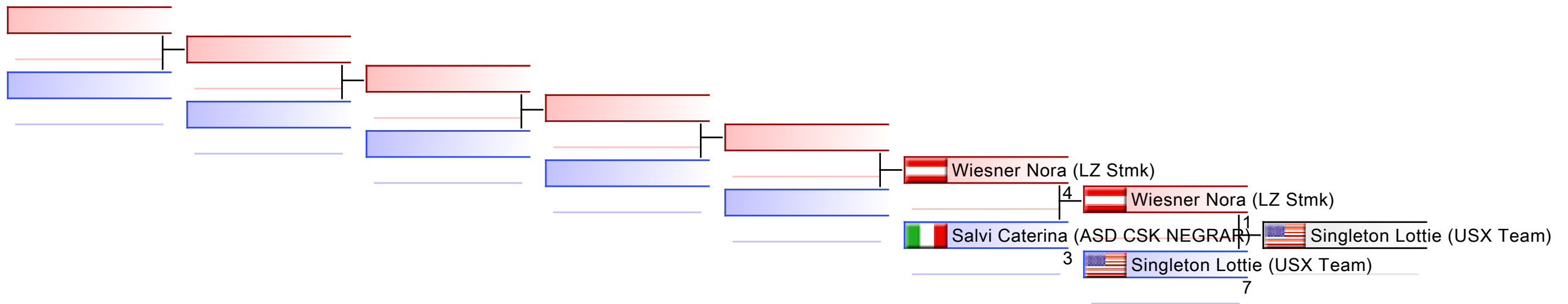

Referees:							
-----------	--	--	--	--	--	--	--

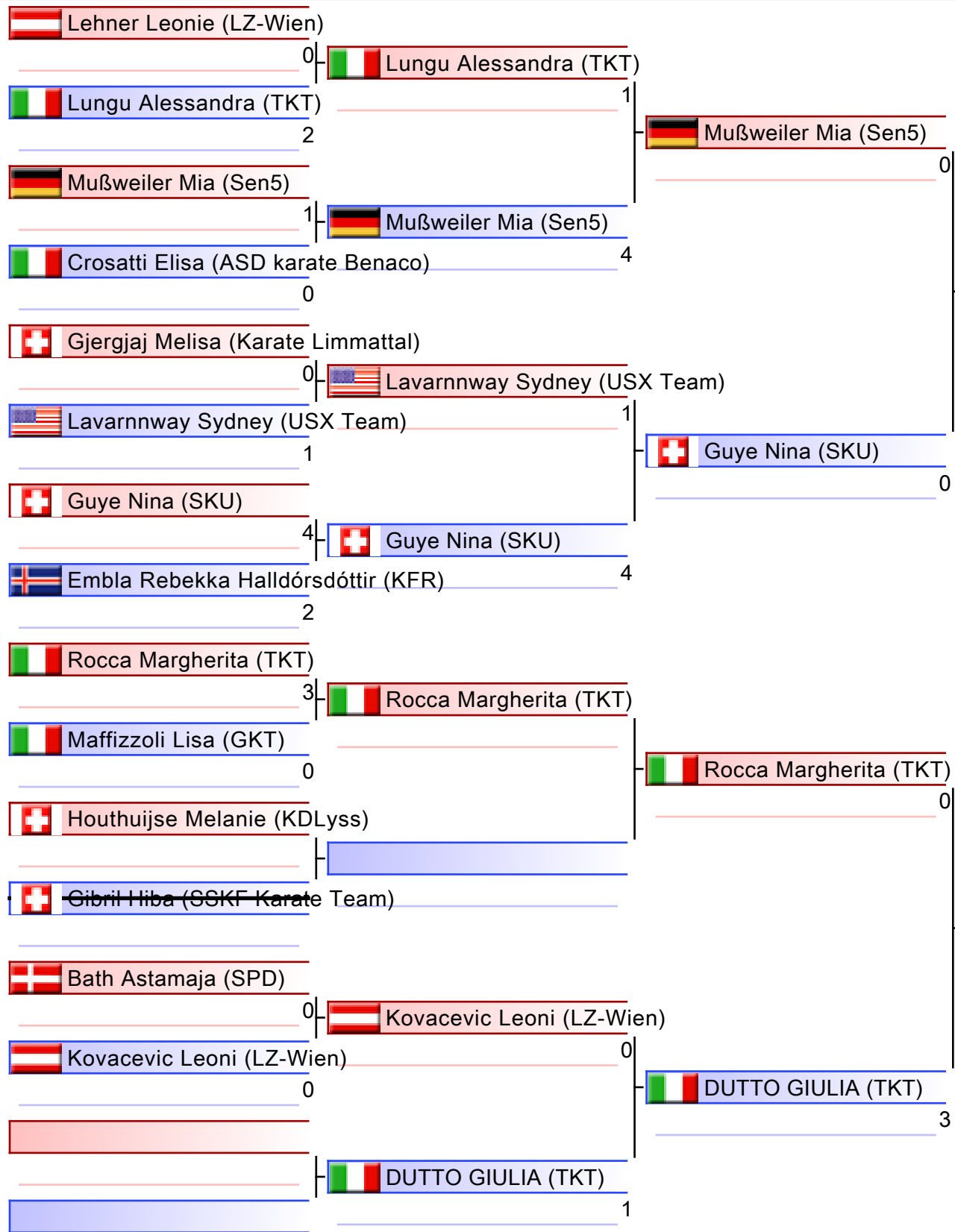

1. DUTTO GIULIA (TKT)
2. GUYE NINA (SKU)
3. ROCCA MARGHERITA (TKT)
3. EMBLA REBEKKA HALLDÓRSDÓTTIR (KFR)
5. KOVACEVIC LEONI (LZ-WIEN)
5. MUSSWEILER MIA (SEN5)
7. LAVARNNWAY SYDNEY (USX TEAM)

Referees:			

# Kumite Individual female Cadets -61

AUSTRIAN JUNIOR OPEN 2023

2023-06-24

Tatami  
4 17:15

Pool  
1

(c)sportdata GmbH & Co KG 2000-2023 (2023-06-24 21:05) v 10.0.1 build 1 (2023-05-19 20:00 CET) License: Online\_Event\_ID-6821\_AUSTRIANJUNIOROPEN2023 (expire 2023-07-08)

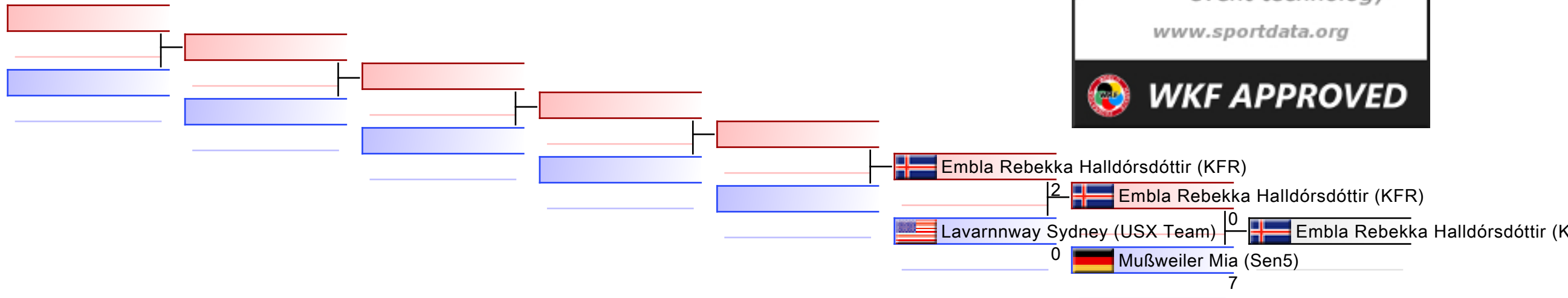

## REPECHAGE: (1)

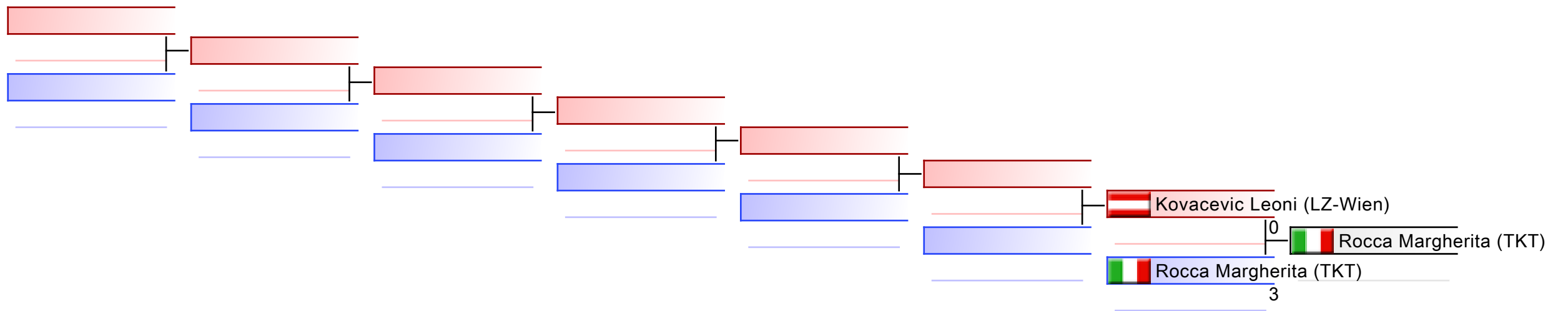

Referees:							
-----------	--	--	--	--	--	--	--

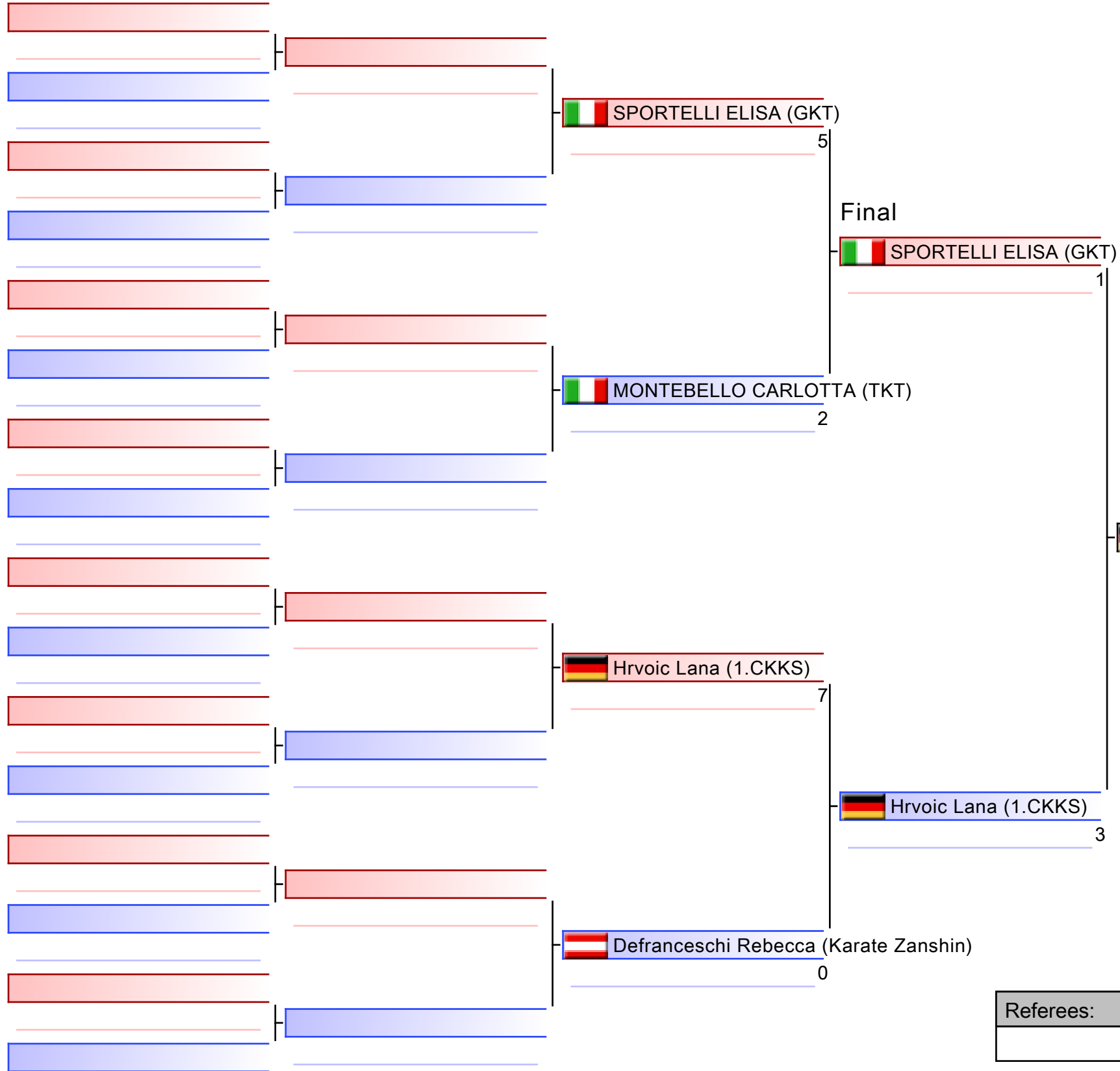

1. HRVOIC LANA (1.CKKS)
2. SPORTELLI ELISA (GKT)
3. MONTEBELLO CARLOTTA (TKT)
3. DEFRANCESCHI REBECCA (KARATE ZANSHIN)

Referees:			

# Kumite Individual female Juniors +66

AUSTRIAN JUNIOR OPEN 2023

2023-06-24

Tatami  
2 14:55

Pool  
1

(c)sportdata GmbH & Co KG 2000-2023 (2023-06-24 21:05) v 10.0.1 build 1 (2023-05-19 20:00 CET) License: Online\_Event\_ID-6821\_AUSTRIANJUNIOROPEN2023 (expire 2023-07-08)

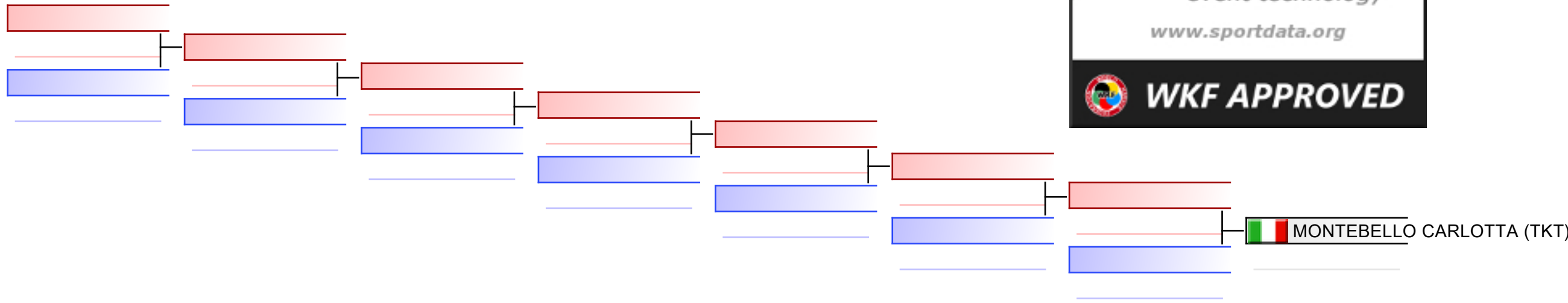

## REPECHAGE: (1)

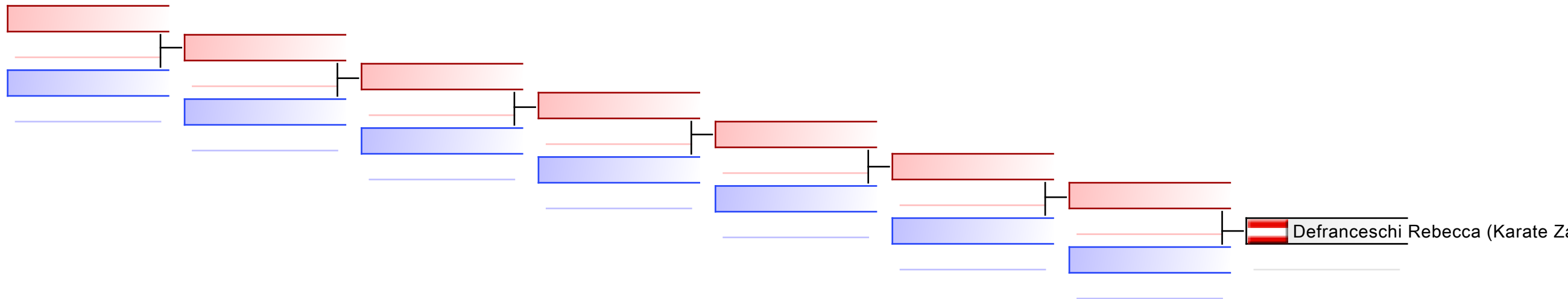

Referees:							
-----------	--	--	--	--	--	--	--



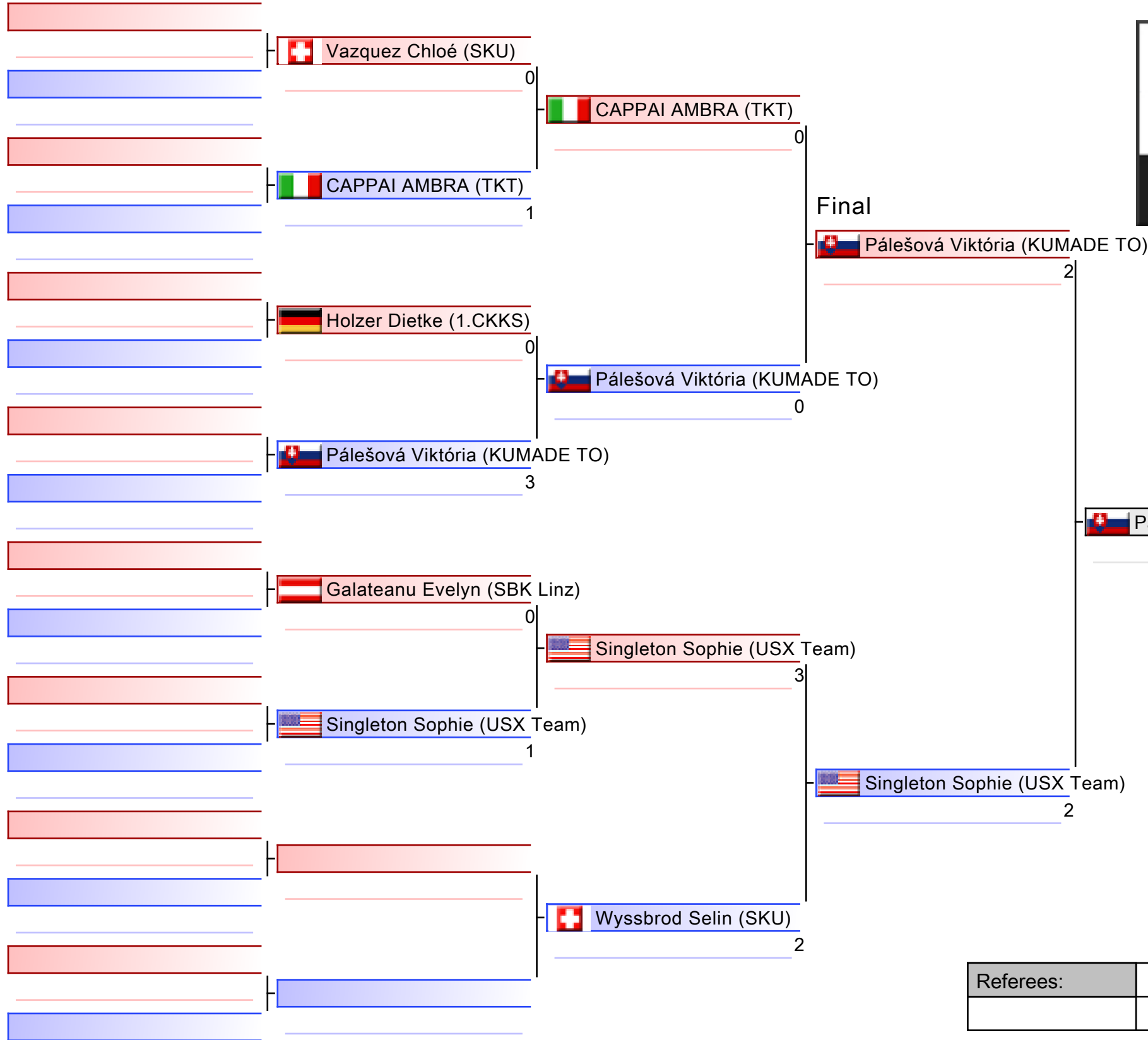

1. PÁLEŠOVÁ VIKTÓRIA (KUMADE TO)
2. SINGLETON SOPHIE (USX TEAM)
3. CAPPAI AMBRA (TKT)
3. WYSSBROD SELIN (SKU)
5. HOLZER DIETKE (1.CKKS)
5. GALATEANU EVELYN (SBK LINZ)

Referees:			

# Kumite Individual female Juniors -48

AUSTRIAN JUNIOR OPEN 2023

2023-06-24

Tatami  
6 14:25

Pool  
1

(c)sportdata GmbH & Co KG 2000-2023 (2023-06-24 21:05) v 10.0.1 build 1 (2023-05-19 20:00 CET) License: Online\_Event\_ID-6821\_AUSTRIANJUNIOROPEN2023 (expire 2023-07-08)

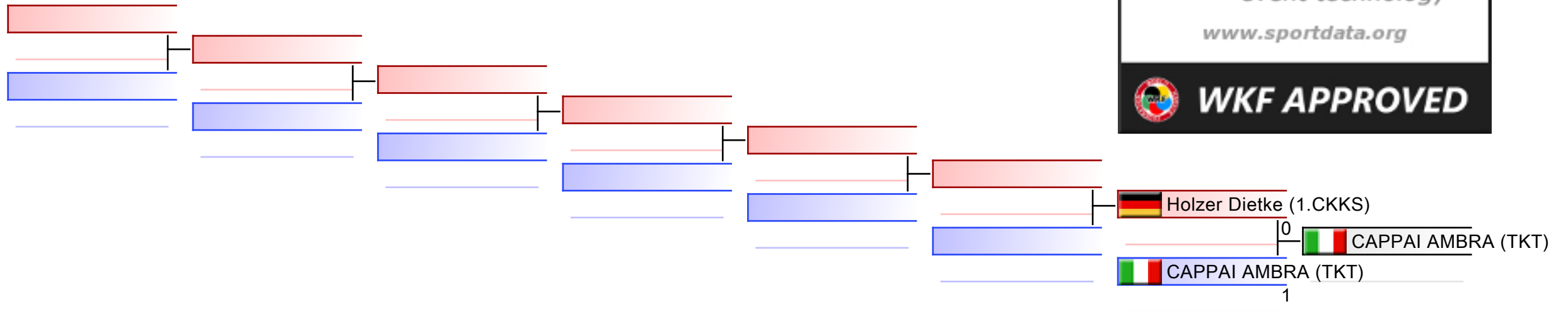

## REPECHAGE: (1)

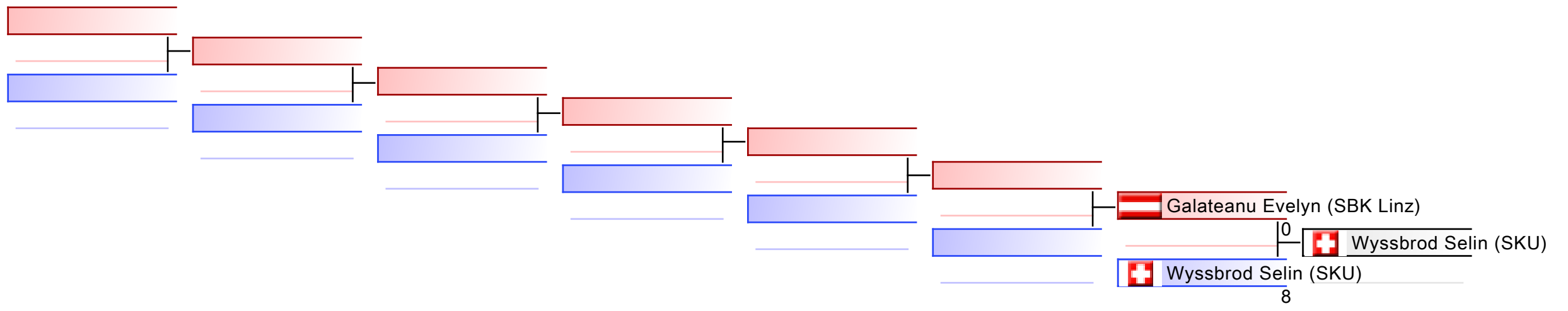

Referees:							
-----------	--	--	--	--	--	--	--

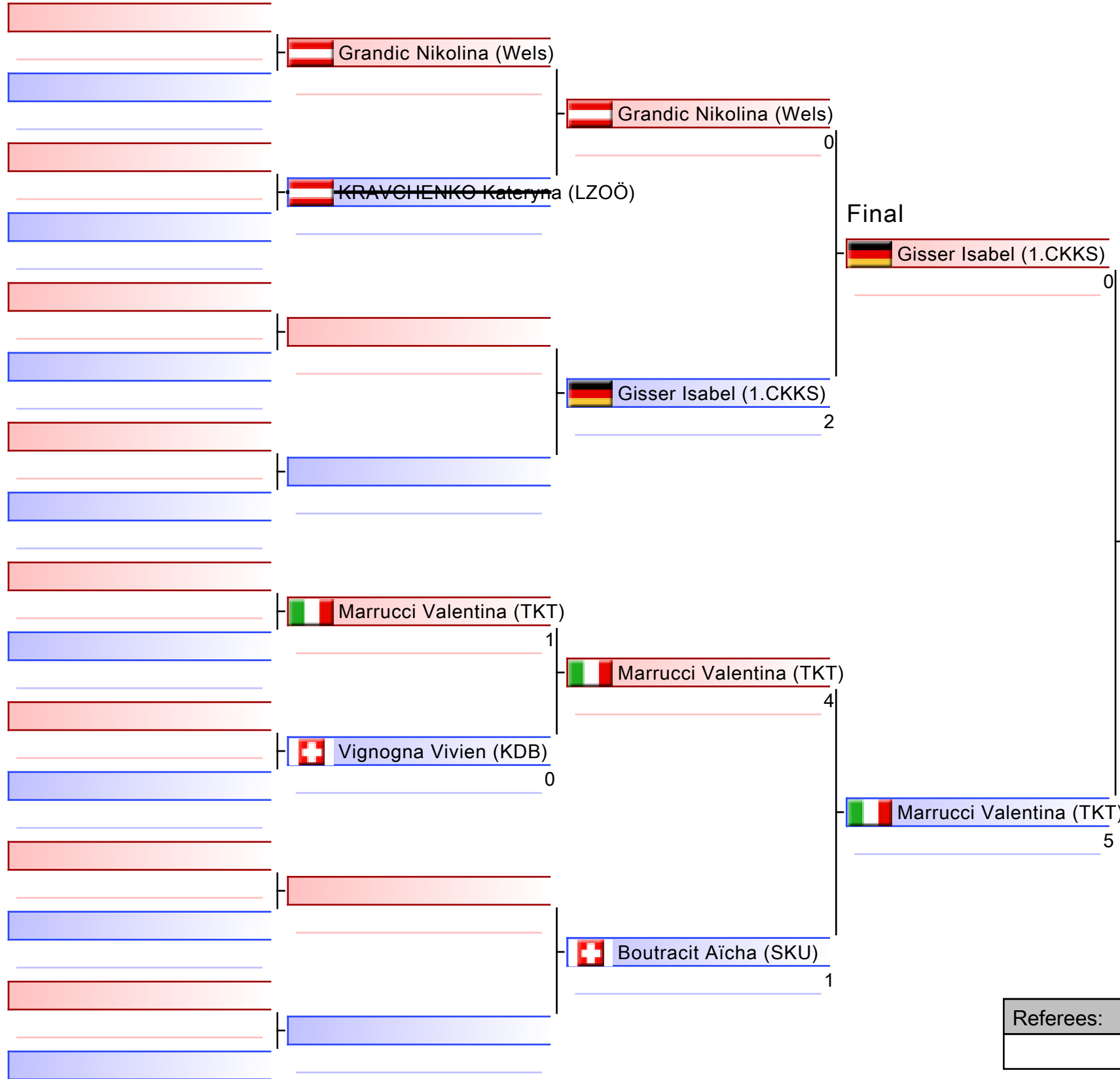

1. MARRUCCI VALENTINA (TKT)
2. GISSER ISABEL (1.CKKS)
3. GRANDIC NIKOLINA (WELS)
3. BOUTRACIT AÏCHA (SKU)
5. VIGNOGNA VIVIEN (KDB)

Referees:			

# Kumite Individual female Juniors -53

AUSTRIAN JUNIOR OPEN 2023

2023-06-24

Tatami  
6 15:00

Pool  
1

(c)sportdata GmbH & Co KG 2000-2023 (2023-06-24 21:05) v 10.0.1 build 1 (2023-05-19 20:00 CET) License: Online\_Event\_ID-6821\_AUSTRIANJUNIOROPEN2023 (expire 2023-07-08)

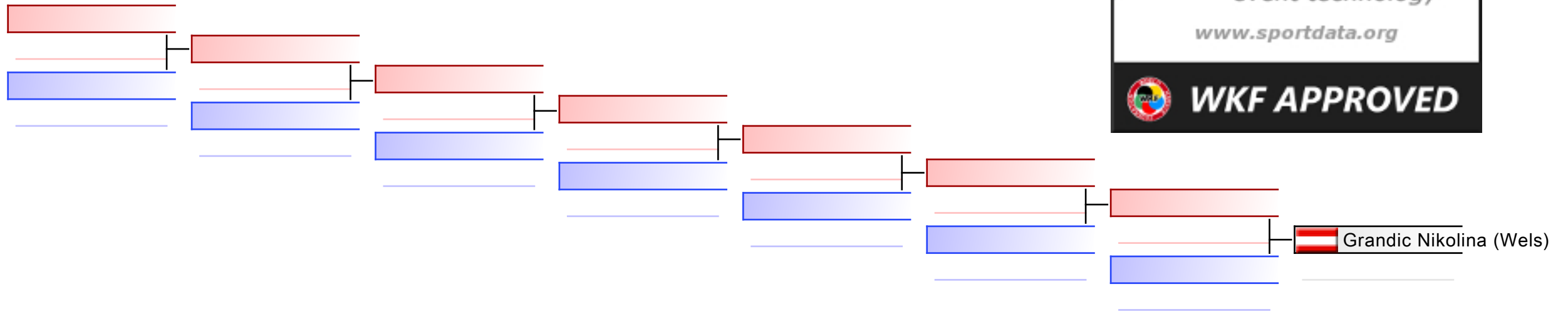

## REPECHAGE: (1)

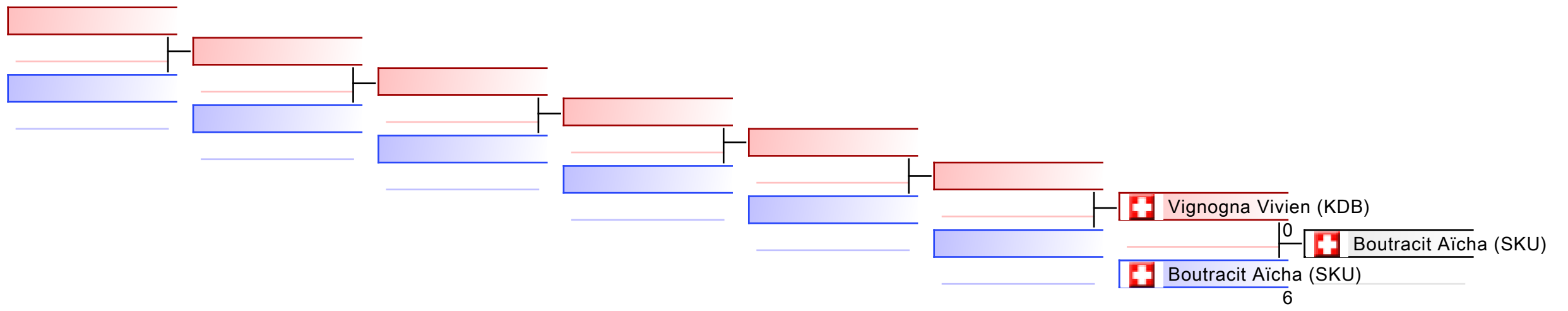

Referees:							
-----------	--	--	--	--	--	--	--

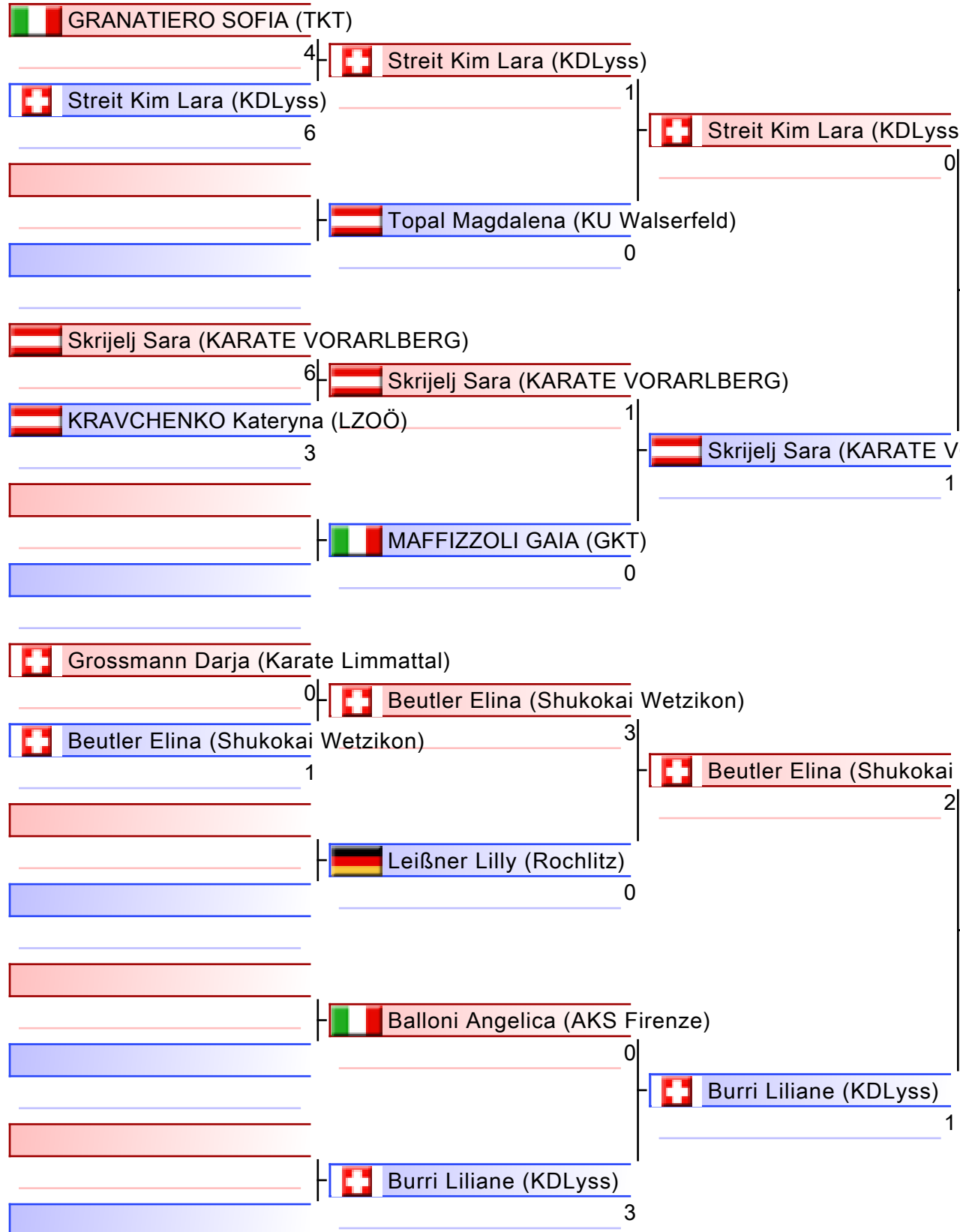

- |                                       |
|---------------------------------------|
| 1. SKRIJELJ SARA (KARATE VORARLBERG)  |
| 2. BEUTLER ELINA (SHUKOKAI WETZIKON)  |
| 3. MAFFIZZOLI GAIA (GKT)              |
| 3. BURRI LILIANE (KDLYSS)             |
| 5. BALLONI ANGELICA (AKS FIRENZE)     |
| 5. LEISSNER LILLY (ROCHLITZ)          |
| 7. KRAVCHENKO KATERYNA (LZOÖ)         |
| 7. GROSSMANN DARJA (KARATE LIMMATTAL) |

Referees:			

# Kumite Individual female Juniors -59

AUSTRIAN JUNIOR OPEN 2023

2023-06-24

Tatami  
3 13:05

Pool  
1

(c)sportdata GmbH & Co KG 2000-2023 (2023-06-24 21:05) v 10.0.1 build 1 (2023-05-19 20:00 CET) License: Online\_Event\_ID-6821\_AUSTRIANJUNIOROPEN2023 (expire 2023-07-08)

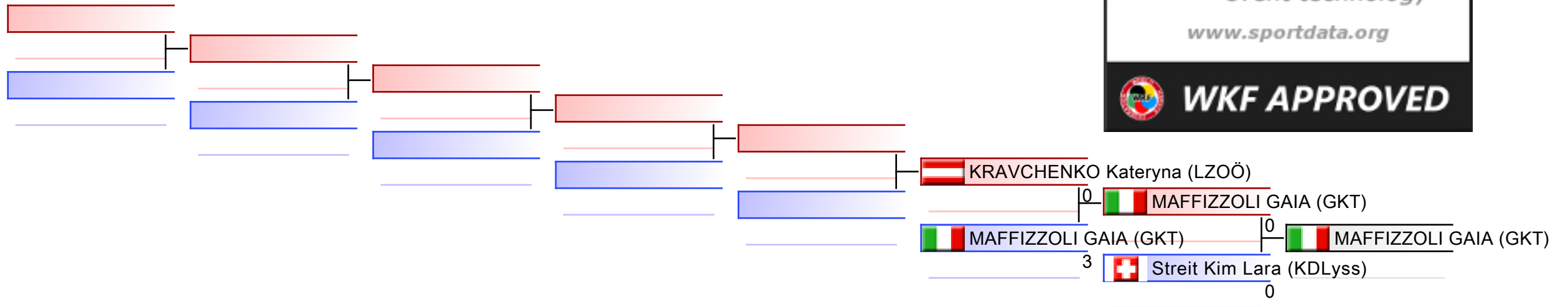

## REPECHAGE: (1)

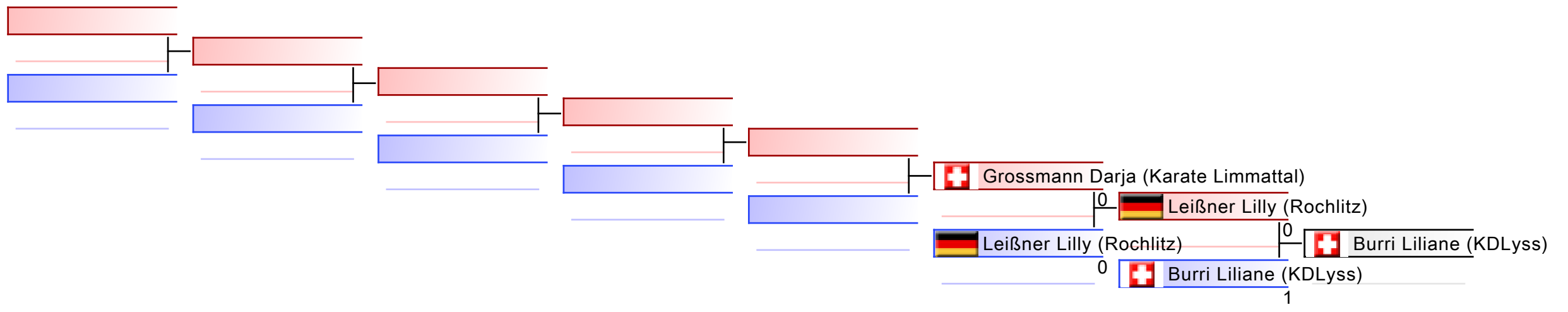

Referees:							
-----------	--	--	--	--	--	--	--

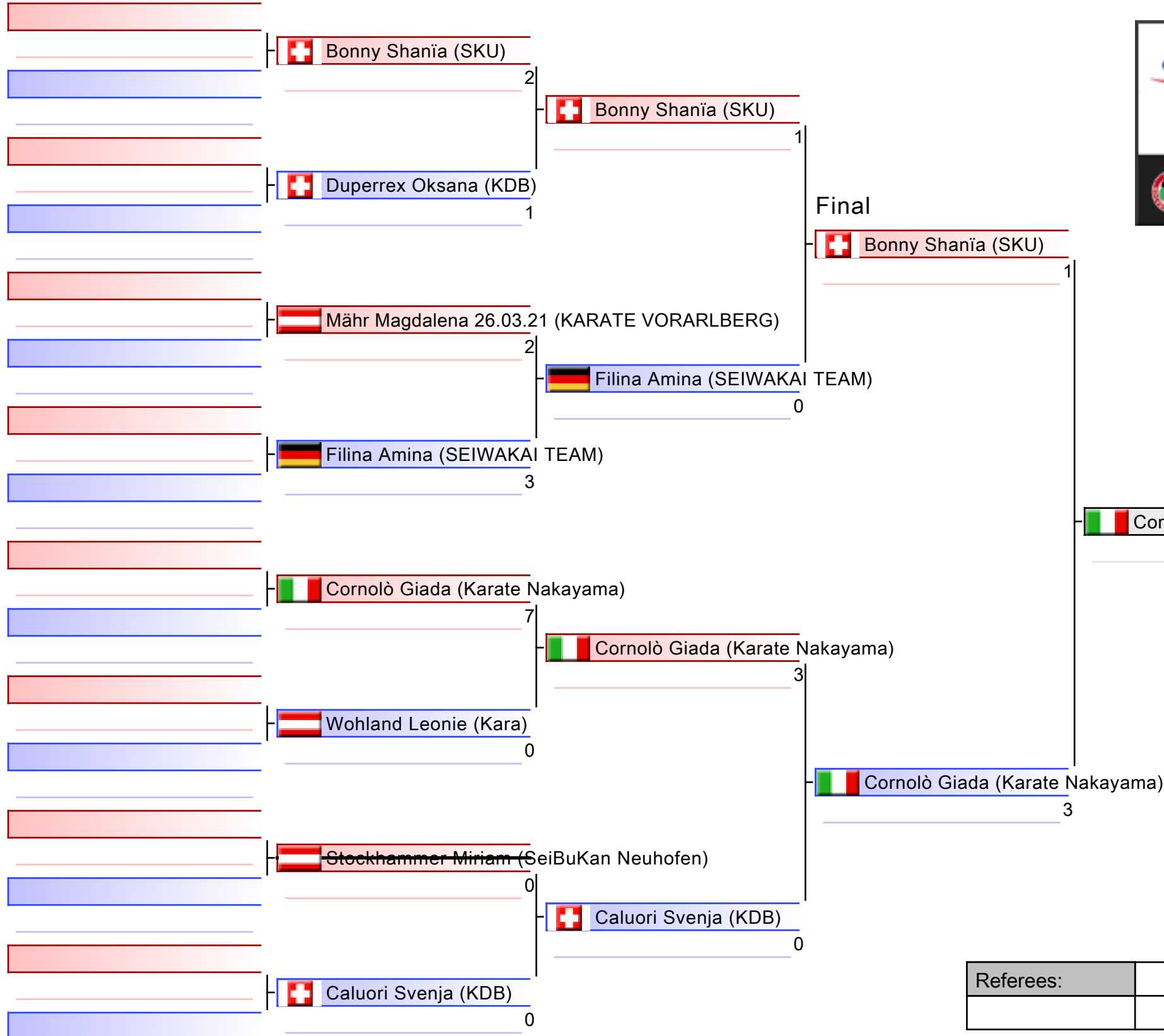

1. CORNOLÒ GIADA (KARATE NAKAYAMA)
2. BONNY SHANIÀ (SKU)
3. DUPERREX OKSANA (KDB)
3. WOHLAND LEONIE (KARA)
5. FILINA AMINA (SEIWAKAI TEAM)
5. CALUORI SVENJA (KDB)

Referees:			

# Kumite Individual female Juniors -66

AUSTRIAN JUNIOR OPEN 2023

2023-06-24

Tatami  
6 15:30

Pool  
1

(c)sportdata GmbH & Co KG 2000-2023 (2023-06-24 21:05) v 10.0.1 build 1 (2023-05-19 20:00 CET) License: Online\_Event\_ID-6821\_AUSTRIANJUNIOROPEN2023 (expire 2023-07-08)

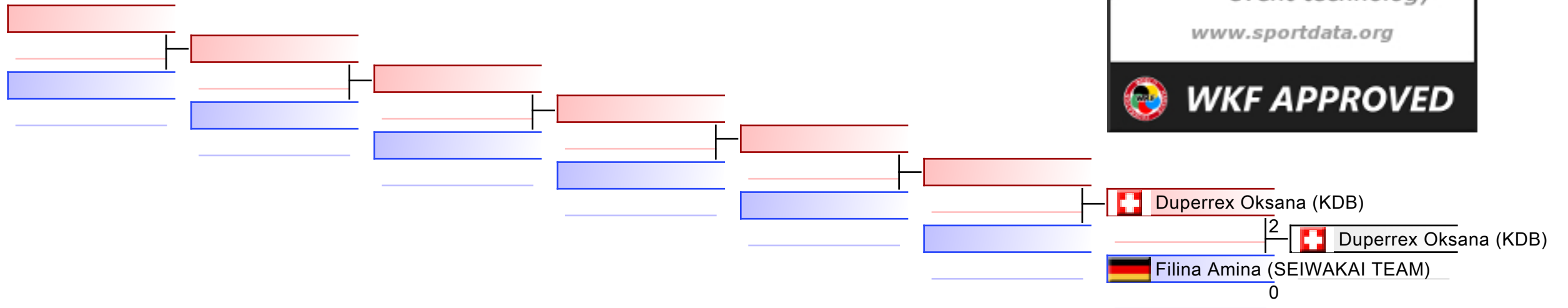

## REPECHAGE: (1)

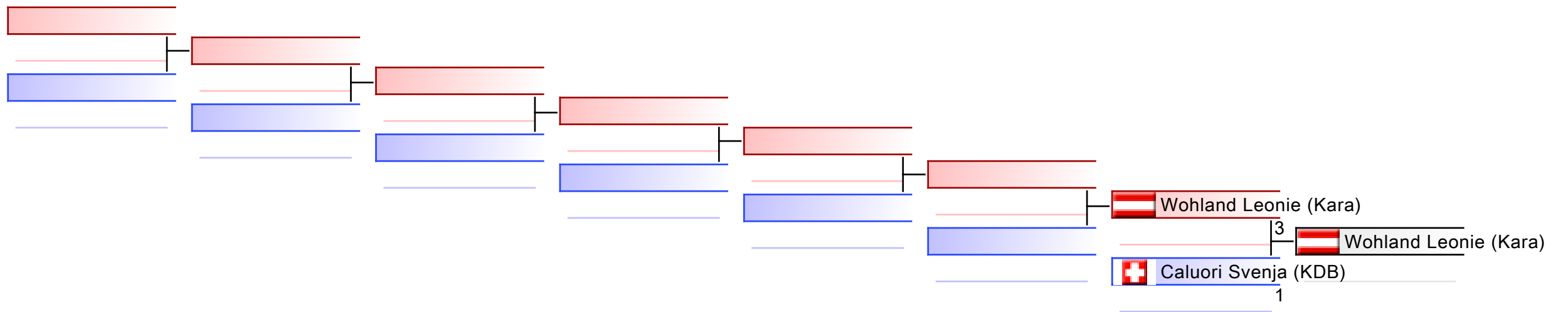

Referees:							
-----------	--	--	--	--	--	--	--



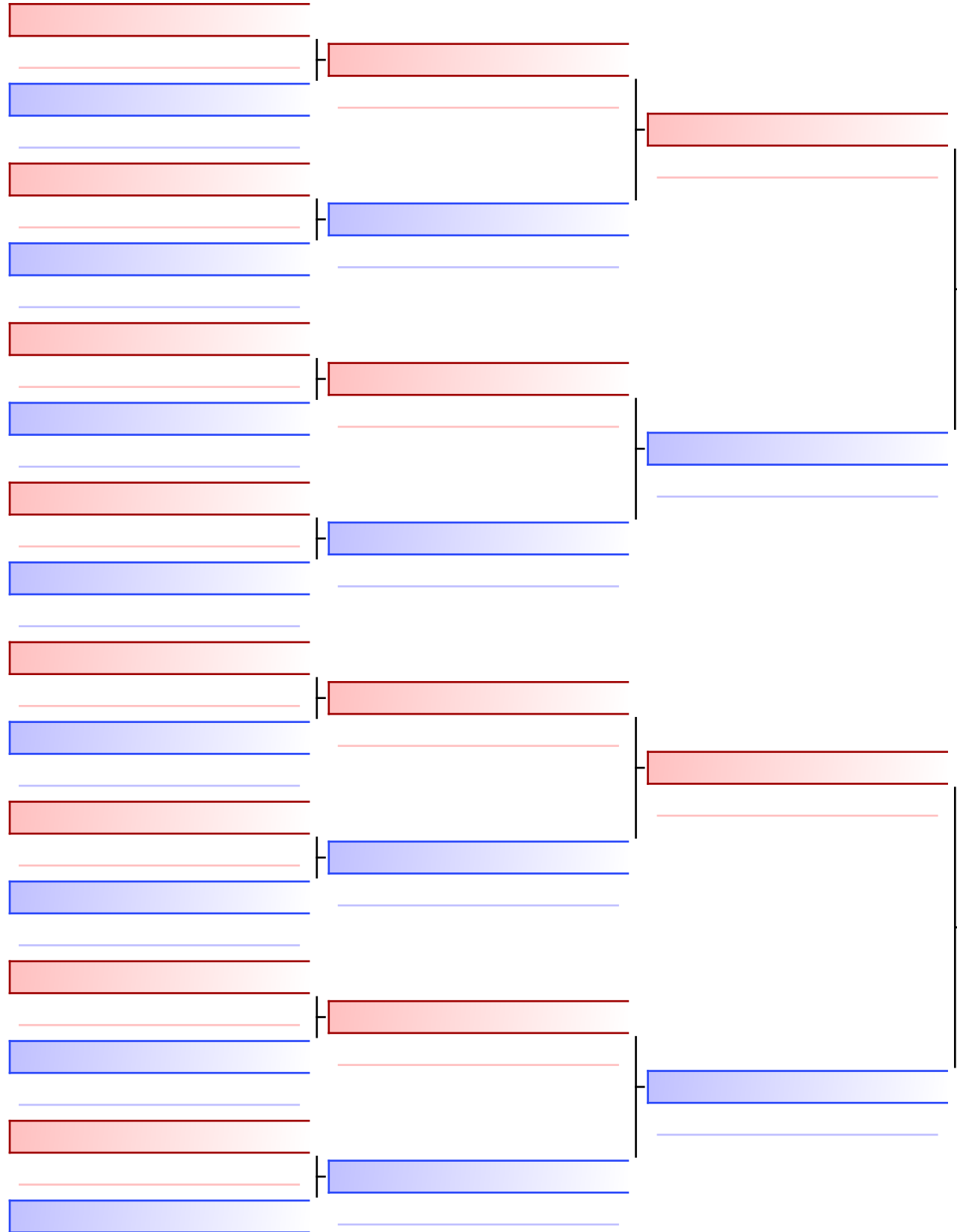

Final

TISAIANU GIULIA (Accademia dello Sport LI)

0

Schmidt Lisa (A.S. Waldkraiburg)

Schmidt Lisa (A.S. Waldkraiburg)

4

1. SCHMIDT LISA (A.S. WALDKRAIBURG)
2. TISAIANU GIULIA (ACCADEMIA DELLO SPORT)

Referees:			

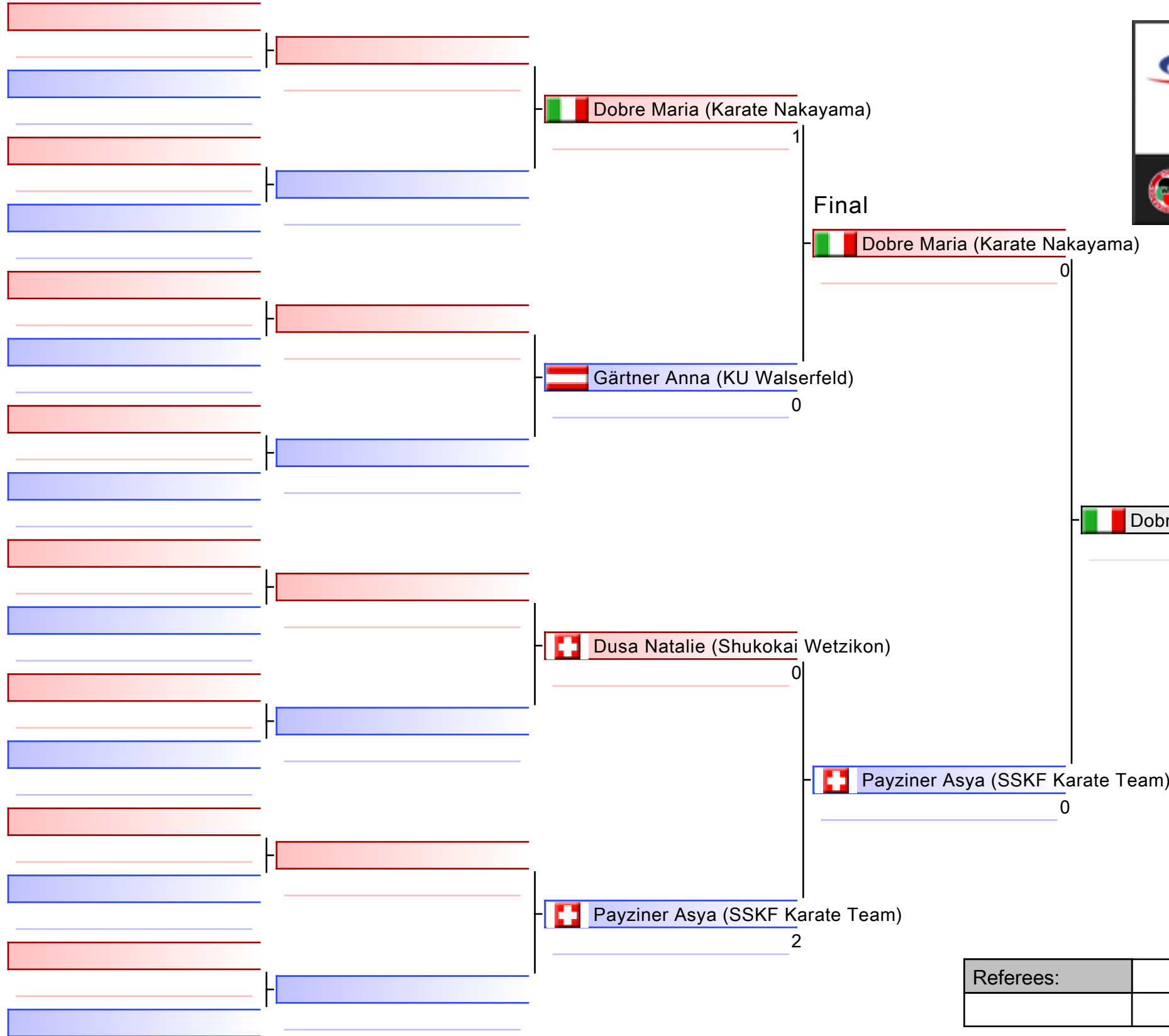

1. DOBRE MARIA (KARATE NAKAYAMA)
2. PAYZINER ASYA (SSKF KARATE TEAM)
3. GÄRTNER ANNA (KU WALSERFELD)
3. DUSA NATALIE (SHUKOKAI WETZIKON)

Referees:			

# KUMITE INDIVIDUAL FEMALE U10 +33kg

AUSTRIAN JUNIOR OPEN 2023

2023-06-24

Tatami  
1 14:25

Pool  
1

(c)sportdata GmbH & Co KG 2000-2023 (2023-06-24 21:05) v 10.0.1 build 1 (2023-05-19 20:00 CET) License: Online\_Event\_ID-6821\_AUSTRIANJUNIOROPEN2023 (expire 2023-07-08)

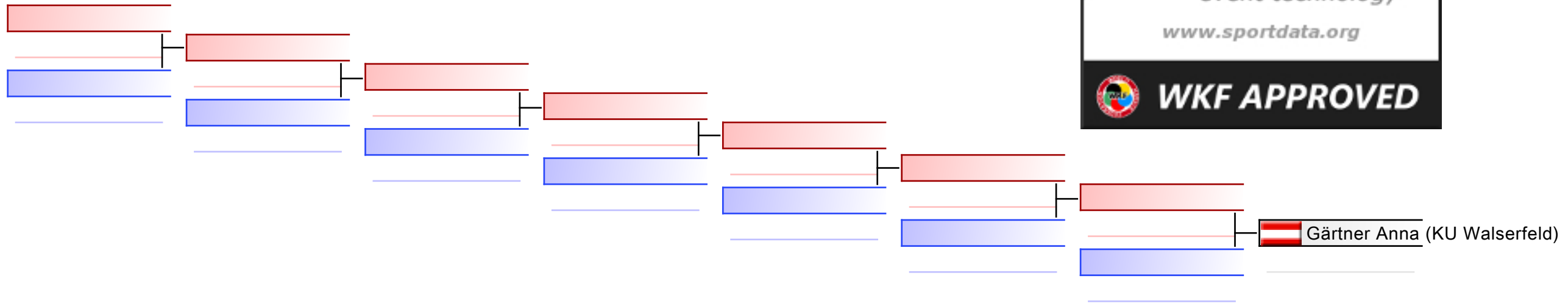

## REPECHAGE: (1)

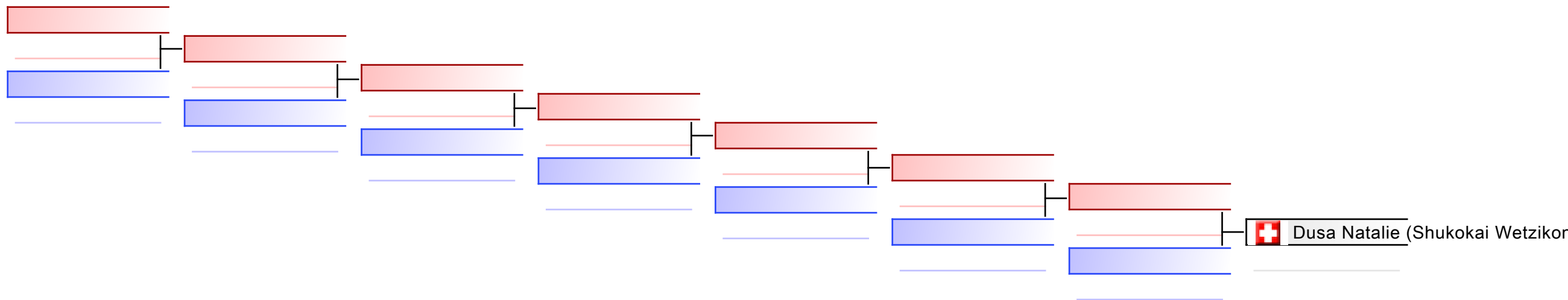

Referees:							
-----------	--	--	--	--	--	--	--

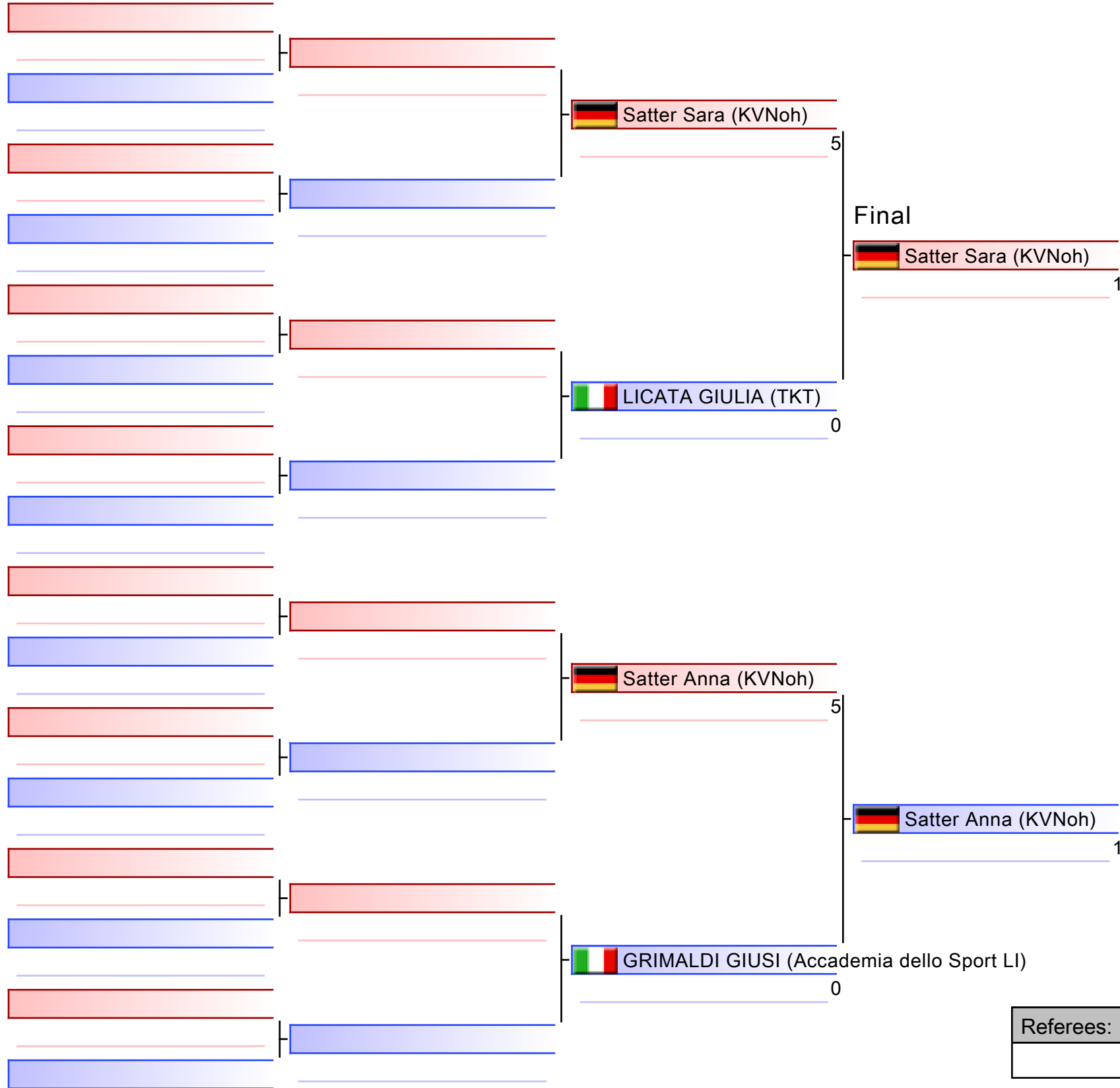

Satter Sara (KVNoh)

1. SATTER SARA (KVNOH)
2. SATTER ANNA (KVNOH)
3. LICATA GIULIA (TKT)
3. GRIMALDI GIUSI (ACCADEMIA DELLO SPORT LI)

Referees:			

Kumite Individual female U10 -27 kg

AUSTRIAN JUNIOR OPEN 2023

2023-06-24

Tatami  
1 14:40

Pool  
1

(c)sportdata GmbH & Co KG 2000-2023 (2023-06-24 21:05) v 10.0.1 build 1 (2023-05-19 20:00 CET) License: Online\_Event\_ID-6821\_AUSTRIANJUNIOROPEN2023 (expire 2023-07-08)

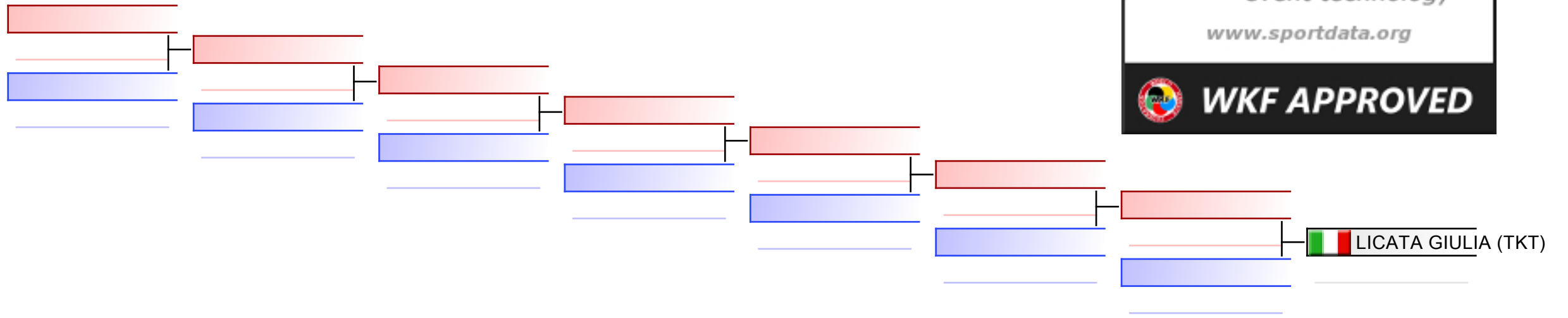

REPECHAGE: (1)

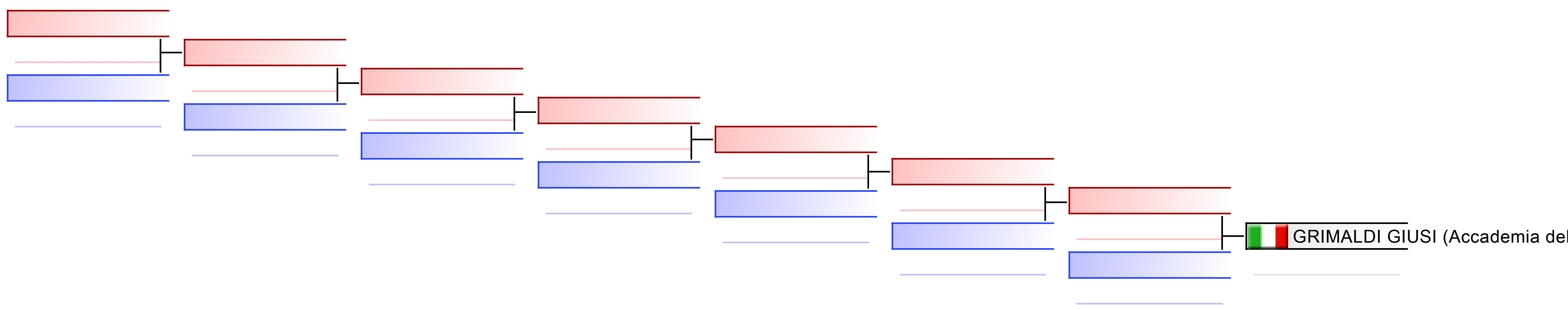

Referees:							
-----------	--	--	--	--	--	--	--

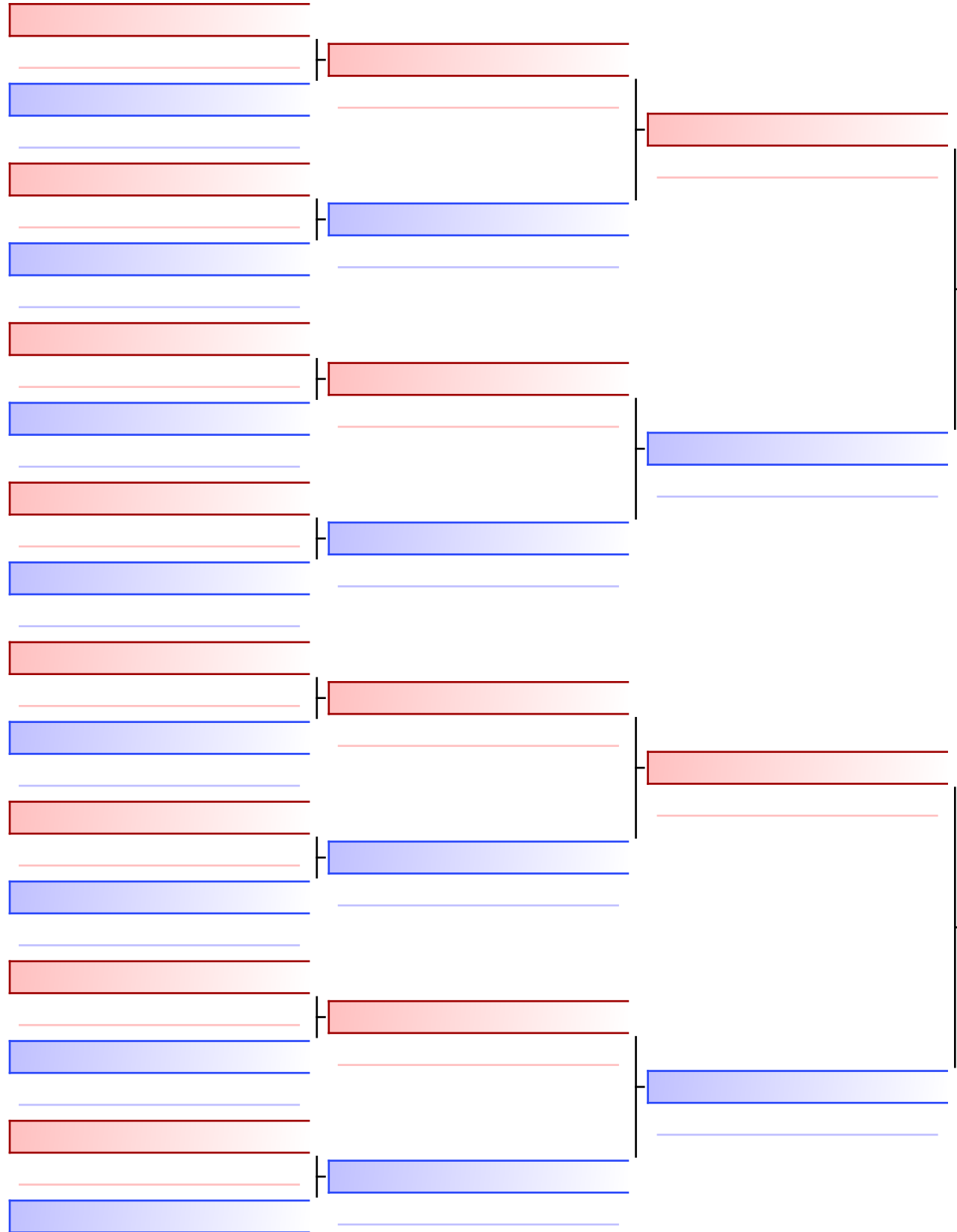

Final

TANCAU ALESSIA (TKT)

2

TANCAU ALESSIA (TKT)

TISAIANU GIULIA (Accademia dello Sport LI)

0

1. TANCAU ALESSIA (TKT)
2. TISAIANU GIULIA (ACCADEMIA DELLO SPORT)

Referees:			

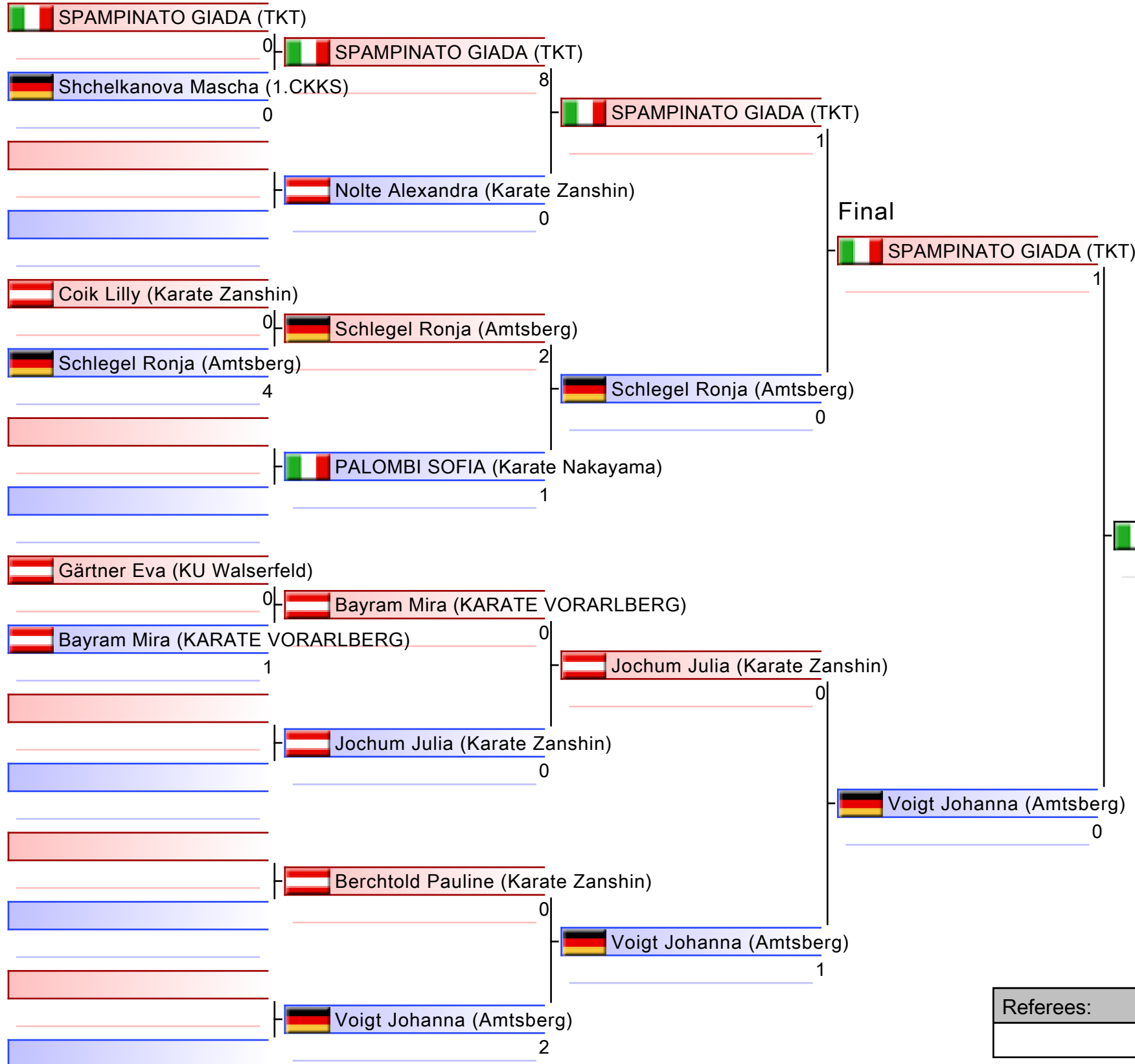

1. SPAMPINATO GIADA (TKT)
2. VOIGT JOHANNA (AMTSBERG)
3. BERCHTOLD PAULINE (KARATE ZANSHIN)
3. SCHLEGEL RONJA (AMTSBERG)
5. JOCHUM JULIA (KARATE ZANSHIN)
5. SHCHELKANOVA MASCHA (1.CKKS)
7. NOLTE ALEXANDRA (KARATE ZANSHIN)

Referees:			

# Kumite Individual female U12 +36 kg

AUSTRIAN JUNIOR OPEN 2023

2023-06-24

Tatami  
5 14:15

Pool  
1

(c)sportdata GmbH & Co KG 2000-2023 (2023-06-24 21:05) v 10.0.1 build 1 (2023-05-19 20:00 CET) License: Online\_Event\_ID-6821\_AUSTRIANJUNIOROPEN2023 (expire 2023-07-08)

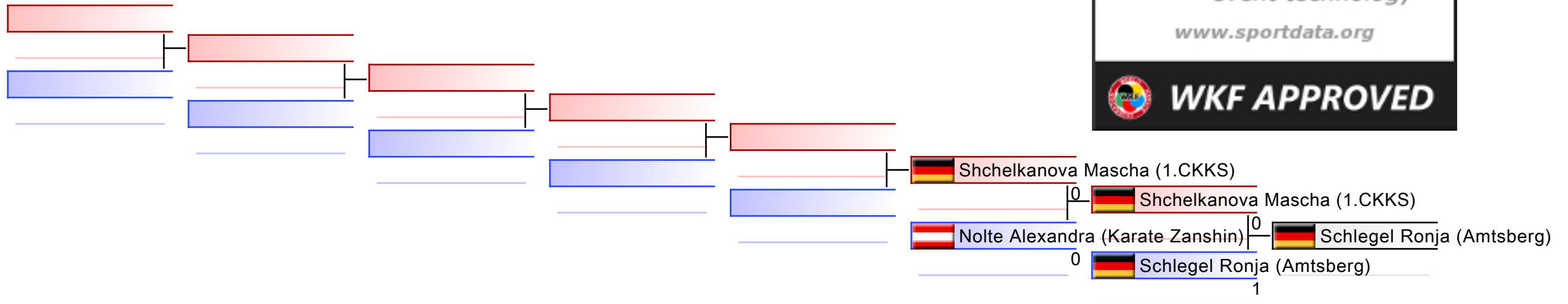

## REPECHAGE: (1)

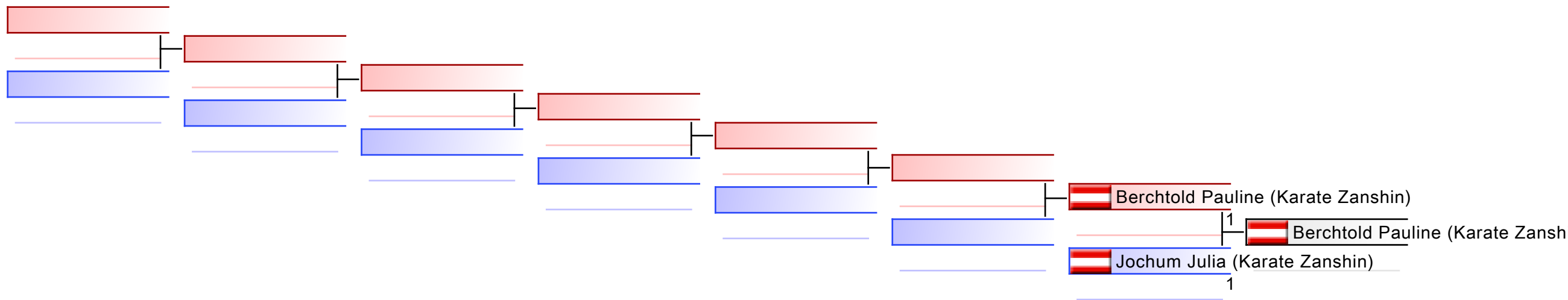

Referees:							
-----------	--	--	--	--	--	--	--



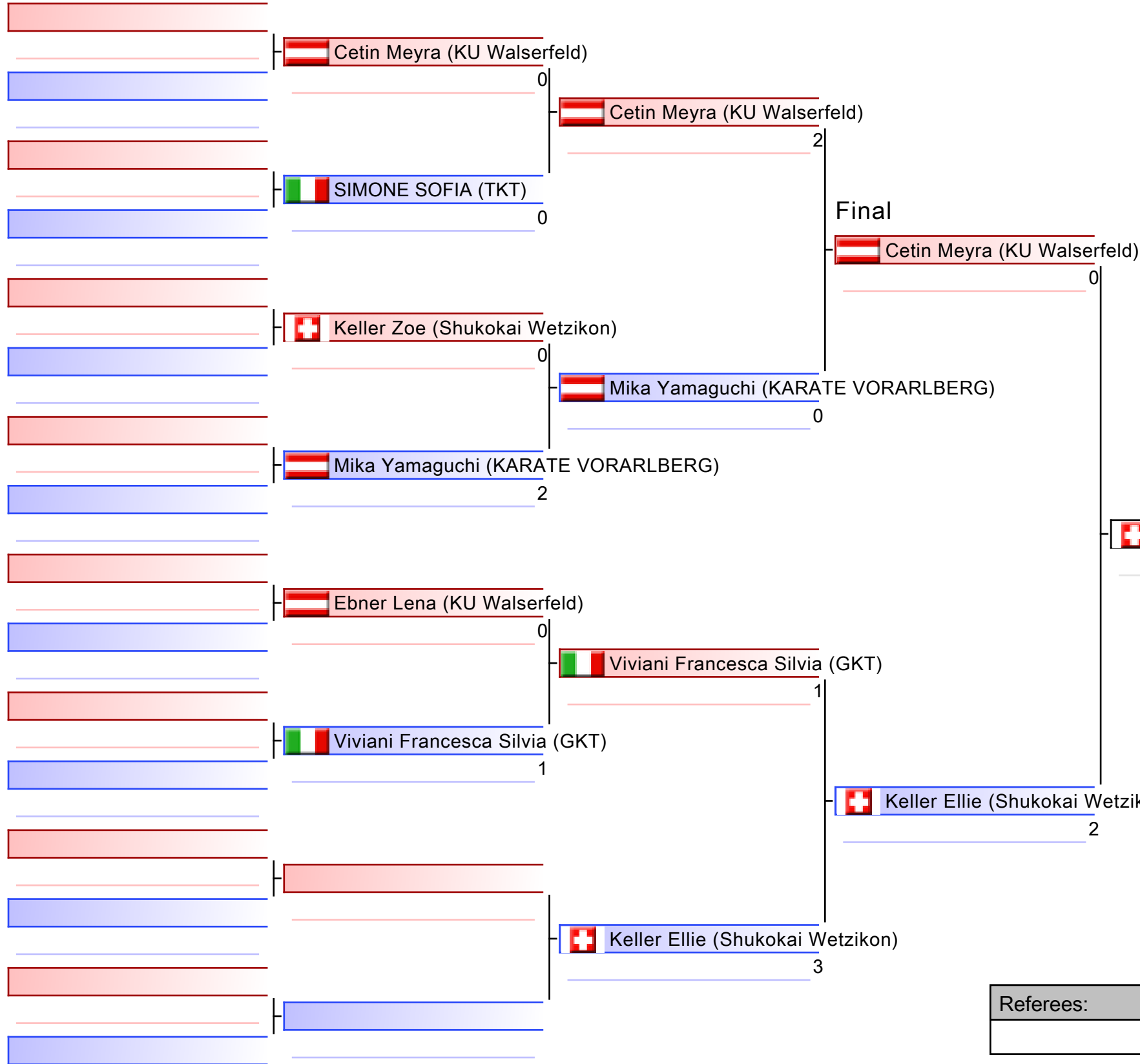

Referees:			

# Kumite Individual female U12 -30 kg

AUSTRIAN JUNIOR OPEN 2023

2023-06-24

Tatami  
5 14:55

Pool  
1

(c)sportdata GmbH & Co KG 2000-2023 (2023-06-24 21:05) v 10.0.1 build 1 (2023-05-19 20:00 CET) License: Online\_Event\_ID-6821\_AUSTRIANJUNIOROPEN2023 (expire 2023-07-08)

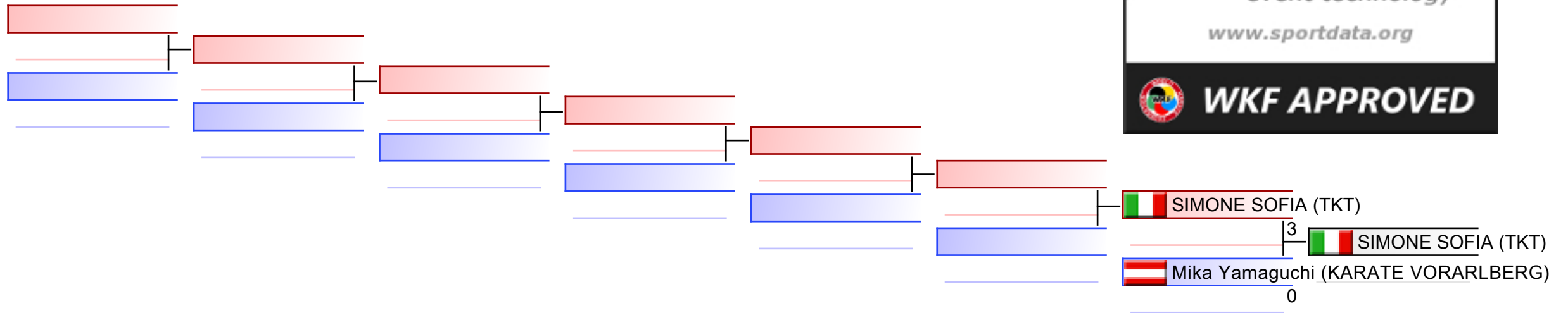

## REPECHAGE: (1)

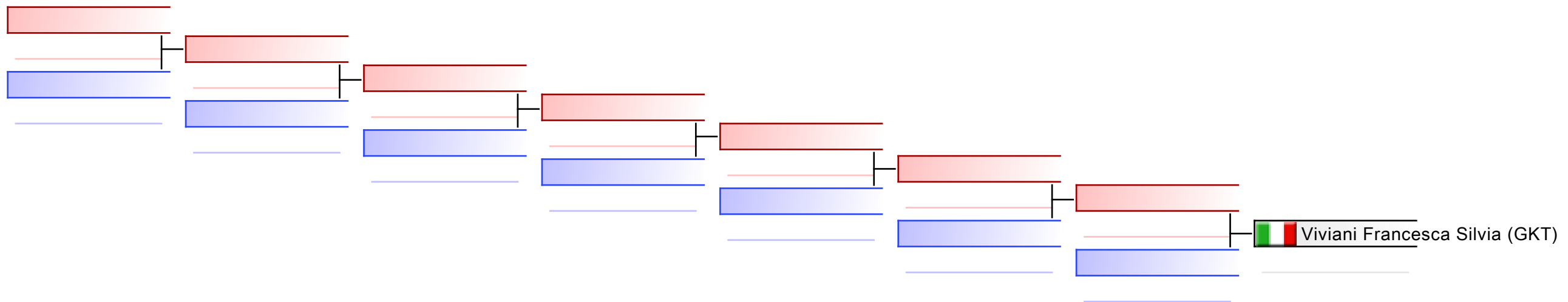

Referees:							
-----------	--	--	--	--	--	--	--

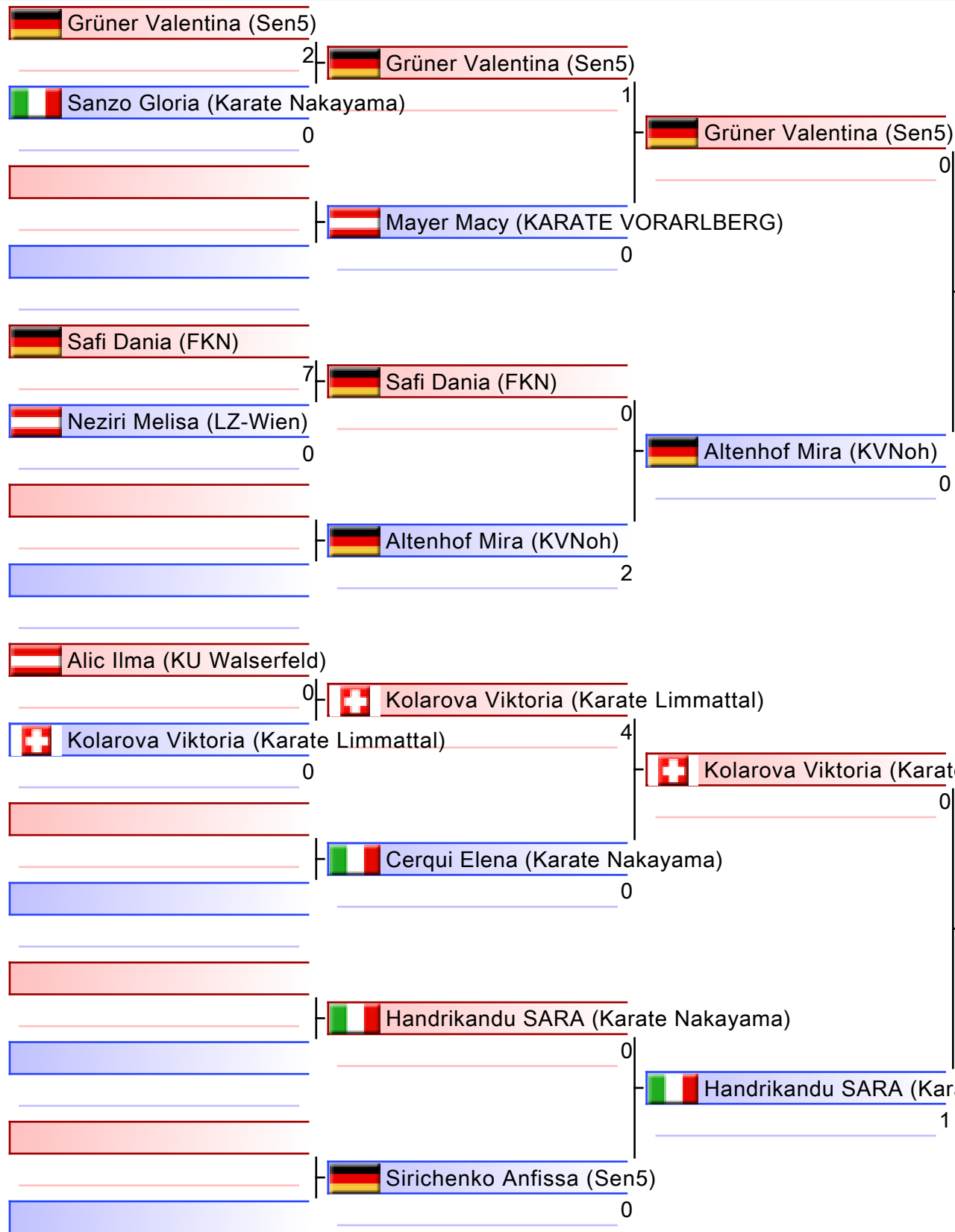

1. ALTENHOF MIRA (KVNoh)
2. HANDRIKANDU SARA (KARATE NAKAYAMA)
3. GRÜNER VALENTINA (SEN5)
3. SIRICHENKO ANFISSA (SEN5)
5. SAFI DANIA (FKN)
5. KOLAROVA VIKTORIA (KARATE LIMMATTAL)

Referees:			

# Kumite Individual female U12 -36 kg

AUSTRIAN JUNIOR OPEN 2023

2023-06-24

Tatami  
5 15:15

Pool  
1

(c)sportdata GmbH & Co KG 2000-2023 (2023-06-24 21:05) v 10.0.1 build 1 (2023-05-19 20:00 CET) License: Online\_Event\_ID-6821\_AUSTRIANJUNIOROPEN2023 (expire 2023-07-08)

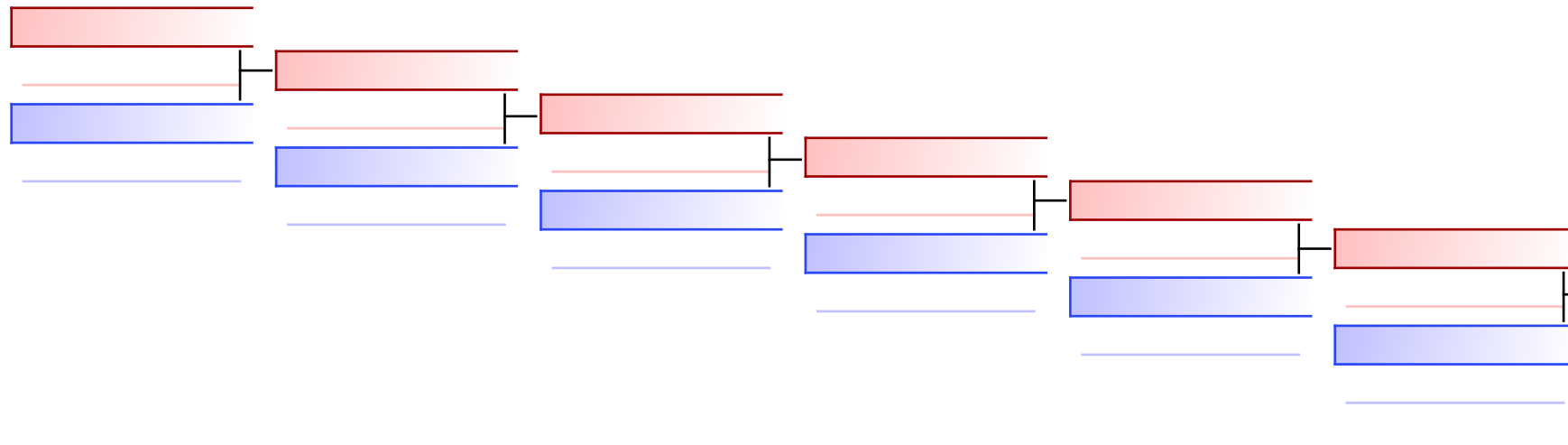

Safi Dania (FKN)  
 2  
 Grüner Valentina (Sen5)  
 3

## REPECHAGE: (1)

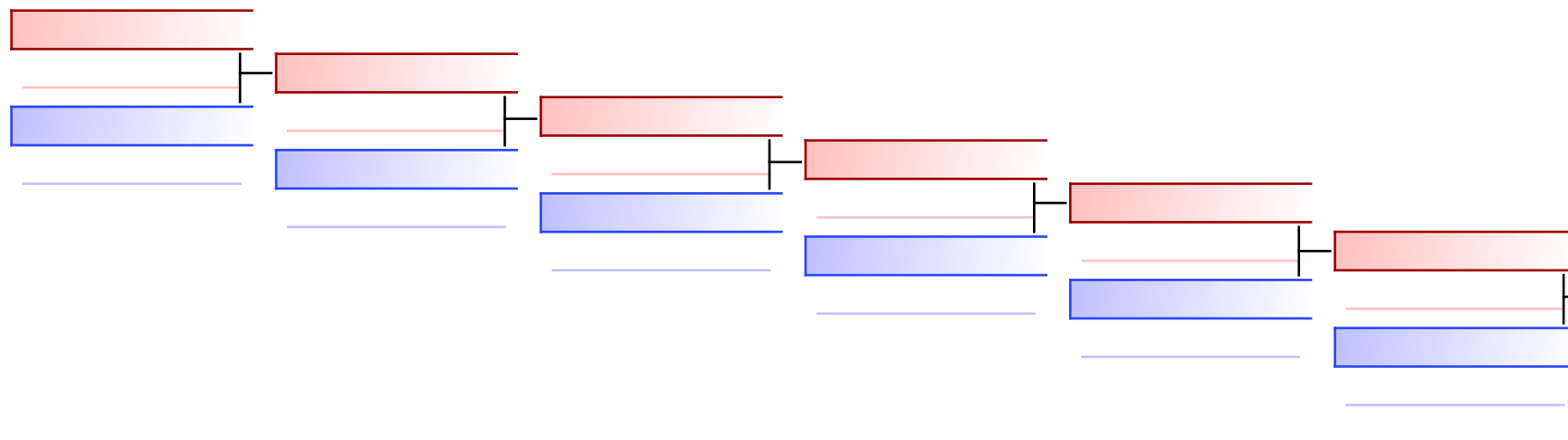

Sirichenko Anfissa (Sen5)  
 2  
 Sirichenko Anfissa (Sen5)  
 Kolarova Viktoria (Karate Limmattal)  
 0

Referees:							
-----------	--	--	--	--	--	--	--

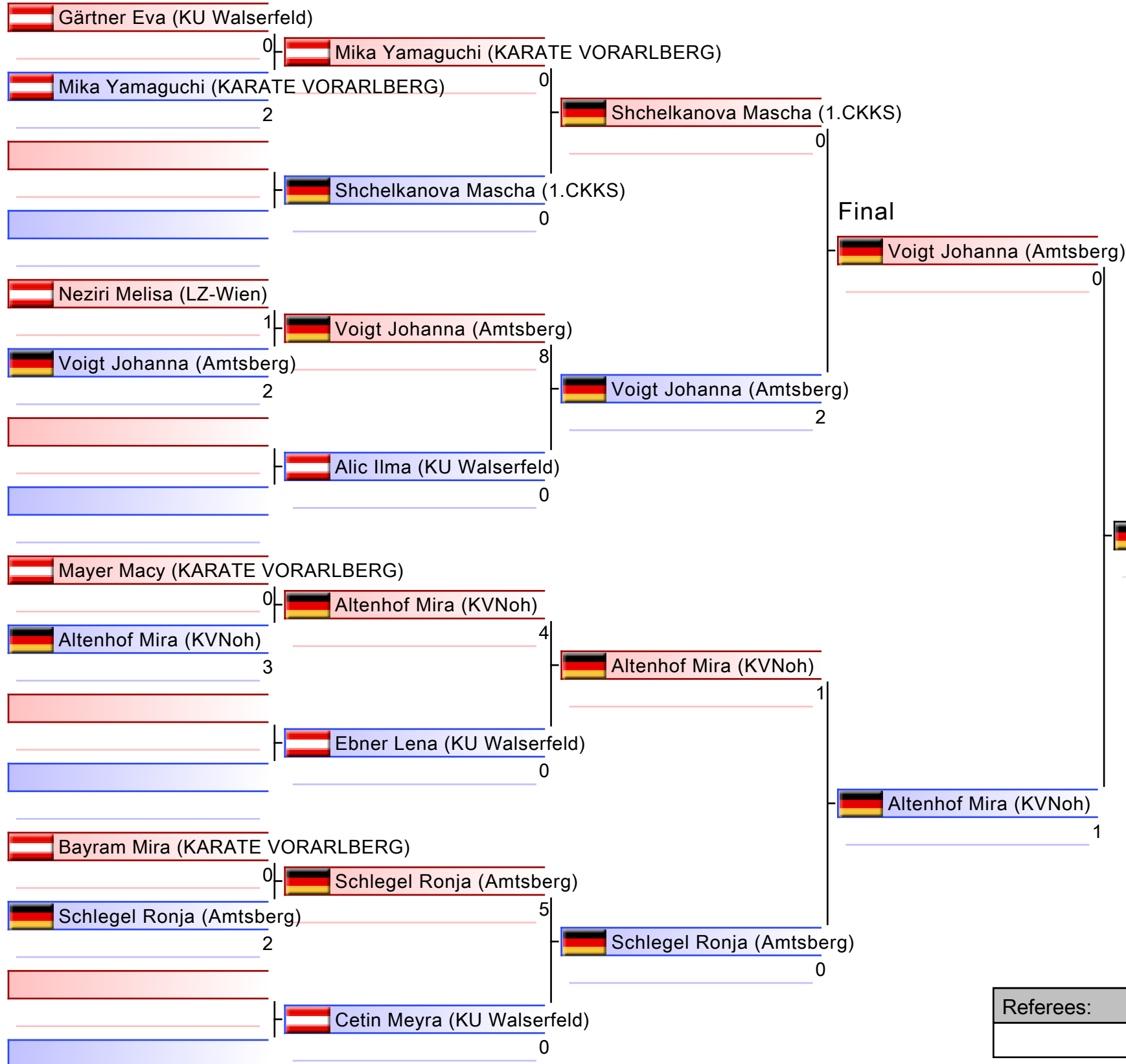

- |                                       |
|---------------------------------------|
| 1. ALTENHOF MIRA (KVNOH)              |
| 2. VOIGT JOHANNA (AMTSBERG)           |
| 3. SHCHELKANOVA MASCHA (1.CKKS)       |
| 3. SCHLEGEL RONJA (AMTSBERG)          |
| 5. EBNER LENA (KU WALSERFELD)         |
| 5. ALIC ILMA (KU WALSERFELD)          |
| 5. MIKA YAMAGUCHI (KARATE VORARLBERG) |
| 5. CETIN MEYRA (KU WALSERFELD)        |

Referees:			

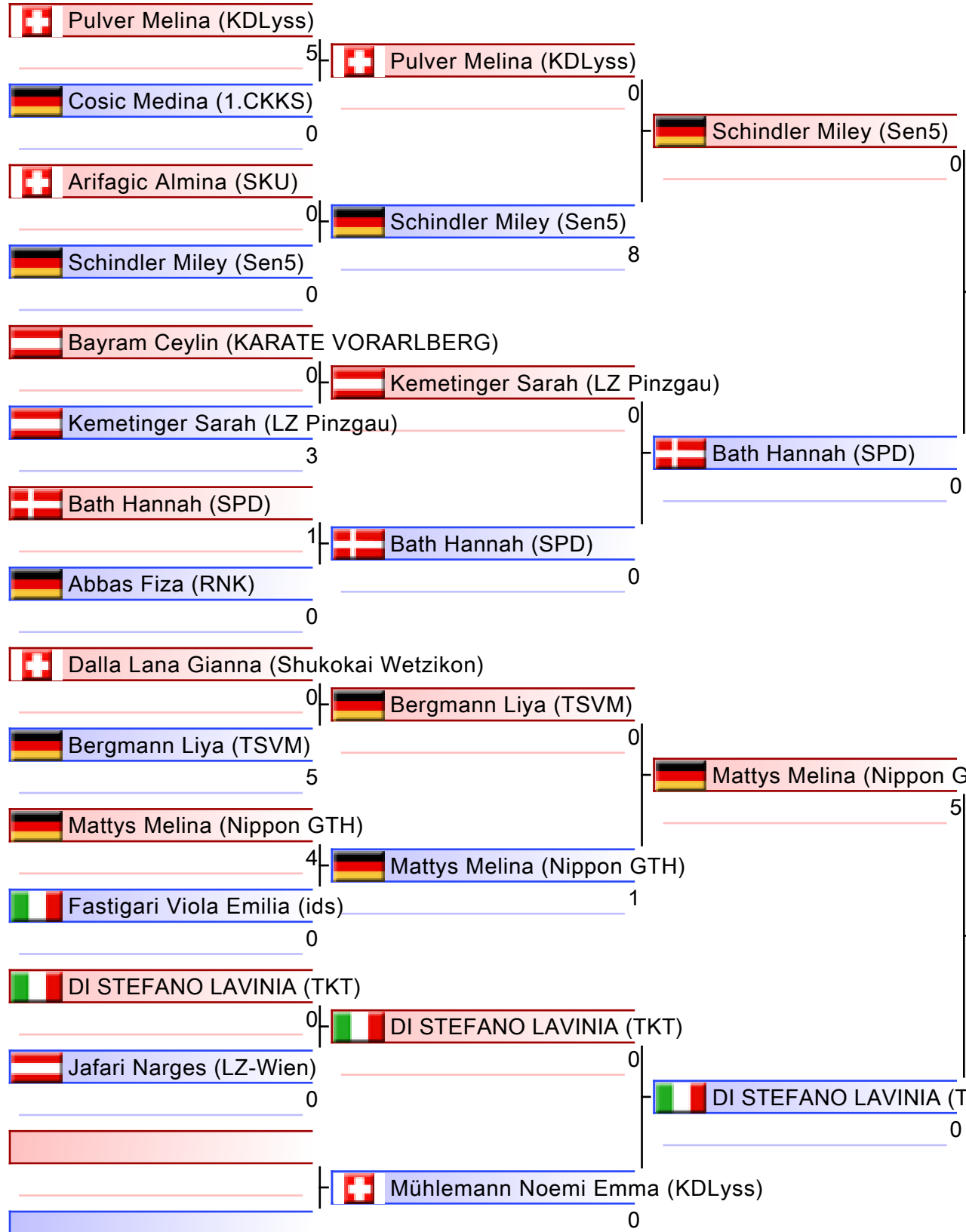

1. MATTYS MELINA (NIPPON GTH)
2. BATH HANNAH (SPD)
3. SCHINDLER MILEY (SEN5)
3. FASTIGARI VIOLA EMILIA (IDS)
5. KEMETINGER SARAH (LZ PINZGAU)
5. DI STEFANO LAVINIA (TKT)
7. ABBAS FIZA (RNK)
7. BERGMANN LIYA (TSVM)

Referees:			

# Kumite Individual female U14 +52kg

AUSTRIAN JUNIOR OPEN 2023

2023-06-24

Tatami  
3 15:10

Pool  
1

(c)sportdata GmbH & Co KG 2000-2023 (2023-06-24 21:05) v 10.0.1 build 1 (2023-05-19 20:00 CET) License: Online\_Event\_ID-6821\_AUSTRIANJUNIOROPEN2023 (expire 2023-07-08)

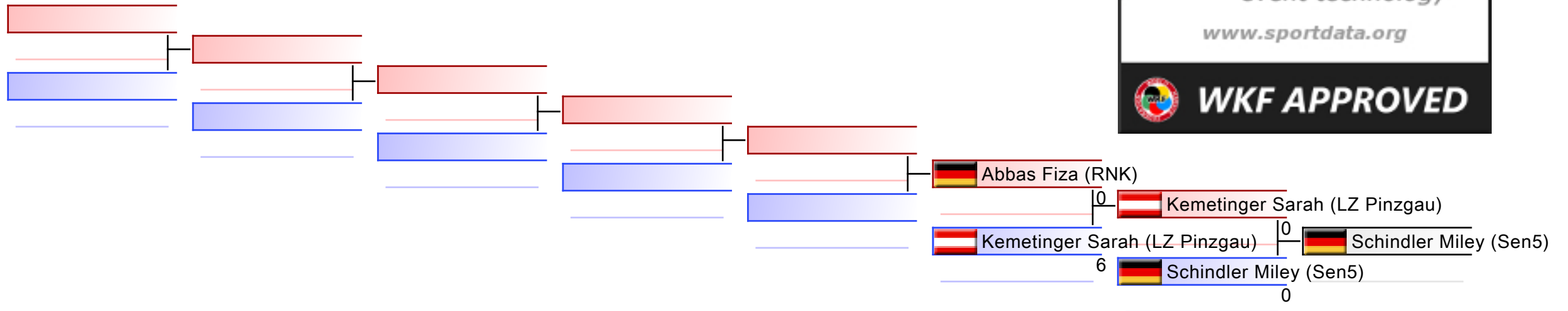

## REPECHAGE: (1)

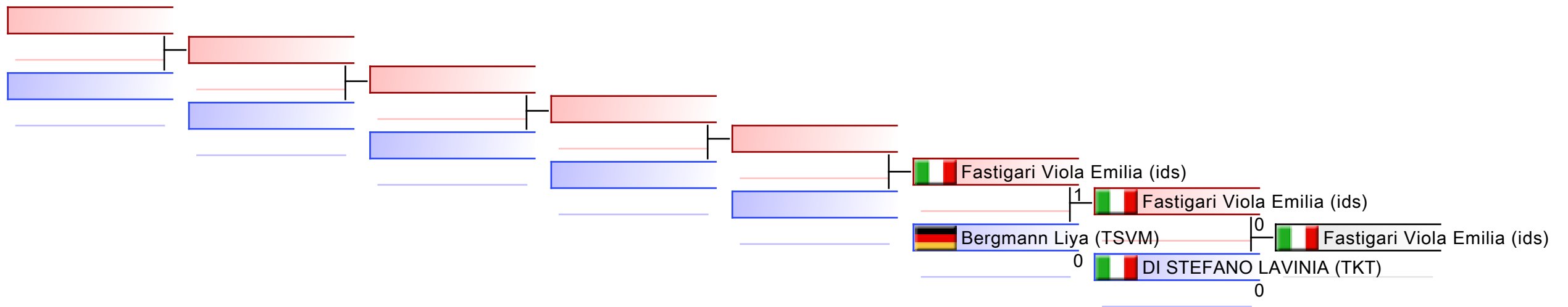

Referees:							
-----------	--	--	--	--	--	--	--

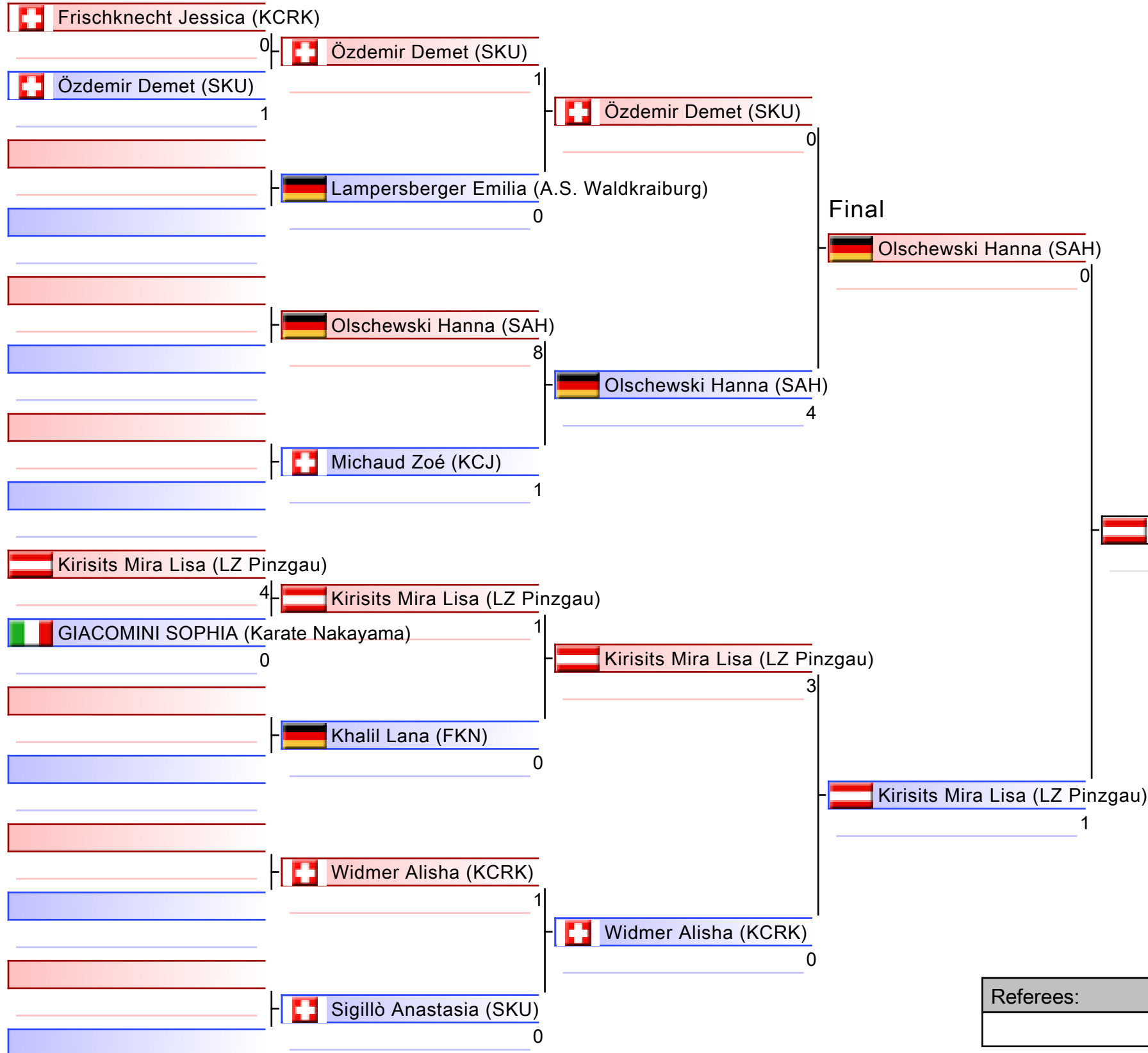

1. KIRISITS MIRA LISA (LZ PINZGAU)
2. OLSCHESKI HANNA (SAH)
3. ÖZDEMİR DEMET (SKU)
3. KHALIL LANA (FKN)
5. MICHAUD ZOÉ (KCJ)
5. WIDMER ALISHA (KCRK)
7. GIACOMINI SOPHIA (KARATE NAKAYAMA)

Referees:			



# Kumite Individual female U14 -42 kg

AUSTRIAN JUNIOR OPEN 2023

2023-06-24

Tatami  
2 17:55

Pool  
1

(c)sportdata GmbH & Co KG 2000-2023 (2023-06-24 21:05) v 10.0.1 build 1 (2023-05-19 20:00 CET) License: Online\_Event\_ID-6821\_AUSTRIANJUNIOROPEN2023 (expire 2023-07-08)

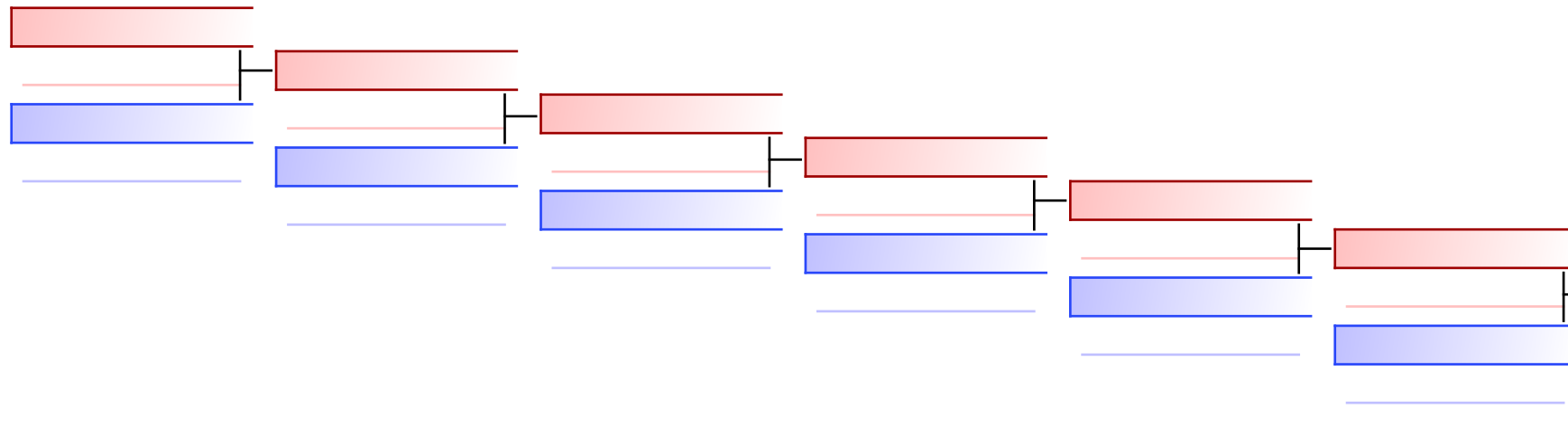

Michaud Zoé (KCJ) 0  
 Özdemir Demet (SKU) 8

## REPECHAGE: (1)

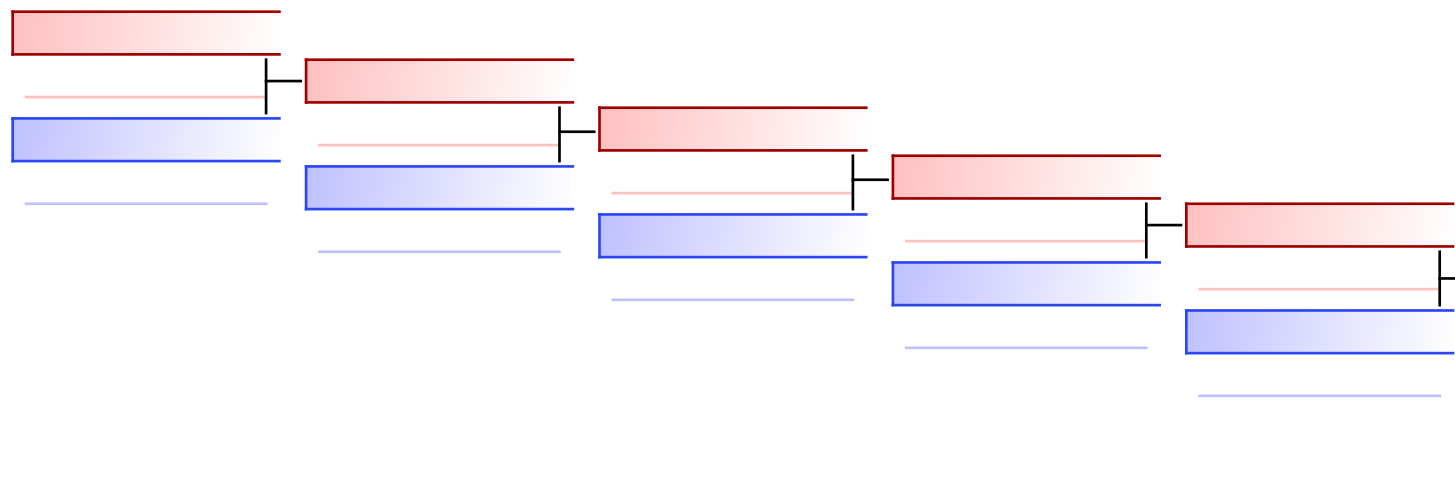

GIACOMINI SOPHIA (Karate Nakayama) 1  
 Khalil Lana (FKN) 6  
 Khalil Lana (FKN) 11  
 Widmer Alisha (KCRK) 0

Referees:							
-----------	--	--	--	--	--	--	--

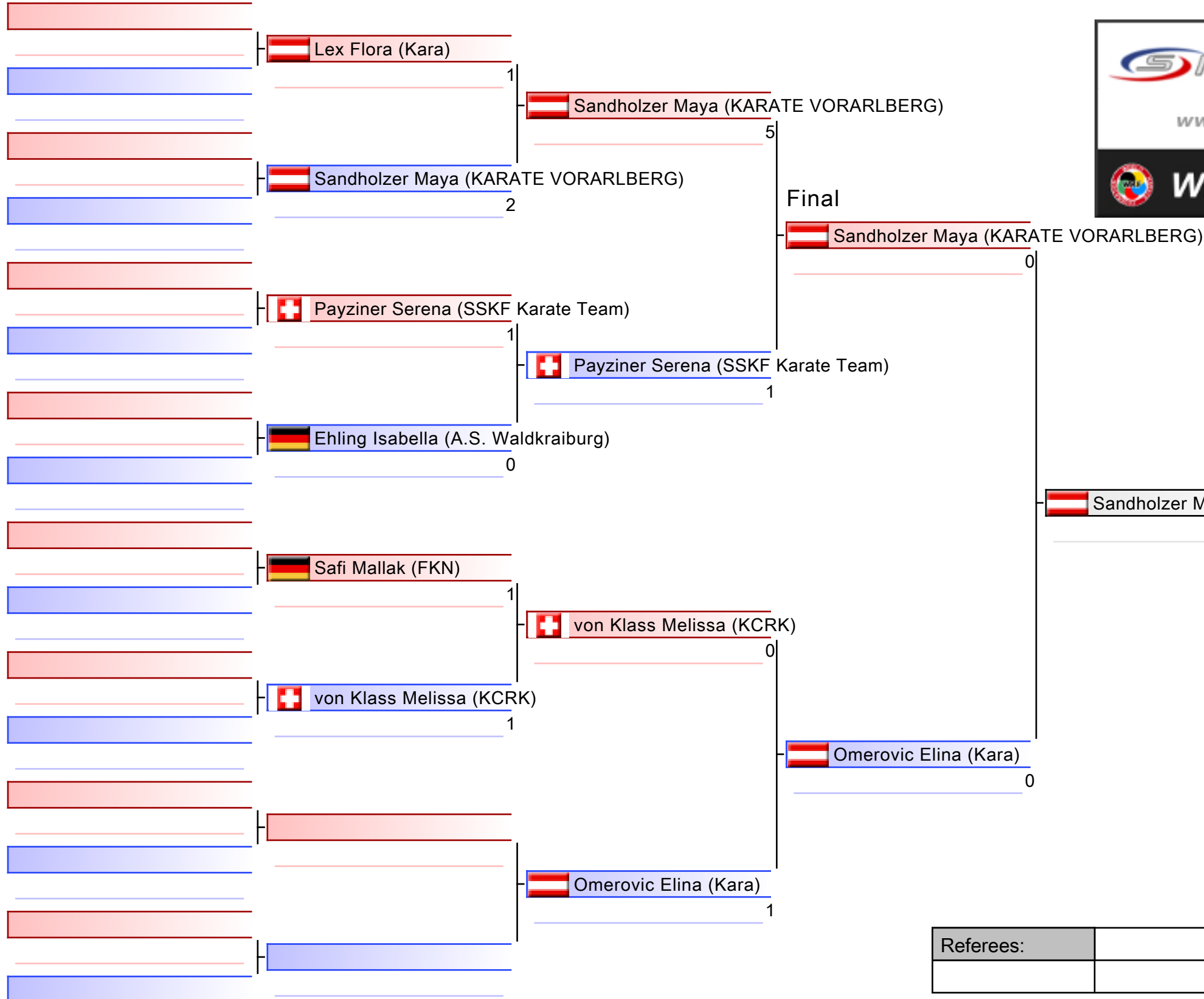

1. SANDHOLZER MAYA (KARATE VORARLBERG)
2. OMEROVIC ELINA (KARA)
3. VON KLASS MELISSA (KCRK)
3. LEX FLORA (KARA)
5. PAYZINER SERENA (SSKF KARATE TEAM)

Referees:			

Kumite Individual female U14 -47 kg

AUSTRIAN JUNIOR OPEN 2023

2023-06-24

Tatami  
3 17:05

Pool  
1

(c)sportdata GmbH & Co KG 2000-2023 (2023-06-24 21:05) v 10.0.1 build 1 (2023-05-19 20:00 CET) License: Online\_Event\_ID-6821\_AUSTRIANJUNIOROPEN2023 (expire 2023-07-08)

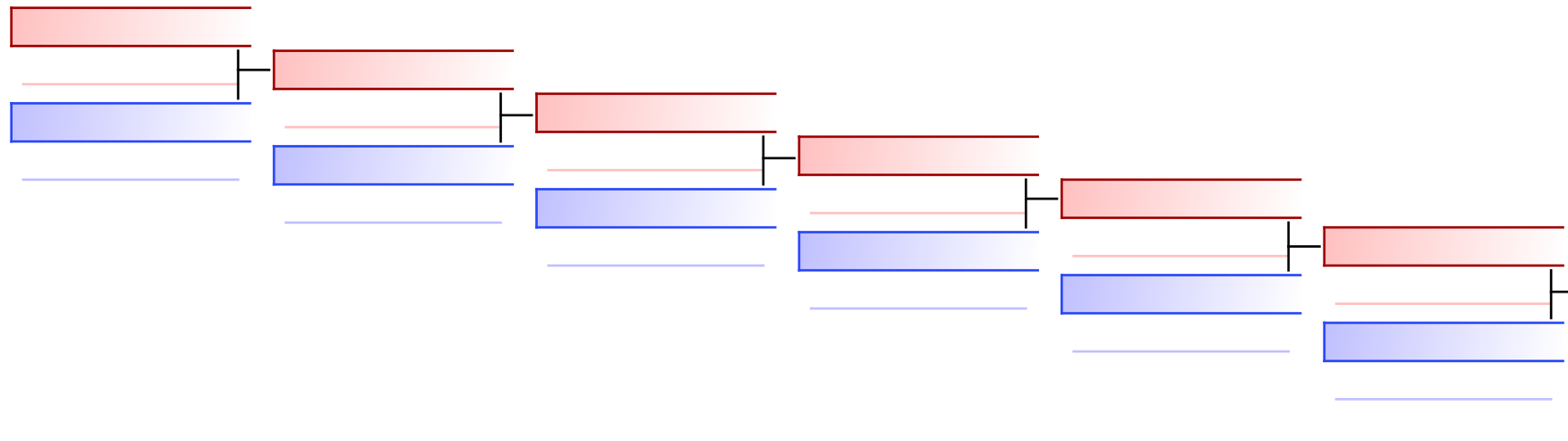

Lex Flora (Kara)  
0  
 Lex Flora (Kara)  
 Payziner Serena (SSKF Karate Team)  
0

REPECHAGE: (1)

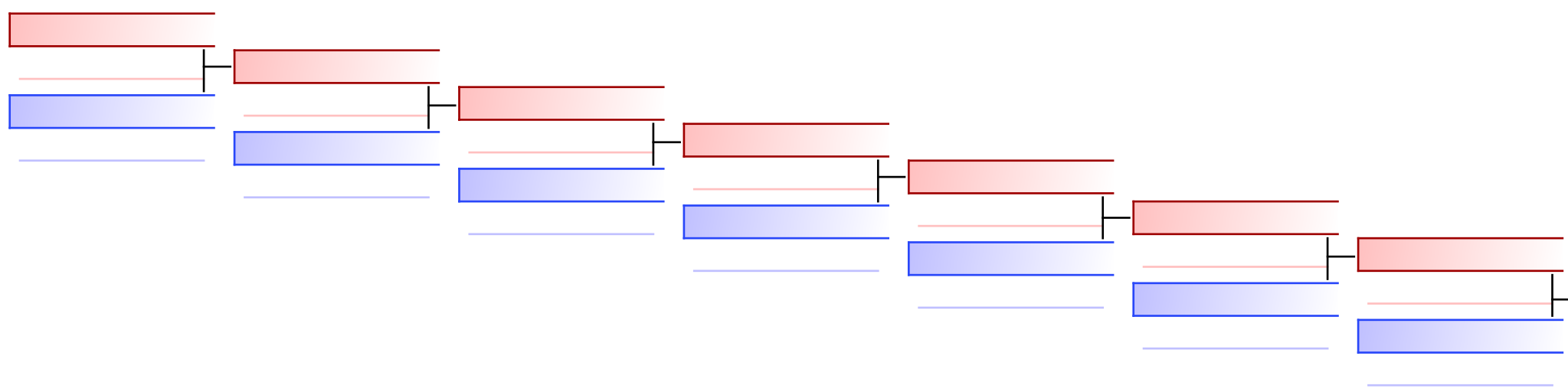

von Klass Melissa (KCRK)

Referees:							
-----------	--	--	--	--	--	--	--

# Kumite Individual female U14 -52

AUSTRIAN JUNIOR OPEN 2023, Schulstrasse 17, 5071 Wals, AUT

2023-06-24

Tatami  
3 17:35

Pool  
1/1

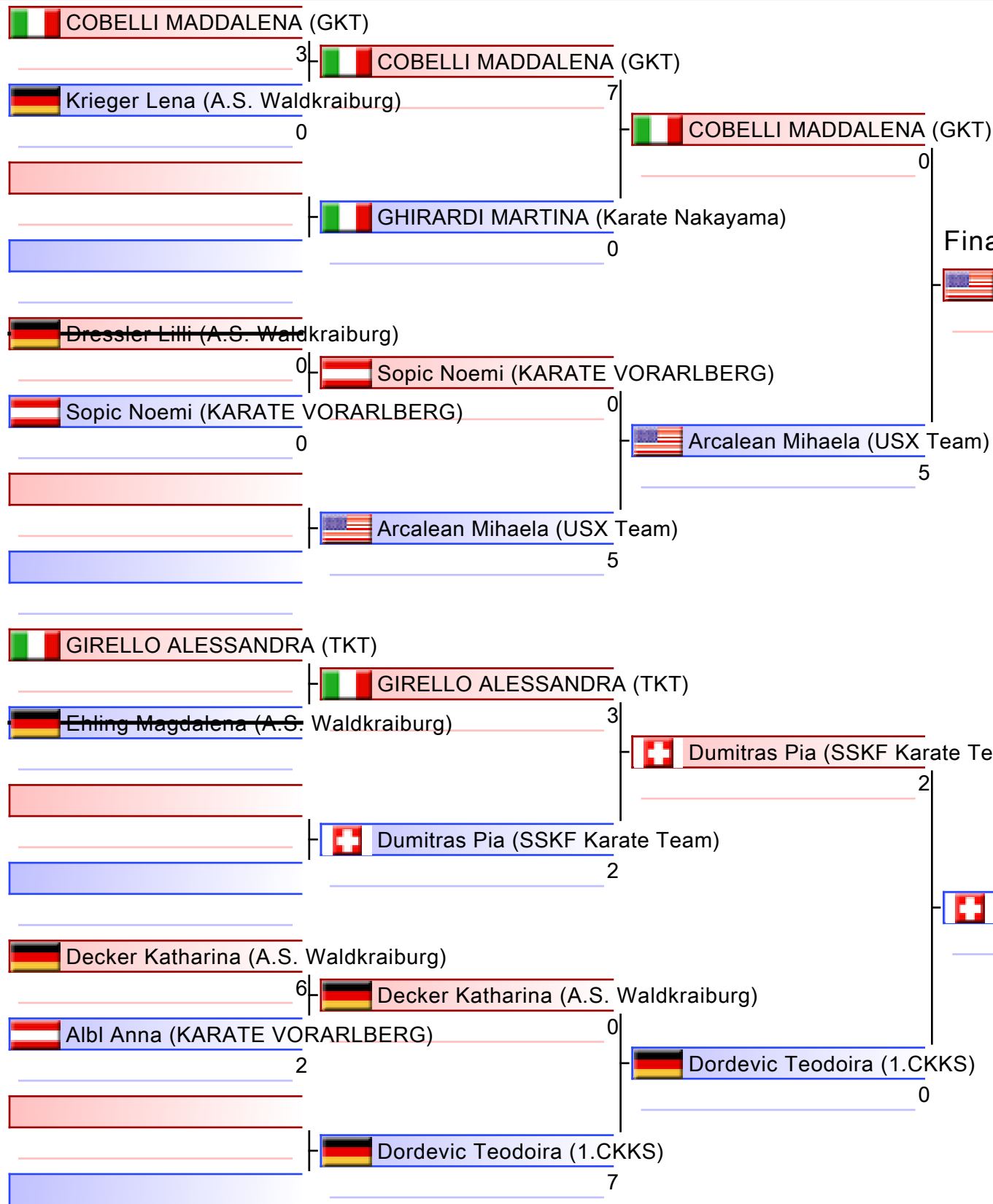

1. ARCALEAN MIHAELA (USX TEAM)
2. DUMITRAS PIA (SSKF KARATE TEAM)
3. COBELLI MADDALENA (GKT)
3. GIRELLO ALESSANDRA (TKT)
5. SOPIC NOEMI (KARATE VORARLBERG)
5. DORDEVIC TEODOIRA (1.CKKS)

Referees:			

# Kumite Individual female U14 -52

AUSTRIAN JUNIOR OPEN 2023

2023-06-24

Tatami  
3 17:35

Pool  
1

(c)sportdata GmbH & Co KG 2000-2023 (2023-06-24 21:05) v 10.0.1 build 1 (2023-05-19 20:00 CET) License: Online\_Event\_ID-6821\_AUSTRIANJUNIOROPEN2023 (expire 2023-07-08)

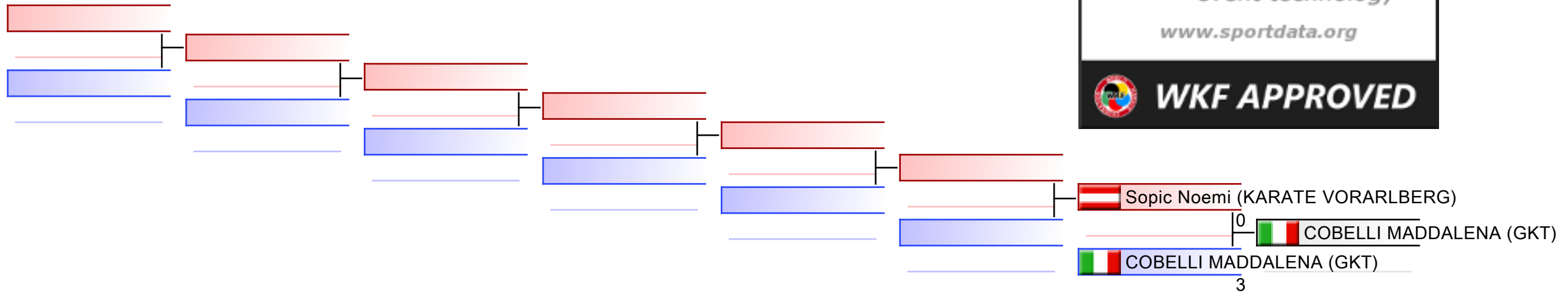

## REPECHAGE: (1)

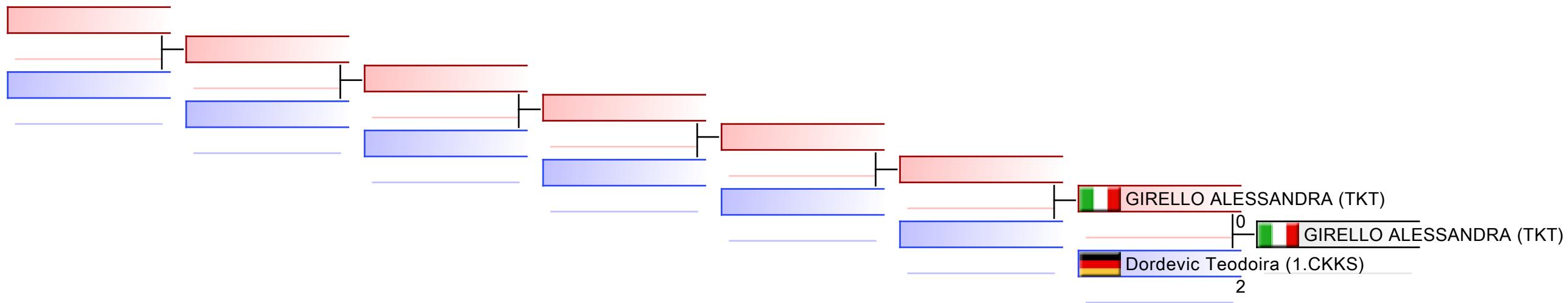

Referees:							
-----------	--	--	--	--	--	--	--

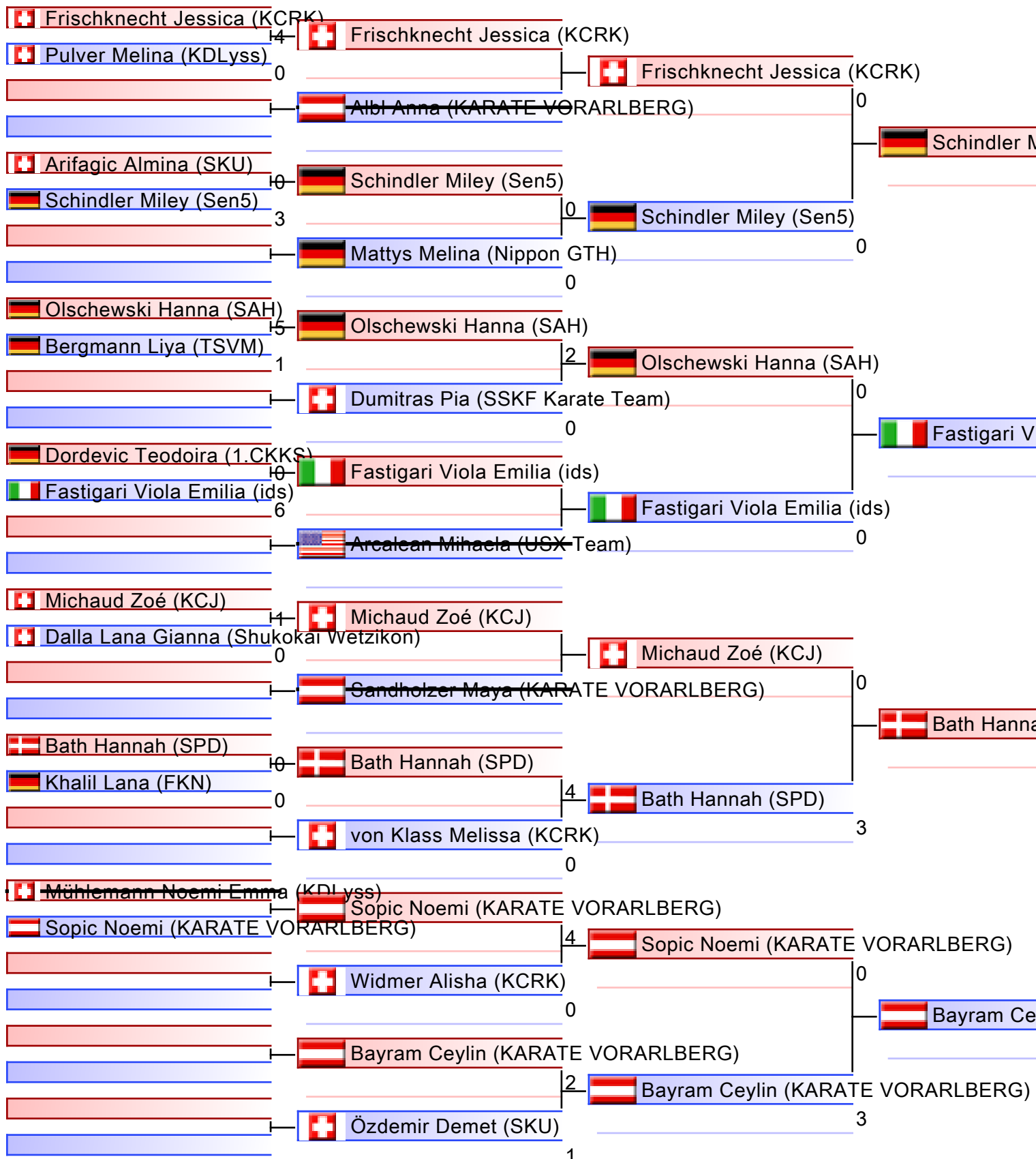

Final

- |                                      |
|--------------------------------------|
| 1. FASTIGARI VIOLA EMILIA (IDS)      |
| 2. BATH HANNAH (SPD)                 |
| 3. SCHINDLER MILEY (SEN5)            |
| 3. BAYRAM CEYLIN (KARATE VORARLBERG) |
| 5. OLSCHEWSKI HANNA (SAH)            |
| 5. MICHAUD ZOÉ (KCJ)                 |
| 5. FRISCHKNECHT JESSICA (KCRK)       |
| 5. SOPIC NOEMI (KARATE VORARLBERG)   |

Referees:			

# Kumite Individual female U16 Open

AUSTRIAN JUNIOR OPEN 2023, Schulstrasse 17, 5071 Wals, AUT

2023-06-24

Tatami  
6 19:15

Pool  
1/1

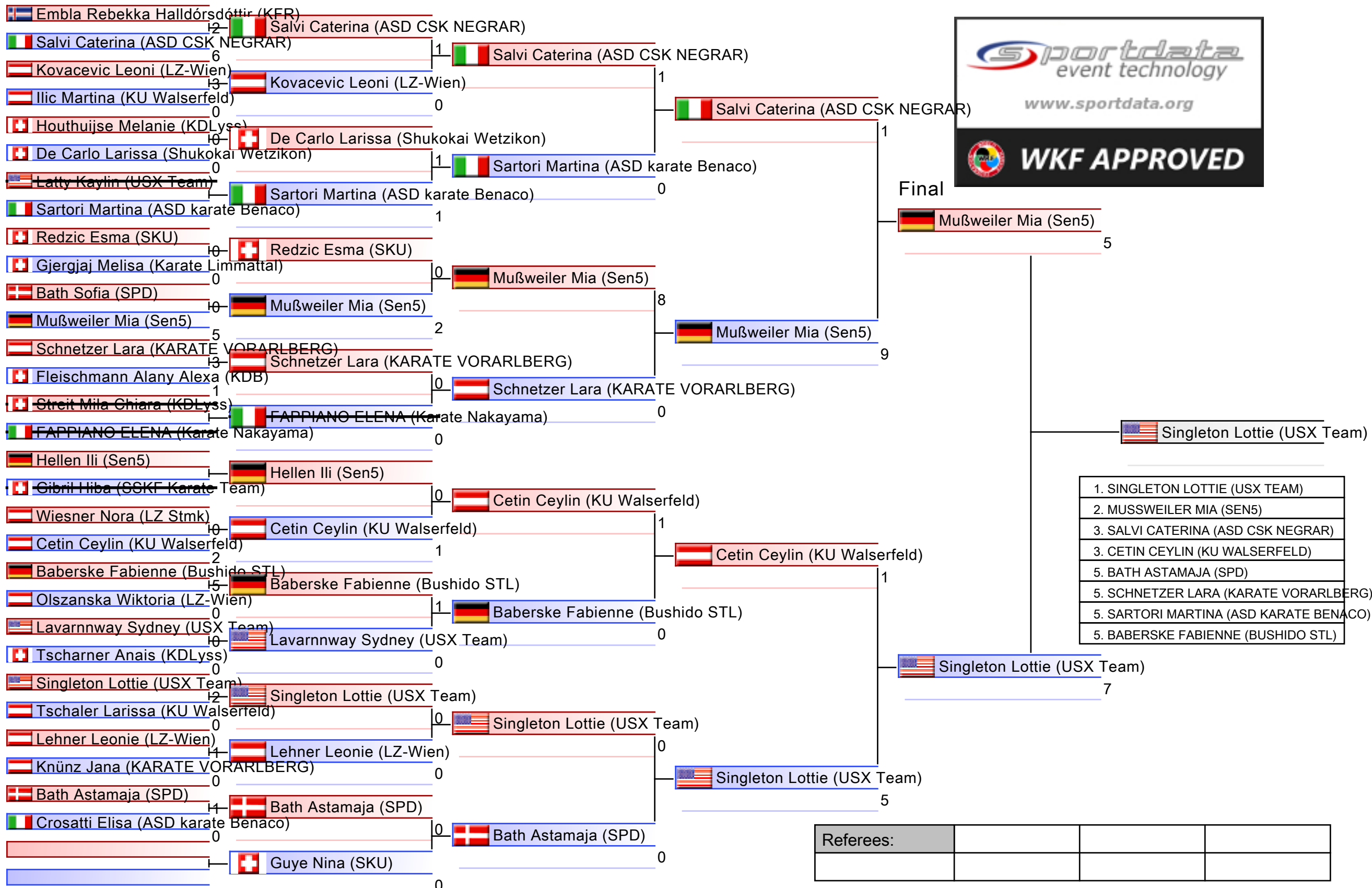

1. SINGLETON LOTTIE (USX TEAM)
2. MUSSWEILER MIA (SEN5)
3. SALVI CATERINA (ASD CSK NEGRAR)
3. CETIN CEYLIN (KU WALSERFELD)
5. BATH ASTAMAJA (SPD)
5. SCHNETZER LARA (KARATE VORARLBERG)
5. SARTORI MARTINA (ASD KARATE BENACO)
5. BABERSKE FABIENNE (BUSHIDO STL)

Referees:			

# Kumite Individual female U18 Open

AUSTRIAN JUNIOR OPEN 2023, Schulstrasse 17, 5071 Wals, AUT

2023-06-24

Tatami  
5 19:05

Pool  
1/1

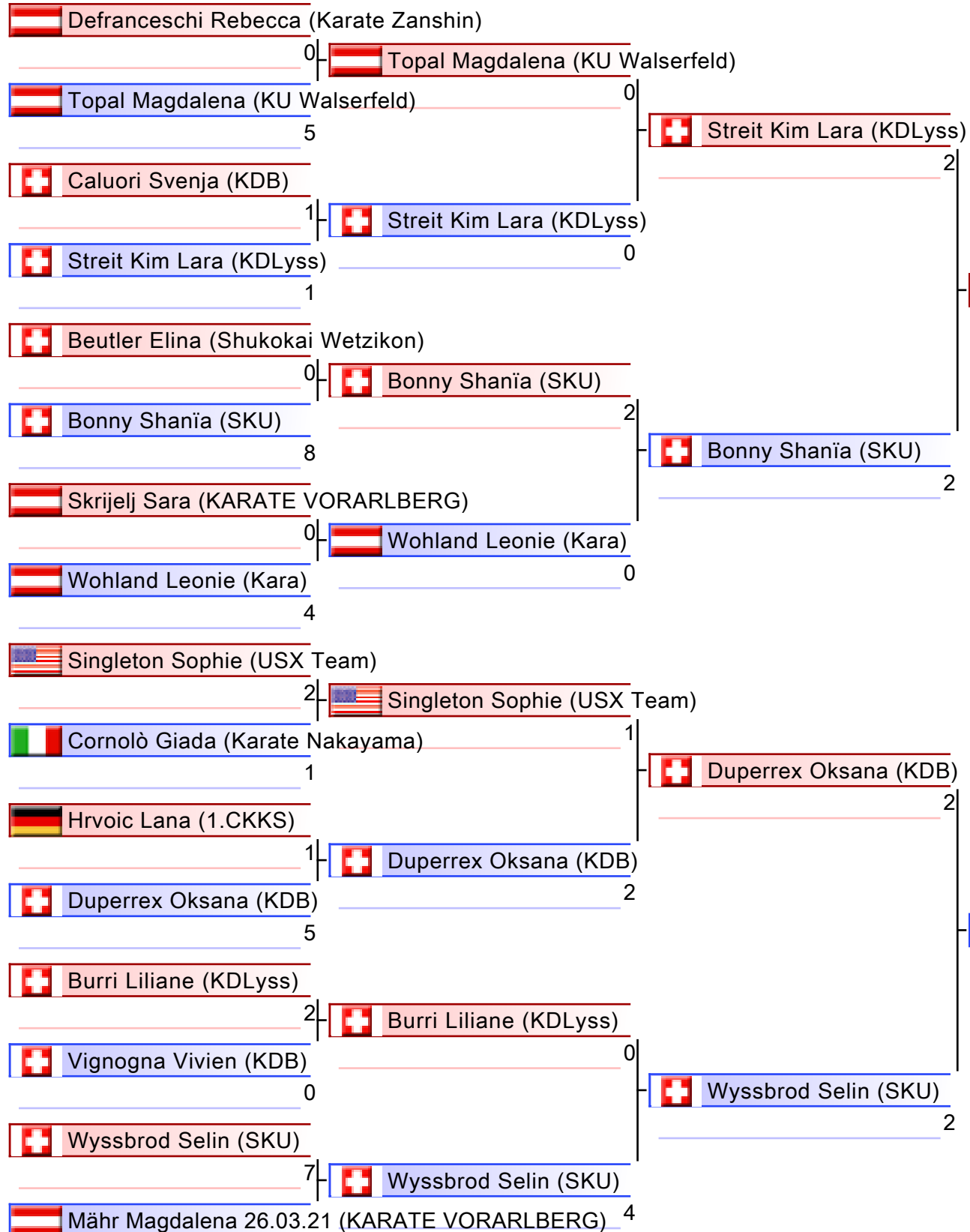

1. DUPERREX OKSANA (KDB)
2. BONNY SHANIIA (SKU)
3. STREIT KIM LARA (KDLYSS)
3. WYSSBROD SELIN (SKU)
5. SINGLETON SOPHIE (USX TEAM)
5. WOHLAND LEONIE (KARA)
5. TOPAL MAGDALENA (KU WALSERFELD)
5. BURRI LILIANE (KDLYSS)

Referees:			



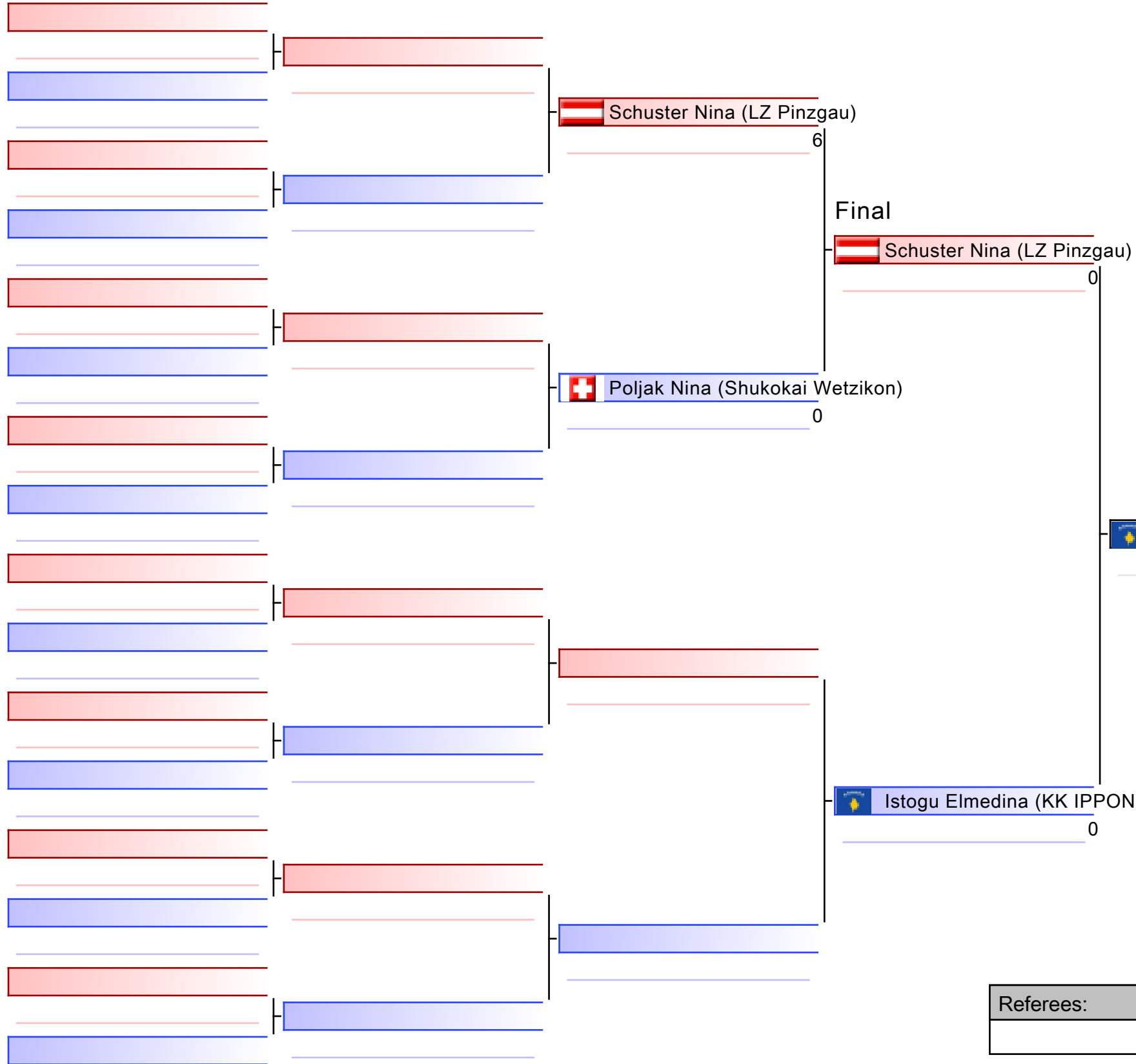

1. ISTOGU ELMEDINA (KK IPPON-PRISHTINE)
2. SCHUSTER NINA (LZ PINZGAU)
3. POLJAK NINA (SHUKOKAI WETZIKON)

Referees:			

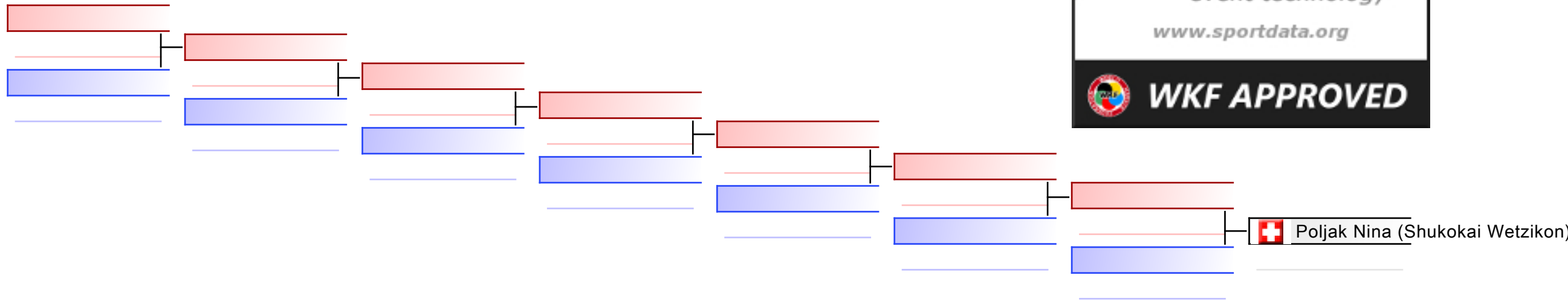

REPECHAGE: (1)

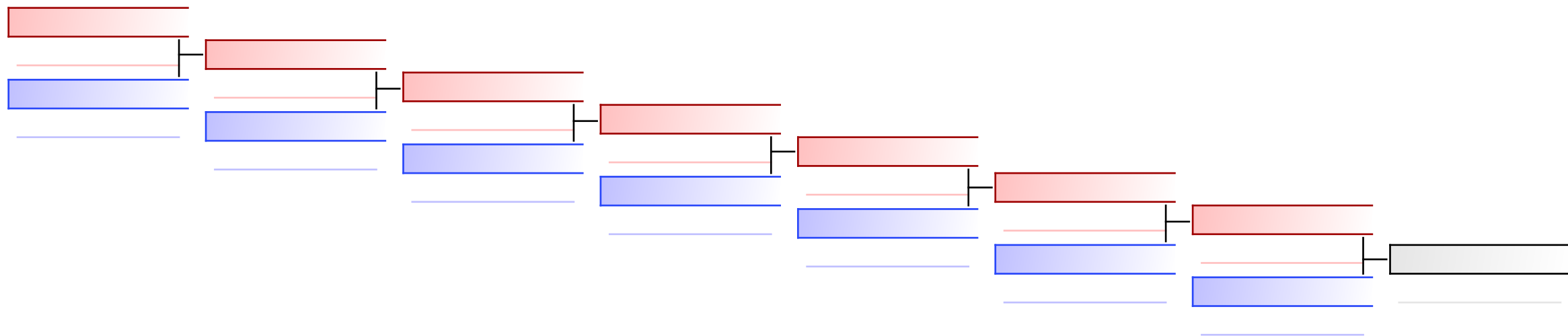

Referees:							
-----------	--	--	--	--	--	--	--

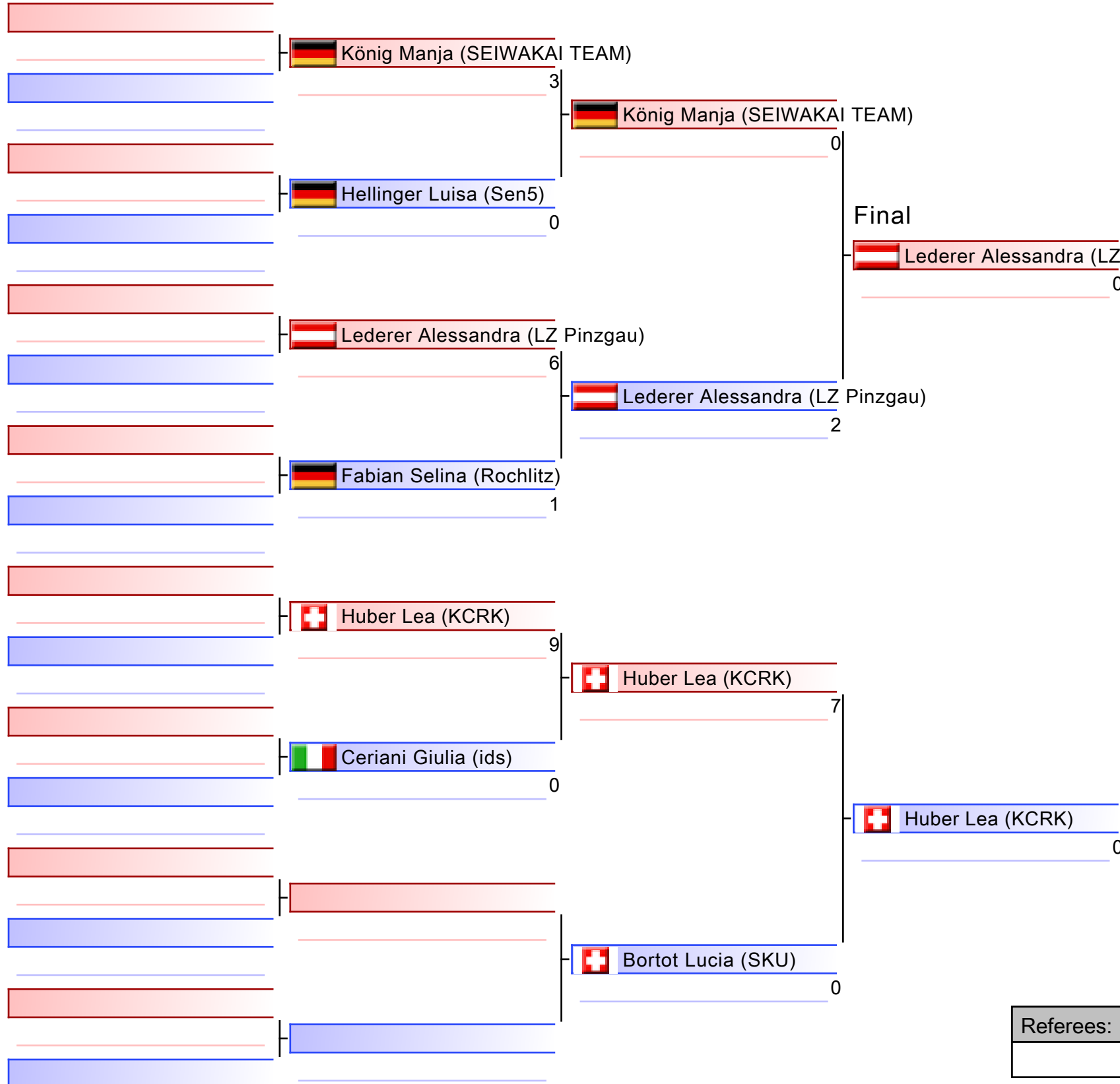

Huber Lea (KCRK)

1. HUBER LEA (KCRK)
2. LEDERER ALESSANDRA (LZ PINZGAU)
3. FABIAN SELINA (ROCHLITZ)
3. BORTOT LUCIA (SKU)
5. KÖNIG MANJA (SEIWAKAI TEAM)
5. CERIANI GIULIA (IDS)

Referees:			

# Kumite Individual female U21 -50 -55

AUSTRIAN JUNIOR OPEN 2023

2023-06-24

Tatami  
2 19:05

Pool  
1

(c)sportdata GmbH & Co KG 2000-2023 (2023-06-24 21:05) v 10.0.1 build 1 (2023-05-19 20:00 CET) License: Online\_Event\_ID-6821\_AUSTRIANJUNIOROPEN2023 (expire 2023-07-08)

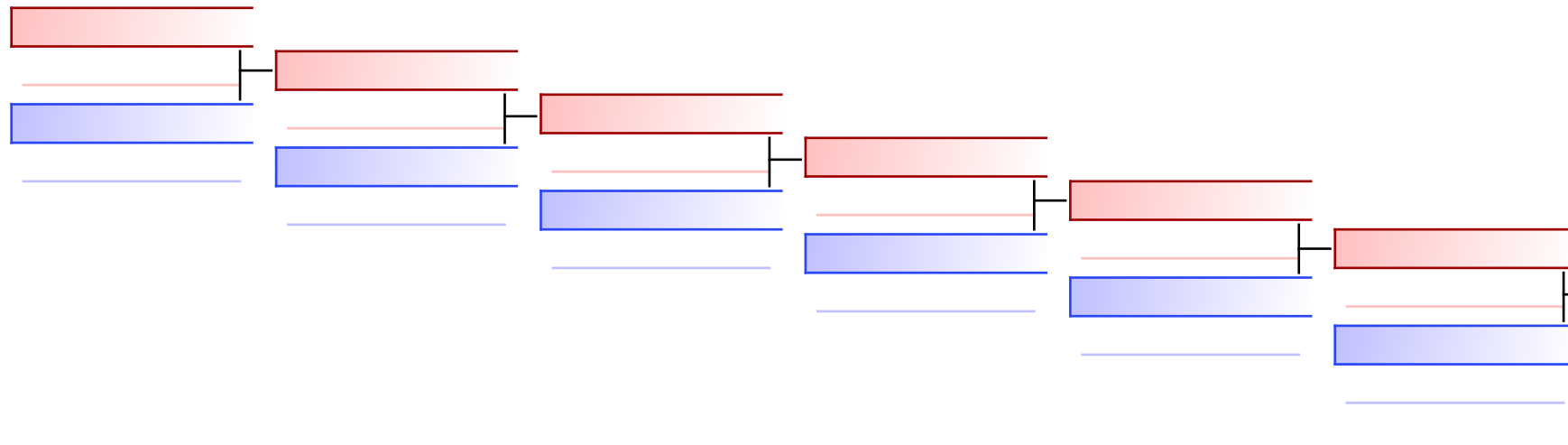

Fabian Selina (Rochlitz) 5  
 König Manja (SEIWAKAI TEAM) 0

## REPECHAGE: (1)

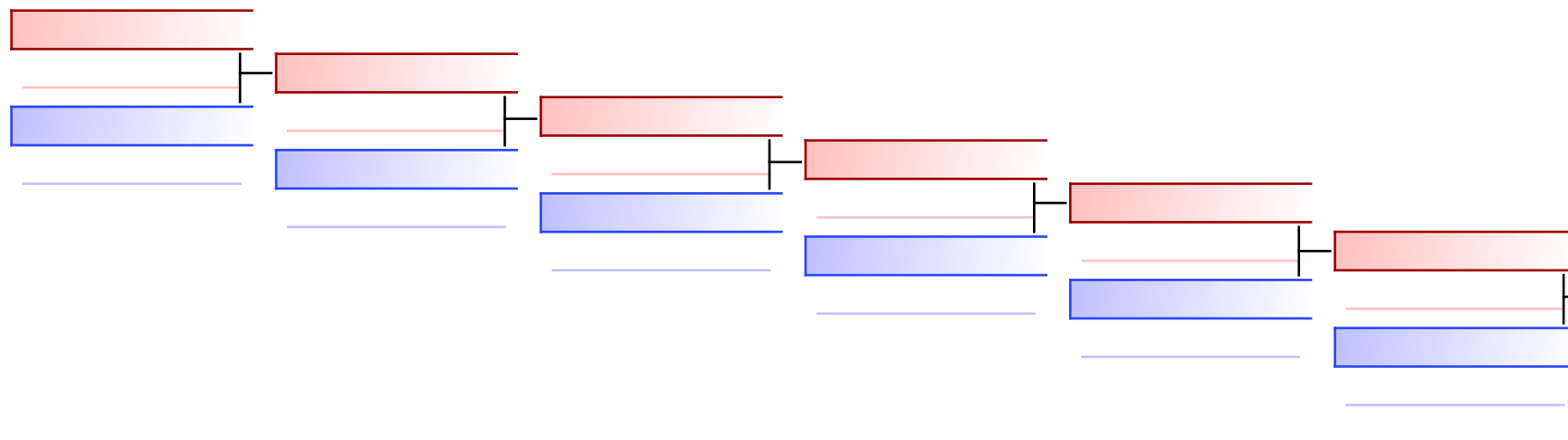

Ceriani Giulia (ids) 2  
 Bortot Lucia (SKU) 4

Referees:							
-----------	--	--	--	--	--	--	--

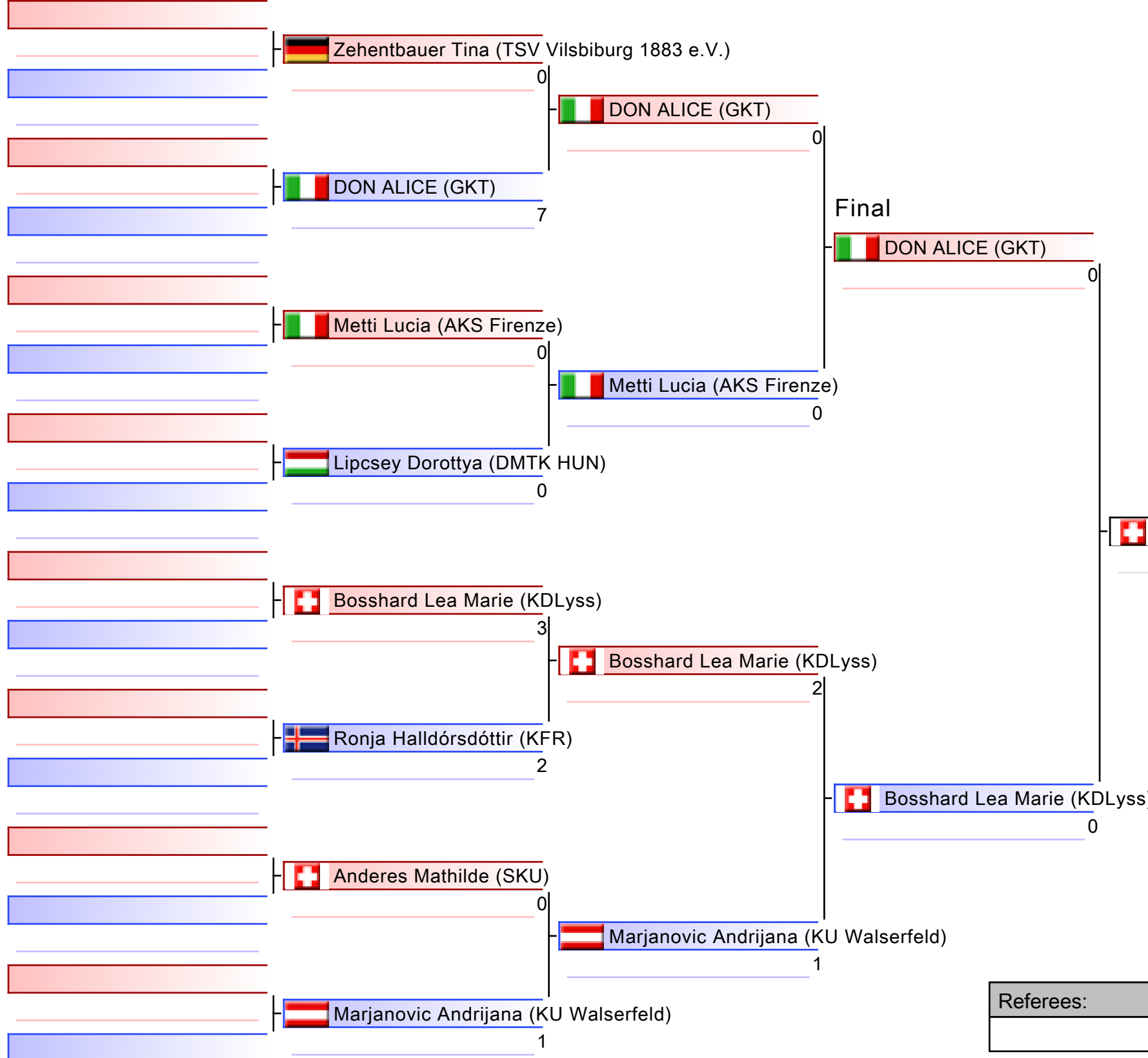

1. BOSSHARD LEA MARIE (KDLYSS)
2. DON ALICE (GKT)
3. ZEHENTBAUER TINA (TSV VILSBIBURG 1883 E)
3. MARJANOVIC ANDRIJANA (KU WALSERFELD)
5. METTI LUCIA (AKS FIRENZE)
5. RONJA HALLDÓRSDÓTTIR (KFR)

Referees:			

# Kumite Individual female U21 -61

AUSTRIAN JUNIOR OPEN 2023

2023-06-24

Tatami  
4 13:05

Pool  
1

(c)sportdata GmbH & Co KG 2000-2023 (2023-06-24 21:05) v 10.0.1 build 1 (2023-05-19 20:00 CET) License: Online\_Event\_ID-6821\_AUSTRIANJUNIOROPEN2023 (expire 2023-07-08)

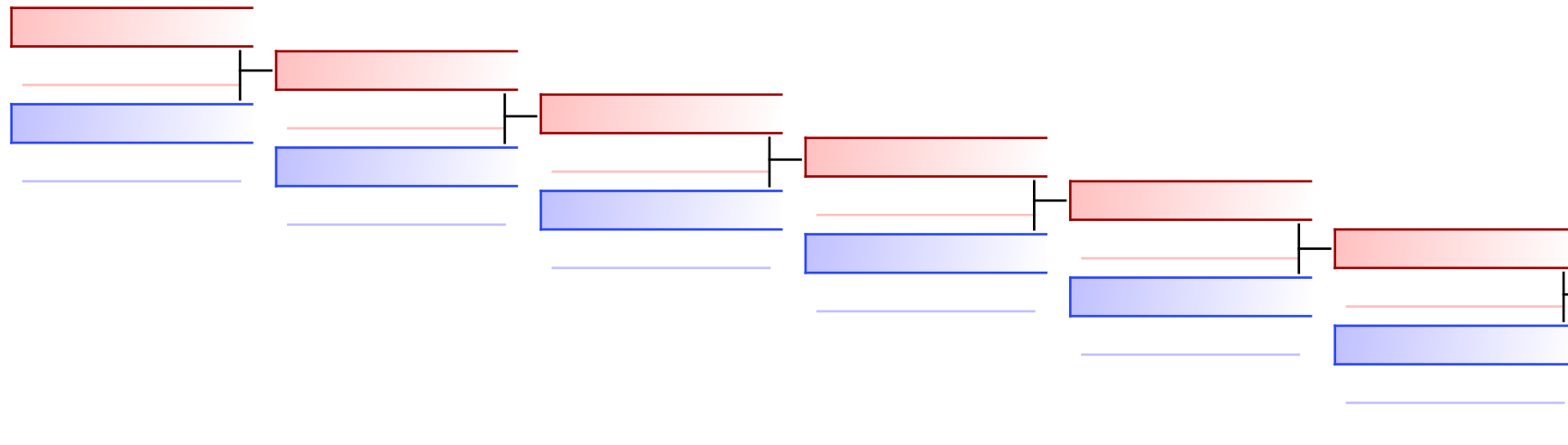

Zehentbauer Tina (TSV Vilsbiburg 1883 e.V.)

0

Zehentbauer Tina (TSV Vilsbiburg)

Metti Lucia (AKS Firenze)

0

## REPECHAGE: (1)

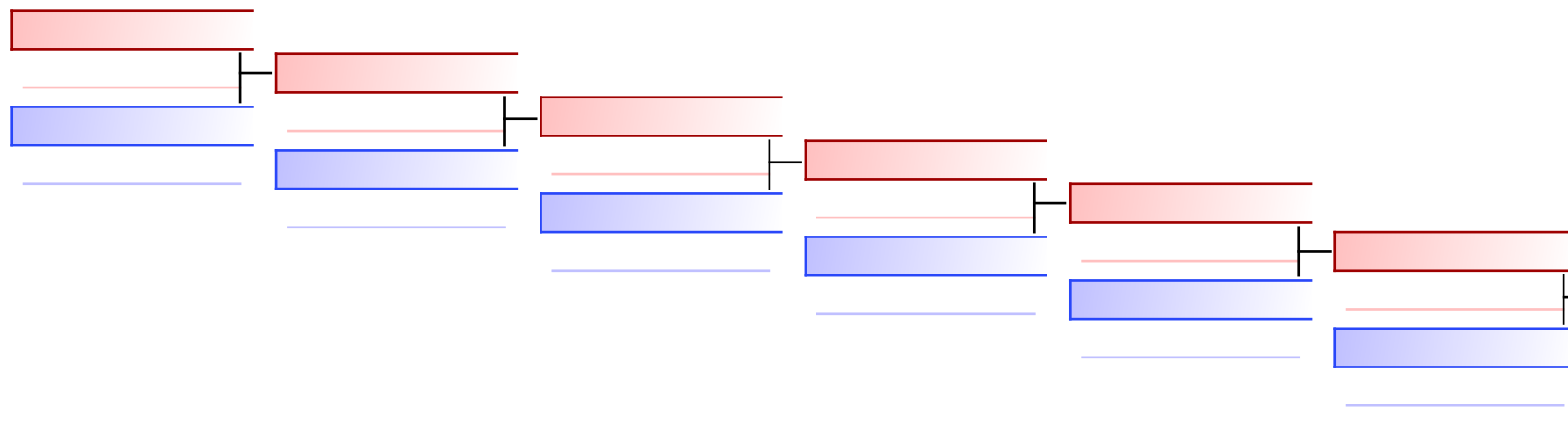

Ronja Halldórsdóttir (KFR)

2

Marjanovic Andrijana (KU Walser)

Marjanovic Andrijana (KU Walserfeld)

3

Referees:							
-----------	--	--	--	--	--	--	--

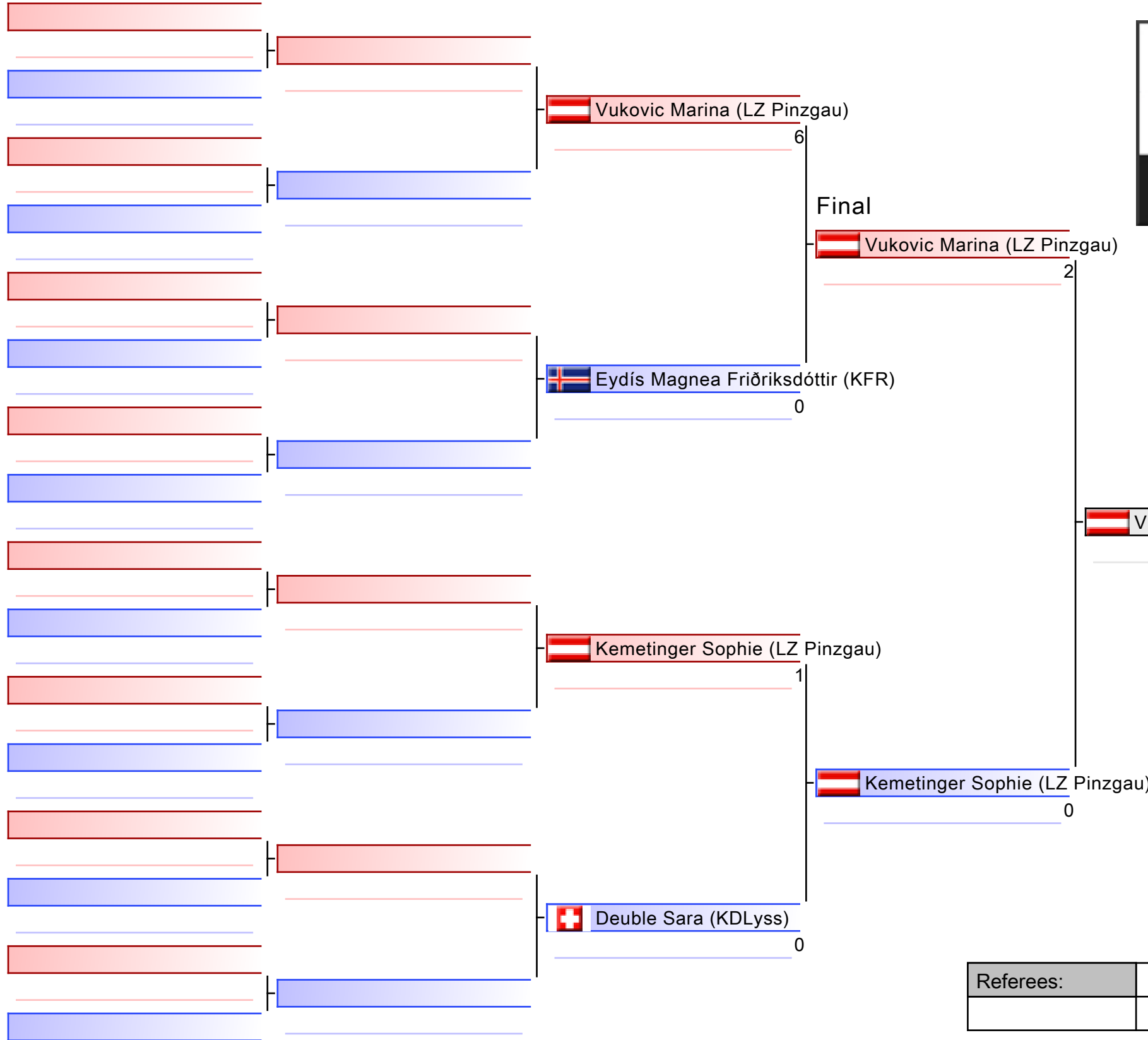

1. VUKOVIC MARINA (LZ PINZGAU)
2. KEMETINGER SOPHIE (LZ PINZGAU)
3. EYDÍS MAGNEA FRÍÐRIKSDÓTTIR (KFR)
3. DEUBLE SARA (KDLYSS)

Referees:			

# Kumite Individual female U21 -68

AUSTRIAN JUNIOR OPEN 2023

2023-06-24

Tatami  
2 19:40

Pool  
1

(c)sportdata GmbH & Co KG 2000-2023 (2023-06-24 21:05) v 10.0.1 build 1 (2023-05-19 20:00 CET) License: Online\_Event\_ID-6821\_AUSTRIANJUNIOROPEN2023 (expire 2023-07-08)

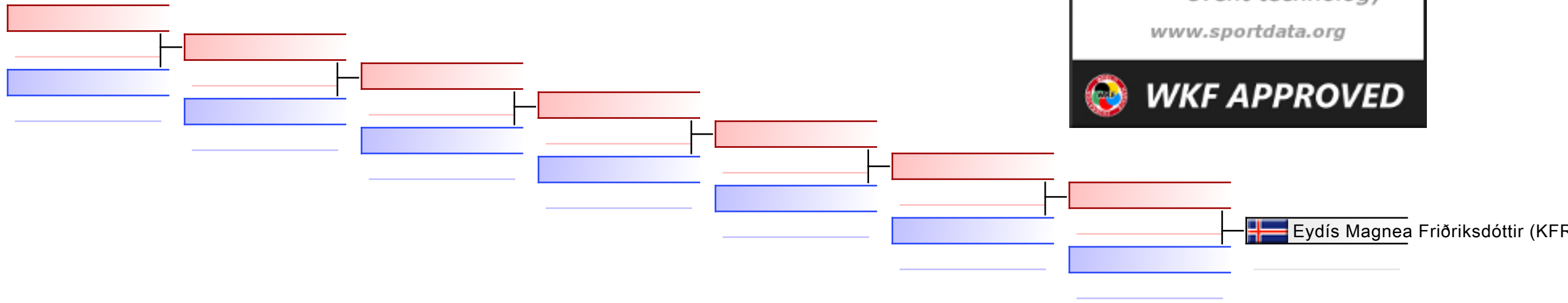

## REPECHAGE: (1)

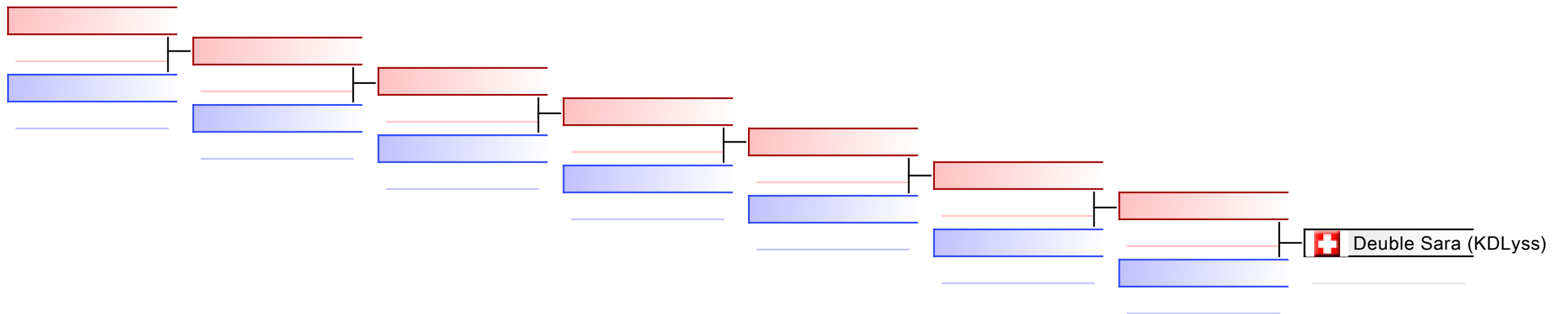

Referees:							
-----------	--	--	--	--	--	--	--



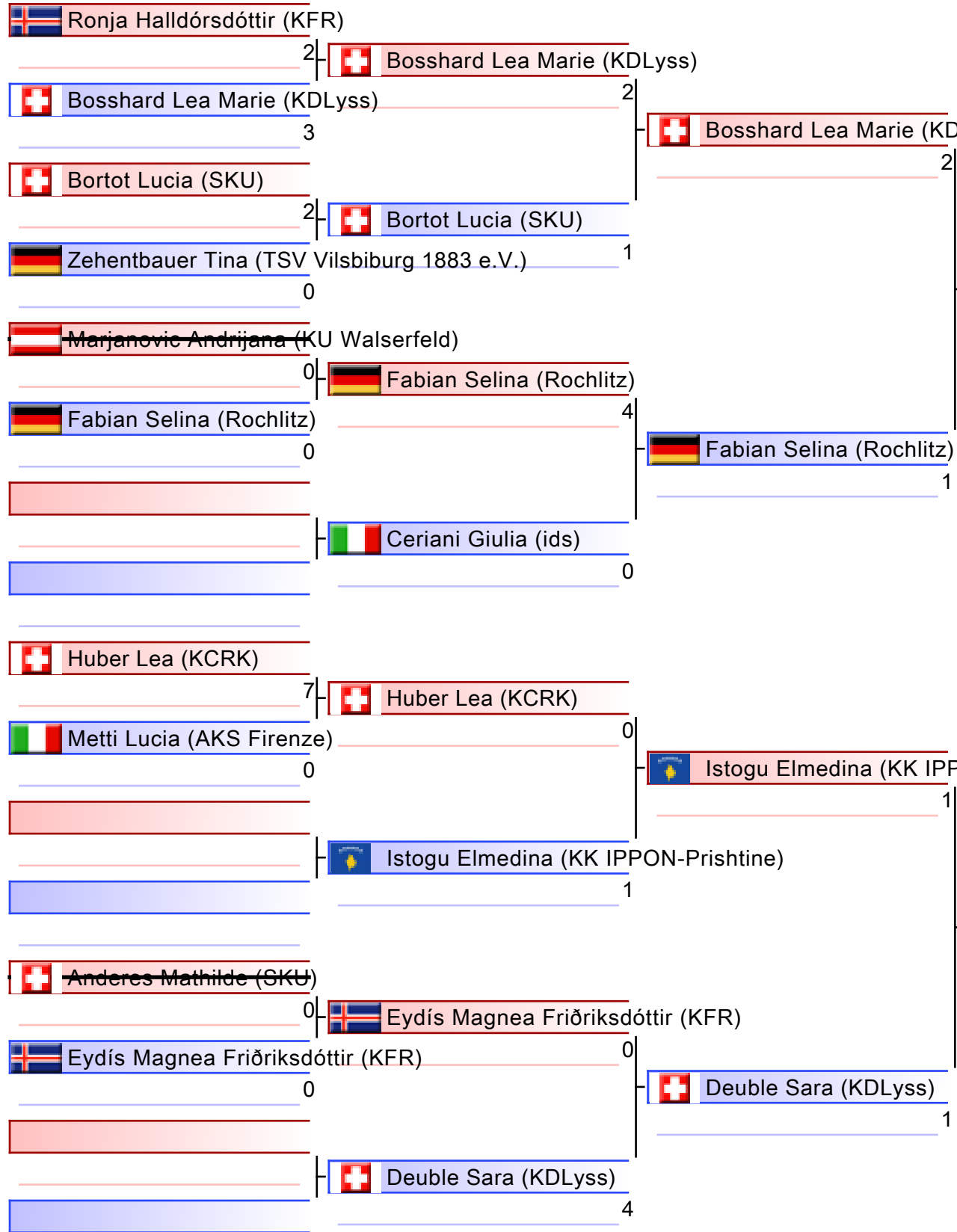

**Final**

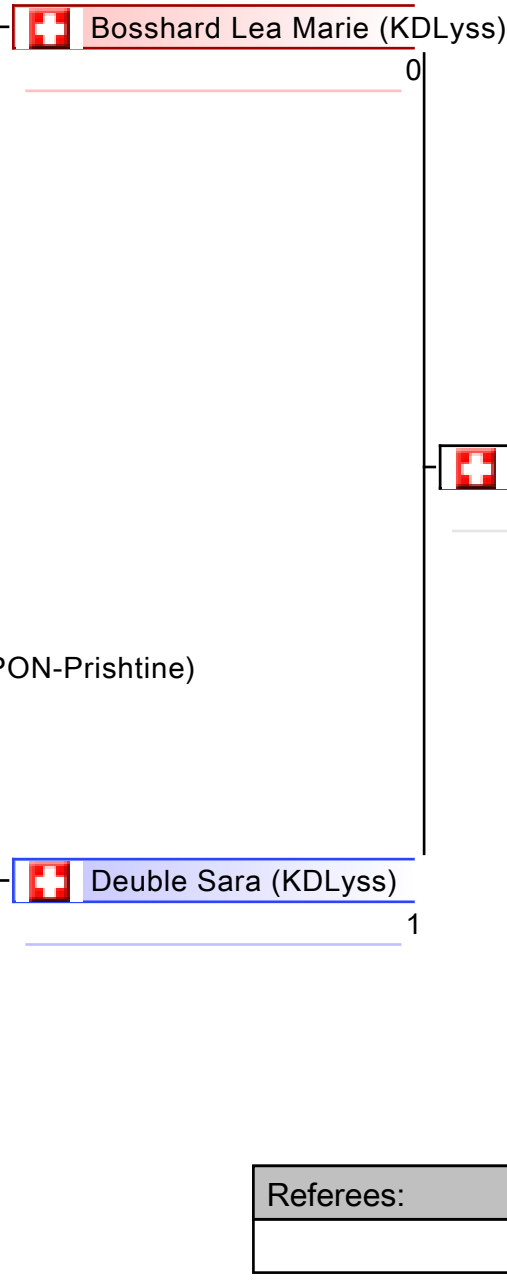

- |   |
|---|
| 1. DEUBLE SARA (KDLYSS)                 |
| 2. BOSSHARD LEA MARIE (KDLYSS)          |
| 3. FABIAN SELINA (ROCHLITZ)             |
| 3. ISTOGU ELMEDINA (KK IPPON-PRISHTINE) |
| 5. EYDÍS MAGNEA FRÍÐRIKSDÓTTIR (KFR)    |
| 5. BORTOT LUCIA (SKU)                   |
| 5. CERIANI GIULIA (IDS)                 |
| 5. HUBER LEA (KCRK)                     |

Referees:			

# Kumite Individual male Cadets +70

AUSTRIAN JUNIOR OPEN 2023, Schulstrasse 17, 5071 Wals, AUT

2023-06-24

Tatami  
1 15:00

Pool  
1/1

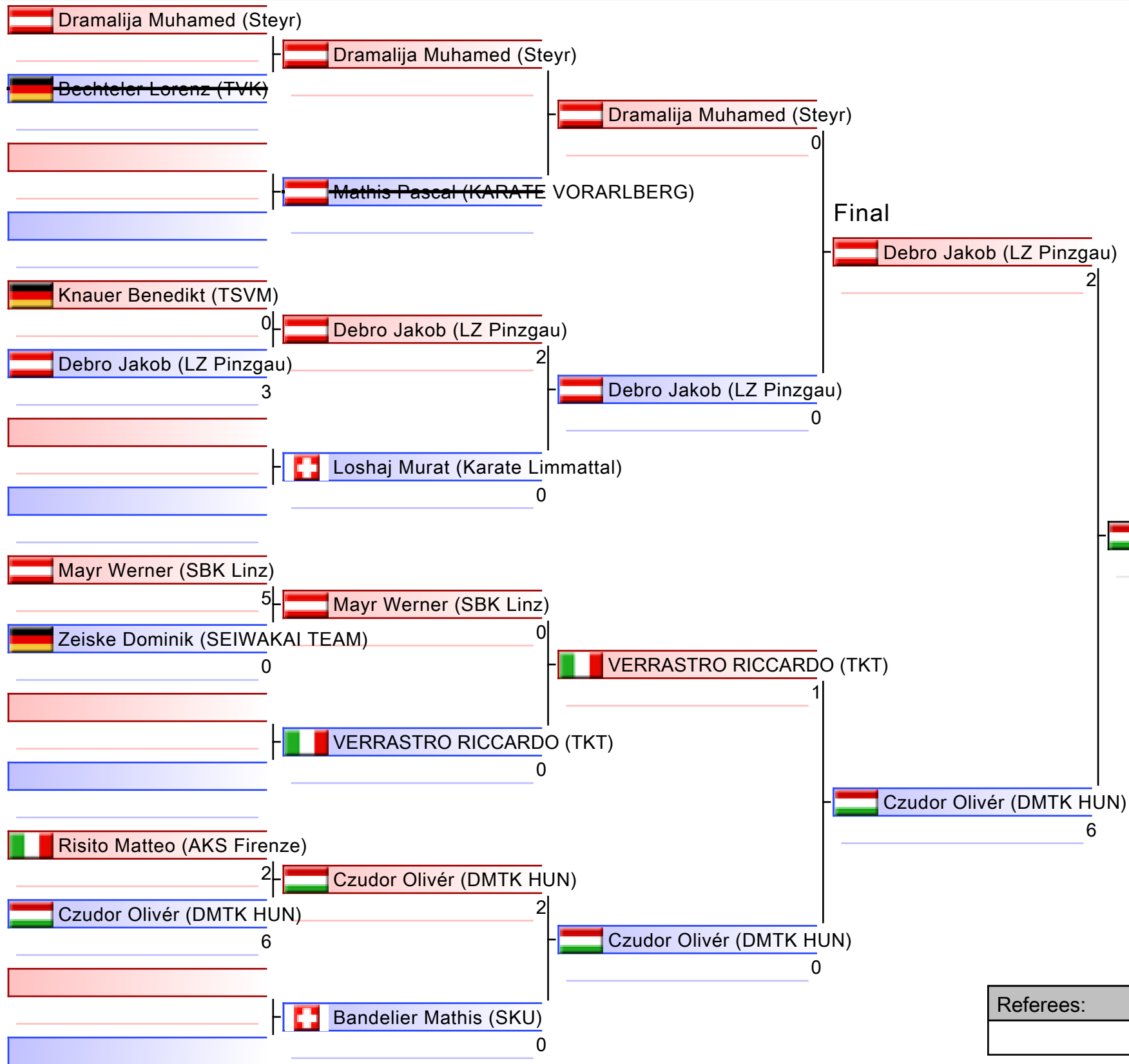

1. CZUDOR OLIVÉR (DMTK HUN)
2. DEBRO JAKOB (LZ PINZGAU)
3. DRAMALIJA MUHAMED (STEYR)
3. VERRASTRO RICCARDO (TKT)
5. KNAUER BENEDIKT (TSVM)
5. BANDELIER MATHIS (SKU)
7. LOSHAJ MURAT (KARATE LIMMATTAL)
7. RISITO MATTEO (AKS FIRENZE)

Referees:			

# Kumite Individual male Cadets +70

AUSTRIAN JUNIOR OPEN 2023

2023-06-24

Tatami  
1 15:00

Pool  
1

(c)sportdata GmbH & Co KG 2000-2023 (2023-06-24 21:05) v 10.0.1 build 1 (2023-05-19 20:00 CET) License: Online\_Event\_ID-6821\_AUSTRIANJUNIOROPEN2023 (expire 2023-07-08)

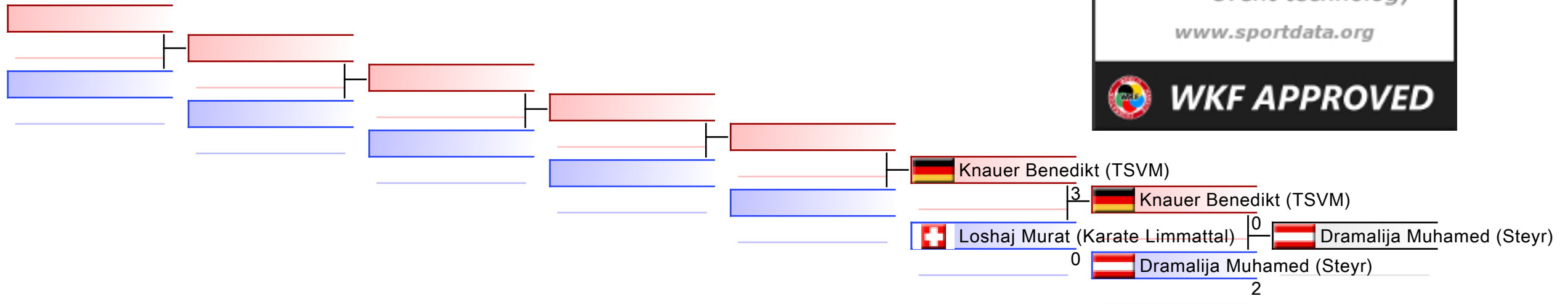

## REPECHAGE: (1)

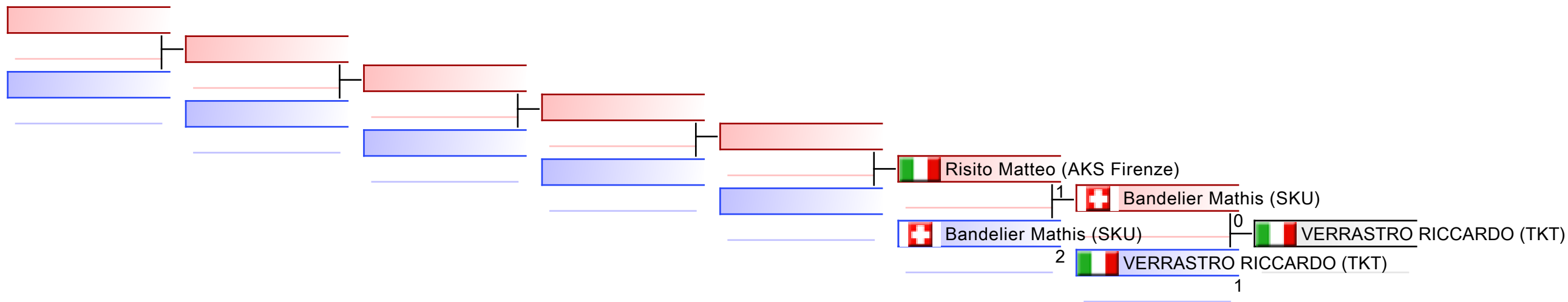

Referees:							
-----------	--	--	--	--	--	--	--

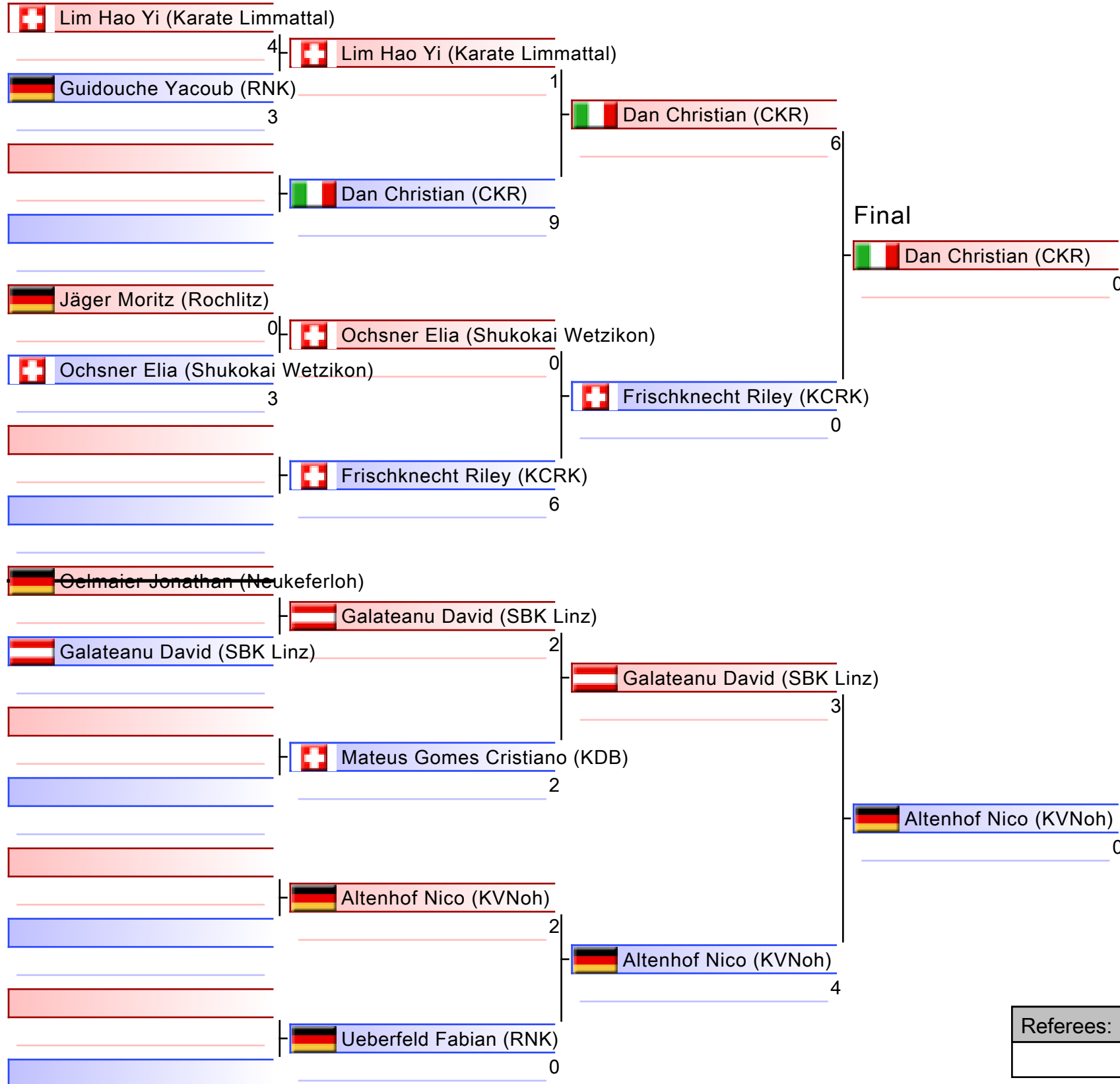

1. DAN CHRISTIAN (CKR)
2. ALTENHOF NICO (KVNOH)
3. FRISCHKNECHT RILEY (KCRK)
3. UEBERFELD FABIAN (RNK)
5. LIM HAO YI (KARATE LIMMATTAL)
5. GALATEANU DAVID (SBK LINZ)

Referees:			



# Kumite Individual male Cadets -57

AUSTRIAN JUNIOR OPEN 2023, Schulstrasse 17, 5071 Wals, AUT

2023-06-24

Tatami  
1 17:20

Pool  
1/1

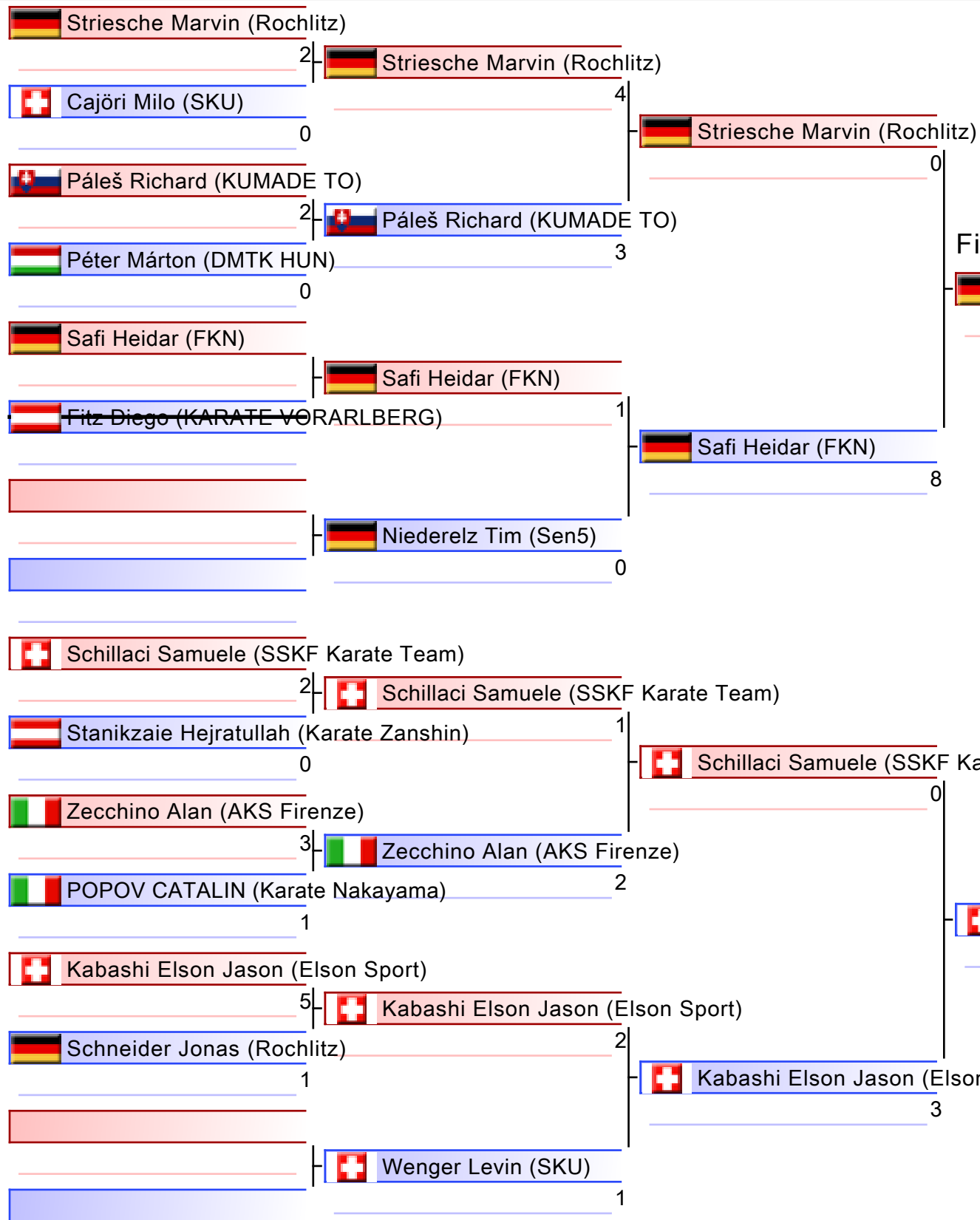

- |   |
|---|
| 1. SAFI HEIDAR (FKN)                    |
| 2. KABASHI ELSON JASON (ELSON SPORT)    |
| 3. NIEDERELZ TIM (SEN5)                 |
| 3. SCHILLACI SAMUELE (SSKF KARATE TEAM) |
| 5. STRIESCHE MARVIN (ROCHLITZ)          |
| 5. WENGER LEVIN (SKU)                   |
| 7. SCHNEIDER JONAS (ROCHLITZ)           |

Referees:			

# Kumite Individual male Cadets -57

AUSTRIAN JUNIOR OPEN 2023

2023-06-24

Tatami  
1 17:20

Pool  
1

(c)sportdata GmbH & Co KG 2000-2023 (2023-06-24 21:05) v 10.0.1 build 1 (2023-05-19 20:00 CET) License: Online\_Event\_ID-6821\_AUSTRIANJUNIOROPEN2023 (expire 2023-07-08)

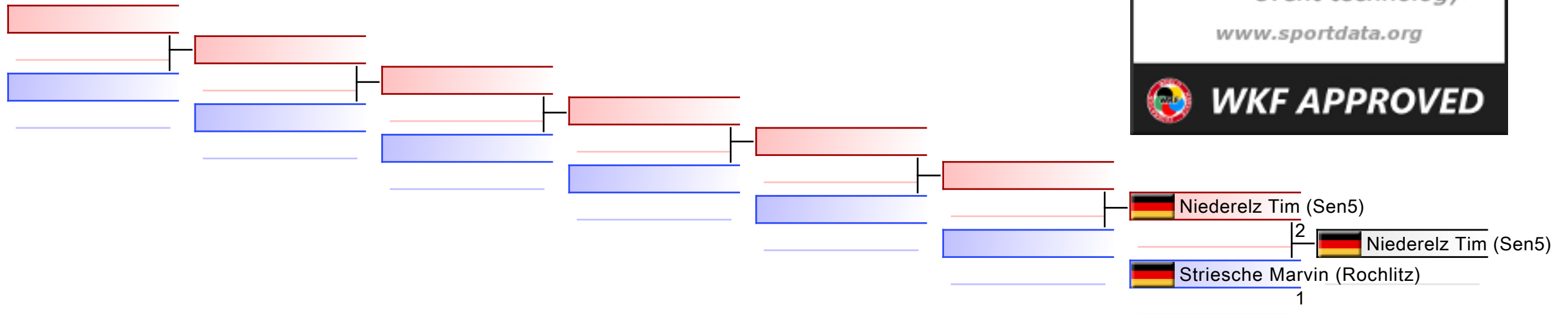

## REPECHAGE: (1)

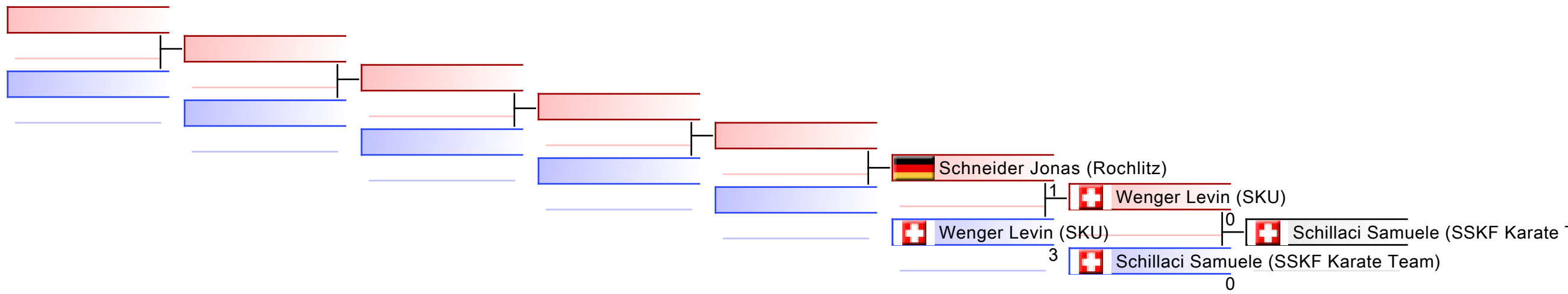

Referees:							
-----------	--	--	--	--	--	--	--

# Kumite Individual male Cadets -63

AUSTRIAN JUNIOR OPEN 2023, Schulstrasse 17, 5071 Wals, AUT

2023-06-24

Tatami 6 16:15

Pool 1/1

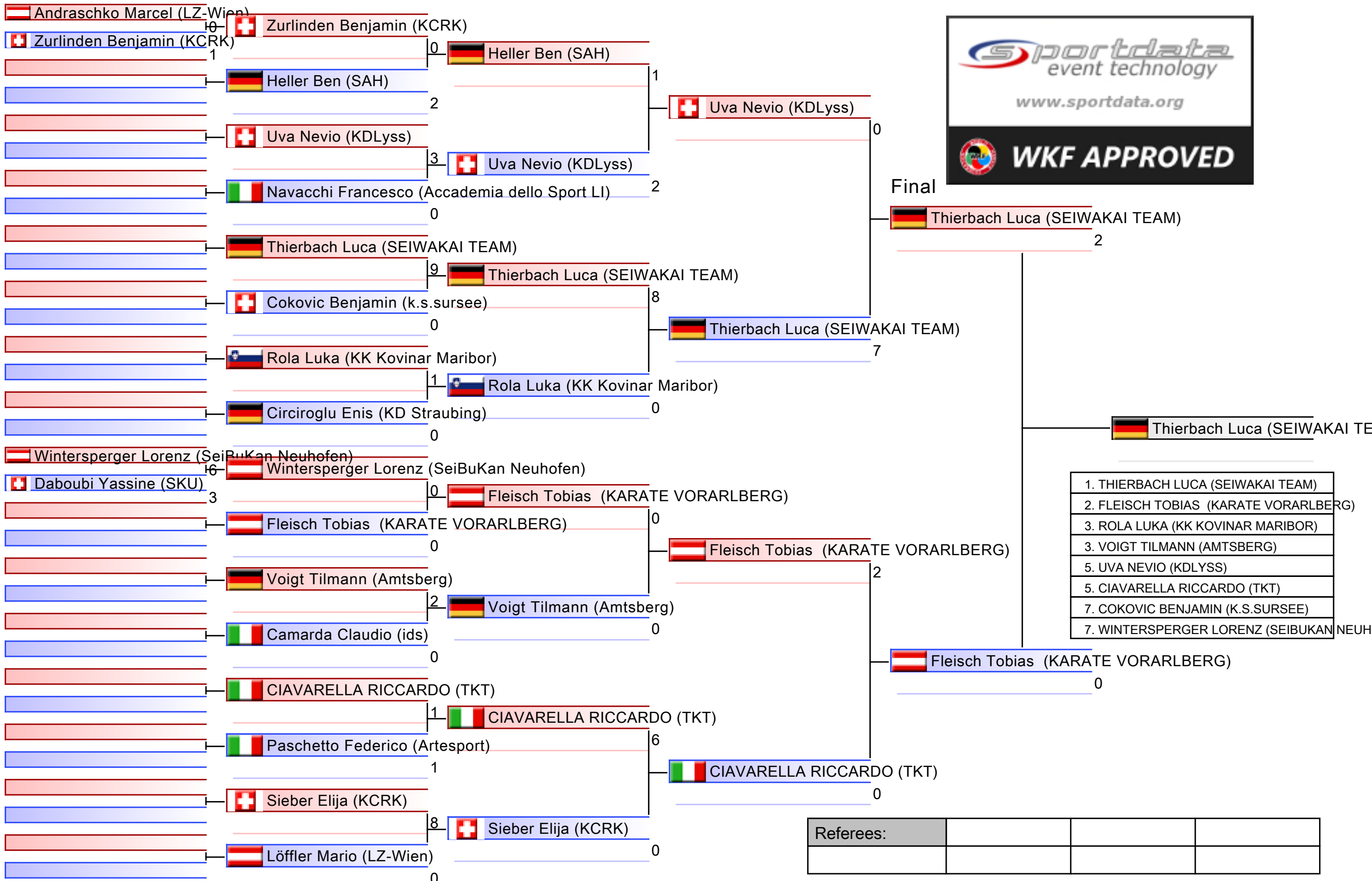

- |   |
|---|
| 1. THIERBACH LUCA (SEIWAKAI TEAM)           |
| 2. FLEISCH TOBIAS (KARATE VORARLBERG)       |
| 3. ROLA LUKA (KK KOVINAR MARIBOR)           |
| 3. VOIGT TILMANN (AMTSBERG)                 |
| 5. UVA NEVIO (KDLyss)                       |
| 5. CIAVARELLA RICCARDO (TKT)                |
| 7. COKOVIC BENJAMIN (K.S.SURSEE)            |
| 7. WINTERSPERGER LORENZ (SEIBUKAN NEUHOFEN) |



# Kumite Individual male Cadets -63

AUSTRIAN JUNIOR OPEN 2023

2023-06-24

Tatami  
6 16:15

Pool  
1

(c)sportdata GmbH & Co KG 2000-2023 (2023-06-24 21:05) v 10.0.1 build 1 (2023-05-19 20:00 CET) License: Online\_Event\_ID-6821\_AUSTRIANJUNIOROPEN2023 (expire 2023-07-08)

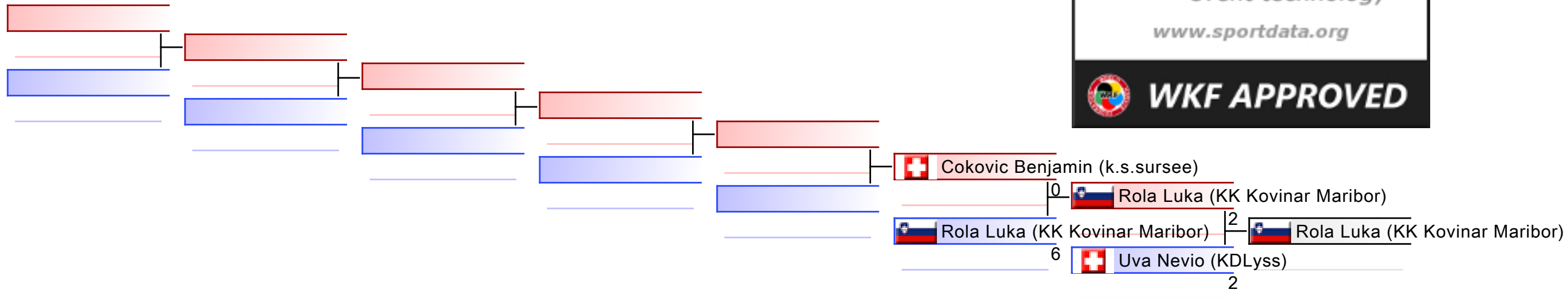

## REPECHAGE: (1)

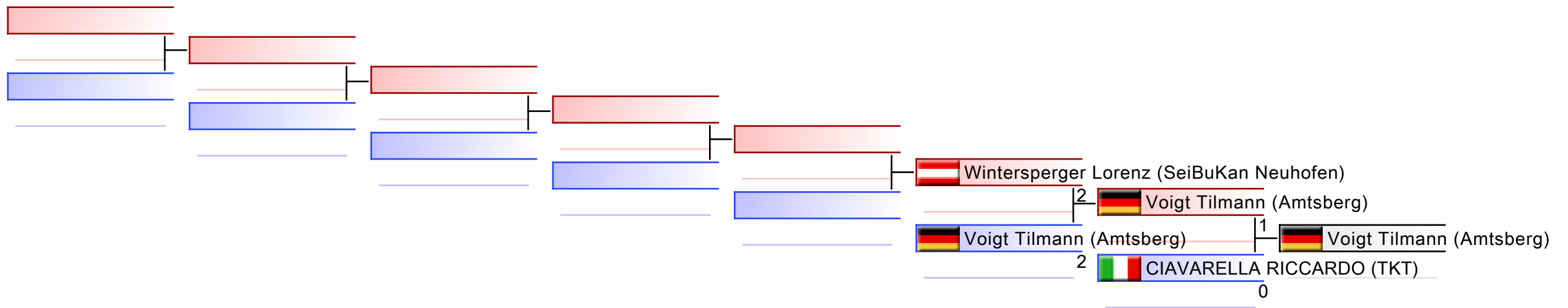

Referees:							
-----------	--	--	--	--	--	--	--

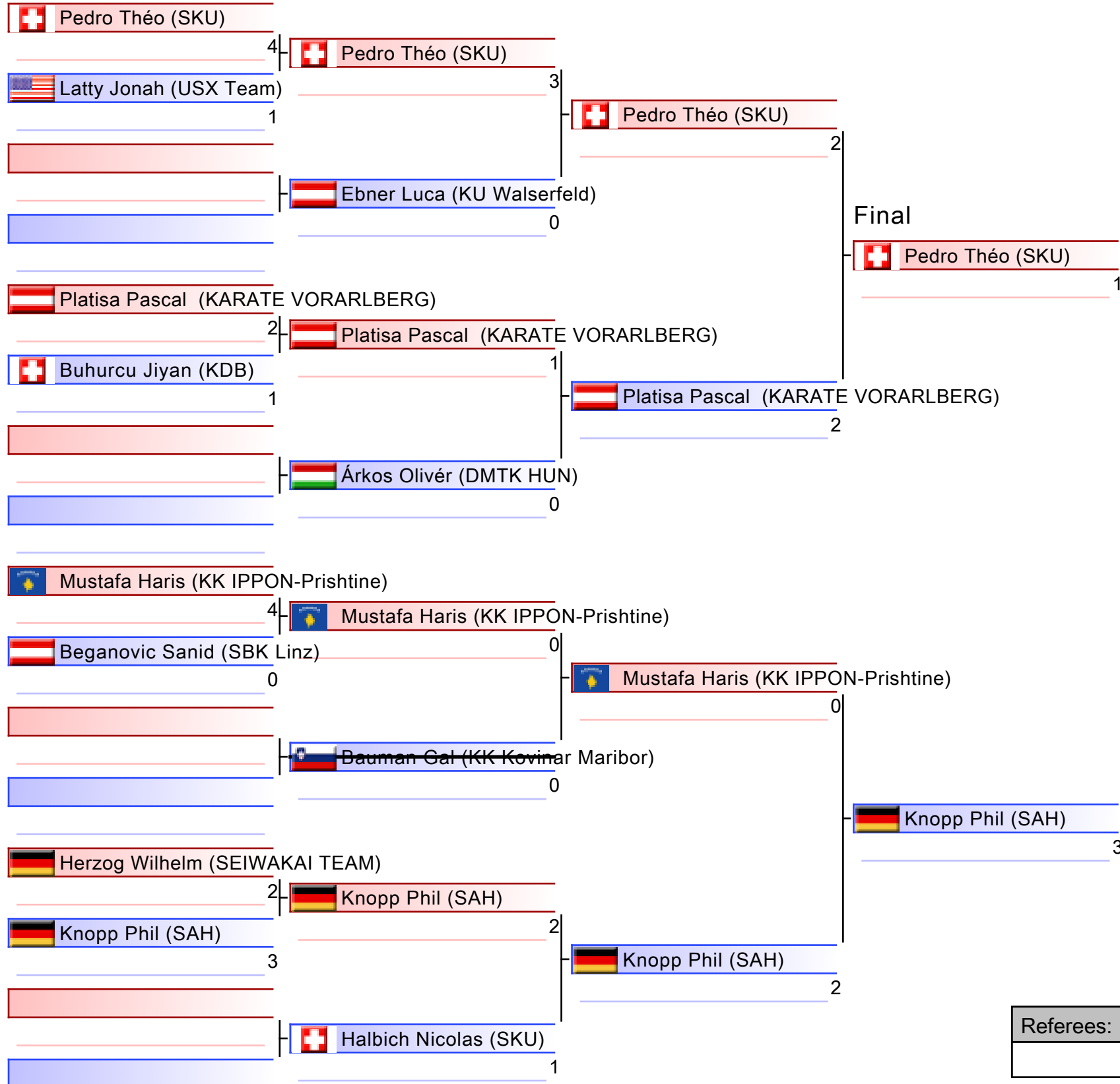

1. KNOPP PHIL (SAH)
2. PEDRO THÉO (SKU)
3. PLATISA PASCAL (KARATE VORARLBERG)
3. MUSTAFA HARIS (KK IPPON-PRISHTINE)
5. EBNER LUCA (KU WALSERFELD)
5. HERZOG WILHELM (SEIWAKAI TEAM)
7. LATTY JONAH (USX TEAM)
7. HALBICH NICOLAS (SKU)

Referees:			

# Kumite Individual male Cadets -70

AUSTRIAN JUNIOR OPEN 2023

2023-06-24

Tatami  
6 13:10

Pool  
1

(c)sportdata GmbH & Co KG 2000-2023 (2023-06-24 21:05) v 10.0.1 build 1 (2023-05-19 20:00 CET) License: Online\_Event\_ID-6821\_AUSTRIANJUNIOROPEN2023 (expire 2023-07-08)

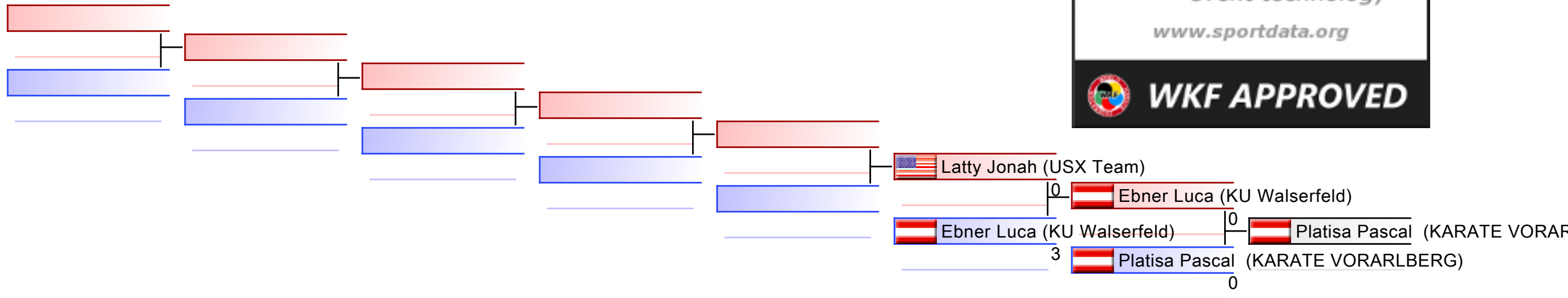

## REPECHAGE: (1)

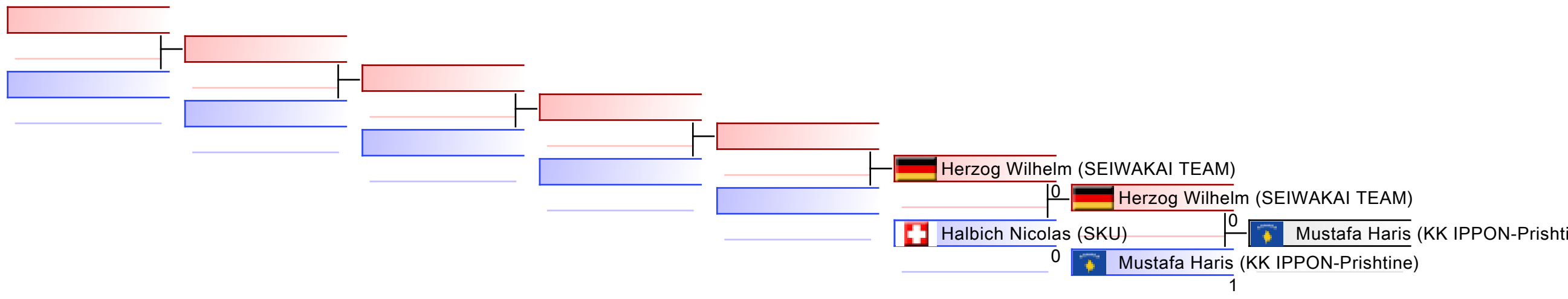

Referees:							
-----------	--	--	--	--	--	--	--

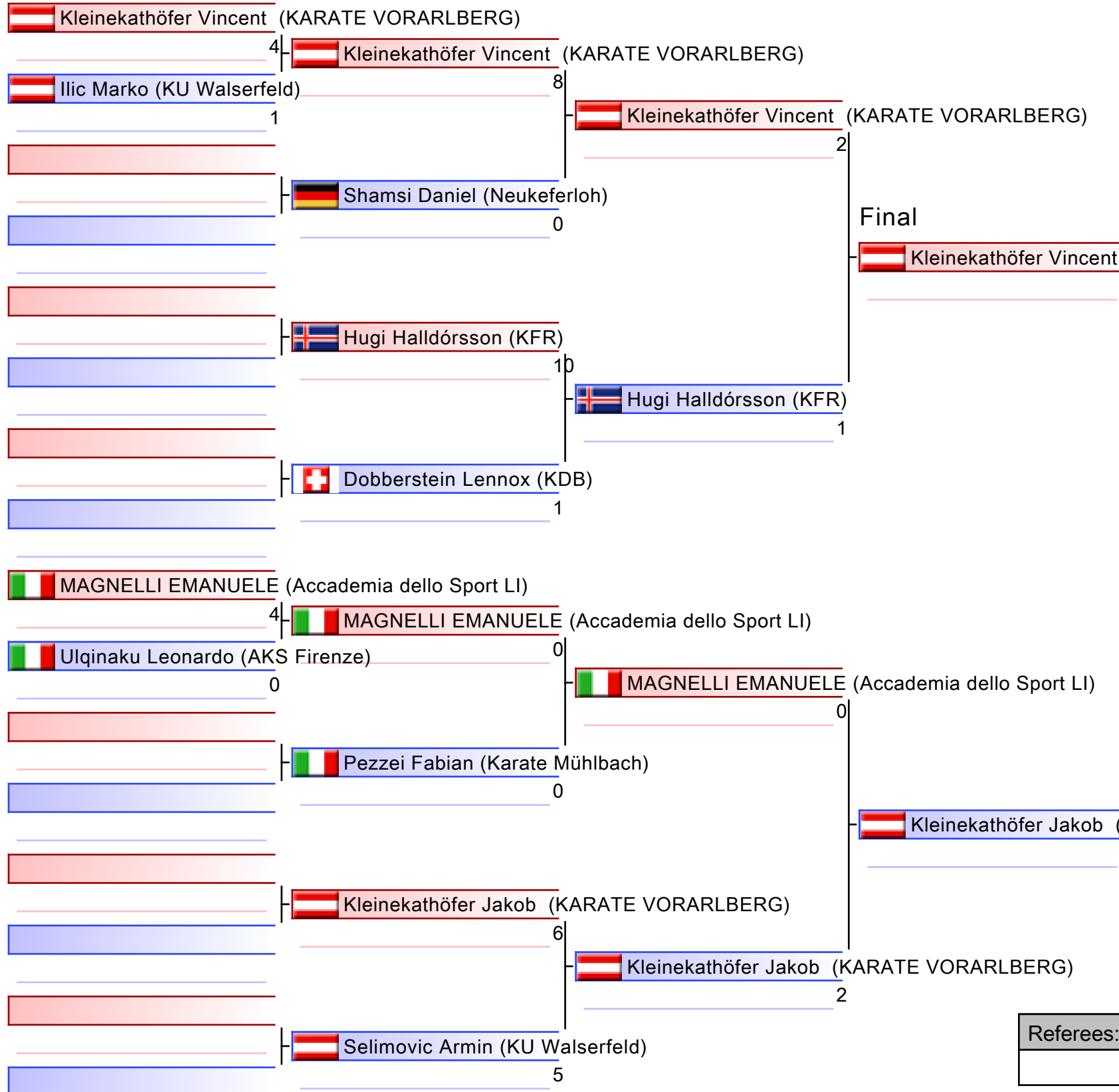

- |   |
|---|
| 1. KLEINEKATHÖFER JAKOB (KARATE VORARLBERG)     |
| 2. KLEINEKATHÖFER VINCENT (KARATE VORARLBERG)   |
| 3. SELIMOVIC ARMIN (KU WALSERFELD)              |
| 3. HUGI HALLDÓRSSON (KFR)                       |
| 5. MAGNELLI EMANUELE (ACCADEMIA DELLO SPORT LI) |
| 5. SHAMSI DANIEL (NEUKEFERLOH)                  |
| 7. ILIC MARKO (KU WALSERFELD)                   |

Referees:			

# Kumite Individual male Juniors +76

AUSTRIAN JUNIOR OPEN 2023

2023-06-24

Tatami  
1 13:05

Pool  
1

(c)sportdata GmbH & Co KG 2000-2023 (2023-06-24 21:05) v 10.0.1 build 1 (2023-05-19 20:00 CET) License: Online\_Event\_ID-6821\_AUSTRIANJUNIOROPEN2023 (expire 2023-07-08)

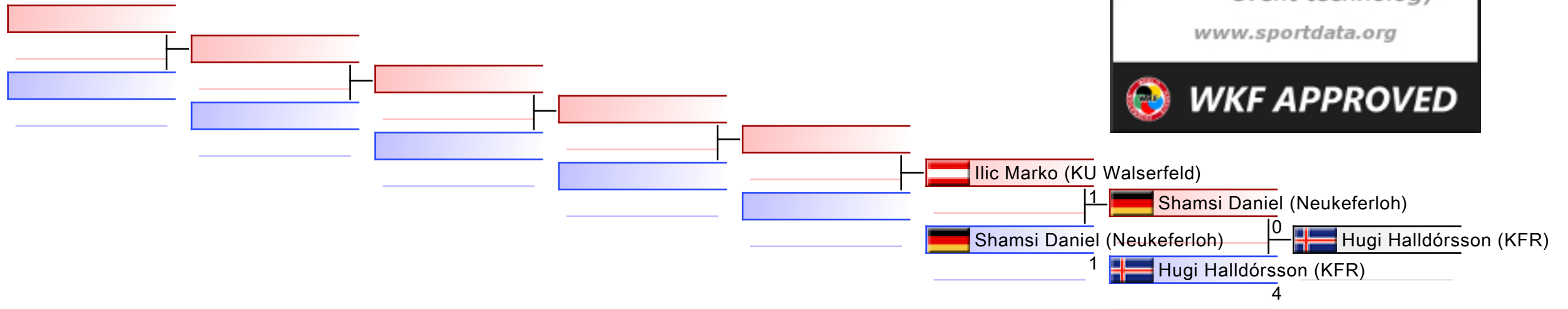

## REPECHAGE: (1)

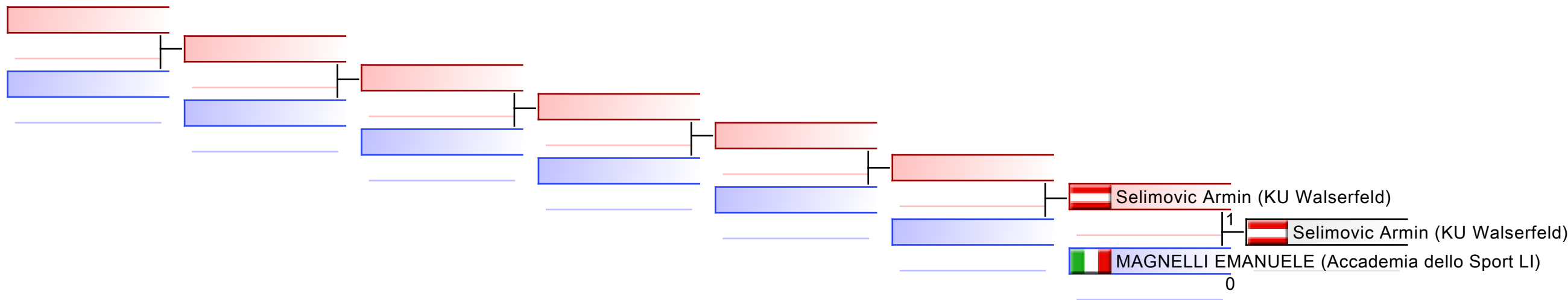

Referees:							
-----------	--	--	--	--	--	--	--

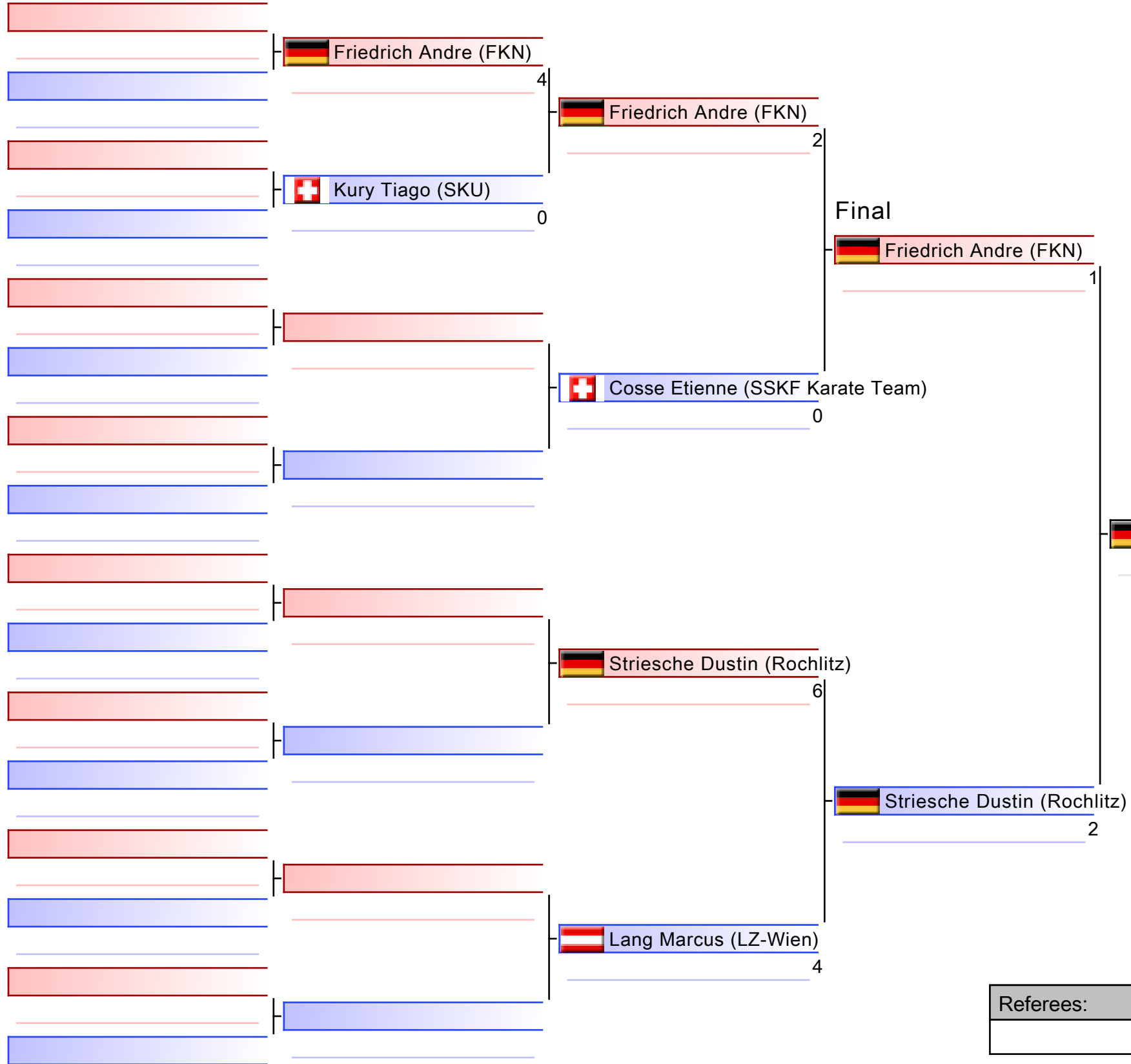

1. STRIESCHE DUSTIN (ROCHLITZ)
2. FRIEDRICH ANDRE (FKN)
3. LANG MARCUS (LZ-WIEN)
3. KURY TIAGO (SKU)
5. COSSE ETIENNE (SSKF KARATE TEAM)

Referees:			

# Kumite Individual male Juniors -55

AUSTRIAN JUNIOR OPEN 2023

2023-06-24

Tatami  
5 15:55

Pool  
1

(c)sportdata GmbH & Co KG 2000-2023 (2023-06-24 21:05) v 10.0.1 build 1 (2023-05-19 20:00 CET) License: Online\_Event\_ID-6821\_AUSTRIANJUNIOROPEN2023 (expire 2023-07-08)

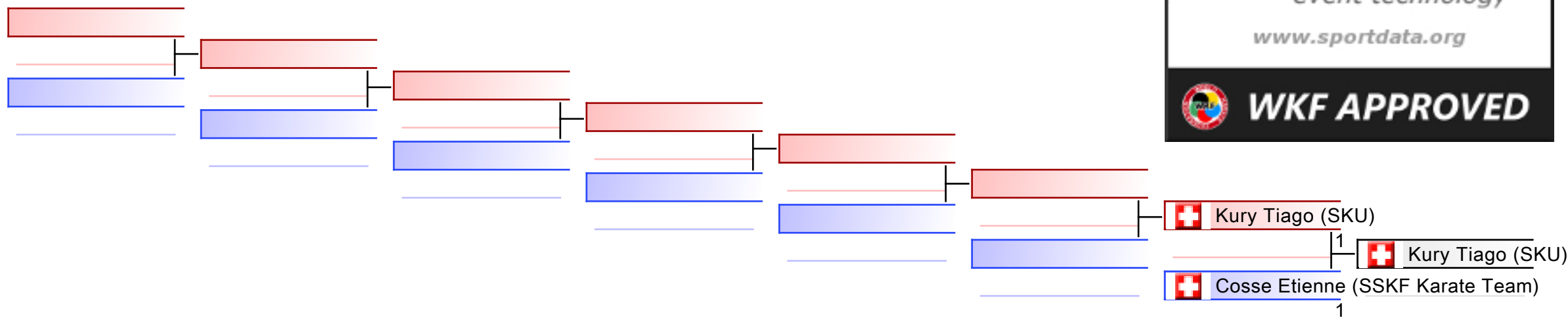

## REPECHAGE: (1)

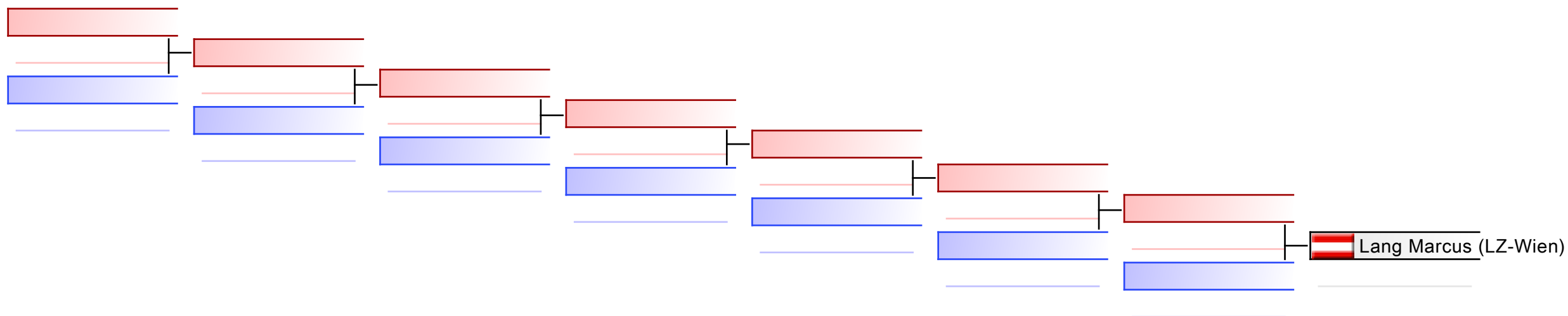

Referees:							
-----------	--	--	--	--	--	--	--

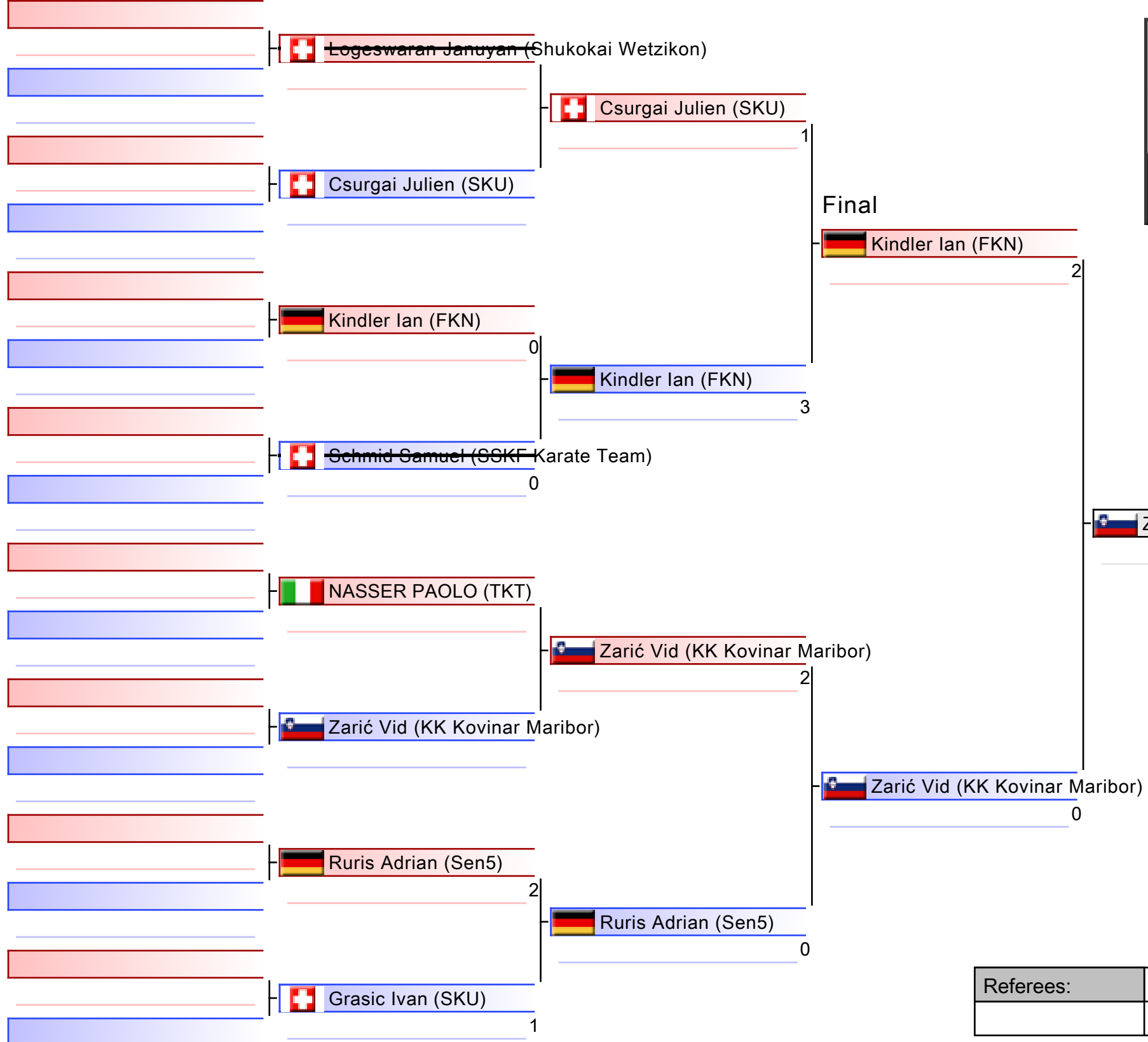

1. ZARIĆ VID (KK KOVINAR MARIBOR)
2. KINDLER IAN (FKN)
3. CSURGAI JULIEN (SKU)
3. NASSER PAOLO (TKT)
5. RURIS ADRIAN (SEN5)

Referees:			



# Kumite Individual male Juniors -61

AUSTRIAN JUNIOR OPEN 2023

2023-06-24

Tatami  
5 16:25

Pool  
1

(c)sportdata GmbH & Co KG 2000-2023 (2023-06-24 21:05) v 10.0.1 build 1 (2023-05-19 20:00 CET) License: Online\_Event\_ID-6821\_AUSTRIANJUNIOROPEN2023 (expire 2023-07-08)

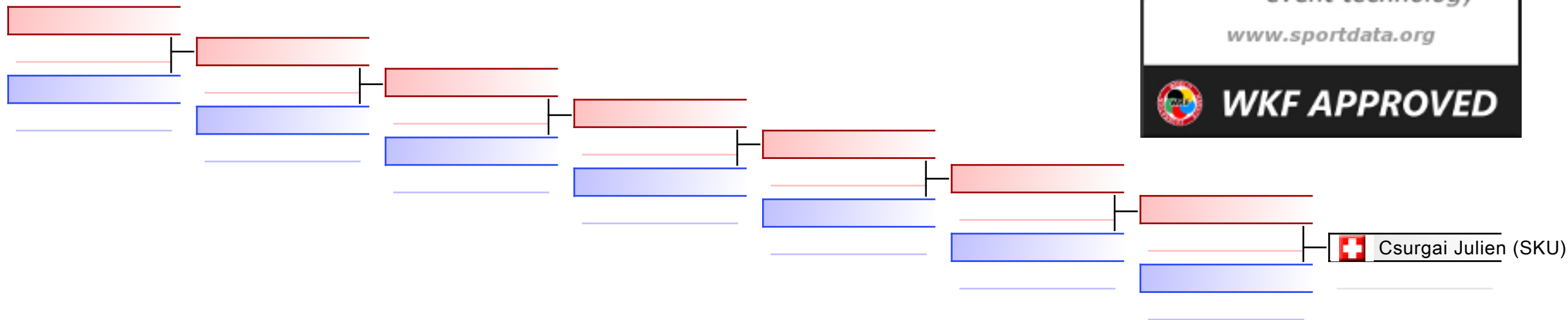

## REPECHAGE: (1)

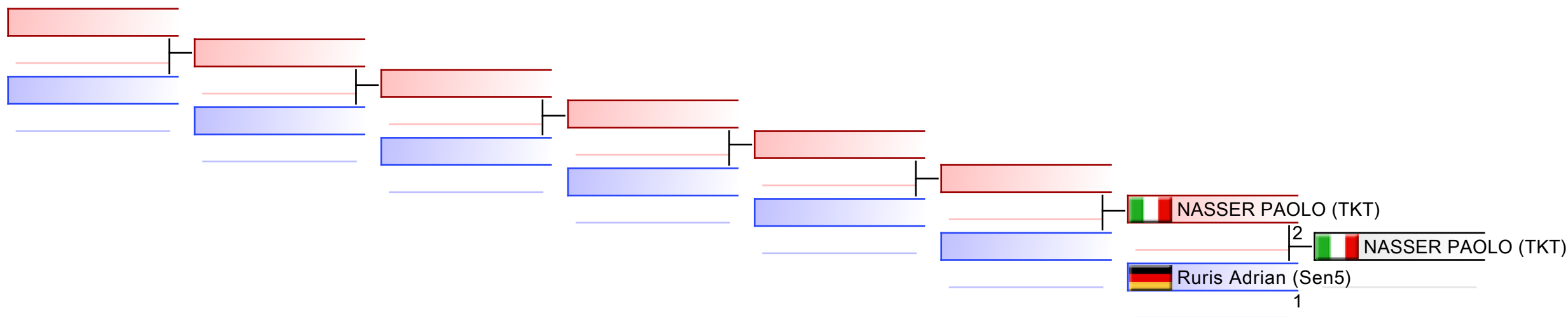

Referees:							
-----------	--	--	--	--	--	--	--

# Kumite Individual male Juniors -68

AUSTRIAN JUNIOR OPEN 2023, Schulstrasse 17, 5071 Wals, AUT

2023-06-24

Tatami  
5 17:20

Pool  
1/1

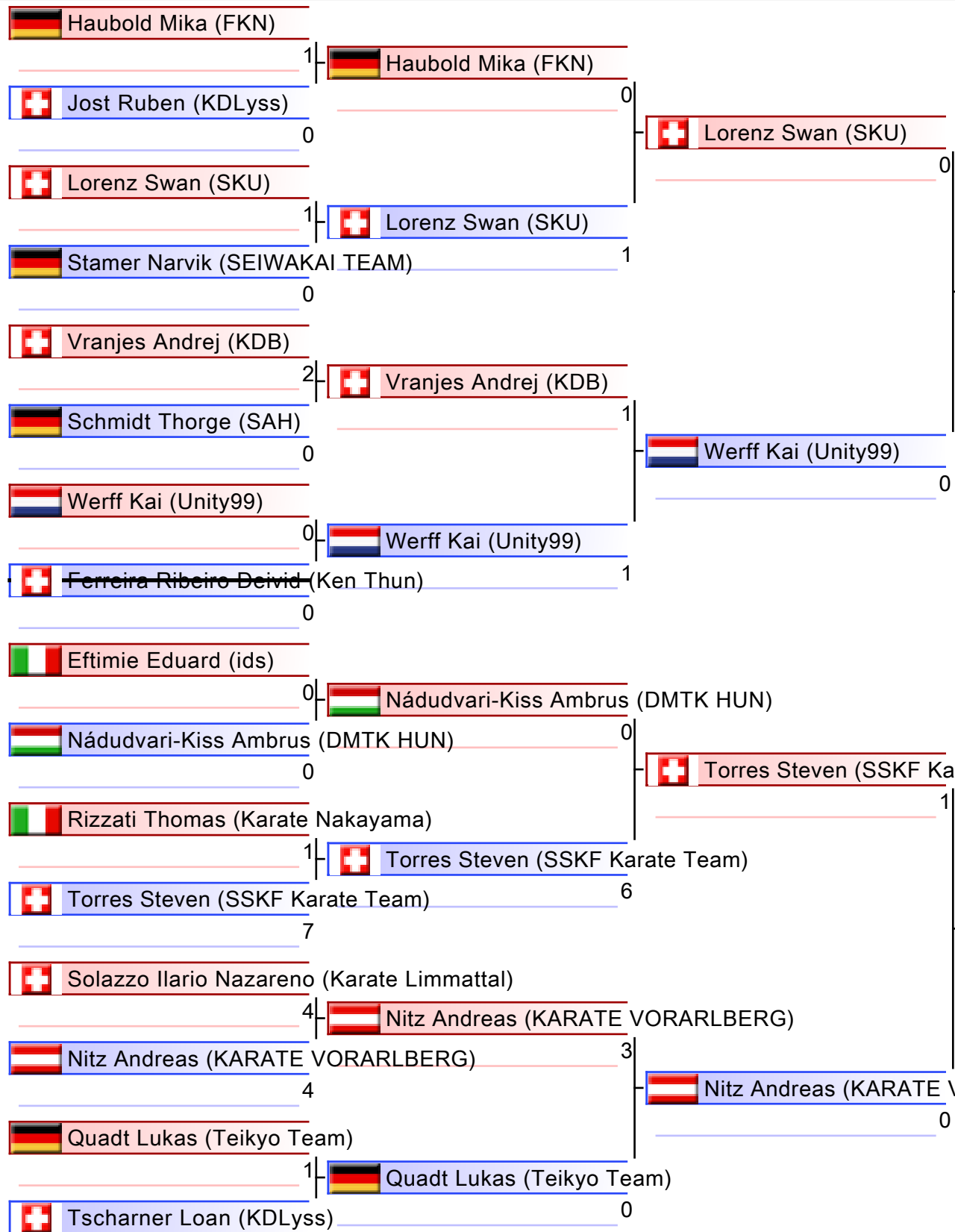

1. TORRES STEVEN (SSKF KARATE TEAM)
2. LORENZ SWAN (SKU)
3. STAMER NARVIK (SEIWAKAI TEAM)
3. NITZ ANDREAS (KARATE VORARLBERG)
5. WERFF KAI (UNITY99)
5. NÁDUDVARI-KISS AMBRUS (DMTK HUN)
7. HAUBOLD MIKA (FKN)
7. RIZZATI THOMAS (KARATE NAKAYAMA)

Referees:			

# Kumite Individual male Juniors -68

AUSTRIAN JUNIOR OPEN 2023

2023-06-24

Tatami  
5 17:20

Pool  
1

(c)sportdata GmbH & Co KG 2000-2023 (2023-06-24 21:05) v 10.0.1 build 1 (2023-05-19 20:00 CET) License: Online\_Event\_ID-6821\_AUSTRIANJUNIOROPEN2023 (expire 2023-07-08)

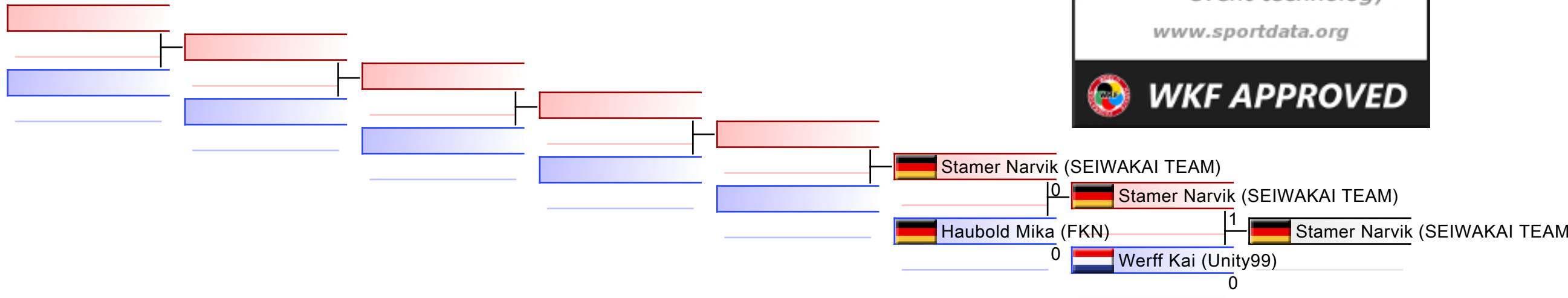

## REPECHAGE: (1)

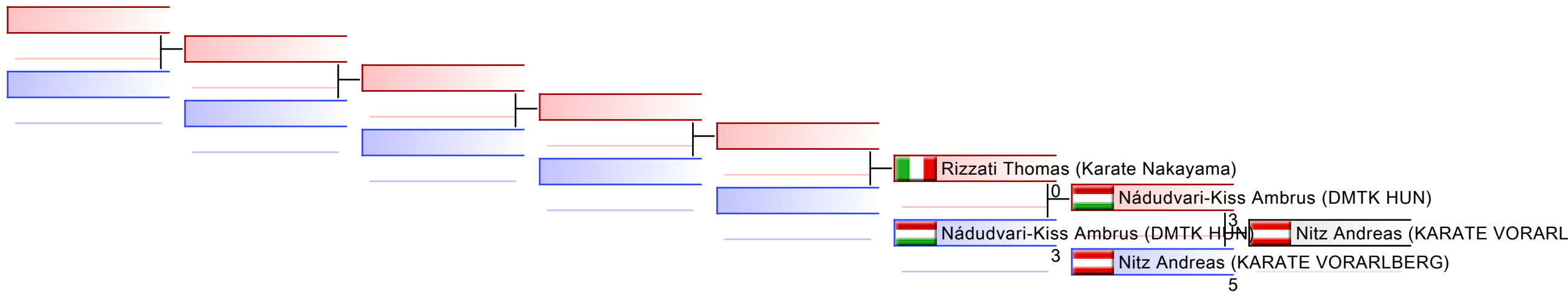

Referees:							
-----------	--	--	--	--	--	--	--

# Kumite Individual male Juniors -76

AUSTRIAN JUNIOR OPEN 2023, Schulstrasse 17, 5071 Wals, AUT

2023-06-24

Tatami  
5 13:10

Pool  
1/1

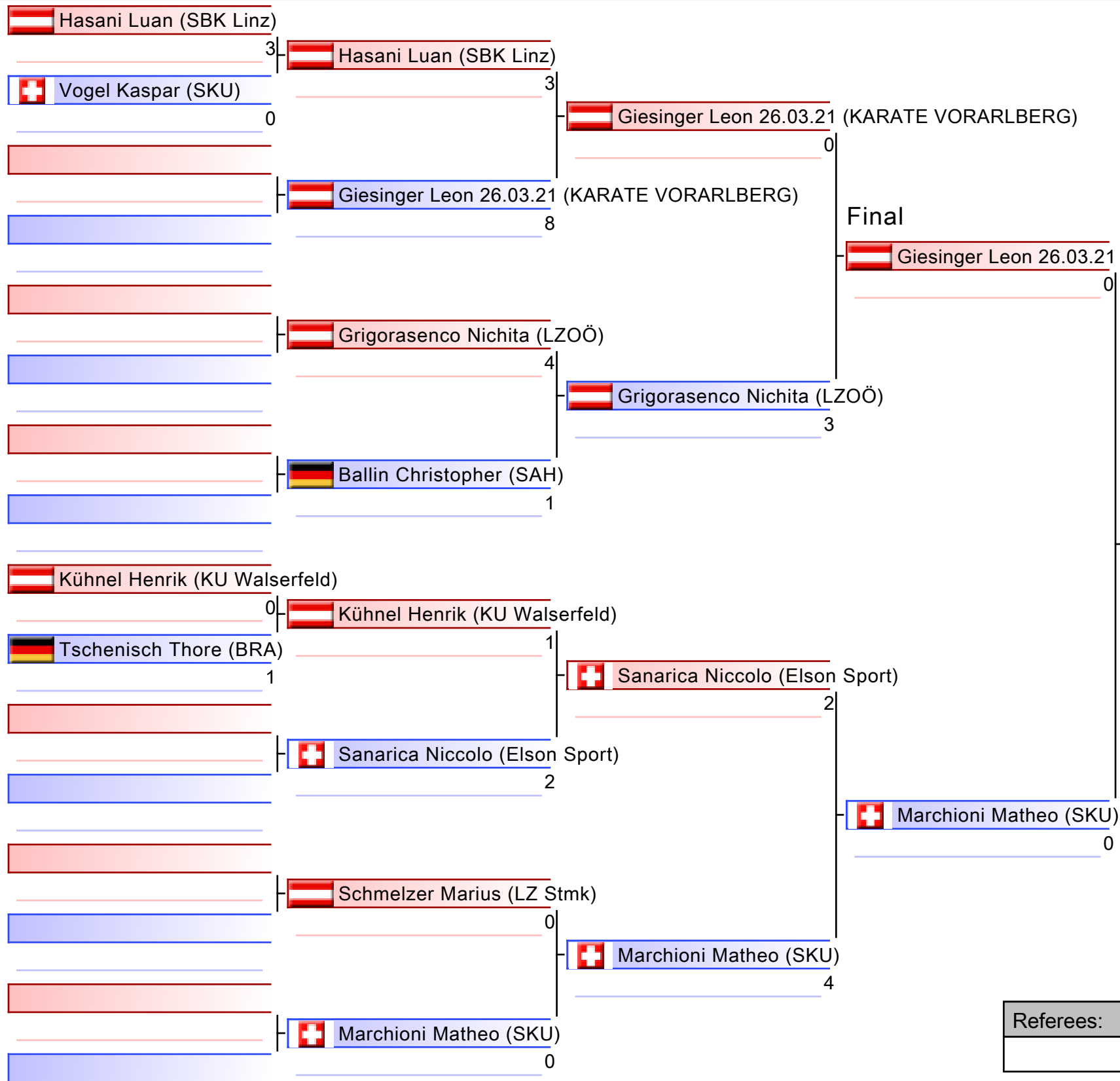

1. MARCHIONI MATHEO (SKU)
2. GIESINGER LEON 26.03.21 (KARATE VORARLBERG)
3. GRIGORASENCO NICHITA (LZOÖ)
3. SCHMELZER MARIUS (LZ STMK)
5. HASANI LUAN (SBK LINZ)
5. SANARICA NICCOLO (ELSON SPORT)

Referees:			

# Kumite Individual male Juniors -76

AUSTRIAN JUNIOR OPEN 2023

2023-06-24

Tatami  
5 13:10

Pool  
1

(c)sportdata GmbH & Co KG 2000-2023 (2023-06-24 21:05) v 10.0.1 build 1 (2023-05-19 20:00 CET) License: Online\_Event\_ID-6821\_AUSTRIANJUNIOROPEN2023 (expire 2023-07-08)

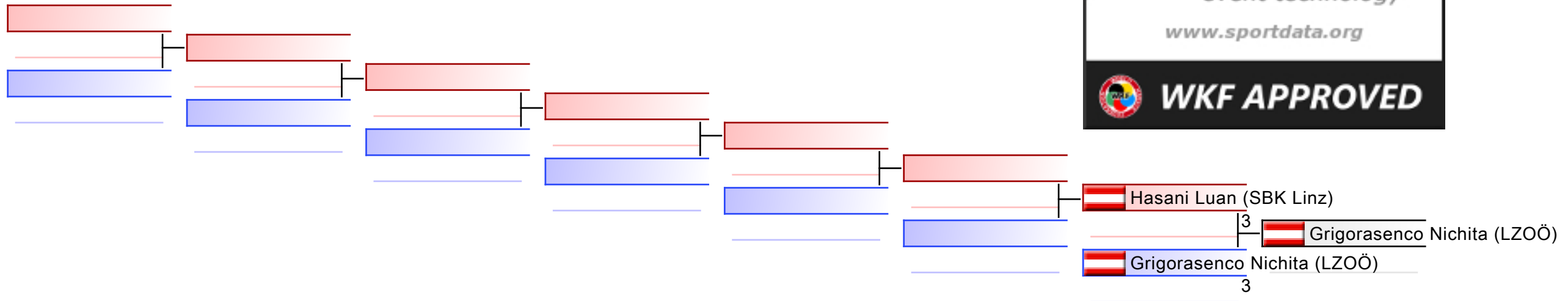

## REPECHAGE: (1)

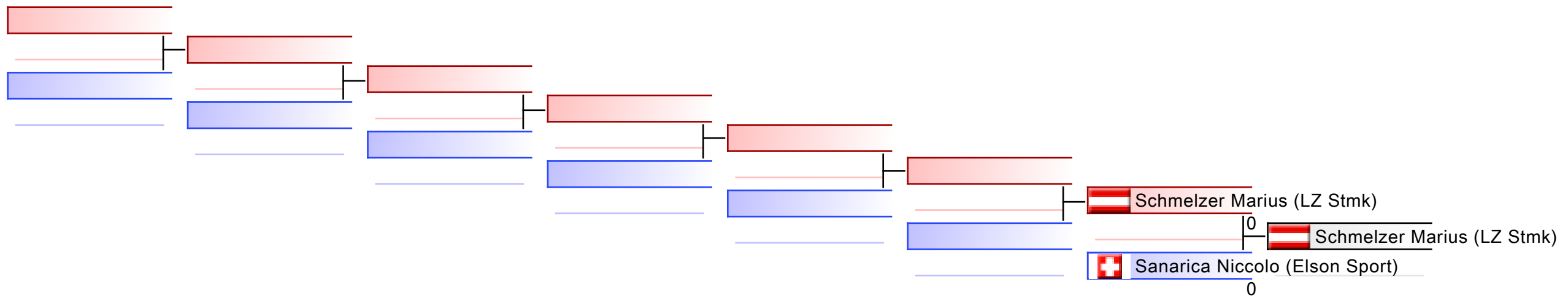

Referees:							
-----------	--	--	--	--	--	--	--

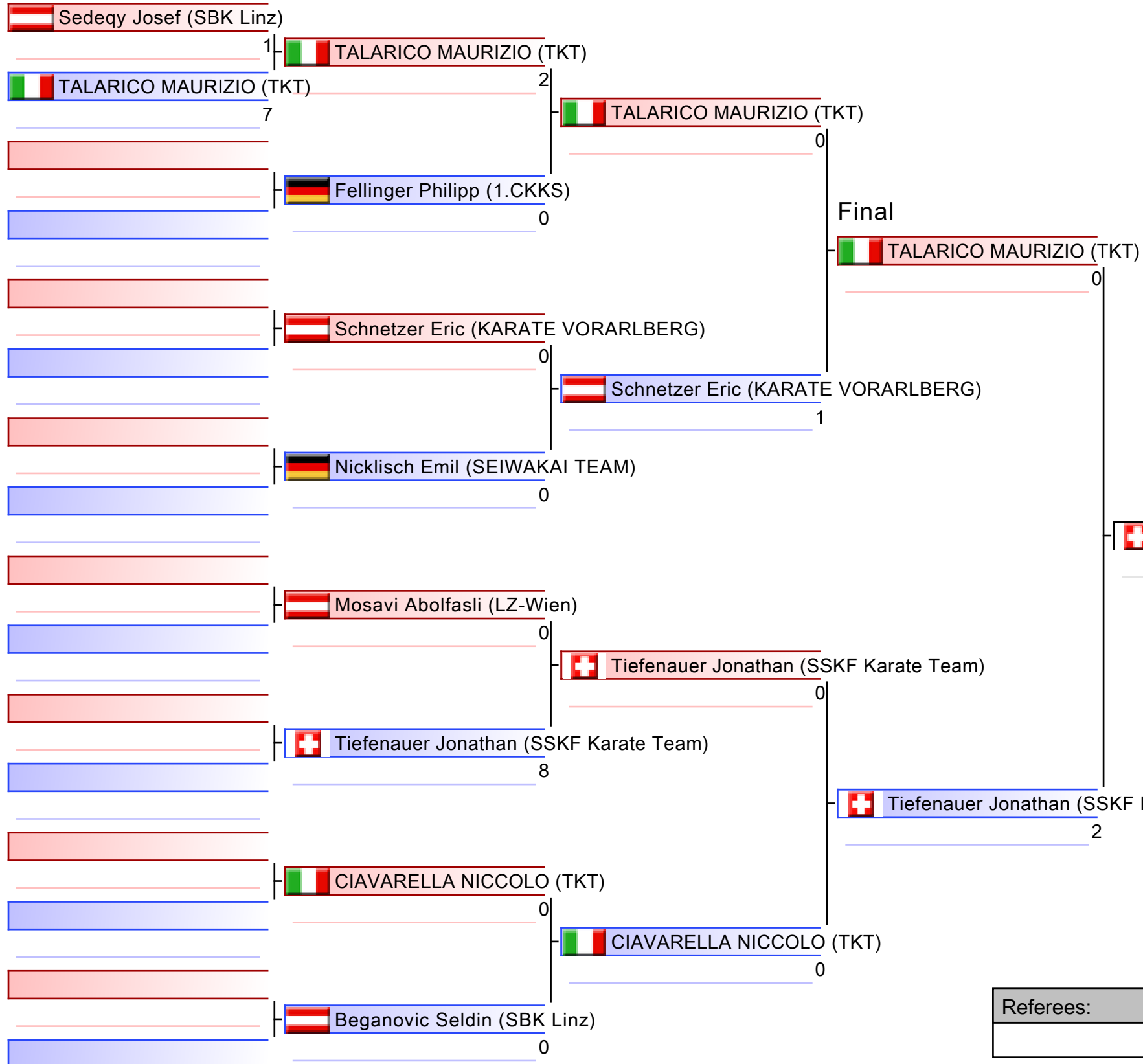

1. TIEFENAUER JONATHAN (SSKF KARATE TEAM)
2. TALARICO MAURIZIO (TKT)
3. MOSAVI ABOLFASLI (LZ-WIEN)
3. SCHNETZER ERIC (KARATE VORARLBERG)
5. CIAVARELLA NICCOLO (TKT)
5. FELLINGER PHILIPP (1.CKKS)
7. SEDEQY JOSEF (SBK LINZ)

Referees:			

# Kumite Individual male U12 +38 kg

AUSTRIAN JUNIOR OPEN 2023

2023-06-24

Tatami  
4 13:45

Pool  
1

(c)sportdata GmbH & Co KG 2000-2023 (2023-06-24 21:05) v 10.0.1 build 1 (2023-05-19 20:00 CET) License: Online\_Event\_ID-6821\_AUSTRIANJUNIOROPEN2023 (expire 2023-07-08)

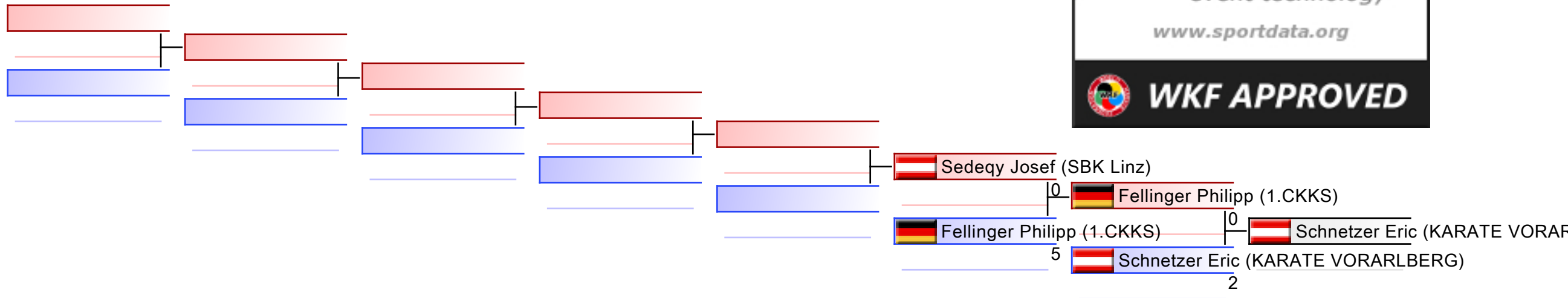

## REPECHAGE: (1)

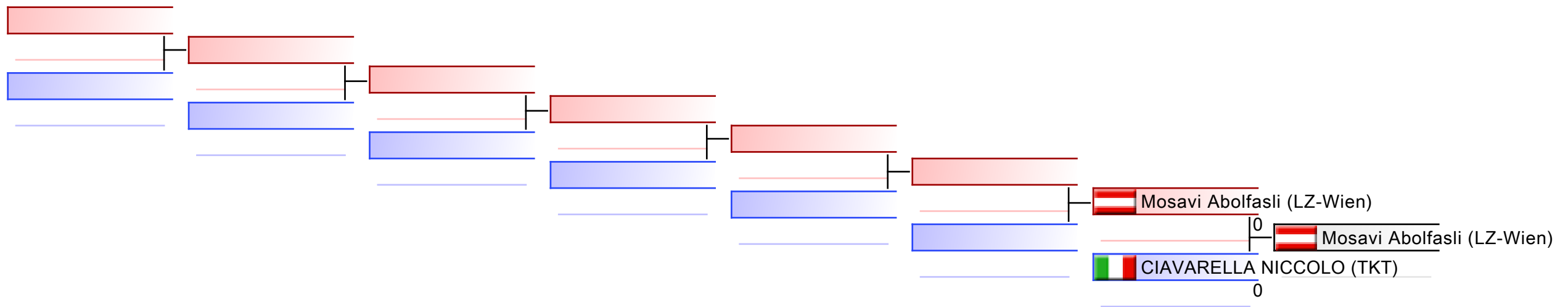

Referees:							
-----------	--	--	--	--	--	--	--

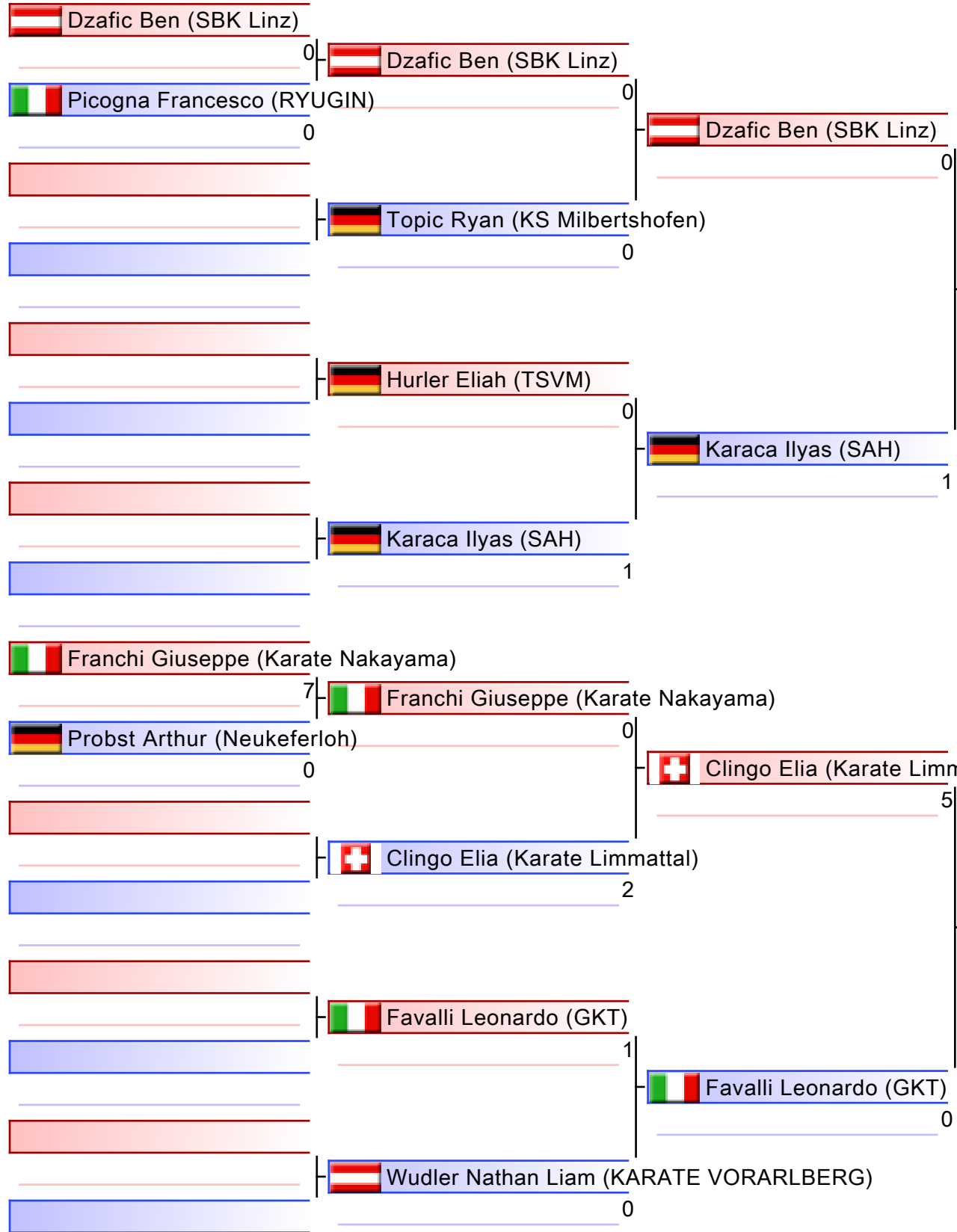

1. KARACA ILYAS (SAH)
2. CLINGO ELIA (KARATE LIMMATTAL)
3. HURLER ELIAH (TSVM)
3. FRANCHI GIUSEPPE (KARATE NAKAYAMA)
5. DZAFIC BEN (SBK LINZ)
5. FAVALLI LEONARDO (GKT)

Referees:			



# Kumite Individual male U12 -32 kg

AUSTRIAN JUNIOR OPEN 2023

2023-06-24

Tatami  
4 14:15

Pool  
1

(c)sportdata GmbH & Co KG 2000-2023 (2023-06-24 21:05) v 10.0.1 build 1 (2023-05-19 20:00 CET) License: Online\_Event\_ID-6821\_AUSTRIANJUNIOROPEN2023 (expire 2023-07-08)

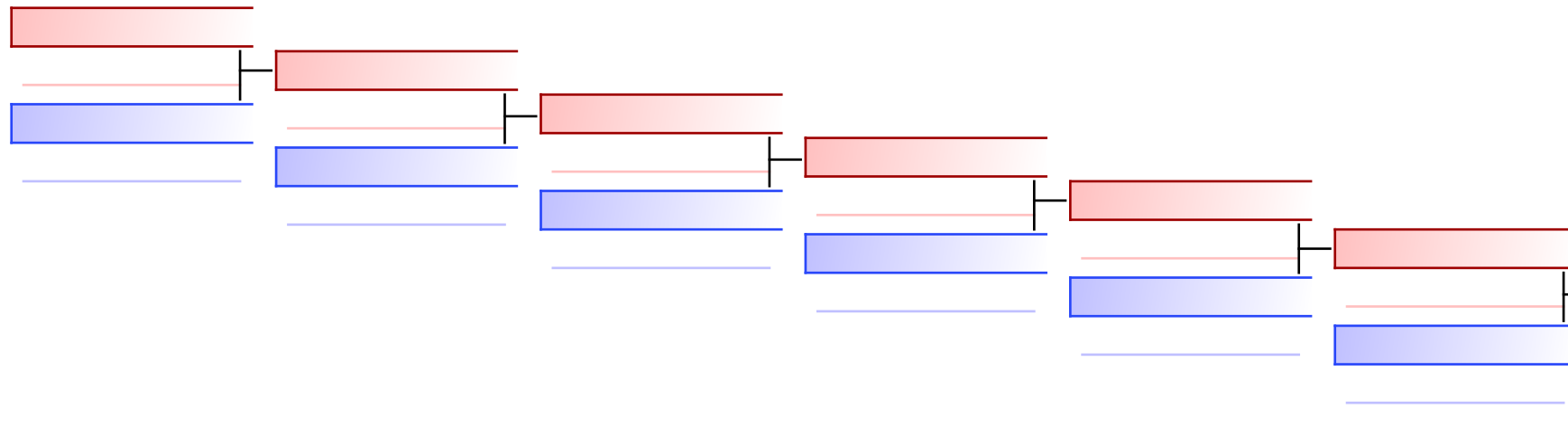

Hurler Eliah (TSVM) 3  
 Dzafic Ben (SBK Linz) 0

## REPECHAGE: (1)

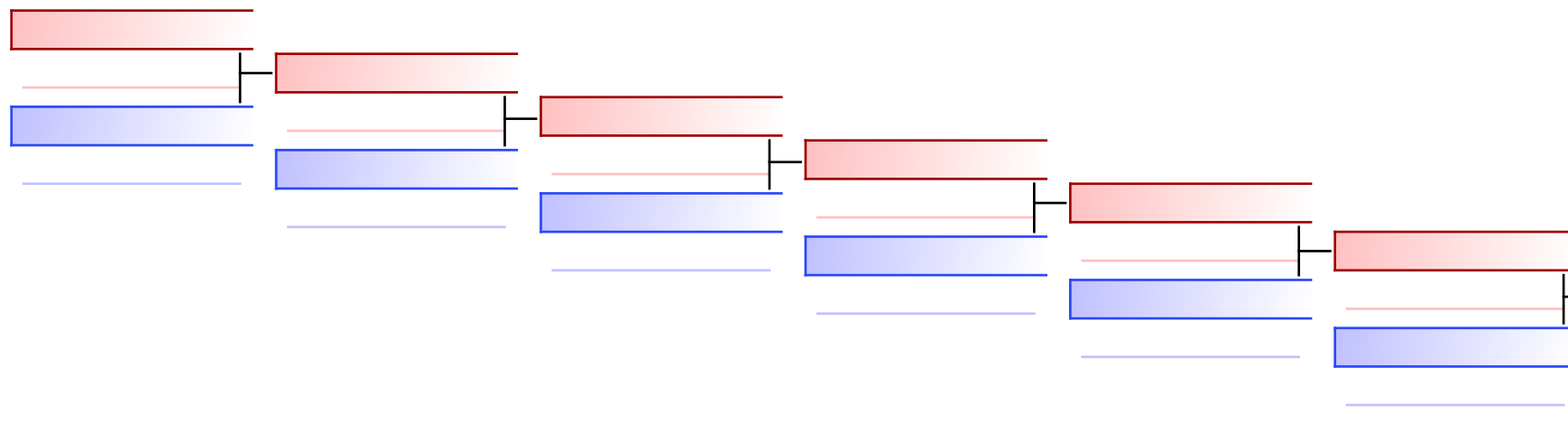

Franchi Giuseppe (Karate Nakayama) 3  
 Favalli Leonardo (GKT) 2

Referees:							
-----------	--	--	--	--	--	--	--

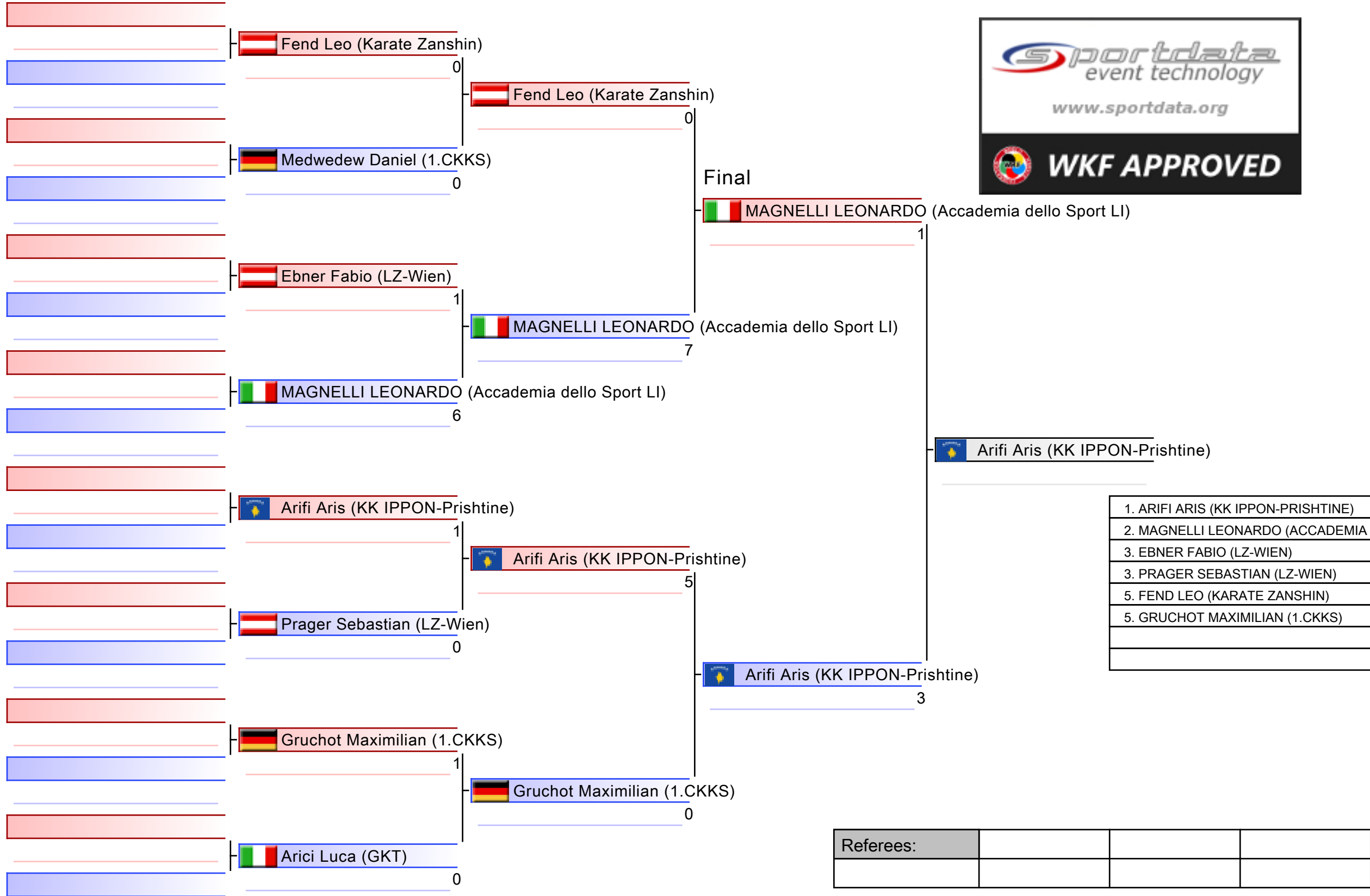

# Kumite Individual male U12 -38 kg

AUSTRIAN JUNIOR OPEN 2023

2023-06-24

Tatami  
4 14:50

Pool  
1

(c)sportdata GmbH & Co KG 2000-2023 (2023-06-24 21:05) v 10.0.1 build 1 (2023-05-19 20:00 CET) License: Online\_Event\_ID-6821\_AUSTRIANJUNIOROPEN2023 (expire 2023-07-08)

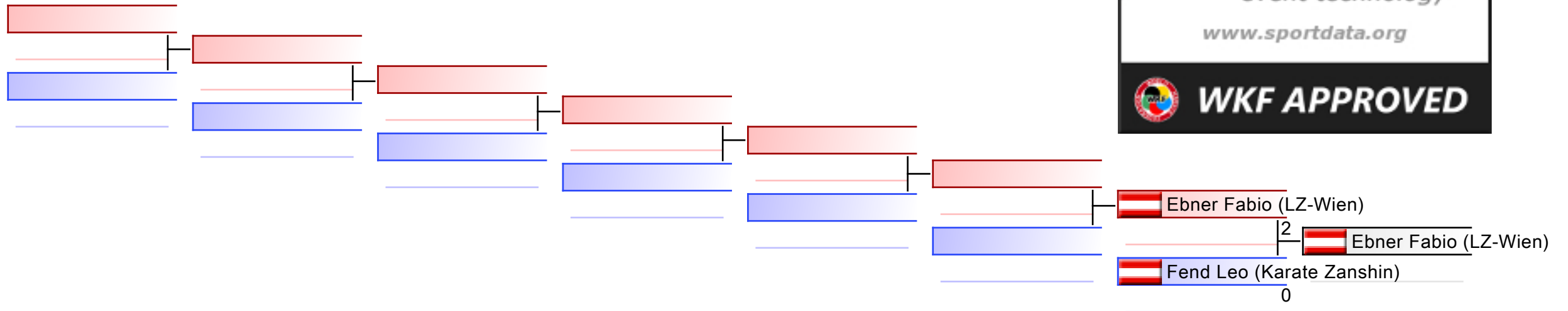

## REPECHAGE: (1)

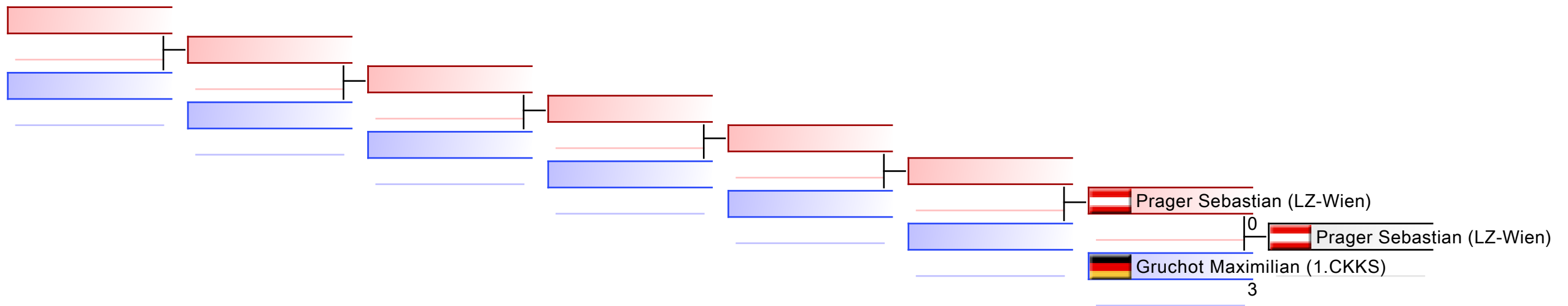

Referees:							
-----------	--	--	--	--	--	--	--

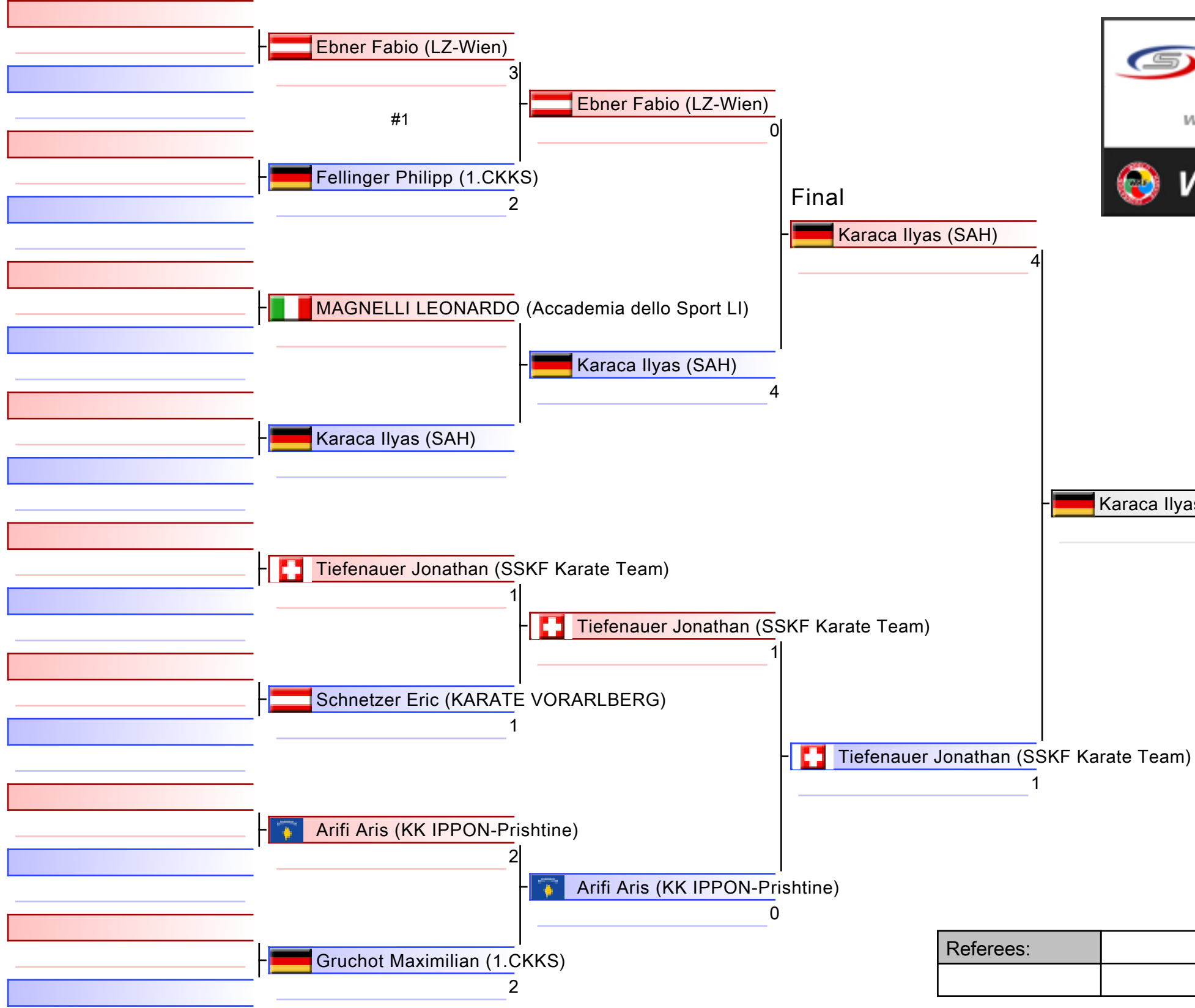

1. KARACA ILYAS (SAH)
2. TIEFENAUER JONATHAN (SSKF KARATE TEAM)
3. EBNER FABIO (LZ-WIEN)
3. ARIFI ARIS (KK IPPON-PRISHTINE)
5. MAGNELLI LEONARDO (ACCADEMIA DELLO SP)
5. SCHNETZER ERIC (KARATE VORARLBERG)
5. FELLINGER PHILIPP (1.CKKS)
5. GRUCHOT MAXIMILIAN (1.CKKS)

Referees:			

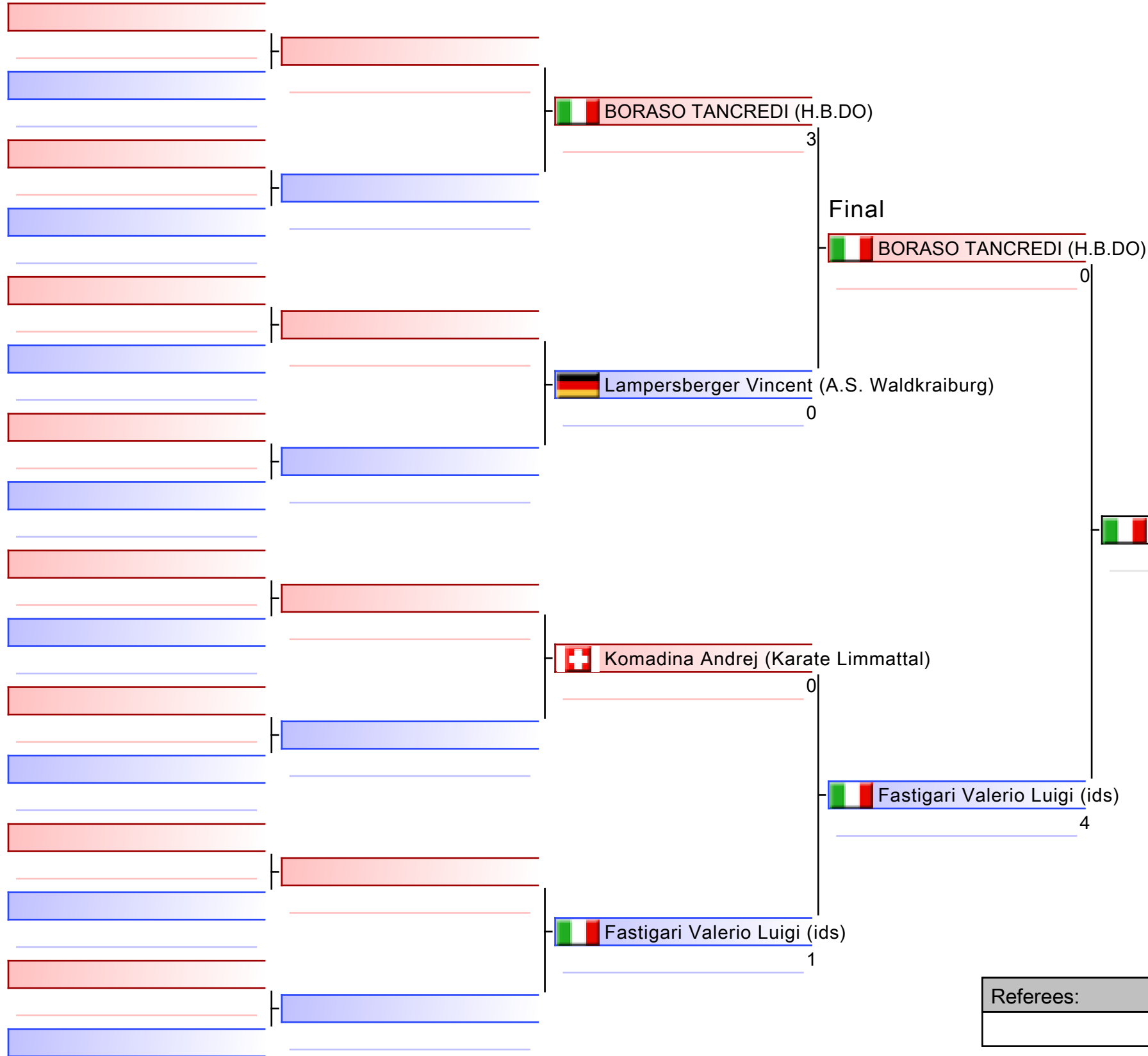

1. FASTIGARI VALERIO LUIGI (IDS)
2. BORASO TANCREDI (H.B.DO)
3. LAMPERSBERGER VINCENT (A.S. WALDKRAIBURG)
3. KOMADINA ANDREJ (KARATE LIMMATTAL)

Referees:			

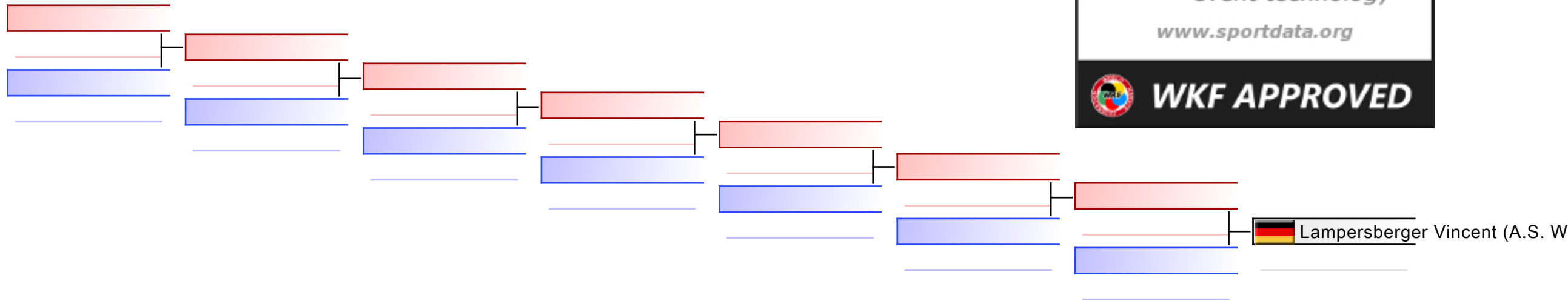

REPECHAGE: (1)

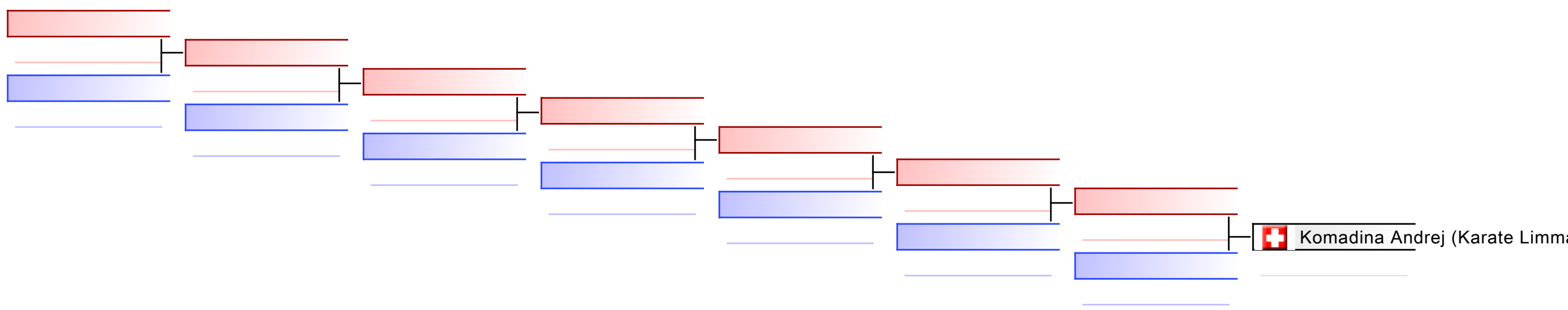

Referees:							
-----------	--	--	--	--	--	--	--

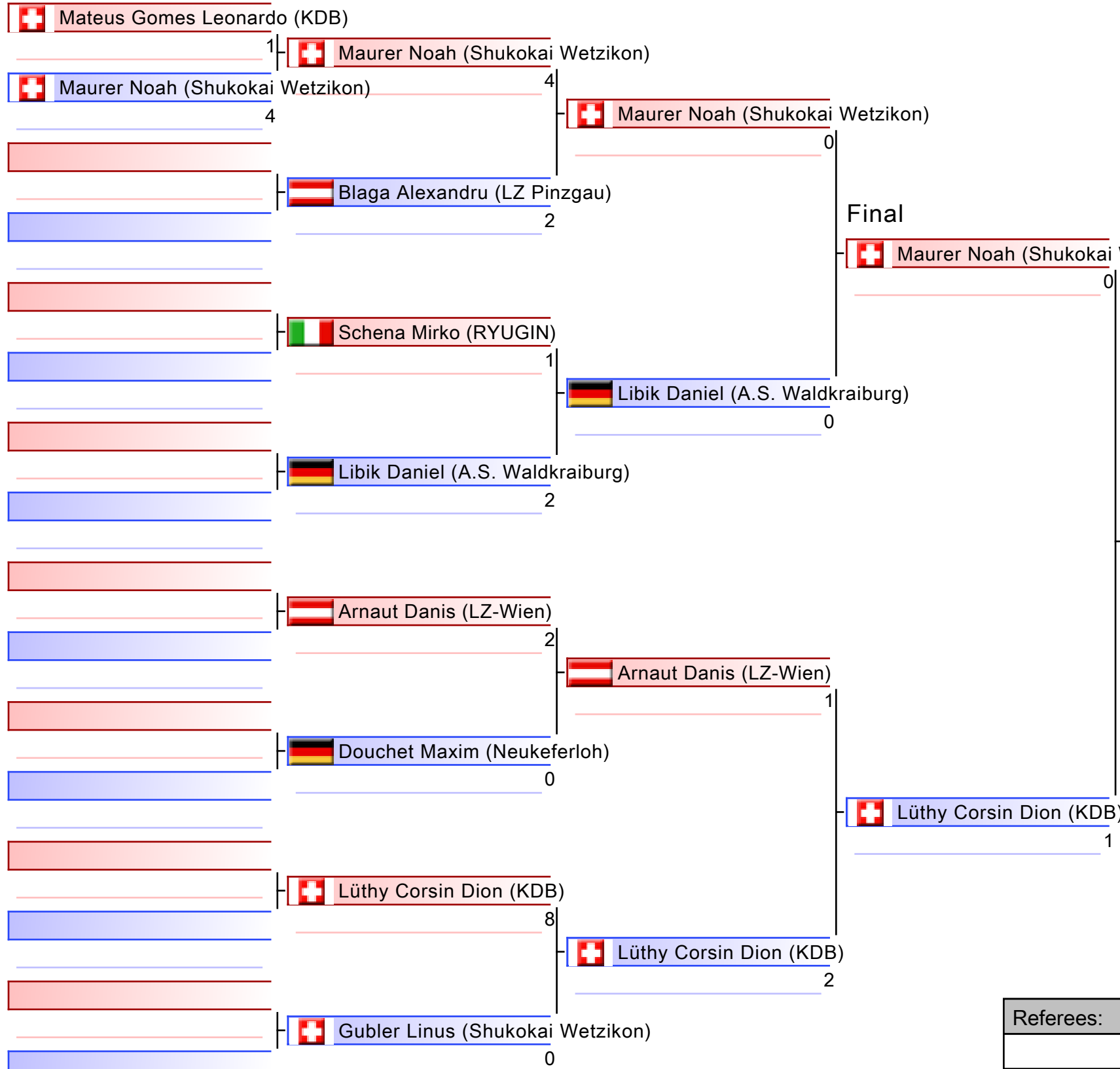

1. MAURER NOAH (SHUKOKAI WETZIKON)
2. LÜTHY CORSIN DION (KDB)
3. ARNAUT DANIS (LZ-WIEN)
3. LIBIK DANIEL (A.S. WALDKRAIBURG)
5. GUBLER LINUS (SHUKOKAI WETZIKON)
5. MATEUS GOMES LEONARDO (KDB)
7. BLAGA ALEXANDRU (LZ PINZGAU)

Referees:			

# Kumite Individual male U14 -40 kg

AUSTRIAN JUNIOR OPEN 2023

2023-06-24

Tatami  
2 15:25

Pool  
1

(c)sportdata GmbH & Co KG 2000-2023 (2023-06-24 21:05) v 10.0.1 build 1 (2023-05-19 20:00 CET) License: Online\_Event\_ID-6821\_AUSTRIANJUNIOROPEN2023 (expire 2023-07-08)

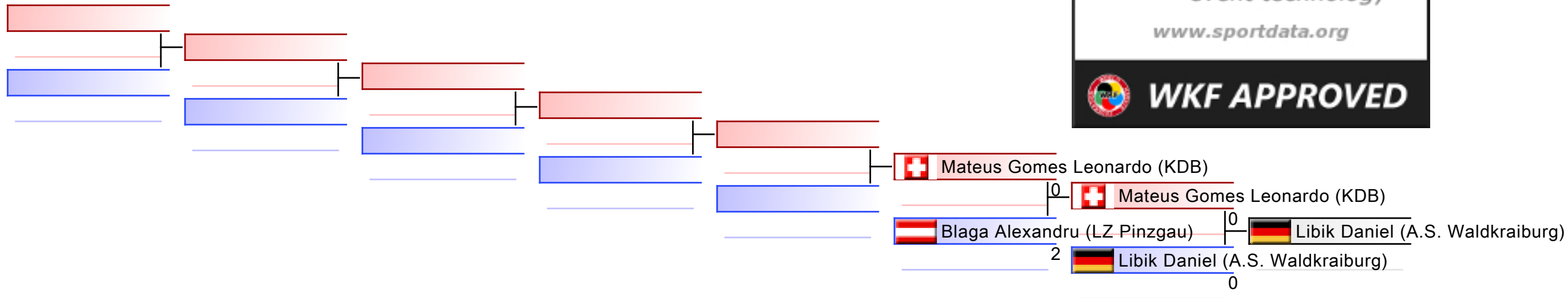

## REPECHAGE: (1)

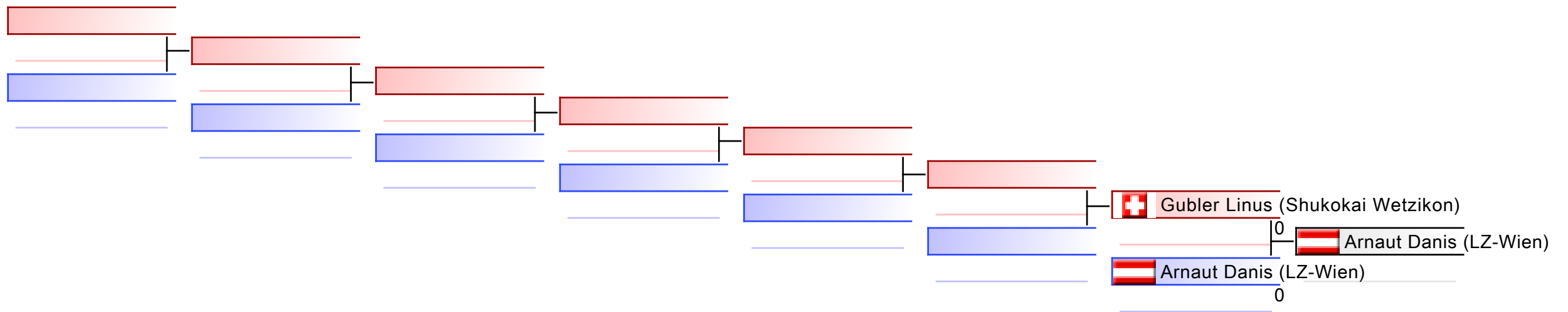

Referees:							
-----------	--	--	--	--	--	--	--



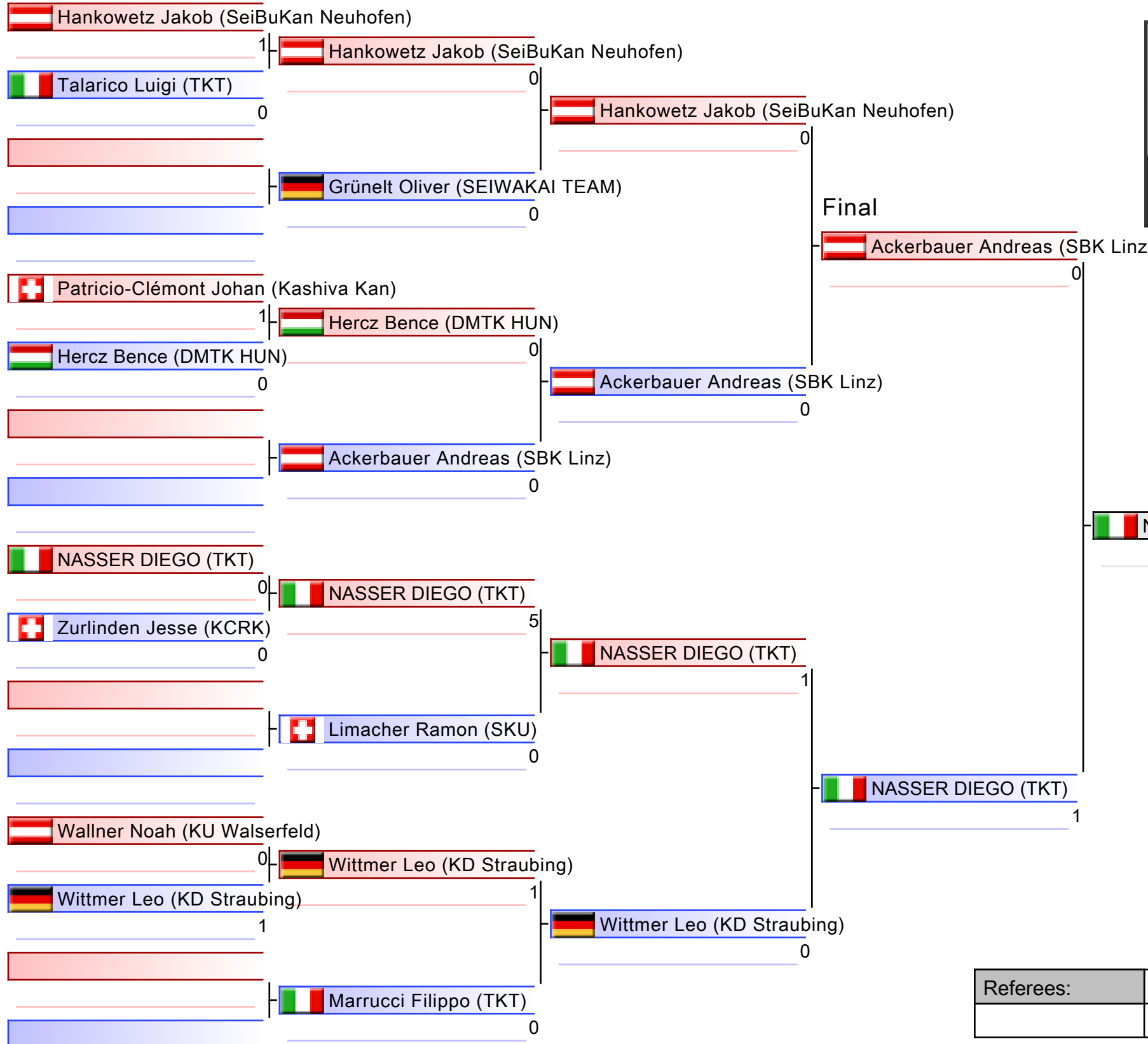

1. NASSER DIEGO (TKT)
2. ACKERBAUER ANDREAS (SBK LINZ)
3. HANKOWETZ JAKOB (SEIBUKAN NEUHOFFEN)
3. ZURLINDEN JESSE (KCRK)
5. HERCZ BENCE (DMTK HUN)
5. WITTMER LEO (KD STRAUBING)
7. LIMACHER RAMON (SKU)

Referees:			

# Kumite Individual male U14 -45 kg

AUSTRIAN JUNIOR OPEN 2023

2023-06-24

Tatami  
2 16:10

Pool  
1

(c)sportdata GmbH & Co KG 2000-2023 (2023-06-24 21:05) v 10.0.1 build 1 (2023-05-19 20:00 CET) License: Online\_Event\_ID-6821\_AUSTRIANJUNIOROPEN2023 (expire 2023-07-08)

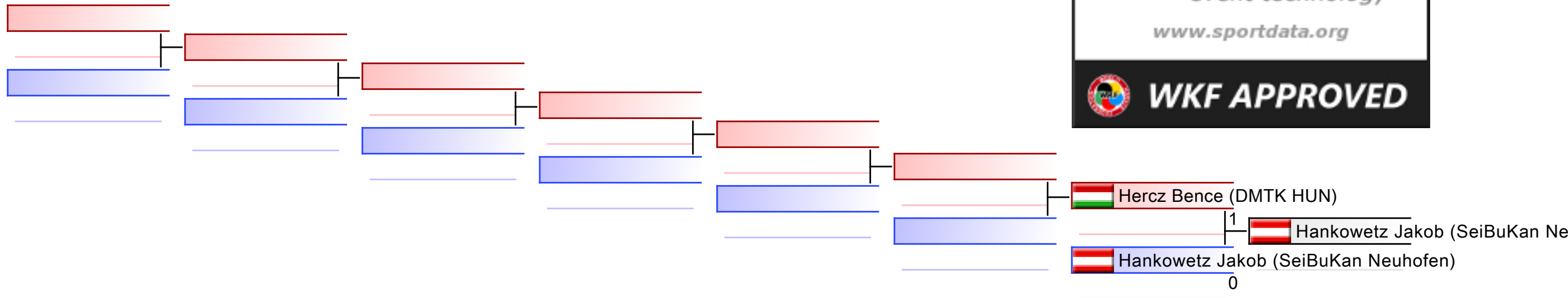

## REPECHAGE: (1)

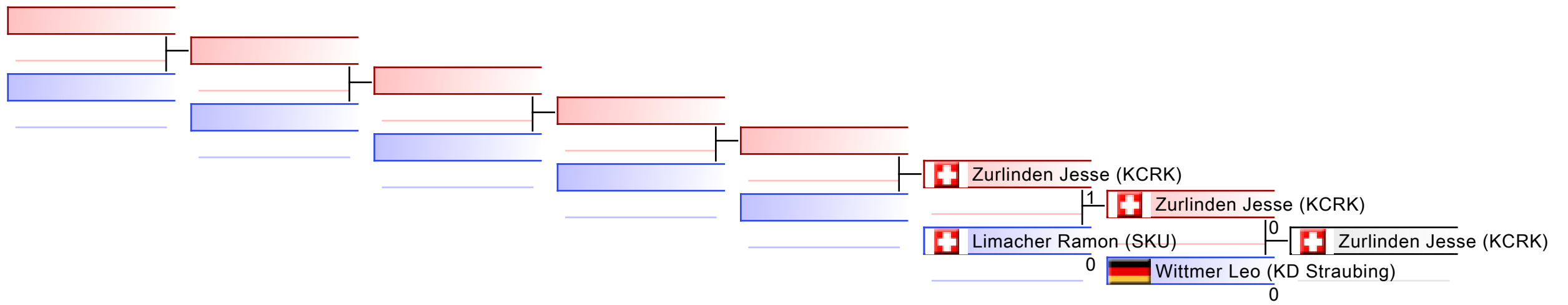

Referees:							
-----------	--	--	--	--	--	--	--

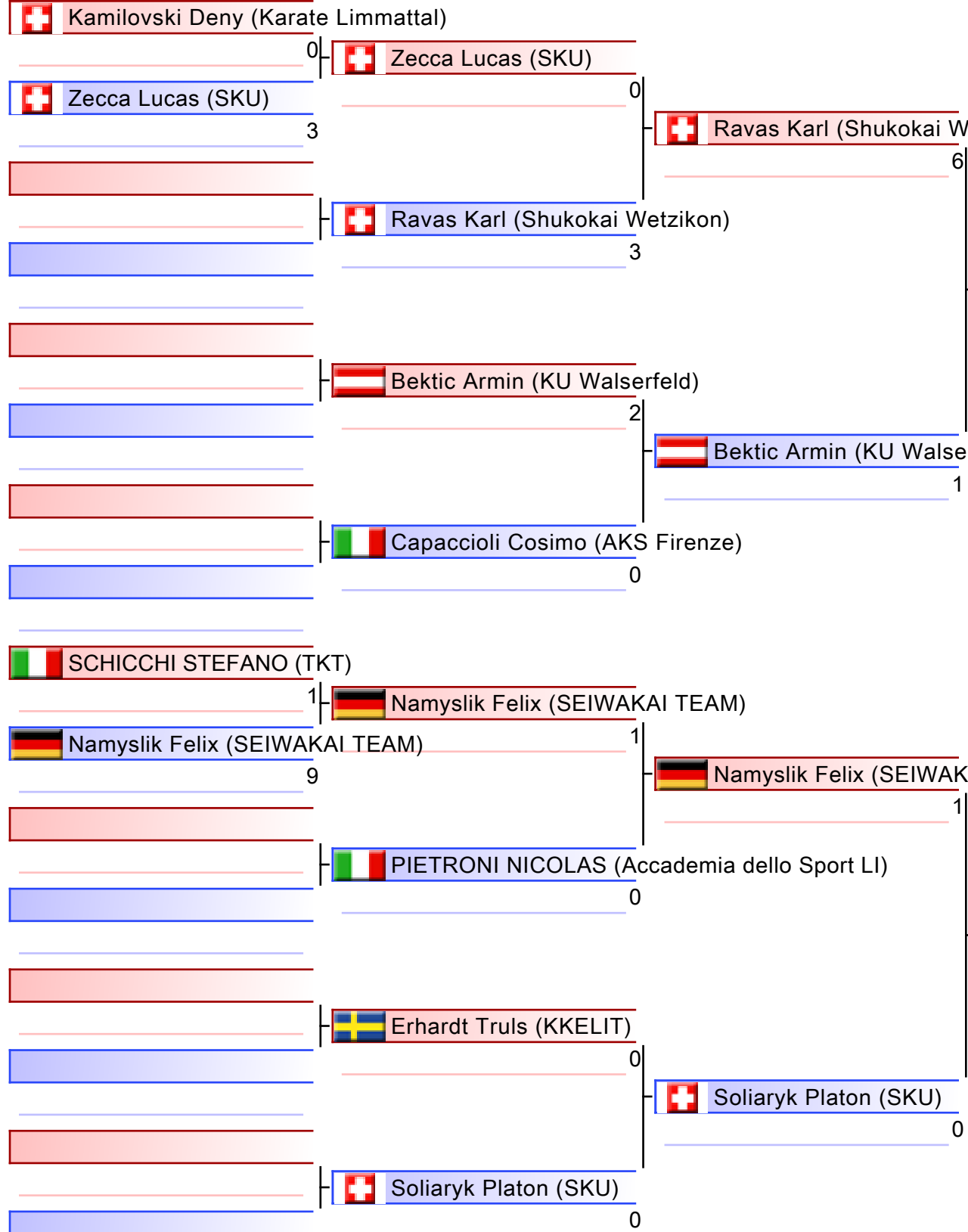

1. RAVAS KARL (SHUKOKAI WETZIKON)
2. NAMYSLIK FELIX (SEIWAKAI TEAM)
3. ZECCA LUCAS (SKU)
3. SOLIARYK PLATON (SKU)
5. BEKTIC ARMIN (KU WALSERFELD)
5. SCHICCHI STEFANO (TKT)
7. PIETRONI NICOLAS (ACCADEMIA DELLO SPORT LI)

Referees:			

# Kumite Individual male U14 -50 kg

AUSTRIAN JUNIOR OPEN 2023

2023-06-24

Tatami  
2 17:05

Pool  
1

(c)sportdata GmbH & Co KG 2000-2023 (2023-06-24 21:05) v 10.0.1 build 1 (2023-05-19 20:00 CET) License: Online\_Event\_ID-6821\_AUSTRIANJUNIOROPEN2023 (expire 2023-07-08)

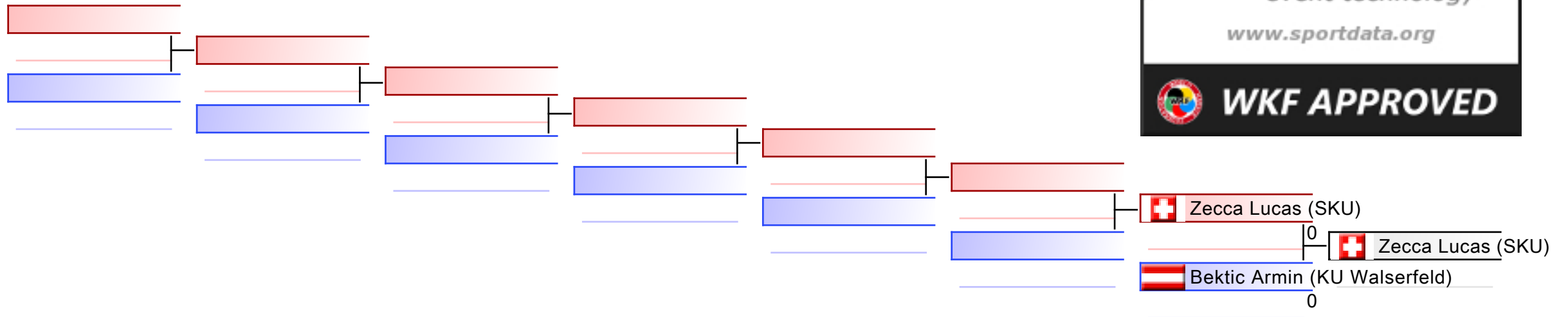

## REPECHAGE: (1)

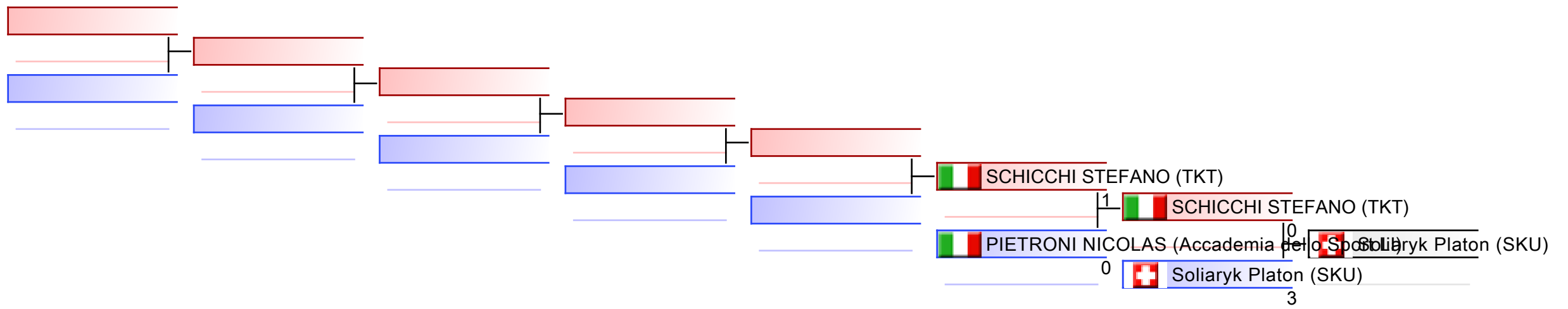

Referees:							
-----------	--	--	--	--	--	--	--

# Kumite Individual male U14 -55 kg

AUSTRIAN JUNIOR OPEN 2023, Schulstrasse 17, 5071 Wals, AUT

2023-06-24

Tatami  
3 16:15

Pool  
1/1

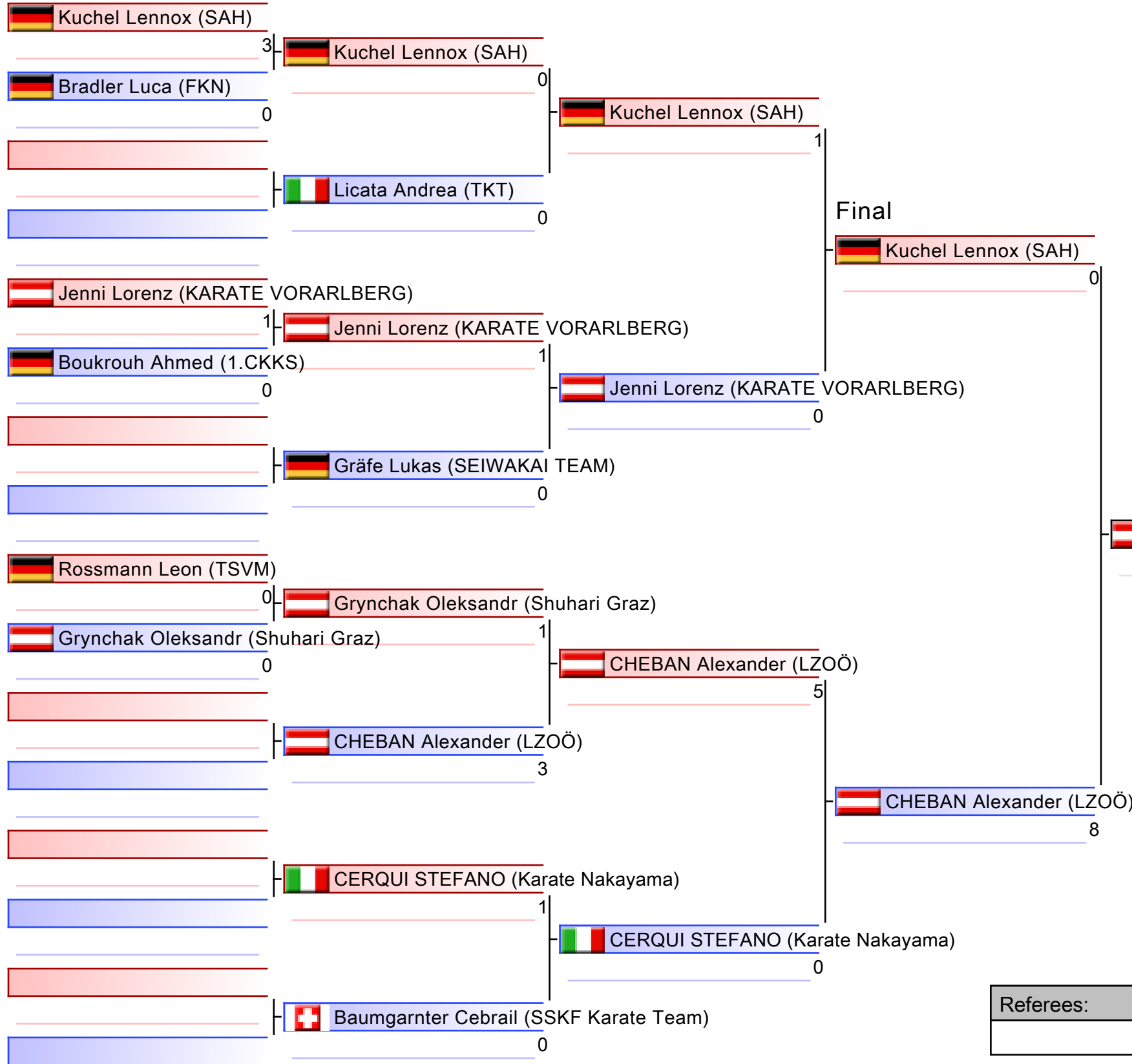

1. CHEBAN ALEXANDER (LZOÖ)
2. KUCHEL LENNOX (SAH)
3. CERQUI STEFANO (KARATE NAKAYAMA)
3. JENNI LORENZ (KARATE VORARLBERG)
5. GRYNCHAK OLEKSANDR (SHUHARI GRAZ)
5. BRADLER LUCA (FKN)
7. LICATA ANDREA (TKT)

Referees:			

# Kumite Individual male U14 -55 kg

AUSTRIAN JUNIOR OPEN 2023

2023-06-24

Tatami  
3 16:15

Pool  
1

(c)sportdata GmbH & Co KG 2000-2023 (2023-06-24 21:05) v 10.0.1 build 1 (2023-05-19 20:00 CET) License: Online\_Event\_ID-6821\_AUSTRIANJUNIOROPEN2023 (expire 2023-07-08)

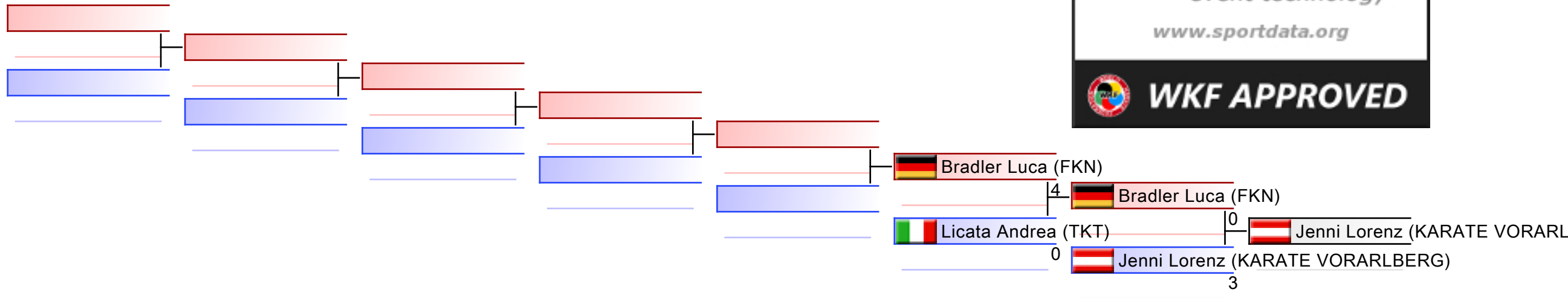

## REPECHAGE: (1)

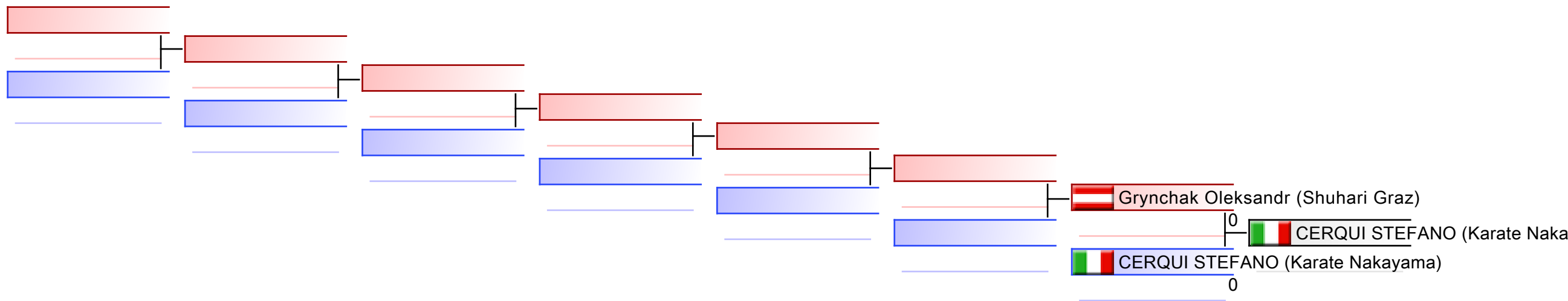

Referees:							
-----------	--	--	--	--	--	--	--

# Kumite Individual male U14 Open

AUSTRIAN JUNIOR OPEN 2023, Schulstrasse 17, 5071 Wals, AUT

2023-06-24

Tatami 6 18:00

Pool 1/1

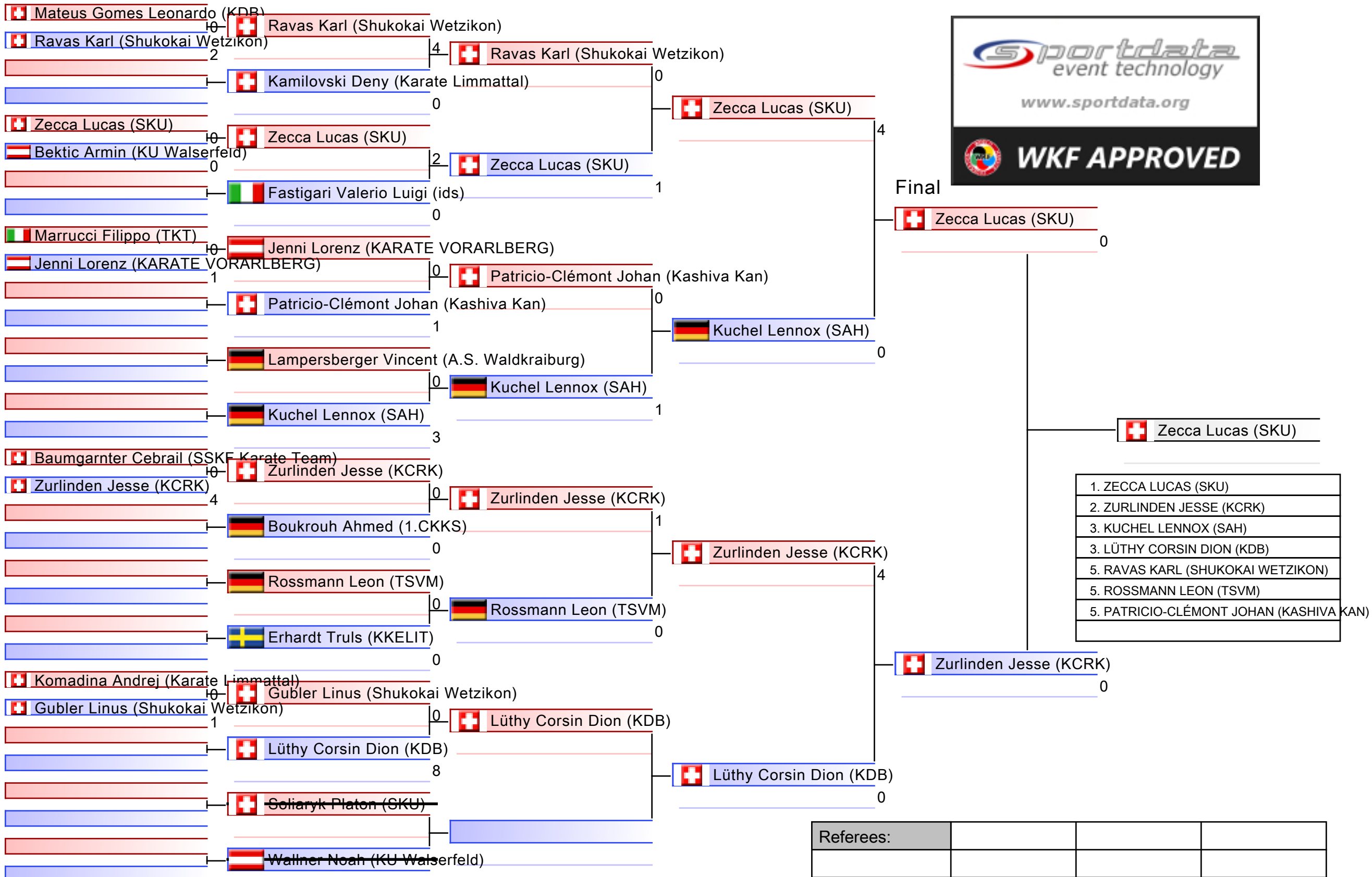

Referees:			

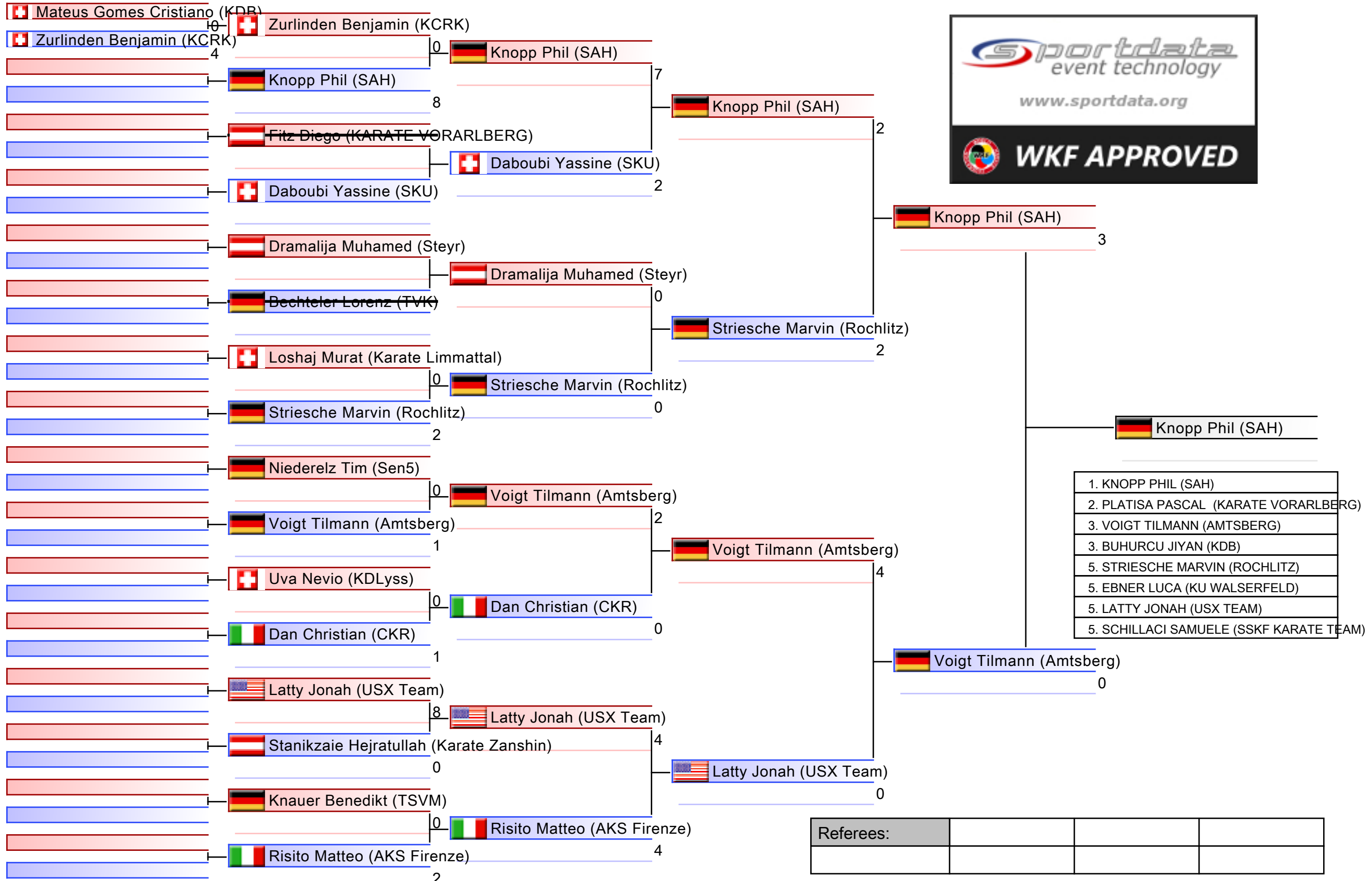

Referees:			



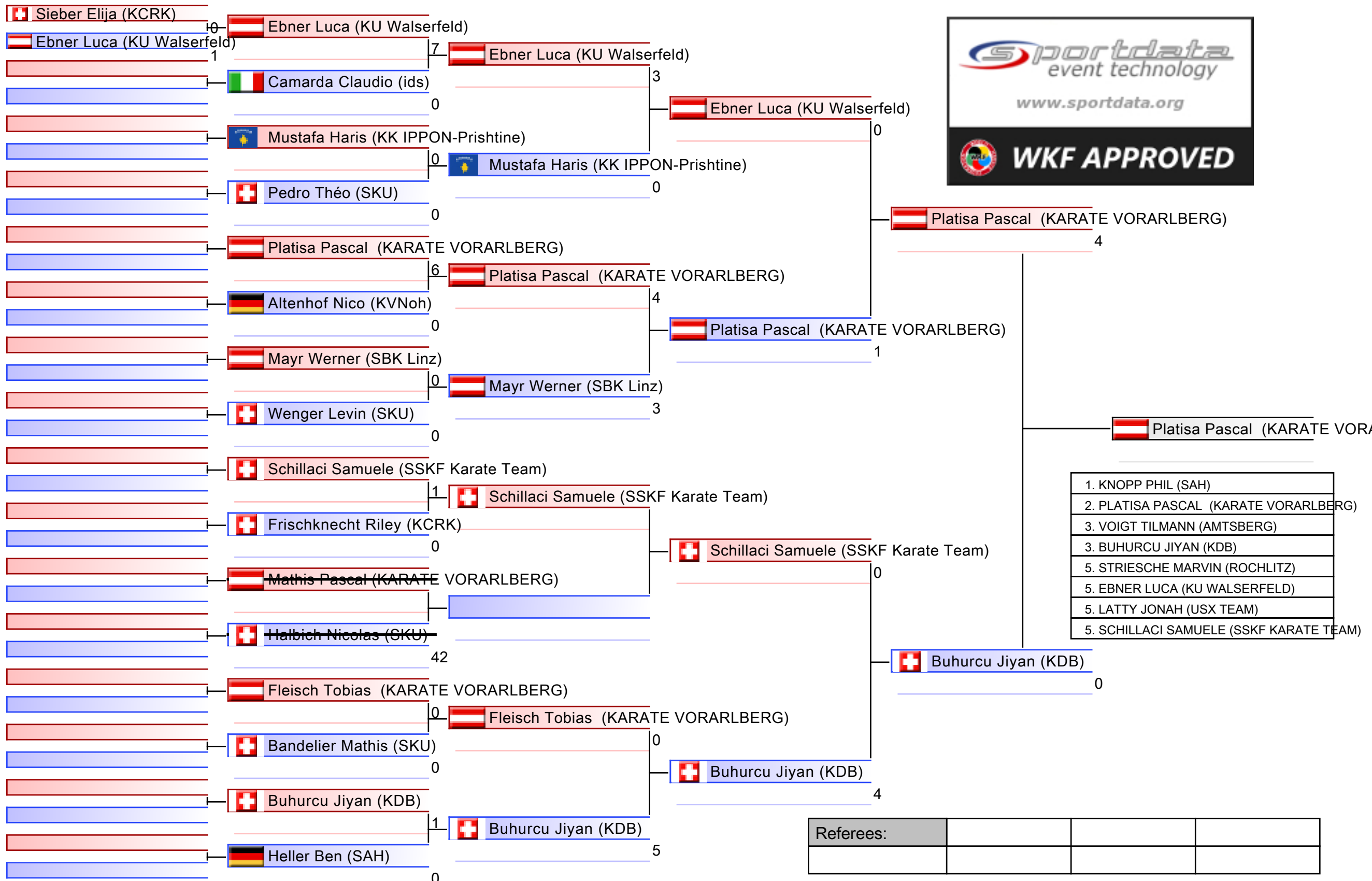

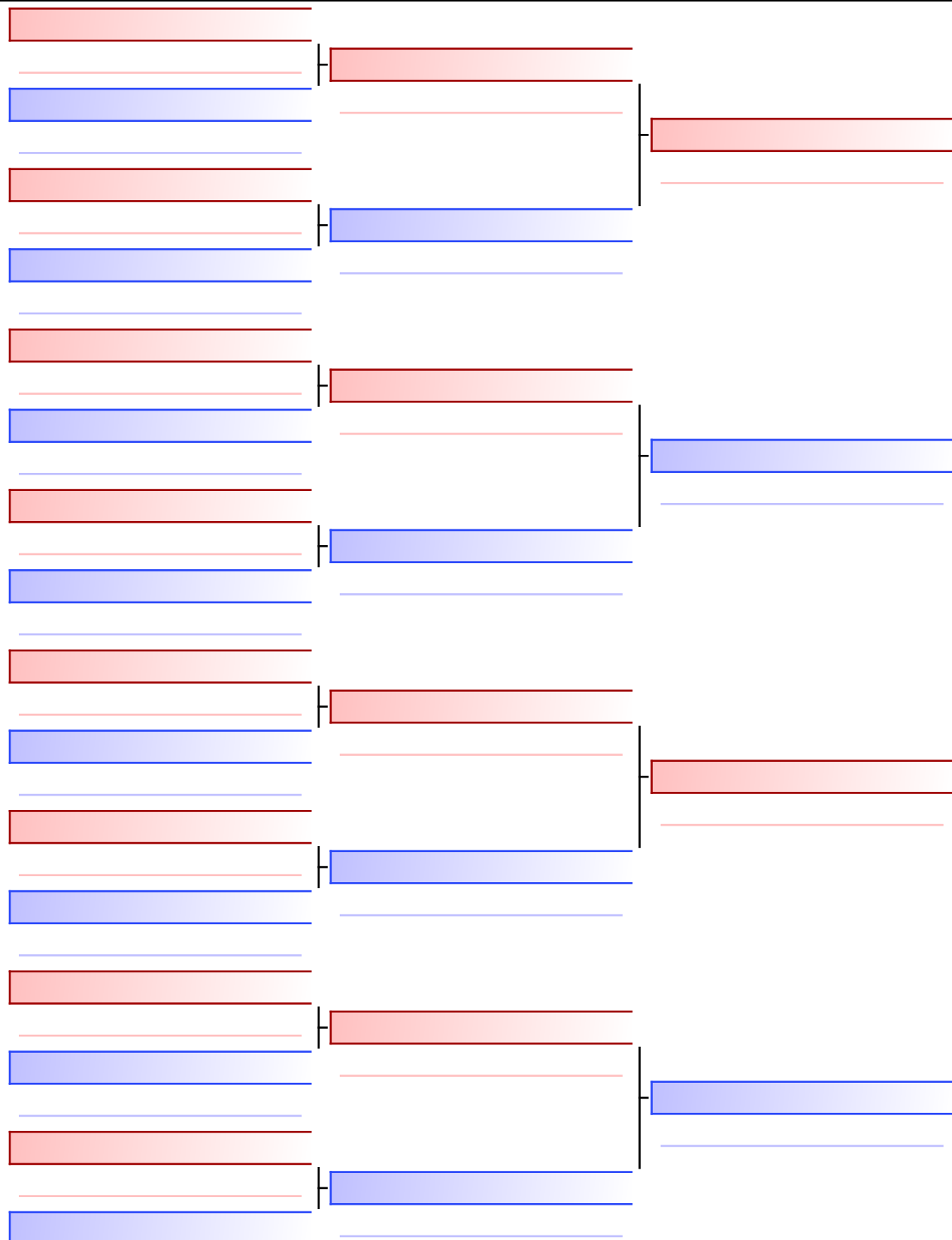

Final

 Knopp Phil (SAH)

9

 Knopp Phil (SAH)

 Platisa Pascal (KARATE VORARLBERG)

2



- |   |
|---|
| 1. KNOPP PHIL (SAH)                     |
| 2. PLATISA PASCAL (KARATE VORARLBERG)   |
| 3. VOIGT TILMANN (AMTSBERG)             |
| 3. BUHURCU JIYAN (KDB)                  |
| 5. STRIESCHE MARVIN (ROCHLITZ)          |
| 5. EBNER LUCA (KU WALSERFELD)           |
| 5. LATTY JONAH (USX TEAM)               |
| 5. SCHILLACI SAMUELE (SSKF KARATE TEAM) |

Referees:			

# Kumite Individual male U18 Open

AUSTRIAN JUNIOR OPEN 2023, Schulstrasse 17, 5071 Wals, AUT

2023-06-24

Tatami  
3 19:55

Pool  
1/2

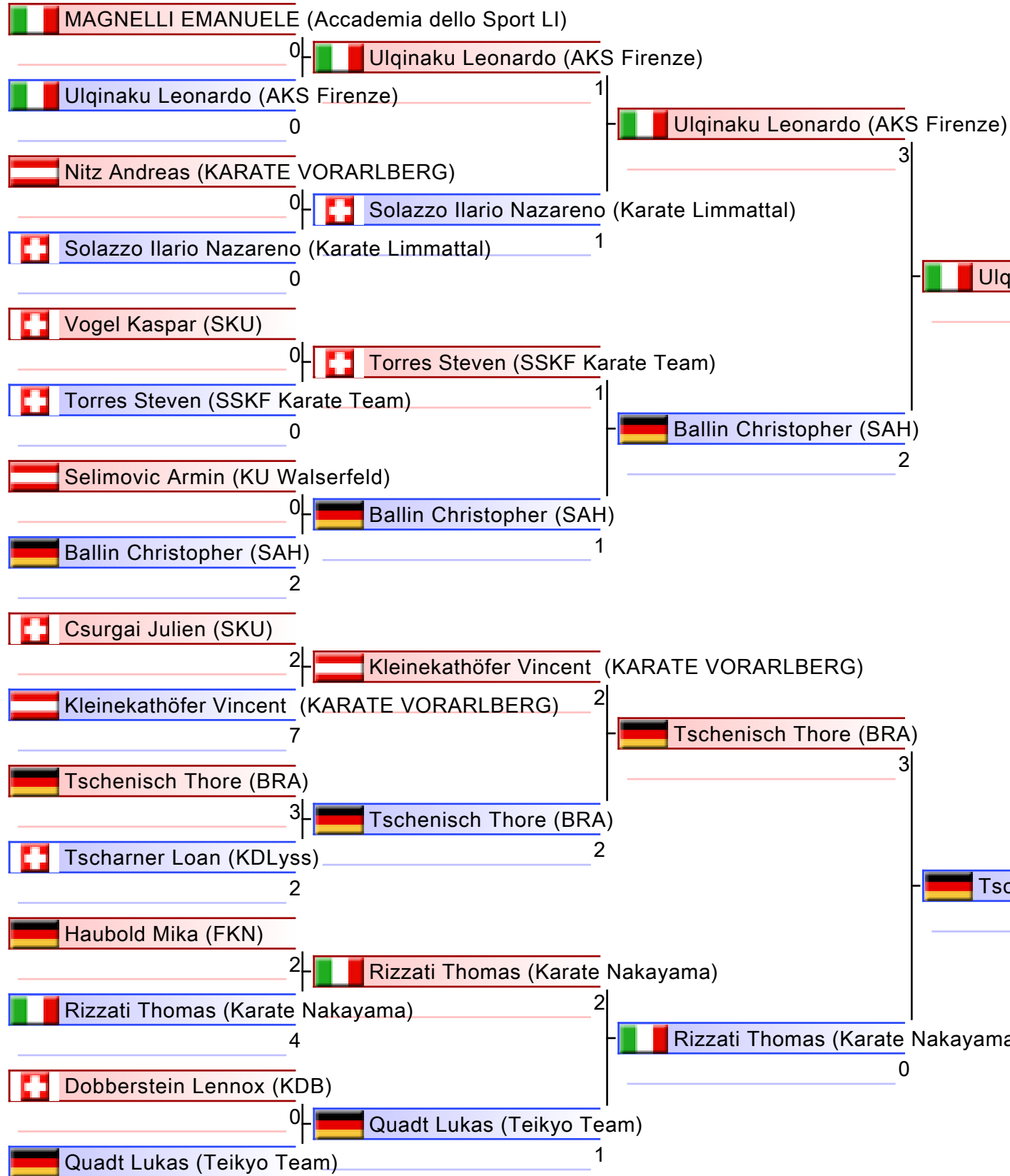

1. JOST RUBEN (KDLySS)
2. TSCHENISCH THORE (BRA)
3. ULQINAKU LEONARDO (AKS FIRENZE)
3. PEZZEI FABIAN (KARATE MÜHLBACH)
5. LORENZ SWAN (SKU)
5. RIZZATI THOMAS (KARATE NAKAYAMA)
5. BALLIN CHRISTOPHER (SAH)
5. KLEINEKATHÖFER JAKOB (KARATE VORARLBERG)

Referees:			

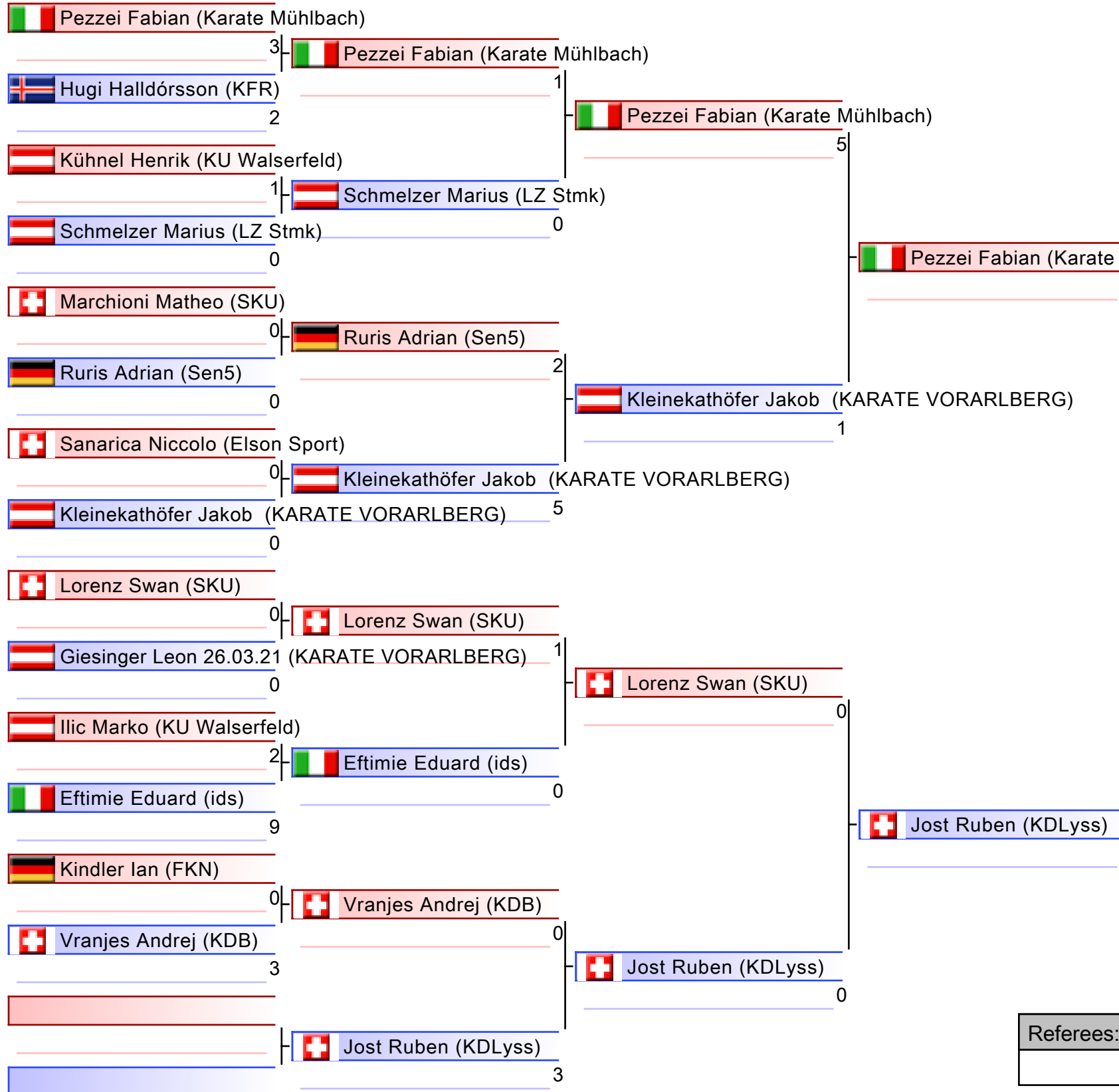

1. JOST RUBEN (KDLyss)
2. TSCHENISCH THORE (BRA)
3. ULQINAKU LEONARDO (AKS FIRENZE)
3. PEZZEI FABIAN (KARATE MÜHLBACH)
5. LORENZ SWAN (SKU)
5. RIZZATI THOMAS (KARATE NAKAYAMA)
5. BALLIN CHRISTOPHER (SAH)
5. KLEINEKATHÖFER JAKOB (KARATE VORARLBERG)

Referees:			

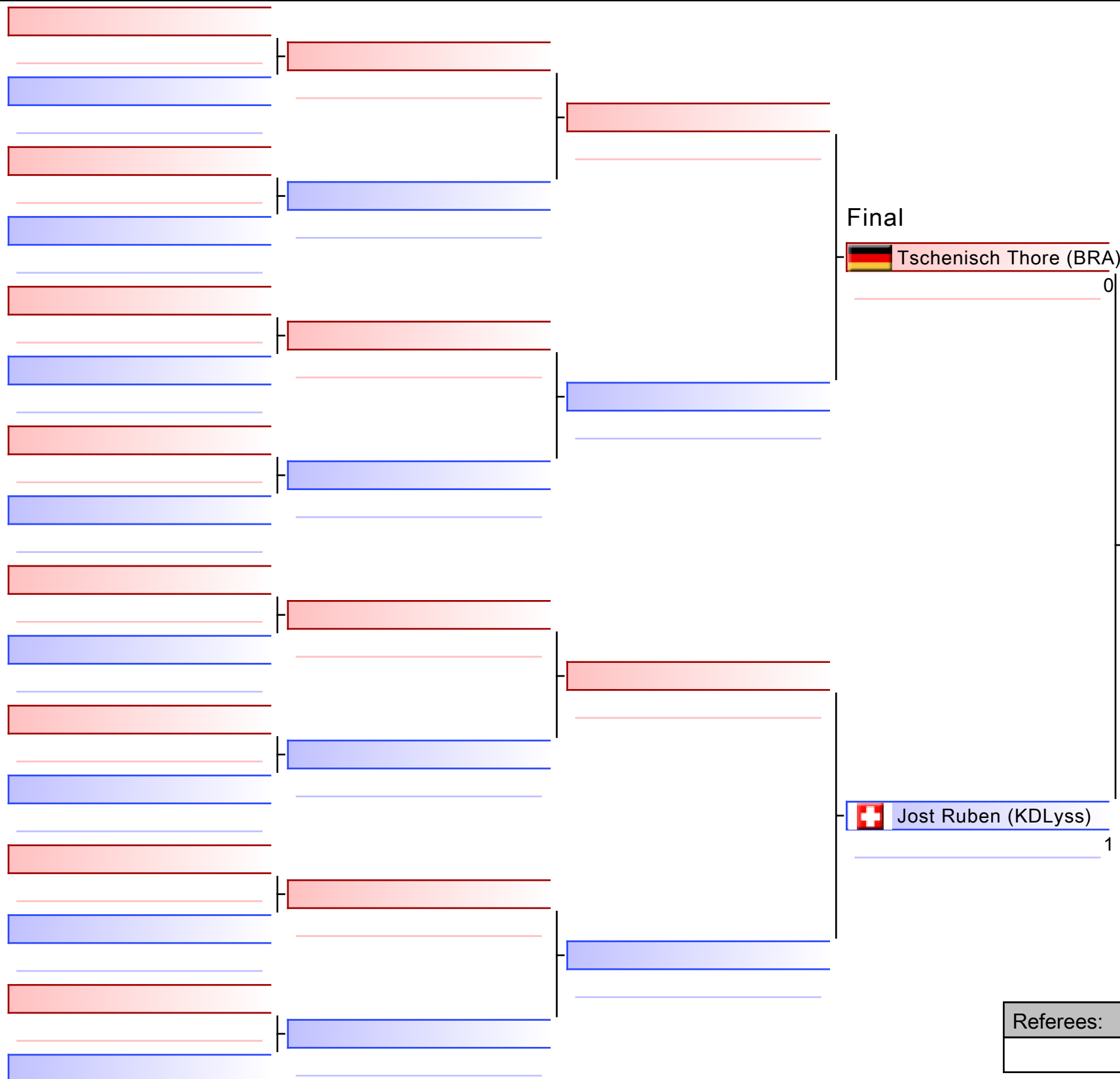

Jost Ruben (KDLyss)

- |  |
|--|
| 1. JOST RUBEN (KDLyss)                   |
| 2. TSCHENISCH THORE (BRA)                |
| 3. ULQINAKU LEONARDO (AKS FIRENZE)       |
| 3. PEZZEI FABIAN (KARATE MÜHLBACH)       |
| 5. LORENZ SWAN (SKU)                     |
| 5. RIZZATI THOMAS (KARATE NAKAYAMA)      |
| 5. BALLIN CHRISTOPHER (SAH)              |
| 5. KLEINEKATHÖFER JAKOB (KARATE VÖRARLE) |

Referees:			

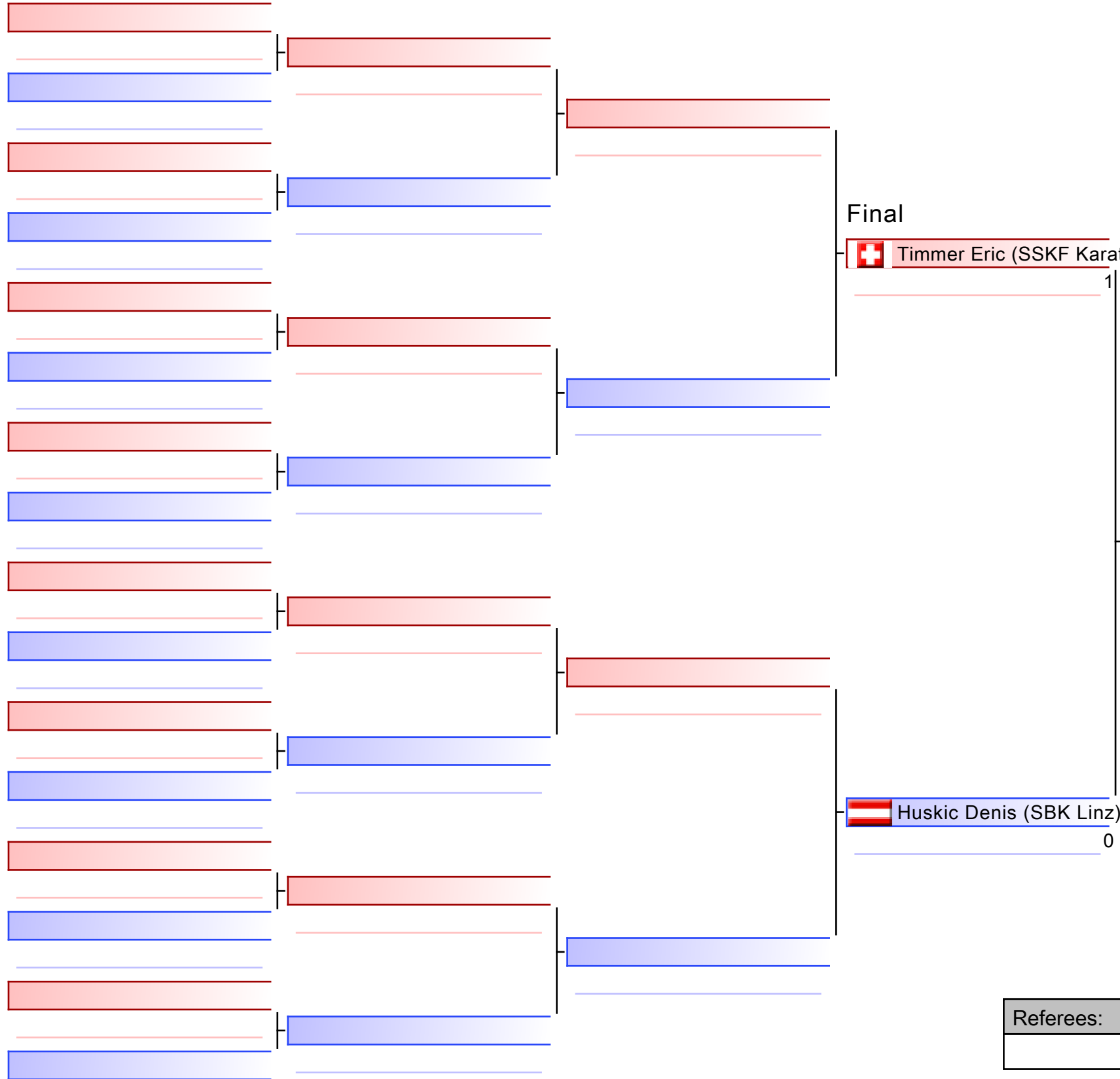

Final

Timmer Eric (SSKF Karate Team)

1

Timmer Eric (SSKF Karate Team)

Huskic Denis (SBK Linz)

0

1. TIMMER ERIC (SSKF KARATE TEAM)
2. HUSKIC DENIS (SBK LINZ)

Referees:			

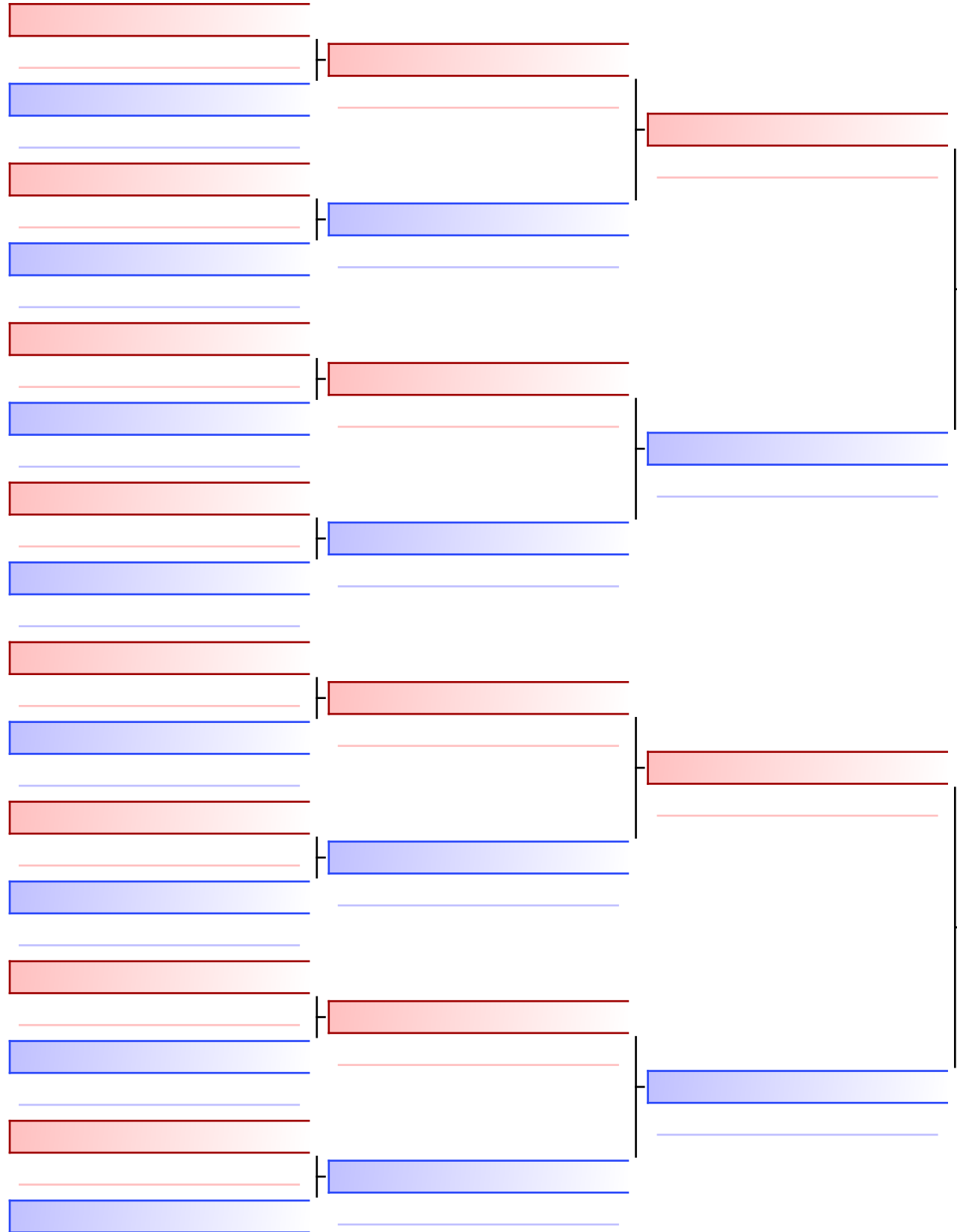

Final

Baranyi Barnabas (KDB)  
3

Baranyi Barnabas (KDB)

Böhler Yannick (KARATE VORARLBERG)  
0

1. BARANYI BARNABAS (KDB)
2. BÖHLER YANNICK (KARATE VORARLBERG)

Referees:			

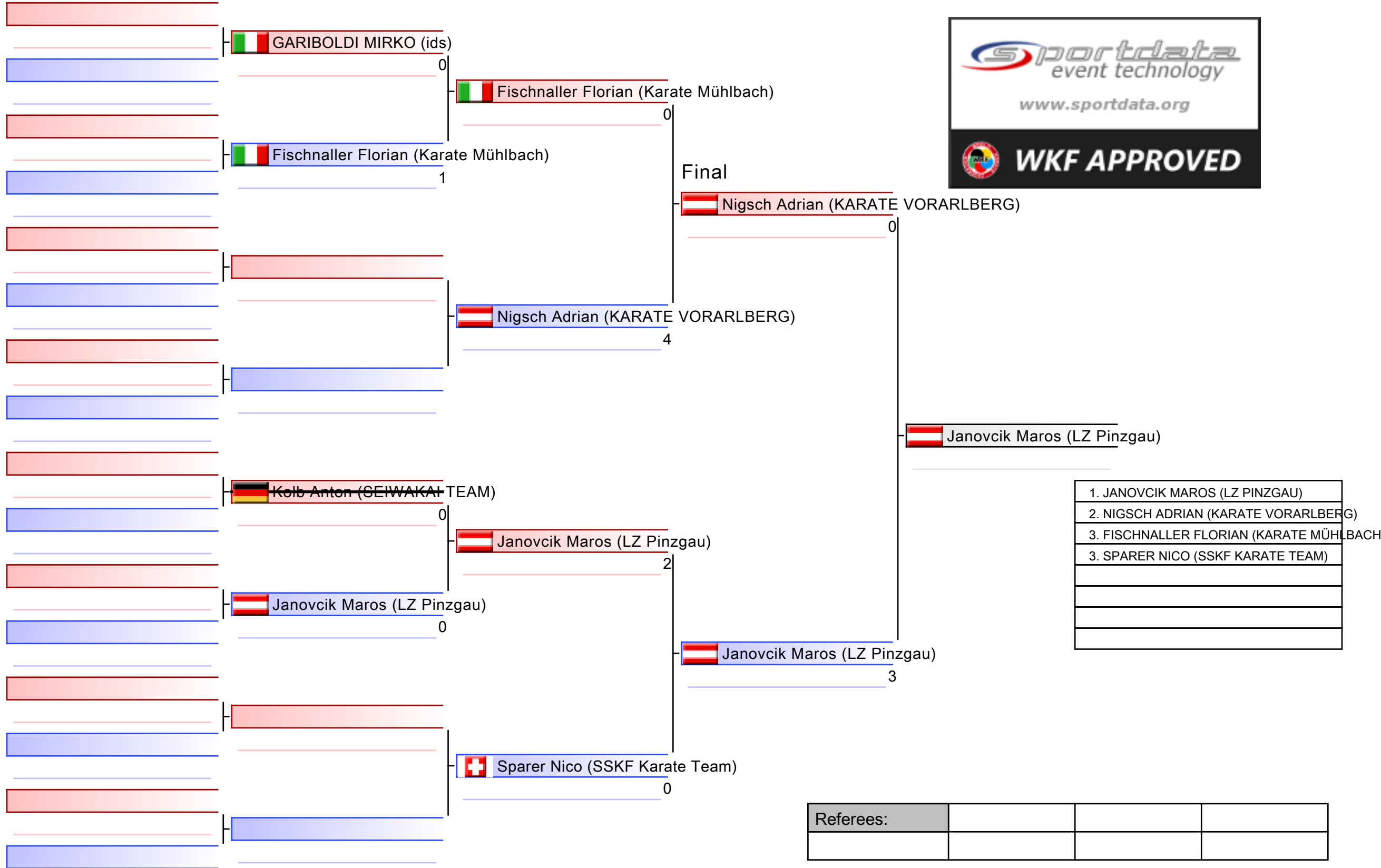

1. JANOVCIK MAROS (LZ PINZGAU)
2. NIGSCH ADRIAN (KARATE VORARLBERG)
3. FISCHNALLER FLORIAN (KARATE MÜHLBACH)
3. SPARER NICO (SSKF KARATE TEAM)

Referees:			



# Kumite Individual male U21 -75

AUSTRIAN JUNIOR OPEN 2023

2023-06-24

Tatami  
3 18:50

Pool  
1

(c)sportdata GmbH & Co KG 2000-2023 (2023-06-24 21:05) v 10.0.1 build 1 (2023-05-19 20:00 CET) License: Online\_Event\_ID-6821\_AUSTRIANJUNIOROPEN2023 (expire 2023-07-08)

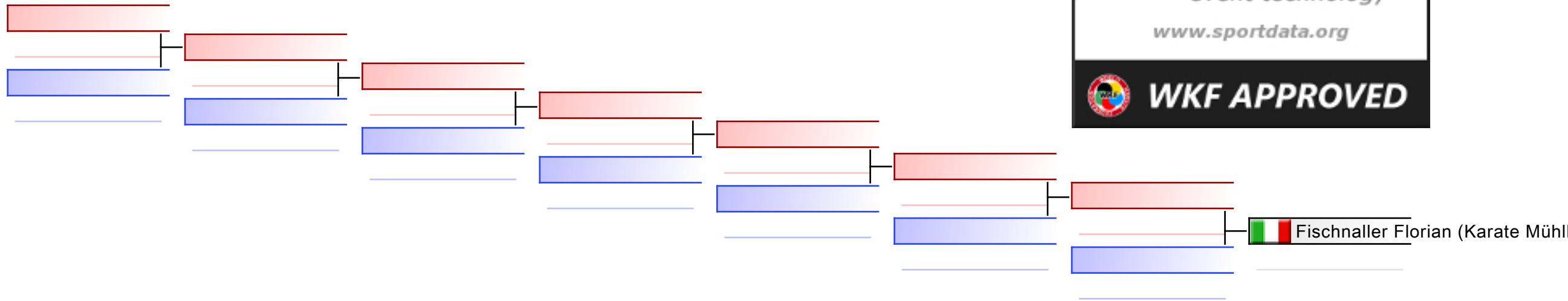

## REPECHAGE: (1)

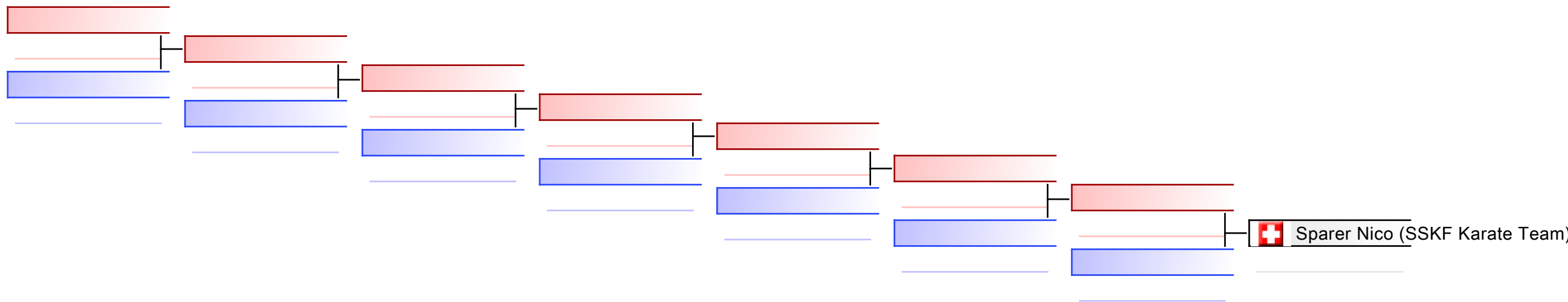

Referees:							
-----------	--	--	--	--	--	--	--

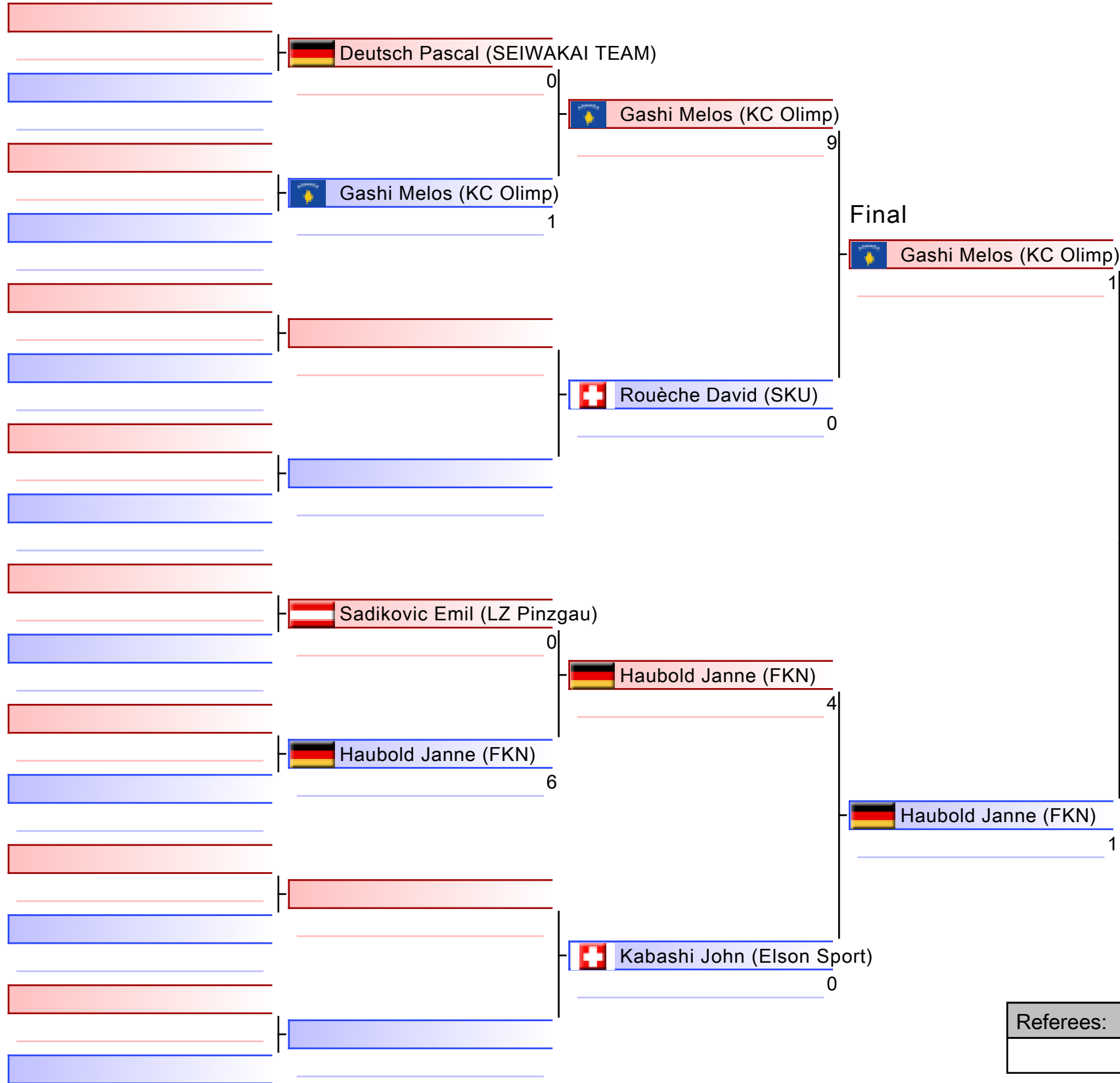

1. GASHI MELOS (KC OLIMP)
2. HAUBOLD JANNE (FKN)
3. DEUTSCH PASCAL (SEIWAKAI TEAM)
3. SADIKOVIC EMIL (LZ PINZGAU)
5. ROUÈCHE DAVID (SKU)
5. KABASHI JOHN (ELSON SPORT)

Referees:			

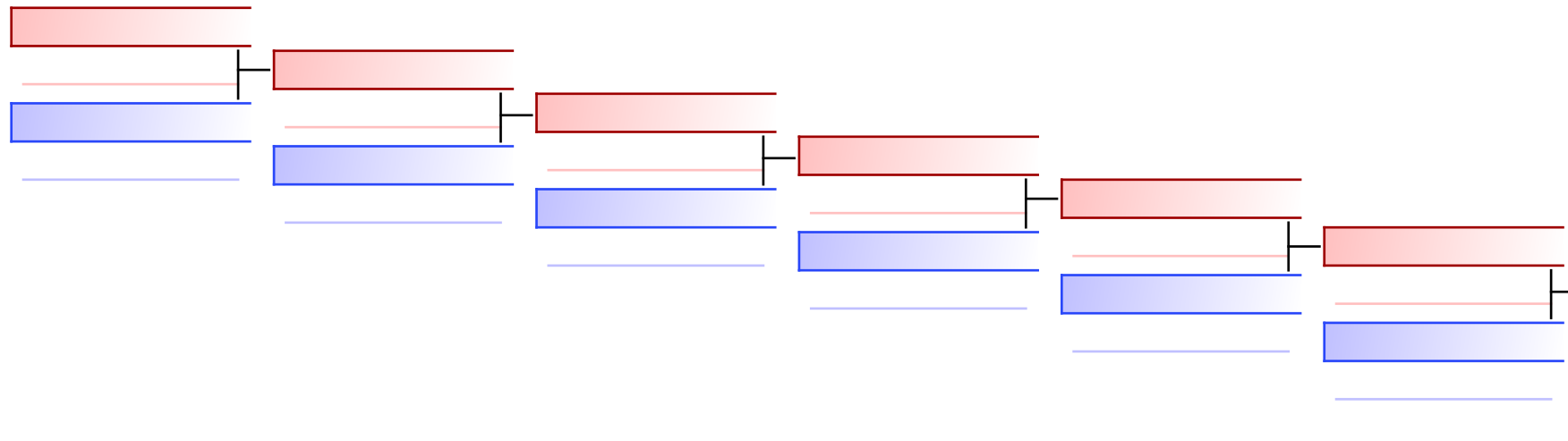

Deutsch Pascal (SEIWAKAI TEAM) | 2  
 Deutsch Pascal (SEIWAKAI TEAM) | 2  
 Rouèche David (SKU) | 0

REPECHAGE: (1)

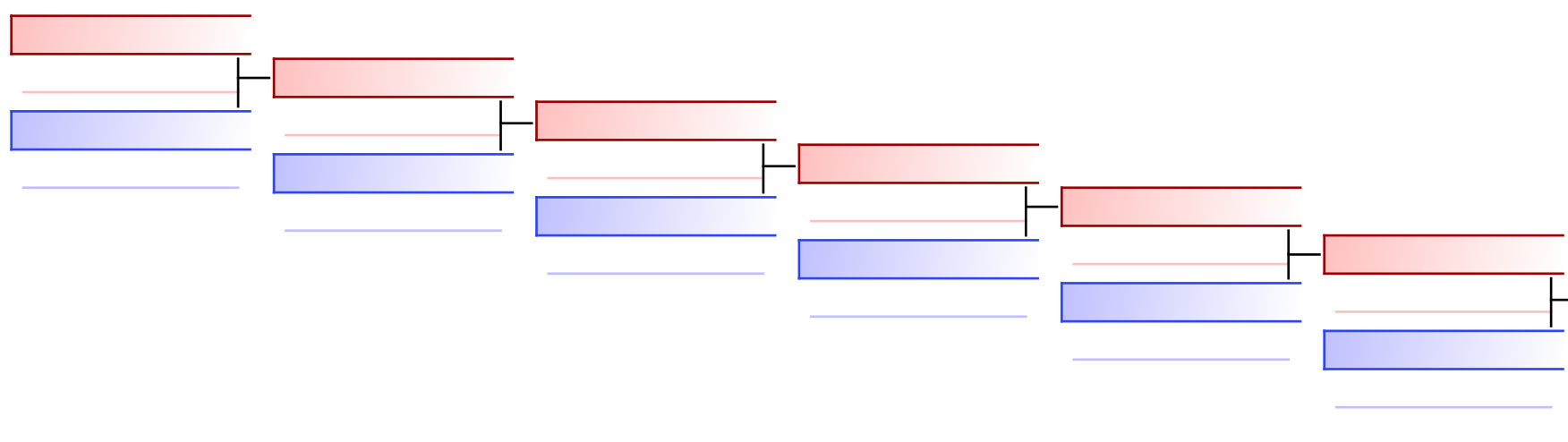

Sadikovic Emil (LZ Pinzgau) | 2  
 Sadikovic Emil (LZ Pinzgau) | 2  
 Kabashi John (Elson Sport) | 1

Referees:							
-----------	--	--	--	--	--	--	--

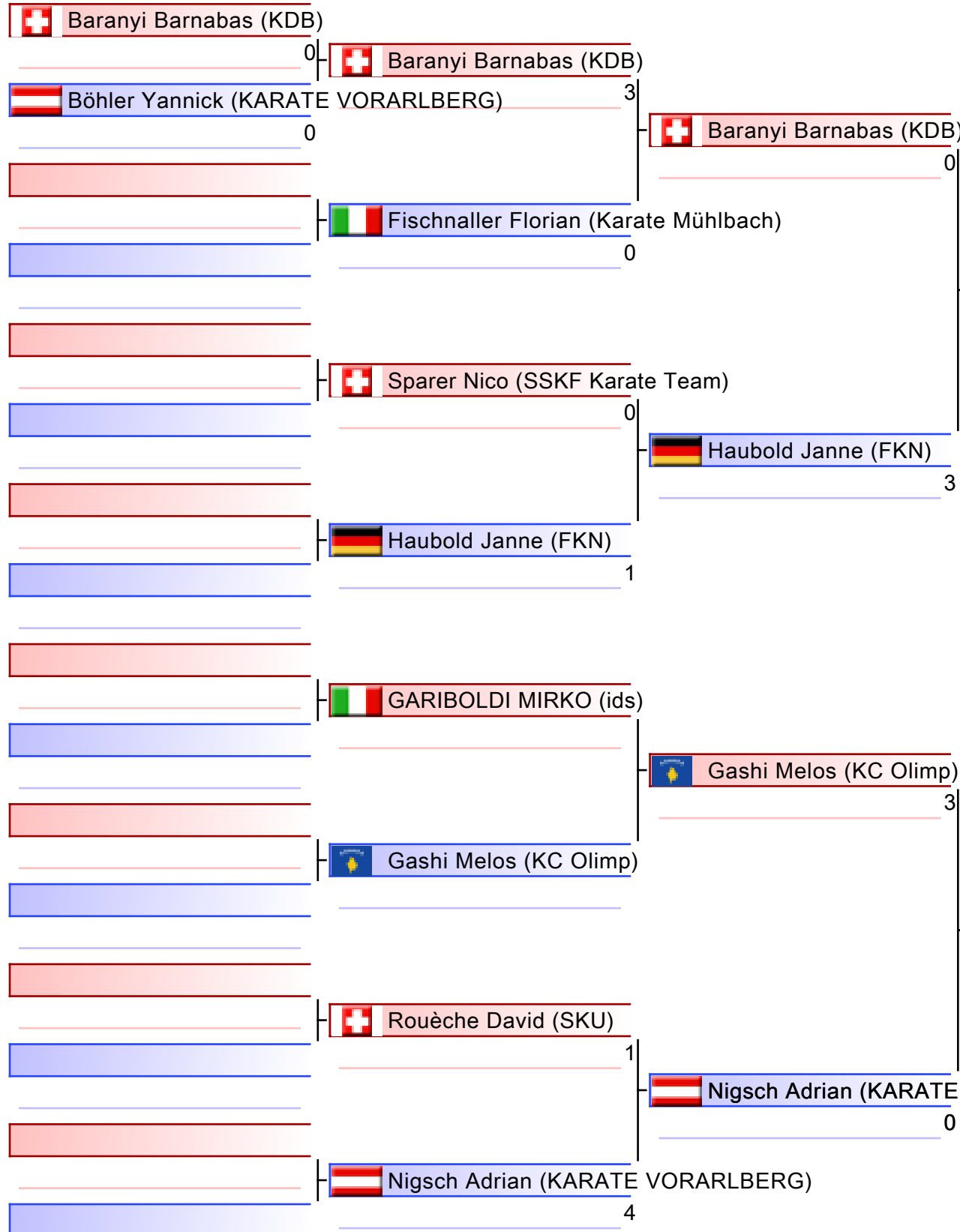

Gashi Melos (KC Olimp)

1. GASHI MELOS (KC OLIMP)
2. HAUBOLD JANNE (FKN)
3. BARANYI BARNABAS (KDB)
3. NIGSCH ADRIAN (KARATE VORARLBERG)
5. GARIBOLDI MIRKO (IDS)
5. SPARER NICO (SSKF KARATE TEAM)
5. FISCHNALLER FLORIAN (KARATE MÜHLBACH)
5. ROUËCHE DAVID (SKU)

Referees:			

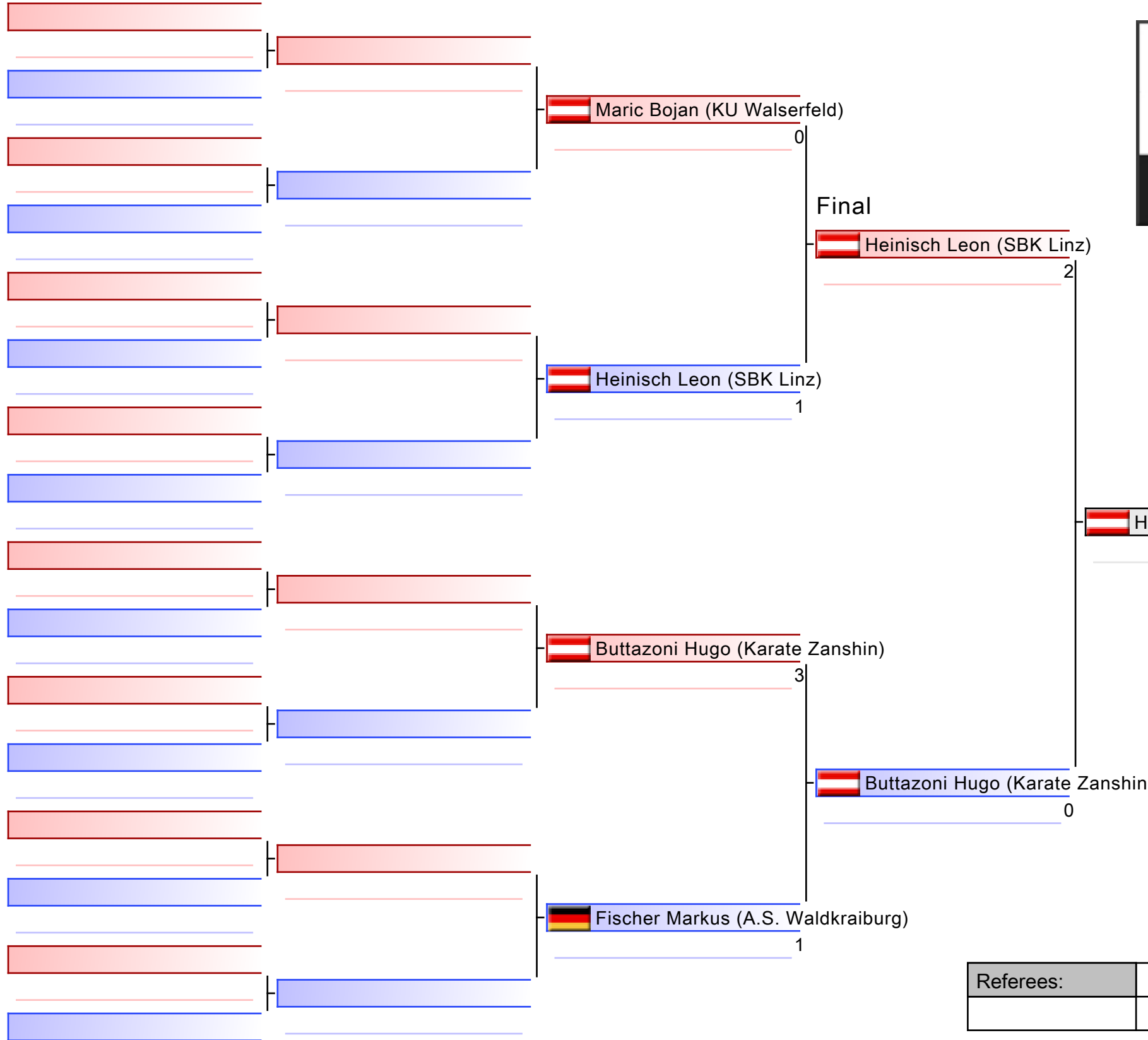

1. HEINISCH LEON (SBK LINZ)
2. BUTTAZONI HUGO (KARATE ZANSHIN)
3. MARIC BOJAN (KU WALSERFELD)
3. FISCHER MARKUS (A.S. WALDKRAIBURG)

Referees:			

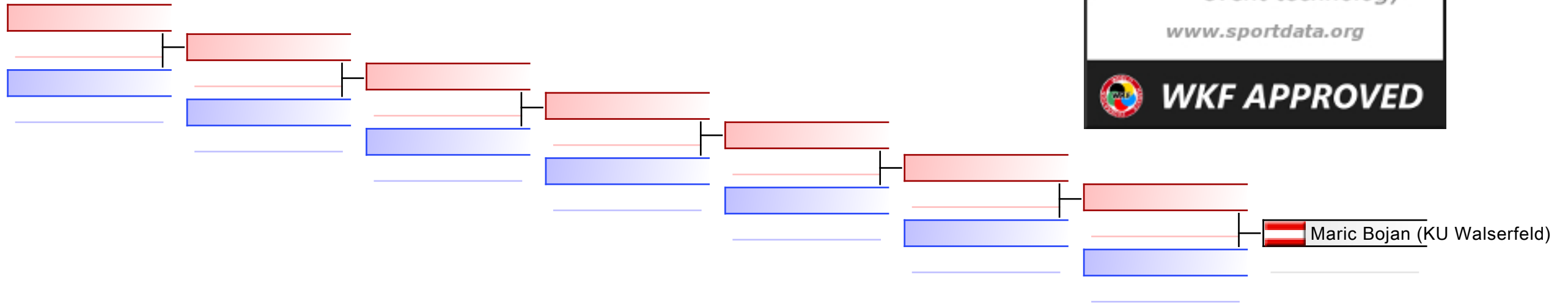

REPECHAGE: (1)

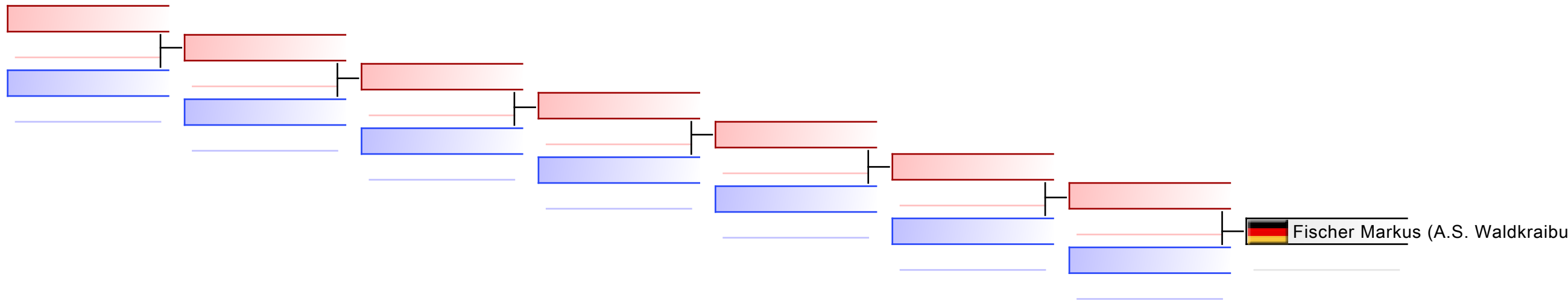

Referees:							
-----------	--	--	--	--	--	--	--

kumite male u10 -28 kg

AUSTRIAN JUNIOR OPEN 2023, Schulstrasse 17, 5071 Wals, AUT

2023-06-24

Tatami  
3 14:20

Pool  
1/1

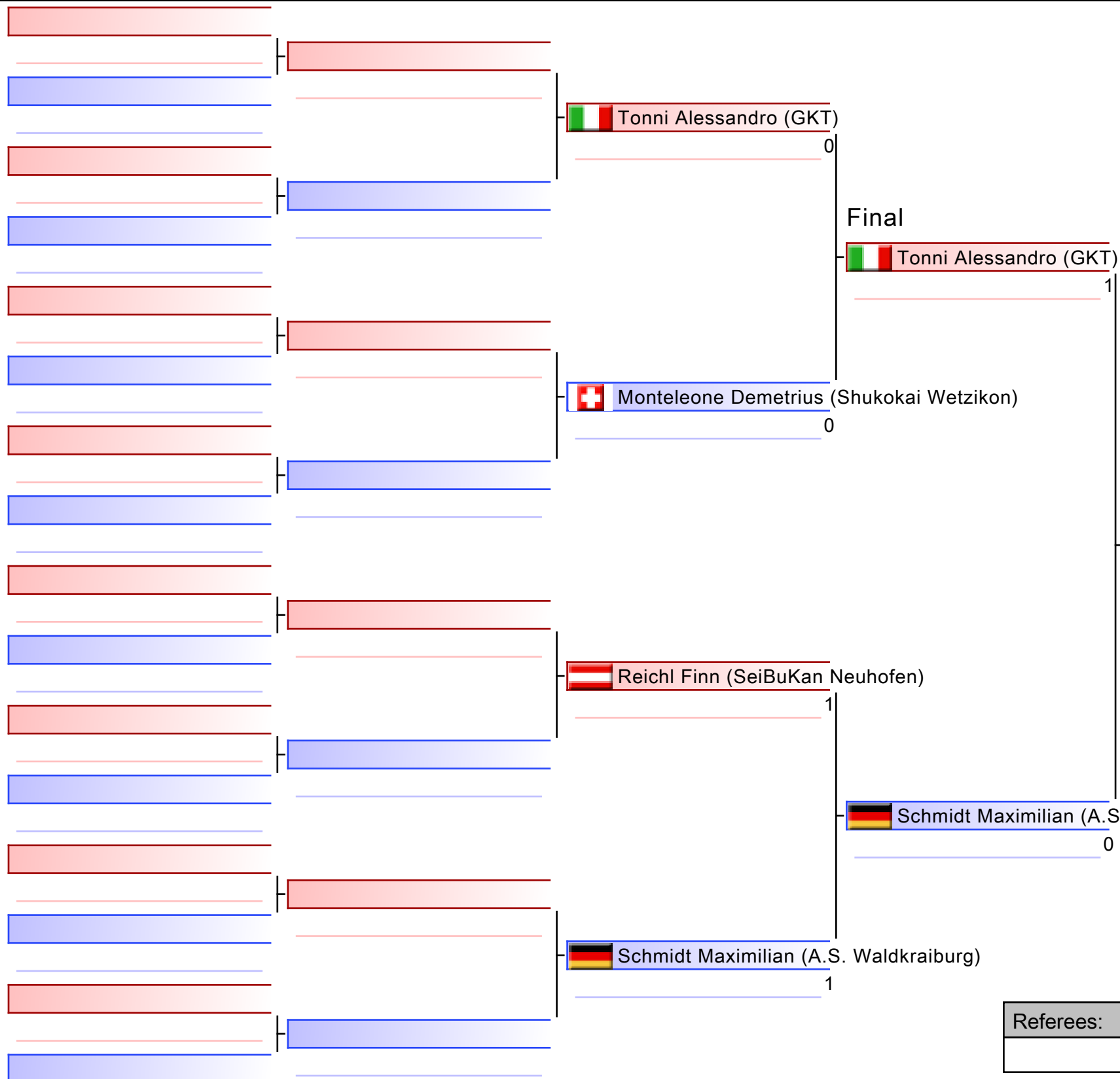

🇮🇹 Tonni Alessandro (GKT)

1. TONNI ALESSANDRO (GKT)
2. SCHMIDT MAXIMILIAN (A.S. WALDKRAIBURG)
3. REICHL FINN (SEIBUKAN NEUHOFEN)

Referees:			

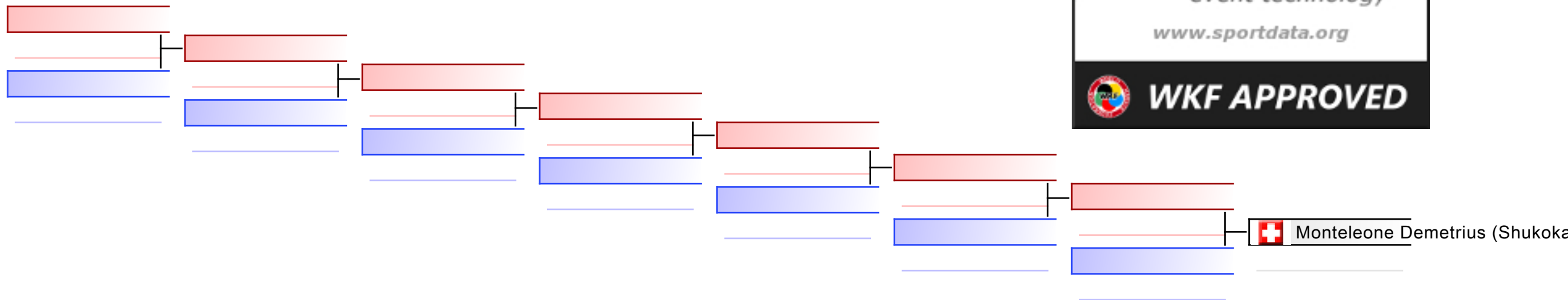

REPECHAGE: (1)

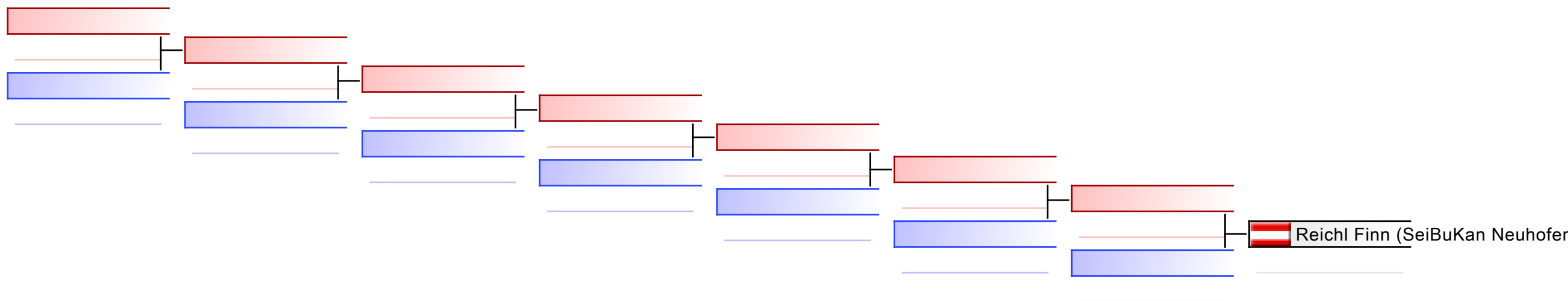

Referees:							
-----------	--	--	--	--	--	--	--



# Kumite male U10 -34kg

AUSTRIAN JUNIOR OPEN 2023, Schulstrasse 17, 5071 Wals, AUT

2023-06-24

Tatami  
3 14:30

Pool  
1/1

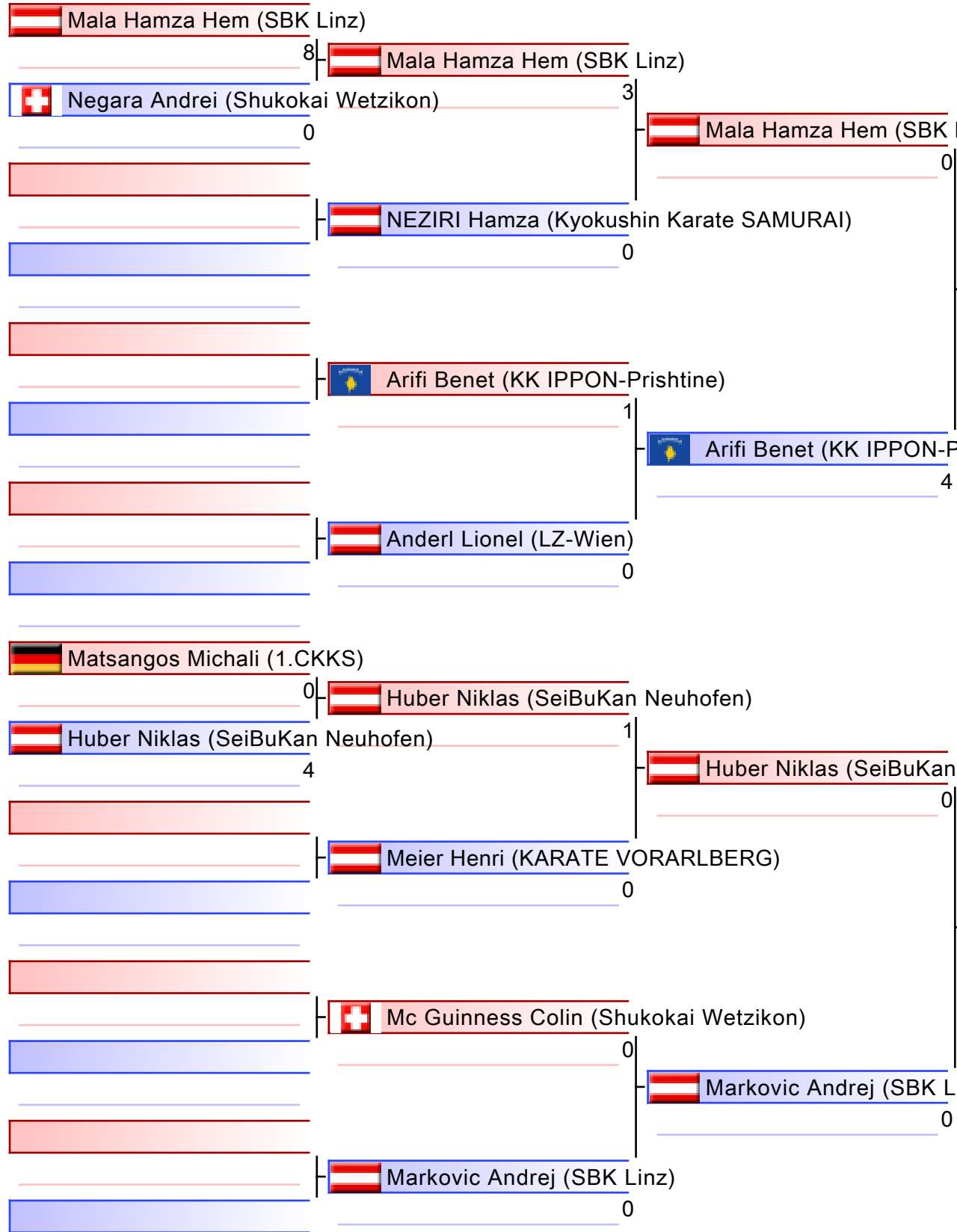

1. ARIFI BENET (KK IPPON-PRISHTINE)
2. MARKOVIC ANDREJ (SBK LINZ)
3. MALA HAMZA HEM (SBK LINZ)
3. MC GUINNESS COLIN (SHUKOKAI WETZIKON)
5. ANDERL LIONEL (LZ-WIEN)
5. HUBER NIKLAS (SEIBUKAN NEUHOFEN)

Referees:			

Kumite male U10 -34kg

AUSTRIAN JUNIOR OPEN 2023

2023-06-24

Tatami  
3 14:30

Pool  
1

(c)sportdata GmbH & Co KG 2000-2023 (2023-06-24 21:05) v 10.0.1 build 1 (2023-05-19 20:00 CET) License: Online\_Event\_ID-6821\_AUSTRIANJUNIOROPEN2023 (expire 2023-07-08)

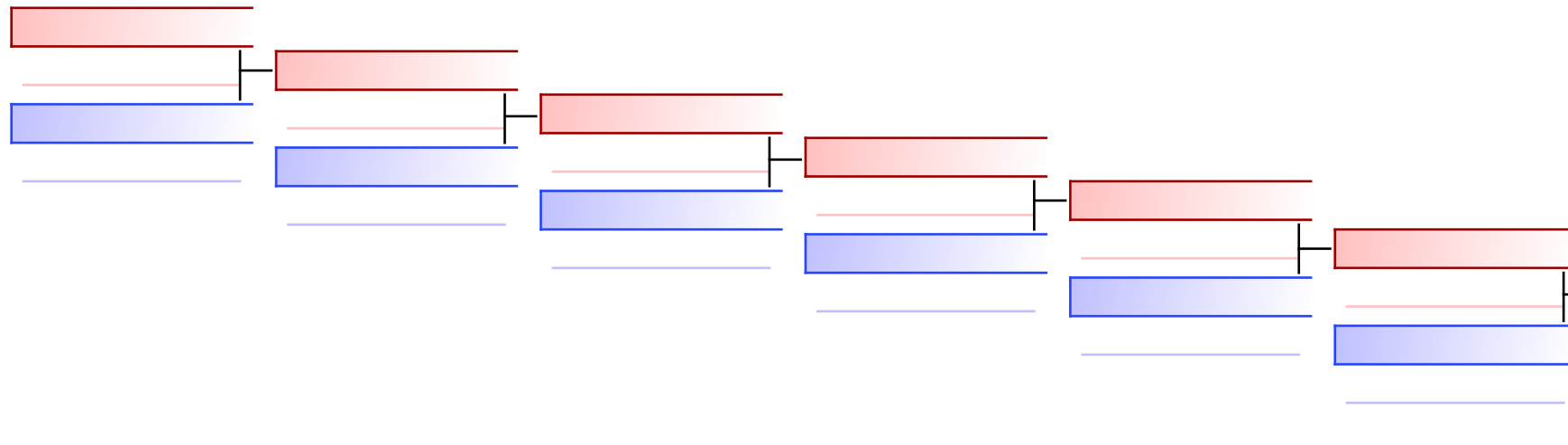

	Anderl Lionel (LZ-Wien)	0		Mala Hamza Hem (SBK Linz)
	Mala Hamza Hem (SBK Linz)	0		Mala Hamza Hem (SBK Linz)

REPECHAGE: (1)

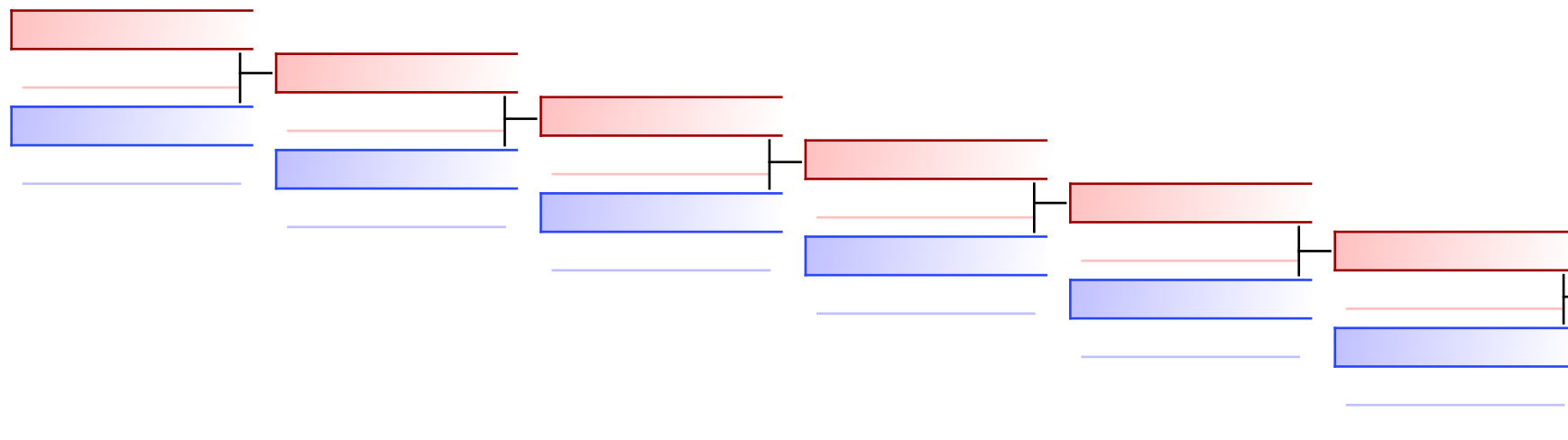

	Mc Guinness Colin (Shukokai Wetzikon)	2		Mc Guinness Colin (Shukokai Wetzikon)
	Huber Niklas (SeiBuKan Neuhofen)	0		Huber Niklas (SeiBuKan Neuhofen)

Referees:							
-----------	--	--	--	--	--	--	--

AUSTRIAN JUNIOR OPEN 2023 - 2023-06-24

Official Results

Kata Individual female Cadets				
1	LEHNER TAMARA	FRIEWAYS KARATEKLUB		AUT - AUSTRIA
2	KORNER LEONIE	FRIEWAYS KARATEKLUB		AUT - AUSTRIA
3	RITZ LILA	KARATE EMME		SUI - SWITZERLAND
3	STUDENKOVA DARIA	OKINAWA		UKR - UKRAINE
5	ANDREINI MARTA	AKS FIRENZE		ITA - ITALY
5	BOBBERT AITANA	TSV ERDING		GER - GERMANY
7	LEGLER JULIA	ASIA SPORTS KARATESCHULE		GER - GERMANY
7	KUBINOVÁ ANNA	CLUB KARATE PLZEN		CZE - CZECH REPUBLIC
9	HECK GLORIA	UKA ZEN TAI RYU HAK ST. PÖLTEN		AUT - AUSTRIA
9	EISELT ZOE	SWISS KARATE UNION		SUI - SWITZERLAND
11	SOLAZZO DIAMANTE	KIMURA SHUKOKAI KARATE LIMMATTAL		SUI - SWITZERLAND
11	SPIELMANN ILÉAH	SWISS KARATE UNION		SUI - SWITZERLAND
13	WITTE FRANZISKA	LV SACHSEN- ANHALT		GER - GERMANY
13	EMBLA REBEKKA HALLDÓRSDÓTTIR	KARATEFÉLAG REYKJAVÍKUR		ISL - ICELAND
15	CAMPELL LARISSA	SWISS KARATE UNION		SUI - SWITZERLAND
15	GJERGJAJ MELISA	KIMURA SHUKOKAI KARATE LIMMATTAL		SUI - SWITZERLAND
17	DE CARLO LARISSA	SHUKOKAI DOJO WETZIKON		SUI - SWITZERLAND
17	GUNZNER KATHARINA	TSV MONHEIM E.V.		GER - GERMANY
17	LIBIK TAMARA	ASIA SPORTS KARATESCHULE		GER - GERMANY
17	TSCHALER LARISSA	KARATE UNION WALSERFELD		AUT - AUSTRIA
21	ILIC MARTINA	KARATE UNION WALSERFELD		AUT - AUSTRIA
21	DEL TITO EMANUELA	ASD HEIAN BUSHI DO		ITA - ITALY
21	GIBBS KASSANDRA LOHAN	BUSHIDO KARATE PERUGIA		ITA - ITALY
25	BAGHERI FARZANA	LEISTUNGSZENTRUM WIEN		AUT - AUSTRIA
25	NIKOLI EMA	KARATE UNION SHOTOKAN TIROL		AUT - AUSTRIA

Kata Individual female Juniors				
1	CRUCITTI FRANCESCA	A.S.D. ARTESPORT		ITA - ITALY
2	STEGER ROSALIE	KARATE CLUB LANGENLOIS		AUT - AUSTRIA
3	STÖSSEL ANNA	SV UNSU KARATE MÖMLINGEN E.V.		GER - GERMANY
3	EIDLER ELENA	FRIEWAYS KARATEKLUB		AUT - AUSTRIA
5	PELLADONI GINA	KARATECENTER RETO KERN KREUZLINGEN		SUI - SWITZERLAND

AUSTRIAN JUNIOR OPEN 2023 - 2023-06-24

Official Results

5	MALAFOVÁ NATÁLIE	NIDOSHINKAN DOJO		CZE - CZECH REPUBLIC	
7	ZAYED FATIMA	SWISS KARATE UNION		SUI - SWITZERLAND	
7	BOBBERT ISABELLA	TSV ERDING		GER - GERMANY	
9	SCHACHNER CLAUDIA	OKINAWA KARATE TUS ALZTAL GARCHING		GER - GERMANY	
9	FORTUNATO EMMA	SWISS KARATE UNION		SUI - SWITZERLAND	
11	GRANDIC NIKOLINA	KARATEDO WELS		AUT - AUSTRIA	
11	GALLIMORE KIM	KARATE EMME		SUI - SWITZERLAND	
13	GROSSMANN DARJA	KIMURA SHUKOKAI KARATE LIMMATTAL		SUI - SWITZERLAND	
13	LASTA KATJA	KARATE UNION SHOTOKAN TIROL		AUT - AUSTRIA	
15	HARASSER MARISA	KARATE UNION SHOTOKAN TIROL		AUT - AUSTRIA	
15	DEFRANCESCHI REBECCA	KARATE ZANSHIN KOBLACH/HARD/ BREGENZ		AUT - AUSTRIA	
17	GALATEANU EVELYN	ASKÖ SEIBUKAN LINZ		AUT - AUSTRIA	
19	ARMAGAN ALEYNA	KARATE UNION WALSERFELD		AUT - AUSTRIA	

**Kata Individual female U10**









1	SCHMIDT LENA	ASIA SPORTS KARATESCHULE		GER - GERMANY	
2	MALAFOVÁ STELLA	NIDOSHINKAN DOJO		CZE - CZECH REPUBLIC	
3	PRESL LINA	KARATE UNION KACHIKAN		AUT - AUSTRIA	
3	KUBINOVÁ ELIŠKA	CLUB KARATE PLZEN		CZE - CZECH REPUBLIC	
5	SCHMIDT LISA	ASIA SPORTS KARATESCHULE		GER - GERMANY	
5	HUSKIC DIANA	ASKÖ SEIBUKAN LINZ		AUT - AUSTRIA	
7	GJERGJAJ AMELIE	KIMURA SHUKOKAI KARATE LIMMATTAL		SUI - SWITZERLAND	

**Kata Individual female U12**

1	CELO HILAL	KARATE UNION KACHIKAN		AUT - AUSTRIA	
2	HAPFELMEIER LOUISA	ASIA SPORTS KARATESCHULE		GER - GERMANY	
3	BAYRAM MIRA	KARATE VORARLBERG		AUT - AUSTRIA	
3	SCHÜTZ JOHANNA	KD STRAUBING		GER - GERMANY	
5	BERCHTOLD PAULINE	KARATE ZANSHIN KOBLACH/HARD/ BREGENZ		AUT - AUSTRIA	
5	COIK LILLY	KARATE ZANSHIN KOBLACH/HARD/ BREGENZ		AUT - AUSTRIA	
7	MÜLLER SARAH	TSV MONHEIM E.V.		GER - GERMANY	
9	EBNER LENA	KARATE UNION WALSERFELD		AUT - AUSTRIA	

AUSTRIAN JUNIOR OPEN 2023 - 2023-06-24

Official Results

Kata Individual female U14				
1	CRUCITTI SOFIA	A.S.D. ARTESPORT		ITA - ITALY
2	SIGILLÒ ANASTASIA	SWISS KARATE UNION		SUI - SWITZERLAND
3	RITZ MAIA	KARATE EMME		SUI - SWITZERLAND
3	KRIEGER LENA	ASIA SPORTS KARATESCHULE		GER - GERMANY
5	NEUENSCHWANDER RIA	RYUEI-RYU KARATE SUISSE		SUI - SWITZERLAND
5	WEISS TIFFANY	SWISS KARATE UNION		SUI - SWITZERLAND
7	STURM ISABELL	KARATE UNION WALSERFELD		AUT - AUSTRIA
7	LAMPERSBERGER EMILIA	ASIA SPORTS KARATESCHULE		GER - GERMANY
9	ASIMI ASMA	LEISTUNGSZENTRUM WIEN		AUT - AUSTRIA

Kata Individual female U21				
1	SUTER ANINA	SWISS KARATE UNION		SUI - SWITZERLAND
2	VLAI JESSICA	ASIA SPORTS KARATESCHULE		GER - GERMANY
3	CELO ISRA	KARATE UNION KACHIKAN		AUT - AUSTRIA
3	FLASCHBERGER SARAH	INOUE-HA KARATE-DO FELDKIRCHEN		AUT - AUSTRIA
5	RONJA HALLDÓRSDÓTTIR	KARATEFÉLAG REYKJAVÍKUR		ISL - ICELAND
5	TSCHANZ OLIVIA	KENSEIKAN KARATE-DO THUN		SUI - SWITZERLAND
7	MIÑANO LANYFER	RYUEI-RYU KARATE SUISSE		SUI - SWITZERLAND
7	DI VIRGILIO ALICE	ASD HEIAN BUSHI DO		ITA - ITALY
9	MAELLE LOCOGE	TSV ERDING		GER - GERMANY
9	CERIANI GIULIA	IMPERO DEL SOLE A.S.D.		ITA - ITALY
11	POPOVA VARVARA	KARATEDO WELS		AUT - AUSTRIA
11	KARAKOC SORAYA	KIMURA SHUKOKAI KARATE LIMMATTAL		SUI - SWITZERLAND
13	EYDÍS MAGNEA FRÍÐRIKSDÓTTIR	KARATEFÉLAG REYKJAVÍKUR		ISL - ICELAND

Kata Individual female U8				
1	MOSAVI SETAYESCH	LEISTUNGSZENTRUM WIEN		AUT - AUSTRIA
2	LENA JANA	KARATE UNION KACHIKAN		AUT - AUSTRIA
3	SCHMIDT LENA	ASIA SPORTS KARATESCHULE		GER - GERMANY
3	HENNEBERG LEA	ASIA SPORTS KARATESCHULE		GER - GERMANY
5	POSAVEC ALINA VICTORIA	SCUOLA DI KARATE YAMA NO KAZE		SUI - SWITZERLAND
5	POSAVEC AMÉLIE STÉPHANIE	SCUOLA DI KARATE YAMA NO KAZE		SUI - SWITZERLAND
7	MUHR LISA-MARIE	KARATE UNION WALSERFELD		AUT - AUSTRIA

AUSTRIAN JUNIOR OPEN 2023 - 2023-06-24

Official Results

Kata Individual male Cadets				
1	HLUSHCHENKO ARTUR	OKINAWA		UKR - UKRAINE
2	ROMAGNOLI EMANUEL	BUSHIDO KARATE PERUGIA		ITA - ITALY
3	ZHOU MARCO	BUSHIDO KARATE PERUGIA		ITA - ITALY
3	MISCHLER KEVIN	KARATE EMME		SUI - SWITZERLAND
5	MATTERA ANTONIO	AKS FIRENZE		ITA - ITALY
5	FIORAVANTI RICCARDO	AKS FIRENZE		ITA - ITALY
7	PELIVANI DENIS	SWISS KARATE UNION		SUI - SWITZERLAND
7	OLLAGNERO GIOVANNI SEBASTIAN	A.S.D. ARTESPORT		ITA - ITALY
9	WALLNER SIMON	KARATE UNION WALSERFELD		AUT - AUSTRIA
9	WAGNER EMIL	KARATE VORARLBERG		AUT - AUSTRIA
11	BRILLI ROCCO	BUSHIDO KARATE PERUGIA		ITA - ITALY
11	SCHEDEL NOLAN	EKTS LAUSANNE VUFFLENS		SUI - SWITZERLAND
13	MIJUSKOVIC DAMIAN	OKINAWA KARATE TSV FEICHTEN		GER - GERMANY
13	CAJÖRI MILO	SWISS KARATE UNION		SUI - SWITZERLAND
15	STANIKZAI HEJRATULLAH	KARATE ZANSHIN KOBLACH/HARD/ BREGENZ		AUT - AUSTRIA
15	LIM HAO YI	KIMURA SHUKOKAI KARATE LIMMATTAL		SUI - SWITZERLAND
17	MATEUS GOMES CRISTIANO	KARATE DO BRUGG		SUI - SWITZERLAND
17	GALATEANU DAVID	ASKÖ SEIBUKAN LINZ		AUT - AUSTRIA
19	LOSHAJ MURAT	KIMURA SHUKOKAI KARATE LIMMATTAL		SUI - SWITZERLAND
19	WALLNER JONAS	KARATE UNION WALSERFELD		AUT - AUSTRIA
21	JANTSCHER MARCEL JOSEPH	KARATE UNION SHOTOKAN TIROL		AUT - AUSTRIA
21	SCHACHINGER LORENZ	KARATE UNION WALSERFELD		AUT - AUSTRIA

Kata Individual male Juniors				
1	FUSCAGNI ALEX	BUSHIDO KARATE PERUGIA		ITA - ITALY
2	GIOVAGNONI GIOELE	BUSHIDO KARATE PERUGIA		ITA - ITALY
3	ZÖCHBAUER SAMUEL	SPORTUNION MUGENDO KARATE		AUT - AUSTRIA
3	ZÖCHLING FLORIAN	SPORTUNION MUGENDO KARATE		AUT - AUSTRIA
5	WU TIMON	LEISTUNGSZENTRUM WIEN		AUT - AUSTRIA
5	VOGEL KASPAR	SWISS KARATE UNION		SUI - SWITZERLAND
7	SOLAZZO ILARIO NAZARENO	KIMURA SHUKOKAI KARATE LIMMATTAL		SUI - SWITZERLAND

AUSTRIAN JUNIOR OPEN 2023 - 2023-06-24

Official Results

7	WAGNER FELIX	KARATE VORARLBERG		AUT - AUSTRIA	
9	HUGI HALLDÓRSSON	KARATEFÉLAG REYKJAVÍKUR		ISL - ICELAND	
9	SCHERTENLEIB JANIK	GOJU KAN BERN		SUI - SWITZERLAND	
11	MELANI MATTEO	AKS FIRENZE		ITA - ITALY	
11	REITER PATRICK	OKINAWA KARATE TSV FEICHTEN		GER - GERMANY	
13	OTT SIMON	KENSEIKAN KARATE- DO THUN		SUI - SWITZERLAND	
13	EFTIMIE EDUARD	IMPERO DEL SOLE A.S.D.		ITA - ITALY	
15	SHAMSI DANIEL	TSV GRASBRUNN- NEUKEFERLOH		GER - GERMANY	
15	BYTYQI LIJON	KARATE SHOTOKAN LORA ZELL AM SEE		AUT - AUSTRIA	

**Kata Individual male U10**

1	SCHMIDT MAXIMILIAN	ASIA SPORTS KARATESCHULE		GER - GERMANY	
2	MALA HAMZA HEM	ASKÖ SEIBUKAN LINZ		AUT - AUSTRIA	
3	BANIC SERGEJ	KARATE SHOTOKAN LORA ZELL AM SEE		AUT - AUSTRIA	
3	FISCHER MARKUS	ASIA SPORTS KARATESCHULE		GER - GERMANY	
5	CRISPOLTI GIULIO	BUSHIDO KARATE PERUGIA		ITA - ITALY	
5	BUTTAZONI HUGO	KARATE ZANSHIN KOBACH/HARD/ BREGENZ		AUT - AUSTRIA	
7	MARKOVIC ANDREJ	ASKÖ SEIBUKAN LINZ		AUT - AUSTRIA	
7	RIGAUD NOEL-LEON	KARATE UNION SHOTOKAN TIROL		AUT - AUSTRIA	
9	KAMILOVSKI SEMI	KIMURA SHUKOKAI KARATE LIMMATTAL		SUI - SWITZERLAND	

**Kata Individual male U12**

1	DAUTORIO IGOR	A.S.D. VILLA PIGNA KARATE		ITA - ITALY	
2	HÜTTER MICHAEL	ASIA SPORTS KARATESCHULE		GER - GERMANY	
3	PROBST ARTHUR	TSV GRASBRUNN- NEUKEFERLOH		GER - GERMANY	
3	ZWIRGLMAIER SIMON	OKINAWA KARATE TSV FEICHTEN		GER - GERMANY	
5	SCHEFBAUMER FRANZ MATHEW	ASKÖ KARATE KARA		AUT - AUSTRIA	
5	HURLER ELIAH	TSV MONHEIM E.V.		GER - GERMANY	
7	MARCANTONINI EDOARDO	BUSHIDO KARATE PERUGIA		ITA - ITALY	
7	KAPS LUKAS	KARATE UNION WALSERFELD		AUT - AUSTRIA	

**Kata Individual male U14**







1	ZADINA EMIL	FRIEWAYS KARATEKLUB		AUT - AUSTRIA	
---	-------------	------------------------	---	---------------	--

AUSTRIAN JUNIOR OPEN 2023 - 2023-06-24

Official Results

2	LIBIK DANIEL	ASIA SPORTS KARATESCHULE		GER - GERMANY	
3	LÜTHY CORSIN DION	KARATE DO BRUGG		SUI - SWITZERLAND	
3	LIMACHER RAMON	SWISS KARATE UNION		SUI - SWITZERLAND	
5	DE MEO MARCO	AKS FIRENZE		ITA - ITALY	
5	LIST FABIO	KARATE-DO WEIZ		AUT - AUSTRIA	
7	ACKERBAUER ANDREAS	ASKÖ SEIBUKAN LINZ		AUT - AUSTRIA	
7	FLATTINGER CLEMENS	UNION KARATECLUB GRIESKIRCHEN		AUT - AUSTRIA	
9	DOUCHET MAXIM	TSV GRASBRUNN- NEUKEFERLOH		GER - GERMANY	
9	CORNACCHIA EDOARDO	OKINAWA KARATE TUS ALZTAL GARCHING		GER - GERMANY	

Kata Individual male U21

1	SCHEDER KENI	EKTS LAUSANNE VUFFLENS		SUI - SWITZERLAND	
2	SCHERTENLEIB LARS NOAH	SWISS KARATE UNION		SUI - SWITZERLAND	
3	PETRONE LEANDRO	SWISS KARATE UNION		SUI - SWITZERLAND	
3	ACQUAIOLI TOMMASO	AKS FIRENZE		ITA - ITALY	
5	FORGIONE MIRCO	SHORIN RYU KARATE DO KLOTEN		SUI - SWITZERLAND	
5	PFEIFFER THOMAS	OKINAWA KARATE TUS ALZTAL GARCHING		GER - GERMANY	

Kata Individual male U8

1	SCHMIDT MAXIMILIAN	ASIA SPORTS KARATESCHULE		GER - GERMANY	
2	BICIOC ROMEO	KARATE UNION SHOTOKAN TIROL		AUT - AUSTRIA	
3	NEZIRI AMAR	KYOKUSHIN KARATE SAMURAI		AUT - AUSTRIA	
3	KOLAROV MAXIM	KIMURA SHUKOKAI KARATE LIMMATTAL		SUI - SWITZERLAND	
5	MENKE JONATHAN	1.CKKS TRAUNREUT		GER - GERMANY	
5	MILIC MIKA	1.CKKS TRAUNREUT		GER - GERMANY	
7	RAFFLER DOMINIC	KARATE UNION WALSERFELD		AUT - AUSTRIA	

Kata Team female U10



1	ASIA SPORTS KARATESCHULE - SCHMIDT LISA - SCHMIDT LENA - HENNEBERG LEA	ASIA SPORTS KARATESCHULE		GER - GERMANY	
2	KARATE UNION WALSERFELD - VOGGENBERGER SOPHIA - MOSER ANNABELLE - HELMSAUER MARLENE	KARATE UNION WALSERFELD		AUT - AUSTRIA	







AUSTRIAN JUNIOR OPEN 2023 - 2023-06-24

Official Results

Kata Team female U12					
1	KARATE ZANSHIN KOBLACH/ HARD/BREGENZ - BERCHTOLD PAULINE - JOCHUM JULIA - COIK LILLY	KARATE ZANSHIN KOBLACH/HARD/ BREGENZ		AUT - AUSTRIA	
2	ASIA SPORTS KARATESCHULE - SCHMIDT LISA - SCHMIDT LENA - HAPFELMEIER LOUISA	ASIA SPORTS KARATESCHULE		GER - GERMANY	
3	KARATE UNION WALSERFELD - SACHER JULIA - GÄRTNER EVA - GÄRTNER ANNA	KARATE UNION WALSERFELD		AUT - AUSTRIA	
3	SHUKOKAI DOJO WETZIKON - KELLER ZOE - KELLER ELLIE - DUSA NATALIE	SHUKOKAI DOJO WETZIKON		SUI - SWITZERLAND	

Kata Team female U14					
1	LEISTUNGSZENTRUM WIEN - JAFARI FATIMA - BAGHERI AMENE - ASIMI ASMA	LEISTUNGSZENTRUM WIEN		AUT - AUSTRIA	
2	KARATE UNION SHOTOKAN TIROL - HARASSER ROSALIE - LASTA MIA - VUJANOVIC TEODORA	KARATE UNION SHOTOKAN TIROL		AUT - AUSTRIA	

Kata Team female U16					
1	KARATE UNION WALSERFELD - MARJANOVIC TIJANA - VENTIMIGLIA VIKTORIA - STURM ISABELL	KARATE UNION WALSERFELD		AUT - AUSTRIA	
2	KARATE SHOTOKAN LORA ZELL AM SEE - LORA ALIJI - BYTYQI LORENA - BYTYQI LONDRESA	KARATE SHOTOKAN LORA ZELL AM SEE		AUT - AUSTRIA	

Kata Team female U18					
1	KARATE EMME - RITZ MAIA - RITZ LILA - GALLIMORE KIM	KARATE EMME		SUI - SWITZERLAND	
2	KARATE UNION WALSERFELD - ILIC MARTINA - TSCHALER LARISSA - ARMAGAN ALEYNA	KARATE UNION WALSERFELD		AUT - AUSTRIA	
3	KARATE UNION SHOTOKAN TIROL - NIKOLI EMA - LASTA KATJA - HARASSER MARISA	KARATE UNION SHOTOKAN TIROL		AUT - AUSTRIA	

Kata Team male U10					
1	ASKÖ SEIBUKAN LINZ	ASKÖ SEIBUKAN LINZ		AUT - AUSTRIA	

AUSTRIAN JUNIOR OPEN 2023 - 2023-06-24



Official Results

	- MALA_HAMZA HEM - MARKOVIC ANDREJ - HEINISCH LEON				
2	KARATE SHOTOKAN LORA ZELL AM SEE - GREGOR VILIAM - GASSER LORENZ_NOEL - BANIC SERGEJ	KARATE SHOTOKAN LORA ZELL AM SEE		AUT - AUSTRIA	
3	KARATE UNION SHOTOKAN TIROL - BICIOC ROMEO - OLINICI EDUARD - OBERDACHER MARKUS	KARATE UNION SHOTOKAN TIROL		AUT - AUSTRIA	
3	1.CKKS TRAUNREUT - RAUEN FERNANDO - MILIC MIKA - MENKE JONATHAN	1.CKKS TRAUNREUT		GER - GERMANY	

**Kata Team male U12**

1	ASIA SPORTS KARATESCHULE - FISCHER MARKUS - MEHLHAFF ALEXANDER - HÜTTER MICHAEL	ASIA SPORTS KARATESCHULE		GER - GERMANY	
2	ASKÖ SEIBUKAN LINZ - SEDEQY JOSEF - DZAFIC BEN - BEGANOVIC SELDIN	ASKÖ SEIBUKAN LINZ		AUT - AUSTRIA	
3	KARATE SHOTOKAN LORA ZELL AM SEE - VYSNA BRYAN - KOTAN EMIR - GRBIC ANDRE	KARATE SHOTOKAN LORA ZELL AM SEE		AUT - AUSTRIA	
3	LEISTUNGSZENTRUM WIEN - EBNER FABIO - ANDERL LIONEL - ANDERL LAUREL	LEISTUNGSZENTRUM WIEN		AUT - AUSTRIA	

**Kata Team male U14 U16**

1	KARATE ZANSHIN KOBLACH/HARD/BREGENZ - BUTTAZONI HUGO - STANIKAIE HEJRATULLAH - FEND LEO	KARATE ZANSHIN KOBLACH/HARD/BREGENZ		AUT - AUSTRIA	
2	KARATE UNION WALSERFELD - SCHACHINGER LORENZ - WALLNER NOAH - WALLNER JONAS	KARATE UNION WALSERFELD		AUT - AUSTRIA	
3	KARATE UNION WALSERFELD - KAPS LUKAS - SACHER THOMAS - MAIER ALEXANDER	KARATE UNION WALSERFELD		AUT - AUSTRIA	

**Kata Team male U18**

1	BUSHIDO KARATE PERUGIA - FUSCAGNI ALEX - GIOVAGNONI GIOELE - ROMAGNOLI EMANUEL	BUSHIDO KARATE PERUGIA		ITA - ITALY	
2	AKS FIRENZE	AKS FIRENZE		ITA - ITALY	

AUSTRIAN JUNIOR OPEN 2023 - 2023-06-24

Official Results

- MELANI MATTEO			
- DE_MEO MARCO			
- FIORAVANTI RICCARDO			

Kumite Individual female Cadets +61				
1	BATH ASTAMAJA	SPORTSKARATE.DK		DEN - DENMARK
2	GRÄFE LOTTE	SEIWAKAI TEAM		GER - GERMANY
3	REDZIC ESMA	SWISS KARATE UNION		SUI - SWITZERLAND
3	STAUB NIA	KARATESCHULE SURSEE		SUI - SWITZERLAND
5	ILIC MARTINA	KARATE UNION WALSERFELD		AUT - AUSTRIA
5	SCHALLER VANESSA	KARATE-DO ROCHLITZ E.V.		GER - GERMANY

Kumite Individual female Cadets -47				
1	CAPATTI GIADA	ASD TALARICO KARATE TEAM APS		ITA - ITALY
2	DREHMANN EMILY-CHIARA	SEIWAKAI TEAM		GER - GERMANY
3	LATTY KAYLIN	USA KARATE TEAM		USA - UNITED STATES
3	BABERSKE FABIENNE	BUSHIDO STOLLBERG E.V.		GER - GERMANY
5	STREIT MILA CHIARA	KARATEDO LYSS-AARBERG		SUI - SWITZERLAND
5	WICKLEIN AMY	NIPPON GOTHA E.V.		GER - GERMANY
7	FLEISCHMANN ALANY ALEXA	KARATE DO BRUGG		SUI - SWITZERLAND

Kumite Individual female Cadets -54				
1	HELLEN ILI	SEN5 KARATE VEREIN E.V.		GER - GERMANY
2	TANCAU SARA	ASD TALARICO KARATE TEAM APS		ITA - ITALY
3	SCHNETZER LARA	KARATE VORARLBERG		AUT - AUSTRIA
3	SINGLETON LOTTIE	USA KARATE TEAM		USA - UNITED STATES
5	TSCHARNER ANAIS	KARATEDO LYSS-AARBERG		SUI - SWITZERLAND
5	WIESNER NORA	LZ STEIERMARK		AUT - AUSTRIA
7	OLSZANSKA WIKTORIA	LEISTUNGSZENTRUM WIEN		AUT - AUSTRIA
7	SALVI CATERINA	ASD CENTRO STUDI KARATE NEGRAR		ITA - ITALY





Kumite Individual female Cadets -61				
1	DUTTO GIULIA	ASD TALARICO KARATE TEAM APS		ITA - ITALY
2	GUYE NINA	SWISS KARATE UNION		SUI - SWITZERLAND
3	ROCCA MARGHERITA	ASD TALARICO KARATE TEAM APS		ITA - ITALY
3	EMBLA REBEKKA HALLDÓRSDÓTTIR	KARATEFÉLAG REYKJAVÍKUR		ISL - ICELAND
5	KOVACEVIC LEONI	LEISTUNGSZENTRUM WIEN		AUT - AUSTRIA
5	MUSSWEILER MIA	SEN5 KARATE VEREIN E.V.		GER - GERMANY

## AUSTRIAN JUNIOR OPEN 2023 - 2023-06-24









## Official Results

7	LAVARNNWAY SYDNEY	USA KARATE TEAM		USA - UNITED STATES	
---	-------------------	-----------------	---	---------------------	--

Kumite Individual female Juniors +66					
1	HRVOIC LANA	1.CKKS TRAUNREUT		GER - GERMANY	
2	SPORTELLI ELISA	GARDA KARATE TEAM		ITA - ITALY	
3	MONTEBELLO CARLOTTA	ASD TALARICO KARATE TEAM APS		ITA - ITALY	
3	DEFRANCESCHI REBECCA	KARATE ZANSHIN KOBLACH/HARD/BREGENZ		AUT - AUSTRIA	

Kumite Individual female Juniors -48					
1	PÁLEŠOVÁ VIKTÓRIA	KARATE KLUB KUMADE TOPOĽČANY		SVK - SLOVAKIA	
2	SINGLETON SOPHIE	USA KARATE TEAM		USA - UNITED STATES	
3	CAPPAL AMBRA	ASD TALARICO KARATE TEAM APS		ITA - ITALY	
3	WYSSBROD SELIN	SWISS KARATE UNION		SUI - SWITZERLAND	
5	HOLZER DIETKE	1.CKKS TRAUNREUT		GER - GERMANY	
5	GALATEANU EVELYN	ASKÖ SEIBUKAN LINZ		AUT - AUSTRIA	

Kumite Individual female Juniors -53					
1	MARRUCCI VALENTINA	ASD TALARICO KARATE TEAM APS		ITA - ITALY	
2	GISSER ISABEL	1.CKKS TRAUNREUT		GER - GERMANY	
3	GRANDIC NIKOLINA	KARATEDO WELS		AUT - AUSTRIA	
3	BOUTRACIT AÏCHA	SWISS KARATE UNION		SUI - SWITZERLAND	
5	VIGNOGNA VIVIEN	KARATE DO BRUGG		SUI - SWITZERLAND	

Kumite Individual female Juniors -59					
1	SKRIJELJ SARA	KARATE VORARLBERG		AUT - AUSTRIA	
2	BEUTLER ELINA	SHUKOKAI DOJO WETZIKON		SUI - SWITZERLAND	
3	MAFFIZZOLI GAIA	GARDA KARATE TEAM		ITA - ITALY	
3	BURRI LILIANE	KARATEDO LYSS-AARBERG		SUI - SWITZERLAND	
5	BALLONI ANGELICA	AKS FIRENZE		ITA - ITALY	
5	LEISSNER LILLY	KARATE-DO ROCHLITZ E.V.		GER - GERMANY	
7	KRAVCHENKO KATERYNA	LZ OBERÖSTERREICH		AUT - AUSTRIA	
7	GROSSMANN DARJA	KIMURA SHUKOKAI KARATE LIMMATTAL		SUI - SWITZERLAND	

Kumite Individual female Juniors -66					
1	CORNOLO GIADA	KARATE NAKAYAMA		ITA - ITALY	
2	BONNY SHANIÁ	SWISS KARATE UNION		SUI - SWITZERLAND	
3	DUPERREX OKSANA	KARATE DO BRUGG		SUI - SWITZERLAND	

## AUSTRIAN JUNIOR OPEN 2023 - 2023-06-24

## Official Results

3	WOHLAND LEONIE	ASKÖ KARATE KARA		AUT - AUSTRIA	
5	FILINA AMINA	SEIWAKAI TEAM		GER - GERMANY	
5	CALUORI SVENJA	KARATE DO BRUGG		SUI - SWITZERLAND	

## Kumite individual female U10 +27

1	SCHMIDT LISA	ASIA SPORTS KARATESCHULE		GER - GERMANY	
2	TISAIANU GIULIA	ACCADEMIA DELLO SPORT LIVORNO		ITA - ITALY	

## KUMITE INDIVIDUAL FEMALE U10 +33kg

1	DOBRE MARIA	KARATE NAKAYAMA		ITA - ITALY	
2	PAYZINER ASYA	SSKF KARATE TEAM		SUI - SWITZERLAND	
3	GÄRTNER ANNA	KARATE UNION WALSERFELD		AUT - AUSTRIA	
3	DUSA NATALIE	SHUKOKAI DOJO WETZIKON		SUI - SWITZERLAND	

## Kumite Individual female U10 -27 kg

1	SATTER SARA	KVNNORDHORN		GER - GERMANY	
2	SATTER ANNA	KVNNORDHORN		GER - GERMANY	
3	LICATA GIULIA	ASD TALARICO KARATE TEAM APS		ITA - ITALY	
3	GRIMALDI GIUSI	ACCADEMIA DELLO SPORT LIVORNO		ITA - ITALY	

## KUMITE INDIVIDUAL FEMALE U10 -33kg

1	TANCAU ALESSIA	ASD TALARICO KARATE TEAM APS		ITA - ITALY	
2	TISAIANU GIULIA	ACCADEMIA DELLO SPORT LIVORNO		ITA - ITALY	

## Kumite Individual female U12 +36 kg

1	SPAMPINATO GIADA	ASD TALARICO KARATE TEAM APS		ITA - ITALY	
2	VOIGT JOHANNA	GOJU-KAI AMTSBERG E.V.		GER - GERMANY	
3	BERCHTOLD PAULINE	KARATE ZANSHIN KOBLAGH/HARD/ BREGENZ		AUT - AUSTRIA	
3	SCHLEGEL RONJA	GOJU-KAI AMTSBERG E.V.		GER - GERMANY	
5	JOCHUM JULIA	KARATE ZANSHIN KOBLAGH/HARD/ BREGENZ		AUT - AUSTRIA	
5	SHCHELKANOVA MASCHA	1.CKKS TRAUNREUT		GER - GERMANY	
7	NOLTE ALEXANDRA	KARATE ZANSHIN KOBLAGH/HARD/ BREGENZ		AUT - AUSTRIA	

## Kumite Individual female U12 -30 kg

1	KELLER ELLIE	SHUKOKAI DOJO WETZIKON		SUI - SWITZERLAND	
2	CETIN MEYRA	KARATE UNION WALSERFELD		AUT - AUSTRIA	

AUSTRIAN JUNIOR OPEN 2023 - 2023-06-24

Official Results

3	VIVIANI FRANCESCA SILVIA	GARDA KARATE TEAM		ITA - ITALY	
3	SIMONE SOFIA	ASD TALARICO KARATE TEAM APS		ITA - ITALY	
5	MIKA YAMAGUCHI	KARATE VORARLBERG		AUT - AUSTRIA	

**Kumite Individual female U12 -36 kg**

1	ALTENHOF MIRA	KVNNORDHORN		GER - GERMANY	
2	HANDRIKANDU SARA	KARATE NAKAYAMA		ITA - ITALY	
3	GRÜNER VALENTINA	SEN5 KARATE VEREIN E.V.		GER - GERMANY	
3	SIRICHENKO ANFISSA	SEN5 KARATE VEREIN E.V.		GER - GERMANY	
5	SAFI DANIA	FUNAKOSHI KARATE NORTHEIM		GER - GERMANY	
5	KOLAROVA VIKTORIA	KIMURA SHUKOKAI KARATE LIMMATTAL		SUI - SWITZERLAND	

**Kumite Individual female U12 Open**

1	ALTENHOF MIRA	KVNNORDHORN		GER - GERMANY	
2	VOIGT JOHANNA	GOJU-KAI AMTSBERG E.V.		GER - GERMANY	
3	SHCHELKANOVA MASCHA	1.CKKS TRAUNREUT		GER - GERMANY	
3	SCHLEGEL RONJA	GOJU-KAI AMTSBERG E.V.		GER - GERMANY	
5	EBNER LENA	KARATE UNION WALSERFELD		AUT - AUSTRIA	
5	ALIC ILMA	KARATE UNION WALSERFELD		AUT - AUSTRIA	
5	MIKA YAMAGUCHI	KARATE VORARLBERG		AUT - AUSTRIA	
5	CETIN MEYRA	KARATE UNION WALSERFELD		AUT - AUSTRIA	
9	GÄRTNER EVA	KARATE UNION WALSERFELD		AUT - AUSTRIA	
9	NEZIRI MELISA	LEISTUNGSZENTRUM WIEN		AUT - AUSTRIA	
9	MAYER MACY	KARATE VORARLBERG		AUT - AUSTRIA	
9	BAYRAM MIRA	KARATE VORARLBERG		AUT - AUSTRIA	

**Kumite Individual female U14 +52kg**

1	MATTYS MELINA	NIPPON GOTHA E.V.		GER - GERMANY	
2	BATH HANNAH	SPORTSKARATE.DK		DEN - DENMARK	
3	SCHINDLER MILEY	SEN5 KARATE VEREIN E.V.		GER - GERMANY	
3	FASTIGARI VIOLA EMILIA	IMPERO DEL SOLE A.S.D.		ITA - ITALY	
5	KEMETINGER SARAH	KARATE LEISTUNGSZENTRUM PINZGAU		AUT - AUSTRIA	
5	DI STEFANO LAVINIA	ASD TALARICO KARATE TEAM APS		ITA - ITALY	
7	ABBAS FIZA	RHEIN-NECKAR KNIGHTS		GER - GERMANY	

AUSTRIAN JUNIOR OPEN 2023 - 2023-06-24



Official Results

7	BERGMANN LIYA	TSV MONHEIM E.V.		GER - GERMANY	
---	---------------	------------------	---	---------------	--

**Kumite Individual female U14 -42 kg**

1	KIRISITS MIRA LISA	KARATE LEISTUNGSZENTRUM PINZGAU		AUT - AUSTRIA	
2	OLSCHEWSKI HANNA	LV SACHSEN-ANHALT		GER - GERMANY	
3	ÖZDEMIR DEMET	SWISS KARATE UNION		SUI - SWITZERLAND	
3	KHALIL LANA	FUNAKOSHI KARATE NORTHEIM		GER - GERMANY	
5	MICHAUD ZOË	KARATÉ CLUB JAGUAR VALLORBE		SUI - SWITZERLAND	
5	WIDMER ALISHA	KARATECENTER RETO KERN KREUZLINGEN		SUI - SWITZERLAND	
7	GIACOMINI SOPHIA	KARATE NAKAYAMA		ITA - ITALY	

**Kumite Individual female U14 -47 kg**

1	SANDHOLZER MAYA	KARATE VORARLBERG		AUT - AUSTRIA	
2	OMEROVIC ELINA	ASKÖ KARATE KARA		AUT - AUSTRIA	
3	VON KLASS MELISSA	KARATECENTER RETO KERN KREUZLINGEN		SUI - SWITZERLAND	
3	LEX FLORA	ASKÖ KARATE KARA		AUT - AUSTRIA	
5	PAYZINER SERENA	SSKF KARATE TEAM		SUI - SWITZERLAND	

**Kumite Individual female U14 -52**

1	ARCALEAN MIHAELA	USA KARATE TEAM		USA - UNITED STATES	
2	DUMITRAS PIA	SSKF KARATE TEAM		SUI - SWITZERLAND	
3	COBELLI MADDALENA	GARDA KARATE TEAM		ITA - ITALY	
3	GIRELLO ALESSANDRA	ASD TALARICO KARATE TEAM APS		ITA - ITALY	
5	SOPIC NOEMI	KARATE VORARLBERG		AUT - AUSTRIA	
5	DORDEVIC TEODOIRA	1.CKKS TRAUNREUT		GER - GERMANY	

**Kumite Individual female U14 Open**

1	FASTIGARI VIOLA EMILIA	IMPERO DEL SOLE A.S.D.		ITA - ITALY	
2	BATH HANNAH	SPORTSKARATE.DK		DEN - DENMARK	
3	SCHINDLER MILEY	SEN5 KARATE VEREIN E.V.		GER - GERMANY	
3	BAYRAM CEYLIN	KARATE VORARLBERG		AUT - AUSTRIA	
5	OLSCHEWSKI HANNA	LV SACHSEN-ANHALT		GER - GERMANY	
5	MICHAUD ZOË	KARATÉ CLUB JAGUAR VALLORBE		SUI - SWITZERLAND	
5	FRISCHKNECHT JESSICA	KARATECENTER RETO KERN KREUZLINGEN		SUI - SWITZERLAND	

AUSTRIAN JUNIOR OPEN 2023 - 2023-06-24

Official Results

5	SOPIC NOEMI	KARATE VORARLBERG		AUT - AUSTRIA	
9	MATTYS MELINA	NIPPON GOTHA E.V.		GER - GERMANY	
9	DUMITRAS PIA	SSKF KARATE TEAM		SUI - SWITZERLAND	
9	VON KLASS MELISSA	KARATECENTER RETO KERN KREUZLINGEN		SUI - SWITZERLAND	
9	WIDMER ALISHA	KARATECENTER RETO KERN KREUZLINGEN		SUI - SWITZERLAND	
9	ÖZDEMIR DEMET	SWISS KARATE UNION		SUI - SWITZERLAND	
17	PULVER MELINA	KARATEDO LYSS- AARBERG		SUI - SWITZERLAND	
17	ARIFAGIC ALMINA	SWISS KARATE UNION		SUI - SWITZERLAND	
17	BERGMANN LIYA	TSV MONHEIM E.V.		GER - GERMANY	
17	DORDEVIC TEODOIRA	1.CKKS TRAUNREUT		GER - GERMANY	
17	DALLA LANA GIANNA	SHUKOKAI DOJO WETZIKON		SUI - SWITZERLAND	
17	KHALIL LANA	FUNAKOSHI KARATE NORTHEIM		GER - GERMANY	





Kumite Individual female U16 Open

1	SINGLETON LOTTIE	USA KARATE TEAM		USA - UNITED STATES	
2	MUSSWEILER MIA	SEN5 KARATE VEREIN E.V.		GER - GERMANY	
3	SALVI CATERINA	ASD CENTRO STUDI KARATE NEGRAR		ITA - ITALY	
3	CETIN CEYLIN	KARATE UNION WALSERFELD		AUT - AUSTRIA	
5	BATH ASTAMAJA	SPORTSKARATE.DK		DEN - DENMARK	
5	SCHNETZER LARA	KARATE VORARLBERG		AUT - AUSTRIA	
5	SARTORI MARTINA	ASD KARATE BENACO		ITA - ITALY	
5	BABERSKE FABIENNE	BUSHIDO STOLLBERG E.V.		GER - GERMANY	
9	KOVACEVIC LEONI	LEISTUNGSZENTRUM WIEN		AUT - AUSTRIA	
9	DE CARLO LARISSA	SHUKOKAI DOJO WETZIKON		SUI - SWITZERLAND	
9	REDZIC ESMA	SWISS KARATE UNION		SUI - SWITZERLAND	
9	FAPPIANO ELENA	KARATE NAKAYAMA		ITA - ITALY	
9	HELLEN ILI	SEN5 KARATE VEREIN E.V.		GER - GERMANY	
9	LAVARNNWAY SYDNEY	USA KARATE TEAM		USA - UNITED STATES	
9	LEHNER LEONIE	LEISTUNGSZENTRUM WIEN		AUT - AUSTRIA	
9	GUYE NINA	SWISS KARATE UNION		SUI - SWITZERLAND	
17	EMBLA REBEKKA HALLDÓRSDÓTTIR	KARATEFÉLAG REYKJAVÍKUR		ISL - ICELAND	
17	ILIC MARTINA	KARATE UNION WALSERFELD		AUT - AUSTRIA	
17	HOUTHUIJSE MELANIE	KARATEDO LYSS- AARBERG		SUI - SWITZERLAND	



AUSTRIAN JUNIOR OPEN 2023 - 2023-06-24

Official Results

17	GJERGJAJ MELISA	KIMURA SHUKOKAI KARATE LIMMATTAL		SUI - SWITZERLAND	
17	BATH SOFIA	SPORTSKARATE.DK		DEN - DENMARK	
17	FLEISCHMANN ALANY ALEXA	KARATE DO BRUGG		SUI - SWITZERLAND	
17	WIESNER NORA	LZ STEIERMARK		AUT - AUSTRIA	
17	OLSZANSKA WIKTORIA	LEISTUNGSZENTRUM WIEN		AUT - AUSTRIA	
17	TSCHARNER ANAIS	KARATEDO LYSS- AARBERG		SUI - SWITZERLAND	
17	TSCHALER LARISSA	KARATE UNION WALSERFELD		AUT - AUSTRIA	
17	KNÜNZ JANA	KARATE VORARLBERG		AUT - AUSTRIA	
17	CROSATTI ELISA	ASD KARATE BENACO		ITA - ITALY	

**Kumite Individual female U18 Open**







1	DUPERREX OKSANA	KARATE DO BRUGG		SUI - SWITZERLAND	
2	BONNY SHANIA	SWISS KARATE UNION		SUI - SWITZERLAND	
3	STREIT KIM LARA	KARATEDO LYSS- AARBERG		SUI - SWITZERLAND	
3	WYSSBROD SELIN	SWISS KARATE UNION		SUI - SWITZERLAND	
5	SINGLETON SOPHIE	USA KARATE TEAM		USA - UNITED STATES	
5	WOHLAND LEONIE	ASKÖ KARATE KARA		AUT - AUSTRIA	
5	TOPAL MAGDALENA	KARATE UNION WALSERFELD		AUT - AUSTRIA	
5	BURRI LILIANE	KARATEDO LYSS- AARBERG		SUI - SWITZERLAND	
9	DEFRANCESCHI REBECCA	KARATE ZANSHIN KOBBLACH/HARD/ BREGENZ		AUT - AUSTRIA	
9	CALUORI SVENJA	KARATE DO BRUGG		SUI - SWITZERLAND	
9	BEUTLER ELINA	SHUKOKAI DOJO WETZIKON		SUI - SWITZERLAND	
9	SKRIJELJ SARA	KARATE VORARLBERG		AUT - AUSTRIA	
9	CORNOLO GIADA	KARATE NAKAYAMA		ITA - ITALY	
9	HRVOIC LANA	1.CKKS TRAUNREUT		GER - GERMANY	
9	VIGNOGNA VIVIEN	KARATE DO BRUGG		SUI - SWITZERLAND	
9	MÄHR MAGDALENA 26.03.21	KARATE VORARLBERG		AUT - AUSTRIA	

**Kumite Individual female U21 +68**

1	ISTOGU ELMEDINA	KLUBI I KARATESE IPPON-PRISHTINE		KOS - KOSOVO	
2	SCHUSTER NINA	KARATE LEISTUNGSZENTRUM PINZGAU		AUT - AUSTRIA	
3	POLJAK NINA	SHUKOKAI DOJO WETZIKON		SUI - SWITZERLAND	





AUSTRIAN JUNIOR OPEN 2023 - 2023-06-24

Official Results

Kumite Individual female U21 -50 -55				
1	HUBER LEA	KARATECENTER RETO KERN KREUZLINGEN		SUI - SWITZERLAND
2	LEDERER ALESSANDRA	KARATE LEISTUNGSZENTRUM PINZGAU		AUT - AUSTRIA
3	FABIAN SELINA	KARATE-DO ROCHLITZ E.V.		GER - GERMANY
3	BORTOT LUCIA	SWISS KARATE UNION		SUI - SWITZERLAND
5	KÖNIG MANJA	SEIWAKAI TEAM		GER - GERMANY
5	CERIANI GIULIA	IMPERO DEL SOLE A.S.D.		ITA - ITALY

Kumite Individual female U21 -61				
1	BOSSHARD LEA MARIE	KARATEDO LYSS- AARBERG		SUI - SWITZERLAND
2	DON ALICE	GARDA KARATE TEAM		ITA - ITALY
3	ZEHENTBAUER TINA	TSV VILSBIBURG 1883 E.V.		GER - GERMANY
3	MARJANOVIC ANDRIJANA	KARATE UNION WALSERFELD		AUT - AUSTRIA
5	METTI LUCIA	AKS FIRENZE		ITA - ITALY
5	RONJA HALLDÓRSDÓTTIR	KARATEFÉLAG REYKJAVÍKUR		ISL - ICELAND

Kumite Individual female U21 -68				
1	VUKOVIC MARINA	KARATE LEISTUNGSZENTRUM PINZGAU		AUT - AUSTRIA
2	KEMETINGER SOPHIE	KARATE LEISTUNGSZENTRUM PINZGAU		AUT - AUSTRIA
3	EYDIS MAGNEA FRIDRIKSDÓTTIR	KARATEFÉLAG REYKJAVÍKUR		ISL - ICELAND
3	DEUBLE SARA	KARATEDO LYSS- AARBERG		SUI - SWITZERLAND

Kumite Individual female U21 Open				
1	DEUBLE SARA	KARATEDO LYSS- AARBERG		SUI - SWITZERLAND
2	BOSSHARD LEA MARIE	KARATEDO LYSS- AARBERG		SUI - SWITZERLAND
3	FABIAN SELINA	KARATE-DO ROCHLITZ E.V.		GER - GERMANY
3	ISTOGU ELMEDINA	KLUBI I KARATESE IPPON-PRISHTINE		KOS - KOSOVO
5	EYDIS MAGNEA FRIDRIKSDÓTTIR	KARATEFÉLAG REYKJAVÍKUR		ISL - ICELAND
5	BORTOT LUCIA	SWISS KARATE UNION		SUI - SWITZERLAND
5	CERIANI GIULIA	IMPERO DEL SOLE A.S.D.		ITA - ITALY
5	HUBER LEA	KARATECENTER RETO KERN KREUZLINGEN		SUI - SWITZERLAND

AUSTRIAN JUNIOR OPEN 2023 - 2023-06-24

Official Results

9	RONJA HALLDÓRSDÓTTIR	KARATEFÉLAG REYKJAVÍKUR		ISL - ICELAND	
9	ZEHENTBAUER TINA	TSV VILSBIBURG 1883 E.V.		GER - GERMANY	
9	METTI LUCIA	AKS FIRENZE		ITA - ITALY	

**Kumite Individual male Cadets +70**

1	CZUDOR OLIVÉR	DMTK HUN		HUN - HUNGARY	
2	DEBRO JAKOB	KARATE LEISTUNGSZENTRUM PINZGAU		AUT - AUSTRIA	
3	DRAMALIJA MUHAMED	ASKÖ KARATE STEYR		AUT - AUSTRIA	
3	VERRASTRO RICCARDO	ASD TALARICO KARATE TEAM APS		ITA - ITALY	
5	KNAUER BENEDIKT	TSV MONHEIM E.V.		GER - GERMANY	
5	BANDELIER MATHIS	SWISS KARATE UNION		SUI - SWITZERLAND	
7	LOSHAJ MURAT	KIMURA SHUKOKAI KARATE LIMMATTAL		SUI - SWITZERLAND	
7	RISITO MATTEO	AKS FIRENZE		ITA - ITALY	

**Kumite Individual male Cadets -52**

1	DAN CHRISTIAN	CENTRO KARATE RIMINI		ITA - ITALY	
2	ALTENHOF NICO	KVNNORDHORN		GER - GERMANY	
3	FRISCHKNECHT RILEY	KARATECENTER RETO KERN KREUZLINGEN		SUI - SWITZERLAND	
3	UEBERFELD FABIAN	RHEIN-NECKAR KNIGHTS		GER - GERMANY	
5	LIM HAO YI	KIMURA SHUKOKAI KARATE LIMMATTAL		SUI - SWITZERLAND	
5	GALATEANU DAVID	ASKÖ SEIBUKAN LINZ		AUT - AUSTRIA	

**Kumite Individual male Cadets -57**

1	SAFI HEIDAR	FUNAKOSHI KARATE NORTHEIM		GER - GERMANY	
2	KABASHI ELSON JASON	ELSON SPORT & KARATE		SUI - SWITZERLAND	
3	NIEDERELZ TIM	SEN5 KARATE VEREIN E.V.		GER - GERMANY	
3	SCHILLACI SAMUELE	SSKF KARATE TEAM		SUI - SWITZERLAND	
5	STRIESCHE MARVIN	KARATE-DO ROCHLITZ E.V.		GER - GERMANY	
5	WENGER LEVIN	SWISS KARATE UNION		SUI - SWITZERLAND	
7	SCHNEIDER JONAS	KARATE-DO ROCHLITZ E.V.		GER - GERMANY	

**Kumite Individual male Cadets -63**

1	THIERBACH LUCA	SEIWAKAI TEAM		GER - GERMANY	
2	FLEISCH TOBIAS	KARATE VORARLBERG		AUT - AUSTRIA	
3	ROLA LUKA	KARATE KLUB KOVINAR MARIBOR		SLO - SLOVENIA	

AUSTRIAN JUNIOR OPEN 2023 - 2023-06-24

Official Results

3	VOIGT TILMANN	GOJU-KAI AMTSBERG E.V.		GER - GERMANY	
5	UVA NEVIO	KARATEDO LYSS- AARBERG		SUI - SWITZERLAND	
5	CIAVARELLA RICCARDO	ASD TALARICO KARATE TEAM APS		ITA - ITALY	
7	COKOVIC BENJAMIN	KARATESCHULE SURSEE		SUI - SWITZERLAND	
7	WINTERSPERGER LORENZ	ASKÖ KARATE SEIBUKAN NEUHOFEN		AUT - AUSTRIA	

**Kumite Individual male Cadets -70**

1	KNOPP PHIL	LV SACHSEN- ANHALT		GER - GERMANY	
2	PEDRO THÉO	SWISS KARATE UNION		SUI - SWITZERLAND	
3	PLATISA PASCAL	KARATE VORARLBERG		AUT - AUSTRIA	
3	MUSTAFA HARIS	KLUBI I KARATESE IPPON-PRISHTINE		KOS - KOSOVO	
5	EBNER LUCA	KARATE UNION WALSERFELD		AUT - AUSTRIA	
5	HERZOG WILHELM	SEIWAKAI TEAM		GER - GERMANY	
7	LATTY JONAH	USA KARATE TEAM		USA - UNITED STATES	
7	HALBICH NICOLAS	SWISS KARATE UNION		SUI - SWITZERLAND	

**Kumite Individual male Juniors +76**

1	KLEINEKATHÖFER JAKOB	KARATE VORARLBERG		AUT - AUSTRIA	
2	KLEINEKATHÖFER VINCENT	KARATE VORARLBERG		AUT - AUSTRIA	
3	SELIMOVIC ARMIN	KARATE UNION WALSERFELD		AUT - AUSTRIA	
3	HUGI HALLDÓRSSON	KARATEFÉLAG REYKJAVÍKUR		ISL - ICELAND	
5	MAGNELLI EMANUELE	ACCADEMIA DELLO SPORT LIVORNO		ITA - ITALY	
5	SHAMSI DANIEL	TSV GRASBRUNN- NEUKEFERLOH		GER - GERMANY	
7	ILIC MARKO	KARATE UNION WALSERFELD		AUT - AUSTRIA	

**Kumite Individual male Juniors -55**

1	STRIESCHE DUSTIN	KARATE-DO ROCHLITZ E.V.		GER - GERMANY	
2	FRIEDRICH ANDRE	FUNAKOSHI KARATE NORTHEIM		GER - GERMANY	
3	LANG MARCUS	LEISTUNGSZENTRUM WIEN		AUT - AUSTRIA	
3	KURY TIAGO	SWISS KARATE UNION		SUI - SWITZERLAND	
5	COSSE ETIENNE	SSKF KARATE TEAM		SUI - SWITZERLAND	

**Kumite Individual male Juniors -61**

1	ZARIC VID	KARATE KLUB KOVINAR MARIBOR		SLO - SLOVENIA	
---	-----------	--------------------------------	---	----------------	--

AUSTRIAN JUNIOR OPEN 2023 - 2023-06-24







Official Results

2	KINDLER IAN	FUNAKOSHI KARATE NORTHEIM		GER - GERMANY	
3	CSURGAI JULIEN	SWISS KARATE UNION		SUI - SWITZERLAND	
3	NASSER PAOLO	ASD TALARICO KARATE TEAM APS		ITA - ITALY	
5	RURIS ADRIAN	SEN5 KARATE VEREIN E.V.		GER - GERMANY	

**Kumite Individual male Juniors -68**

1	TORRES STEVEN	SSKF KARATE TEAM		SUI - SWITZERLAND	
2	LORENZ SWAN	SWISS KARATE UNION		SUI - SWITZERLAND	
3	STAMER NARVIK	SEIWAKAI TEAM		GER - GERMANY	
3	NITZ ANDREAS	KARATE VORARLBERG		AUT - AUSTRIA	
5	WERFF KAI	UNITY99		NED - NETHERLANDS	
5	NÁDUDVARI-KISS AMBRUS	DMTK HUN		HUN - HUNGARY	
7	HAUBOLD MIKA	FUNAKOSHI KARATE NORTHEIM		GER - GERMANY	
7	RIZZATI THOMAS	KARATE NAKAYAMA		ITA - ITALY	

**Kumite Individual male Juniors -76**

1	MARCHIONI MATHEO	SWISS KARATE UNION		SUI - SWITZERLAND	
2	GIESINGER LEON 26.03.21	KARATE VORARLBERG		AUT - AUSTRIA	
3	GRIGORASENCO NICHITA	LZ OBERÖSTERREICH		AUT - AUSTRIA	
3	SCHMELZER MARIUS	LZ STEIERMARK		AUT - AUSTRIA	
5	HASANI LUAN	ASKÖ SEIBUKAN LINZ		AUT - AUSTRIA	
5	SANARICA NICCOLO	ELSON SPORT & KARATE		SUI - SWITZERLAND	

**Kumite Individual male U12 +38 kg**

1	TIEFENAUER JONATHAN	SSKF KARATE TEAM		SUI - SWITZERLAND	
2	TALARICO MAURIZIO	ASD TALARICO KARATE TEAM APS		ITA - ITALY	
3	MOSAVI ABOLFASLI	LEISTUNGSZENTRUM WIEN		AUT - AUSTRIA	
3	SCHNETZER ERIC	KARATE VORARLBERG		AUT - AUSTRIA	
5	CIAVARELLA NICCOLO	ASD TALARICO KARATE TEAM APS		ITA - ITALY	
5	FELLINGER PHILIPP	1.CKKS TRAUNREUT		GER - GERMANY	
7	SEDEQY JOSEF	ASKÖ SEIBUKAN LINZ		AUT - AUSTRIA	

**Kumite Individual male U12 -32 kg**

1	KARACA ILYAS	LV SACHSEN- ANHALT		GER - GERMANY	
2	CLINGO ELIA	KIMURA SHUKOKAI KARATE LIMMATTAL		SUI - SWITZERLAND	
3	HURLER ELIAH	TSV MONHEIM E.V.		GER - GERMANY	
3	FRANCHI GIUSEPPE	KARATE NAKAYAMA		ITA - ITALY	

AUSTRIAN JUNIOR OPEN 2023 - 2023-06-24

Official Results

5	DZAFIC BEN	ASKÖ SEIBUKAN LINZ		AUT - AUSTRIA	
5	FAVALLI LEONARDO	GARDA KARATE TEAM		ITA - ITALY	

Kumite Individual male U12 -38 kg					
1	ARIFI ARIS	KLUBI I KARATESE IPPON-PRISHTINE		KOS - KOSOVO	
2	MAGNELLI LEONARDO	ACCADEMIA DELLO SPORT LIVORNO		ITA - ITALY	
3	EBNER FABIO	LEISTUNGSZENTRUM WIEN		AUT - AUSTRIA	
3	PRAGER SEBASTIAN	LEISTUNGSZENTRUM WIEN		AUT - AUSTRIA	
5	FEND LEO	KARATE ZANSHIN KOBLACH/HARD/ BREGENZ		AUT - AUSTRIA	
5	GRUCHOT MAXIMILIAN	1.CKKS TRAUNREUT		GER - GERMANY	

Kumite Individual male U12 Open					
1	KARACA ILYAS	LV SACHSEN-ANHALT		GER - GERMANY	
2	TIEFENAUER JONATHAN	SSKF KARATE TEAM		SUI - SWITZERLAND	
3	EBNER FABIO	LEISTUNGSZENTRUM WIEN		AUT - AUSTRIA	
3	ARIFI ARIS	KLUBI I KARATESE IPPON-PRISHTINE		KOS - KOSOVO	
5	MAGNELLI LEONARDO	ACCADEMIA DELLO SPORT LIVORNO		ITA - ITALY	
5	SCHNETZER ERIC	KARATE VORARLBERG		AUT - AUSTRIA	
5	FELLINGER PHILIPP	1.CKKS TRAUNREUT		GER - GERMANY	
5	GRUCHOT MAXIMILIAN	1.CKKS TRAUNREUT		GER - GERMANY	

Kumite Individual male U14 +55 kg					
1	FASTIGARI VALERIO LUIGI	IMPERO DEL SOLE A.S.D.		ITA - ITALY	
2	BORASO TANCREDI	ASD HEIAN BUSHI DO		ITA - ITALY	
3	LAMPERSBERGER VINCENT	ASIA SPORTS KARATESCHULE		GER - GERMANY	
3	KOMADINA ANDREJ	KIMURA SHUKOKAI KARATE LIMMATTAL		SUI - SWITZERLAND	

Kumite Individual male U14 -40 kg					
1	MAURER NOAH	SHUKOKAI DOJO WETZIKON		SUI - SWITZERLAND	
2	LÜTHY CORSIN DION	KARATE DO BRUGG		SUI - SWITZERLAND	
3	ARNAUT DANIS	LEISTUNGSZENTRUM WIEN		AUT - AUSTRIA	
3	LIBIK DANIEL	ASIA SPORTS KARATESCHULE		GER - GERMANY	
5	GUBLER LINUS	SHUKOKAI DOJO WETZIKON		SUI - SWITZERLAND	
5	MATEUS GOMES LEONARDO	KARATE DO BRUGG		SUI - SWITZERLAND	
7	BLAGA ALEXANDRU	KARATE LEISTUNGSZENTRUM PINZGAU		AUT - AUSTRIA	



AUSTRIAN JUNIOR OPEN 2023 - 2023-06-24

Official Results

Kumite Individual male U14 -45 kg				
1	NASSER DIEGO	ASD TALARICO KARATE TEAM APS		ITA - ITALY
2	ACKERBAUER ANDREAS	ASKÖ SEIBUKAN LINZ		AUT - AUSTRIA
3	HANKOWETZ JAKOB	ASKÖ KARATE SEIBUKAN NEUHOFEN		AUT - AUSTRIA
3	ZURLINDEN JESSE	KARATECENTER RETO KERN KREUZLINGEN		SUI - SWITZERLAND
5	HERCZ BENCE	DMTK HUN		HUN - HUNGARY
5	WITTMER LEO	KD STRAUBING		GER - GERMANY
7	LIMACHER RAMON	SWISS KARATE UNION		SUI - SWITZERLAND

Kumite Individual male U14 -50 kg				
1	RAVAS KARL	SHUKOKAI DOJO WETZIKON		SUI - SWITZERLAND
2	NAMYSLIK FELIX	SEIWAKAI TEAM		GER - GERMANY
3	ZECCA LUCAS	SWISS KARATE UNION		SUI - SWITZERLAND
3	SOLIARYK PLATON	SWISS KARATE UNION		SUI - SWITZERLAND
5	BEKTIC ARMIN	KARATE UNION WALSERFELD		AUT - AUSTRIA
5	SCHICCHI STEFANO	ASD TALARICO KARATE TEAM APS		ITA - ITALY
7	PIETRONI NICOLAS	ACCADEMIA DELLO SPORT LIVORNO		ITA - ITALY

Kumite Individual male U14 -55 kg				
1	CHEBAN ALEXANDER	LZ OBERÖSTERREICH		AUT - AUSTRIA
2	KUCHEL LENNOX	LV SACHSEN- ANHALT		GER - GERMANY
3	CERQUI STEFANO	KARATE NAKAYAMA		ITA - ITALY
3	JENNI LORENZ	KARATE VORARLBERG		AUT - AUSTRIA
5	GRYNCHAK OLEKSANDR	SPORTUNION SHUHARI GRAZ		AUT - AUSTRIA
5	BRADLER LUCA	FUNAKOSHI KARATE NORTHEIM		GER - GERMANY
7	LICATA ANDREA	ASD TALARICO KARATE TEAM APS		ITA - ITALY

Kumite Individual male U14 Open				
1	ZECCA LUCAS	SWISS KARATE UNION		SUI - SWITZERLAND
2	ZURLINDEN JESSE	KARATECENTER RETO KERN KREUZLINGEN		SUI - SWITZERLAND
3	KUCHEL LENNOX	LV SACHSEN- ANHALT		GER - GERMANY
3	LÜTHY CORSIN DION	KARATE DO BRUGG		SUI - SWITZERLAND
5	RAVAS KARL	SHUKOKAI DOJO WETZIKON		SUI - SWITZERLAND

AUSTRIAN JUNIOR OPEN 2023 - 2023-06-24

Official Results

5	ROSSMANN LEON	TSV MONHEIM E.V.		GER - GERMANY	
5	PATRICIO-CLÉMONT JOHAN	KASHIVA KAN BIENNE		SUI - SWITZERLAND	
9	KAMILOVSKI DENY	KIMURA SHUKOKAI KARATE LIMMATTAL		SUI - SWITZERLAND	
9	FASTIGARI VALERIO LUIGI	IMPERO DEL SOLE A.S.D.		ITA - ITALY	
9	JENNI LORENZ	KARATE VORARLBERG		AUT - AUSTRIA	
9	LAMPERSBERGER VINCENT	ASIA SPORTS KARATESCHULE		GER - GERMANY	
9	BOUKROUH AHMED	1.CKKS TRAUNREUT		GER - GERMANY	
9	ERHARDT TRULS	KARATEKLUBB ELIT		SWE - SWEDEN	
9	GUBLER LINUS	SHUKOKAI DOJO WETZIKON		SUI - SWITZERLAND	
17	MATEUS GOMES LEONARDO	KARATE DO BRUGG		SUI - SWITZERLAND	
17	BEKTIC ARMIN	KARATE UNION WALSERFELD		AUT - AUSTRIA	
17	MARRUCCI FILIPPO	ASD TALARICO KARATE TEAM APS		ITA - ITALY	
17	BAUMGARNTER CEBRAIL	SSKF KARATE TEAM		SUI - SWITZERLAND	
17	KOMADINA ANDREJ	KIMURA SHUKOKAI KARATE LIMMATTAL		SUI - SWITZERLAND	

Kumite Individual male U16 Open

1	KNOPP PHIL	LV SACHSEN-ANHALT		GER - GERMANY	
2	PLATISA PASCAL	KARATE VORARLBERG		AUT - AUSTRIA	
3	VOIGT TILMANN	GOJU-KAI AMTSBERG E.V.		GER - GERMANY	
3	BUHURCU JIYAN	KARATE DO BRUGG		SUI - SWITZERLAND	
5	STRIESCHE MARVIN	KARATE-DO ROCHLITZ E.V.		GER - GERMANY	
5	EBNER LUCA	KARATE UNION WALSERFELD		AUT - AUSTRIA	
5	LATTY JONAH	USA KARATE TEAM		USA - UNITED STATES	
5	SCHILLACI SAMUELE	SSKF KARATE TEAM		SUI - SWITZERLAND	
9	DABOUBI YASSINE	SWISS KARATE UNION		SUI - SWITZERLAND	
9	DRAMALIJA MUHAMED	ASKÖ KARATE STEYR		AUT - AUSTRIA	
9	DAN CHRISTIAN	CENTRO KARATE RIMINI		ITA - ITALY	
9	RISITO MATTEO	AKS FIRENZE		ITA - ITALY	
9	MUSTAFA HARIS	KLUBI I KARATESE IPPON-PRISHTINE		KOS - KOSOVO	
9	MAYR WERNER	ASKÖ SEIBUKAN LINZ		AUT - AUSTRIA	
9	FLEISCH TOBIAS	KARATE VORARLBERG		AUT - AUSTRIA	
17	ZURLINDEN BENJAMIN	KARATECENTER RETO KERN KREUZLINGEN		SUI - SWITZERLAND	
17	LOSHAJ MURAT	KIMURA SHUKOKAI KARATE LIMMATTAL		SUI - SWITZERLAND	



AUSTRIAN JUNIOR OPEN 2023 - 2023-06-24

Official Results

17	NIEDERELZ TIM	SEN5 KARATE VEREIN E.V.		GER - GERMANY	
17	UVA NEVIO	KARATEDO LYSS- AARBERG		SUI - SWITZERLAND	
17	STANIKZAIE HEJRATULLAH	KARATE ZANSHIN KOBBLACH/HARD/ BREGENZ		AUT - AUSTRIA	
17	KNAUER BENEDIKT	TSV MONHEIM E.V.		GER - GERMANY	
17	CAMARDA CLAUDIO	IMPERO DEL SOLE A.S.D.		ITA - ITALY	
17	PEDRO THÉO	SWISS KARATE UNION		SUI - SWITZERLAND	
17	ALTENHOF NICO	KVNNORDHORN		GER - GERMANY	
17	WENGER LEVIN	SWISS KARATE UNION		SUI - SWITZERLAND	
17	FRISCHKNECHT RILEY	KARATECENTER RETO KERN KREUZLINGEN		SUI - SWITZERLAND	
17	BANDELIER MATHIS	SWISS KARATE UNION		SUI - SWITZERLAND	
17	HELLER BEN	LV SACHSEN- ANHALT		GER - GERMANY	
33	MATEUS GOMES CRISTIANO	KARATE DO BRUGG		SUI - SWITZERLAND	
33	SIEBER ELIJA	KARATECENTER RETO KERN KREUZLINGEN		SUI - SWITZERLAND	

**Kumite Individual male U18 Open**

1	JOST RUBEN	KARATEDO LYSS- AARBERG		SUI - SWITZERLAND	
2	TSCHENISCH THORE	LV BRANDENBURG		GER - GERMANY	
3	ULQINAKU LEONARDO	AKS FIRENZE		ITA - ITALY	
3	PEZZEI FABIAN	KARATE MÜHLBACH		ITA - ITALY	
5	LORENZ SWAN	SWISS KARATE UNION		SUI - SWITZERLAND	
5	RIZZATI THOMAS	KARATE NAKAYAMA		ITA - ITALY	
5	BALLIN CHRISTOPHER	LV SACHSEN- ANHALT		GER - GERMANY	
5	KLEINEKATHÖFER JAKOB	KARATE VORARLBERG		AUT - AUSTRIA	
9	SOLAZZO ILARIO NAZARENO	KIMURA SHUKOKAI KARATE LIMMATTAL		SUI - SWITZERLAND	
9	TORRES STEVEN	SSKF KARATE TEAM		SUI - SWITZERLAND	
9	KLEINEKATHÖFER VINCENT	KARATE VORARLBERG		AUT - AUSTRIA	
9	QUADT LUKAS	TEIKYO KARATE TEAM E.V.		GER - GERMANY	
9	SCHMELZER MARIUS	LZ STEIERMARK		AUT - AUSTRIA	
9	RURIS ADRIAN	SEN5 KARATE VEREIN E.V.		GER - GERMANY	
9	EFTIMIE EDUARD	IMPERO DEL SOLE A.S.D.		ITA - ITALY	
9	VRANJES ANDREJ	KARATE DO BRUGG		SUI - SWITZERLAND	
17	MAGNELLI EMANUELE	ACCADEMIA DELLO SPORT LIVORNO		ITA - ITALY	
17	NITZ ANDREAS	KARATE VORARLBERG		AUT - AUSTRIA	

AUSTRIAN JUNIOR OPEN 2023 - 2023-06-24

Official Results

17	VOGEL KASPAR	SWISS KARATE UNION		SUI - SWITZERLAND	
17	SELIMOVIC ARMIN	KARATE UNION WALSERFELD		AUT - AUSTRIA	
17	CSURGAI JULIEN	SWISS KARATE UNION		SUI - SWITZERLAND	
17	TSCHARNER LOAN	KARATEDO LYSS-AARBERG		SUI - SWITZERLAND	
17	HAUBOLD MIKA	FUNAKOSHI KARATE NORTHEIM		GER - GERMANY	
17	DOBBERSTEIN LENNOX	KARATE DO BRUGG		SUI - SWITZERLAND	
17	HUGI HALLDÓRSSON	KARATEFÉLAG REYKJAVÍKUR		ISL - ICELAND	
17	KÜHNEL HENRIK	KARATE UNION WALSERFELD		AUT - AUSTRIA	
17	MARCHIONI MATHEO	SWISS KARATE UNION		SUI - SWITZERLAND	
17	SANARICA NICCOLO	ELSON SPORT & KARATE		SUI - SWITZERLAND	
17	GIESINGER LEON 26.03.21	KARATE VORARLBERG		AUT - AUSTRIA	
17	ILIC MARKO	KARATE UNION WALSERFELD		AUT - AUSTRIA	
17	KINDLER IAN	FUNAKOSHI KARATE NORTHEIM		GER - GERMANY	

**Kumite Individual male U21 -60**

1	TIMMER ERIC	SSKF KARATE TEAM		SUI - SWITZERLAND	
2	HUSKIC DENIS	ASKO SEIBUKAN LINZ		AUT - AUSTRIA	

**Kumite Individual male U21 -67**

1	BARANYI BARNABAS	KARATE DO BRUGG		SUI - SWITZERLAND	
2	BÖHLER YANNICK	KARATE VORARLBERG		AUT - AUSTRIA	

**Kumite Individual male U21 -75**

1	JANOVCIK MAROS	KARATE LEISTUNGSZENTRUM PINZGAU		AUT - AUSTRIA	
2	NIGSCH ADRIAN	KARATE VORARLBERG		AUT - AUSTRIA	
3	FISCHNALLER FLORIAN	KARATE MÜHLBACH		ITA - ITALY	
3	SPARER NICO	SSKF KARATE TEAM		SUI - SWITZERLAND	

**Kumite Individual male U21 -84 +84**

1	GASHI MELOS	KARATE CLUB OLIMP		KOS - KOSOVO	
2	HAUBOLD JANNE	FUNAKOSHI KARATE NORTHEIM		GER - GERMANY	
3	DEUTSCH PASCAL	SEIWAKAI TEAM		GER - GERMANY	
3	SADIKOVIC EMIL	KARATE LEISTUNGSZENTRUM PINZGAU		AUT - AUSTRIA	
5	ROUËCHE DAVID	SWISS KARATE UNION		SUI - SWITZERLAND	
5	KABASHI JOHN	ELSON SPORT & KARATE		SUI - SWITZERLAND	

AUSTRIAN JUNIOR OPEN 2023 - 2023-06-24

Official Results

Kumite Individual male U21 Open				
1	GASHI MELOS	KARATE CLUB OLIMP		KOS - KOSOVO
2	HAUBOLD JANNE	FUNAKOSHI KARATE NORTHEIM		GER - GERMANY
3	BARANYI BARNABAS	KARATE DO BRUGG		SUI - SWITZERLAND
3	NIGSCH ADRIAN	KARATE VORARLBERG		AUT - AUSTRIA
5	GARIBOLDI MIRKO	IMPERO DEL SOLE A.S.D.		ITA - ITALY
5	SPARER NICO	SSKF KARATE TEAM		SUI - SWITZERLAND
5	FISCHNALLER FLORIAN	KARATE MÜHLBACH		ITA - ITALY
5	ROUËCHE DAVID	SWISS KARATE UNION		SUI - SWITZERLAND
9	BÖHLER YANNICK	KARATE VORARLBERG		AUT - AUSTRIA



Kumite male U10 +34kg				
1	HEINISCH LEON	ASKÖ SEIBUKAN LINZ		AUT - AUSTRIA
2	BUTTAZONI HUGO	KARATE ZANSHIN KOBACH/HARD/ BREGENZ		AUT - AUSTRIA
3	MARIC BOJAN	KARATE UNION WALSERFELD		AUT - AUSTRIA
3	FISCHER MARKUS	ASIA SPORTS KARATESCHULE		GER - GERMANY

kumite male u10 -28 kg				
1	TONNI ALESSANDRO	GARDA KARATE TEAM		ITA - ITALY
2	SCHMIDT MAXIMILIAN	ASIA SPORTS KARATESCHULE		GER - GERMANY
3	REICHL FINN	ASKÖ KARATE SEIBUKAN NEUHOFEN		AUT - AUSTRIA

Kumite male U10 -34kg				
1	ARIFI BENET	KLUBI I KARATESE IPPON-PRISHTINE		KOS - KOSOVO
2	MARKOVIC ANDREJ	ASKÖ SEIBUKAN LINZ		AUT - AUSTRIA
3	MALA HAMZA HEM	ASKÖ SEIBUKAN LINZ		AUT - AUSTRIA
3	MC GUINNESS COLIN	SHUKOKAI DOJO WETZIKON		SUI - SWITZERLAND
5	ANDERL LIONEL	LEISTUNGSZENTRUM WIEN		AUT - AUSTRIA
5	HUBER NIKLAS	ASKÖ KARATE SEIBUKAN NEUHOFEN		AUT - AUSTRIA



























## AUSTRIAN JUNIOR OPEN 2023 - 2023-06-24

## Medals - Club

Rank	Club	1. Place	2. Place	3. Place
1	 ASIA SPORTS KARATESCHULE, GER	6	6	7
2	 ASD TALARICO KARATE TEAM APS, ITA	6	2	8
3	 LV SACHSEN-ANHALT, GER	4	2	1
4	 SWISS KARATE UNION, SUI	3	7	12
5	 KARATE VORARLBERG, AUT	3	6	8
6	 KARATE LEISTUNGSZENTRUM PINZGAU, AUT	3	4	1
7	 SSKF KARATE TEAM, SUI	3	3	2
8	 KVNNORDHORN, GER	3	2	0
9	 SHUKOKAI DOJO WETZIKON, SUI	3	1	4
10	 KARATEDO LYSS-AARBERG, SUI	3	1	3
11	 KLUBI I KARATESE IPPON-PRISHTINE, KOS	3	0	3
12	 ASKÖ SEIBUKAN LINZ, AUT	2	5	1
13	 BUSHIDO KARATE PERUGIA, ITA	2	2	1
14	 KARATE DO BRUGG, SUI	2	1	5
15	 KARATE NAKAYAMA, ITA	2	1	2
	 USA KARATE TEAM, USA	2	1	2
	 KARATE ZANSHIN KOBLACH/HARD/BREGENZ, AUT	2	1	2
18	 FRIEWAYS KARATEKLUB, AUT	2	1	1
19	 LEISTUNGSZENTRUM WIEN, AUT	2	0	7
20	 IMPERO DEL SOLE A.S.D., ITA	2	0	1
21	 A.S.D. ARTESPORT, ITA	2	0	0
	 KARATE CLUB OLIMP, KOS	2	0	0
23	 KARATE UNION WALSERFELD, AUT	1	4	7
24	 FUNAKOSHI KARATE NORTHEIM, GER	1	4	1
25	 SEIWAKAI TEAM, GER	1	3	2
26	 GARDA KARATE TEAM, ITA	1	2	3
27	 SPORTSKARATE.DK, DEN	1	2	0
28	 SEN5 KARATE VEREIN E.V., GER	1	1	5
29	 KARATECENTER RETO KERN KREUZLINGEN, SUI	1	1	3
30	 1.CKKS TRAUNREUT, GER	1	1	2
	 KARATE UNION KACHIKAN, AUT	1	1	2
32	 KARATE EMME, SUI	1	0	3
33	 KARATE-DO ROCHLITZ E.V., GER	1	0	2
34	 KARATE KLUB KOVINAR MARIBOR, SLO	1	0	1
	 LZ OBERÖSTERREICH, AUT	1	0	1
	 OKINAWA, UKR	1	0	1
37	 A.S.D. VILLA PIGNA KARATE, ITA	1	0	0
	 DMTK HUN, HUN	1	0	0
	 CENTRO KARATE RIMINI, ITA	1	0	0
	 NIPPON GOTHA E.V., GER	1	0	0
	 EKTS LAUSANNE VUFFLENS, SUI	1	0	0
	 KARATE KLUB KUMADE TOPOĽČANY, SVK	1	0	0
43	 ACCADEMIA DELLO SPORT LIVORNO, ITA	0	3	1
44	 GOJU-KAI AMTSBERG E.V., GER	0	2	4
45	 KARATE SHOTOKAN LORA ZELL AM SEE, AUT	0	2	2
	 KARATE UNION SHOTOKAN TIROL, AUT	0	2	2
47	 ASKÖ KARATE KARA, AUT	0	1	2

## AUSTRIAN JUNIOR OPEN 2023 - 2023-06-24

## Medals - Club

		KIMURA SHUKOKAI KARATE LIMMATTAL, SUI	0	1	2
		AKS FIRENZE, ITA	0	1	2
50		NIDOSHINKAN DOJO, CZE	0	1	0
		KARATE CLUB LANGENLOIS, AUT	0	1	0
		ASD HEIAN BUSHI DO, ITA	0	1	0
		LV BRANDENBURG, GER	0	1	0
		ELSON SPORT & KARATE, SUI	0	1	0
55		KARATEFÉLAG REYKJAVÍKUR, ISL	0	0	3
56		SPORTUNION MUGENDO KARATE, AUT	0	0	2
		KARATE MÜHLBACH, ITA	0	0	2
		ASKÖ KARATE SEIBUKAN NEUHOFEN, AUT	0	0	2
59		BUSHIDO STOLLBERG E.V., GER	0	0	1
		TSV VILSBIBURG 1883 E.V., GER	0	0	1
		CLUB KARATE PLZEN, CZE	0	0	1
		ASKÖ KARATE STEYR, AUT	0	0	1
		INOUE-HA KARATE-DO FELDKIRCHEN, AUT	0	0	1
		RHEIN-NECKAR KNIGHTS, GER	0	0	1
		SV UNSU KARATE MÖMLINGEN E.V., GER	0	0	1
		KD STRAUBING, GER	0	0	1
		KARATEDO WELS, AUT	0	0	1
		LZ STEIERMARK, AUT	0	0	1
		TSV MONHEIM E.V., GER	0	0	1
		KYOKUSHIN KARATE SAMURAI, AUT	0	0	1
		KARATESCHULE SURSEE, SUI	0	0	1
		TSV GRASBRUNN-NEUKEFERLOH, GER	0	0	1
		ASD CENTRO STUDI KARATE NEGRAR, ITA	0	0	1
		OKINAWA KARATE TSV FEICHTEN, GER	0	0	1