

Vision Refined



OUR COMMITMENT, TO YOUR SUCCESS.

At 20/20, you'll find exceptional products and value.

We carry both premium and affordable product lines with a history of great performance and customer satisfaction. Our competitive pricing makes it easy for you to consume or resell these products with confidence.

Providing true B2B online is evident at Shop2020as.com as this platform allows 24/7 access and ultimate ease of use, saving you both time and money. In most cases, shipping is included at no cost to you.

We offer:

- Affordable and premium products
- Competitive pricing
- An exceptional shopping experience
- Online ordering B2B
- Direct to Customer Service ordering

Protect your clinic brand by mitigating "Big Box" product comparisons and experience the 20/20 advantage. As internet and low price only sellers strive to commoditize optical products as all being the same, 20/20 uniquely stands in a category on its own. Our customers appreciate this commitment.

We look forward to providing innovative new product, service and program releases into the future. Subscribe to our newsletter and be the first to hear about these releases and special offers. Would you like to see something specific? Contact me directly.

Robert G. Begg,
President

TABLE OF CONTENTS

Eyeglass Cleaning Supplies.....	5
Cases.....	15
Sun & UV Protection.....	23
Readers.....	49
Active Lifestyle.....	57
Chains & Cords.....	65
Lab Supplies.....	71
Displays.....	87
Promotional.....	103

EYEGLOSS CLEANING SUPPLIES

Lens Cleaning Cloths
Eye-Patch & Microfiber Gloves
Lens Cleaners
Combination Kits
Wipes & Anti-Fog

EYEGLOSS CLEANING SUPPLIES | LENS CLEANING CLOTHS



★ ULTRA - SOLID

High-tech lens cleaning cloth composed of 70% polyester, 30% nylon and knit with ultra fine micro fibers using the most advanced technology. This cloth cleans all types of lenses and coatings, with or without a liquid cleaner. To rejuvenate the ultra cloth, just wash it in warm water with detergent, rinse and air dry. Available in 10x15 cm & 15x18 cm, rounded edges or 10x18 cm, zig zag edges.



* Only available in 15x18 cm rounded and 10x18 cm Zig Zag



★ ULTRA - JUMBO LAB

The largest size of our Ultra cloth. Perfect for use in the lab or as a unique retail item. Available in 30x30 cm.



★ ULTRA - SOLID, BOX-25, BLACK POUCH

An assortment of some of our most popular colors in the Ultra cloth. Individually packaged in a black pouch for retail, or as a custom branded promotional item. Available in 15x18 cm, rounded edges.



Fashion Woman

Optic Illusion

Tie Dye

ULTRA - FASHION

Same features as the Ultra-Solid cloth, with bold new digitally printed patterns. Available in 10x15 cm & 15x18 cm, rounded edges.

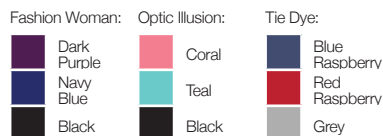

ULTRA - INSPIRATIONAL

Same features as the Ultra-Solid cloth, with inspirational messages. Available 10x18 cm with zig zag edges or 15x18 cm with rounded edges which comes in a clear resale pouch.



Wish Dream Believe Love



10 x 18 cm zig zag



15 x 18 cm rounded

★ ANTIMICROBIAL

Our most advanced lens cleaning cloth with antimicrobial technology built-in during the manufacturing process and lasting for up to 30 wash cycles. Highly advanced protection prevents bacteria and microbe build up without any special cleaning solutions. Fights the transfer of contaminants from surface to skin. Available in 15x18 cm, zigzag edges.

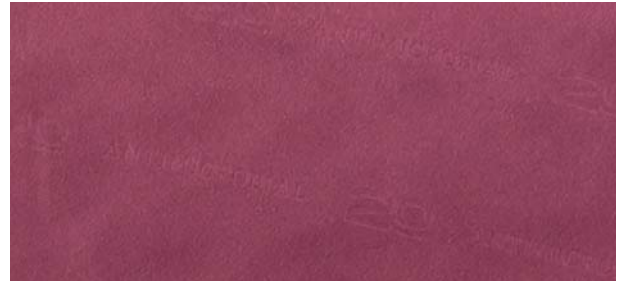

ANTIMICROBIAL - JUMBO LAB

The largest size of our Antimicrobial cloth. Perfect for use in the lab or as a unique retail item. Available in 28x30 cm.



**CUSTOM
PRINTING
AVAILABLE ON
ALL CLEANING
CLOTHS**

EYEGLOSS CLEANING SUPPLIES | LENS CLEANING CLOTHS

CUSTOM PRINTING AVAILABLE ON ALL CLEANING CLOTHS
Minimum quantities of 100 per color

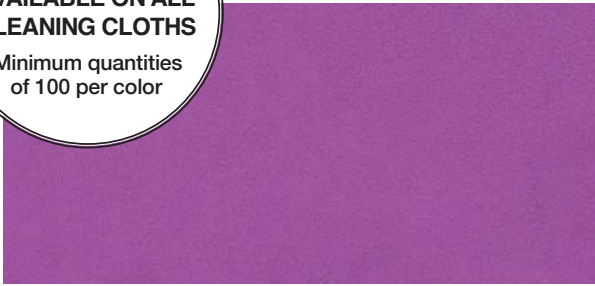

GK SHAMMY

Composed of a shammy material (70% polyester, 30% polyamide) this cloth has excellent absorbency for streak free cleaning. Available in 15x18 cm or 30x30 cm (grey only), rounded edges.

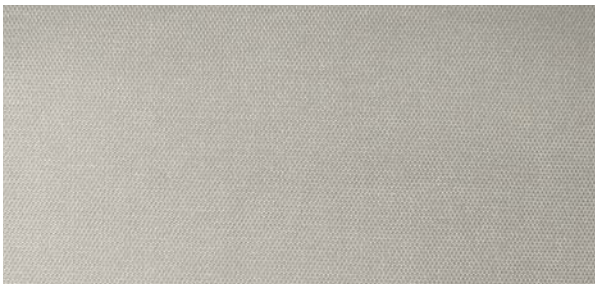

GK WEAVE

Economical option for high volume and basic eyeglass cleaning needs. Available in 15x15 cm, zig zag edges.



Violet

Yellow

★ MIKRŌ DIGITAL - EYE OF THE STORM

Using the same material as the Ultra cloth, this unique digitally printed cloth can be custom branded to your specifications on the reverse side. Available in 15x15 cm.



MIKRŌ DIGITAL - CUSTOM ARTWORK

Using the same material as the Ultra cloth, with the option for full customization in a digital print. Available in 15x15 cm. Send us your artwork.

EYE-PATCH MOBILE

Size 1" x 1"
Customizable patch to advertise your business
and to clean mobile device screens.



EYE-PATCH TABLET

Size 2" x 2"
Customizable patch to advertise your business
and clean mobile device screens.
Stock colour options: Blue, green, grey or pink;
Custom colours available.



MICROFIBER CLEANING GLOVES

Made of high quality Diamond microfiber,
(70% polyester, 30% nylon), these gloves
are soft and flexible. A stylish and efficient
way to clean your glasses in the dispensary
and a unique retail item.



Abstract



Chameleon

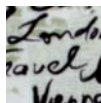

Paris

**SAVE
MONEY TIME
AND STORAGE SPACE
WITH OUR
AUTO RELEASE PROGRAM**

**Call our
Customer Service Team
for more information**



**BLOWOUT
PRICING
AVAILABLE**

PROTEKT™



PROTEKT™ A/R Lens Cleaner, backed by several coating labs, has been safety tested and is not harmful to any lens coating. Although specifically developed for anti-reflective lenses, it can be used on all plastic and glass lenses. Certified by Colts laboratories.

ECO-20

Eco-20 A/R Lens Cleaner features a virtually odourless eco-based A/R formula. Safe to use on any lens type. Complementary with our Antimicrobial cloth.

**FREE PRINTING
AVAILABLE**
Minimum
quantities apply



★ **PROTEKT™ A/R LENS CLEANER - PREMIUM**

Custom printing available on all bottle sizes - 30 ml, 120 ml & 240 ml
Available in 30 ml/240 ml & 30 ml/120 ml combo packs.

ECO-20 A/R LENS CLEANER

Custom printing available on all bottle sizes - 30 ml, 125 ml



PUMP, FITS 4 L JUG

Make your bottle refills quick and easy.

PROTEKT™ A/R LENS CLEANER CONCENTRATE - 456 ml

An economical and green friendly option to replenish your solution. Simply mix into a 4 L container with distilled or deionized water and save.



ECO-20 A/R LENS CLEANER - 7 ml

Compact and colourful, these refillable bottles are great for everyday use and quick cleaning. Assorted box of 60. Custom printing available.

- Cobalt
- Green
- Red
- Light Blue
- Yellow
- Clear

RECEIVE THIS DISPLAY FREE WITH THE PURCHASE OF 300 PIECES
One display per customer



PROTEKT™ A/R LENS CLEANER REFILL, 3.79 L JUG



ECO-20 FLAT PACK A/R LENS CLEANER - 20 ml

Compact flat pack bottles that just slip into a pocket or purse. Great for daily use. Custom printing available on minimum orders. Available unprinted in boxes of 25.

EYEGGLASS CLEANING SUPPLIES | COMBINATION KITS



ULTRA KIT - PROTEKT 30 ml & ULTRA CLOTH 10X15

Our premium kit includes a 10x15 cm rounded Ultra cloth and an ergonomic 30 ml bottle of Protekt™ cleaning solution. Custom options available see Custom option selection chart or inquire.

Pre-Assembled Kit Colours - Available with or without screwdrivers.



★ ULTRA KIT - ECO-20 7 ml & ULTRA CLOTH 10X15

Ultra Kit includes a 7 ml bottle of our Eco-20 cleaner and a 10x15 cm rounded Ultra cloth. Custom printing available. Custom options available see Custom option selection chart or inquire.

Pre-Assembled Kit Colours - Available with or without screwdrivers.



ULTRA KIT CHIC - ECO-20 7 ml & ULTRA CLOTH 10X15

Chic Ultra Kit includes a 7 ml bottle of our Eco-20 cleaner and a 10x15 cm rounded Ultra cloth in a sleek pouch. Custom printing available. Inquire about colour combinations.



ULTRA KIT KIDS - 7 ml

Kids Ultra Kit includes a 7 ml bottle of our Eco-20 cleaner and 10x15 cm rounded Ultra cloth. Custom printing available. Inquire about custom colour combinations.

CUSTOM PRINTING AVAILABLE ON ALL CLEANING KITS
Minimum quantities apply



EYEGLASS CLEANING SUPPLIES | COMBINATION KITS



ECO-20 Flat Pack Cleaner - 20ml
20ml refills available.



Antimicrobial Cloth 15x18cm
10 colours available.



Carrying case
The ultimate in convenience for those on the go.

★ **ECO-20 BACK PACK CLEANING KIT - ANTIMICROBIAL**

Contains 20 ml Eco-20 flat pack cleaner and a 15x18 cm Antimicrobial cloth all held together with the 'back pack' carrying case. Custom printing available on minimum quantities. Inquire about custom and stock colour combinations. Also available individually unprinted in all cloth colours.

- | | | | | |
|--------|-------|--------|------------|-------|
| Plum | Olive | Orange | Violet | Red |
| Maroon | Black | Green | Light Blue | White |



**RECEIVE
A DISPLAY
FREE WITH THE
PURCHASE OF 500
BACK PACK KITS FOR
A SMALL DISPLAY
AND 1000 KITS
FOR A LARGE
DISPLAY**



CUSTOM KIT OPTIONS

Choose your cloth

ULTRA CLOTH

- 10 x 15 cm
- 15 x 18 cm

ANTIMICROBIAL

- 15 x 18 cm

GK SHAMMY

- 15 x 18 cm

GK WEAVE

- 15 x 15 cm

Choose your cleaner

ECO-20

- 7 ml
- 20 ml
- 30 ml
- 125 ml

PROTEKT

- 30 ml
- 120 ml
- 240 ml

CUSTOM ULTRA OR ANTIMICROBIAL KITS

Build your own fully customizable kit. Choose a cloth from our premium Ultra cloth, or Antimicrobial collections, then select your cleaner from our wide range of sizes. You can also add a key chain screwdriver. Contact our Customer Service team for more information.

EYEGLOSS CLEANING SUPPLIES | LENS CLEANERS - WIPES & ANTI-FOG



LENS CLEANING WIPES

Designed for one-time use, these pre-moistened wipes are perfect for all hi-tech lens coatings, will not scratch or leave any residue. Available in a box of 60 or a box of 180 (counter display).



FOG DEFENCE

The ultimate in anti-fog treatments, this formula cleans easily, leaving no residue. Safe to apply on any lens type, with each application lasting 24-72 hours. 50 wipes per box.



★ EK CAT CRAP ANTI-FOG PASTE

Prevents fogging of the lenses while repelling dust and dirt. Cleans and polishes glass and plastic. Safe on all lenses and coatings. **Carded individually or Kitty Litter 24 pcs.**



★ EK CAT CRAP ANTI-FOG SPRAY GEL

Prevents fogging of the lenses while repelling dust and dirt. Cleans and polishes glass and plastic. Safe on all lenses and coatings. **Carded individually or Kitty Litter 15 pcs.**

CASES

Ladies

Mens

Unisex

Kids & Teens

Custom Printing

CASES | LADIES



★ **MANTA**
159-66-40
90 cases per box
IN | LABEL



★ **KOI**
152-55-32
90 cases per box
IN | LABEL



★ **ELEMENT**
160-58-37
90 cases per box
IN | LABEL



★ **MARQUIS**
162-67-42
90 cases per box
IN | OUT | LABEL



★ **NOUVEAU**
160-55-42
90 cases per box
LABEL



★ **STARBURST**
162-59-40
50 cases per box
IN | OUT | LABEL | EMOSS



CANDY
163-60-32
100 cases per box
IN | LABEL





PLUSH II
165-70-22
40 cases per box,
10 of each
LABEL



JAPANESE PRINT I
165-65-35
40 cases per box
LABEL



CHANTEL
170-80-10
Coin purse top
40 cases per box



**SAVE
MONEY TIME
AND STORAGE SPACE
WITH OUR
AUTO RELEASE PROGRAM**

**Call our
Customer Service Team
for more information**



★ **INFINITY**
153-73-33
90 cases per box
IN | LABEL



★ **NEW PRODUCT**

* Please refer to the back of case section for custom printing legend
 ** Case sizing is listed after item name as follows in mm: Length-Width-Height
 *** All cases with more than one colour option listed come in an assorted box

CASES | MENS

ALL MEN'S
CASES HAVE A
PREMIUM METAL
STITCHED CLIP
FOR ENSURED
QUALITY



★ SLIP W/CLIP & PEN POCKET LARGE

160-83

25 cases per box

OUT | LABEL



SLIP W/CLIP LARGE

160-83

25 cases per box

OUT | LABEL



SLIP W/CLIP & FULL FLAP LARGE ALSO AVAILABLE IN SMALL SIZE

Large 200-90 Small 165-70

25 cases per box

OUT | LABEL



★ SLIP W/CLIP & HALF FLAP LARGE

162-82

25 cases per box

OUT | LABEL



★ SEMI-HARD W/CLIP & FULL FLAP SMALL

160-72

25 cases per box

OUT | LABEL



★ SEMI-HARD W/CLIP & FULL FLAP LARGE

165-80

25 cases per box

OUT | LABEL



SLIP W/BELT LOOP & FULL FLAP (SAFETY) X-LARGE

192-98

25 cases per box

OUT | LABEL



★ HARD WITH STITCH CLIP MEDIUM

163-30-65

25 cases per box

OUT | LABEL



★ **FLAIR**

160-60-34

50 cases per box
IN | OUT | LABEL



★ **METAL**

160-60-34

50 cases per box
IN | OUT | LABEL



★ **FLAIR W/CLIP FLAP**

160-60-38

50 cases per box
OUT | LABEL



★ **CONTOUR**

160-58-38

40 cases per box
IN | OUT | LABEL | EMBOSS



URBAN

165-65-43

45 cases per box
IN | OUT | LABEL

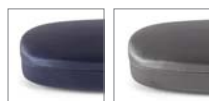

CLASSIC

156-58-45

60 cases per box
IN | OUT | LABEL

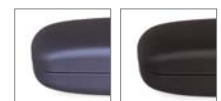

★ **WRAP LARGE**

165-68-51

20 cases per box
IN | OUT | LABEL



PREMIUM BLACK LARGE

160-65-42

50 cases per box
IN | OUT | LABEL

★ **BESTSELLER** * ★ **NEW PRODUCT**

* Please refer to the back of case section for custom printing legend

** Case sizing is listed after item name as follows in mm: Length-Width-Height

*** All cases with more than one color option listed come in an assorted box

CASES | UNISEX

COMING SOON



★ **PRESTIGE LARGE**
165-72-42
10 cases per box
IN | LABEL

COMING SOON



★ **PRESTIGE MEDIUM**
165-65-35
10 cases per box
IN | LABEL

COMING SOON



★ **PRESTIGE SMALL**
160-65-40
10 cases per box
IN | LABEL



★ **FLAIR ECONOMY**
160-60-34
50 cases per box
IN | OUT | LABEL



★ **ECONOMY MEDIUM**
155-60-33
50 cases per box
IN | OUT | LABEL | EMBOSS



★ **PLASTIC LARGE**
158-66-35
50 cases per box
IN | OUT | LABEL



DARK GREEN
158-52-35
50 cases per box
LABEL



SMOKE
155-60-40
50 cases per box
LABEL



ECCO-01
155-50-35
25 cases per box
IN | LABEL



TRI
150-70-40
40 cases per box
LABEL

COMING SOON



★ **DUAL - WITH POCKET**
165-72-7
10 cases per box
IN | OUT | LABEL



MICROFIBER POUCH - SMALL & LARGE
193-95
1 each
OUT | LABEL

CASES | CLIPS



VISOR CLIP
Clips onto the flip down visor in your car and opens to place the temples of your glasses inside. *Custom printing available.



CLIP-ON MEDIUM
133-65-21
10 cases per box
IN | OUT | LABEL

CASES | KIDS



FLASH
160-66-33
30 cases per box
IN | LABEL



★ **NEW STARZ**
137-60-35
60 cases per box
IN | LABEL



★ **BESTSELLER** * ★ **NEW PRODUCT**

* Please refer to the back of case section for custom printing legend
** Case sizing is listed after item name as follows in mm: Length-Width-Height
*** All cases with more than one color option listed come in an assorted box



Pad Printing (Interior) - **IN**



Labeling - **LABEL**

CUSTOM LOGO PRINTING GUIDELINES

- A separate plate/dye is required for embossing or pad printing orders.
- Artwork is required for labeling orders.
- Allow 2 to 4 weeks delivery on all new orders which require new graphics.
- Allow 1 week delivery for re-orders using existing graphics.
- An initial, one time dye charge will apply to all orders which require a new embossing and/or printing plate.
- Each case in our catalogue is labeled with printing capabilities (IN, LABEL, OUT, EMBOSS)
- Minimum quantities apply



Pad Printing (Exterior) - **OUT**



Embossing - **EMBOSS**

SUN & UV PROTECTION

Overglasses

Clip-Ons

Flip-Ups

Bifocal Sunglasses

Plano Sunglasses

Sunglasses & Lens Packages

Kids Sunglasses



20/20, the original distributor of overglasses in Canada introduces Overcoats. Made of TR90 with polarized lenses, all Overcoat models feature “temple tunnel technology” and are “engineered for a better fit”. They are available in S and F series.

FEATURES AND BENEFITS

- TR90 frame
- Polarized triacetate lenses, UV400
- Mirrored lens options
- Optics by 20/20
- Replacement lenses available for all models
- Microfiber pouch included with every pair of Overcoats



★ **OVERCOATS S-SERIES REC** 64-13-137

TR90 frame with polarized triacetate lenses.

Lens Colours: Grey Yellow
 Brown



Black Tortoise Navy



OVERCOATS F-SERIES REC 62-14-140

TR90 frame with polarized triacetate lenses.

Lens Colours: Grey
 Brown



Purple Blue Grey



★ **OVERCOATS F-SERIES ROUND REC** 62-14-140

TR90 frame with polarized triacetate lenses.

Lens Colours: Grey
 Brown



Purple Blue Grey

*Lens colours are not available with all frame colours

Now with a new lightweight design and 2 new shapes, these Overcoats models feature a TR90 frame and polarized TAC lenses. All models have a soft touch finish.

FEATURES AND BENEFITS

- New lightweight design
- TR90 frame
- Polarized triacetate lens, UV400
- Microfiber pouch is included with every pair of Overcoats
- Optics by 20/20

★ OVERCOATS F-SERIES MINI REC 58-17-140

TR90 frame with polarized triacetate lenses.



Black/Grey



Brown/Brown



★ OVERCOATS F-SERIES CATEYE 56-18-140

TR90 frame with polarized triacetate lenses.



Black/Grey



Brown/Brown



solehs

Perfected to protect from the sun and be worn over prescription eyewear, these classic Soleh models feature a TR90 frame and polarized TAC lenses. All models have a soft touch finish unless stated otherwise.

FEATURES AND BENEFITS

- TR90 frame
- Polarized triacetate lens, UV400
- Mirrored lens options
- Optics by 20/20
- Replacement lenses are available for some models
- Microfiber pouch is included with every pair of Solehs



★ SOLEHS SLIM REC 60-17-130

TR90 frame with polarized triacetate lenses.

Lens Colours: *
 Grey, Yellow, Green Mirror, Grey Photochromic, Brown, Driver, Blue Mirror, Brown Photochromic

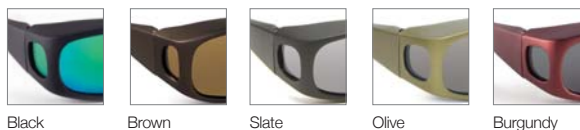

SOLEHS ROUND REC 61-17-130

TR90 frame with polarized triacetate lenses.

Lens Colours: *
 Grey, Yellow, Grey Photochromic, Brown, Driver, Brown Photochromic



SOLEHS SQUARE 64-15-125

TR90 frame with polarized triacetate lenses.

Lens Colours: Yellow, Grey Photochromic



Black

*Lens colours are not available with all frame colours

sølehs-LITE

Polarized • Polarisé

Now with a new lightweight design and 2 new shapes, these Solehs-Lite models feature a TR90 frame and polarized TAC lenses. All models have a soft touch finish.

FEATURES AND BENEFITS

- New lightweight design
- TR90 frame
- Polarized triacetate lens, UV400
- Microfiber pouch is included with every pair of Solehs
- Optics by 20/20

★ SOLEHS-LITE REC 65-18-135

TR90 frame with polarized triacetate lenses.



Black/Grey



Brown/Brown



★ SOLEHS-LITE ROUND 65-19-135

TR90 frame with polarized triacetate lenses.



Black/Grey



Brown/Brown





RECEIVE AN 18PC
FLOOR DISPLAY
WITH THE PURCHASE
OF 48 ASSORTED
SOLEHS/OVERCOATS

RECEIVE THIS DISPLAY
with the purchase of 12 assorted
Solehs/Overcoats



OVERGLASSES FLOOR DISPLAY, 18PC

OVERGLASSES COUNTER DISPLAY, 12PC

Perception®

20/20 is proud to be the exclusive Canadian distributor of Perception® mirrored clip-ons from Shade Control®. The clip-ons are available with a copper driving lens and a bronze frame in our most popular shapes and sizes. Perception® clip-ons are available in a 20 piece fitting kit for easy storage and organization. Ask how you can become a Perception® mirror lens clip-on dealer.



SELECTING A SIZE:

- Use the size guide provided on following pages. All outlines are actual size for accurate sizing.
- Lay your glasses face down onto the outlines of the clip-on sunglasses and select whichever size is the closest match.

HOW THE CLIP-ONS ATTACH TO YOUR GLASSES:

- This type of clip-on sunglass is held in place by the tension from the spring-bridge and four small, plastic coated clips, two on either side of each lens.
- The clips will fit over glasses with metal, plastic, or rimless frames with lenses up to 5 mm thick at the edges.

**BUY 15
PRE-SELECTED
PERCEPTION CLIP-ONS
RECEIVE AN
ADDITIONAL 5 FOR
FREE AND
A FITTING KIT**



PERCEPTION FITTING KIT, 20PC

Keep your clip-ons organized and maximize your sales. Size & style availability ensures an accurate fit for your customer's frame.

SUN & UV | CLIP-ONS PERCEPTION POLARIZED WITH A/R BACK COAT

TRU REC

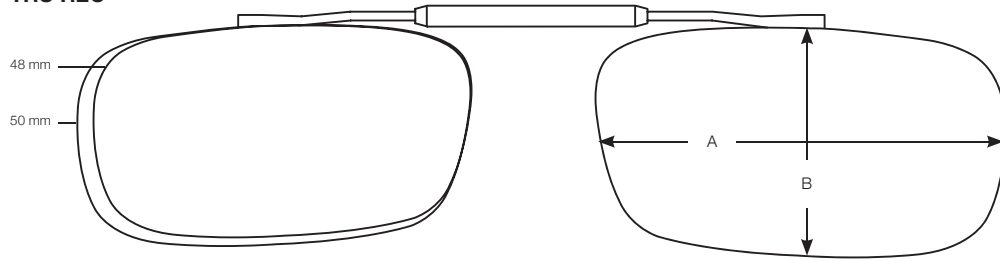

Size	A	B
48 mm	48	27
50 mm	50	28

SLIM REC

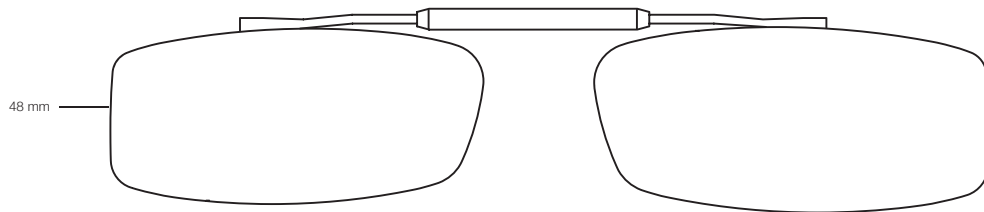

Size	A	B
48 mm	48	22

MOD REC

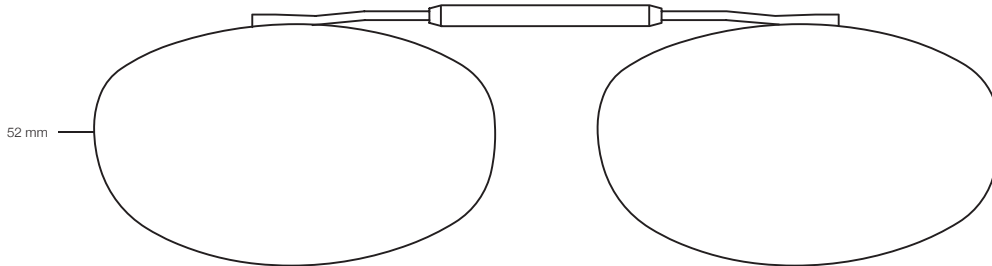

Size	A	B
52 mm	52	31

LO REC

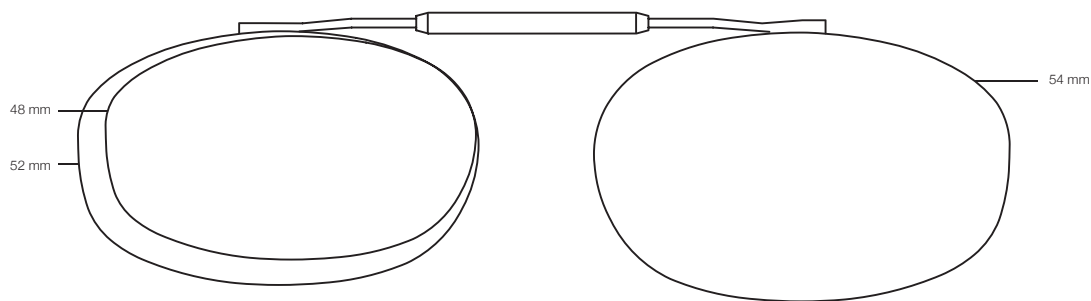

Size	A	B
48 mm	48	27
52 mm	52	29
54 mm	54	30



FEATURES AND BENEFITS

- Polarized lenses
- Shade Control clips are designed to ensure that the polarized horizontal axis is never compromised
- Stainless steel patented construction

- Functioning rim locks
- All sun lenses filter 100% of ultraviolet light up to 400 nm and meet or exceed all local and international standards pertaining to optical clarity, durability, and safety, including but not limited to ANSI Z80.3:2008, EN1836:2005, and AS/NZS 1067:2003.



PRICE MATCH PRODUCT

SELECTING A SIZE:

- Use the size guide provided on following pages. All outlines are actual size for accurate sizing.
- Lay your glasses face down onto the outlines of the clip-on sunglasses and select whichever size is the closest match.

HOW THE CLIP-ONS ATTACH TO YOUR GLASSES:

- This type of clip-on sunglass is held in place by the tension from the spring-bridge and four small, plastic coated clips, two on either side of each lens.
- The clips will fit over glasses with metal, plastic, or rimless frames with lenses up to 5 mm thick at the edges.

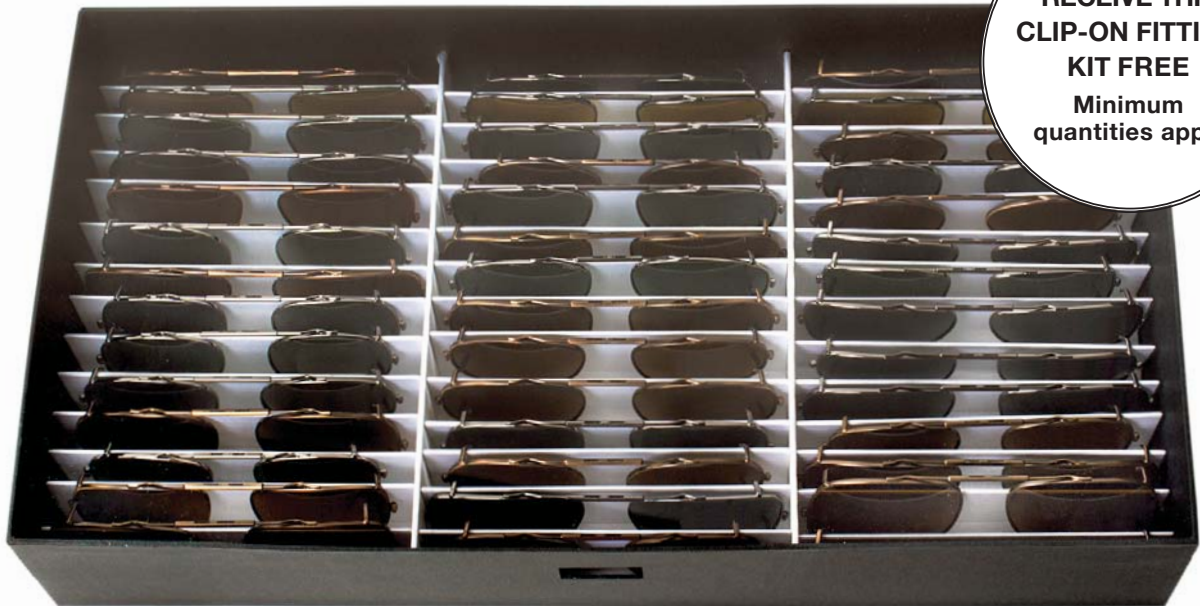

**RECEIVE THIS
CLIP-ON FITTING
KIT FREE
Minimum
quantities apply**

VISIONARIES FITTING KIT, 42PC

Keep your clip-ons organized and maximize your sales. Size & style availability ensures an accurate fit for your customer's frame.

SUN & UV | CLIP-ONS VISIONARIES POLARIZED

★ WAL

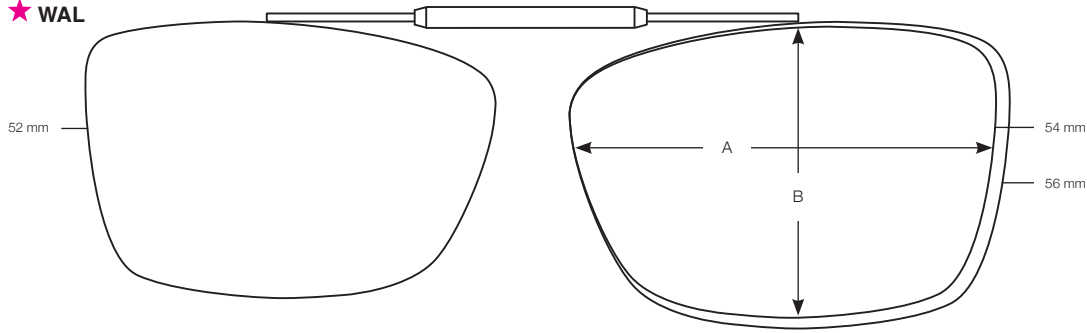

Size	A	B
52 mm	52	35
54 mm	54	37
56 mm	56	39

Gunmetal Frame
Grey Lens

Bronze Frame
Brown Lens

★ HIP

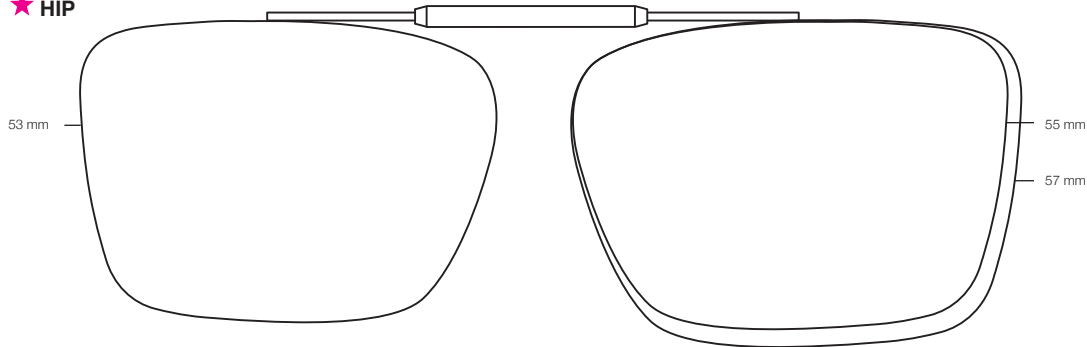

Size	A	B
53 mm	53	38
55 mm	55	39
57 mm	57	42

Bronze Frame
Brown Lens

★ ROC

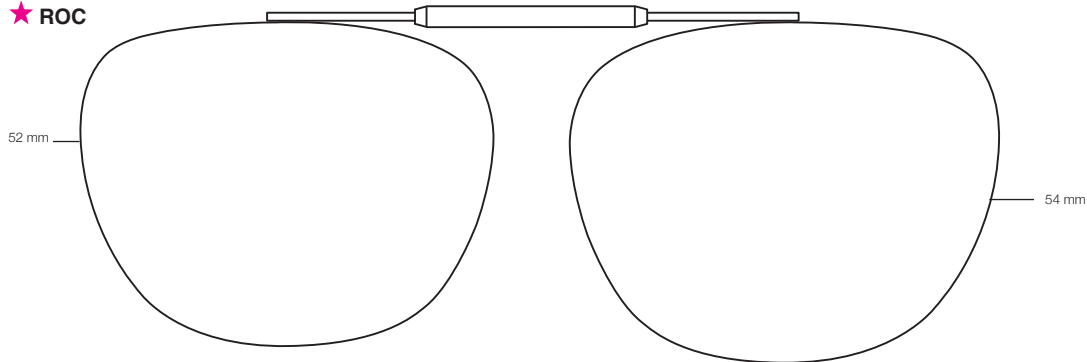

Size	A	B
52 mm	52	41
54 mm	54	43

Bronze Frame
Brown Lens

SUN & UV | CLIP-ONS VISIONARIES POLARIZED



Size	A	B
48 mm	48	27
50 mm	50	28
52 mm	52	29
54 mm	54	30
56 mm	56	34
58 mm	58	35.2

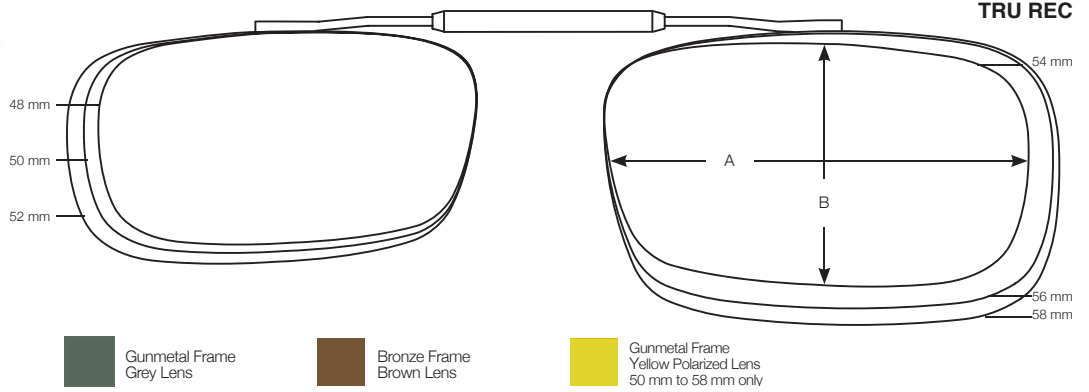

Size	A	B
48 mm	48	27
50 mm	50	28
52 mm	52	29
54 mm	54	30
56 mm	56	35.2

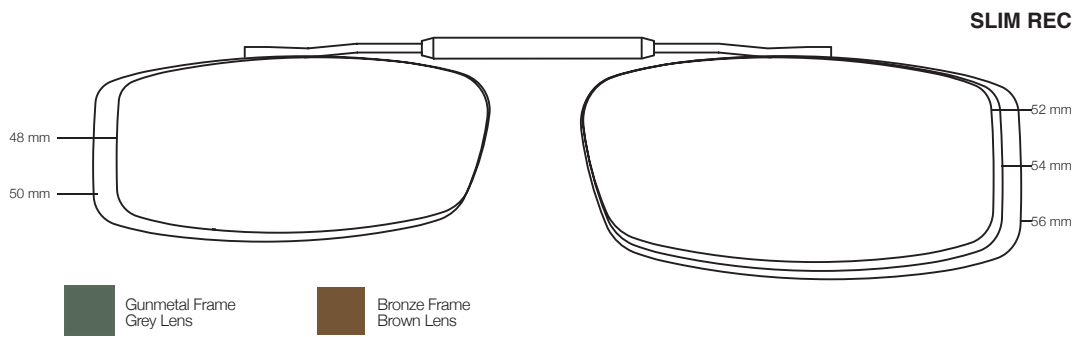

Size	A	B
52 mm	52	33
54 mm	54	35
56 mm	56	38

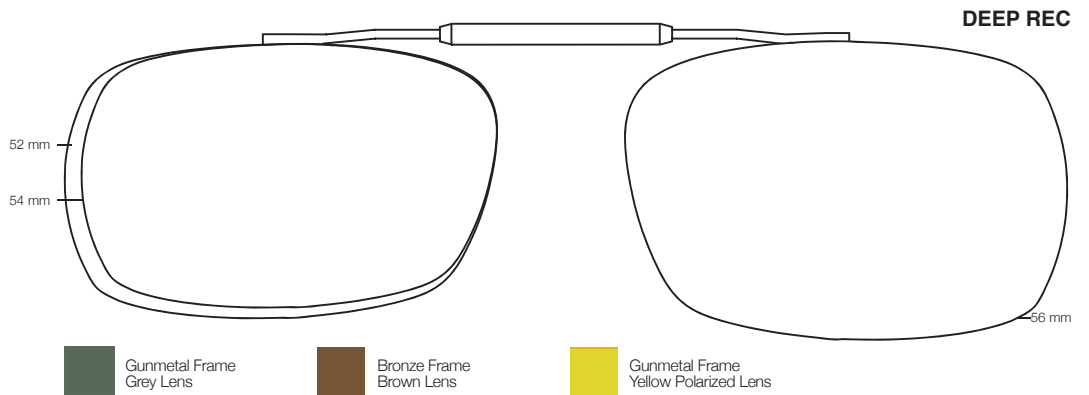

Size	A	B
55 mm	55	26.5
57 mm	57	27

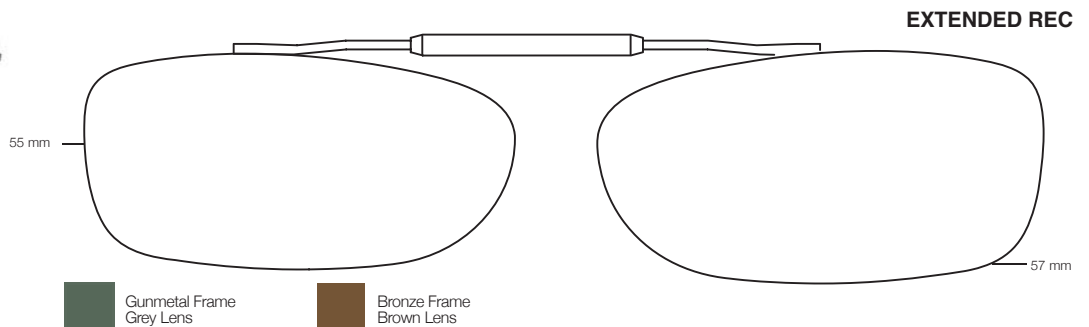

SUN & UV | CLIP-ONS VISIONARIES POLARIZED

REC

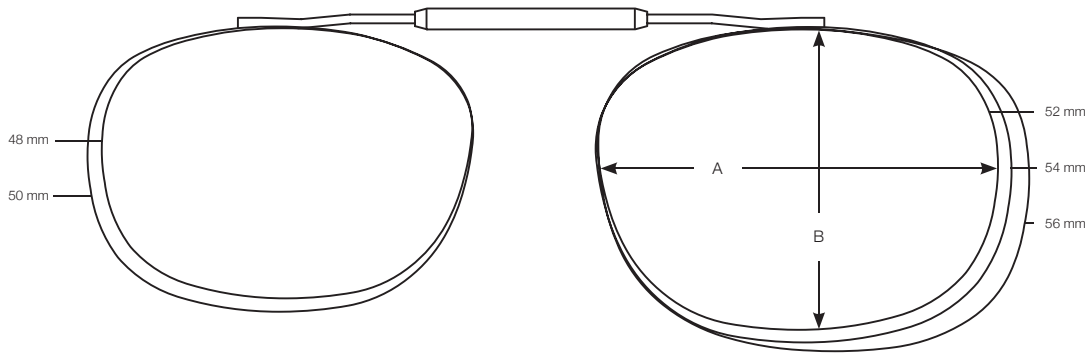

Size	A	B
48 mm	48	35
50 mm	50	37
52 mm	52	39
54 mm	54	40
56 mm	56	43

- Gunmetal Frame
Grey Lens
- Bronze Frame
Brown Lens

MOD REC

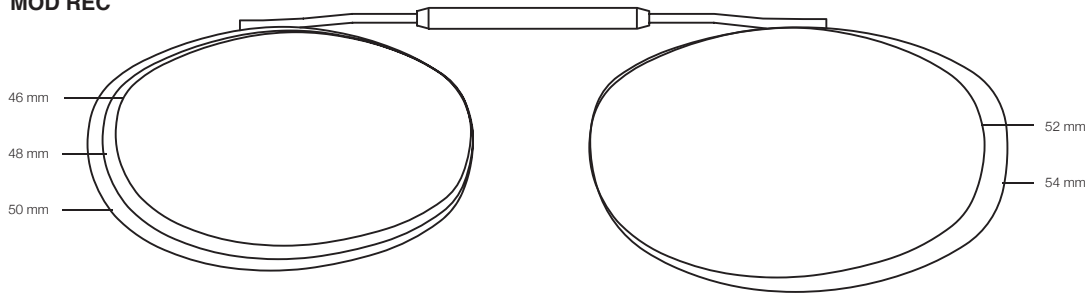

Size	A	B
46 mm	46	26
48 mm	48	28
50 mm	50	29
52 mm	52	31
54 mm	54	33

- Gunmetal Frame
Grey Lens
- Bronze Frame
Brown Lens

LO REC

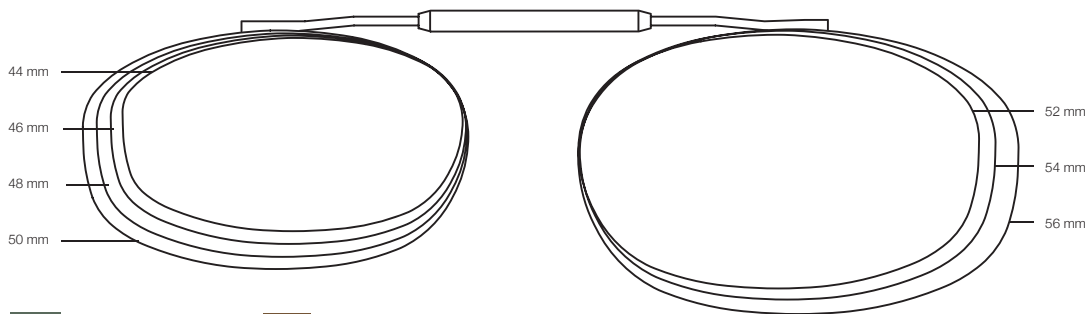

Size	A	B
44 mm	44	27
46 mm	46	29
48 mm	48	30
50 mm	50	32
52 mm	52	32
54 mm	54	35
56 mm	56	35

- Gunmetal Frame
Grey Lens
- Bronze Frame
Brown Lens



Size	A	B
44 mm	44	34
46 mm	46	36
48 mm	48	37
50 mm	50	39
52 mm	52	41

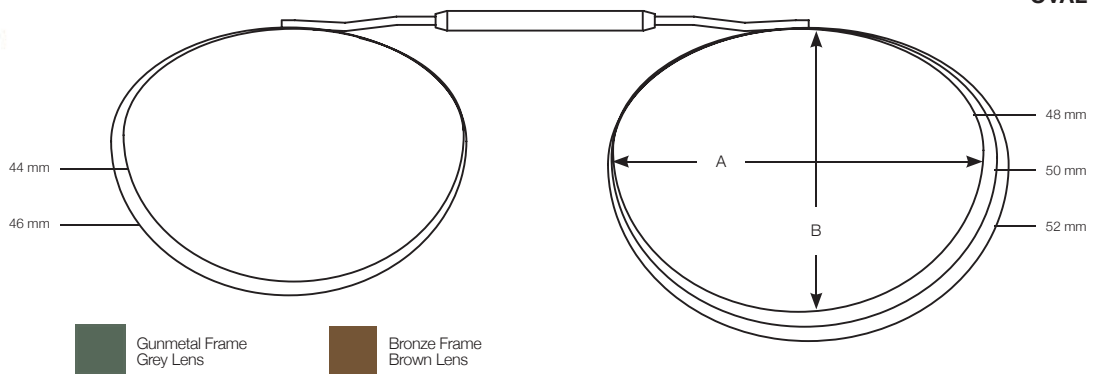

Size	A	B
50 mm	50	28
52 mm	52	29

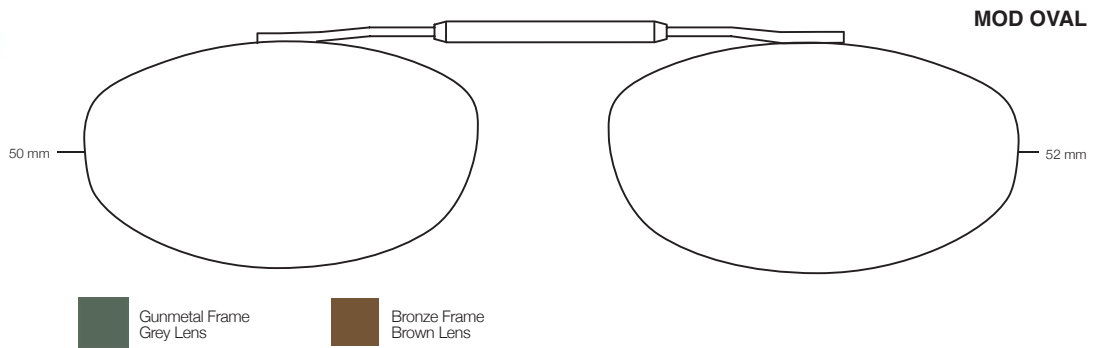

Size	A	B
42 mm	42	26
44 mm	44	27
46 mm	46	30
48 mm	48	30

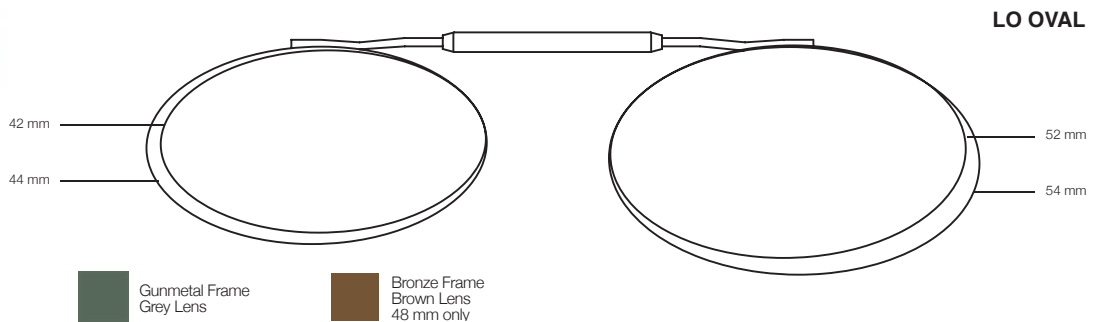

Size	A	B
48 mm	48	29
50 mm	50	30
52 mm	52	31

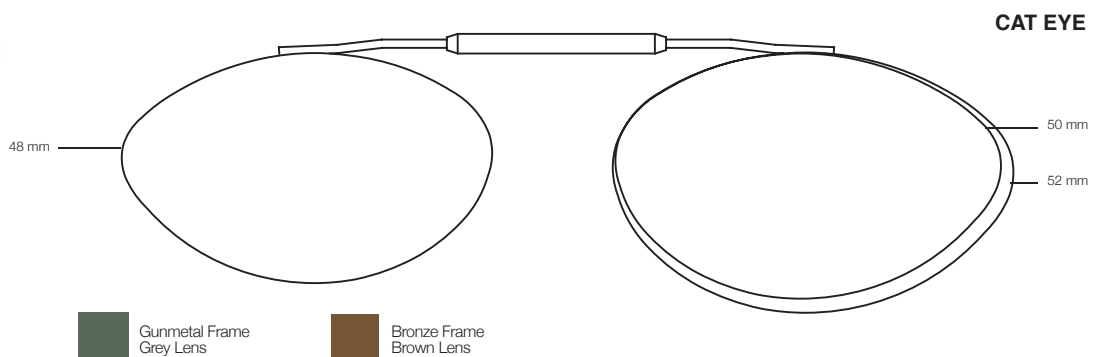

SUN & UV | CLIP-ONS VISIONARIES POLARIZED

SQUARE

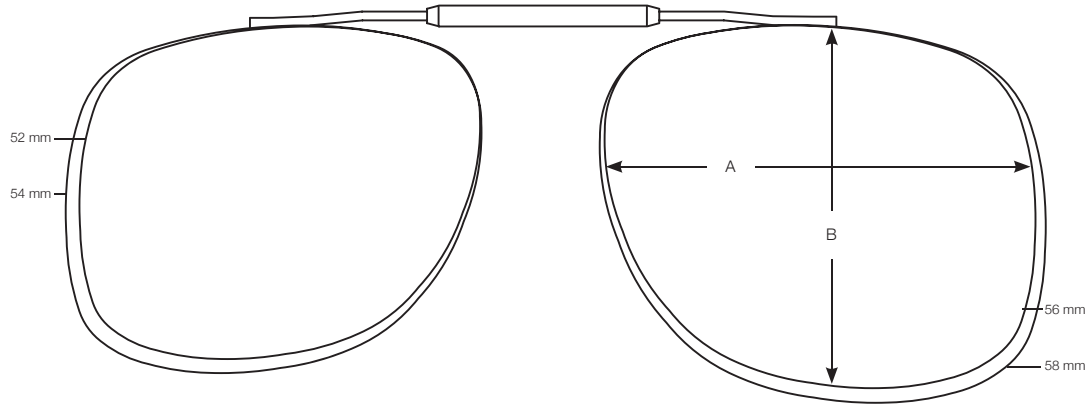

Size	A	B
52 mm	52	45
54 mm	54	46
56 mm	56	48
58 mm	58	49

- Gunmetal Frame
Grey Lens
- Bronze Frame
Brown Lens
54 mm to 58 mm only

WAY

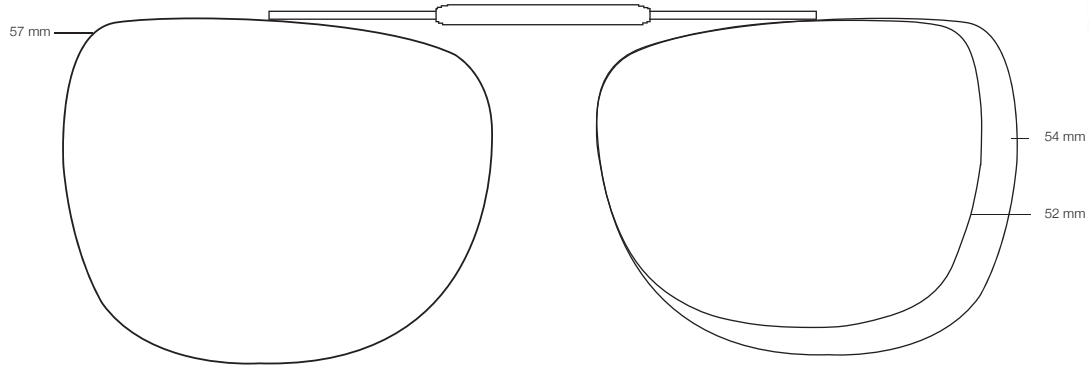

Size	A	B
52 mm	52	45
54 mm	54	46
57 mm	56	47

- Black Frame
Grey Lens
- Bronze Frame
Brown Lens

ROUND

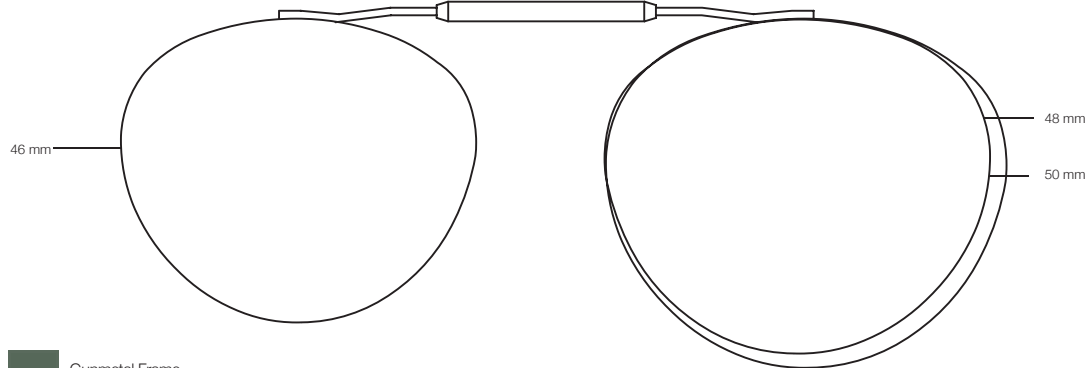

Size	A	B
46 mm	46	42
48 mm	48	43
50 mm	50	45

- Gunmetal Frame
Grey Lens

SUN & UV | CLIP-ONS VISIONARIES POLARIZED



Size	A	B
52 mm	52	29
54 mm	54	31
56 mm	56	32

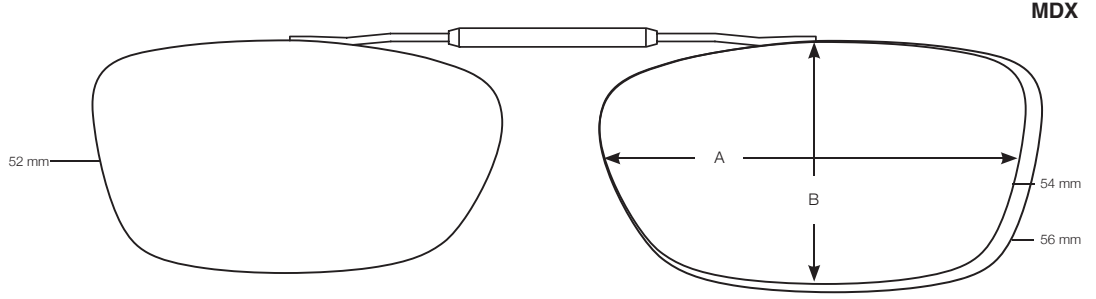

MDX

 Gunmetal Frame
Grey Lens

 Bronze Frame
Brown Lens

 Gunmetal Frame
Yellow Polarized Lens
54 mm only



Size	A	B
52 mm	52	26
54 mm	54	27

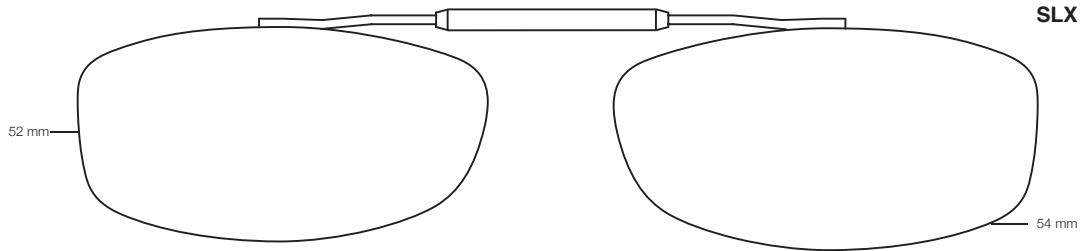

SLX

 Gunmetal Frame
Grey Lens

 Bronze Frame
Brown Lens

SUN & UV | CLIP-ONS VISIONARIES POLARIZED FOR KIDS

KIDS LO REC

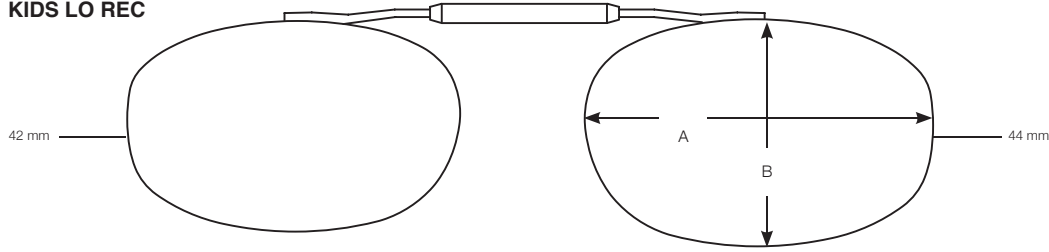

42 mm	42	26
44 mm	44	26



Rootbeer Frame
Grey Lens



Blueberry Frame
Grey Lens

KIDS LO OVAL

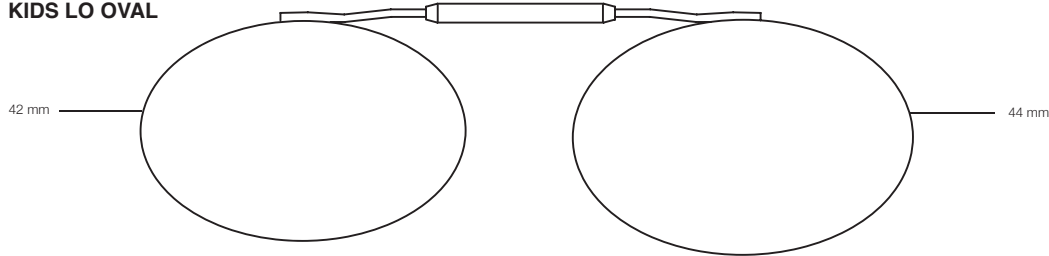

42 mm	42	27
44 mm	44	28



Rootbeer Frame
Grey Lens



Blueberry Frame
Grey Lens

KIDS HEXAGON

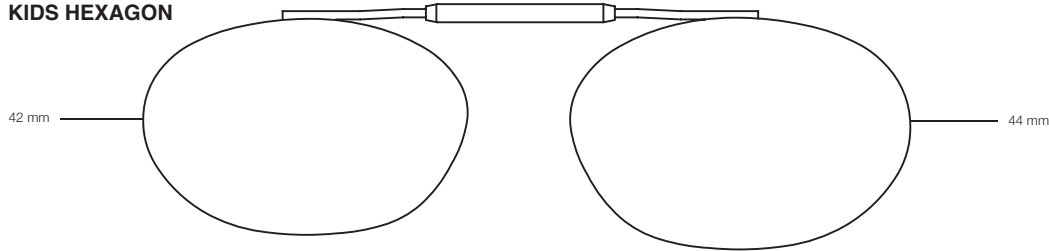

42 mm	42	25
58 mm	44	26



Rootbeer Frame
Grey Lens



Blueberry Frame
Grey Lens

PROTEKT™ Flip-Ups

FEATURES & BENEFITS

- Silicone dipped tips to protect prescription lenses from scratching
- All metal clip mechanism
- Polarized lenses where specified
- Limited lifetime manufacturers warranty



SQUARE SMALL A=55 mm B=46 mm



RECTANGLE SMALL A=53 mm B=35 mm



OVAL SMALL A=52 mm B=37 mm



SQUARE MEDIUM A=59 mm B=54 mm

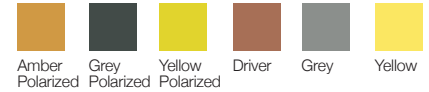

ROUND MEDIUM A=57 mm B=48 mm



OVAL MEDIUM A=57 mm B=40 mm



SQUARE LARGE A=63 mm B=58 mm



SUN & UV | INSTANT SUNGLASSES



POST MYDIATRIC, SLIP-IN

Box of 100



POST MYDIATRIC

Adjustable temples, Box of 100

SUN & UV | BIFOCAL SUNGLASSES



★ **HANG RETRO** 46-17-165

Polycarbonate soft touch frame with spring hinges, polycarbonate bifocal lenses.

+1.50, +2.00, +2.50



Light Blue /Green



Blue Green /Green



Blue /Mirror



Turquoise /Mirror



★ **RETRO HIPSTER** 48-16-145

Polycarbonate frame with spring hinges, polycarbonate bifocal lenses.

+1.50, +2.00, +2.50



Crystal Blue Two Tone



Crystal Yellow Two Tone



GOLFOCAL - GREEN LENS 67-16-120

Ultra light TR-90 frame, polycarbonate bifocal lenses with A/R and scratch-resistant coating. Case, cleaner and cloth included.

+1.50, +2.00, +2.50



Black



Slate



GOLFOCAL - BROWN LENS 67-16-120

Ultra light TR-90 frame, polycarbonate bifocal lenses with A/R and scratch-resistant coating. Case, cleaner and cloth included.

+1.50, +2.00, +2.50



Brown



White



★ **GK MARLIN** 64-19-126

An excellent choice for fishing enthusiasts with an ultra-light TR-90 frame, polarized bifocal polycarbonate lenses with flash mirror & oleo phobic coatings on the front and an A/R purple back coat. Case, cleaner and cloth included. **Plano, +1.50, +2.00, +2.50**



Black/Grey



Tortoise/Brown



GK SPORT 64-19-126

Ultra light, rimless TR90 frame and bifocal polycarbonate lenses. Non-polarized unisex style. Case, cleaner and cloth included. **Plano, +1.50, +2.00, +2.50**



Crystal Grey /Grey



Tortoise/Brown



★ **GK RAY** 51-19-140

Unisex, non-polarized bifocal sunglass with classic, retro frame style. Microfiber pouch included. **+1.50, +2.00, +2.50**



Black/Clear /Grey



Tortoise/Brown



Black/Tortoise /Grey



SUN & UV | PLANO SUNGLASSES



GK MARLIN - POLARIZED 64-19-126

An excellent choice for fishing enthusiasts with an ultra-light rimless TR-90 frame, polarized polycarbonate lenses with flash mirror & oleo phobic coatings on the front and an A/R purple back coat. Case, cleaner and cloth included.



Crystal Grey/
Grey



Tortoise/Driver



GK SPORT - RIMLESS 64-19-126

Ultra light, TR90 frame and polycarbonate lenses. Non-polarized unisex style. Case, cleaner and cloth included.



Tortoise/Yellow



Tortoise/Brown



Crystal Grey/
Grey



GK HELIUM 65-13-127

TR90 frame with polycarbonate lenses. Complete with three sets of lenses in grey, brown and clear. Case, cleaner and cloth included.



Black/Grey



Lavender/Grey



★ WAVE - POLARIZED 51-21-142

Polycarbonate frame with polarized triacetate lenses. Microfiber pouch included.



Black/Grey



Black/Driver



Tortoise/Grey



Tortoise/Driver

GK PLEIN AIR PACKAGE OPTION 67-16-120

GK™ Plein Air sunglasses are designed for individuals, who like to call the great outdoors their home. Photochromic polarized TAC lenses provide consistent UV protection and clarity as light levels fluctuate. Case, cleaner and cloth included. Tortoise PC frame plus two pairs of photochromic polarized TAC lenses in grey and brown.



GK PERSONAL PACKAGE OPTION 67-16-120

Create your package with a frame and two pairs of lenses to make a complete set. These sunglasses will meet the needs for your everyday activities, from the water to the slopes and all the fairways in between. Case, cleaner and cloth included.



Brown TR White TR Black TR Slate TR

SELECT A FRAME COLOR, THEN CHOOSE ONE LENS FROM EACH GROUP IN THE FOLLOWING.

Packages include: case, cleaner, cloth and two pairs of lenses.

GROUP 1 - FAIRWAY LENS (PLANO POLARIZED)

Outdoor polarized with A/R back coat reduces glare and improves visual acuity. Optimal for on the water or the slopes.

Plano / Polarized

Brown Golf, Green Golf or Driver Golf

GROUP 2 - FAIRWAY LENS (BIFOCAL)

Eclipse Technology renders the 'add' virtually invisible. Golfocals with Eclipse Technology will let you enjoy your outdoor activities without the hassle of changing your glasses. Ideal for perfecting your golf game.

Eclipse Technology / Non-Polarized

Green or Brown Golf

+1.50, +2.00, +2.50 with Eclipse Technology and A/R back coat

OR

Plano / Non-Polarized

Brown Golf, Green Golf or Driver Golf

All with A/R back coat.



Charlie Sun™

CHARLIE SUN™ is our newest line of children's sunglasses constructed with a durable TR90 frame, 180° hinges, polarized triacetate lenses with a mirror coating and 8 layer backside A/R 100% UV protection lenses that transmit 18% light.

Minimum orders of an 12 piece fitting kit receive 4 of each style, Aubrey, Jayden and Skye, 2 of each colour and a display stand with a branded features plaque. Each unit includes a silicone cord and microfiber pouch.

**180°
FLEX HINGES**
**8 LAYER
BACKSIDE A/R
COATING**
MINIMUM ORDER
OF 12 PCS.



★ **AUBREY** 41-17-118

Suitable for kids 1-3 years.



Matte Red



Matte Dark Blue



★ **JAYDEN** 45-17-124

Suitable for kids 3-9 years.



Dark Blue



Dark Grey



★ **SKYE** 48-18-122

Suitable for kids 9+ years.



Black



Dark Blue



SEEKERS

SEEKERS are our newest line of children's promotional sunglasses constructed with 100% UV400 PC lenses that transmit 13% - 18% light. Ideal as a give-away for trunk shows, special events or even for retail sales, these fun and trendy glasses are one of our bestsellers .

COMING SOON



★ **SEEKERS AVIATORS MEDIUM** 40-14-105

Suitable for kids 0-3 years. High gloss TPE frame with UV400 PC lens with 18% light transmittance.
Promotional item - minimum order of 12 pcs per colour per style.



Aqua Pink Blue Black

COMING SOON



★ **SEEKERS AVIATORS LARGE** 46-14-115

Suitable for kids 3-6 years. High gloss TPE frame with UV400 PC lens. 18% light transmittance.
Promotional item - minimum order of 12 pcs per colour per style.



Aqua Pink Blue Black

COMING SOON



★ **SEEKERS AVIATORS EXTRA LARGE** 50-14-123

Suitable for kids 6-10 years. High gloss TPE frame with UV400 PC lens with 18% light transmittance.
Promotional item - minimum order of 12 pcs per colour per style.



Blue Black



★ **SEEKERS SMALL** 39-17-110

Suitable for kids 0-3 years. Polycarbonate silk matte frame with UV400 PC lenses that transmit 13% of visible light.
Promotional item - minimum order of 12 pcs per colour per style.



Pink/Blue

Teal/Orange



★ **SEEKERS MEDIUM ROUND** 43-15-130

Suitable for kids 3-6 years. Polycarbonate silk matte frame with UV400 PC cool mirrored lenses that transmit 13% of visible light.
Promotional item - minimum order of 12 pcs per colour per style.



Black/Neon Orange

Blue/Yellow

Navy Blue Neon Green



★ **SEEKERS MEDIUM** 45-16-125

Suitable for kids 6-10 years. Polycarbonate silk matte frame with UV400 PC lenses that transmit 13% of visible light.
Promotional item - minimum order of 12 pcs per colour per style.



Black/Neon Orange

Blue/Yellow

Navy Blue Neon Green



★ **SEEKERS LARGE** 44-20-125

Suitable for kids 6-10 years. Silk matte frame with 100% UV polycarbonate lenses that transmit 13% light.
Promotional item - minimum order of 12 pcs per colour per style.



Black/Neon Orange

Blue/Yellow

Navy Blue Neon Green

PROTEKT™ SUPER KIDS

PROTEKT™ SUPER KIDS is our premium line of children's sunglasses constructed of durable TR-90 material with polycarbonate lenses transmitting a minimum of 80% of visible light. The low bridge design on the smaller sizes is ideal for the underdeveloped bridge on small children.



STING 48-110

Suitable for kids 6-9 years. TR90 frame with polarized polycarbonate lenses.



Crystal Brown Crystal Green



★ **SHOTZ** 40-110

Suitable for kids 0-3 years. TR90 frame with polycarbonate lenses.



Crystal Green Pearl Green



RILEY 44-110

Suitable for kids 0-3 years. TR90 frame with polycarbonate lenses.



Crystal Orange



SKEETER 38-110

Suitable for kids 0-3 years. TR90 frame with polycarbonate lenses.



Crystal Green Pearl Green



SLING 52-120

Suitable for kids 6-9 years. Polycarbonate frame.



Matte Clear Crystal Pink Crystal Purple

READERS

Ladies

Mens

Unisex

Hydrotac



★ **AUDREY** 51-18-135

Ophthalmic metal reader with spring hinges and smooth temple detail. Stainless steel, semi-rimless frame and acrylic lenses. **+1.00 to +3.00 in quarter diopters**



Matte Black



★ **MOSAIC** 52-17-140

Geometric-shaped readers with silver accent plaques and mosaic patterned temples. Spring hinges, polycarbonate frame & acrylic lenses. **+0.75 to +3.00 in quarter diopters, +3.50**



Blue



Orange



Pink



★ **FERN** 50-16-140

Beautifully crafted, trendy and comfortable with spring hinges, silver accent plaques, and fern patterned temples. Polycarbonate frame & acrylic lenses. **+0.75 to +3.00 in quarter diopters, +3.50**



Blue



Brown



Purple

COMING SOON



VIVIAN 50-18-140

Lightweight ladies metal reader with an elegant pattern on the temples. Stainless steel frame & acrylic lenses. **+0.75 to +3.00 in quarter diopters**



Purple/Silver



LOTUS 50-18-140

Attractively styled to assist patients with makeup application. The single lens flips from eye to eye for easy use. Nickel/Silver frame & acrylic lenses. **3.00, +3.50**



Purple



Detail

CASE INCLUDED WITH ALL READERS

★ **TRUMAN** 54-18-140

Ophthalmic metal reader with spring hinges and smooth temple detail. Stainless steel frame and acrylic lenses.

+1.00 to +4.00 in quarter diopters



Gunmetal Matte Grey



★ **MAGNUM** 55-17-140

Ophthalmic semi-rimless reader. Stainless steel frame and CR-39 A/R back coat lenses. **+0.75 to +3.00 in quarter diopters**



Black



Brown



Gunmetal



STEALTH 53-19-140

Ophthalmic metal reader with spring hinges and ridged temple detail. Stainless steel frame and acrylic lenses.

+1.00 to +3.00 in quarter diopters



Gunmetal



GENT 53-19-133

Ophthalmic quality reader. Stainless steel frame with TR-90 temples and acrylic lenses. **+1.00 to +3.00 in quarter diopters**



Brown



Gunmetal



★ **BENZ** 47-22-151

European style, stainless steel frame and acrylic lenses.

+1.00 to +3.00 in quarter diopters



Black/Black



Brown/Black



Silver/Black



CASE INCLUDED WITH ALL READERS

★ **BESTSELLER** ★ **NEW PRODUCT**



★ **MAJOR SPRING** 50-17-135

Classic style stainless steel frame with acrylic lenses.
+1.00 to +3.00 in quarter diopters, +3.50, +4.00, +4.50 & +5.00



Brown



Gunmetal



★ **JAG** 48-17-135

Rectangular ophthalmic frame with hand-made acetate temples and spring hinges. Stainless steel frame with acrylic lenses.
+0.75 to +3.00 in quarter diopters



Gunmetal



REMINGTON 48-15-142

Stainless frame with soft rubber temple covers & nose pieces.
+1.00 to +3.00 in quarter diopters



Gunmetal



CRUSH 50-18-138

Extremely durable ophthalmic reader. Polycarbonate frame and acrylic lenses.
+1.00 to +3.00 in quarter diopters



Purple



Red



ROGUE 53-16-140

With light-as-a-feather construction, the Rogue frame is easy to forget you have on. TR-90 frame with polycarbonate reading lenses.
+3.00 Only



Black/Grey



Blue/Light Blue

CASE INCLUDED WITH ALL READERS

★ CAMBRIDGE 47-20-145

Classic and stylish reader that is lightweight and comfortable. Spring hinges, metal accents, and soft touch polycarbonate frame with acrylic A/R back coat lenses.

+1.00 to +3.00 in quarter diopters, +3.50



Black Brown Grey Red Tortoise



★ YALE 51-20-142

Beautifully designed unisex frame that is both fashionable and comfortable. Spring hinges, metal accents and a tortoise patterned soft touch polycarbonate frame with acrylic A/R back coat lenses. **+0.75 to +3.00 in quarter diopters, +3.50**



Blue Green Purple Red



★ DEX 53-19-134

Modern rectangular frame with wood grain pattern temples and spring hinges. Polycarbonate frame with acrylic lenses.

+1.00 to +3.00 in quarter diopters



Black/Grey



EXECUTIVE 50-17-135

Classic yet modern, this reader boasts vintage flair, with its acetate frame front and spring hinge temples in Red or Black.

+1.00 to +3.00 in quarter diopters



Red Black



★ KENNEDY 53-19-143

Classic Style. Polycarbonate frame with acrylic lenses.

+1.00 to +3.00 in quarter diopters



Black



CASE INCLUDED WITH ALL READERS



★ **HANG 20** 54-17-135

Hang 20 readers include a second sunglass UV400 reading lens at no charge. Polycarbonate frame with acrylic lenses.

+1.00 to +3.00 in quarter diopters



Tortoise Clear/Black Black/Burberry



HANG 22 52-18-150

Available in bright fun colors with interchangeable frame fronts and temples. Purchase multiple pairs to change your color combination daily, reflecting your mood or style. Polycarbonate frame with acrylic lenses.

+1.00 to +2.50 in quarter diopters, +3.00



Clear/Purple Green/Orange Orange/Blue Orange/Orange Red/Purple



★ **HANG 23** 45-17-165

Polycarbonate soft touch frame with spring hinges. Polycarbonate blue light filter lenses.

+0.75 to +3.00 in quarter diopters



Dark Blue Dark Brown Purple Blue Green



★ **LENNON** 43-17-140

Polycarbonate frame with Polycarbonate blue light filter lenses.

+0.75 to +3.00 in quarter diopters



Dark Brown Olive Dark Blue

CASE INCLUDED WITH ALL READERS

PROFESSIONAL 51-19-137

Unisex 4 point classic style reader with polycarbonate frame and lenses.

+1.00 to +3.00 in quarter diopters



Gunmetal/Black

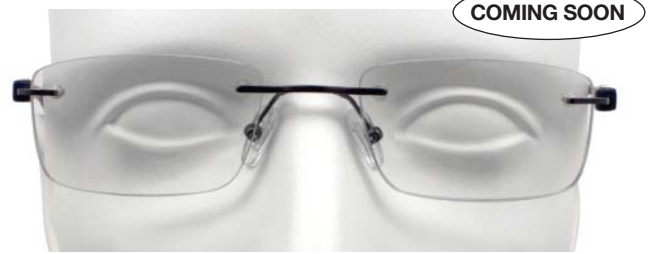

DILIGENT 50-15-145

Unisex semi-rimless classic European style reader with ultra light TR-90 temples. Stainless steel frame with acrylic lenses.

+1.00 to +3.00 in quarter diopters



Navy



UNI SPEC 52-18-135

Light rimless unisex reader, polycarbonate frame and lens.

+1.00, +1.25, +1.50, +1.75, +2.00, +2.50, +3.00



Black



Lemon



Purple



Tortoise



FLASH 54-17-135

Wonderful for camping trips, boating, or just maintenance in your home when low light is a factor. Polycarbonate frame with acrylic lenses. A set of spare batteries included.

+1.00, +1.50, +2.00, +2.50



Black



Tortoise



CLIP-ON READERS A=58 mm, B=30 mm

Clips on to patients' existing frames to provide reading powers. Ideal for computer use.

+1.00 to +3.50 in quarter diopters



Made in USA





Merge style and flexibility with the innovative Fusion Reader Collection. Each frame comes with a set of multi-coloured temples and includes a case. Additional lenses and temples can be purchased separately. An ideal reader or RX frame.

FUSION READER

Option 1

Fusion or Fusion II frame, 4 temples, custom case

Option 2

Fusion or Fusion II frame, 2 temples, custom case

FUSION FITTING KIT, 6PC

4 Fusion frames, 2 temples for each frame, custom case
2 Fusion II frames, 2 temples for each frame, custom case

FUSION LENS KIT, 20PC

Fusion lens kit, 20 prs pre-cut Fusion and Fusion II reading glass lenses.

+1.00, +1.25, +1.50, +1.75, +2.00, +2.25, +2.50, +2.75, +3.00
+1.00, +1.25, +1.50, +1.75, +2.00, +2.25, +2.50, +2.75, +3.00
+1.50, +1.75



FUSION 53-17-140

Semi-rimless ophthalmic frame with interchangeable reading lenses
Monel frame with polycarbonate A/R back coat lenses and TR-90 temples. **+1.00, +1.25, +1.50, +1.75, +2.00, +2.75**



Brown Brown Gunmetal Red



FUSION II 50-18-135

Semi-rimless ophthalmic frame with interchangeable reading lenses
Monel frame with polycarbonate A/R back coat lenses and TR-90 temples. **+1.00 to +3.00 in quarter diopters**



Black Gunmetal

**REPLACEMENT
TEMPLES**
Switch the look of your
Fusion frames with our
TR-90 interchangeable
temples

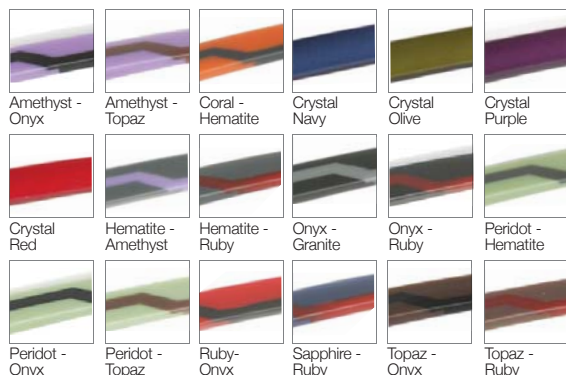

ACTIVE LIFESTYLE

Progear Eyeguard
Swim/Dive
Safety Eyewear

PROGEAR EYEGUARD

Our fitting kit saves time and money by allowing you to order the correct size, model and colour for your customer the first time.



FITTING KIT, 7PC Includes 7 frames in all 4 sizes, both temple model and full strap, 3 windguards small, medium and large as well as a counter display. Official FIFA soccer ball included.



The first Rx-able safety sports frame that passes all three international safety standards: ASTM F803 (USA), EN166 (Europe) and JIS T8147 (Japan). All Progear® products include a case and microfiber cleaning cloth with a one year warranty against manufacturer's defects.

FEATURES AND BENEFITS

- V-shaped groove (1.6 mm high towards the inside) for lens safety in the event of impact
- Solid polycarbonate frame for increased impact protection
- Hypo-allergenic, expanded thermoplastic rubber (TPR) nose pad for additional protection
- Removable and adjustable neoprene band with washable Velcro fastener
- Anti-slip TPR temple pad
- Rimlock barrel and screws made of high quality stainless steel to prevent corrosion with a built-in lockable spacer make Rx glazing easy
- Detachable front shock damper and inner safety side-cushion to absorb impacts
- High viscosity polycarbonate lens with 3 mm center thickness, Plano Anti-fog, scratch-resistant hard coating and UV protection

Progear® Eyeguards meet or exceed ASTM F803-03 impact resistance for several sports. Also meets EN-166 (Europe) and JIS T8147.5.1d (Japan) safety standards.

Sports	Sustains Impact Speed at (m/sec)	Sustains Impact Speed at (mph)
Squash, Badminton, Handball, Basketball, Volleyball, & Soccer	40	90
Racquetball & Paddle ball	40	90
Baseball & Softball	18 (for age < 9) 25 (for age 9-14) 31 (for age >14)	40 55 70

KIDS - TEMPLE MODEL 48-18-117
SUITABLE FOR AGES 6-10 YEARS



KIDS - FULL STRAP 48-18
SUITABLE FOR AGES 6-10 YEARS





★ **YOUTH - TEMPLE MODEL** 52-18-122
SUITABLE FOR AGES 11 TO 16 YRS

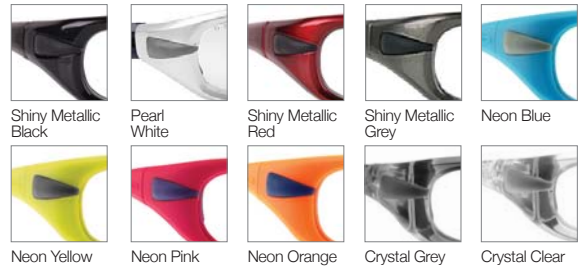

YOUTH - FULL STRAP 52-18
SUITABLE FOR AGES 11 TO 16 YRS



★ **ADULTS - TEMPLE MODEL** 55-19-122



ADULTS - FULL STRAP 55-19



ADULTS X-LARGE - TEMPLE MODEL 57-19-122

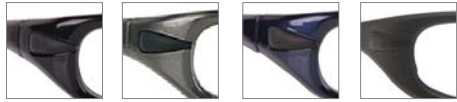

Shiny Metallic Black Shiny Metallic Grey Shiny Metallic Blue Matte Graphite



ADULTS X-LARGE - FULL STRAP 57-19

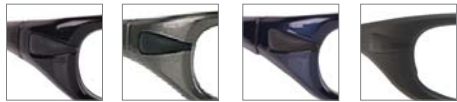

Shiny Metallic Black Shiny Metallic Grey Shiny Metallic Blue Matte Graphite



WINDGUARDS SPONGE

Designed with sweat absorbing material, excellent for high intensity sports and wind protection. Available in all sizes.

WINDGUARDS EVA

Perfect for sports such as cycling, motorcycling, boating and other leisure activities requiring wind protection. Available in all sizes.



ADDITIONAL ACCESSORIES AND REPLACEMENT PARTS AVAILABLE FOR ALL PROGEAR® EYEGUARD PRODUCTS

- Full head straps
- Temple straps
- Rubber temple pads and nose pads
- Cases



STOCK LENSES

2.0 mm (center thickness) Polycarbonate HMC (Hard Multi-Coat A/R) lenses. Available from **+3.00 to -6.00 with a cylinder range from 0 to -2.00.**

**PROGEAR®
EYEGUARD FRAME
& LENS PACKAGE**

- OPTION 1 - Frame Only**
- OPTION 2 - Frame & Stock Lenses**
- OPTION 3 - Frame & Stock Lenses w/ Edging and Shipping**



Progear® H2O can accommodate a power range of **+6.00 to -11.00, up to 3.00 cyl** and works with any lens material, clear, tinted, anti-fog coated, etc.. Progear® H2O has a patented lens glazing structure that uses conventional V-bevel lenses and is water-sealed with a rubber "O-ring".

Available in two models, standard and large, both manufactured with hypo-allergenic, latex-free, silicone eye-seals and straps. All models come in three frame colours (smoke, indigo and violet). Three bridge sizes are included for a perfect fit, along with a soft neoprene pouch for easy storage and protection after use.

FEATURES AND BENEFITS

- Accommodates a power range of **+6.00 to -11.00**
- Completely water tight for leakage prevention
- Hypo-allergenic & Latex free
- Multiple bridge sizes included for optimum PD adjustment
- Soft neoprene pouch for convenient storage
- Replacement parts available
- Replacement parts available



★ **SWIM GOGGLE** HSV-1301

Standard cup size



★ **SWIM GOGGLE** HSV-1302

Large cup size





Recognized by pro and elite triathletes and competitive swimmers for their precise optics, comfort and safety, Sable Swim Goggles are the best choice for the individual professional athlete or for recreational swimmers.

Sable Swim Goggles are available in prescription (advanced, thin-lens aspheric technology for prescriptions **-1.50 to -10.00.**) and non-prescription styles. Flat Lens technology offers spectacular sighting in open water with an Anti-Fog guarantee.

FEATURES AND BENEFITS

- Unchanged vision above or underwater. Contact surface with water is absolutely flat. Non-distortion, high precision lenses. Refraction minimized to within 0.125 D.
- Conforms to pupil distance of most near-sighted people. Oval lens. Focal point is offset 4 mm to give a wider field of view. Small, medium or large size bridge available. Small fits PD 61 mm, medium fits 64 mm, large fits 67 mm. 3 mm tolerance creates effective PD range of 58 mm to 70 mm.
- One-touch buckle design. Goggle can be removed without hair tangling.
- 100% silicone gasket and head strap are non-toxic, and non-allergenic. Flexibility of parts extends product life and silicone material provides a superior seal.
- Polycarbonate optical lens is virtually unbreakable with a high gloss, hard coating with UV protection.

SOAP OR ANTI-REFLECTION SPRAY CLEANERS SHOULD NOT BE USED ON THE LENSES AS THE ANTI-FOG COATING WILL BE DAMAGED

★ **SABLE SWIM GOGGLE**

Available with black or clear strap option. Separate eye cups are available to match different powered prescriptions. Note: If swim goggles are custom made per customer's request, they will be non-returnable.

-1.50 to -6.50 in half diopters, -7.00 to -10.00 in full diopters.



DIVE MASK

Lightweight with an adjustable head strap for comfort. This dive mask is extremely durable with an exceptional field of vision for both snorkeling and diving. Comes equipped with glass lenses. Available in both plano and Rx. Rx model is non-returnable after Rx insertion.

-1.50 to -6.50 in half diopters, -7.00 to -10.00 in full diopters.



Blue/Grey



Black/Yellow



PROTEKT™

The name says it all for first class safety on the job. Keep yourself safe with clear vision and industry leading protection with Protekt™.

PROTEKT™ safety frames are available in:

- Standard Plano
- Adjustable Plano (with adjustable temples)
- Bifocal models



★ **GHOST - PLANO** 80-16-130 ANSI Z87+

Flash mirror and A/R back coating. Meets safety standards as rated by ANSI. Includes a microfiber pouch.



GHOST - BIFOCAL 80-16-130 ANSI Z87+

A/R back coating. Meets safety standards as rated by ANSI. Includes a microfiber pouch. **+1.50, +2.00, +2.50**



PHANTOM - PLANO 70-15-135 ANSI Z87.1

Flash mirror and A/R back coating, length adjustable temples. Meets safety standards as rated by ANSI. Includes a microfiber pouch.



MAG 1 - RX-ABLE SAFETY FRAME

Slim design is ideally suited for use under air packs or helmets. It is manufactured of a high grade DuPont® Nylon and it is ANSI Z87.1 approved. 25mm bridge and short bridle kit available by special order.

Sizes: 46 mm, 48 mm & 50 mm



CHAINS & CORDS

Fashion Chains
Eye Glass Loupes
EK Cat Straps
Protekt & Ziko Cords
Croakies

CHAINS & CORDS | FASHION CHAINS

20/20 FASHION CHAINS

Our large selection of chains is always available to keep your stock fresh and contemporary with something for every customer.



RECEIVE
A FREE
DISPLAY WITH A
FASHION CHAIN
PURCHASE
OVER \$250

FASHION CHAIN COLLECTION

LINK CHAIN

Multi-coloured beads



★ BALI CHAIN

Silver with aqua beads



BOHEMIAN CHAIN

Silver with beads



LUCY & BETTY

6/pkg, 3 PCS of each colour



THIN CLASSIC CHAIN

6/pkg, 2PCS of each colour



Black Blue Rose Gold

THICK CLASSIC CHAIN

6/pkg, 2PCS of each colour



Black Blue Rose Gold

★ TWISTER CHAIN

6/pkg, 2PCS of each colour

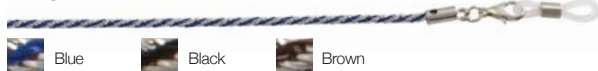

Blue Black Brown

★ REFLEX CHAIN

6/pkg, 2PCS of each colour

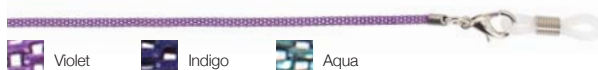

Violet Indigo Aqua

CAROLINE ABRAM - PARIS CHAIN COLLECTION



Square 1



Rouge 1

EUROPEAN CHAIN COLLECTION



Chain 1-7



★ Chain 1-11



★ Chain 1-13

"NEK ART" CHAIN COLLECTION



Chain 2-4



Chain 2-5



Chain 2-6



Chain 2-7



Chain 2-8



Chain 2-9



Chain 2-10



Chain 2-11



Chain 2-12

"NEK ART" CHAIN COLLECTION - LOUPES



Chain 2-1



Chain 2-2

RECEIVE
A T-STAND DISPLAY
WITH YOUR PURCHASE
Minimum purchase of
12 PCS with the 'Nek Art'
Collection
& minimum purchase of 24
PCS with the European
Collection



GK STERLING 92.5 SILVER BALI COLLECTION

Our GK™ Bali Collection. Handcrafted in Bali, these sterling silver 92.5 holders are available in two different pendant styles and come in four different ultra-suede cord colours.



EYEGGLASS HOLDER



EYEGGLASS HOLDER GK

Cord Colours:



CAROLINE ABRAM LOUPES



LOUPES 3





★ **3-WAY**

This retainer can be worn straight off the temple tip or in a spectacle position worn off the temple. **Length 24"**



★ **FAT CATS 3-WAY**

Our 3-Way Eyewear Retainer over sized! The Fat Cat is made with 3mm rope and rubber ends, designed specifically for those extra large earpieces and temples. **Length 24"**



★ **THIN CATS 3-WAY**

A thinner version of the original Cat Strap in a 3mm rope made with the same great quality and features. Rubber tubing in a slimmed down style and includes the rubber adjustable slider. **Length 22"**



★ **CUSANO LEATHER ELITE- 3-WAY**

Geniune napa leather with enhanced stitching and pewter finished slide adjuster. This eyewear retainer combines fashion and function while keeping eyewear secure. The patented 3-way connector allows you to attach the retainer with three different options; straight, angles, or as a spec attachment. The Cusano Leather 3-Way is available in five colour combinations. **Length 24"**

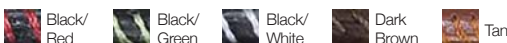

★ **TECH 3-WAY**

Features a revolutionary transparent material designed to stay off your neck and collar for a low profile, comfortable fit. The 3-way end can be worn straight off the earpiece, in a spectacle position, or at an angle. **Length 12"**



ZIKO™

Ziko™ cords are made with the finest quality materials.

TRAKZ STRAIGHT

Made with 4 mm thick cord and fitted with our custom made Trakz temple grips to fit medium and large frames.

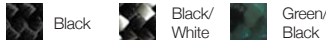

TRAKZ FAT

Made with 4 mm thick cord and fitted with our custom made Trakz temple grips to fit medium and large frames.

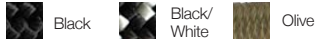

★ TRAKZ THIN

Made with 3 mm cord, silicone tube designed to grip sleek wire frames.



TRAKZ LOOP

Made with the finest quality mountaineering 3 mm cord, fitted with a zero UV resistant end.



★ GHOST

Almost invisible but they are always reliable.



SKINZ ORIGINAL

In top quality full grain leather.



★ MICROWINDER

Nylon cord made with basic simplicity. Fun, bright, lightweight and come in a variety of colours.

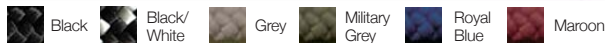

★ KIDZ GHOST



★ KIDZ MICRO



★ KIDZ SHORTY

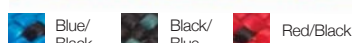

PROTEKT™

Protekt™ is our economical 20/20 option with quality production and great colour options.

★ **PROTEKT™ SLIDER** takes retainers to a new level, allowing infinite adjustment between 10"-16". Close to the head for a secure fit or off the neck, your choice. Coated cable. Custom printing available.



PROTEKT™ SPORT



★ **PROTEKT™ SPORT ELASTIC**, Latex free ends, Black 12/pkg



★ **PROTEKT™ PREMIUM NYLON**, pkg of 12 per colour



★ **PROTEKT™ WAX DARK**, 6/pkg, 2PCS of each colour



★ **PROTEKT™ WAX NEUTRAL**, 6/pkg, 2PCS of each colour



★ **PROTEKT™ PRO STRETCH**, 6/pkg, 2PCS of each colour



★ **PROTEKT™ PRO SPORT**, 6/pkg, 2PCS of each colour



PROTEKT™ NEW COLLECTION



PROTEKT™ LEATHER



PROTEKT™ APACHE

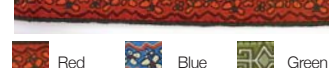



The ARC is Croakies® most technically advanced line of sport retainers, with a sleek and modern look. The ARC stands apart from other cable retainers with superior quality and advanced adjust-ability. The ARC Endless also features Croakies® Endless length adjustment technology.

Ends are available as replacements and in combo packs. Choose your cord and choose your ends for optimum security of your valuable eyewear.

ARC ENDLESS

Stainless steel cable with adjustable lengths. Available in:
 14" Kids - extends to 14" shortens to 9"
 16" - extends to 16" shortens to 10"
 18" - extends to 18" shortens to 11"



★ Black with black cones



Silver with white cones

TERRA ENDLESS

15" long & 3.2 mm diameter. Durable woven cord with endless adjustment system.



Navy
 Brown
 Black

★ **TERRA ENDLESS, LONG**

33" long & 3.2 mm diameter. Durable woven cord with endless



Navy
 Brown
 Black

★ **LYCRA® SUITER FLOATER***

28" long & 0.5" wide. Closed cell foam with adjustable soft foam bead. High-quality, non-absorbent, quick dry Lycra®.



*Flotation Factor = CFF +1: smaller plastic frames (.04kg - .06kg) & smaller metal frames (.02kg - .03kg)

ARC ENDS

Molded UV resistant ends that snap on and off. Available in a package of two.

SIZE	SHAPE
XXL 9-15 mm	
XL 6-9 mm	
REG 3-5 mm	
MICRO 2-4 mm	
XL TITE 7-10 mm	
REG TITE 6-7 mm	

LAB SUPPLIES

Hand Tools

Tag & Label

Equipment

Lab Consumables

Chemicals

Contact Lens Accessories

Lenses

Repair Parts

RIMLESS ADJUSTING PLIER



★ **NYLON ADJUSTING PLIER ROUND / SQUARE**

Nylon pad jaw is 8 mm. Round nose tip diameter 2 mm. Used on semi-rimless cord suspension.

Round or Square Jaw



★ **NARROW DOUBLE NYLON PLIER**

Metal and plastic frames are held firmly without marring or marking. 5 mm wide, ideal for tight spots. Replaceable jaws.



DOUBLE NYLON PLIER

10 mm wide jaws.



LONG NOSE PLIER

All purpose plier for holding and shaping. Smooth jaw and radius-tapered edges.



★ **SLIMLINE NOSE PAD ADJUSTING PLIER**

Designed so that the hollow side of plier fits around pad receiver on the opposite side of plier. Holds the pad and arm firmly.



PAD ADJUSTING PLIER

Designed so that hollow side of plier fits around pad receiver on the opposite side of plier. Holds the pad and arm firmly.



CARBIDE END CUTTING PLIER, DOUBLE LAP HINGE

Blades angled at 10 degrees. Length of blades 19 mm for general cutting and to reach in difficult areas with better visibility. Carbide blades designed to effectively cut stainless steel and other hard metals up to 2.1 mm diameter. Dual leaf spring handles.



★ **MINI CARBIDE END CUTTING PLIERS**

Double jointed for extra leverage and strength. Carbide blades designed to effectively cut stainless steel and other hard metals up to 2.1 mm diameter. Dual leaf spring handles.



SIDE CUTTER

Durability, strength and power. Carbide blades designed to effectively cut stainless steel or hard metal up to 2.1 mm diameter. Dual leaf-spring handles.



1 YEAR WARRANTY
on all Value tools
2 YEAR WARRANTY
on all European tools
for manufacturer defects

RIMLESS DISASSEMBLY PLIER

For use with silhouette style mountings.



★ **DOUBLE NYLON JAW EYEWIRE SHAPER**

Adjusts the curvature of the eyewire to the appropriate curvature of the lens.



RIMLESS MOUNTING PLIER

For use with silhouette style mountings.



LENS AXIS ALIGNING PLIER

Rubber pads are 23 mm long, oval shaped. Self-swiveling pads.



THREE POINT PLIER



BLOCKING PAD REMOVAL PLIER



RIMLESS CUTTING PLIER

Suitable for rimless screws. Allows user to cut screws close to lens surface without scratching. Dual leaf spring handles.



PEENING PLIER



EYEWIRE SIZING PLIER

Tips are tapered to very fine points and are offset to the side and front of plier jaw. Will access to all types of eye wire hinge barrels.



PROTEKT™ DISPENSING TOOL RACK 6"



- ★ BESTSELLER
- EUROPEAN MADE
- VALUE

LAB SUPPLIES | HAND TOOLS

SCREWDRIVER BALL BEARING



★ SCREWDRIVER ALUMINUM



BLADE EXTRACTOR 1.1 mm



BLADE EXTRACTOR 1.5 mm



BLADE EXTRACTOR 2.0 mm



BLADE PHILLIPS 0.062 X 0.062 ”



BLADE FLAT 0.040 X 0.040 ”



BLADE FLAT 0.062 X 0.072 ”



BLADE FLAT 0.062 X 0.087 ”



BLADE WRENCH 2.25 mm



BLADE WRENCH 2.0 mm



FILE FLAT, 15 cm



FILE HALF ROUND, 15 cm



FILE EXTRA NARROW, 15 cm



★ STAINLESS STEEL RULER, 15 cm



★ SCREWDRIVER WITH BALL BEARING HEAD

Knurled body and screw fitting for the blade.
Diameter of body: 9 mm, Total length: 127 mm



BLADE FLAT 1.0 mm



BLADE FLAT 1.5 mm



BLADE FLAT 1.8 mm



BLADE FLAT 2.3 mm



BLADE PHILLIPS



KNOCK OUT WRENCH, 2.0 mm and 2.25 mm



FILE SCREW HEAD SLOTTING



NOSE PAD POPPER

Notched to slide between pad and pad arm to pop pad off.
Illustrated instructions included. 2-1/2" L



PICKUP SCREWDRIVERS

Jaws automatically adjust by spring tension. Holds screws securely while removing or inserting. Chrome top and handle.



- BLADE FLAT 1.0 mm 
- BLADE FLAT 2.0 mm 
- BLADE PHILLIPS 

HEXAGONAL AND STAR WRENCH

Wrench with spring ejection. Makes the removal of nut easy.



★ **SCREW PICK-UP TWEEZERS, 5.5"**

Locking and holding in one motion. Stainless steel construction. Built in grooves at tip.



SCREW HOLDING TWEEZERS



FINE POINT TWEEZERS



PAD REMOVAL TWEEZERS, 6"





Stainless steel. Push on pad removal tweezers.



- ★ **BESTSELLER**
- **EUROPEAN MADE**
- **VALUE**

WOODEN BLOCK WITH SCREWDRIVERS



- BLADE FLAT 1.0 mm 
- BLADE FLAT 1.5 mm 
- BLADE FLAT 1.8 mm 
- BLADE FLAT 2.3 mm 
- BLADE PHILLIPS 

NUT GRABBER

Durable stainless steel construction. For easy nut and bolt assembly.



MOUNTING RIMLESS HOOK

Hook for use with nylon semi-rimless style mountings.



RIMLESS MOUNTING HOOK REPLACEMENTS

Replacement hooks for use with mounting hook. 3pcs

★ **MAGNETIC TOOL BAR, 18"**

Double bar magnetic holder. Holds metal tools firmly, yet releases without effort.





DISTOMETER

Measures the distance between the cornea and spectacle or trial lenses (vertex distance). This becomes especially sensitive above plus or minus five diopters.



LENS CLOCK

Measures base curve for 1.49 or 1.6 index lenses.



LENS THICKNESS CALIPER

Very precise. Measures lens thickness up to 10 mm with an accuracy of 0.01 mm.



LENS CALIPER

Gives accurate readings for all lens blanks up to 15 mm. Graduated in 1/10 mm with nylon tips. Throat depth 43 mm.



SALT PAN WARMER

Adjustable temperature control, indicator light, 4' grounded power cord and rubber feet. Max temperature 400°F. 6-1/2"(w) x 4-1/4"(h) x 10-5/8"(l).



★ **PD METER**

Digital PD meter with a high level of precision. Displays left and right eye measurements with a range from 22.5 mm to 41mm. Near, intermediate and far viewing distance. Measures vertex distance.



★ **ULTRASONIC CLEANER, 1000ml**

Stainless steel tank, holds multiple pairs of glasses.



ULTRASONIC CLEANER, 500ml

Stainless steel tank, holds one pair of glasses.



HOT AIR WARMER

Quiet & compact with 6 amps. Reduces danger of burning or drying out frames. Generates both warm and cool air.



★ TENSIOMETER 

Tension is applied when mounting a lens. If wrongly applied, such stress can cause distortion and, in glass lenses, chips. Any excessive tensioning on fitted lenses, identified by the tensiometer, should be eliminated. • **3 Year Warranty**



**FEATURE
PRODUCT**
HYGIENE BOX
SEE PG. 79

★ HYGIENE BOX 

Uses a UV-C lamp with high germicide power to destroy bacteria, germs, spores, molds and other micro-organisms from the surface of frames in just a few seconds.

• **3 Year Warranty**



★ FRAME WARMER VUP 

~ 120°C with closed lid
~ 150 °C with hot air concentrator inserted.
• Cut-out switch for overheat protection.
• Metal housing.
• 350 W (+5%/-10%).
• **3 Year Warranty**



★ FRAME WARMER FUP PLUS 

~ 150°C with closed lid
~ 190 °C with hot air concentrator inserted
~ 190 °C with concentrator extension inserted.
• Cut-out switch for overheat protection.
• Electronic heating regulator.
• Cold air option.
• Aluminium housing.
• 350 W (+5%/-10%).
• **3 Year Warranty**

VOLUME
PRICING ON
ALL BLOCKING
PADS

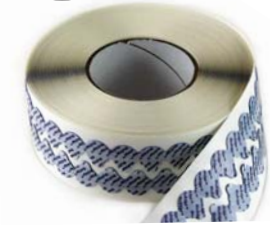

★ PROTEKT™ HYDROPHOBIC BLOCKING PADS

18 mm, Full Eye/1000



PROTEKT™ POWER GRIPPER BLOCKING PADS

Round Blue/1000



PROTEKT™ POWER GRIPPER BLOCKING PADS

1/2 Eye/1000



PROTEKT™ JOB TRAYS

6" W x 1.5" H x 9" D, 26/box, Grey
6" W x 1.5" H x 9" D, 26/box, White
Reusable tray labels white bag/100



LIQUID DISPENSER

4 oz. Polyethylene bottle with stainless steel pump action lid. One way pump holds flux in well of cap and prevents contamination.



LENS HOLDER

High quality polypropylene will not scratch lenses. Lens held in place with snug tension holders. Available in Black & White.



PROTEKT™ EASY CUT PATTERN BLANKS

Oversize Grey/100



PATTERN BLANKS

Oversize or Large White/100



★ UNIVERSAL SOLDER

Package of 6. White (Silver) or Yellow (Gold) with flux core. Swiss made.



WHITE LABELS

105 pcs - Suitable for plastic frame tags.



PLASTIC FRAME TAGS

Bag of 100

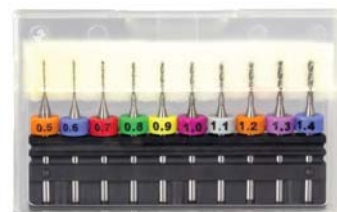

KIT DRILL BIT 0.5MM-1.4MM

Also available in individual sizes.



★ GERMICIDE UV LAMP TO SANITIZE GLASSES AND TRIAL FRAMES

- Ideal for the optician that wishes to sanitize trial glasses without using water, cleansers or heat
- Through the use of a UV-C lamp with high germicide power it destroys the bacteria, germs, spores, molds and other micro-organisms from the surface of glasses in just a few seconds
- **3 Year Warranty**

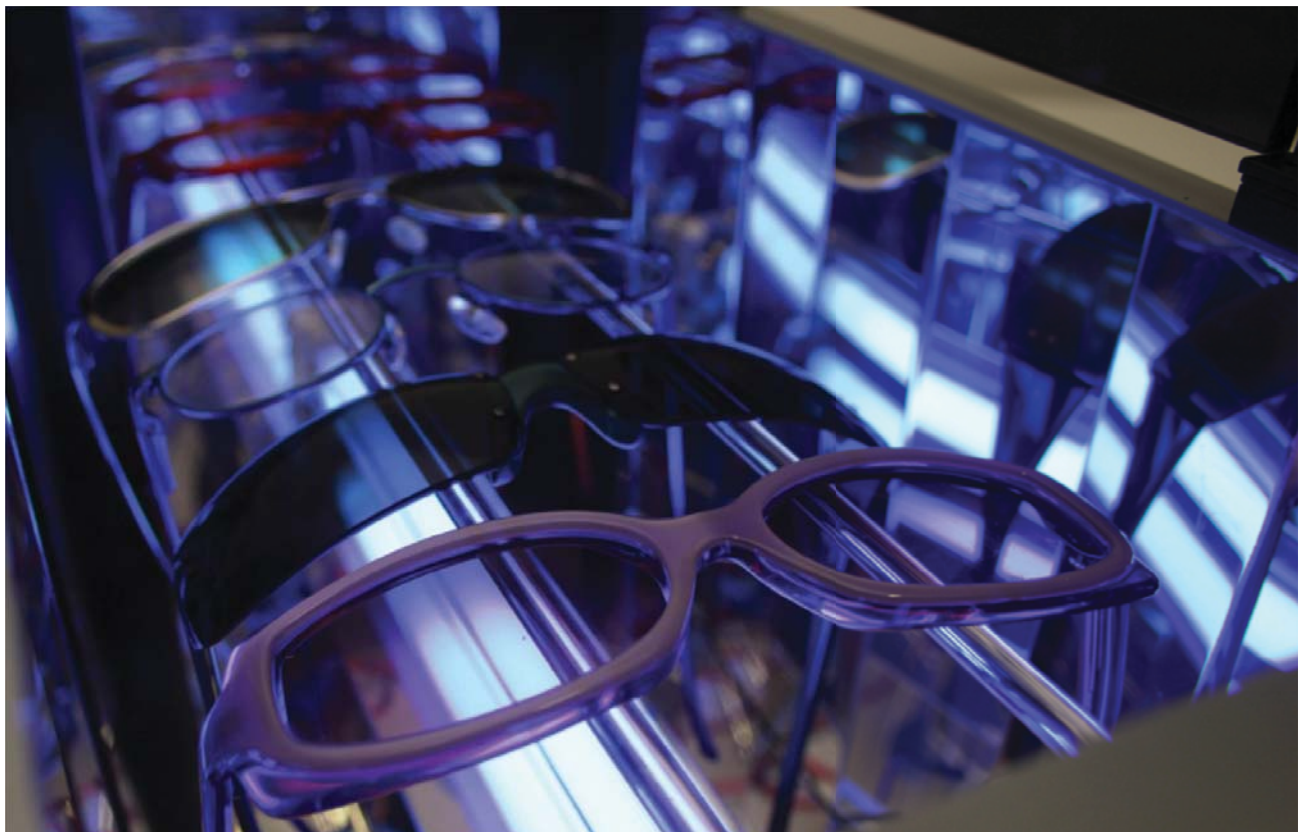

LAB SUPPLIES | CHEMICALS



PROTEKT™ LIQUID DYE, 114 ml

- Blue
- Charcoal
- HD Black
- Cool Grey
- G15
- Green
- Pink
- Sunglass Brown
- HD Brown
- Top Gun Grey
- Yellow



PROTEKT™ BLUE BLOCKER, 114 ml



UV SHIELD CONCENTRATE
250 ml



★ **ALL OFF**
Ink remover, 16 oz



★ **ULTRASONIC CLEANING SOLUTION**
0.95 L / 32 oz



★ **LOCTITE**, 10 ml
Available in Purple (Nickel Silver) and Blue (Stainless Steel).



A/R STRIPPER
250 ml



HEAT TRANSFER FLUID
1 L/4 L



NEUTRALIZER
1 L/4 L



GLASS BEADS FOR SALT PAN
Available in regular & large sizes.



LOCTITE SUPER BONDER, 3 ml



POLISHING COMPOUND CR39



POLISHING COMPOUND POLYCARBONATE

LAB SUPPLIES | CONTACT LENS ACCESSORIES



OVERNIGHT TRAY



CONTACT LENS MAILER, 100PC



LARGE TWEEZERS



PLUNGER

<p>CR-39 POLARIZED 2.1 x 70 mm Made in Japan</p>	 <p>★ Grey</p>	 <p>★ Brown</p>	<p>ALL LENSES PACKAGED IN OUR NEW LENS BOX FOR EASY STORAGE Inquire about volume pricing</p>	
<p>CR-39 1.8 x 74 mm</p>	 <p>Grey</p>	 <p>G15</p>		
<p>CR-39 GRADIENT 1.9 x 72 mm</p>	 <p>Grey w/Silver Mirror</p>	 <p>Grey</p>	 <p>Brown</p>	 <p>Brown w/Silver Mirror</p>
<p>POLYCARBONATE POLARIZED 1.5 mm (50 x 70 mm) Made in Japan</p>	 <p>Grey</p>	 <p>G15</p>	 <p>Brown</p>	
<p>POLYCARBONATE 1.8 x 74 mm</p>	 <p>Grey</p>	 <p>G15</p>	 <p>Brown</p>	
<p>TRI-ACETATE POLARIZED 0.8 mm (66 x 60 mm) Made in Japan</p>	 <p>Dark Grey</p>	 <p>★ Light Grey</p>	 <p>★ Brown</p>	



Screw it in, snap it off, frame repairs in a snap. Snap-it™ stainless steel screws with thread lock have a unique, extra-long feeder tab that makes handling screws a cinch. After a screw is inserted into a hinge or eyewire, the long feeder tab simply snaps off. The screw is left with a smooth finish to eliminate clipping and filing.

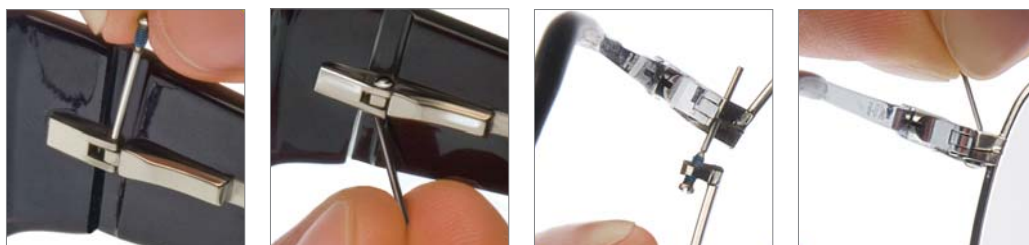

ASSORTED SNAP-IT SCREW KIT

Contains 250PC - 10 sizes 25 screws each



★ Silver

Gold

SNAP-IT HINGE

50 PC/pkg

Thread x Length x Head	PART #
1.3 x 3.5 x 2.0 mm	9133520

★

1.4 x 3.5 x 2.0 mm	9143520
1.4 x 4.0 x 2.0 mm	9144020
1.4 x 4.8 x 2.0 mm	9144820
1.4 x 5.5 x 2.0 mm	9145520
1.4 x 4.0 x 2.5 mm	9144025
1.4 x 4.8 x 2.5 mm	9144825
1.4 x 5.5 x 2.5 mm	9145525

1.5 x 3.5 x 2.0 mm	9153520
1.5 x 4.0 x 2.0 mm	9154020
1.5 x 4.8 x 2.0 mm	9154820
1.5 x 5.5 x 2.0 mm	9155520
1.5 x 4.0 x 2.5 mm	9154025
1.5 x 4.8 x 2.5 mm	9154825
1.5 x 5.5 x 2.5 mm	9155525

SNAP-IT EYEWIRE

50 PC/pkg

Thread x Length x Head	PART #
1.3 x 3.0 x 1.8 mm	9133018
1.4 x 3.0 x 1.8 mm	9143018
1.5 x 3.0 x 1.8 mm	9153018

★

★

1.2 x 4.0 x 1.8 mm	9124018
1.3 x 4.0 x 1.8 mm	9134018
1.4 x 4.0 x 1.8 mm	9144018
1.5 x 4.0 x 1.8 mm	9154018

1.2 x 4.8 x 1.8 mm	9124818
1.3 x 4.8 x 1.8 mm	9134818
1.4 x 4.8 x 1.8 mm	9144818
1.5 x 4.8 x 1.8 mm	9154818

*Please specify Gold as "G" or Silver as "S" after code number.

★ PREMIUM SCREW KIT

Contains 1000PC - 10 skus 100 of each



PREMIUM SCREW HALF KIT

Contains 500PC - 10 skus 50 of each



★ STANDARD SCREW KIT

Contains 1000PC - 10 skus 100 of each



SPECIALTY NOSE PAD KIT

Contains 100pairs - 10 skus 10 pairs of each



EYEWIRE - STAINLESS STEEL

100 PC/pkg, Made in Germany

☉		1.2 x 4.4 mm
☉		1.4 x 3.0 mm
☉		1.4 x 3.5 mm
★ ☉		1.4 x 4.0 mm
☉		1.4 x 4.5 mm
☉		1.4 x 2.8 mm (safety)
☉		1.4 x 3.3 mm (safety)
★ ☉		1.4 x 3.8 mm (safety)
★ ☉		1.4 x 4.3 mm (safety)
☉		1.6 x 5.8 mm

HINGE - STAINLESS STEEL

100 PC/pkg, Made in Germany

☉		1.2 x 3.1 mm Spring Hinge (safety)
★ ☉		1.3 x 3.1 mm Spring Hinge (safety)
☉		1.4 x 3.5 mm Spring Hinge (safety)
★ ☉		1.4 x 4.0 mm Spring Hinge (safety)
☉		1.4 x 4.5 mm (safety)
☉		1.4 x 4.4 mm

SELF TAPPING - STAINLESS STEEL

100 PC/pkg, Made in Germany

☉		1.3 mm Small Head
★ ☉		1.4 mm Small Head
★ ☉		1.5 mm Large Head

NOSE PAD - NICKEL SILVER

100 PC/pkg, Made in Germany

★ ☉		1.0 x 4.1 mm
☉		1.1 x 5.5 mm

NUTS & BOLTS



100 PC/pkg, Made in Germany

☉		1.4 x 10.5 mm Silver 1.4 mm Hexnut Silver
★ ☉		1.2 x 10.6 mm Silver 1.2 mm Hexnut Silver
☉		1.16 x 9.35 mm Gold 1.16 mm Hexnut Gold





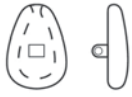
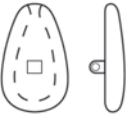
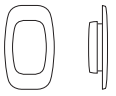



		1.4 mm Hexnut Plastic Coated
		Bushing Plastic
		Washer Plastic
		Cap Silicone

LAB SUPPLIES | REPAIR PARTS - NOSE PADS

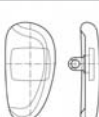
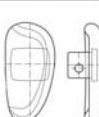

SPECIALTY NOSE PADS

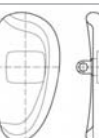
SIZE & SHAPE	SCREW-IN	SNAP-IN
10 mm AIR PADS Silicone 20 prs/pkg		N/A
13 mm AIR PADS Silicone 20 prs/pkg		N/A
10.5 mm MONO Silicone 25 prs/pkg	N/A	
9 mm ROUND Gel 5 prs/pkg		





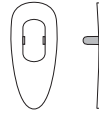
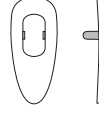









PVC GERMAN NOSE PADS - 25 prs/pkg

SIZE & SHAPE	SCREW-IN	SNAP-IN
11 mm OVAL PVC		
★ 13 mm OVAL PVC		
★ 15 mm D-SHAPED PVC		
17 mm D-SHAPED PVC		
19 mm D-SHAPED PVC		

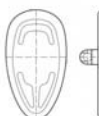
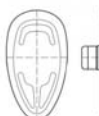
SPECIALTY B&L NOSE PADS - 20 prs/pkg

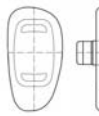
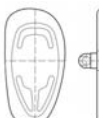
SIZE & SHAPE	SILVER	GOLD
15 mm B&L PVC - Crimp-On		N/A
★ 14.5 mm B&L Silicone - Crimp-On 10 prs/Silver & 10 prs/Gold		

SILICONE PREMIUM GERMAN NOSE PADS - 25 prs/pkg







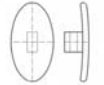

SIZE & SHAPE	SCREW-IN	SNAP-IN
7.5 mm ROUND Phthalate & Latex free		
9 mm ROUND Phthalate & Latex free		
10 mm SYMMETRICAL Phthalate & Latex free		
★ 13 mm SYMMETRICAL Phthalate & Latex free		
16 mm SYMMETRICAL Phthalate & Latex free		
★ 15 mm D-SHAPED Phthalate & Latex free		
17 mm D-SHAPED Phthalate & Latex free		
19 mm D-SHAPED Phthalate & Latex free		

* All Images not actual size





SPECIALTY GERMAN NOSE PADS

SIZE & SHAPE	SCREW-IN	SNAP-IN
9 mm ALT. BASE Silicone Phthalate & Latex free 25 prs/pkg	N/A	
12 mm ALT. BASE PVC 25 prs/pkg	N/A	
11 mm AIR PADS Silicone Phthalate & Latex free 5 prs/pkg		N/A
14.5 mm AIR PADS Silicone Phthalate & Latex free 5 prs/pkg		N/A
13 mm PRIMADONNA Silicone 25 prs/pkg	N/A	
15 mm PRIMADONNA Silicone Phthalate & Latex free 25 prs/pkg	N/A	
★ 14.5 mm WAVE Ultra-Comfort Pad Silicone 5 prs/pkg		
13 mm SLIM Titanium 5 prs/pkg		
★ 13 mm THIN PVC Phthalate & Latex free 25 prs/pkg		

STRAP BRIDGES - 5/pkg

SIZE & SHAPE	SCREW-IN	SNAP-IN
38.8 mm PVC	N/A	
★ 28.5 mm Silicone		
30.5 mm Silicone Phthalate & Latex free		
★ 36.8 mm Silicone Phthalate & Latex free		
38.8 mm Silicone Phthalate & Latex free	N/A	



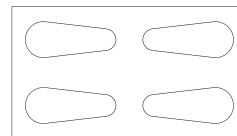

SADDLE BRIDGES - 3/pkg

14.9 mm GOLD Silicone		
16.9 mm GOLD Silicone		

★ **STICK ON NOSE PADS - Silicone, 24 prs/pkg**



VALUE PACK NOSE PADS - 100 prs/pkg

SIZE	7.5 mm ALT. BASE PVC, Snap Only	9 mm ROUND Silicone	★ 13 mm SYMM. Silicone	★ 15 mm SYMM. Silicone	15 mm D-SHAPED Silicone	17 mm SYMM. Silicone
SHAPE - available in snap and screw type unless noted.						

* All Images not actual size

★ **BESTSELLER**

LAB SUPPLIES | REPAIR PARTS - VARIOUS

ROUND TEMPLE TIPS

5 prs/pkg

1.2 x 65 mm Butyrate	 Black	 Tortoise
1.4 x 65 mm Silicone	 Black	 Brown

PVC ROUND TEMPLE TIPS

10 prs/pkg

1.2 x 65 mm	 Black	 Brown
1.3 x 65 mm	 Black	 Brown
1.4 x 65 mm	 Black	 Brown
★ 1.5 x 65 mm	 Black	 Brown
★ 1.6 x 65 mm	 Black	 Brown

★ TEMPLE TIP REPAIR KIT

Assortment of black and brown PVC temple tips in 1.2 - 1.6 mm core sizes. Five pairs of each color and size.



★ TEMPLE LOCKS

One size silicone temple locks. Available in clear or brown. Minimum five pairs per colour.



CONVERSION ENDS



1.25 mm ROUND KIDS

Silicone

1.4 mm ROUND

Silicone

PROTEKT™ CLEAR HEAT SHRINK



- ★ 3 mm = 0.5 mm when shrunk
- ★ 5 mm = 1.0 mm when shrunk
- ★ 7 mm = 1.5 mm when shrunk

PROTEKT™ HEAT SHRINK TUBING



- 2.36 mm = 1.17 mm when shrunk, 10PC
- 5 mm = 2.5 mm when shrunk, 10PC

★ DELUXE KEYCHAIN SCREWDRIVER



★ **RIMLESS CORD**
0.5 mm or 0.6 mm



★ **FIGURE 8 LINER**
0.47 mm, 0.51 mm or 0.6 mm



★ **FLAT LINER (T-Bar)**



★ **LENS LINER**
0.010 or 0.020 gauge



★ **LENS TITE**



DISPLAYS

Display Rods
Display Rod Accessories
Locking Rods
Display Panels
Mobile Displays
Storage Solutions
Accessory Display Centre
Counter Displays
Mirrors

DISPLAYS

CONTACT US
FOR ALL YOUR
DISPLAY NEEDS



TIPS FOR A SUCCESSFUL DISPENSARY

- Use subtle display systems that showcase the product, not the system.
- Never devalue your products by displaying them on low-quality systems.
- Use efficient lighting that will draw attention of passers-by and entice them inside.
- Create a lighting angle that effectively showcases your frames.
- Energize your presentation with lit posters and graphic design elements.
- Keep your space neat and uncluttered. Avoid using too many displays as this will only make it look disorganized.



The patented FixX™ Display System utilizes stainless steel and anodized aluminum components to create an updated and contemporary dispensary look. Frames are held by the patented Eyeglass Support Pod (ESP) which allows frames to be displayed in several different ways. This flexibility combined with various mounting options allow a dispensary to be re-created and refreshed at no additional cost.

Choose your mounts - available in two lengths 2" or 7"

316 Marine grade stainless steel rods for exceptional strength and durability allow two different mounting methods, wall or counter/valance mount. Twelve grey display pods come with each display rod.

Typically, frame rods are anchored by two mounting points. Our wall mounts allow the rods to be mounted dually or by one center point. Mounting by one center point gives great flexibility in varying rod placement.



Made in Canada

WALL MOUNT, 2"

Anodized aluminum finish.



WALL MOUNT, 7"

Anodized aluminum finish.



COUNTER / VALANCE MOUNT, 2"

Anodized aluminum finish.



**DUAL MOUNT
FRAME ROD,
42" or 48"**



**SINGLE MOUNT
FRAME ROD,
42" or 48"**





Made in Canada

Pod Display Options:

Three different looks for thousands of pairs of glasses.



Option 1

Option 2

Option 3

DISPLAY PODS

Display pods are available in clear, grey frosted or copper.



OVAL MAGNIFYING MIRROR



PLEXI SHELF, 5.5" D x 10" W



DISPLAY ROD MIRRORS

Attaches to frame rods.

Mirror Sizes:
6.75" W x 11" H
6.75" W x 23" H



ACCESSORY POST, 3"



ROD LOGO HOLDER

Plexi glass logo holder 4" W x 2" H.
Fits Avery labels 05163.
Slides onto an ESP pod.





LOCKING ROD, 48"

Bridge gap when closed 15 mm.
Holds 16 frames.

LOCKING ROD LOGO HOLDER

4" W x 2" H. Fits Avery labels 05163.
Attaches to locking frame rod.



LOCKING ROD MIRROR

5.75" W x 3.875" H. Clean cut rectangular mirror.
Attaches to locking frame rod.



Open



Closed



Made in Canada



DISPLAY PANEL, 36" X 48"

Fits four frame rods. Frosted clear finish.
Rods not included.

**FULLY
CUSTOMIZABLE
PANELS**

DISPLAY PANEL, 20" X 48"

Fits two frame rods. Frosted clear finish.
Rods not included.

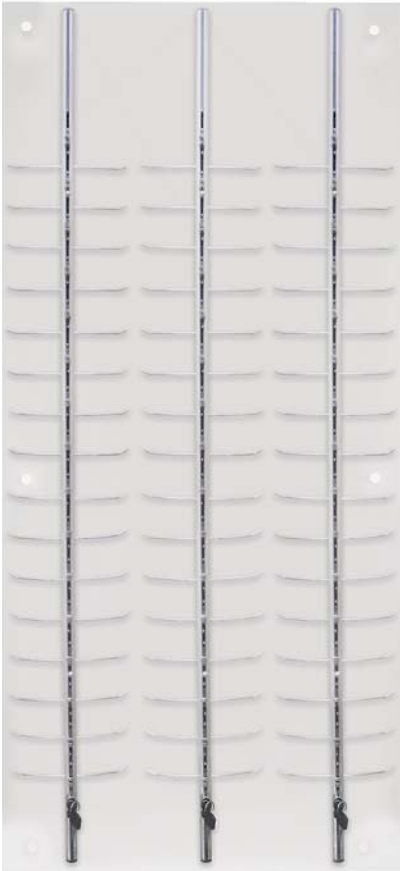

DISPLAY PANEL, 28" X 48"

Fits three frame rods. Frosted clear finish.
Rods not included.

PANEL WALL MOUNTS, 2" & 4"

Aluminum



STAINLESS STEEL FRAME HOLDER

Stainless steel mounts available upon request.





Made in Canada

EYE-CENTRE SINGLE

24.5" W x 78" H, Foot print - 24.5" W x 16" D
Holds 64 frames, locking or non-locking rods.
Available in silver.

EYE-CENTRE DUAL

45" W x 78" H, Foot print - 45" W x 16" D
Holds 128 frames, locking or non-locking rods.
Available in silver.



See Storage Solutions for this specific unit.

The FIXX™ mobile locking & non locking frame rod displays allow for complete flexibility in deciding the optimum display for your practice.

Choose the type and number of rods per panel to create a custom floor display unit suited uniquely to your dispensary. Inquire about pricing.

**DOUBLE YOUR
FRAME COUNT
WITHOUT DOUBLING
WALL SPACE**

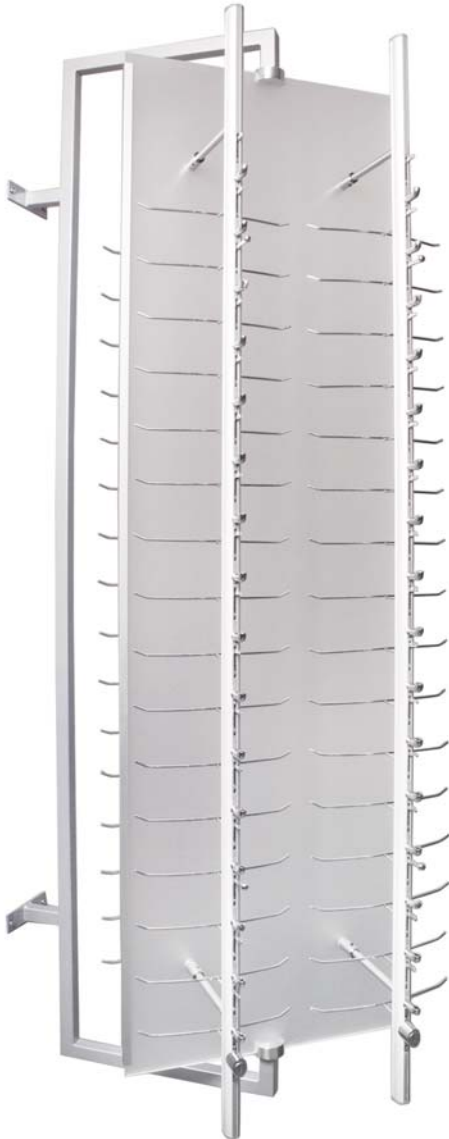

WALL MOUNT DISPLAY

15" W x 52.5" L x 22" D.
Rotating wall mount. Locking or non-locking display holds 64 frames within 15" of wall space. Two rods per side, 16 frames per rod.



**EYE-TREE,
18" X 18" FOOT PRINT**

Locking & non-locking available.
Holds 64 frames.
Available in silver.

DISPLAYS | STORAGE SOLUTIONS

Organize your dispensary with some of these great FIXX™ storage solutions. Configured to optimize space and reduce clutter, these organizers are an ideal way to store extra frame stock, sunglasses or excess manufacturer's cases. Castors allow the units to be moved to a secure location if required. Drawers pull out completely to act as a display case.



ROLLING STORAGE AND DISPLAY CABINET, 14 DRAWERS

15" W x 34.5" H x 15" D

14 drawers -168 places for ophthalmic frame display and storage.
Faux leather finish, padded top. Available in black only.



ROLLING STORAGE AND DISPLAY CABINET, 10 DRAWERS

15" W x 34.5" H x 15" D

10 drawers -100 places for sunglass frame display and storage.
Faux leather finish, padded top. Available in wenge and black.



Present patients' new eyewear in these elegant FIXX™ presentation trays. Use these stylish boxes to store overstock frames, to send home with customers viewing multiple frames or as a retail item. Custom logoing available for this product.

FRAME STORAGE AND OVERNIGHT BOX

6.25" W x 9" L x 2" H
Custom logoing available for this product.

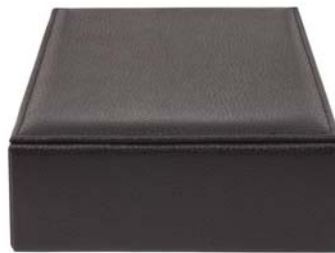

FRAME "SAFE"

6.875" W x 1.625" H x 4" D
Convenient and stylish - keep your glasses out of harms way with the Frame "Safe". One for the office, night stand and car. Features strong magnetic closure and sturdy construction. Easily accepts today's larger frame styles.



PRESENTATION TRAY

6.25" W x 9" L x 2" H



LEATHER RECTANGULAR MIRROR

8" W x 13" H x 7" D



PROTEKT™ EYE-CENTER CABINET

15" W x 24" H x 15" D
Perfect for cases, extra inventories or accessories. Features two compartments and locking door.





**CLEAN & CRISP ACCESSORY CENTRE
WALL MOUNT DISPLAY**

**DESIGN YOUR
ACCESSORY
DISPLAY**



**CLEAN & CRISP ACCESSORY CENTRE
MOBILE DISPLAY**





Made in Canada

With the FIXX™ Eyewear Support Pod (ESP) System, you have the flexibility to display your frames in three different ways; by the bridge with temples open, by the bridge with the temples closed or by the temples themselves. The ESP's are completely modular so you can have your frames facing straight ahead or slightly twisted to one side. You can also increase and decrease the spacing between your frames on the rods.

The ESP's are removable, so once a frame is sold, its pod can be removed so there is no misconception of theft. You also have the choice of how many frames you wish to display from season to season, without having open gaps in your dispensary.



DISPLAY PEDESTALS

Rod lengths:
 2PC - 6", 3PC - 9", 4PC - 12", 5PC - 15"
 Pod colour choices, grey, copper and clear.
 See Display Rod Accessories page.



DISPLAY ROCKS

9" and 12" rod lengths. Each base is unique.
 Pod colour choices, grey, copper and clear. See Display Rod Accessories page.



EYESTEIN DISPENSING ACCESSORY CENTRE
Inquire with our Customer Service team.



PALM
4" W x 8.25" H x 4.25" D
Hand carved individual frame display.
Custom colours available.



NOSE
2.25" W x 6" H x 2.5" D
Hand carved individual frame display.
Custom colours available.

DISPLAYS | MIRRORS

Add style to your dispensary with our beveled counter and wall-mount mirrors with a polished chrome finish. Counter mirrors feature weighted and padded bases for extra stability, while the wall-mount mirrors come equipped with a tilting rod to keep fingerprints off the glass. Choose from a traditional oval shape or an inverted trapezoid shape which is perfect to frame a face for eyeglass dispensing.

OVAL WALL MOUNT MIRROR

10.5" W x 15" H



ILLUMINATED RECTANGULAR DISPENSING MIRROR

11" W x 5.75" H



TRAPEZOID WALL MOUNT MIRROR

10.5" W (Top) x 12.5" H
6.5" W (Bottom)



TRAPEZOID DISPENSING MIRROR

10.5" W (Top) x 12.5" H
6.5" W (Bottom)



LARGE OVAL DISPENSING MIRROR

10.5" W x 15" H



MEDIUM OVAL DISPENSING MIRROR

8" W x 10.5" H



HAND-HELD MIRROR

5.1" W x 7" H
2x magnification front mirror
1x magnification back mirror



PROMOTIONAL

Eye-Patch
Accessories



The Eye-Patch mobile and Eye-Patch tablet are customizable microfiber cleaners, excellent for advertising your business and cleaning the screen of any mobile device - tablets, cell phones, e-readers and the list goes on. Delivered to you in as little as two business days*. Give away this marketing tool to everyone who walks through the door. The more you give, the more exposure you will receive. Just like a tweet, the Eye-Patch Mobile and Eye-Patch tablet will give you more exposure than a newspaper ad at a fraction of the price.

*Pertains to Eye-Patch tablet and upon approval of artwork.

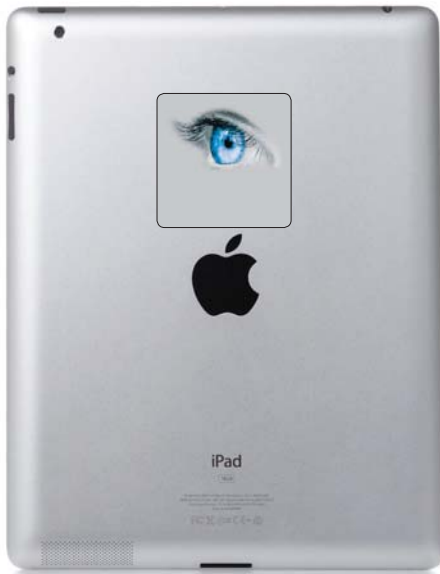

EYE-PATCH TABLET, 2" X 2"

Customizable microfiber patch to advertise your business and clean mobile device screens. Colour options: Blue, Green, Grey or Pink.

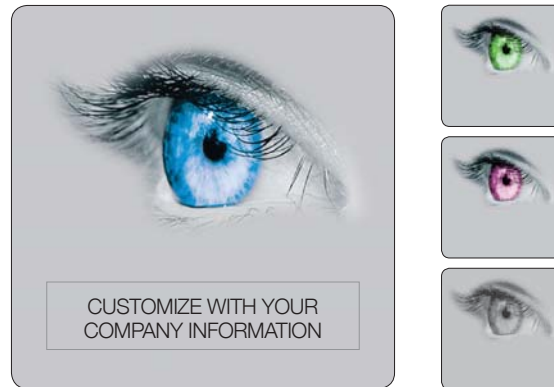

EYE-PATCH MOBILE, 1" X 1"

Customizable microfiber patch to advertise your business and clean mobile device screens.



STANDARD VERSION



CUSTOMIZE WITH YOUR COMPANY INFORMATION



MINI EYEGLASSES

Size 2.5" W x 1" H



OPTEGO READER

A completely clear and portable reader in **+2.75** power. Use alone or over current glasses and contact lenses. *Custom printing available.



SCARAB VISOR CLIP

*Custom printing available.



YOUR LOGO HERE



UNI READER

Light rimless unisex reader with polycarbonate frame front and slim temples. **+1.00, +1.25, +1.50, +1.75, +2.00, +2.50 & +3.00**



BOOKMARK MAGNIFIER W/CLIP

2.5x magnification, pocket size magnifier with a clip. Comes with a carrying case to prevent scratches. *Custom printing available.



VISOR CLIP

Clips onto the flip down visor in your car and opens to place the temples of your glasses inside. *Custom printing available.



ACCOUNT TERMS

A signed credit application is required for all accounts. Account payments are net 30 days from invoice date. Interest of 2% per month will be charged on all overdue accounts.

SHIPPING & HANDLING

Shipping & handling will apply to orders of \$100.00 net or less, special order items and all display items. Carriers will be assigned at the discretion of 20/20 Accessory Source Ltd. unless otherwise requested.

RETURNS

All products are returnable for a period of six months from invoice date due to manufacturer's defects. Products may be exchanged or credited during this period at the discretion of 20/20 Accessory Source Ltd. All returns must be accompanied by a valid RMA# (return number) and original packaging. To obtain an RMA#, please contact Customer Service. Returns without a valid RMA# may be subject to a 25% restocking fee. Personal misuse not covered.





T 604.465.3469 | 1.800.265.3937 | F 604.465.0164 | 1.888.497.3937
20165 113B Ave, Maple Ridge BC V2X 0Z1 | www.2020as.com