

VENETO OPEN

2023.05.19 - 2023.05.21

Via S. Marco, 53, 35129 Padova PD

ITALY,ITA





VENETO OPEN

ITALY

2023.05.19 - 2023.05.21

Via S. Marco, 53, 35129 Padova PD

Participation List (by Club/Team)

#	Code	Club	Male	Female	Total Entries	Total Athletes
1	 ITA	A. S. D. SCUOLA KARATE OMEGNA[6][5](SKO[5])	0	1	1	1
2	 ITA	A.S.D. Ren.Bu.Kan Forl(A.S.D. Ren.Bu.Kan Forl)	0	1	1	1
3	 ITA	A.D.P. CHAMPIONS(A.D.P. CHAMPIONS)	1	0	1	1
4	 ITA	A.S.D Ki-Oshi(ASD KIOSHI)	1	3	4	4
5	 ITA	A.S.D. BELFRAKARATE(BELFRAKARATE)	0	1	1	1
6	 ITA	A.S.D. ATLETIC CLUB[1](ATLETIC[1])	0	1	1	1
7	 ITA	A.S.D. Artesport(Artesport)	2	3	5	5
8	 ITA	A.S.D. Asi Karate Veneto[2](Asi Karate Veneto[2])	10	3	13	13
9	 ITA	A.S.D. Champion Center (Champion Center)	2	2	4	3
10	 ITA	A.S.D. DOJO KARATE WADORYU SPINEA(KARATE SPINEA)	2	3	5	4
11	 ITA	A.S.D. DYNAMIK REVOLUTION KARATE(DYNAMIK REVOLUTION KARATE)	0	1	1	1
12	 ITA	A.S.D. FAMILY FIGHT TEAM[1](FFT[1])	0	2	2	2
13	 ITA	A.S.D. FIGHTERS KARATE TEAM(FKT)	1	1	2	2
14	 ITA	A.S.D. Fuji-Yama Karate-Do Sette Comuni[1](F.Y.K.7C.[1])	4	5	9	9
15	 ITA	A.S.D. JISEI BUDO A.M.I.[1](ASD JISEI BUDO AMI)	1	1	2	2
16	 ITA	A.S.D. JOHNNYS KARATE BORGOSISA(JOHNNYS KARATE)	2	2	4	4
17	 ITA	A.S.D. KARATE WA YU KAI GIUSSANO(KARATE GIUSSANO)	0	1	1	1
18	 ITA	A.S.D. KARATESETTEVILLE(A.S.D.Karatesett eville)	14	2	16	13
19	 ITA	A.S.D. Kameju Karate-Do(Asd Kameju Karate)	0	5	5	3
20	 ITA	A.S.D. Lenea Team Sarnataro Karate(LENEA)	1	0	1	1
21	 ITA	A.S.D. METROPOLITAN KARATE BRINDISI[1](METROPOLITAN BRINDISI[1])	1	0	1	1
22	 ITA	A.S.D. Mantuano Karate Team[5](MKT[5])	1	0	1	1
23	 ITA	A.S.D. Master Fitness[3](Master Fitness[3])	4	0	4	4
24	 ITA	A.S.D. POLISPORTIVA TEVERE(12RM4246)	1	2	3	3
25	 ITA	A.S.D. SHIZOKU KARATE AVELLINO(SHIZOKU KRT AV)	6	6	12	12
26	 ITA	A.S.D. SHOTOKAN KARATE RYU VENEZIA(A.S.D. SKR VENEZIA)	7	10	17	16
27	 ITA	A.S.D. SPORT KARATE CURINGA(KRT CURINGA)	0	1	1	1
28	 ITA	A.S.D. Sen Shin Kai Rovigo(SSKR)	7	2	9	7





























VENETO OPEN

ITALY

2023.05.19 - 2023.05.21

Via S. Marco, 53, 35129 Padova PD

Participation List (by Club/Team)

29		ITA	A.S.D. TATAKAI KARATE TEAM(TATAKAI)	0	1	1	1
30		ITA	A.S.D. TIGER KARATE TEAM(TIGERKARATETEAM)	2	5	7	7
31		ITA	A.S.D.KARATE VENEZIA(KARATE VENEZIA)	2	1	3	3
32		ITA	A.S.DILETTANTISTICA EPOMEO ROMA(A.S.D. EPOMEO)	2	1	3	3
33		ITA	A.S.d. Millennium Karate[7](MK[7])	1	3	4	4
34		ITA	A.T. karate club Roma(A.T. karate club Roma)	5	1	6	6
35		ITA	A.s.d. Gymnasium karate sporting club(Gymnasium krt sporting)	1	1	2	2
36		ITA	ACADEMY PONTE DI PIAVE ASD(ASDK PDP)	1	0	1	1
37		ITA	ACCADEMIA KARATE UNION TEAM(AK[1])	2	3	5	4
38		ITA	ACCADEMIA TENRYU KARATE ASD(TENRYU KRT)	3	2	5	3
39		ITA	ACSD BUDO LACASSIA torino(BudoLacassia)	2	2	4	4
40		ITA	ACTIVITY CLUB SSD ARL[1](ACTIVITY CLUB SSD[1])	1	0	1	1
41		ITA	AI DAI CLUB VILLA ADRIANA(AI DAI CLUB)	2	0	2	2
42		ITA	AKS Firenze(AKS Firenze)	10	2	12	12
43		ITA	ASD ACCADEMIA KARATE AREZZO [6](AKA[6])	0	4	4	3
44		ITA	ASD CAM LUCCA(ASD CAM LUCCA)	0	7	7	7
45		ITA	ASD CENTRO SPORTIVO TEODORO MONTEPARANO[2](C.S TEODORO[2])	1	1	2	2
46		ITA	ASD CENTRO STUDI KARATE NEGRAR[1](ASD CSK NEGRAR[1])	1	3	4	4
47		ITA	ASD CINTURA NERA KARATE (CINTURA NERA K)	2	5	7	7
48		ITA	ASD CISTELLUM JUDO KARATE(ASD CISKARATE)	2	0	2	2
49		ITA	ASD CLUB FUNAKOSHI[5](FUNAKOSHI[5])	1	3	4	4
50		ITA	ASD CLUB KARATE SHOTOKAN(ASDCKS)	1	0	1	1
51		ITA	ASD CSK MASTER[2](ASD CSK MASTER[2])	1	0	1	1
52		ITA	ASD DEFENCE KARATE 2000 PRAVISDOMINI[1](Defence[1])	1	1	2	2
53		ITA	ASD DRAGON KARATE TEAM MODENA[1](DKT MODENA[1])	0	1	1	1
54		ITA	ASD DRAGON KARATE(DRAGON KARATE)	3	0	3	3
55		ITA	ASD EDERA KARATE FORLI(ASD EDERA)	1	0	1	1
56		ITA	ASD ESERCITO - 187 FOLGORE(ASD ESERCITO - 187 FOLGORE)	9	1	10	8
57		ITA	ASD ESERCITO - 3 RGT AVES AQUILA(ESERCITO AVES AQUILA)	7	9	16	16





























VENETO OPEN

ITALY

2023.05.19 - 2023.05.21

Via S. Marco, 53, 35129 Padova PD

Participation List (by Club/Team)

58		ITA	ASD FC MOREVILLA[1](Asd Morevilla[1][1])	9	1	10	10
59		ITA	ASD INTERNATIONAL PALADANZE[1](PALADANZE[1])	3	1	4	4
60		ITA	ASD KARATE 2001(K 01)	0	4	4	3
61		ITA	ASD KARATE CLUB VALDOBBIADENE CROCETTA(ASD KARATE VALDO)	2	5	7	7
62		ITA	ASD KARATE DO NOVENTA(ASD KARATE DO NOVENTA)	0	1	1	1
63		ITA	ASD KARATE SACILE(KARATE SACILE)	2	1	3	3
64		ITA	ASD KEN KO PIOBESI(ASD KEN KO PIOBESI)	1	0	1	1
65		ITA	ASD Karate Center Bologna[11](KCB[11])	3	0	3	3
66		ITA	ASD Karate Genocchio(KG1982)	4	6	10	10
67		ITA	ASD Karate club kanazawa[1](Kanazawa Cimadolmo[1][1])	2	2	4	4
68		ITA	ASD LIBERTAS CLUB LAVELLO(LCL)	1	1	2	2
69		ITA	ASD Leoni Karate Team(Leoni Karate Team)	5	3	8	7
70		ITA	ASD OKINAWA FIGHT(OKINAWA FIGHT ASD)	1	0	1	1
71		ITA	ASD Polisportiva Tre Pietre Firenze(TPK)	2	0	2	2
72		ITA	ASD REMBUKAN KARATE VILLASMUNDO[1](REMBUKAN VILLASMUNDO[1])	0	1	1	1
73		ITA	ASD RENSHUKAN TORINO(RENSHUKAN)	0	1	1	1
74		ITA	ASD SCUOLA KARATE MIGNAGOLA(KARATE MIGNAGOLA)	0	1	1	1
75		ITA	ASD SHOTOKAN ACIREALE[2](ACIREALE[2])	0	1	1	1
76		ITA	ASD SHOURI TEAM KARATE[5](STK[5])	1	0	1	1
77		ITA	ASD Shotokan Karate Pozzuolo del Friuli(SKZP)	2	1	3	3
78		ITA	ASD TALARICO KARATE TEAM APS(TKT[1])	24	23	47	45
79		ITA	ASD Tiger s Style Team Iodice(ASD TS)	4	2	6	6
80		ITA	ASD VIP CENTER MOTTA(VIP CENTER MOTTA)	1	0	1	1
81		ITA	ASD YAMAGUCHI[1](YAM[1])	2	1	3	3
82		ITA	ASD karate Benaco(ASD karate Benaco)	0	2	2	2
83		ITA	ASSOCIAZIONE SPORTIVA DILETTANTISTICA LEONE[1](A.S.D.LEONE[1])	1	2	3	3
84		ITA	ASSOCIAZIONE SPORTIVA DILETTANTISTICA SHU REN KAN(A.S.D. SHU REN KAN)	2	0	2	2
85		ITA	Accademia Karate Montevarchi A.S.D.(Acc. Karate Montevarchi)	3	2	5	5

VENETO OPEN

ITALY

2023.05.19 - 2023.05.21

Via S. Marco, 53, 35129 Padova PD

Participation List (by Club/Team)

86		ITA	Arte Del Movimento Rovigo(Arte Del Movimento)	2	0	2	2
87		ITA	Asd Bushinkai(Bushinkai)	2	0	2	2
88		ITA	Asd Fenice Karate Team[2](FKT[2])	0	4	4	3
89		ITA	Asd Foligno,Karate Club,(FolignoKarate)	6	0	6	6
90		ITA	Asd Ryuko(Asd Ryuko)	1	1	2	2
91		ITA	Asd Samurai Ryu Vallecamonica(Samurai Ryu)	0	2	2	2
92		ITA	Asd Shingitai Pisa[1](Shingitai Pisa[1])	5	0	5	5
93		ITA	Asd kb center 2000[1](Kb center 2000[1])	2	2	4	4
94		ITA	Asd_Dinamo_Karate_2015(Dinamo Karate 2015)	1	0	1	1
95		ITA	Ass. Centro Sportivo Sakura[12](Sakura Vicenza)	2	1	3	3
96		ITA	Atlas Karate(AK[11])	2	4	6	5
97		ITA	BERRETTONI[3](BERRETTONI[3])	0	3	3	2
98		ITA	BUDOKAN MONTELUPO[1](BDKMNT)	0	1	1	1
99		ITA	Bodymind Karate[2](Bodymind Karate[2])	7	1	8	8
100		ITA	Budokan Portuali(BDK PRT)	1	0	1	1
101		ITA	CENTRO KARATE RICCIONE 1(CKR 1)	1	1	2	2
102		ITA	CENTRO KARATE RIMINI[3](CKR[3])	1	0	1	1
103		ITA	CENTRO RICERCHE SPORT KARATE(CRSK)	1	0	1	1
104		ITA	CENTRO YOSHITAKA (CENTRO YOSHITAKA)	4	2	6	5
105		ITA	CKS KARATE CERTALDO[1](CKS[1])	0	1	1	1
106		ITA	CLUB ARTI ORIENTALI CANTU asd(CAO CANTU)	1	3	4	4
107		ITA	CRS AKIYAMA Settimo(CRS AKIYAMA Settimo)	2	0	2	2
108		ITA	CSCARABINIERI[2](CSCARABINIERI[2] [3][2])	1	0	1	1
109		ITA	CSKT KARATE TEAM(C.S.K.T. JGOR CARTA)	0	3	3	3
110		ITA	Centro Karate Riccione [1](CKR ITALY [1])	2	15	17	14
111		ITA	Cesanelli(Cesanelli)	0	1	1	1
112		ITA	DYNAMIC KARATE ASD(DK ASD)	2	0	2	1
113		ITA	EAGLES CLUB 2007(EAG)	1	0	1	1
114		ITA	Energia in movimento SSD ARL(Energia in movimento PESCARA)	0	1	1	1
115		ITA	Etruria karate(E.K)	0	2	2	1
116		ITA	FIGHT CLUB [2](FCK[2])	2	0	2	2
117		ITA	FORZA E COSTANZA - BRESCIA(F & C)	2	7	9	9
118		ITA	FUNAKOSHI 1976 asd[1](funakoshi CANDELO[1])	6	0	6	6
119		ITA	Funakoshi Milano(Funakoshi Milano)	1	0	1	1
120		ITA	G.S.FF.OO. POLIZIA DI STATO(FF.OO. POLIZIA DI STATO)	24	13	37	31
121		ITA	G.S.FIAMME CREMISI BERSAGLIERI FOGGIA(Fiamme Cremisi Bersaglieri)	4	2	6	6











VENETO OPEN

ITALY

2023.05.19 - 2023.05.21

Via S. Marco, 53, 35129 Padova PD

Participation List (by Club/Team)

122		ITA	Gin. Angel Fiumicino(Gin. Angel)	0	4	4	2
123		ITA	Golden Tiger Team Karate - Muay Thai(GTTK)	3	1	4	4
124		ITA	Istituto Karate Shotokan Sondrio(IKS Sondrio)	0	2	2	2
125		ITA	JKS CASTANO PRIMO[7](JKS[7])	4	2	6	3
126		ITA	KAIGI KARATE FITNESS A.S.D.(KAIGI KARATE)	1	2	3	3
127		ITA	KARATE BORBIAGO VE(KRT BORBIAGO)	1	0	1	1
128		ITA	KARATE CAMUNO CHINTE[8][21](KCC[21])	2	0	2	2
129		ITA	KARATE CLUB SAVONA (KCS - LIGURIA KARATE)	13	11	24	24
130		ITA	KARATE POZZUOLO[4](KARATE POZZUOLO[4])	7	4	11	10
131		ITA	KARATE SANSEPOLCRO(KARATE SANSEPOLCRO)	5	1	6	6
132		ITA	Karate Alto Vicentino (K. A. V.)	3	2	5	5
133		ITA	Karate Baldassarre(Baldassarre)	6	2	8	8
134		ITA	Karate Doschi Ass.ne sportiva dilettantistica(Karate Doschi A.S.D.)	0	1	1	1
135		ITA	Karate Nakayama[1](Karate Nakayama[1])	7	8	15	15
136		ITA	Karate Polisportiva Brembate Sopra[1](KBS[1])	3	2	5	4
137		ITA	Karate Sporting Team[5](KSTKST)	2	1	3	3
138		ITA	Karate Team Dolomiti[1](KTDolomiti[1])	0	1	1	1
139		ITA	Kyohan Simmi(Kyohan)	3	0	3	2
140		ITA	LIFE CHAMPION MADDALONI(L.C.M)	2	0	2	2
141		ITA	LIGURIA_KARATE_FUNAKOSHI_LA SPEZIA(LIG_KA_FUN_SP)	2	7	9	9
142		ITA	Luciano Baderna(Shinanban K.)	2	3	5	5
143		ITA	MASTER RAPID SKF CBL(MASTER RAPID SKF CBL)	26	31	57	41
144		ITA	Mens Sana Siena(Mens Sana)	2	4	6	6
145		ITA	NADIR TRATTI D ORIENTE SSD[1](NADIR[1])	6	1	7	7
146		ITA	NEW SPORTING CLUB CAVARZERE A.S.D.(NEW SPORTING CLUB)	1	1	2	2
147		ITA	Napoli[1](Napoli[1])	0	1	1	1
148		ITA	Olimpia Karate Bergamo asd(Olimpia Bergamo)	4	4	8	8
149		ITA	PRO-TEAM ASD(PRO-TEAM ASD)	0	1	1	1
150		ITA	Polihandy ASD[1](Polihandy[1])	1	2	3	3
151		ITA	Polisportiva Karate Mogliano(PKM)	2	2	4	4
152		ITA	Polisportiva Sassarese(Pol. Sassarese)	1	0	1	1
153		ITA	Pro Recco karate asd(Pro Recco[1])	0	2	2	2
154		ITA	S.S.DILETTANTISTICA C.K.S. 2000(20SR1832)	0	1	1	1
155		ITA	SHIRAI CLUB S. VALENTINO(SHIRAI CLUB S. VALENTINO)	7	2	9	9
156		ITA	SPORT TARGET (SPORT TARGET)	16	11	27	22
157		ITA	SSD Polisportiva Ternana(karateterni)	4	0	4	2



































VENETO OPEN

ITALY

2023.05.19 - 2023.05.21

Via S. Marco, 53, 35129 Padova PD

Participation List (by Club/Team)

158		ITA	Spazio Sport Forte dei Marmi(Spazio Sport)	2	3	5	5
159		ITA	TEAM KARATE LENTINI(TEAMKARATELENTINI)	5	4	9	9
160		ITA	TSKS BELLUNO(TSKS)	13	4	17	17
161		ITA	Team Karate Puleo Firenze(TKP)	9	5	14	12
162		ITA	UNIVERSAL CENTER[1](UC[1])	12	6	18	16
163		ITA	UNIVERSAL TEAM - CSO ARCOBALENO(UNIVERSAL TEAM)	6	2	8	8
164		ITA	WMAC italia (WMACIT)	1	0	1	1
165		ITA	YOSEIKAN KARATE OPEN WKF[2](YOSEIKAN KARATE[2])	3	0	3	3
166		ITA	a.s.d sen shin kai padova(sen shin kai pd)	9	2	11	11
167		ITA	a.s.d. Dojo Taka Tora[1](Dojo Taka Tora[1])	2	1	3	3
168		ITA	a.s.d. Nenrjukan karate(nenrjukan)	3	3	6	5
169		ITA	a.s.d. karate roma(a.s.d. karate roma)	1	0	1	1
170		ITA	accademia karate casentino[8](AKC[8])	0	1	1	1
171		ITA	asd karate ninja club[1][1](knc[1][1])	0	3	3	2
172		ITA	asd APAM[2](APAM[2])	0	1	1	1
173		ITA	asd CENTRO KARATE SPORTIVO[1](asd CKS[1])	0	5	5	5
174		ITA	asd KARATE TEAM 1999(KARATE TEAM 1999)	6	4	10	10
175		ITA	asd Treviso Karate[3](Treviso Karate[3])	1	0	1	1
176		ITA	asd athletic karate do azzano x(atlkarazzx)	2	0	2	2
177		ITA	asd judo karate club(asd jk club)	1	2	3	3
178		ITA	asd karate camaiore(karate camaiore fijlkam)	2	3	5	5
179		ITA	asd le arti new school dojo shotokan roma est[1](le arti new school[1])	4	3	7	7
180		ITA	asd nippon club napoli karate[1](nipponkarate[1])	1	1	2	2
181		ITA	ass.naz.carab. capasso1(ass.naz.carab. capasso1)	1	2	3	3
182		ITA	centro sportivo farnesiana karate piacenza(karate piacenza)	0	3	3	3
183		ITA	centro sportivo karate wado ryu roma[1](cskw roma[1])	1	3	4	4
184		ITA	karate colli euganei[7](kce[7])	2	1	3	3
185		ITA	karate lion (karate lion)	2	0	2	2
186		ITA	karate trento asd(ktn)	2	3	5	5
187		ITA	skorpion karate asd(skorpion karate asd)	0	3	3	3
188		ITA	sport center messina[1](sc messina[1])	2	0	2	2
189		ITA	ssd bracelli club[1](ssd bracelli club[1])	2	0	2	2
190		ITA	tora-do karate team a.s.d.(Tora-do italy)	3	2	5	5
191		SLO	PORTNO DRUTVO GORICA[1](D GORICA[1])	2	1	3	3
Totals:				529	436	965	893



VENETO OPEN

ITALY

2023.05.19 - 2023.05.21

Via S. Marco, 53, 35129 Padova PD

Tournament Participation (Entries) by Club

 ITALY					
 A. S. D. SCUOLA KARATE OMEGNA(SKO)					
ID	Sex	Family Name	Given Name	Category	
1	Female	Rigoni	Clelia	Kata Individual female U21 R2-G1	
2	Female	Rigoni	Clelia	Kata Individual female U21	
3	Female	Rigoni	Clelia	Kata Individual female U21 R3 Bronze Medal Match 2	

Entries: 3

VENETO OPEN

ITALY

2023.05.19 - 2023.05.21

Via S. Marco, 53, 35129 Padova PD

Tournament Participation (Entries) by Club

A.S.D. Ren.Bu.Kan Forl(A.S.D. Ren.Bu.Kan Forl)					
ID	Sex	Family Name	Given Name	Category	
4	Female	Bondi	Evita	Kata Individual female Juniors	

Entries: 1

VENETO OPEN

ITALY

2023.05.19 - 2023.05.21

Via S. Marco, 53, 35129 Padova PD

Tournament Participation (Entries) by Club



A.D.P. CHAMPIONS(A.D.P. CHAMPIONS)

ID	Sex	Family Name	Given Name	Category	
5	SD61524	Male	Daidone	Filippo	Kumite Individual male Juniors -55

Entries: 1

VENETO OPEN

ITALY

2023.05.19 - 2023.05.21

Via S. Marco, 53, 35129 Padova PD

Tournament Participation (Entries) by Club

 A.S.D Ki-Oshi(ASD KIOSHI)					
ID	Sex	Family Name	Given Name	Category	
6	Female	Aiello	Lucrezia	Kumite Individual female U14 -42	
7	Female	Aquino	Eleonora	Kumite Individual female U14 -52	
8	Female	Longo	Valentina	Kumite Individual female U14 -42	
9	Male	Sultafa	Kevin	Kumite Individual male U14 -55	

Entries: 4

VENETO OPEN

ITALY

2023.05.19 - 2023.05.21

Via S. Marco, 53, 35129 Padova PD

Tournament Participation (Entries) by Club

a.s.d sen shin kai padova(sen shin kai pd)					
ID	Sex	Family Name	Given Name	Category	
10	Female	Favarato	Matilde	Kumite Individual female Juniors -59	
11	Male	Lazzaretti	Leonardo	Kumite Individual male U21 -84	
12	Male	Lazzaretti	Tommaso	Kumite Individual male Juniors -68	
13	Male	Lovise	Riccardo	Kumite Individual male U14 -55	
14	Male	Marigo	Giovanni	Kumite Individual male U14 -55	
15	Female	Nicol	Beatrice	Kumite Individual female Juniors -59	
16	Male	Nicol	Carlo	Kumite Individual male U14 -55	
17	Male	Niedda	Antonio	Kumite Individual male U14 -40	
18	Male	Pendini	Tommaso	Kumite Individual male Juniors -68	
19	Male	Soranzo	Thomas	Kumite Individual male U21 -75	
20	Male	TOSATTO	ALESSANDRO	Kumite Individual male U14 -40	

Entries: 11

VENETO OPEN

ITALY

2023.05.19 - 2023.05.21

Via S. Marco, 53, 35129 Padova PD

Tournament Participation (Entries) by Club



A.S.D. BELFRAKARATE(BELFRAKARATE)

ID	Sex	Family Name	Given Name	Category
21	Female	Sala	Carlotta	Kumite Individual female Juniors -48

Entries: 1

VENETO OPEN

ITALY

2023.05.19 - 2023.05.21

Via S. Marco, 53, 35129 Padova PD

Tournament Participation (Entries) by Club

 A.S.D. Artesport(Artesport)					
ID	Sex	Family Name	Given Name	Category	
22	Female	Crucitti	Francesca	Kata Individual female Juniors	
23	Female	Crucitti	Francesca	Kata Individual female Juniors R2-G2	
24	Female	Crucitti	Sofia	Kata Individual female U14 R3 Gold Medal Match	
25	Female	Crucitti	Sofia	Kata Individual female U14 R2-G1	
26	Female	Crucitti	Sofia	Kata Individual female U14	
27	Male	Ollagnero	Giovanni Sebastian	Kata Individual male Cadets	
28	Male	Ollagnero	Giovanni Sebastian	Kata Individual male Cadets R2-G2	
29	Male	Paschetto	Federico	Kumite Individual male Cadets -63	
30	Female	Zoccola	Lisa	Kata Individual female U14	

Entries: **9**

VENETO OPEN

ITALY

2023.05.19 - 2023.05.21

Via S. Marco, 53, 35129 Padova PD

Tournament Participation (Entries) by Club

 A.S.D. Asi Karate Veneto(Asi Karate Veneto)					
ID	Sex	Family Name	Given Name	Category	
31	Male	Barban	Francesco	Kumite Individual male Juniors -76	
32	Female	Barbiero	Andrea Lory	Kumite Individual female U14 +52	
33	Male	Basso	Marco	Kumite Individual male Cadets -57	
34	Male	Bon	Edoardo	Kumite Individual male U14 -40	
35	Female	Bon	Greta	Kumite Individual female U14 +52	
36	Male	Contin	leonardo	Kumite Individual male Cadets -63	
37	Male	Gesuato	Riccardo	Kumite Individual male U14 +55	
38	Male	Guerriero	Nicola	Kumite Individual male Juniors +76	
39	Male	Perin	Luca	Kumite Individual male Juniors -68	
40	Male	Pravato	Alessandro	Kumite Individual male U14 -40	
41	Female	Reale	Francesca	Kata Individual female Sen R2-G1	
42	Female	Reale	Francesca	Kata Individual female Sen	
43	Female	Reale	Francesca	Kata Individual female Sen R3-G1	
44	Female	Reale	Francesca	Kata Individual female Sen R4 Gold Medal Match	
45	Male	Volpato	Christian	Kumite Individual male Cadets -57	
46	Male	Volpato	Pietro	Kumite Individual male Cadets -70	

Entries: **16**

VENETO OPEN

ITALY

2023.05.19 - 2023.05.21

Via S. Marco, 53, 35129 Padova PD

Tournament Participation (Entries) by Club

 A.S.D. ATLETIC CLUB(ATLETIC)					
ID	Sex	Family Name	Given Name	Category	
47	Female	Mariani	Stella	Kumite Individual female U14 +52	

Entries: 1

VENETO OPEN

ITALY

2023.05.19 - 2023.05.21

Via S. Marco, 53, 35129 Padova PD

Tournament Participation (Entries) by Club

 A.S.D. Champion Center (Champion Center)					
ID	Sex	Family Name	Given Name	Category	
48	Female	ANSELMI	CHIARA	Kumite Individual female Cadets -61	
49	Female	Bifulco	Asia	Kumite Individual female Juniors -48	
50	Male	Varriale	Luca	Kumite Individual male U21 -67	
51	Male	Varriale	Luca	Kumite Individual male Seniors -67	

Entries: 4

VENETO OPEN

ITALY

2023.05.19 - 2023.05.21

Via S. Marco, 53, 35129 Padova PD

Tournament Participation (Entries) by Club

 A.S.D. DOJO KARATE WADORYU SPINEA(KARATE SPINEA)					
ID	Sex	Family Name	Given Name	Category	
52	Female	Antonello	Victoria	Kumite Individual female Cadets +61	
53	Female	Bernacchia	Giorgia	Kumite Individual female U14 +52	
54	Female	MASSARO	ALESSIA	Kumite Individual female U14 +52	
55	Male	Rosciglioni	Jonathan	Kumite Individual male U21 +84	
56	Male	Rosciglioni	Jonathan	Kumite Individual male Seniors +84	

Entries: 5

VENETO OPEN

ITALY

2023.05.19 - 2023.05.21

Via S. Marco, 53, 35129 Padova PD

Tournament Participation (Entries) by Club

 a.s.d. Dojo Taka Tora(Dojo Taka Tora)					
ID	Sex	Family Name	Given Name	Category	
57	Male	Di Bari	Daniel Antonio	Kumite Individual male Cadets -63	
58	Male	Gernone	Lorenzo	Kumite Individual male Juniors -68	
59	Female	MININNI	MIKOL	Kumite Individual female Juniors -59	

Entries: 3

VENETO OPEN

ITALY

2023.05.19 - 2023.05.21

Via S. Marco, 53, 35129 Padova PD

Tournament Participation (Entries) by Club

A.S.D. DYNAMIK REVOLUTION KARATE(DYNAMIK REVOLUTION KARATE)					
ID	Sex	Family Name	Given Name	Category	
60	Female	Gulizia	Bianca Anna	Kata Individual female Juniors	

Entries: 1

VENETO OPEN

ITALY

2023.05.19 - 2023.05.21

Via S. Marco, 53, 35129 Padova PD

Tournament Participation (Entries) by Club

 A.S.D. FAMILY FIGHT TEAM(FFT)					
ID	Sex	Family Name	Given Name	Category	
61	Female	Stroschio	Melissa	Kumite Individual female Juniors -66	
62	Female	VARONE	MARTINA	Kumite Individual female Juniors +66	

Entries: 2

VENETO OPEN

ITALY

2023.05.19 - 2023.05.21

Via S. Marco, 53, 35129 Padova PD

Tournament Participation (Entries) by Club

A.S.D. FIGHTERS KARATE TEAM(FKT)					
ID	Sex	Family Name	Given Name	Category	
63	Female	CERATO	GIORGIA	Kata Individual female Cadets	
64	Male	GAVRILESCU	EDUARD	Kumite Individual male U14 -55	

Entries: 2

VENETO OPEN

ITALY

2023.05.19 - 2023.05.21

Via S. Marco, 53, 35129 Padova PD

Tournament Participation (Entries) by Club

 A.S.D. Fuji-Yama Karate-Do Sette Comuni(F.Y.K.7C.)					
ID	Sex	Family Name	Given Name	Category	
65	Male	ARDUINI	RICCARDO	Kumite Individual male Cadets -70	
66	Female	ARDUINI	SOFIA	Kumite Individual female U14 +52	
67	Female	Franchi	Samantha	Kumite Individual female Cadets -61	
68	Male	PASQUALETTO CASSINIS	FRANCESCO	Kumite Individual male Cadets +70	
69	Female	PASSUELLO	CATERINA	Kumite Individual female U14 +52	
70	Female	Pertrile	Marta	Kumite Individual female Juniors -66	
71	Female	POZZA	MARTA	Kumite Individual female U14 -42	
72	Male	Rizzotto	Alessio	Kumite Individual male U21 -75	
73	Male	Tessari	Leonardo	Kumite Individual male U14 -50	

Entries: 9

VENETO OPEN

ITALY

2023.05.19 - 2023.05.21

Via S. Marco, 53, 35129 Padova PD

Tournament Participation (Entries) by Club

 A.s.d. Gymnasium karate sporting club(Gymnasium krt sporting)					
ID	Sex	Family Name	Given Name	Category	
74	Male	Garcia	Richmond Kyle	Kumite Individual male Cadets -52	
75	Female	Villari	Sofia	Kumite Individual female Juniors -48	

Entries: 2

VENETO OPEN

ITALY

2023.05.19 - 2023.05.21

Via S. Marco, 53, 35129 Padova PD

Tournament Participation (Entries) by Club

 A.S.D. JISEI BUDO A.M.I.(ASD JISEI BUDO AMI)					
ID	Sex	Family Name	Given Name	Category	
76	Male	CUPCEA	NIKITA	Kumite Individual male U14 -55	
77	Female	TODESCO	LETIZIA	Kumite Individual female U14 -47	

Entries: 2

VENETO OPEN

ITALY

2023.05.19 - 2023.05.21

Via S. Marco, 53, 35129 Padova PD

Tournament Participation (Entries) by Club

 A.S.D. JOHNNYS KARATE BORGO SISA(JOHNYS KARATE)					
ID	Sex	Family Name	Given Name	Category	
78	Female	CHIAPPARELLI	GIADA	Kumite Individual female Cadets -47	
79	Male	FOSCHI	SEBASTIAN	Kumite Individual male Juniors -55	
80	Female	LEONI	ADELE	Kumite Individual female Cadets -54	
81	Male	PINTO	ALESSIO	Kata Individual male Cadets	

Entries: 4

VENETO OPEN

ITALY

2023.05.19 - 2023.05.21

Via S. Marco, 53, 35129 Padova PD

Tournament Participation (Entries) by Club

 A.S.D. Kameju Karate-Do(Asd Kameju Karate)					
ID	Sex	Family Name	Given Name	Category	
82	Female	Gaudenzi	Cecilia	Kata Individual female Cadets	
83	Female	Gaudenzi	Eleonora	Kata Individual female Sen	
84	Female	Gaudenzi	Eleonora	Kata Individual female U21	
85	Female	Solotchi	Tania	Kata Individual female Sen	
86	Female	Solotchi	Tania	Kata Individual female U21	

Entries: 5

VENETO OPEN

ITALY

2023.05.19 - 2023.05.21

Via S. Marco, 53, 35129 Padova PD

Tournament Participation (Entries) by Club

 a.s.d. karate roma(a.s.d. karate roma)					
ID	Sex	Family Name	Given Name	Category	
87	Male	caponera	emanuele	Kata Individual male Cadets R2-G1	
88	Male	caponera	emanuele	Kata Individual male Cadets R4 Bronze Medal Match 2	
89	Male	caponera	emanuele	Kata Individual male Cadets	
90	Male	caponera	emanuele	Kata Individual male Cadets R3-G1	

Entries: 4

VENETO OPEN

ITALY

2023.05.19 - 2023.05.21

Via S. Marco, 53, 35129 Padova PD

Tournament Participation (Entries) by Club

 A.S.D. KARATE WA YU KAI GIUSSANO(KARATE GIUSSANO)					
ID	Sex	Family Name	Given Name	Category	
91	Female	BALLABIO	DELIA	Kumite Individual female U14 +52	

Entries: 1

VENETO OPEN

ITALY

2023.05.19 - 2023.05.21

Via S. Marco, 53, 35129 Padova PD

Tournament Participation (Entries) by Club

 A.S.D. KARATESETTEVILLE(A.S.D.Karatesetteville)					
ID	Sex	Family Name	Given Name	Category	
92	Male	Amici	Matteo	Kumite Individual male U14 -40	
93	Male	Berlingiero	Jacopo Bruno	Kata Individual male Sen	
94	Male	Berlingiero	Jacopo Bruno	Kata Individual male U21 R2-G2	
95	Male	Berlingiero	Jacopo Bruno	Kata Individual male U21	
96	Male	Berlingiero	Jacopo Bruno	Kata Individual male U21 R3 Bronze Medal Match 1	
97	Male	Berlingiero	Jacopo Bruno	Kata Individual male Sen R2-G1	
98	Male	Botanici	Luca	Kata Individual male U21	
99	Male	Botanici	Luca	Kata Individual male Sen	
100	Male	Cherchi	Nicol	Kumite Individual male U21 -75	
101	Male	Cicchetti	Lorenzo	Kata Individual male Sen R2-G2	
102	Male	Cicchetti	Lorenzo	Kata Individual male Sen	
103	Male	Fuscagni	Alex	Kata Individual male Juniors R3-G1	
104	Male	Fuscagni	Alex	Kata Individual male Juniors R2-G1	
105	Male	Fuscagni	Alex	Kata Individual male Juniors	
106	Male	GAGLIO	Andrea	Kata Individual male U21	
107	Male	GAGLIO	Andrea	Kata Individual male Sen R3-G1	
108	Male	GAGLIO	Andrea	Kata Individual male Sen R2-G1	
109	Male	GAGLIO	Andrea	Kata Individual male U21 R3 Bronze Medal Match 2	
110	Male	GAGLIO	Andrea	Kata Individual male Sen	
111	Male	GAGLIO	Andrea	Kata Individual male U21 R2-G1	
112	Male	Giovagnoni	Gioele	Kata Individual male Juniors	
113	Female	Istrate	Daria	Kumite Individual female U14 +52	
114	Male	Lattanzi	Cristian	Kata Individual male U14	
115	Male	Lattanzi	Cristian	Kata Individual male U14 R2-G2	
116	Female	Salvati	Erica	Kata Individual female Sen R2-G1	
117	Female	Salvati	Erica	Kata Individual female Sen	
118	Male	Scala	Francesco	Kumite Individual male U14 +55	
119	Male	Zhou	Marco	Kata Individual male Cadets R4 Bronze Medal Match 1	
120	Male	Zhou	Marco	Kata Individual male Cadets	
121	Male	Zhou	Marco	Kata Individual male Cadets R3-G1	
122	Male	Zhou	Marco	Kata Individual male Cadets R2-G1	

Entries: 31

VENETO OPEN

ITALY

2023.05.19 - 2023.05.21

Via S. Marco, 53, 35129 Padova PD

Tournament Participation (Entries) by Club



A.S.D. Lenea Team Sarnataro Karate(LENEA)

ID	Sex	Family Name	Given Name	Category
123	Male	Popovich	Victorio	Kumite Individual male Juniors +76

Entries: 1

VENETO OPEN

ITALY

2023.05.19 - 2023.05.21

Via S. Marco, 53, 35129 Padova PD

Tournament Participation (Entries) by Club

A.S.D. Mantuano Karate Team(MKT)					
ID	Sex	Family Name	Given Name	Category	
124	Male	Guzzetti	Riccardo	Kata Individual male U14	

Entries: 1

VENETO OPEN

ITALY

2023.05.19 - 2023.05.21

Via S. Marco, 53, 35129 Padova PD

Tournament Participation (Entries) by Club

 A.S.D. Master Fitness(Master Fitness)					
ID	Sex	Family Name	Given Name	Category	
125	Male	Alekesej	Santinacci	Kumite Individual male Cadets -70	
126	Male	Burali	Davide	Kata Individual male Cadets	
127	Male	TOMA	GESON	Kumite Individual male Cadets +70	
128	0587579	Male	TOMA	GIOELE	Kumite Individual male U21 -84

Entries: 4

VENETO OPEN

ITALY

2023.05.19 - 2023.05.21

Via S. Marco, 53, 35129 Padova PD

Tournament Participation (Entries) by Club

 A.S.D. METROPOLITAN KARATE BRINDISI(METROPOLITAN BRINDISI)					
ID	Sex	Family Name	Given Name	Category	
129	Male	SERGI	FRANCESCO	Kata Individual male Juniors	
130	Male	SERGI	FRANCESCO	Kata Individual male Juniors R2-G1	

Entries: 2

VENETO OPEN

ITALY

2023.05.19 - 2023.05.21

Via S. Marco, 53, 35129 Padova PD

Tournament Participation (Entries) by Club

 A.S.d. Millennium Karate(MK)					
ID	Sex	Family Name	Given Name	Category	
131	Female	Disar	Ginevra	Kumite Individual female U14 +52	
132	Female	Giraldi	Francesca	Kumite Individual female Juniors -53	
133	Female	Giraldi	Laura	Kumite Individual female U14 -52	
134	Male	Mura	Matteo	Kumite Individual male U14 -45	

Entries: 4

VENETO OPEN

ITALY

2023.05.19 - 2023.05.21

Via S. Marco, 53, 35129 Padova PD

Tournament Participation (Entries) by Club

 a.s.d. Nenrjukan karate(nenrjukan)					
ID	Sex	Family Name	Given Name	Category	
135	Female	ALEGRE LAMARQUE	MAIA	Kata Individual female U21	
136	Female	DALLE FUSINE	ANNA	Kata Individual female Juniors	
137	Male	Muhlich	Thomas	Kumite Individual male Juniors -61	
138	Male	NANNI	GIACOMO	Kata Individual male Sen	
139	Male	NANNI	GIACOMO	Kata Individual male U21	
140	Female	SCABIN	FRANCESCA	Kata Individual female Sen	

Entries: 6

VENETO OPEN

ITALY

2023.05.19 - 2023.05.21

Via S. Marco, 53, 35129 Padova PD

Tournament Participation (Entries) by Club

 A.S.D. POLISPORTIVA TEVERE(12RM4246)					
ID	Sex	Family Name	Given Name	Category	
141	Female	DE GREGORIO	GABRIELLA	Kata Individual female Juniors R2-G2	
142	Female	DE GREGORIO	GABRIELLA	Kata Individual female Juniors	
143	Male	LUCIANI	DAVIDE	Kumite Individual male U21 -84	
144	Female	LUCIANI	SIRIA	Kumite Individual female Cadets -54	

Entries: 4

VENETO OPEN

ITALY

2023.05.19 - 2023.05.21

Via S. Marco, 53, 35129 Padova PD

Tournament Participation (Entries) by Club

 A.S.D. Sen Shin Kai Rovigo(SSKR)					
ID	Sex	Family Name	Given Name	Category	
145	Male	Albertin	Lorenzo	Kata Individual male Juniors	
146	Male	Albertin	Lorenzo	Kata Individual male Juniors R2-G2	
147	Male	Albertin	Lorenzo	Kata Individual male Juniors R3-G2	
148	Male	Bicos	Nikita	Kata Individual male Cadets R4 Bronze Medal Match 2	
149	Male	Bicos	Nikita	Kata Individual male Cadets	
150	Male	Bicos	Nikita	Kata Individual male Cadets R3-G2	
151	Male	Bicos	Nikita	Kata Individual male Cadets R2-G2	
152	Female	Buoso	Chiara	Kata Individual female Juniors	
153	Female	Cappellato	Maria	Kata Individual female U21	
154	Male	Manfio	Andrea	Kata Individual male Sen R2-G2	
155	Male	Manfio	Andrea	Kata Individual male Sen	
156	Male	Manfio	Andrea	Kata Individual male U21	
157	Male	Varva	Alessandro	Kata Individual male Cadets	
158	Male	Zanirato	Francesco	Kata Individual male Juniors	
159	Male	Zanirato	Francesco	Kata Individual male Sen	

Entries: **15**

VENETO OPEN

ITALY

2023.05.19 - 2023.05.21

Via S. Marco, 53, 35129 Padova PD

Tournament Participation (Entries) by Club

 A.S.D. SHIZOKU KARATE AVELLINO(SHIZOKU KRT AV)					
ID	Sex	Family Name	Given Name	Category	
160	Female	Andreottola	Laura	Kumite Individual female Juniors -48	
161	Female	Avitabile	Michela	Kumite Individual female Cadets -61	
162	Male	Branchi	Niccol	Kumite Individual male Cadets -70	
163	Female	Capone	Bianca	Kumite Individual female Cadets -54	
164	Male	De Stefano	Emanuele	Kumite Individual male Cadets -57	
165	Male	Loffredo	Francesco	Kumite Individual male Juniors -68	
166	Female	Mangiapia	Marianna	Kumite Individual female U14 +52	
167	Male	Pagano	Emilio	Kumite Individual male U14 -55	
168	Male	Rossano	Antonio Claudio	Kumite Individual male U14 -50	
169	Female	Rossano	Federica Carmela	Kumite Individual female U14 -52	
170	Male	Todesca	Alfonso	Kumite Individual male U14 -40	
171	Female	Todesca	Carmen	Kumite Individual female U14 -42	

Entries: **12**

VENETO OPEN

ITALY

2023.05.19 - 2023.05.21

Via S. Marco, 53, 35129 Padova PD

Tournament Participation (Entries) by Club

 A.S.D. SHOTOKAN KARATE RYU VENEZIA(A.S.D. SKR VENEZIA)					
ID	Sex	Family Name	Given Name	Category	
172	Male	BERGANTINO	DAVIDE	Kumite Individual male U14 -40	
173	Female	BERTON	EMMA	Kumite Individual female Cadets -61	
174	Male	Bressanello	RICCARDO	Kumite Individual male U21 -84	
175	Female	BROSSA	SARA	Kumite Individual female U21 -50	
176	Female	CANCIAN	ASIA	Kumite Individual female Cadets +61	
177	Female	DAL MISTRO	ANNIKA	Kumite Individual female Juniors -59	
178	Female	De Gregori	Chiara	Kumite Individual female U21 +68	
179	Female	De Gregori	Chiara	Kumite Individual female Seniors +68	
180	Male	De Gregori	Mattia	Kumite Individual male Juniors -76	
181	Female	Doria	Beatrice	Kumite Individual female U14 +52	
182	Male	DORIA	MATTEO	Kumite Individual male Cadets -63	
183	Male	GAGGIO	NICOL	Kumite Individual male U21 +84	
184	Female	MILLIACCIO	VERONICA	Kumite Individual female Juniors +66	
185	Male	PAGAN	FILIPPO	Kumite Individual male U21 -75	
186	Female	SEPTELICI	MIRIAM	Kumite Individual female U14 +52	
187	Male	Teodoro	Gabriele	Kumite Individual male Cadets -63	
188	Female	ULINICI	NICOLETA	Kumite Individual female U14 +52	

Entries: 17

VENETO OPEN

ITALY

2023.05.19 - 2023.05.21

Via S. Marco, 53, 35129 Padova PD

Tournament Participation (Entries) by Club



A.S.D. SPORT KARATE CURINGA(KRT CURINGA)

ID	Sex	Family Name	Given Name	Category	
189	SD749997	Female	DE PACE	Maria Luisa	Kata Individual female Cadets

Entries: 1

VENETO OPEN

ITALY

2023.05.19 - 2023.05.21

Via S. Marco, 53, 35129 Padova PD

Tournament Participation (Entries) by Club

 A.S.D. TATAKAI KARATE TEAM(TATAKAI)					
ID	Sex	Family Name	Given Name	Category	
190	Female	SEREN	DIANA	Kata Individual female U14	
191	Female	SEREN	DIANA	Kata Individual female U14 R2-G1	

Entries: 2

VENETO OPEN

ITALY

2023.05.19 - 2023.05.21

Via S. Marco, 53, 35129 Padova PD

Tournament Participation (Entries) by Club

 A.S.D. TIGER KARATE TEAM(TIGERKARATETEAM)					
ID	Sex	Family Name	Given Name	Category	
192	Female	BERTOCCHI	ELISA	Kata Individual female Cadets	
193	Male	BIZZARRI	GIACOMO	Kumite Individual male U14 -55	
194	Male	BORROMETI	OMAR	Kata Individual male U14	
195	Male	BORROMETI	OMAR	Kata Individual male U14 R2-G1	
196	Male	BORROMETI	OMAR	Kata Individual male U14 R3 Bronze Medal Match 2	
197	Female	COSELLI	LINDA	Kata Individual female Cadets	
198	Female	COSELLI	LINDA	Kata Individual female Cadets R2-G2	
199	Female	DELLAMICO	GIOIA	Kata Individual female U14	
200	Female	Grieco	Lucrezia	Kumite Individual female Cadets +61	
201	Female	IACOVONE	MARTINA	Kata Individual female Sen	

Entries: **10**

VENETO OPEN

ITALY

2023.05.19 - 2023.05.21

Via S. Marco, 53, 35129 Padova PD

Tournament Participation (Entries) by Club

 A.S.D.KARATE VENEZIA(KARATE VENEZIA)					
ID	Sex	Family Name	Given Name	Category	
202	Male	CECCHINI	JACOPO	Kumite Individual male U14 -55	
203	Male	CHIOZZOTTO PRADOLIN	SEBASTIANO UGO	Kumite Individual male U14 +55	
204	Female	PAVIS	ANNALISA	Kumite Individual female Juniors -59	

Entries: 3

VENETO OPEN

ITALY

2023.05.19 - 2023.05.21

Via S. Marco, 53, 35129 Padova PD

Tournament Participation (Entries) by Club

 A.S.DILETTANTISTICA EPOMEIO ROMA(A.S.D. EPOMEIO)					
ID	Sex	Family Name	Given Name	Category	
205	Female	Mandal	Rebecca	Kumite Individual female U14 -47	
206	Male	MD Kasal	G Hussain	Kumite Individual male Cadets -63	
207	Male	Romano	Gabriele	Kumite Individual male U14 +55	

Entries: 3

VENETO OPEN

ITALY

2023.05.19 - 2023.05.21

Via S. Marco, 53, 35129 Padova PD

Tournament Participation (Entries) by Club

 A.T. karate club Roma(A.T. karate club Roma)					
ID	Sex	Family Name	Given Name	Category	
208	Male	AGUS	MARIO	Kumite Individual male U21 -60	
209	Male	BIANCHI	SALY	Kumite Individual male U21 -67	
210	Female	CECERE	MARIKA	Kumite Individual female U21 -55	
211	Male	IZZO	GIANMARCO	Kumite Individual male Juniors -61	
212	Male	MARINO	FERNANDO	Kumite Individual male Juniors +76	
213	Male	TORRE	LORENZO	Kumite Individual male U21 -84	

Entries: 6

VENETO OPEN

ITALY

2023.05.19 - 2023.05.21

Via S. Marco, 53, 35129 Padova PD

Tournament Participation (Entries) by Club



ACADEMY PONTE DI PIAVE ASD(ASDK PDP)

ID	Sex	Family Name	Given Name	Category
214	Male	Guerra	Riccardo	Kumite Individual male Juniors -55

Entries: 1

VENETO OPEN

ITALY

2023.05.19 - 2023.05.21

Via S. Marco, 53, 35129 Padova PD

Tournament Participation (Entries) by Club

 accademia karate casentino(AKC)					
ID	Sex	Family Name	Given Name	Category	
215	Female	Abenante	Laura	Kumite Individual female Juniors -48	

Entries: 1

VENETO OPEN

ITALY

2023.05.19 - 2023.05.21

Via S. Marco, 53, 35129 Padova PD

Tournament Participation (Entries) by Club

 Accademia Karate Montevarchi A.S.D.(Acc. Karate Montevarchi)					
ID	Sex	Family Name	Given Name	Category	
216	Male	Brogi	Tommaso	Kumite Individual male Juniors -68	
217	Female	Corbo	Keira	Kumite Individual female Cadets +61	
218	Male	Di Maio	Manuel	Kumite Individual male Cadets +70	
219	Male	Mariani	Lorenzo	Kumite Individual male Cadets -63	
220	Female	Vannini	Emma	Kumite Individual female Cadets +61	

Entries: 5

VENETO OPEN

ITALY

2023.05.19 - 2023.05.21

Via S. Marco, 53, 35129 Padova PD

Tournament Participation (Entries) by Club

 ACCADEMIA KARATE UNION TEAM(AK)					
ID	Sex	Family Name	Given Name	Category	
221	Male	LIBERTI	Santino	Kumite Individual male Cadets +70	
222	Female	LOFFREDO	Andrea Chiara	Kumite Individual female Juniors -59	
223	Female	Morra	Francesca	Kumite Individual female Seniors -50	
224	Female	Morra	Francesca	Kumite Individual female U21 -50	
225	Male	ROSIELLO	Marco	Kata Individual male Cadets	

Entries: 5

VENETO OPEN

ITALY

2023.05.19 - 2023.05.21

Via S. Marco, 53, 35129 Padova PD

Tournament Participation (Entries) by Club

 ACCADEMIA TENRYU KARATE ASD(TENRYU KRT)					
ID	Sex	Family Name	Given Name	Category	
226	Male	CAMPAGNA	SAMUELE	Kata Individual male Cadets	
227	Male	CAMPAGNA	SAMUELE	Kata Individual male Cadets R2-G1	
228	Male	CARCHESIO	JACOPO	Kata Individual male Sen R2-G2	
229	Male	CARCHESIO	JACOPO	Kata Individual male Sen	
230	Male	CARCHESIO	JACOPO	Kata Individual male Juniors	
231	Female	La Macchia	Cristina	Kata Individual female Sen	
232	Female	La Macchia	Cristina	Kata Individual female Juniors	

Entries: 7

VENETO OPEN

ITALY

2023.05.19 - 2023.05.21

Via S. Marco, 53, 35129 Padova PD

Tournament Participation (Entries) by Club

 ACSD BUDO LACASSIA torino(BudoLacassia)					
ID	Sex	Family Name	Given Name	Category	
233	Female	Dapas	Vanessa	Kumite Individual female U21 -55	
234	Male	Dominici	Matteo	Kumite Individual male Juniors -68	
235	Male	LACASSIA	Leonardo	Kumite Individual male U21 +84	
236	Female	Laiolo	Serena	Kumite Individual female Juniors -59	

Entries: 4

VENETO OPEN

ITALY

2023.05.19 - 2023.05.21

Via S. Marco, 53, 35129 Padova PD

Tournament Participation (Entries) by Club

 ACTIVITY CLUB SSD ARL(ACTIVITY CLUB SSD)					
ID	Sex	Family Name	Given Name	Category	
237	Male	scarcella	nicola	Kumite Individual male U14 +55	

Entries: 1

VENETO OPEN

ITALY

2023.05.19 - 2023.05.21

Via S. Marco, 53, 35129 Padova PD

Tournament Participation (Entries) by Club

 AI DAI CLUB VILLA ADRIANA(AI DAI CLUB)					
ID	Sex	Family Name	Given Name	Category	
238	Male	MIRILLA	SAMUEL	Kumite Individual male Juniors -76	
239	Male	NICOLAI	RICCARDO	Kumite Individual male Cadets -70	

Entries: 2

VENETO OPEN

ITALY

2023.05.19 - 2023.05.21

Via S. Marco, 53, 35129 Padova PD

Tournament Participation (Entries) by Club

 AKS Firenze(AKS Firenze)					
ID	Sex	Family Name	Given Name	Category	
240	Male	Acquaioli	Tommaso	Kata Individual male U21	
241	Female	Andreini	Marta	Kata Individual female Cadets	
242	Female	Andreini	Marta	Kata Individual female Cadets R2-G2	
243	Male	Brunetti Melozzi	Cesare	Kumite Individual male Juniors -68	
244	Male	Capaccioli	Cosimo	Kumite Individual male U14 -55	
245	Male	De Meo	Marco	Kata Individual male U14	
246	Male	De Meo	Marco	Kata Individual male U14 R2-G1	
247	Male	De Meo	Marco	Kata Individual male U14 R3 Gold Medal Match	
248	Male	Fioravanti	Riccardo	Kata Individual male Cadets	
249	Male	Fioravanti	Riccardo	Kata Individual male Cadets R2-G2	
250	Male	Melani	Matteo	Kata Individual male Juniors R2-G1	
251	Male	Melani	Matteo	Kata Individual male Juniors	
252	Male	Mordini	Alessandro	Kumite Individual male U14 -45	
253	Female	Paoletti	Ilaria	Kata Individual female Sen	
254	Male	Risito	Matteo	Kumite Individual male Cadets +70	
255	466364	Male	Ulqinaku	Leonardo Kumite Individual male Juniors +76	
256	Male	Zecchino	Alan	Kumite Individual male Cadets -52	

Entries: 17

VENETO OPEN

ITALY

2023.05.19 - 2023.05.21

Via S. Marco, 53, 35129 Padova PD

Tournament Participation (Entries) by Club

 Arte Del Movimento Rovigo(Arte Del Movimento)					
ID	Sex	Family Name	Given Name	Category	
257	Male	Battistini	Mattia	Kumite Individual male U14 -40	
258	Male	Loudiyi	Yasser	Kumite Individual male U21 -60	

Entries: 2

VENETO OPEN

ITALY

2023.05.19 - 2023.05.21

Via S. Marco, 53, 35129 Padova PD

Tournament Participation (Entries) by Club

🇮🇹 asd karate ninja club(knc)					
ID	Sex	Family Name	Given Name	Category	
259	Female	CIANCHI	MARTINA	Kata Individual female Sen	
260	Female	CIANCHI	MARTINA	Kata Individual female Sen R2-G2	
261	Female	CIANCHI	MARTINA	Kata Individual female U21	
262	Female	CIANCHI	MARTINA	Kata Individual female U21 R2-G1	
263	Female	NAGLEIN	EMMA	Kata Individual female Cadets	

Entries: 5

VENETO OPEN

ITALY

2023.05.19 - 2023.05.21

Via S. Marco, 53, 35129 Padova PD

Tournament Participation (Entries) by Club

 ASD ACCADEMIA KARATE AREZZO (AKA)					
ID	Sex	Family Name	Given Name	Category	
264	Female	DIONI	ELEONORA	Kumite Individual female Cadets -54	
265	Female	GAGLIOTI	FRANCESCA	Kumite Individual female Seniors -55	
266	Female	GAGLIOTI	FRANCESCA	Kumite Individual female U21 -55	
267	Female	MKARTI	MALAK	Kumite Individual female Juniors +66	

Entries: 4

VENETO OPEN

ITALY

2023.05.19 - 2023.05.21

Via S. Marco, 53, 35129 Padova PD

Tournament Participation (Entries) by Club



asd APAM(APAM)

ID	Sex	Family Name	Given Name	Category
268	Female	LORENZET	LISA	Kumite Individual female Seniors -55

Entries: 1

VENETO OPEN

ITALY

2023.05.19 - 2023.05.21

Via S. Marco, 53, 35129 Padova PD

Tournament Participation (Entries) by Club

 asd athletic karate do azzano x(atlkarazzx)					
ID	Sex	Family Name	Given Name	Category	
269	Male	Sciannelli	GIULIO	Kata Individual male Cadets	
270	Male	ZANET	THOMAS	Kata Individual male U14	

Entries: 2

VENETO OPEN

ITALY

2023.05.19 - 2023.05.21

Via S. Marco, 53, 35129 Padova PD

Tournament Participation (Entries) by Club

 Asd Bushinkai(Bushinkai)					
ID	Sex	Family Name	Given Name	Category	
271	Male	De Gregorio	Riccardo	Kumite Individual male U14 -50	
272	Male	Iacobacci	Amedeo Junior	Kumite Individual male U14 -40	

Entries: 2

VENETO OPEN

ITALY

2023.05.19 - 2023.05.21

Via S. Marco, 53, 35129 Padova PD

Tournament Participation (Entries) by Club

 ASD CAM LUCCA(ASD CAM LUCCA)					
ID	Sex	Family Name	Given Name	Category	
273	ITA03110	Female	Bozzi	Rebecca	Kata Individual female U21
274		Female	MALLEGNI	MARTA	Kata Individual female Cadets
275	ITA02738	Female	MORBINI	GAIA	Kata Individual female Sen
276	ITA02738	Female	MORBINI	GAIA	Kata Individual female Sen R2-G1
277	ITA03808	Female	MUGNANI	MIRIAM	Kata Individual female Juniors
278	ITA03004	Female	Salani	Aurora	Kata Individual female U21
279	SD647070	Female	SCATENA	LETIZIA	Kata Individual female Juniors
280		Female	TOGNETTI	MARIA CHIARA	Kata Individual female Cadets

Entries: 8

VENETO OPEN

ITALY

2023.05.19 - 2023.05.21

Via S. Marco, 53, 35129 Padova PD

Tournament Participation (Entries) by Club

 asd CENTRO KARATE SPORTIVO(asd CKS)					
ID	Sex	Family Name	Given Name	Category	
281	Female	BELLARDI	MARIA SOFIA	Kata Individual female Cadets	
282	Female	GALLUZZI	REBECCA	Kata Individual female Cadets	
283	Female	GATTA	LINDA	Kata Individual female Cadets	
284	Female	MORO	SOFIA	Kata Individual female Sen	
285	Female	Nichetti	Valeria	Kata Individual female Juniors	

Entries: 5

VENETO OPEN

ITALY

2023.05.19 - 2023.05.21

Via S. Marco, 53, 35129 Padova PD

Tournament Participation (Entries) by Club

 ASD CENTRO SPORTIVO TEODORO MONTEPARANO(C.S TEODORO)					
ID	Sex	Family Name	Given Name	Category	
286	Female	CARDONE	MARTINA	Kumite Individual female U14 -47	
287	Male	Panico	Valentino	Kumite Individual male Cadets -63	

Entries: 2

VENETO OPEN

ITALY

2023.05.19 - 2023.05.21

Via S. Marco, 53, 35129 Padova PD

Tournament Participation (Entries) by Club

 ASD CENTRO STUDI KARATE NEGRAR(ASD CSK NEGRAR)					
ID	Sex	Family Name	Given Name	Category	
288	Female	Lavarini	Nicole	Kumite Individual female Cadets -54	
289	Female	Salvi	Caterina	Kumite Individual female Cadets -61	
290	Male	Strazieri	Filippo	Kumite Individual male Cadets -63	
291	Female	Tommasi	Agnese	Kumite Individual female U21 -55	

Entries: 4

VENETO OPEN

ITALY

2023.05.19 - 2023.05.21

Via S. Marco, 53, 35129 Padova PD

Tournament Participation (Entries) by Club

 ASD CINTURA NERA KARATE (CINTURA NERA K)					
ID	Sex	Family Name	Given Name	Category	
292	Female	BRAMBILLA	SOFIA	Kumite Individual female Juniors -66	
293	Male	CAMEROTA	ISAAC MATTIA	Kumite Individual male U14 -50	
294	Female	CATTANEO	CHIARA	Kumite Individual female Juniors -53	
295	Male	GULIN	GABRIELE	Kumite Individual male U14 -40	
296	Female	MURGIA	ALESSIA	Kumite Individual female Cadets -47	
297	Female	MURGIA	ARIANNA	Kumite Individual female Cadets -54	
298	Female	RICCIARDI	ELISA	Kumite Individual female Cadets +61	

Entries: 7

VENETO OPEN

ITALY

2023.05.19 - 2023.05.21

Via S. Marco, 53, 35129 Padova PD

Tournament Participation (Entries) by Club

 ASD CISTELLUM JUDO KARATE(ASD CISKARATE)					
ID	Sex	Family Name	Given Name	Category	
299	Male	Brundu	Cristian	Kata Individual male Cadets	
300	Male	Brundu	Cristian	Kata Individual male Cadets R2-G1	
301	Male	Morandi	Andrea	Kata Individual male Sen	

Entries: 3

VENETO OPEN

ITALY

2023.05.19 - 2023.05.21

Via S. Marco, 53, 35129 Padova PD

Tournament Participation (Entries) by Club

 ASD CLUB FUNAKOSHI(FUNAKOSHI)					
ID	Sex	Family Name	Given Name	Category	
302	Female	Bragari	Ariana	Kumite Individual female U14 -42	
303	Male	Furfari	Giuseppe Antonio	Kumite Individual male U14 -50	
304	Female	Luna Arias	Daniela Ginevra	Kumite Individual female U14 -42	
305	Female	Vogli	Sara	Kumite Individual female Juniors +66	

Entries: 4

VENETO OPEN

ITALY

2023.05.19 - 2023.05.21

Via S. Marco, 53, 35129 Padova PD

Tournament Participation (Entries) by Club

 ASD CLUB KARATE SHOTOKAN(ASDCKS)					
ID	Sex	Family Name	Given Name	Category	
306	Male	Licciardi	Simone	Kumite Individual male U14 +55	

Entries: 1

VENETO OPEN

ITALY

2023.05.19 - 2023.05.21

Via S. Marco, 53, 35129 Padova PD

Tournament Participation (Entries) by Club

 ASD CSK MASTER(ASD CSK MASTER)					
ID	Sex	Family Name	Given Name	Category	
307	Male	BERETTA	FEDERICO	Kata Individual male Cadets R2-G2	
308	Male	BERETTA	FEDERICO	Kata Individual male Cadets	

Entries: 2

VENETO OPEN

ITALY

2023.05.19 - 2023.05.21

Via S. Marco, 53, 35129 Padova PD

Tournament Participation (Entries) by Club

 ASD DEFENCE KARATE 2000 PRAVISDOMINI(Defence)					
ID	Sex	Family Name	Given Name	Category	
309	Female	Fregonese	Martina	Kumite Individual female U21 -68	
310	Male	Mio	Danny	Kumite Individual male Seniors -75	

Entries: 2

VENETO OPEN

ITALY

2023.05.19 - 2023.05.21

Via S. Marco, 53, 35129 Padova PD

Tournament Participation (Entries) by Club



ASD DRAGON KARATE TEAM MODENA(DKT MODENA)

ID	Sex	Family Name	Given Name	Category
311	Female	GIBERTONI	SARA	Kumite Individual female U14 +52

Entries: 1

VENETO OPEN

ITALY

2023.05.19 - 2023.05.21

Via S. Marco, 53, 35129 Padova PD

Tournament Participation (Entries) by Club

 ASD DRAGON KARATE(DRAGON KARATE)					
ID	Sex	Family Name	Given Name	Category	
312	Male	ALEKSANDROV	NAZAR	Kumite Individual male U14 -55	
313	Male	CODELUPPI	NICCOLO	Kumite Individual male Cadets -70	
314	Male	SIA	ERIC	Kumite Individual male Cadets -63	

Entries: 3

VENETO OPEN

ITALY

2023.05.19 - 2023.05.21

Via S. Marco, 53, 35129 Padova PD

Tournament Participation (Entries) by Club



ASD EDERA KARATE FORLI(ASD EDERA)

ID	Sex	Family Name	Given Name	Category
315	Male	Piazza	Francesco	Kumite Individual male Cadets -52

Entries: 1

VENETO OPEN

ITALY

2023.05.19 - 2023.05.21

Via S. Marco, 53, 35129 Padova PD

Tournament Participation (Entries) by Club

 ASD ESERCITO - 187 FOLGORE(ASD ESERCITO - 187 FOLGORE)					
ID	Sex	Family Name	Given Name	Category	
316	Male	Baroni	Edoardo	Kata Individual male Sen	
317	Male	Baroni	Edoardo	Kata Individual male Juniors	
318	Male	BOZZI	ANDREA	Kumite Individual male Juniors -76	
319	Male	CITI	JACOPO	Kumite Individual male Cadets -52	
320	Male	CORVAGLIA	SAMUELE	Kata Individual male Sen R2-G2	
321	Male	CORVAGLIA	SAMUELE	Kata Individual male Sen	
322	Male	CORVAGLIA	SAMUELE	Kata Individual male Juniors	
323	Male	CORVAGLIA	VINCENZO	Kata Individual male Sen	
324	Female	FRIZZI	EMMA LUDOVICA	Kumite Individual female Juniors -59	
325	Male	LIGAS	EDOARDO	Kumite Individual male Cadets -57	
326	Male	NANNINI	LEONARDO	Kumite Individual male U14 -40	

Entries: 11

VENETO OPEN

ITALY

2023.05.19 - 2023.05.21

Via S. Marco, 53, 35129 Padova PD

Tournament Participation (Entries) by Club

 ASD ESERCITO - 3 RGT AVES AQUILA(ESERCITO AVES AQUILA)					
ID	Sex	Family Name	Given Name	Category	
327	Male	baiocchi	angelo tommaso	Kumite Individual male U21 -67	
328	Male	Benison	Mehmi	Kumite Individual male Juniors -55	
329	Male	Carminati	Andrea	Kata Individual male Cadets	
330	Male	carminati	andrea	Kumite Individual male U14 -55	
331	Female	Cielok	Irene	Kata Individual female U14	
332	Female	ciurlia	nadia	Kumite Individual female U14 +52	
333	Male	el koreichi	hamza	Kumite Individual male Juniors -68	
334	Female	El koreichi	Laila	Kumite Individual female U14 -47	
335	Female	Gafforelli	Elisa	Kumite Individual female U21 -55	
336	Female	Ippolito	Asia	Kumite Individual female U21 -61	
337	Male	massignani	tommaso	Kata Individual male U14	
338	Female	micheli	matilde	Kata Individual female Cadets R4 Gold Medal Match	
339	Female	micheli	matilde	Kata Individual female Cadets R3-G1	
340	Female	micheli	matilde	Kata Individual female Cadets R2-G1	
341	Female	micheli	matilde	Kata Individual female Cadets	
342	Female	Natalini	Giulia Ginevra	Kata Individual female Cadets R2-G1	
343	Female	Natalini	Giulia Ginevra	Kata Individual female Cadets	
344	Female	Preda	Giada	Kata Individual female Cadets R3-G2	
345	Female	Preda	Giada	Kata Individual female Cadets	
346	Female	Preda	Giada	Kata Individual female Cadets R2-G2	
347	Female	Preda	Giada	Kata Individual female Cadets R4 Bronze Medal Match 2	
348	Male	rapis	massimo	Kata Individual male Juniors	
349	Female	villa	martina	Kata Individual female Cadets R2-G2	
350	Female	villa	martina	Kata Individual female Cadets	

Entries: **24**

VENETO OPEN

ITALY

2023.05.19 - 2023.05.21

Via S. Marco, 53, 35129 Padova PD

Tournament Participation (Entries) by Club

 ASD FC MOREVILLA(Asd Morevilla)					
ID	Sex	Family Name	Given Name	Category	
351	649029	Male	Castellano	FEDERICO	Kumite Individual male U14 -50
352	649030	Male	CERSOSIMO	ALESSANDRO	Kumite Individual male U14 -55
353	451466	Male	CIBRARIO	MATTEO	Kumite Individual male Cadets -63
354	814247	Male	Lella	Qian Yue Daniele	Kumite Individual male U14 -40
355	484829	Male	MAGGIPINTO	STEFANO	Kumite Individual male Cadets -63
356	483231	Female	MUCCIA	SERENA	Kumite Individual female U14 -42
357	435465	Male	NARDACCIO	MATTEO	Kata Individual male U14 R3 Gold Medal Match
358	435465	Male	NARDACCIO	MATTEO	Kata Individual male U14
359	435465	Male	NARDACCIO	MATTEO	Kata Individual male U14 R2-G2
360	435470	Male	PAGNOTTA	ALESSANDRO	Kumite Individual male Juniors -55
361	734679	Male	PANARO	ALESSANDRO	Kumite Individual male U14 -50
362	463341	Male	Scarola	Raphae	Kumite Individual male U14 -45

Entries: 12

VENETO OPEN

ITALY

2023.05.19 - 2023.05.21

Via S. Marco, 53, 35129 Padova PD

Tournament Participation (Entries) by Club

 Asd Fenice Karate Team(FKT)					
ID	Sex	Family Name	Given Name	Category	
363	Female	BALDRIGHI	CHIARA	Kata Individual female Cadets	
364	Female	FORCELLA	ELEONORA	Kata Individual female Cadets R2-G1	
365	Female	FORCELLA	ELEONORA	Kata Individual female Cadets	
366	Female	GRUPPIONI	ASIA	Kata Individual female Sen R3-G1	
367	Female	GRUPPIONI	ASIA	Kata Individual female Sen R4 Bronze Medal Match 1	
368	Female	GRUPPIONI	ASIA	Kata Individual female Sen R2-G1	
369	Female	GRUPPIONI	ASIA	Kata Individual female Sen	
370	Female	GRUPPIONI	ASIA	Kata Individual female Juniors R3-G1	
371	Female	GRUPPIONI	ASIA	Kata Individual female Juniors	
372	Female	GRUPPIONI	ASIA	Kata Individual female Juniors R4 Bronze Medal Match 1	
373	Female	GRUPPIONI	ASIA	Kata Individual female Juniors R2-G1	

Entries: 11

VENETO OPEN

ITALY

2023.05.19 - 2023.05.21

Via S. Marco, 53, 35129 Padova PD

Tournament Participation (Entries) by Club

 Asd Foligno, Karate Club, (FolignoKarate)					
ID	Sex	Family Name	Given Name	Category	
374	Male	Dan	Leonard	Kumite Individual male U21 +84	
375	SD45554	Martellini	Nicholas	Kumite Individual male Juniors +76	
376	Male	Martellini	Samuel	Kumite Individual male U21 -75	
377	SD52429	Pierbattisti	Riccardo	Kumite Individual male U21 -60	
378	Male	PONTASSUGLIA	FRANCESCO	Kumite Individual male U14 -50	
379	ITA03801	Torti	Lorenzo	Kumite Individual male Juniors -61	

Entries: 6

VENETO OPEN

ITALY

2023.05.19 - 2023.05.21

Via S. Marco, 53, 35129 Padova PD

Tournament Participation (Entries) by Club

 ASD INTERNATIONAL PALADANZE(PALADANZE)					
ID	Sex	Family Name	Given Name	Category	
380	Female	ALOISIO	GIADA	Kumite Individual female Juniors -59	
381	Male	BASILE	MANUEL	Kumite Individual male Cadets -70	
382	Male	BURROSI	SAMUELE	Kumite Individual male Juniors +76	
383	Male	NAVARRA	FRANCESCO	Kumite Individual male Cadets -57	

Entries: 4

VENETO OPEN

ITALY

2023.05.19 - 2023.05.21

Via S. Marco, 53, 35129 Padova PD

Tournament Participation (Entries) by Club

 asd judo karate club(asd jk club)					
ID	Sex	Family Name	Given Name	Category	
384	Female	burzo	carolina	Kumite Individual female Cadets -54	
385	Female	burzo	francesca	Kumite Individual female Juniors -53	
386	Male	ferrarini	francesco	Kumite Individual male Cadets -70	

Entries: 3

VENETO OPEN

ITALY

2023.05.19 - 2023.05.21

Via S. Marco, 53, 35129 Padova PD

Tournament Participation (Entries) by Club

 ASD KARATE 2001(K 01)					
ID	Sex	Family Name	Given Name	Category	
387	Female	Biondo	Ilaria	Kata Individual female Sen R2-G1	
388	Female	Biondo	Ilaria	Kata Individual female Sen	
389	Female	DEste	Federica	Kumite Individual female Seniors -61	
390	Female	DEste	Federica	Kumite Individual female U21 -61	
391	Female	Paronetto	Giorgia	Kumite Individual female U14 -47	

Entries: 5

VENETO OPEN

ITALY

2023.05.19 - 2023.05.21

Via S. Marco, 53, 35129 Padova PD

Tournament Participation (Entries) by Club

 ASD karate Benaco(ASD karate Benaco)					
ID	Sex	Family Name	Given Name	Category	
392	Female	Crosatti	Elisa	Kumite Individual female Cadets -61	
393	Female	Sartori	Martina	Kumite Individual female Cadets -54	

Entries: 2

VENETO OPEN

ITALY

2023.05.19 - 2023.05.21

Via S. Marco, 53, 35129 Padova PD

Tournament Participation (Entries) by Club

 asd karate camaiole(karate camaiole fijlkam)					
ID	Sex	Family Name	Given Name	Category	
394	Male	CORONA	MATTIA	Kata Individual male Sen	
395	Male	COSCI	GIUSEPPE	Kata Individual male Juniors R3-G2	
396	Male	COSCI	GIUSEPPE	Kata Individual male Juniors	
397	Male	COSCI	GIUSEPPE	Kata Individual male Juniors R2-G2	
398	Male	COSCI	GIUSEPPE	Kata Individual male Juniors R4 Gold Medal Match	
399	Female	LENZONI	EMMA	Kata Individual female U14 R2-G1	
400	Female	LENZONI	EMMA	Kata Individual female U14 R3 Bronze Medal Match 2	
401	Female	LENZONI	EMMA	Kata Individual female U14	
402	Female	marcelli	anna	Kata Individual female Juniors	
403	Female	marcelli	anna	Kata Individual female Juniors R2-G1	
404	Female	SIMONCINI	SOPHIA	Kata Individual female Sen	

Entries: 11

VENETO OPEN

ITALY

2023.05.19 - 2023.05.21

Via S. Marco, 53, 35129 Padova PD

Tournament Participation (Entries) by Club

 ASD Karate Center Bologna(KCB)					
ID	Sex	Family Name	Given Name	Category	
405	Male	BARTOLINI	LORENZO	Kumite Individual male U21 -84	
406	Male	Berti	Rafael	Kumite Individual male Cadets +70	
407	Male	Laginestra	Luigi Alessandro	Kumite Individual male Cadets -57	

Entries: 3

VENETO OPEN

ITALY

2023.05.19 - 2023.05.21

Via S. Marco, 53, 35129 Padova PD

Tournament Participation (Entries) by Club

 ASD Karate club kanazawa(Kanazawa Cimadolmo)					
ID	Sex	Family Name	Given Name	Category	
408	Female	BUTA	MELISSA	Kumite Individual female U14 -47	
409	Female	cucciol	eleonora	Kumite Individual female Cadets -54	
410	Male	muccignat	alberto	Kumite Individual male U14 -55	
411	Male	redigolo	davide	Kumite Individual male Cadets -57	

Entries: 4

VENETO OPEN

ITALY

2023.05.19 - 2023.05.21

Via S. Marco, 53, 35129 Padova PD

Tournament Participation (Entries) by Club

 ASD KARATE CLUB VALDOBBIADENE CROCETTA(ASD KARATE VALDO)					
ID	Sex	Family Name	Given Name	Category	
412	Male	CORBANESE	ENRICO	Kumite Individual male U14 -40	
413	Female	MARSURA	ELISA	Kumite Individual female Cadets -47	
414	Female	PEDERIVA	PAOLA	Kumite Individual female Seniors -55	
415	Female	Pryndiuk	Anastasia	Kumite Individual female U14 -42	
416	Male	Pryndiuk	Artem	Kumite Individual male U14 -45	
417	Female	SOLIMANO	ISABEL	Kumite Individual female U14 -42	
418	Female	VETTORETTI	GIADA	Kumite Individual female U14 -47	

Entries: 7

VENETO OPEN

ITALY

2023.05.19 - 2023.05.21

Via S. Marco, 53, 35129 Padova PD

Tournament Participation (Entries) by Club

ASD KARATE DO NOVENTA(ASD KARATE DO NOVENTA)					
ID	Sex	Family Name	Given Name	Category	
419	WKF-ID	Female	ROCCHI	ASIA	Kata Individual female U14

Entries: 1

VENETO OPEN

ITALY

2023.05.19 - 2023.05.21

Via S. Marco, 53, 35129 Padova PD

Tournament Participation (Entries) by Club

 ASD Karate Genocchio(KG1982)					
ID	Sex	Family Name	Given Name	Category	
420	Female	Baronchelli	Martina	Kumite Individual female Cadets -54	
421	Female	BOSIO	MATILDE	Kumite Individual female Juniors -48	
422	Female	BROGNOLI	GRETA	Kumite Individual female Seniors +68	
423	Male	Chiari	Luca	Kumite Individual male Cadets -70	
424	Male	Genocchio	Manuel	Kumite Individual male Cadets -63	
425	Female	Gjorgieva	Anelia	Kumite Individual female U21 -50	
426	Male	Realini	Niccol	Kumite Individual male Cadets -70	
427	Male	Rospo	Lorenzo	Kumite Individual male Cadets -52	
428	Female	Terna	Sofia	Kumite Individual female Juniors -48	
429	Female	TORRI	LAURA	Kumite Individual female U21 -55	

Entries: **10**

VENETO OPEN

ITALY

2023.05.19 - 2023.05.21

Via S. Marco, 53, 35129 Padova PD

Tournament Participation (Entries) by Club

 ASD KARATE SACILE(KARATE SACILE)					
ID	Sex	Family Name	Given Name	Category	
430	Male	PAGOS	LORENZO	Kumite Individual male Seniors -60	
431	Male	PAGOS	LUCA	Kumite Individual male Juniors -61	
432	Female	RAIMONDI	ALESSIA	Kumite Individual female Juniors -59	

Entries: 3

VENETO OPEN

ITALY

2023.05.19 - 2023.05.21

Via S. Marco, 53, 35129 Padova PD

Tournament Participation (Entries) by Club

asd KARATE TEAM 1999(KARATE TEAM 1999)					
ID	Sex	Family Name	Given Name	Category	
433	Female	Bulgarelli	Irene	Kata Individual female Juniors	
434	Male	DE PASQUALE	LUCA	Kumite Individual male Cadets -57	
435	Female	Dusi	Serena	Kata Individual female Sen	
436	Male	Guandalini	Matteo	Kumite Individual male Juniors -68	
437	Male	MOI	GIOELE	Kumite Individual male Cadets -57	
438	Male	PIZZAMIGLIO	ALESSIO	Kata Individual male Cadets	
439	Male	QUACECI	ALFIO	Kumite Individual male U21 -67	
440	Male	SPIAZZI	Matteo	Kumite Individual male Juniors -76	
441	Female	Zairi	Nour	Kumite Individual female Seniors -55	
442	Female	ZINDAOUI	BESMELA	Kumite Individual female Cadets -61	

Entries: **10**

VENETO OPEN

ITALY

2023.05.19 - 2023.05.21

Via S. Marco, 53, 35129 Padova PD

Tournament Participation (Entries) by Club

 Asd kb center 2000(Kb center 2000)					
ID	Sex	Family Name	Given Name	Category	
443	Female	Bonavolonta	Francesca	Kata Individual female U21	
444	Female	campisciano	alessia	Kata Individual female Juniors	
445	Male	priolo	riccardo	Kata Individual male Sen	
446	Male	Stefanini	Cristian	Kumite Individual male Cadets -52	

Entries: 4

VENETO OPEN

ITALY

2023.05.19 - 2023.05.21

Via S. Marco, 53, 35129 Padova PD

Tournament Participation (Entries) by Club

ASD KEN KO PIOBESI(ASD KEN KO PIOBESI)					
ID	Sex	Family Name	Given Name	Category	
447	Male	DOVERA	GABRIELE	Kumite Individual male Juniors +76	

Entries: 1

VENETO OPEN

ITALY

2023.05.19 - 2023.05.21

Via S. Marco, 53, 35129 Padova PD

Tournament Participation (Entries) by Club

asd le arti new school dojo shotokan roma est(le arti new school)					
ID	Sex	Family Name	Given Name	Category	
448	Male	aloise	leonardo	Kata Individual male Juniors	
449	Male	AURELI	LEONARDO	Kumite Individual male Juniors -55	
450	Female	calin	alexia	Kumite Individual female Cadets -54	
451	Female	craiu	biatris Ionela	Kumite Individual female Juniors -59	
452	Male	lleshaj	gabriele	Kumite Individual male Juniors -76	
453	Male	OSELLI	TOMMASO	Kumite Individual male Cadets +70	
454	Female	zaccaro	aisha	Kumite Individual female U21 -50	

Entries: 7

VENETO OPEN

ITALY

2023.05.19 - 2023.05.21

Via S. Marco, 53, 35129 Padova PD

Tournament Participation (Entries) by Club

 ASD Leoni Karate Team(Leoni Karate Team)					
ID	Sex	Family Name	Given Name	Category	
455	Male	Busi	Lorenzo	Kumite Individual male Cadets -52	
456	Male	Castellazzi	Christian	Kumite Individual male Cadets -63	
457	Male	Golinelli	Federico	Kumite Individual male Cadets -70	
458	Female	Malaguti	Sara	Kumite Individual female Juniors -59	
459	Female	Manicardi	Vittoria	Kumite Individual female U21 -61	
460	Female	Montanari	Alessia Marina	Kumite Individual female Cadets +61	
461	Male	Pignatti	Francesco	Kumite Individual male Seniors -67	
462	Male	Pignatti	Francesco	Kumite Individual male U21 -67	

Entries: 8

VENETO OPEN

ITALY

2023.05.19 - 2023.05.21

Via S. Marco, 53, 35129 Padova PD

Tournament Participation (Entries) by Club

 ASD LIBERTAS CLUB LAVELLO(LCL)				
ID	Sex	Family Name	Given Name	Category
463	Female	BAVUSO	MARIA STEFANIA	Kumite Individual female U21 -61
464	Male	ROSA	FRANCESCO	Kumite Individual male Juniors -68

Entries: 2

VENETO OPEN

ITALY

2023.05.19 - 2023.05.21

Via S. Marco, 53, 35129 Padova PD

Tournament Participation (Entries) by Club

asd nippon club napoli karate(nipponkarate)					
ID	Sex	Family Name	Given Name	Category	
465	Male	Camanzo	Salvatore	Kata Individual male Cadets	
466	Female	Murolo	Francesca Pia	Kumite Individual female Juniors +66	

Entries: 2

VENETO OPEN

ITALY

2023.05.19 - 2023.05.21

Via S. Marco, 53, 35129 Padova PD

Tournament Participation (Entries) by Club



ASD OKINAWA FIGHT(OKINAWA FIGHT ASD)

ID	Sex	Family Name	Given Name	Category
467	Male	Mazzilis	Leonardo	Kumite Individual male U14 -40

Entries: 1

VENETO OPEN

ITALY

2023.05.19 - 2023.05.21

Via S. Marco, 53, 35129 Padova PD

Tournament Participation (Entries) by Club

 ASD Polisportiva Tre Pietre Firenze(TPK)					
ID	Sex	Family Name	Given Name	Category	
468	Male	ESPOSITO	GABRIELE	Kata Individual male U21	
469	Male	Senatori	Andrea	Kata Individual male Sen	

Entries: 2

VENETO OPEN

ITALY

2023.05.19 - 2023.05.21

Via S. Marco, 53, 35129 Padova PD

Tournament Participation (Entries) by Club

 ASD REMBUKAN KARATE VILLASMUNDO(REMBUKAN VILLASMUNDO)					
ID	Sex	Family Name	Given Name	Category	
470	Female	BARONE	MIRYAM	Kumite Individual female Juniors -53	

Entries: 1

VENETO OPEN

ITALY

2023.05.19 - 2023.05.21

Via S. Marco, 53, 35129 Padova PD

Tournament Participation (Entries) by Club

 ASD RENSHUKAN TORINO(RENSHUKAN)					
ID	Sex	Family Name	Given Name	Category	
471	Female	Penso	Isotta	Kumite Individual female Cadets -47	

Entries: 1

VENETO OPEN

ITALY

2023.05.19 - 2023.05.21

Via S. Marco, 53, 35129 Padova PD

Tournament Participation (Entries) by Club

 Asd Ryuko(Asd Ryuko)					
ID	Sex	Family Name	Given Name	Category	
472	Male	Pari	Fabrizio	Kata Individual male Juniors	
473	Female	Vedovelli	Giulia	Kata Individual female Sen	

Entries: 2

VENETO OPEN

ITALY

2023.05.19 - 2023.05.21

Via S. Marco, 53, 35129 Padova PD

Tournament Participation (Entries) by Club

 Asd Samurai Ryu Vallecamonica(Samurai Ryu)					
ID	Sex	Family Name	Given Name	Category	
474	Female	Pelamatti	Desire	Kumite Individual female Juniors -59	
475	Female	Salvetti	Ilaria	Kumite Individual female Juniors -66	

Entries: 2

VENETO OPEN

ITALY

2023.05.19 - 2023.05.21

Via S. Marco, 53, 35129 Padova PD

Tournament Participation (Entries) by Club

 ASD SCUOLA KARATE MIGNAGOLA(KARATE MIGNAGOLA)					
ID	Sex	Family Name	Given Name	Category	
476	Female	Bozzo	Aurora	Kumite Individual female Juniors +66	

Entries: 1

VENETO OPEN

ITALY

2023.05.19 - 2023.05.21

Via S. Marco, 53, 35129 Padova PD

Tournament Participation (Entries) by Club

 Asd Shingitai Pisa(Shingitai Pisa)					
ID	Sex	Family Name	Given Name	Category	
477	Male	BENOTTO	ALESSIO	Kumite Individual male U14 +55	
478	Male	FALORNI	ANDREA	Kumite Individual male Cadets -52	
479	Male	FANTINI	FRANCESCO	Kumite Individual male U14 +55	
480	Male	GAMBINO	JACOPO	Kumite Individual male Cadets +70	
481	Male	SPINESI	LEONARDO	Kumite Individual male Cadets -57	

Entries: 5

VENETO OPEN

ITALY

2023.05.19 - 2023.05.21

Via S. Marco, 53, 35129 Padova PD

Tournament Participation (Entries) by Club



ASD SHOTOKAN ACIREALE(ACIREALE)

ID	Sex	Family Name	Given Name	Category
482	Female	FICHERA	CARLA	Kumite Individual female Juniors +66

Entries: 1

VENETO OPEN

ITALY

2023.05.19 - 2023.05.21

Via S. Marco, 53, 35129 Padova PD

Tournament Participation (Entries) by Club

 ASD Shotokan Karate Pozzuolo del Friuli(SKZP)					
ID	Sex	Family Name	Given Name	Category	
483	Male	BARBANO	ALLESSANDRO	Kumite Individual male Juniors -76	
484	Female	IPPOLITI	IRENE	Kata Individual female Juniors	
485	Male	PAVAN	SEBASTIANO	Kata Individual male U14	

Entries: 3

VENETO OPEN

ITALY

2023.05.19 - 2023.05.21

Via S. Marco, 53, 35129 Padova PD

Tournament Participation (Entries) by Club

ASD SHOURI TEAM KARATE(STK)					
ID	Sex	Family Name	Given Name	Category	
486	Male	GUERRINI	MAURIZIO	Kata Individual male Sen	

Entries: 1

VENETO OPEN

ITALY

2023.05.19 - 2023.05.21

Via S. Marco, 53, 35129 Padova PD

Tournament Participation (Entries) by Club

 ASD TALARICO KARATE TEAM APS(TKT)				
ID	Sex	Family Name	Given Name	Category
487	Female	CAPATTI	GIADA	Kumite Individual female Cadets -47
488	Female	CAPPAL	AMBRA	Kumite Individual female Juniors -48
489	Male	CARRARESI	ALESSANDRO	Kumite Individual male Cadets -63
490	Male	CIAVARELLA	RICCARDO	Kumite Individual male Cadets -57
491	Male	COPPOLA	ALESSANDRO	Kumite Individual male U21 -75
492	Female	Corsaro	Benedetta	Kumite Individual female Cadets -54
493	Female	DAMI	GIORGIA	Kata Individual female U14
494	Male	DE SIMONE	PAOLO	Kumite Individual male Cadets -70
495	Female	DI STEFANO	LAVINIA	Kumite Individual female U14 +52
496	Female	DUBLINO	SOFIA	Kata Individual female Cadets R3-G1
497	Female	DUBLINO	SOFIA	Kata Individual female Cadets R2-G1
498	Female	DUBLINO	SOFIA	Kata Individual female Cadets
499	Female	DUBLINO	SOFIA	Kata Individual female Cadets R4 Bronze Medal Match 2
500	Female	DUTTO	GIULIA	Kumite Individual female Cadets -61
501	Female	FABBRI	GIORGIA	Kumite Individual female U21 -55
502	Male	FALCO	SAMUELE	Kata Individual male Cadets R2-G1
503	Male	FALCO	SAMUELE	Kata Individual male Cadets
504	Male	FREDA	MATTEO	Kata Individual male U14
505	Male	FREDA	MATTEO	Kata Individual male U14 R2-G2
506	Male	FREDA	MATTEO	Kata Individual male U14 R3 Bronze Medal Match 1
507	Male	Galeotti	Thomas	Kata Individual male U21 R2-G1
508	Male	Galeotti	Thomas	Kata Individual male U21
509	Female	GENTILE	GIORGIA	Kumite Individual female Seniors +68
510	Female	GIORDANO	AURORA	Kumite Individual female Cadets -47
511	Male	GIORDANO	FABRIZIO	Kumite Individual male Juniors -61
512	Female	GIRELLO	ALESSANDRA	Kumite Individual female U14 -52
513	Female	GRANATIERO	SOFIA	Kumite Individual female Juniors -59
514	Male	LORENZETTI	TOMMASO	Kumite Individual male U21 -67
515	Female	Lungu	Alessandra	Kumite Individual female Cadets -61
516	Female	Macias Vinci	Angelica	Kata Individual female U14
517	Male	Marrucci	Filippo	Kumite Individual male U14 -45
518	Female	Marrucci	Valentina	Kumite Individual female Juniors -53
519	Male	MARZANO	MICHELE	Kata Individual male Juniors
520	Male	MARZANO	MICHELE	Kata Individual male Juniors R2-G1
521	Female	MONTEBELLO	CARLOTTA	Kumite Individual female Juniors +66
522	Male	NANOCCHIO	GIUSEPPE	Kumite Individual male Seniors -60
523	Male	NANOCCHIO	GIUSEPPE	Kumite Individual male U21 -60
524	Male	NASSER	DIEGO	Kumite Individual male U14 -45
525	Male	NASSER	PAOLO	Kumite Individual male Juniors -61
526	Female	OBERTO	VIVIEN	Kata Individual female Cadets R2-G2
527	Female	OBERTO	VIVIEN	Kata Individual female Cadets R3-G2
528	Female	OBERTO	VIVIEN	Kata Individual female Cadets
529	Female	OBERTO	VIVIEN	Kata Individual female Cadets R4 Bronze Medal Match 1
530	Male	Portogallo	Matteo	Kata Individual male Juniors
531	Male	Portogallo	Matteo	Kata Individual male Juniors R2-G2

VENETO OPEN

ITALY

2023.05.19 - 2023.05.21

Via S. Marco, 53, 35129 Padova PD

Tournament Participation (Entries) by Club

532	Male	PUPPO	MATTEO	Kumite Individual male U21 +84
533	Male	Putelli	Nicol	Kata Individual male Cadets R3-G2
534	Male	Putelli	Nicol	Kata Individual male Cadets R2-G2
535	Male	Putelli	Nicol	Kata Individual male Cadets R4 Bronze Medal Match 1
536	Male	Putelli	Nicol	Kata Individual male Cadets
537	Male	QUATTROCCHI	DANIELE	Kata Individual male U14
538	Male	QUATTROCCHI	DANIELE	Kata Individual male U14 R2-G1
539	Male	RAMOS	MATT	Kumite Individual male U21 -67
540	Female	Rocca	Margherita	Kumite Individual female Cadets -61
541	Female	Schicchi	Alessandra	Kumite Individual female U21 -61
542	Female	Schicchi	Federica	Kumite Individual female Seniors -50
543	Male	SCHICCHI	STEFANO	Kumite Individual male U14 -50
544	Female	TAGLIO	ALESSIA	Kumite Individual female Seniors -55
545	Female	TAGLIO	ALESSIA	Kumite Individual female U21 -55
546	Female	TANCAU	SARA	Kumite Individual female Cadets -54
547	Male	VERRASTRO	RICCARDO	Kumite Individual male Cadets +70
548	Male	VIVALDA	SIMONE	Kumite Individual male U21 -84
549	Male	ZITOUNI	ILIAS	Kumite Individual male Juniors -61

Entries: **63**

VENETO OPEN

ITALY

2023.05.19 - 2023.05.21

Via S. Marco, 53, 35129 Padova PD

Tournament Participation (Entries) by Club

 ASD Tiger s Style Team Iodice(ASD TS)					
ID	Sex	Family Name	Given Name	Category	
550	Female	Apuzzo	Aurora	Kumite Individual female Cadets +61	
551	Male	Di Rubba	Luigi	Kata Individual male Juniors R4 Bronze Medal Match 1	
552	Male	Di Rubba	Luigi	Kata Individual male Juniors R3-G1	
553	Male	Di Rubba	Luigi	Kata Individual male Juniors R2-G1	
554	Male	Di Rubba	Luigi	Kata Individual male Juniors	
555	Male	Maiorino	Pietro	Kumite Individual male Juniors +76	
556	Male	Scialla	Bruno	Kumite Individual male Juniors +76	
557	Female	Sibona	Maria	Kumite Individual female Juniors +66	
558	Male	Vacca	Thomas	Kata Individual male Juniors	

Entries: 9

VENETO OPEN

ITALY

2023.05.19 - 2023.05.21

Via S. Marco, 53, 35129 Padova PD

Tournament Participation (Entries) by Club

asd Treviso Karate(Treviso Karate)					
ID	Sex	Family Name	Given Name	Category	
559	Male	Giuliano	Matteo	Kumite Individual male Cadets -52	

Entries: 1

VENETO OPEN

ITALY

2023.05.19 - 2023.05.21

Via S. Marco, 53, 35129 Padova PD

Tournament Participation (Entries) by Club

 ASD VIP CENTER MOTTA(VIP CENTER MOTTA)					
ID	Sex	Family Name	Given Name	Category	
560	Male	Marchese	Lucio	Kata Individual male Cadets	
561	Male	Marchese	Lucio	Kata Individual male Cadets R3-G2	
562	Male	Marchese	Lucio	Kata Individual male Cadets R2-G2	

Entries: 3

VENETO OPEN

ITALY

2023.05.19 - 2023.05.21

Via S. Marco, 53, 35129 Padova PD

Tournament Participation (Entries) by Club

 ASD YAMAGUCHI(YAM)					
ID	Sex	Family Name	Given Name	Category	
563	Male	BINAGLIA	FEDERICO	Kumite Individual male Cadets -52	
564	Female	FUSO	VERONICA	Kumite Individual female Cadets +61	
565	Male	ROSSI	CRISTIANO	Kumite Individual male Cadets -63	

Entries: 3

VENETO OPEN

ITALY

2023.05.19 - 2023.05.21

Via S. Marco, 53, 35129 Padova PD

Tournament Participation (Entries) by Club

 Asd_Dinamo_Karate_2015(Dinamo Karate 2015)				
ID	Sex	Family Name	Given Name	Category
566	Male	Fioremisto	Mattia	Kumite Individual male U14 -50

Entries: 1

VENETO OPEN

ITALY

2023.05.19 - 2023.05.21

Via S. Marco, 53, 35129 Padova PD

Tournament Participation (Entries) by Club

 Ass. Centro Sportivo Sakura(Sakura Vicenza)					
ID	Sex	Family Name	Given Name	Category	
567	Female	Bisol	Giulia	Kumite Individual female Cadets -61	
568	Male	Bisol	Lorenzo	Kumite Individual male U21 +84	
569	Male	Salomon	Filippo	Kumite Individual male U21 -84	

Entries: 3

VENETO OPEN

ITALY

2023.05.19 - 2023.05.21

Via S. Marco, 53, 35129 Padova PD

Tournament Participation (Entries) by Club

 ass.naz.carab. capasso1(ass.naz.carab. capasso1)					
ID	Sex	Family Name	Given Name	Category	
570	865653	Female	Cocca	Marialuigia	Kumite Individual female Cadets -61
571		Female	petruzziello	nicole anna	Kumite Individual female U14 -42
572		Male	Tornicasa	Francesco	Kumite Individual male Cadets -57

Entries: 3

VENETO OPEN

ITALY

2023.05.19 - 2023.05.21

Via S. Marco, 53, 35129 Padova PD

Tournament Participation (Entries) by Club

 ASSOCIAZIONE SPORTIVA DILETTANTISTICA LEONE(A.S.D.LEONE)					
ID	Sex	Family Name	Given Name	Category	
573	0052983	Male	LEONE	GIUSEPPE	Kumite Individual male Juniors -61
574	0052985	Female	LEONE	ILARIA	Kumite Individual female Cadets -47
575	0065098	Female	Ricciardi	Emanuela	Kumite Individual female Juniors -59

Entries: 3

VENETO OPEN

ITALY

2023.05.19 - 2023.05.21

Via S. Marco, 53, 35129 Padova PD

Tournament Participation (Entries) by Club

 ASSOCIAZIONE SPORTIVA DILETTANTISTICA SHU REN KAN(A.S.D. SHU REN KAN)				
ID	Sex	Family Name	Given Name	Category
576	Male	PARABOSCHI	MATTEO	Kata Individual male Cadets
577	Male	TESORIATI	ALESSANDRO	Kata Individual male Juniors

Entries: 2

VENETO OPEN

ITALY

2023.05.19 - 2023.05.21

Via S. Marco, 53, 35129 Padova PD

Tournament Participation (Entries) by Club

 Atlas Karate(AK)					
ID	Sex	Family Name	Given Name	Category	
578	Female	Bonetti	Nicole	Kata Individual female Cadets	
579	Male	Colombi	Pietro	Kata Individual male Juniors	
580	Male	Colombi	Pietro	Kata Individual male Sen	
581	Female	Crippa	Anna	Kata Individual female Sen	
582	Female	Cumbo	Greta	Kata Individual female U14	
583	Female	Nicosia	Valeria	Kata Individual female Cadets	

Entries: 6

VENETO OPEN

ITALY

2023.05.19 - 2023.05.21

Via S. Marco, 53, 35129 Padova PD

Tournament Participation (Entries) by Club

 BERRETTONI(BERRETTONI)					
ID	Sex	Family Name	Given Name	Category	
584	Female	DOMINIJANNI	ELISA	Kata Individual female U21 R2-G1	
585	Female	DOMINIJANNI	ELISA	Kata Individual female U21 R3 Gold Medal Match	
586	Female	DOMINIJANNI	ELISA	Kata Individual female Sen	
587	Female	DOMINIJANNI	ELISA	Kata Individual female U21	
588	Female	FUSCO	BENEDETTA	Kata Individual female Cadets	

Entries: 5

VENETO OPEN

ITALY

2023.05.19 - 2023.05.21

Via S. Marco, 53, 35129 Padova PD

Tournament Participation (Entries) by Club

 Bodymind Karate(Bodymind Karate)					
ID	Sex	Family Name	Given Name	Category	
589	Female	BELLINELLI	MELANIA	Kumite Individual female U21 -68	
590	Male	bertolucci	gianmarco	Kumite Individual male Juniors -76	
591	Male	Carrara	Matteo	Kumite Individual male U14 -55	
592	Male	Ciomei	Filippo	Kumite Individual male U21 -75	
593	Male	Paoletti	Mattia	Kumite Individual male Juniors -68	
594	Male	Paoletti	Niccol	Kumite Individual male Cadets -52	
595	Male	Paolini	Yari	Kumite Individual male Cadets +70	
596	Male	ungaretti	gabriele	Kumite Individual male Juniors -68	

Entries: **8**

VENETO OPEN

ITALY

2023.05.19 - 2023.05.21

Via S. Marco, 53, 35129 Padova PD

Tournament Participation (Entries) by Club

 BUDOKAN MONTELUPO(BDKMNT)					
ID	Sex	Family Name	Given Name	Category	
597	Female	BETTINI	SOFIA	Kumite Individual female Juniors +66	

Entries: 1

VENETO OPEN

ITALY

2023.05.19 - 2023.05.21

Via S. Marco, 53, 35129 Padova PD

Tournament Participation (Entries) by Club

 Budokan Portuali(BDK PRT)					
ID	Sex	Family Name	Given Name	Category	
598	Male	Lena	Corrado	Kumite Individual male Juniors +76	

Entries: 1

VENETO OPEN

ITALY

2023.05.19 - 2023.05.21

Via S. Marco, 53, 35129 Padova PD

Tournament Participation (Entries) by Club

 CENTRO KARATE RICCIONE 1(CKR 1)					
ID	Sex	Family Name	Given Name	Category	
599	Male	BAGAROLO	THOMAS	Kata Individual male Cadets	
600	Female	ORSETTI	ANNA	Kata Individual female Cadets R3-G2	
601	Female	ORSETTI	ANNA	Kata Individual female Cadets	
602	Female	ORSETTI	ANNA	Kata Individual female Cadets R2-G2	
603	Female	ORSETTI	ANNA	Kata Individual female Cadets R4 Gold Medal Match	

Entries: 5

VENETO OPEN

ITALY

2023.05.19 - 2023.05.21

Via S. Marco, 53, 35129 Padova PD

Tournament Participation (Entries) by Club

 Centro Karate Riccione (CKR ITALY)					
ID	Sex	Family Name	Given Name	Category	
604	Male	Abbruscato	Gabriele	Kata Individual male Juniors	
605	Female	Algeri	Olimpia	Kata Individual female Cadets	
606	Female	Bacchini	Chiara	Kata Individual female Sen	
607	Female	Bacchini	Chiara	Kata Individual female Juniors	
608	Female	Bacchini	Chiara	Kata Individual female Juniors R2-G1	
609	Female	Bacchini	Chiara	Kata Individual female Cadets	
610	Female	Bacchini	Chiara	Kata Individual female Cadets R2-G2	
611	Female	Cardaropoli	Isabel	Kata Individual female U14	
612	Female	Cescut	Emma	Kumite Individual female U14 -42	
613	Female	Cherubini	Sofia	Kata Individual female U21 R2-G2	
614	Female	Cherubini	Sofia	Kata Individual female U21	
615	Female	Giulianelli	Adele	Kumite Individual female U14 -42	
616	Female	Marconi	Maria	Kata Individual female Cadets R3-G1	
617	Female	Marconi	Maria	Kata Individual female Cadets R2-G1	
618	Female	Marconi	Maria	Kata Individual female Cadets	
619	Female	Marconi	Maria	Kata Individual female Cadets R4 Bronze Medal Match 1	
620	Female	Ortalli	Nina	Kata Individual female Cadets	
621	Female	Padoan	Martina	Kata Individual female Sen	
622	Female	Padoan	Martina	Kata Individual female Sen R2-G2	
623	Female	Padoan	Martina	Kata Individual female Juniors	
624	Female	Padoan	Martina	Kata Individual female Juniors R4 Gold Medal Match	
625	Female	Padoan	Martina	Kata Individual female Juniors R3-G2	
626	Female	Padoan	Martina	Kata Individual female Juniors R2-G2	
627	Female	Serinelli	Aurora	Kata Individual female Sen	
628	Female	Serinelli	Aurora	Kata Individual female Juniors	
629	Female	Serinelli	Aurora	Kata Individual female Juniors R3-G2	
630	Female	Serinelli	Aurora	Kata Individual female Juniors R2-G2	
631	Female	Vandi	Ginevra	Kumite Individual female U14 +52	
632	Male	Vesco	Natan	Kumite Individual male Juniors -76	

Entries: 29

VENETO OPEN

ITALY

2023.05.19 - 2023.05.21

Via S. Marco, 53, 35129 Padova PD

Tournament Participation (Entries) by Club



CENTRO KARATE RIMINI(CKR)

ID	Sex	Family Name	Given Name	Category
633	Male	Di Sante	Simone	Kata Individual male U14

Entries: 1

VENETO OPEN

ITALY

2023.05.19 - 2023.05.21

Via S. Marco, 53, 35129 Padova PD

Tournament Participation (Entries) by Club



CENTRO RICERCHE SPORT KARATE(CRSK)

ID	Sex	Family Name	Given Name	Category
634	Male	ZAMBOTTO	NICOLO	Kata Individual male Cadets

Entries: 1

VENETO OPEN

ITALY

2023.05.19 - 2023.05.21

Via S. Marco, 53, 35129 Padova PD

Tournament Participation (Entries) by Club

 centro sportivo farnesiana karate piacenza(karate piacenza)					
ID	Sex	Family Name	Given Name	Category	
635	Female	DALLAVALLE	EVA	Kumite Individual female U14 -52	
636	Female	GRANELLI	GAIA	Kumite Individual female U14 -47	
637	Female	LONGERI	AURORA	Kumite Individual female U14 -52	

Entries: 3

VENETO OPEN

ITALY

2023.05.19 - 2023.05.21

Via S. Marco, 53, 35129 Padova PD

Tournament Participation (Entries) by Club

 centro sportivo karate wado ryu roma(cskw roma)					
ID	Sex	Family Name	Given Name	Category	
638	Female	Caneva	Sara	Kumite Individual female Cadets -61	
639	Female	Girardi	Michela	Kumite Individual female Juniors -66	
640	Female	Punta	Micaela	Kata Individual female Cadets R2-G1	
641	Female	Punta	Micaela	Kata Individual female Cadets	
642	Female	Punta	Micaela	Kata Individual female Cadets R3-G1	
643	Male	Zalla	Alessandro	Kumite Individual male U14 -40	

Entries: 6

VENETO OPEN

ITALY

2023.05.19 - 2023.05.21

Via S. Marco, 53, 35129 Padova PD

Tournament Participation (Entries) by Club

 CENTRO YOSHITAKA (CENTRO YOSHITAKA)					
ID	Sex	Family Name	Given Name	Category	
644	Male	DAFFLITTO	PIETRO	Kumite Individual male U21 -75	
645	Male	NEGRIZZOLO	PIETRO	Kumite Individual male U14 -55	
646	Male	OSTI	FABRIZIO	Kumite Individual male Seniors -75	
647	Male	OSTI	FABRIZIO	Kumite Individual male U21 -75	
648	Female	Sofrone	Denisa Mihaela	Kumite Individual female U14 +52	
649	Female	XU	DUO	Kumite Individual female Cadets -61	

Entries: 6

VENETO OPEN

ITALY

2023.05.19 - 2023.05.21

Via S. Marco, 53, 35129 Padova PD

Tournament Participation (Entries) by Club

 Cesanelli(Cesanelli)					
ID	Sex	Family Name	Given Name	Category	
650	Female	Cesanelli	Giada	Kumite Individual female Seniors -61	

Entries: 1

VENETO OPEN

ITALY

2023.05.19 - 2023.05.21

Via S. Marco, 53, 35129 Padova PD

Tournament Participation (Entries) by Club



CKS KARATE CERTALDO(CKS)

ID	Sex	Family Name	Given Name	Category
651	Female	Cianti	Giulia	Kumite Individual female Cadets -54

Entries: 1

VENETO OPEN

ITALY

2023.05.19 - 2023.05.21

Via S. Marco, 53, 35129 Padova PD

Tournament Participation (Entries) by Club

 CLUB ARTI ORIENTALI CANTU asd(CAO CANTU)					
ID	Sex	Family Name	Given Name	Category	
652	Female	CATTANEO	ELISA	Kumite Individual female Cadets -61	
653	Female	Gandola	Greta	Kumite Individual female Cadets -47	
654	Female	GANDOLA	VIOLA	Kumite Individual female Cadets -54	
655	Male	GIULIANO	SIMONE	Kumite Individual male U14 +55	

Entries: 4

VENETO OPEN

ITALY

2023.05.19 - 2023.05.21

Via S. Marco, 53, 35129 Padova PD

Tournament Participation (Entries) by Club

 CRS AKIYAMA Settimo(CRS AKIYAMA Settimo)					
ID	Sex	Family Name	Given Name	Category	
656	Male	Acerra	Federico	Kumite Individual male Cadets -52	
657	Male	Lio	Matteo	Kumite Individual male Juniors -68	

Entries: 2

VENETO OPEN

ITALY

2023.05.19 - 2023.05.21

Via S. Marco, 53, 35129 Padova PD

Tournament Participation (Entries) by Club

 CSCARABINIERI(CSCARABINIERI)					
ID	Sex	Family Name	Given Name	Category	
658	Male	Morandi	Alessandro	Kumite Individual male Juniors -68	

Entries: 1

VENETO OPEN

ITALY

2023.05.19 - 2023.05.21

Via S. Marco, 53, 35129 Padova PD

Tournament Participation (Entries) by Club

 CSKT KARATE TEAM(C.S.K.T. JGOR CARTA)					
ID	Sex	Family Name	Given Name	Category	
659	Female	carta	beatrice	Kumite Individual female Juniors -59	
660	Female	gatta	ilaria	Kumite Individual female Cadets -61	
661	Female	prinzio	gaia	Kumite Individual female Cadets -47	

Entries: 3

VENETO OPEN

ITALY

2023.05.19 - 2023.05.21

Via S. Marco, 53, 35129 Padova PD

Tournament Participation (Entries) by Club

 DYNAMIC KARATE ASD(DK ASD)					
ID	Sex	Family Name	Given Name	Category	
662	Male	CARUANA	LORENZO	Kumite Individual male Seniors -67	
663	Male	CARUANA	LORENZO	Kumite Individual male U21 -67	

Entries: 2

VENETO OPEN

ITALY

2023.05.19 - 2023.05.21

Via S. Marco, 53, 35129 Padova PD

Tournament Participation (Entries) by Club

 EAGLES CLUB 2007(EAG)					
ID	Sex	Family Name	Given Name	Category	
664	Male	Rizzo	Alessandro	Kumite Individual male Cadets +70	

Entries: 1

VENETO OPEN

ITALY

2023.05.19 - 2023.05.21

Via S. Marco, 53, 35129 Padova PD

Tournament Participation (Entries) by Club

 Energia in movimento SSD ARL(Energia in movimento PESCARA)					
ID	Sex	Family Name	Given Name	Category	
665	Female	FEBO	MELISSA	Kumite Individual female Seniors +68	

Entries: 1

VENETO OPEN

ITALY

2023.05.19 - 2023.05.21

Via S. Marco, 53, 35129 Padova PD

Tournament Participation (Entries) by Club

 Etruria karate(E.K)					
ID	Sex	Family Name	Given Name	Category	
666	Female	Machetti	Irene	Kata Individual female Sen	
667	Female	Machetti	Irene	Kata Individual female Juniors	

Entries: 2

VENETO OPEN

ITALY

2023.05.19 - 2023.05.21

Via S. Marco, 53, 35129 Padova PD

Tournament Participation (Entries) by Club

 FIGHT CLUB (FCK)					
ID	Sex	Family Name	Given Name	Category	
668	Male	GELOSI	LORENZO	Kumite Individual male U14 -50	
669	Male	NASSO	ANDREA	Kumite Individual male U14 +55	

Entries: 2

VENETO OPEN

ITALY

2023.05.19 - 2023.05.21

Via S. Marco, 53, 35129 Padova PD

Tournament Participation (Entries) by Club

 FORZA E COSTANZA - BRESCIA(F & C)					
ID	Sex	Family Name	Given Name	Category	
670	Female	DUCA	GIORGIA	Kumite Individual female Juniors -59	
671	Male	DUCA	LEONARDO	Kumite Individual male Cadets -52	
672	Female	Guerini	Anna	Kumite Individual female U21 -55	
673	Female	Pelucco	Chiara	Kumite Individual female U14 -52	
674	Male	Pelucco	Cristian	Kumite Individual male Cadets -63	
675	Female	SESSA	CHIARA	Kumite Individual female U14 +52	
676	Female	Simonini	Valentina	Kumite Individual female U21 -68	
677	Female	Vitali	Veronica	Kumite Individual female U21 -50	
678	Female	Zucco	Allegra	Kumite Individual female Cadets +61	

Entries: 9

VENETO OPEN

ITALY

2023.05.19 - 2023.05.21

Via S. Marco, 53, 35129 Padova PD

Tournament Participation (Entries) by Club

 FUNAKOSHI 1976 asd(funakoshi CANDELO)					
ID	Sex	Family Name	Given Name	Category	
679	Male	GARRIONE	GIOVANNI	Kumite Individual male Cadets -57	
680	Male	GOZZI	CARLO	Kumite Individual male Juniors -55	
681	Male	NUCCIO	DAVIDE	Kumite Individual male Juniors -55	
682	Male	SALUSSOLIA	FRANCESCO	Kumite Individual male Cadets -70	
683	Male	SASSO	STEFANO	Kumite Individual male Juniors -61	
684	Male	SPILINGA	CHRISTIAN	Kumite Individual male Cadets -52	

Entries: 6

VENETO OPEN

ITALY

2023.05.19 - 2023.05.21

Via S. Marco, 53, 35129 Padova PD

Tournament Participation (Entries) by Club

 Funakoshi Milano(Funakoshi Milano)					
ID	Sex	Family Name	Given Name	Category	
685	Male	ZANGELIDIS	CHRISTOS	Kata Individual male Sen	

Entries: 1

VENETO OPEN

ITALY

2023.05.19 - 2023.05.21

Via S. Marco, 53, 35129 Padova PD

Tournament Participation (Entries) by Club

G.S.FF.OO. POLIZIA DI STATO(F.F.OO. POLIZIA DI STATO)				
ID	Sex	Family Name	Given Name	Category
686	Male	ANGELONI	ALESSANDRO	Kumite Individual male Juniors -61
687	Male	BARONE	MARCO VALERIO	Kumite Individual male Cadets -63
688	Female	BENCIVENGA	FRANCESCA	Kata Individual female Cadets
689	Male	CASALINI	YARI	Kumite Individual male Juniors -68
690	Male	CHILELLI	RICCARDO	Kumite Individual male Cadets -52
691	Male	D'IGLIO	MICHELE	Kumite Individual male Juniors -61
692	Female	DE ANGELIS	MARTINA	Kumite Individual female U21 -50
693	Female	DE FALCO	ASIA	Kumite Individual female Juniors -48
694	Male	DI LAZZARO	LEONARDO	Kata Individual male Cadets R2-G1
695	Male	DI LAZZARO	LEONARDO	Kata Individual male Cadets
696	Male	DI LAZZARO	LEONARDO	Kata Individual male Cadets R3-G1
697	Male	DI NOIA	MARCO	Kumite Individual male Juniors -61
698	Female	Garofoli	Sofia	Kata Individual female Sen R2-G2
699	Female	Garofoli	Sofia	Kata Individual female Sen R4 Bronze Medal Match 1
700	Female	Garofoli	Sofia	Kata Individual female Sen R3-G2
701	Female	Garofoli	Sofia	Kata Individual female Sen
702	Male	GASPARINI	VALERIO	Kumite Individual male U14 -40
703	Male	Grazia	Manuel	Kata Individual male Sen R2-G2
704	Male	Grazia	Manuel	Kata Individual male Sen
705	Male	Grazia	Manuel	Kata Individual male U21 R2-G1
706	Male	Grazia	Manuel	Kata Individual male Sen R4 Gold Medal Match
707	Male	Grazia	Manuel	Kata Individual male U21
708	Male	Grazia	Manuel	Kata Individual male Sen R3-G2
709	Male	Grazia	Manuel	Kata Individual male U21 R3 Bronze Medal Match 1
710	Female	GRAZIA	NICOL	Kata Individual female Juniors R2-G1
711	Female	GRAZIA	NICOL	Kata Individual female Juniors
712	Female	GRAZIANI	DIANA	Kumite Individual female U14 -42
713	Male	MANCINI	FABIO	Kumite Individual male Cadets -63
714	Male	MATACCHIONI	LUIGI	Kata Individual male Sen R2-G1
715	Male	MATACCHIONI	LUIGI	Kata Individual male Juniors R4 Gold Medal Match
716	Male	MATACCHIONI	LUIGI	Kata Individual male Juniors R3-G1
717	Male	MATACCHIONI	LUIGI	Kata Individual male Sen
718	Male	MATACCHIONI	LUIGI	Kata Individual male Juniors R2-G1
719	Male	MATACCHIONI	LUIGI	Kata Individual male Juniors
720	Male	MATACCHIONI	LUIGI	Kata Individual male Sen R3-G1
721	Male	MATACCHIONI	LUIGI	Kata Individual male Sen R4 Bronze Medal Match 2
722	Male	Miranda	Mario	Kata Individual male U21
723	Female	ONORI	SOFIA	Kumite Individual female U14 +52
724	Male	PANAGIA	GIUSEPPE	Kata Individual male Sen R4 Bronze Medal Match 2
725	Male	PANAGIA	GIUSEPPE	Kata Individual male Sen R3-G2
726	Male	PANAGIA	GIUSEPPE	Kata Individual male Sen R2-G2
727	Male	PANAGIA	GIUSEPPE	Kata Individual male Sen
728	Male	PARISI	Lorenzo	Kumite Individual male Seniors -84

VENETO OPEN

ITALY

2023.05.19 - 2023.05.21

Via S. Marco, 53, 35129 Padova PD

Tournament Participation (Entries) by Club

729	Male	PARISI	Lorenzo	Kumite Individual male U21 -84
730	Male	Polsinelli	Guido	Kata Individual male Sen R2-G1
731	Male	Polsinelli	Guido	Kata Individual male U21 R3 Gold Medal Match
732	Male	Polsinelli	Guido	Kata Individual male Sen
733	Male	Polsinelli	Guido	Kata Individual male U21 R2-G2
734	Male	Polsinelli	Guido	Kata Individual male Sen R4 Bronze Medal Match 1
735	Male	Polsinelli	Guido	Kata Individual male U21
736	Male	Polsinelli	Guido	Kata Individual male Sen R3-G1
737	Male	PROIETTI	Simone	Kumite Individual male Juniors -76
738	Male	ROSIELLO	GIUSEPPE	Kata Individual male Juniors
739	Male	ROSIELLO	GIUSEPPE	Kata Individual male Juniors R2-G2
740	Male	ROSIELLO	GIUSEPPE	Kata Individual male Juniors R4 Bronze Medal Match 2
741	Male	ROSIELLO	GIUSEPPE	Kata Individual male Juniors R3-G2
742	Female	ROSSI	Giulia	Kata Individual female Juniors R3-G2
743	Female	ROSSI	Giulia	Kata Individual female Juniors R4 Bronze Medal Match 2
744	Female	ROSSI	Giulia	Kata Individual female Juniors R2-G2
745	Female	ROSSI	Giulia	Kata Individual female Sen R3-G1
746	Female	ROSSI	Giulia	Kata Individual female Sen R2-G1
747	Female	ROSSI	Giulia	Kata Individual female Sen
748	Female	ROSSI	Giulia	Kata Individual female Juniors
749	Male	SANTUCCI	DARIO	Kumite Individual male Cadets -63
750	Female	SCLERANDI	NOEMI	Kumite Individual female Juniors -53
751	Female	SERVETTO	THEA	Kumite Individual female U14 -42
752	Female	Tagliaferro	Chiara	Kata Individual female Sen R3-G2
753	Female	Tagliaferro	Chiara	Kata Individual female Sen
754	Female	Tagliaferro	Chiara	Kata Individual female Sen R2-G2
755	Female	Tagliaferro	Chiara	Kata Individual female U21
756	Female	Tagliaferro	Chiara	Kata Individual female U21 R3 Gold Medal Match
757	Female	Tagliaferro	Chiara	Kata Individual female U21 R2-G2
758	Male	VACCA	MATTEO	Kumite Individual male U14 -40
759	Male	VENTIMIGLIA	Devid	Kumite Individual male U14 -40

Entries: 74

VENETO OPEN

ITALY

2023.05.19 - 2023.05.21

Via S. Marco, 53, 35129 Padova PD

Tournament Participation (Entries) by Club

 G.S.FIAMME CREMISI BERSAGLIERI FOGGIA(Fiamme Cremisi Bersaglieri)					
ID	Sex	Family Name	Given Name	Category	
760	G.S. Fiamme Cremisi Bersaglieri Foggia	Female	BLASI	Gabriella	Kumite Individual female U14 -47
761	G.S. Fiamme Cremisi Bersaglieri Foggia	Male	Buonfiglio	Alessandro	Kumite Individual male Cadets -70
762	G.S. Fiamme Cremisi Bersaglieri Foggia	Female	Buonfiglio	Roberta	Kumite Individual female U14 -42
763	G.S. Fiamme Cremisi Bersaglieri Foggia	Male	Colecchia	Daniele	Kumite Individual male Juniors -76
764	G.S. Fiamme Cremisi Bersaglieri Foggia	Male	Galasso	Emanuele	Kumite Individual male U14 -55
765	G.S. Fiamme Cremisi Bersaglieri Foggia	Male	Rossiniello	Kevin Pio	Kumite Individual male U14 +55

Entries: 6

VENETO OPEN

ITALY

2023.05.19 - 2023.05.21

Via S. Marco, 53, 35129 Padova PD

Tournament Participation (Entries) by Club

 Gin. Angel Fiumicino(Gin. Angel)					
ID	Sex	Family Name	Given Name	Category	
766	Female	DANGELO	ELISA	Kumite Individual female Seniors -50	
767	Female	DANGELO	ELISA	Kumite Individual female U21 -50	
768	Female	FERRI	AURORA	Kumite Individual female Seniors +68	
769	Female	FERRI	AURORA	Kumite Individual female U21 +68	

Entries: 4

VENETO OPEN

ITALY

2023.05.19 - 2023.05.21

Via S. Marco, 53, 35129 Padova PD

Tournament Participation (Entries) by Club

 Golden Tiger Team Karate - Muay Thai(GTTK)					
ID	Sex	Family Name	Given Name	Category	
770	Male	DEL SEPPIA	GIACOMO	Kumite Individual male U14 +55	
771	Female	FERRA	EMMA	Kata Individual female Cadets	
772	Male	GIACOMELLI	DANIELE	Kumite Individual male Juniors -76	
773	Male	MACCIONI SANTINI	NICCOLO	Kumite Individual male U14 -50	

Entries: 4

VENETO OPEN

ITALY

2023.05.19 - 2023.05.21

Via S. Marco, 53, 35129 Padova PD

Tournament Participation (Entries) by Club

 Istituto Karate Shotokan Sondrio(IKS Sondrio)					
ID	Sex	Family Name	Given Name	Category	
774	Female	Poli	Greta	Kata Individual female Juniors	
775	Female	Poli	Greta	Kata Individual female Juniors R2-G1	
776	Female	Tagliabue	Silvia	Kata Individual female Cadets R2-G1	
777	Female	Tagliabue	Silvia	Kata Individual female Cadets	

Entries: 4

VENETO OPEN

ITALY

2023.05.19 - 2023.05.21

Via S. Marco, 53, 35129 Padova PD

Tournament Participation (Entries) by Club

 JKS CASTANO PRIMO(JKS)					
ID	Sex	Family Name	Given Name	Category	
778	Male	Barbi	Simone	Kata Individual male Sen	
779	Male	Barbi	Simone	Kata Individual male U21	
780	Female	Battioli	Elisa	Kata Individual female Sen	
781	Female	Battioli	Elisa	Kata Individual female U21	
782	Male	Carugati	Cristian	Kata Individual male Juniors	
783	Male	Carugati	Cristian	Kata Individual male Juniors R2-G2	
784	Male	Carugati	Cristian	Kata Individual male Sen	

Entries: 7

VENETO OPEN

ITALY

2023.05.19 - 2023.05.21

Via S. Marco, 53, 35129 Padova PD

Tournament Participation (Entries) by Club

 KAIGI KARATE FITNESS A.S.D.(KAIGI KARATE)					
ID	Sex	Family Name	Given Name	Category	
785	Female	ACQUATI	MICOLE	Kata Individual female U21	
786	Female	Audia	Asia	Kata Individual female U14 R3 Gold Medal Match	
787	Female	Audia	Asia	Kata Individual female U14 R2-G2	
788	Female	Audia	Asia	Kata Individual female U14	
789	Male	BELLASIO	SEBASTIANO	Kata Individual male Juniors	

Entries: 5

VENETO OPEN

ITALY

2023.05.19 - 2023.05.21

Via S. Marco, 53, 35129 Padova PD

Tournament Participation (Entries) by Club

 Karate Alto Vicentino (K. A. V.)					
ID	Sex	Family Name	Given Name	Category	
790	Male	Di Franco	Nicol	Kumite Individual male Cadets -52	
791	Female	Roncaglia	Giulia	Kumite Individual female Cadets +61	
792	Female	Roncaglia	Maria	Kumite Individual female U14 +52	
793	Male	Zaccaria	Andrea	Kumite Individual male U21 -67	
794	Male	Zaccaria	Nicol Flavio	Kumite Individual male Juniors -61	

Entries: 5

VENETO OPEN

ITALY

2023.05.19 - 2023.05.21

Via S. Marco, 53, 35129 Padova PD

Tournament Participation (Entries) by Club

 Karate Baldassarre(Baldassarre)					
ID	Sex	Family Name	Given Name	Category	
795	Male	Baldassarre	Raffaele	Kumite Individual male U14 -50	
796	Male	Cantone	Luigi	Kumite Individual male U14 -40	
797	Female	Golino	Simonetta	Kata Individual female Sen R2-G1	
798	Female	Golino	Simonetta	Kata Individual female Sen	
799	Male	Martinelli	Alessandro	Kata Individual male Cadets	
800	Male	Muni	Alessandro	Kata Individual male Cadets	
801	Female	Ricciardi	Angela	Kata Individual female U14 R2-G2	
802	Female	Ricciardi	Angela	Kata Individual female U14	
803	Male	Tartaglione	Gaetano Pio	Kata Individual male Cadets	
804	Male	Vastano	Michele	Kata Individual male Cadets	

Entries: **10**

VENETO OPEN

ITALY

2023.05.19 - 2023.05.21

Via S. Marco, 53, 35129 Padova PD

Tournament Participation (Entries) by Club

KARATE BORBIAGO VE(KRT BORBIAGO)					
ID	Sex	Family Name	Given Name	Category	
805	Male	MONICO	LEONARDO	Kumite Individual male U14 -45	

Entries: 1

VENETO OPEN

ITALY

2023.05.19 - 2023.05.21

Via S. Marco, 53, 35129 Padova PD

Tournament Participation (Entries) by Club

 KARATE CAMUNO CHINTE(KCC)					
ID	Sex	Family Name	Given Name	Category	
806	Male	MONDINI	LUCA	Kumite Individual male Cadets -70	
807	Male	ZANELLI	FILIPPO	Kumite Individual male Juniors -68	

Entries: 2

VENETO OPEN

ITALY

2023.05.19 - 2023.05.21

Via S. Marco, 53, 35129 Padova PD

Tournament Participation (Entries) by Club

 KARATE CLUB SAVONA (KCS - LIGURIA KARATE)					
ID	Sex	Family Name	Given Name	Category	
808	Male	Braja	Gabriele	Kumite Individual male Juniors -68	
809	Female	Brignone	Giorgia	Kumite Individual female Juniors -48	
810	Male	CALEFFI	ALESSIO	Kumite Individual male U21 -75	
811	Female	Campo	Arianna	Kumite Individual female U14 -42	
812	Male	Campo	Francesco	Kumite Individual male U14 -50	
813	Female	Catona	Silvia	Kumite Individual female Cadets -47	
814	Female	DE ROSA	NOEMI	Kumite Individual female Seniors -55	
815	Male	Domi	Saimon	Kumite Individual male Cadets -70	
816	Male	Ferraris	Giacomo	Kumite Individual male U14 -40	
817	Female	FIUME	MATILDE	Kumite Individual female Cadets -54	
818	Male	Fornari	ALESSANDRO	Kumite Individual male U14 -45	
819	Female	Galati	Vittoria	Kumite Individual female U14 -42	
820	Male	GENTA	JACOPO	Kumite Individual male Cadets -57	
821	Female	GENTA	MICOL	Kumite Individual female Juniors -48	
822	Female	Giordani	Paola	Kumite Individual female Juniors -66	
823	Male	MAGNANI	RICCARDO	Kumite Individual male Cadets +70	
824	Female	Marenco	Maya	Kumite Individual female U14 -52	
825	Male	MONDO BRANCHI	MATTEO	Kumite Individual male Cadets -52	
826	Female	MUSSO	ROBERTA	Kumite Individual female Cadets -61	
827	Male	ODELLO	ANDREA	Kumite Individual male Juniors -61	
828	Male	Pica	Gian Lorenzo	Kumite Individual male Juniors -68	
829	Female	ROVERE	LISA	Kumite Individual female U14 -42	
830	Male	SERGI	ELIA	Kumite Individual male Juniors -68	
831	Male	TESTA	DANIELE	Kumite Individual male Cadets +70	

Entries: 24

VENETO OPEN

ITALY

2023.05.19 - 2023.05.21

Via S. Marco, 53, 35129 Padova PD

Tournament Participation (Entries) by Club

 karate colli euganei(kce)					
ID	Sex	Family Name	Given Name	Category	
832	Male	bertazzo	alberto	Kumite Individual male U14 +55	
833	Male	Bortoliero	Manuel	Kumite Individual male U14 -45	
834	Female	castello	annie	Kumite Individual female Cadets -61	

Entries: 3

VENETO OPEN

ITALY

2023.05.19 - 2023.05.21

Via S. Marco, 53, 35129 Padova PD

Tournament Participation (Entries) by Club

 Karate Doschi Ass.ne sportiva dilettantistica(Karate Doschi A.S.D.)					
ID	Sex	Family Name	Given Name	Category	
835	Female	Federici	Carola	Kumite Individual female Juniors -48	

Entries: 1

VENETO OPEN

ITALY

2023.05.19 - 2023.05.21

Via S. Marco, 53, 35129 Padova PD

Tournament Participation (Entries) by Club

 karate lion (karate lion)					
ID	Sex	Family Name	Given Name	Category	
836	Male	Baldassarre	Samuel Vincenzo	Kumite Individual male U14 -40	
837	Male	Testa	Alessandro	Kumite Individual male U14 -45	

Entries: 2

VENETO OPEN

ITALY

2023.05.19 - 2023.05.21

Via S. Marco, 53, 35129 Padova PD

Tournament Participation (Entries) by Club

 Karate Nakayama(Karate Nakayama)					
ID	Sex	Family Name	Given Name	Category	
838	Male	BONOMETTI	ARTURO	Kumite Individual male U14 -55	
839	Male	CARNEVALE	FRANCESCO	Kumite Individual male Juniors -55	
840	Male	CERQUI	STEFANO	Kumite Individual male U14 -55	
841	Female	Cornol	Giada	Kumite Individual female Juniors -66	
842	Female	Elwardany	Giana	Kumite Individual female Cadets -47	
843	Female	FAPPIANO	ELENA	Kumite Individual female Cadets -54	
844	Female	GIACOMINI	SOPHIA	Kumite Individual female U14 -42	
845	Female	GOFFI	AMBRA	Kumite Individual female Juniors -59	
846	Female	GORRIN	EMMA	Kumite Individual female U14 -52	
847	Male	HUSSAIN	MOHAMMAD DANISH	Kumite Individual male U14 -40	
848	Female	Ndiaye	Aminata	Kumite Individual female Cadets -61	
849	Male	PIEMONTE	GABRIEL	Kumite Individual male Juniors -55	
850	Male	POPOV	CATALIN	Kumite Individual male Cadets -57	
851	Male	PORTESI	GABRIELE	Kumite Individual male Juniors +76	
852	Female	Rivadossi	Greta	Kumite Individual female U21 -55	

Entries: 15

VENETO OPEN

ITALY

2023.05.19 - 2023.05.21

Via S. Marco, 53, 35129 Padova PD

Tournament Participation (Entries) by Club

 Karate Polisportiva Brembate Sopra(KBS)					
ID	Sex	Family Name	Given Name	Category	
853	Male	Capelli	Riccardo	Kumite Individual male U14 -55	
854	Female	Guerrini	Alice	Kumite Individual female Seniors -68	
855	Female	Guerrini	Alice	Kumite Individual female U21 -68	
856	Male	Mazzoleni	Fabio	Kumite Individual male Seniors +84	
857	Male	RAVASIO	MATTIA	Kumite Individual male U14 +55	

Entries: 5

VENETO OPEN

ITALY

2023.05.19 - 2023.05.21

Via S. Marco, 53, 35129 Padova PD

Tournament Participation (Entries) by Club

 KARATE POZZUOLO(KARATE POZZUOLO)					
ID	Sex	Family Name	Given Name	Category	
858	Male	AGLIANO	SAMUELE	Kumite Individual male Seniors -60	
859	Male	AGLIANO	SAMUELE	Kumite Individual male U21 -60	
860	Female	BOCCHIOLA	NOEMI	Kumite Individual female Cadets +61	
861	Male	FERRIERI	ALBERTO	Kumite Individual male Cadets -63	
862	Male	FERRIERI	GIUSEPPE	Kumite Individual male Cadets -63	
863	Female	GAMBA	BEATRICE	Kumite Individual female Juniors -59	
864	Male	GARDINI	CHRISTIAN	Kumite Individual male U14 -40	
865	Male	MALANGONE	ALESSANDRO	Kumite Individual male Juniors -61	
866	Female	PASIN	MATILDE	Kumite Individual female U14 +52	
867	Female	pavone	sofia	Kumite Individual female U14 -42	
868	Male	zanni	federico	Kumite Individual male Cadets -57	

Entries: 11

VENETO OPEN

ITALY

2023.05.19 - 2023.05.21

Via S. Marco, 53, 35129 Padova PD

Tournament Participation (Entries) by Club

 KARATE SANSEPOLCRO(KARATE SANSEPOLCRO)					
ID	Sex	Family Name	Given Name	Category	
869	Male	AMATI	ANDREA	Kumite Individual male Cadets -70	
870	Male	BETTI	MASSIMO	Kumite Individual male U14 -40	
871	Male	CASCIANINI	FILIPPO	Kumite Individual male U14 +55	
872	Male	EVACUO	CRISTIAN	Kumite Individual male U14 -45	
873	Male	MARINI	AMON	Kumite Individual male U14 -45	
874	Female	VALENTINI	GRETA	Kumite Individual female Cadets -54	

Entries: 6

VENETO OPEN

ITALY

2023.05.19 - 2023.05.21

Via S. Marco, 53, 35129 Padova PD

Tournament Participation (Entries) by Club

 Karate Sporting Team(KSTKST)					
ID	Sex	Family Name	Given Name	Category	
875	Female	Lugato	Maria Sofia	Kumite Individual female Juniors +66	
876	Male	Rorato	Tommaso	Kumite Individual male U14 +55	
877	Male	Sette	Giacomo	Kumite Individual male Juniors -61	

Entries: 3

VENETO OPEN

ITALY

2023.05.19 - 2023.05.21

Via S. Marco, 53, 35129 Padova PD

Tournament Participation (Entries) by Club

 Karate Team Dolomiti(KTDolomiti)					
ID	Sex	Family Name	Given Name	Category	
878	Female	Masoch	Mariachiara	Kumite Individual female Juniors -48	

Entries: 1

VENETO OPEN

ITALY

2023.05.19 - 2023.05.21

Via S. Marco, 53, 35129 Padova PD

Tournament Participation (Entries) by Club

 karate trento asd(ktn)					
ID	Sex	Family Name	Given Name	Category	
879	Female	CAPITANIO	MATILDE	Kumite Individual female Juniors -59	
880	Male	Redjepi	Arian	Kumite Individual male U21 -60	
881	Female	Sadler	Claudia	Kumite Individual female Cadets -61	
882	Female	Sadler	Giulia	Kumite Individual female Juniors +66	
883	Male	Sera	Simone	Kumite Individual male U14 -55	

Entries: 5

VENETO OPEN

ITALY

2023.05.19 - 2023.05.21

Via S. Marco, 53, 35129 Padova PD

Tournament Participation (Entries) by Club

 Kyohan Simmi(Kyohan)					
ID	Sex	Family Name	Given Name	Category	
884	Male	De Chirico	Paolo	Kumite Individual male U21 -75	
885	Male	Romanini	Giorgio	Kumite Individual male Seniors +84	
886	Male	Romanini	Giorgio	Kumite Individual male U21 +84	

Entries: 3

VENETO OPEN

ITALY

2023.05.19 - 2023.05.21

Via S. Marco, 53, 35129 Padova PD

Tournament Participation (Entries) by Club

 LIFE CHAMPION MADDALONI(L.C.M)					
ID	Sex	Family Name	Given Name	Category	
887	Male	BRASILE	ANTONIO	Kata Individual male Cadets	
888	Male	SALAMITI	GIUSEPPE	Kata Individual male Cadets	

Entries: 2

VENETO OPEN

ITALY

2023.05.19 - 2023.05.21

Via S. Marco, 53, 35129 Padova PD

Tournament Participation (Entries) by Club

 LIGURIA_KARATE_FUNAKOSHI_LA_SPEZIA(LIG_KA_FUN_SP)					
ID	Sex	Family Name	Given Name	Category	
889	Female	GIOVANARDI	ASIA	Kumite Individual female Cadets -61	
890	Female	HERRERA MORALES	BEATRICE	Kumite Individual female Cadets +61	
891	Male	LONGO	ANDREA	Kumite Individual male U14 -40	
892	Male	LONGO	ANTONINO	Kumite Individual male U21 -67	
893	Female	MAGGIO	ELEONORA	Kumite Individual female U14 +52	
894	Female	PICCARDI	AMBRA	Kumite Individual female Cadets -61	
895	Female	PICCARDI	DILETTA	Kumite Individual female U14 -42	
896	Female	SANTI	NOEMI	Kumite Individual female U21 +68	
897	Female	VAUCHELLE	ELISA	Kumite Individual female Cadets -54	

Entries: 9

VENETO OPEN

ITALY

2023.05.19 - 2023.05.21

Via S. Marco, 53, 35129 Padova PD

Tournament Participation (Entries) by Club

 Luciano Baderna(Shinanban K.)					
ID	Sex	Family Name	Given Name	Category	
898	Female	Ballestrieri	Camilla	Kumite Individual female Seniors +68	
899	Female	Ballestrieri	Sofia	Kumite Individual female Juniors -59	
900	Male	Guarino	Andrea	Kumite Individual male Cadets -52	
901	Female	Miceli	Nicole	Kumite Individual female Seniors -50	
902	Male	Montanari	Valerio	Kumite Individual male Cadets -70	

Entries: 5

VENETO OPEN

ITALY

2023.05.19 - 2023.05.21

Via S. Marco, 53, 35129 Padova PD

Tournament Participation (Entries) by Club

 MASTER RAPID SKF CBL(MASTER RAPID SKF CBL)				
ID	Sex	Family Name	Given Name	Category
903	Male	Andreoli	Simone	Kumite Individual male Cadets -70
904	Male	Barletta	Leonardo	Kata Individual male Sen R2-G1
905	Male	Barletta	Leonardo	Kata Individual male Sen
906	Male	Barletta	Leonardo	Kata Individual male U21
907	Female	BIANCHINI	ELISON	Kata Individual female U21
908	Male	BOMBARDI	LEONARDO	Kata Individual male Juniors R3-G2
909	Male	BOMBARDI	LEONARDO	Kata Individual male Sen
910	Male	BOMBARDI	LEONARDO	Kata Individual male Juniors
911	Male	BOMBARDI	LEONARDO	Kata Individual male Juniors R2-G2
912	Male	BOMBARDI	LEONARDO	Kata Individual male Sen R2-G1
913	Male	BOMBARDI	LEONARDO	Kata Individual male Juniors R4 Bronze Medal Match 1
914	Female	BORGHESI	MATILDA	Kumite Individual female Cadets -61
915	Female	BRAMBILLA	CHIARA	Kata Individual female Juniors R2-G2
916	Female	BRAMBILLA	CHIARA	Kata Individual female Sen
917	Female	BRAMBILLA	CHIARA	Kata Individual female Juniors
918	Female	BRESCIANI	LARA	Kata Individual female U21
919	Male	Calabrese	Filippo	Kata Individual male Cadets R4 Gold Medal Match
920	Male	Calabrese	Filippo	Kata Individual male Cadets R3-G2
921	Male	Calabrese	Filippo	Kata Individual male Cadets R2-G2
922	Male	Calabrese	Filippo	Kata Individual male Cadets
923	Female	CALDI	ARIANNA	Kata Individual female U21
924	Female	CALDI	ARIANNA	Kata Individual female Sen
925	Male	CALDI	LEONARDO	Kata Individual male Sen
926	Male	CALDI	LEONARDO	Kata Individual male Juniors
927	Male	CALDI	LEONARDO	Kata Individual male Juniors R2-G2
928	Male	Calvi	Filippo	Kata Individual male Juniors R2-G1
929	Male	Calvi	Filippo	Kata Individual male Juniors
930	Female	Cherouaqi	Basma	Kumite Individual female Cadets -61
931	Male	Di Pucchio	Roberto	Kata Individual male Cadets
932	Male	Di Pucchio	Roberto	Kata Individual male Cadets R2-G2
933	Male	DIPAOLA	DIEGO	Kata Individual male U14
934	Male	EDERAR	KARIM	Kata Individual male Sen R2-G2
935	Male	EDERAR	KARIM	Kata Individual male Juniors R3-G1
936	Male	EDERAR	KARIM	Kata Individual male Juniors R4 Bronze Medal Match 2
937	Male	EDERAR	KARIM	Kata Individual male Sen
938	Male	EDERAR	KARIM	Kata Individual male Juniors R2-G1
939	Male	EDERAR	KARIM	Kata Individual male Juniors
940	Male	EDERAR	KARIM	Kata Individual male Sen R3-G2
941	Female	EDERAR	MIRIAM	Kata Individual female Juniors R2-G1
942	Female	EDERAR	MIRIAM	Kata Individual female Juniors R4 Bronze Medal Match 2
943	Female	EDERAR	MIRIAM	Kata Individual female Sen R4 Gold Medal Match
944	Female	EDERAR	MIRIAM	Kata Individual female Sen R3-G2
945	Female	EDERAR	MIRIAM	Kata Individual female Sen
946	Female	EDERAR	MIRIAM	Kata Individual female Sen R2-G2

VENETO OPEN

ITALY

2023.05.19 - 2023.05.21

Via S. Marco, 53, 35129 Padova PD

Tournament Participation (Entries) by Club

947	Female	EDERAR	MIRIAM	Kata Individual female Juniors R3-G1
948	Female	EDERAR	MIRIAM	Kata Individual female Juniors
949	Male	FEDERICI	LORENZO	Kumite Individual male Juniors -76
950	Male	FERRI	DANIELE	Kumite Individual male U14 -55
951	Male	FERRI	DANIELE	Kata Individual male U14
952	Male	Foglieni	Gabriele	Kata Individual male U21 R2-G2
953	Male	Foglieni	Gabriele	Kata Individual male U21
954	Male	Foglieni	Gabriele	Kata Individual male Sen
955	Female	FRIGENI	MICHELA	Kata Individual female U14 R3 Bronze Medal Match 2
956	Female	FRIGENI	MICHELA	Kata Individual female U14 R2-G2
957	Female	FRIGENI	MICHELA	Kata Individual female U14
958	Male	GAVIOLI	CLAUDIO	Kata Individual male U21
959	Male	LANDI	MATTEO	Kumite Individual male Seniors -60
960	Female	MAESTRI	ERIKA	Kata Individual female U21
961	Female	MAESTRI	ERIKA	Kata Individual female Sen
962	Male	Maffolini	Alessandro	Kumite Individual male U14 +55
963	Male	MORETTI	EROS	Kata Individual male U14 R3 Bronze Medal Match 1
964	Male	MORETTI	EROS	Kata Individual male U14
965	Male	MORETTI	EROS	Kata Individual male U14 R2-G1
966	Male	Moretti	Oscar	Kata Individual male Cadets
967	Male	Moretti	Oscar	Kata Individual male Cadets R3-G1
968	Male	Moretti	Oscar	Kata Individual male Cadets R4 Gold Medal Match
969	Male	Moretti	Oscar	Kata Individual male Cadets R2-G1
970	Female	NORIS	GIADA	Kata Individual female Juniors R2-G2
971	Female	NORIS	GIADA	Kata Individual female Sen R3-G2
972	Female	NORIS	GIADA	Kata Individual female Sen
973	Female	NORIS	GIADA	Kata Individual female Sen R4 Bronze Medal Match 2
974	Female	NORIS	GIADA	Kata Individual female Sen R2-G2
975	Female	NORIS	GIADA	Kata Individual female Juniors
976	Female	PARIMBELLI	CAROLINA	Kata Individual female Cadets R2-G1
977	Female	PARIMBELLI	CAROLINA	Kata Individual female Cadets
978	Female	PEDRETTI	ASIA	Kumite Individual female U14 -52
979	Female	PENDOLI	AURORA	Kumite Individual female Seniors -61
980	Female	PENDOLI	AURORA	Kumite Individual female U21 -61
981	Male	Pendoli	Emanuele	Kumite Individual male Seniors -75
982	Male	Pendoli	Emanuele	Kumite Individual male U21 -75
983	Female	Perina	Camilla	Kumite Individual female Seniors -50
984	Female	Perina	Camilla	Kumite Individual female U21 -50
985	Female	Rifugio	Lavinia	Kumite Individual female Cadets +61
986	Male	Rifugio	Lorenzo	Kumite Individual male Seniors +84
987	Female	Rifugio	Ludovica	Kata Individual female U21
988	Female	Tiraboschi	Letizia	Kumite Individual female Cadets +61
989	Female	Valenti	Jennifer	Kata Individual female U14 R3 Bronze Medal Match 1
990	Female	Valenti	Jennifer	Kata Individual female U14 R2-G1
991	Female	Valenti	Jennifer	Kata Individual female U14
992	Female	VERDONE	MELISSA	Kata Individual female Juniors R3-G2

VENETO OPEN

ITALY

2023.05.19 - 2023.05.21

Via S. Marco, 53, 35129 Padova PD

Tournament Participation (Entries) by Club

993	Female	VERDONE	MELISSA	Kata Individual female Juniors R2-G2
994	Female	VERDONE	MELISSA	Kata Individual female Sen
995	Female	VERDONE	MELISSA	Kata Individual female Sen R2-G2
996	Female	VERDONE	MELISSA	Kata Individual female Juniors
997	Female	VERDONE	MELISSA	Kata Individual female Juniors R4 Bronze Medal Match 1
998	Female	VIELMI	ELISA	Kata Individual female Sen
999	Female	VIELMI	ELISA	Kata Individual female Juniors
1,000	Female	YAMINE	MARYAM	Kumite Individual female U14 +52
1,001	Female	ZANI	CHIARA	Kata Individual female U21 R2-G2
1,002	Female	ZANI	CHIARA	Kata Individual female U21
1,003	Female	ZANI	CHIARA	Kata Individual female U21 R3 Bronze Medal Match 2

Entries: **101**

VENETO OPEN

ITALY

2023.05.19 - 2023.05.21

Via S. Marco, 53, 35129 Padova PD

Tournament Participation (Entries) by Club

 Mens Sana Siena(Mens Sana)					
ID	Sex	Family Name	Given Name	Category	
1,004	Female	Butini	Margherita	Kumite Individual female U14 -47	
1,005	Female	Ferraro	Elisabetta	Kumite Individual female U21 -55	
1,006	Male	MALLARDI	ALESSIO MARIA	Kumite Individual male Juniors -55	
1,007	Female	Milea	Maya	Kumite Individual female Cadets -54	
1,008	Female	Olmastroni	Adele	Kumite Individual female U21 -68	
1,009	Male	Papini	Dario	Kumite Individual male Juniors -68	

Entries: 6

VENETO OPEN

ITALY

2023.05.19 - 2023.05.21

Via S. Marco, 53, 35129 Padova PD

Tournament Participation (Entries) by Club

 NADIR TRATTI D ORIENTE SSD(NADIR)					
ID	Sex	Family Name	Given Name	Category	
1,010	Male	ATTIANESE	FRANCESCO	Kumite Individual male U14 -50	
1,011	Male	DE VIRGILIO	ETTORE	Kumite Individual male U14 -50	
1,012	Female	FARINA	ANNA	Kumite Individual female Juniors +66	
1,013	Male	GRIMALDI	VINCENZO	Kumite Individual male U14 -40	
1,014	Male	MONTORO	ORESTE	Kumite Individual male Cadets -57	
1,015	Male	PAPPAPCENA	GIUSEPPE	Kumite Individual male Cadets -63	
1,016	Male	PROVVIDERA	RICCARDO	Kumite Individual male Cadets -70	

Entries: **7**

VENETO OPEN

ITALY

2023.05.19 - 2023.05.21

Via S. Marco, 53, 35129 Padova PD

Tournament Participation (Entries) by Club

 Napoli(Napoli)					
ID	Sex	Family Name	Given Name	Category	
1,017	Female	Di Pietro	Anna	Kumite Individual female Juniors -66	

Entries: 1

VENETO OPEN

ITALY

2023.05.19 - 2023.05.21

Via S. Marco, 53, 35129 Padova PD

Tournament Participation (Entries) by Club

 NEW SPORTING CLUB CAVARZERE A.S.D.(NEW SPORTING CLUB)					
ID	Sex	Family Name	Given Name	Category	
1,018	Female	FONTANESI	ALICE	Kumite Individual female Juniors -59	
1,019	Male	TECCHIO	DAVIDE	Kumite Individual male Seniors -67	

Entries: 2

VENETO OPEN

ITALY

2023.05.19 - 2023.05.21

Via S. Marco, 53, 35129 Padova PD

Tournament Participation (Entries) by Club

 Olimpia Karate Bergamo asd(Olimpia Bergamo)					
ID	Sex	Family Name	Given Name	Category	
1,020	Male	CHIESA	BRIAN	Kumite Individual male U14 -50	
1,021	Male	Decio	Alessandro	Kumite Individual male Juniors -55	
1,022	Female	El Asri	Amina	Kumite Individual female Cadets -61	
1,023	Female	El Asri	khadija	Kumite Individual female Cadets -54	
1,024	Female	PALUMBO	VITTORIA PIA	Kumite Individual female Cadets +61	
1,025	Male	RABIEA	RAIAN FARGHALI	Kumite Individual male U14 -50	
1,026	Female	SIGNORELLI	SOFIA	Kumite Individual female Cadets +61	
1,027	Male	Tibaldi	Nicol	Kumite Individual male U21 -67	

Entries: 8

VENETO OPEN

ITALY

2023.05.19 - 2023.05.21

Via S. Marco, 53, 35129 Padova PD

Tournament Participation (Entries) by Club

 Polihandy ASD(Polihandy)					
ID	Sex	Family Name	Given Name	Category	
1,028	Female	Caruggi	Alice	Kumite Individual female Juniors -53	
1,029	Female	gabriele	miriam	Kata Individual female Cadets	
1,030	Male	Lubrano	lorenzo	Kumite Individual male Juniors -68	

Entries: 3

VENETO OPEN

ITALY

2023.05.19 - 2023.05.21

Via S. Marco, 53, 35129 Padova PD

Tournament Participation (Entries) by Club

 Polisportiva Karate Mogliano(PKM)					
ID	Sex	Family Name	Given Name	Category	
1,031	Female	Boer	Catia	Kumite Individual female Seniors +68	
1,032	Female	Di Leo	Noemi	Kumite Individual female U14 -52	
1,033	Male	Menegon	Davide	Kumite Individual male U14 -45	
1,034	Male	Menegon	Mattia	Kumite Individual male Juniors -76	

Entries: 4

VENETO OPEN

ITALY

2023.05.19 - 2023.05.21

Via S. Marco, 53, 35129 Padova PD

Tournament Participation (Entries) by Club



Polisportiva Sassarese(Pol. Sassarese)

ID	Sex	Family Name	Given Name	Category
1,035	Male	Mauro	Alessandro	Kumite Individual male Cadets -57

Entries: 1

VENETO OPEN

ITALY

2023.05.19 - 2023.05.21

Via S. Marco, 53, 35129 Padova PD

Tournament Participation (Entries) by Club

 Pro Recco karate asd(Pro Recco)					
ID	Sex	Family Name	Given Name	Category	
1,036	Female	Viacava	Camilla	Kata Individual female U14	
1,037	Female	Viacava	Caterina	Kata Individual female U14	

Entries: 2

VENETO OPEN

ITALY

2023.05.19 - 2023.05.21

Via S. Marco, 53, 35129 Padova PD

Tournament Participation (Entries) by Club

 PRO-TEAM ASD(PRO-TEAM ASD)					
ID	Sex	Family Name	Given Name	Category	
1,038	Female	DI BARI	GEMMA	Kumite Individual female Juniors +66	

Entries: 1

VENETO OPEN

ITALY

2023.05.19 - 2023.05.21

Via S. Marco, 53, 35129 Padova PD

Tournament Participation (Entries) by Club



S.S.DILETTANTISTICA C.K.S. 2000(20SR1832)

ID	Sex	Family Name	Given Name	Category
1,039	Female	Mazzotta	Noemi	Kumite Individual female Cadets -54

Entries: 1

VENETO OPEN

ITALY

2023.05.19 - 2023.05.21

Via S. Marco, 53, 35129 Padova PD

Tournament Participation (Entries) by Club

 SHIRAI CLUB S. VALENTINO(SHIRAI CLUB S. VALENTINO)					
ID	Sex	Family Name	Given Name	Category	
1,040	Male	CALIFANO	EMANUELE	Kumite Individual male Juniors -61	
1,041	Male	CALIFANO	PIETRO PIO	Kumite Individual male Juniors -68	
1,042	Male	Celentano	Antonio	Kumite Individual male Juniors -55	
1,043	Female	DE VIVO	ANNACHIARA	Kumite Individual female U14 +52	
1,044	Female	DE VIVO	ERMELINDA	Kumite Individual female Cadets +61	
1,045	Male	KOROTENKO	MICHAIL	Kumite Individual male Juniors -68	
1,046	Male	Ruocco	Armando	Kumite Individual male U14 -55	
1,047	Male	Russomanno	Gioele Antonio	Kumite Individual male Cadets -63	
1,048	Male	SQUILLANTE	GUIDO	Kumite Individual male Juniors -55	

Entries: 9

VENETO OPEN

ITALY

2023.05.19 - 2023.05.21

Via S. Marco, 53, 35129 Padova PD

Tournament Participation (Entries) by Club

 skorpion karate asd(skorpion karate asd)					
ID	Sex	Family Name	Given Name	Category	
1,049	Female	bossi	alessandra	Kumite Individual female Juniors -48	
1,050	Female	dominici	roberta	Kata Individual female Juniors R2-G1	
1,051	Female	dominici	roberta	Kata Individual female Juniors R3-G1	
1,052	Female	dominici	roberta	Kata Individual female Juniors	
1,053	Female	dominici	roberta	Kata Individual female Juniors R4 Gold Medal Match	
1,054	Female	fanelli	aurora	Kumite Individual female Juniors -66	

Entries: 6

VENETO OPEN

ITALY

2023.05.19 - 2023.05.21

Via S. Marco, 53, 35129 Padova PD

Tournament Participation (Entries) by Club

 Spazio Sport Forte dei Marmi(Spazio Sport)					
ID	Sex	Family Name	Given Name	Category	
1,055	ITA462	Female	LORENZONI	ELENA	Kata Individual female Sen
1,056		Male	MASSAGLIA	MARCO	Kata Individual male Juniors
1,057		Male	MASSAGLIA	MARCO	Kata Individual male Juniors R2-G2
1,058		Female	MATTUGINI	ESTER	Kata Individual female Cadets
1,059		Male	PANFILE	DAVID	Kata Individual male U14
1,060		Female	STAGI	NICOLE	Kata Individual female U14 R3 Bronze Medal Match 1
1,061		Female	STAGI	NICOLE	Kata Individual female U14 R2-G2
1,062		Female	STAGI	NICOLE	Kata Individual female U14

Entries: 8

VENETO OPEN

ITALY

2023.05.19 - 2023.05.21

Via S. Marco, 53, 35129 Padova PD

Tournament Participation (Entries) by Club

 sport center messina(sc messina)					
ID	Sex	Family Name	Given Name	Category	
1,063	Male	CAPRITTI	ENEA	Kumite Individual male Cadets -70	
1,064	Male	NICOTRA	SALVATORE	Kumite Individual male Cadets -57	

Entries: 2

VENETO OPEN

ITALY

2023.05.19 - 2023.05.21

Via S. Marco, 53, 35129 Padova PD

Tournament Participation (Entries) by Club

SPORT TARGET (SPORT TARGET)					
ID	Sex	Family Name	Given Name	Category	
1,065	Female	Aloisi	Gisella	Kumite Individual female Cadets -54	
1,066	Male	Andretta	Giacomo	Kumite Individual male Seniors -67	
1,067	Male	Baggio	Narayan	Kumite Individual male U14 -40	
1,068	ITA2666	Male	Binotto	Pietro	Kata Individual male U21 R2-G1
1,069	ITA2666	Male	Binotto	Pietro	Kata Individual male Sen R4 Gold Medal Match
1,070	ITA2666	Male	Binotto	Pietro	Kata Individual male U21
1,071	ITA2666	Male	Binotto	Pietro	Kata Individual male Sen R3-G1
1,072	ITA2666	Male	Binotto	Pietro	Kata Individual male Sen R2-G1
1,073	ITA2666	Male	Binotto	Pietro	Kata Individual male U21 R3 Gold Medal Match
1,074	ITA2666	Male	Binotto	Pietro	Kata Individual male Sen
1,075	Male	Bitici	Liridon	Kumite Individual male Seniors -67	
1,076	Male	CAMBRUZZI	ALESSIO	Kumite Individual male Seniors -67	
1,077	Male	CAMBRUZZI	ALESSIO	Kumite Individual male U21 -67	
1,078	Female	Creiasco	Eleonora	Kumite Individual female U14 -47	
1,079	Male	Di Nardo	Mattia	Kumite Individual male U14 -45	
1,080	SD49017	Female	Ecchili	Graziella	Kumite Individual female Cadets -61
1,081	Male	Gasparetto	Davide	Kumite Individual male Seniors -75	
1,082	Male	Gatto	Alessandro	Kumite Individual male Seniors +84	
1,083	Female	Marchetti	Giulia	Kata Individual female U21 R2-G1	
1,084	Female	Marchetti	Giulia	Kata Individual female Sen R3-G1	
1,085	Female	Marchetti	Giulia	Kata Individual female Sen R2-G1	
1,086	Female	Marchetti	Giulia	Kata Individual female Sen	
1,087	Female	Marchetti	Giulia	Kata Individual female Sen R4 Bronze Medal Match 2	
1,088	Female	Marchetti	Giulia	Kata Individual female U21 R3 Bronze Medal Match 1	
1,089	Female	Marchetti	Giulia	Kata Individual female U21	
1,090	Male	MASON	TOMMASO	Kumite Individual male Juniors -61	
1,091	Male	Minervino	Giuseppe	Kumite Individual male Seniors -75	
1,092	Male	Pasqualetto	Davide	Kumite Individual male U14 -45	
1,093	Female	PERUZZI	GIADA	Kata Individual female Sen	
1,094	Female	PERUZZI	GIADA	Kata Individual female Sen R2-G2	
1,095	Female	PERUZZI	GIADA	Kata Individual female U21 R3 Bronze Medal Match 1	
1,096	Female	PERUZZI	GIADA	Kata Individual female U21	
1,097	Female	PERUZZI	GIADA	Kata Individual female U21 R2-G2	
1,098	Female	Schirato	Marika	Kumite Individual female U14 -42	
1,099	ITA04275	Female	STANGHERLIN	SOFIA	Kata Individual female Sen
1,100	ITA04275	Female	STANGHERLIN	SOFIA	Kata Individual female Juniors R3-G1
1,101	ITA04275	Female	STANGHERLIN	SOFIA	Kata Individual female Juniors
1,102	ITA04275	Female	STANGHERLIN	SOFIA	Kata Individual female Juniors R2-G1
1,103	Male	Tamberi	Alessandro	Kumite Individual male Cadets -63	
1,104	Female	Tamberi	Sara	Kumite Individual female U14 -52	
1,105	ITA04449	Male	Toniolo	Alvise	Kumite Individual male Cadets -70
1,106	Male	Turcato	Giacomo Filippo	Kata Individual male U14 R3 Bronze Medal Match 2	
1,107	Male	Turcato	Giacomo Filippo	Kata Individual male U14	
1,108	Male	Turcato	Giacomo Filippo	Kata Individual male U14 R2-G2	

VENETO OPEN

ITALY

2023.05.19 - 2023.05.21

Via S. Marco, 53, 35129 Padova PD

Tournament Participation (Entries) by Club

Entries: **44**

VENETO OPEN

ITALY

2023.05.19 - 2023.05.21

Via S. Marco, 53, 35129 Padova PD

Tournament Participation (Entries) by Club

 ssd bracelli club(ssd bracelli club)					
ID	Sex	Family Name	Given Name	Category	
1,109	Male	DI MARCO	ALESSANDRO	Kumite Individual male U21 -67	
1,110	Male	SUPINO	FEDERICO	Kumite Individual male Juniors +76	

Entries: 2

VENETO OPEN

ITALY

2023.05.19 - 2023.05.21

Via S. Marco, 53, 35129 Padova PD

Tournament Participation (Entries) by Club

 SSD Polisportiva Ternana(karateterni)					
ID	Sex	Family Name	Given Name	Category	
1,111	Male	Piccioni	Edoardo	Kata Individual male U21 R3 Bronze Medal Match 2	
1,112	Male	Piccioni	Edoardo	Kata Individual male Sen R2-G2	
1,113	Male	Piccioni	Edoardo	Kata Individual male Sen	
1,114	Male	Piccioni	Edoardo	Kata Individual male U21 R2-G2	
1,115	Male	Piccioni	Edoardo	Kata Individual male Sen R4 Bronze Medal Match 1	
1,116	Male	Piccioni	Edoardo	Kata Individual male U21	
1,117	Male	Piccioni	Edoardo	Kata Individual male Sen R3-G2	
1,118	Male	Rossi	Francesco	Kata Individual male Sen	
1,119	Male	Rossi	Francesco	Kata Individual male Juniors	
1,120	Male	Rossi	Francesco	Kata Individual male Sen R2-G1	

Entries: **10**

VENETO OPEN

ITALY

2023.05.19 - 2023.05.21

Via S. Marco, 53, 35129 Padova PD

Tournament Participation (Entries) by Club

 TEAM KARATE LENTINI(TEAMKARATELENTINI)					
ID	Sex	Family Name	Given Name	Category	
1,121	Male	alfano	nicol	Kumite Individual male Juniors -55	
1,122	Female	Balneare	Ludovica	Kumite Individual female Cadets -54	
1,123	Female	colletti	emma	Kumite Individual female Juniors -53	
1,124	Male	d azzo	liborio	Kumite Individual male Cadets -70	
1,125	Male	gigliotta	giuseppe	Kumite Individual male Juniors -61	
1,126	Female	GULOTTA	GIOIA MARIA	Kumite Individual female U14 +52	
1,127	Female	marturano	irene	Kumite Individual female Juniors -59	
1,128	Male	RANELI	IGNAZIO ALESSANDRO PIO	Kumite Individual male Cadets +70	
1,129	Male	Turturici	Calogero	Kumite Individual male Cadets -52	

Entries: 9

VENETO OPEN

ITALY

2023.05.19 - 2023.05.21

Via S. Marco, 53, 35129 Padova PD

Tournament Participation (Entries) by Club

 Team Karate Puleo Firenze(TKP)					
ID	Sex	Family Name	Given Name	Category	
1,130	Female	Bigagli	Viola	Kumite Individual female Cadets -54	
1,131	Female	Cimone	Arianna	Kumite Individual female Cadets +61	
1,132	Female	Lippi	Ginevra	Kumite Individual female Cadets -61	
1,133	Male	Lombardi	Lapo	Kumite Individual male Seniors -75	
1,134	Male	Lombardi	Lapo	Kumite Individual male U21 -75	
1,135	Male	Lupattelli	Andrea	Kumite Individual male Juniors -61	
1,136	Male	Milanta	Raffaello	Kumite Individual male Seniors -84	
1,137	Male	Moraldi	Amun Enea	Kumite Individual male Seniors -84	
1,138	Male	Moraldi	Amun Enea	Kumite Individual male U21 -84	
1,139	Female	Pergolesi	Aurora	Kumite Individual female U21 +68	
1,140	Female	Piantini	Caterina	Kumite Individual female Juniors -53	
1,141	Male	Rufini	Alessio	Kumite Individual male U21 -67	
1,142	Male	Rufini	Samuele	Kumite Individual male U21 -67	
1,143	Male	Trombetti	Tommaso	Kumite Individual male Cadets +70	

Entries: 14

VENETO OPEN

ITALY

2023.05.19 - 2023.05.21

Via S. Marco, 53, 35129 Padova PD

Tournament Participation (Entries) by Club

 tora-do karate team a.s.d.(Tora-do italy)					
ID	Sex	Family Name	Given Name	Category	
1,144	Female	Arizzi	Clara	Kumite Individual female U14 -52	
1,145	Male	Confalonieri	Aaron	Kumite Individual male U14 -50	
1,146	Male	La Rocca	Darin	Kumite Individual male Juniors -61	
1,147	Male	Travia	Matteo	Kata Individual male Cadets	
1,148	Female	Visco	Sofia	Kumite Individual female U14 -52	

Entries: 5

VENETO OPEN

ITALY

2023.05.19 - 2023.05.21

Via S. Marco, 53, 35129 Padova PD

Tournament Participation (Entries) by Club

 TSKS BELLUNO(TSKS)					
ID	Sex	Family Name	Given Name	Category	
1,149	Male	Antinucci	Ascanio	Kumite Individual male Cadets -57	
1,150	Male	Buzesko Pop	Antonio	Kumite Individual male Cadets -63	
1,151	Female	Calbaza	Elisa	Kumite Individual female U14 -52	
1,152	Male	Casanova Rosolo	Matteo	Kumite Individual male U14 -45	
1,153	Male	Da Rin	Loris	Kumite Individual male Juniors -68	
1,154	Male	De Lazzer	Leonardo	Kumite Individual male Cadets -70	
1,155	Male	De Monte	Bryan	Kumite Individual male Juniors -61	
1,156	Male	Esegio	Jacopo	Kumite Individual male Cadets +70	
1,157	Male	Lam	Gabriele	Kata Individual male Cadets	
1,158	Male	Lam	Gabriele	Kata Individual male Cadets R2-G1	
1,159	Male	Masini	Gabriele	Kumite Individual male Cadets -70	
1,160	Male	NASSIVERA	PIETRO	Kata Individual male Juniors	
1,161	Male	Pais Becher	Emiliano	Kumite Individual male Juniors -76	
1,162	Female	Pompanin	Emma	Kumite Individual female Cadets -61	
1,163	Female	Pompanin	Linda	Kumite Individual female Cadets -54	
1,164	Male	Pontil Scala	Lorenzo	Kumite Individual male U14 -40	
1,165	Female	Zambelli	Rachele	Kumite Individual female Juniors -59	
1,166	Male	Zoungoula	Aaron	Kumite Individual male Juniors -68	

Entries: 18

VENETO OPEN

ITALY

2023.05.19 - 2023.05.21

Via S. Marco, 53, 35129 Padova PD

Tournament Participation (Entries) by Club

 UNIVERSAL CENTER(UC)					
ID	Sex	Family Name	Given Name	Category	
1,167	ITA04478	Female	Ariosto	Myriam	Kumite Individual female Juniors -53
1,168	ITA04479	Male	Avolio	Francesco	Kumite Individual male Cadets -63
1,169	SD61482	Male	Capuzzo	Salvatore	Kumite Individual male Juniors -61
1,170	ITA03397	Male	De Francesco	Luigi	Kumite Individual male Seniors -67
1,171	ITA03397	Male	De Francesco	Luigi	Kumite Individual male U21 -67
1,172	SD57333	Female	Di Domenico	Chiara	Kumite Individual female Seniors -55
1,173	SD57333	Female	Di Domenico	Chiara	Kumite Individual female U21 -55
1,174		Female	Giordano	Nadia	Kumite Individual female Cadets -61
1,175		Female	Manzo	Chiara	Kumite Individual female Juniors -53
1,176		Male	Mazzola	Alessandro	Kumite Individual male Cadets +70
1,177		Male	Mazzola	Gennaro	Kumite Individual male Cadets +70
1,178		Male	Navarra	Diego Angelo	Kumite Individual male Cadets -70
1,179	ITA09980	Male	Pignatiello	Luigi	Kumite Individual male Juniors -76
1,180	ITA04481	Male	Polito	Vincenzo	Kumite Individual male Juniors +76
1,181		Male	Rosmelli	Ivan	Kumite Individual male Cadets -70
1,182	SD61015	Male	Ruffo	Giovanni	Kumite Individual male Cadets -57
1,183	ITA04878	Male	Serino	Salvatore	Kumite Individual male Cadets -57
1,184		Female	Severino	Giustina	Kumite Individual female Cadets -47

Entries: **18**

VENETO OPEN

ITALY

2023.05.19 - 2023.05.21

Via S. Marco, 53, 35129 Padova PD

Tournament Participation (Entries) by Club

 UNIVERSAL TEAM - CSO ARCOBALENO(UNIVERSAL TEAM)					
ID	Sex	Family Name	Given Name	Category	
1,185	Male	ANGELLOTTI	DANIELE	Kata Individual male Cadets	
1,186	Female	ESPOSITO	EMILIA	Kata Individual female Cadets R2-G2	
1,187	Female	ESPOSITO	EMILIA	Kata Individual female Cadets R3-G2	
1,188	Female	ESPOSITO	EMILIA	Kata Individual female Cadets	
1,189	Male	ESPOSITO	NICOLA	Kumite Individual male Cadets -70	
1,190	Female	GARGIULO	TERRY	Kata Individual female U14	
1,191	Male	INTAGLIATORE	FABIANO	Kumite Individual male U14 -50	
1,192	Male	MERLUZZO	ANTONIO	Kata Individual male U14	
1,193	Male	PINTO	SALVATORE	Kumite Individual male Cadets +70	
1,194	Male	SCARICO	MARIO	Kumite Individual male U14 -55	

Entries: **10**

VENETO OPEN

ITALY

2023.05.19 - 2023.05.21

Via S. Marco, 53, 35129 Padova PD

Tournament Participation (Entries) by Club

 WMAC italia (WMACIT)					
ID	Sex	Family Name	Given Name	Category	
1,195	Male	de Marchi	Sergio	Kata Individual male Sen	

Entries: 1

VENETO OPEN

ITALY

2023.05.19 - 2023.05.21

Via S. Marco, 53, 35129 Padova PD

Tournament Participation (Entries) by Club

 YOSEIKAN KARATE OPEN WKF(YOSEIKAN KARATE)					
ID	Sex	Family Name	Given Name	Category	
1,196	Male	Guida	Samuele	Kumite Individual male Cadets -57	
1,197	Male	Segantini	Andrea	Kumite Individual male U14 -55	
1,198	Male	Slavazza	Simone	Kumite Individual male Cadets -52	

Entries: 3



VENETO OPEN

ITALY

2023.05.19 - 2023.05.21

Via S. Marco, 53, 35129 Padova PD

Tournament Participation (Entries) by Club

 SLOVENIA					
 PORTNO DRUTVO GORICA(D GORICA)					
ID	Sex	Family Name	Given Name	Category	
1,199	Male	GOSTI	STEFAN	Kumite Individual male Cadets -57	
1,200	Male	KOLEK	KLEMEN	Kumite Individual male Juniors +76	
1,201	Female	VOROVI	ALEKSANDRA	Kata Individual female U21	

Entries: 3

VENETO OPEN

ITALY

2023.05.19 - 2023.05.21

Via S. Marco, 53, 35129 Padova PD

Tournament Participation (Entries) by Club

Total Entries: **1,201**

VENETO OPEN

ITALY
Via S. Marco, 53, 35129 Padova PD

2023.05.19 - 2023.05.21

Statistics

Participating Countries: 2

Participating Regions: 16

Participating Team/Clubs: 191

	Competitors	Entries
Female	402	436
Male	491	529
Total	893	965

Entries per Category

	Entries	Teams
Kata Individual female Cadets	36	-
Kata Individual female Juniors	29	-
Kata Individual female Sen	38	-
Kata Individual female U14	19	-
Kata Individual female U21	23	-
Kata Individual male Cadets	35	-
Kata Individual male Juniors	31	-
Kata Individual male Sen	33	-
Kata Individual male U14	17	-
Kata Individual male U21	17	-
Kumite Individual female Cadets +61	19	-
Kumite Individual female Cadets -47	12	-
Kumite Individual female Cadets -54	26	-
Kumite Individual female Cadets -61	29	-
Kumite Individual female Juniors +66	14	-
Kumite Individual female Juniors -48	14	-
Kumite Individual female Juniors -53	11	-
Kumite Individual female Juniors -59	24	-
Kumite Individual female Juniors -66	9	-
Kumite Individual female Seniors +68	7	-
Kumite Individual female Seniors -50	5	-
Kumite Individual female Seniors -55	7	-
Kumite Individual female Seniors -61	3	-
Kumite Individual female Seniors -68	1	-
Kumite Individual female U14 +52	27	-
Kumite Individual female U14 -42	22	-
Kumite Individual female U14 -47	11	-
Kumite Individual female U14 -52	15	-
Kumite Individual female U21 +68	4	-
Kumite Individual female U21 -50	8	-

VENETO OPEN

ITALY

2023.05.19 - 2023.05.21

Via S. Marco, 53, 35129 Padova PD

Statistics

Kumite Individual female U21 -55	12	-
Kumite Individual female U21 -61	6	-
Kumite Individual female U21 -68	5	-
Kumite Individual male Cadets +70	19	-
Kumite Individual male Cadets -52	20	-
Kumite Individual male Cadets -57	24	-
Kumite Individual male Cadets -63	27	-
Kumite Individual male Cadets -70	28	-
Kumite Individual male Juniors +76	14	-
Kumite Individual male Juniors -55	15	-
Kumite Individual male Juniors -61	23	-
Kumite Individual male Juniors -68	26	-
Kumite Individual male Juniors -76	16	-
Kumite Individual male Seniors +84	5	-
Kumite Individual male Seniors -60	4	-
Kumite Individual male Seniors -67	8	-
Kumite Individual male Seniors -75	6	-
Kumite Individual male Seniors -84	3	-
Kumite Individual male U14 +55	17	-
Kumite Individual male U14 -40	28	-
Kumite Individual male U14 -45	16	-
Kumite Individual male U14 -50	20	-
Kumite Individual male U14 -55	25	-
Kumite Individual male U21 +84	7	-
Kumite Individual male U21 -60	6	-
Kumite Individual male U21 -67	16	-
Kumite Individual male U21 -75	13	-
Kumite Individual male U21 -84	10	-
Totals:	965	0

Kumite Individual female Cadets +61

VENETO OPEN, Via S. Marco, 53, 35129 Padova PD, ITA

2023-05-20

Tatami
5 09:00

Tabelloni - Pool
1/2

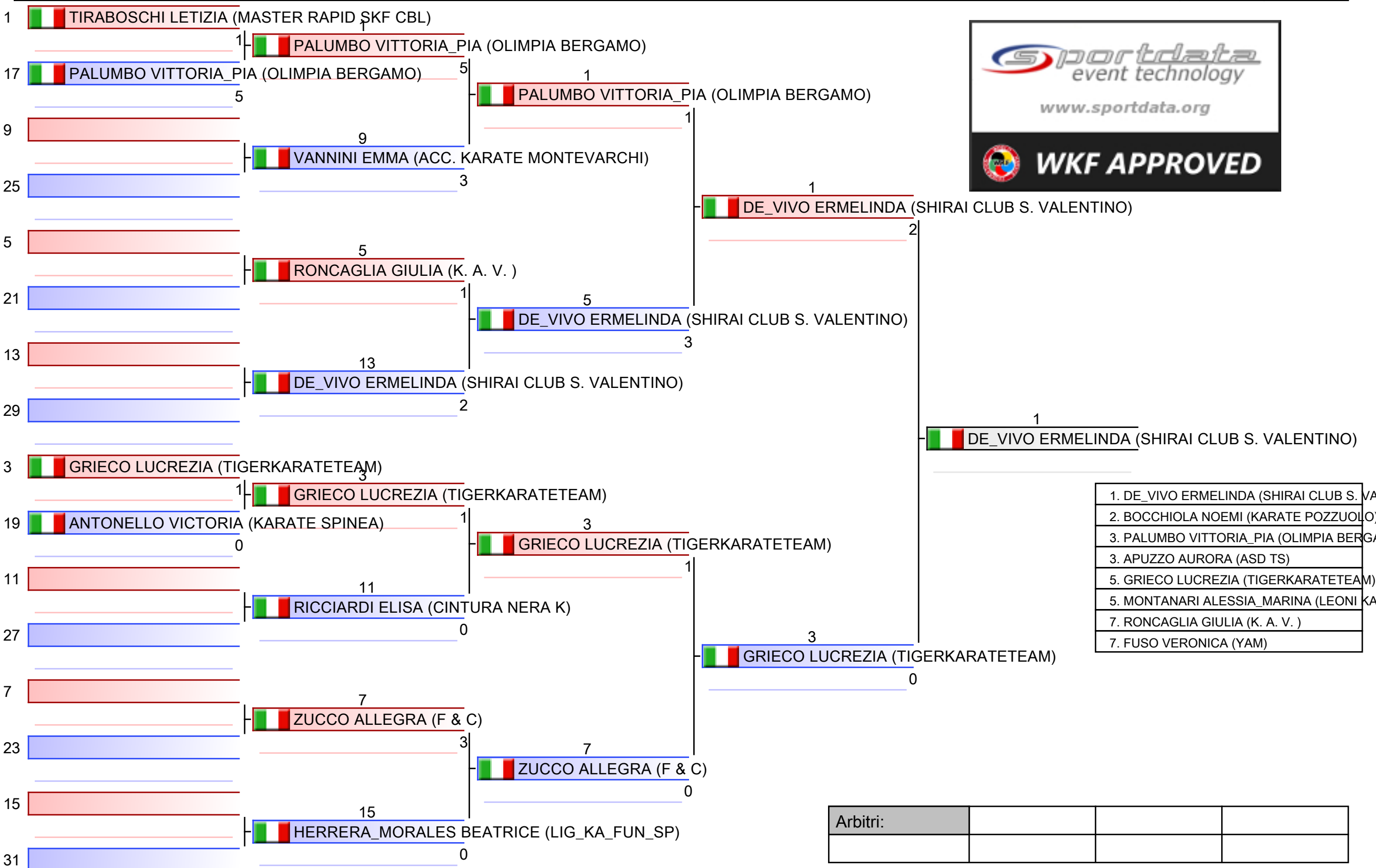

- 1. DE_VIVO ERMELINDA (SHIRAI CLUB S. VALENTINO)
- 2. BOCCHIOLA NOEMI (KARATE POZZUOLO)
- 3. PALUMBO VITTORIA_PIA (OLIMPIA BERGAMO)
- 3. APUZZO AURORA (ASD TS)
- 5. GRIECO LUCREZIA (TIGERKARATETEAM)
- 5. MONTANARI ALESSIA_MARINA (LEONI KARATE)
- 7. RONCAGLIA GIULIA (K. A. V.)
- 7. FUSO VERONICA (YAM)

Arbitri:			

Kumite Individual female Cadets +61

VENETO OPEN, Via S. Marco, 53, 35129 Padova PD, ITA

2023-05-20

Tatami
6 09:00

Tabelloni - Pool
2/2

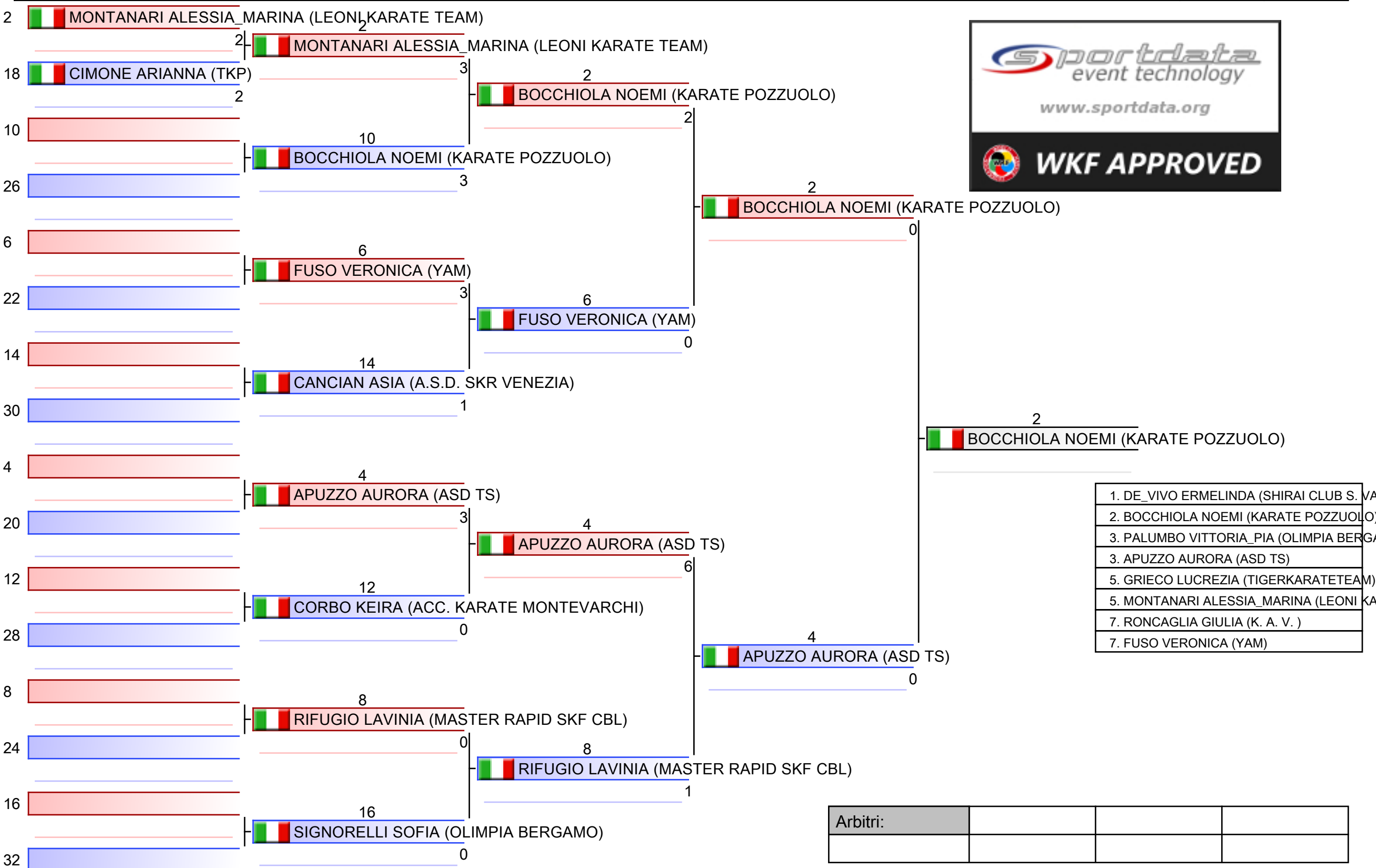

- | |
|--------------------------------------------|
| 1. DE_VIVO ERMELINDA (SHIRAI CLUB S. VALEN |
| 2. BOCCHIOLA NOEMI (KARATE POZZUOLO) |
| 3. PALUMBO VITTORIA_PIA (OLIMPIA BERGAMO) |
| 3. APUZZO AURORA (ASD TS) |
| 5. GRIECO LUCREZIA (TIGERKARATETEAM) |
| 5. MONTANARI ALESSIA_MARINA (LEONI KARATE |
| 7. RONCAGLIA GIULIA (K. A. V.) |
| 7. FUSO VERONICA (YAM) |

Arbitri:			

Vincitore di pool-Kumite Individual female Cadets +61

VENETO OPEN, Via S. Marco, 53, 35129 Padova PD, ITA

Tatami

Tabelloni - Pool

1/1

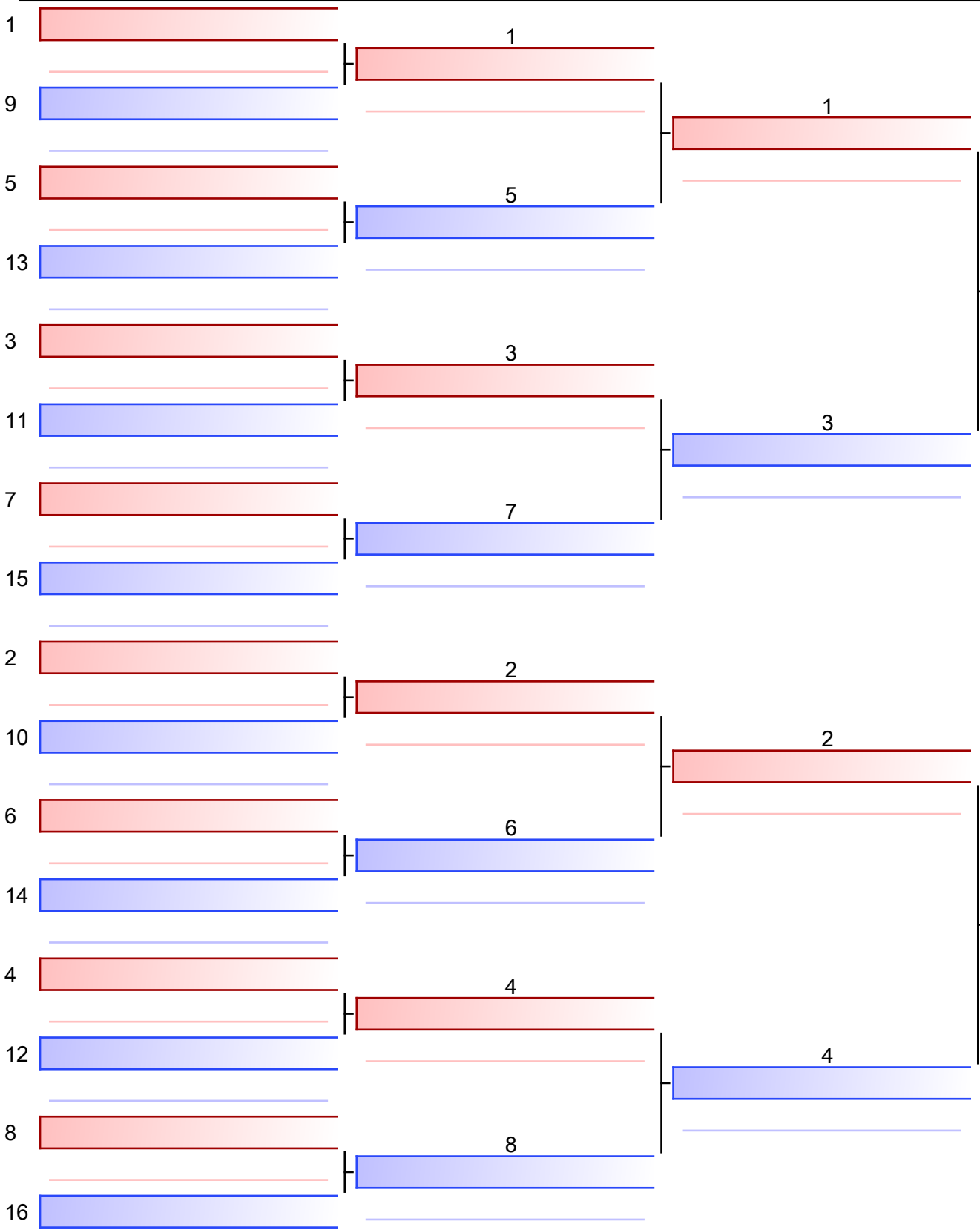

Finale

1 DE_VIVO ERMELINDA (SHIRAI CLUB S. VALENTINO)

3

DE_VIVO ERMELINDA (SHIRAI CLUB S. VALENTINO)

2 BOCCHIOLA NOEMI (KARATE POZZUOLO)

0

- | |
|-------------------------------------------------|
| 1. DE_VIVO ERMELINDA (SHIRAI CLUB S. VALENTINO) |
| 2. BOCCHIOLA NOEMI (KARATE POZZUOLO) |
| 3. PALUMBO VITTORIA_PIA (OLIMPIA BERGAMO) |
| 3. APUZZO AURORA (ASD TS) |
| 5. GRIECO LUCREZIA (TIGERKARATETEAM) |
| 5. MONTANARI ALESSIA_MARINA (LEONI KARATE) |
| 7. RONCAGLIA GIULIA (K. A. V.) |
| 7. FUSO VERONICA (YAM) |

Arbitri:			

Kumite Individual female Cadets +61

VENETO OPEN

2023-05-20

Tatami
2 12:05

Tabelloni - Pool
1,2

(c)sportdata GmbH & Co KG 2000-2023 (2023-05-21 20:06) v 10.0.0 build 1 (2023-02-10) Licenza: Fijlkam Karate 2023 (expire 2023-12-31)

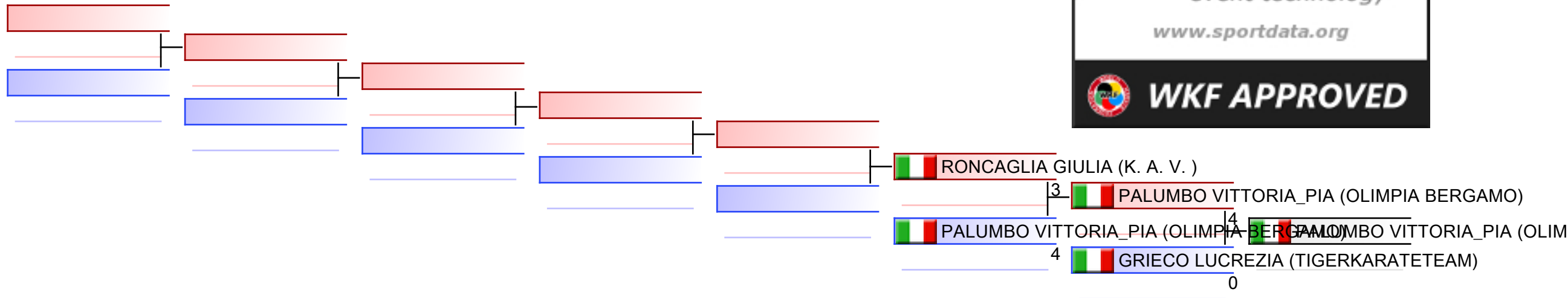

Ripescaggi: (1,2)

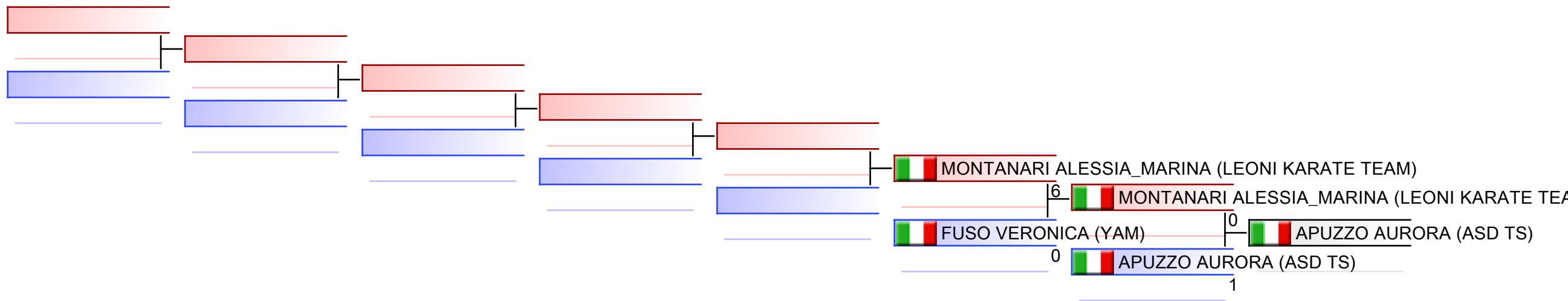

Arbitri:							
----------	--	--	--	--	--	--	--

Kumite Individual female Cadets -47

VENETO OPEN, Via S. Marco, 53, 35129 Padova PD, ITA

2023-05-20

Tatami
4 09:00

Tabelloni - Pool
1/1

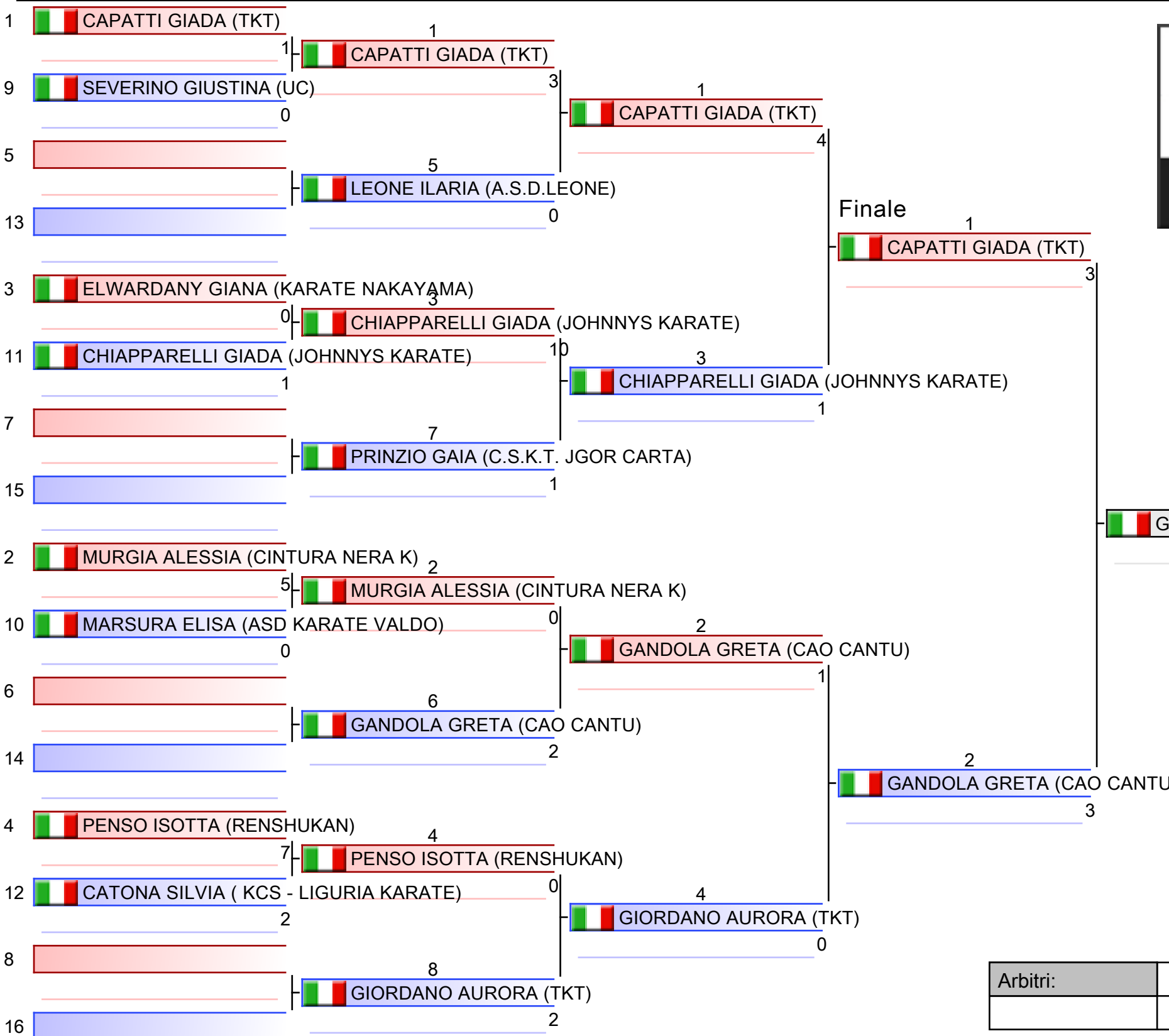

1. GANDOLA GRETA (CAO CANTU)
2. CAPATTI GIADA (TKT)
3. MURGIA ALESSIA (CINTURA NERA K)
3. LEONE ILARIA (A.S.D.LEONE)
5. GIORDANO AURORA (TKT)
5. CHIAPPARELLI GIADA (JOHNNYS KARATE)
7. SEVERINO GIUSTINA (UC)

Arbitri:			

Kumite Individual female Cadets -47

VENETO OPEN

2023-05-20

Tatami
4 12:25

Tabelloni - Pool
1

(c)sportdata GmbH & Co KG 2000-2023 (2023-05-21 20:06) v 10.0.0 build 1 (2023-02-10) Licenza: Fijlkam Karate 2023 (expire 2023-12-31)

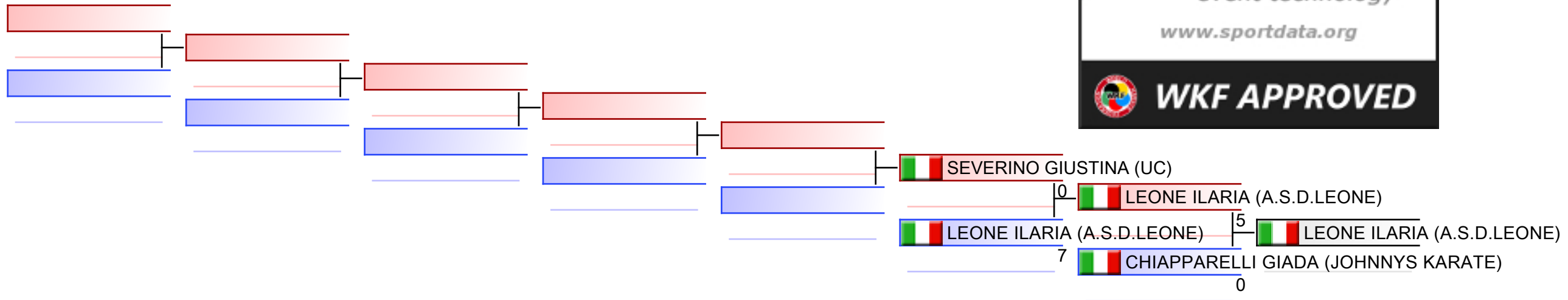

Ripescaggi: (1)

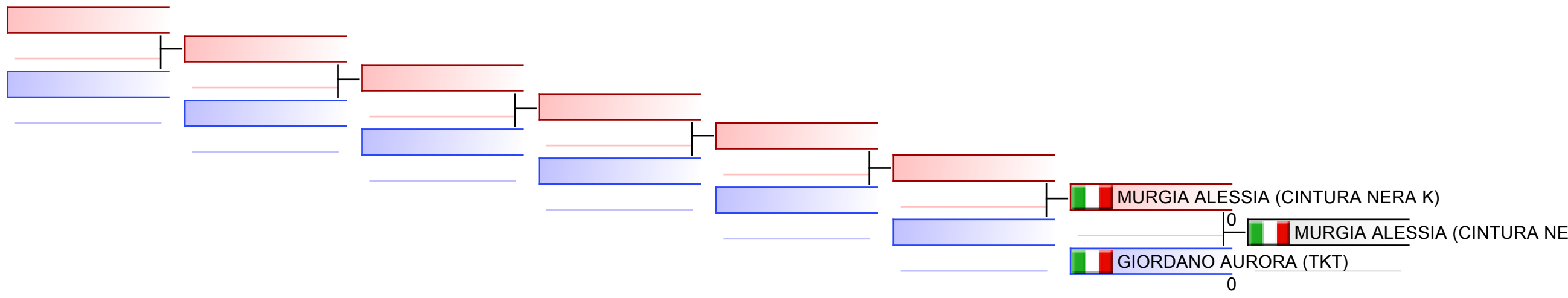

Arbitri:							
----------	--	--	--	--	--	--	--

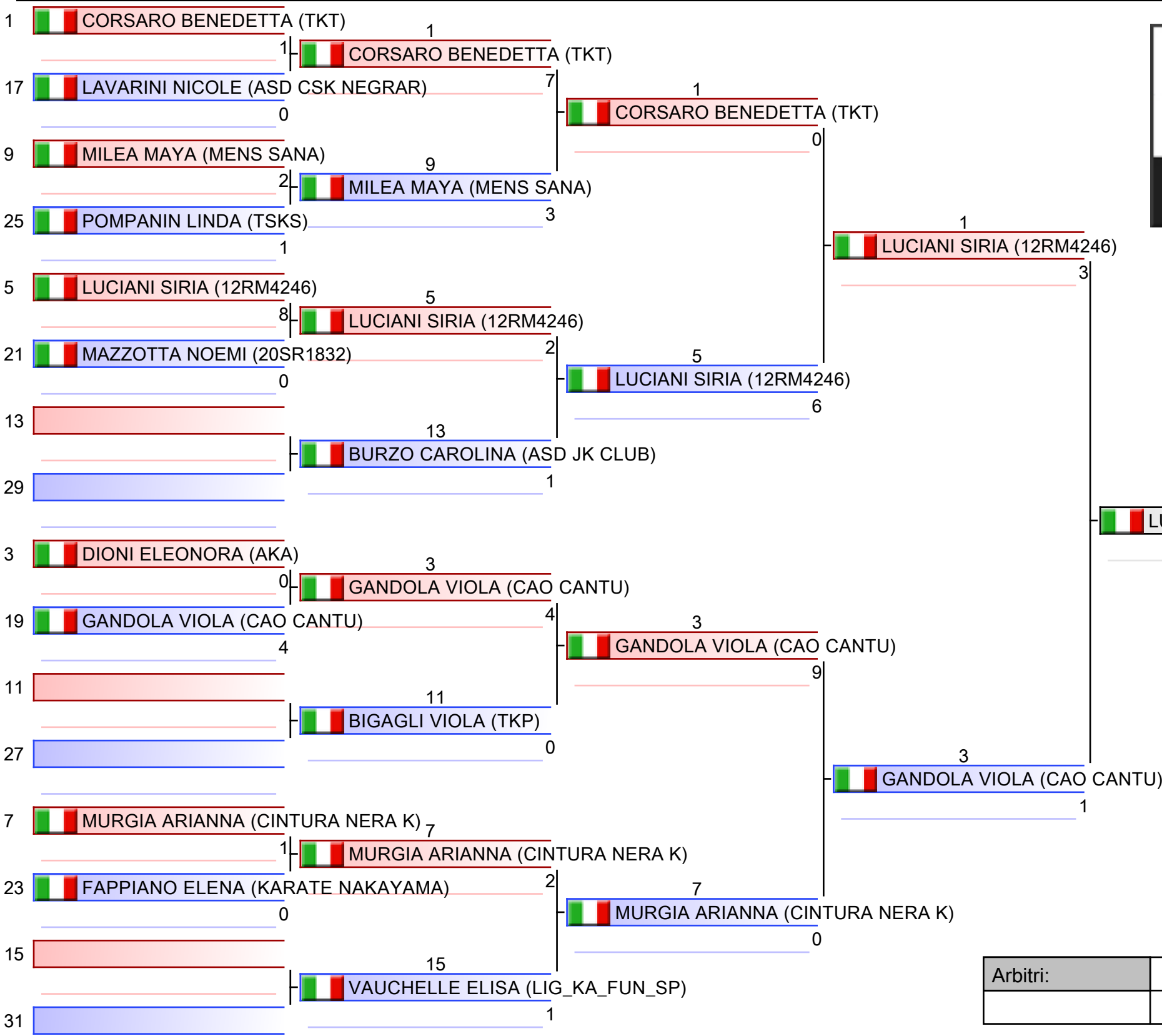

- | |
|------------------------------------------|
| 1. LUCIANI SIRIA (12RM4246) |
| 2. CAPONE BIANCA (SHIZOKU KRT AV) |
| 3. GANDOLA VIOLA (CAO CANTU) |
| 3. BALNEARE LUDOVICA (TEAMKARATELENTINI) |
| 5. BURZO CAROLINA (ASD JK CLUB) |
| 5. ALOISI GISELLA (SPORT TARGET) |
| 7. CORSARO BENEDETTA (TKT) |
| 7. LEONI ADELE (JOHNNYS KARATE) |

Arbitri:			

Kumite Individual female Cadets -54

VENETO OPEN, Via S. Marco, 53, 35129 Padova PD, ITA

2023-05-20

Tatami
3 09:00

Tabelloni - Pool
2/2

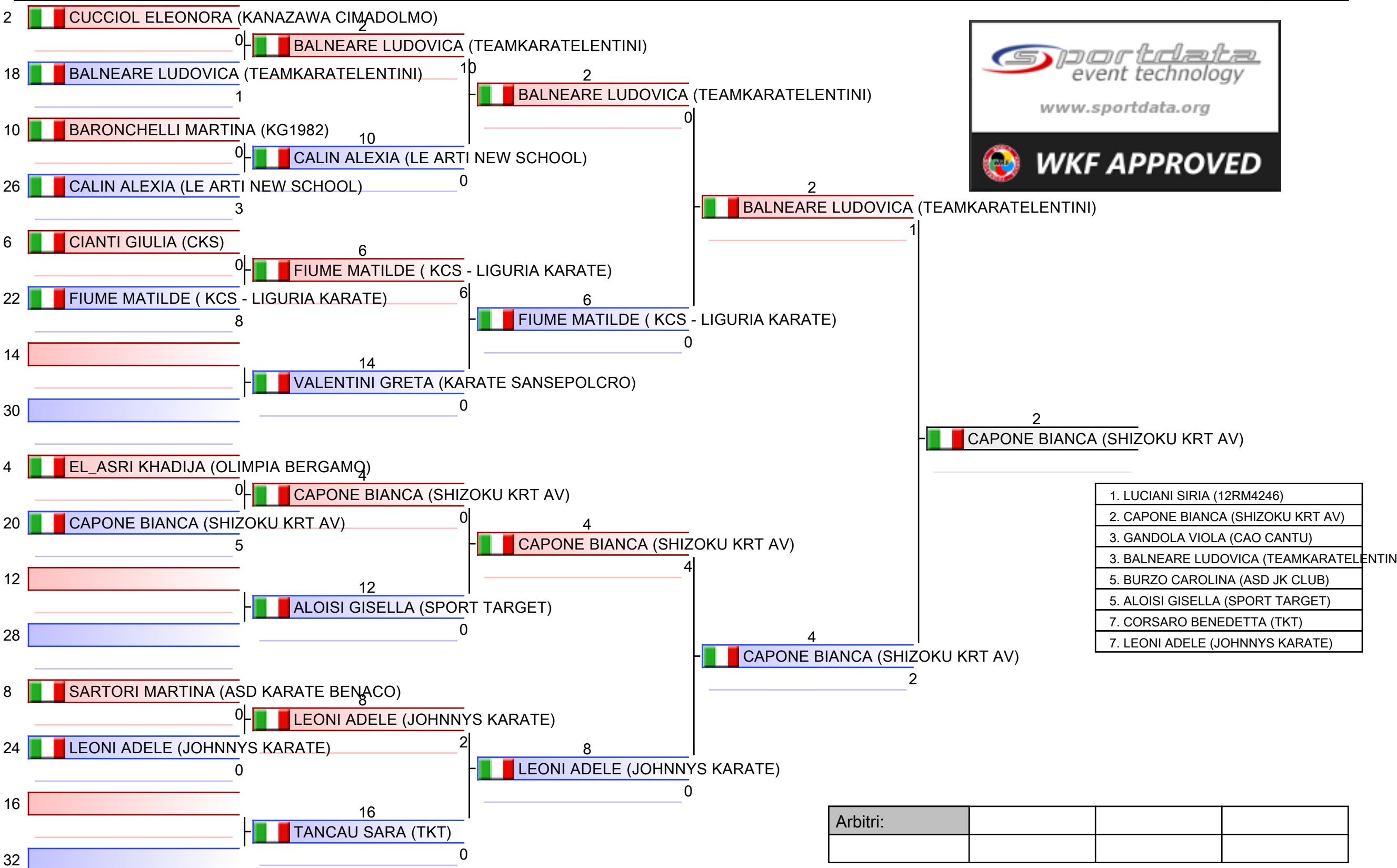

Arbitri:			

Vincitore di pool-Kumite Individual female Cadets -54

VENETO OPEN, Via S. Marco, 53, 35129 Padova PD, ITA

Tatami

Tabelloni - Pool

1/1

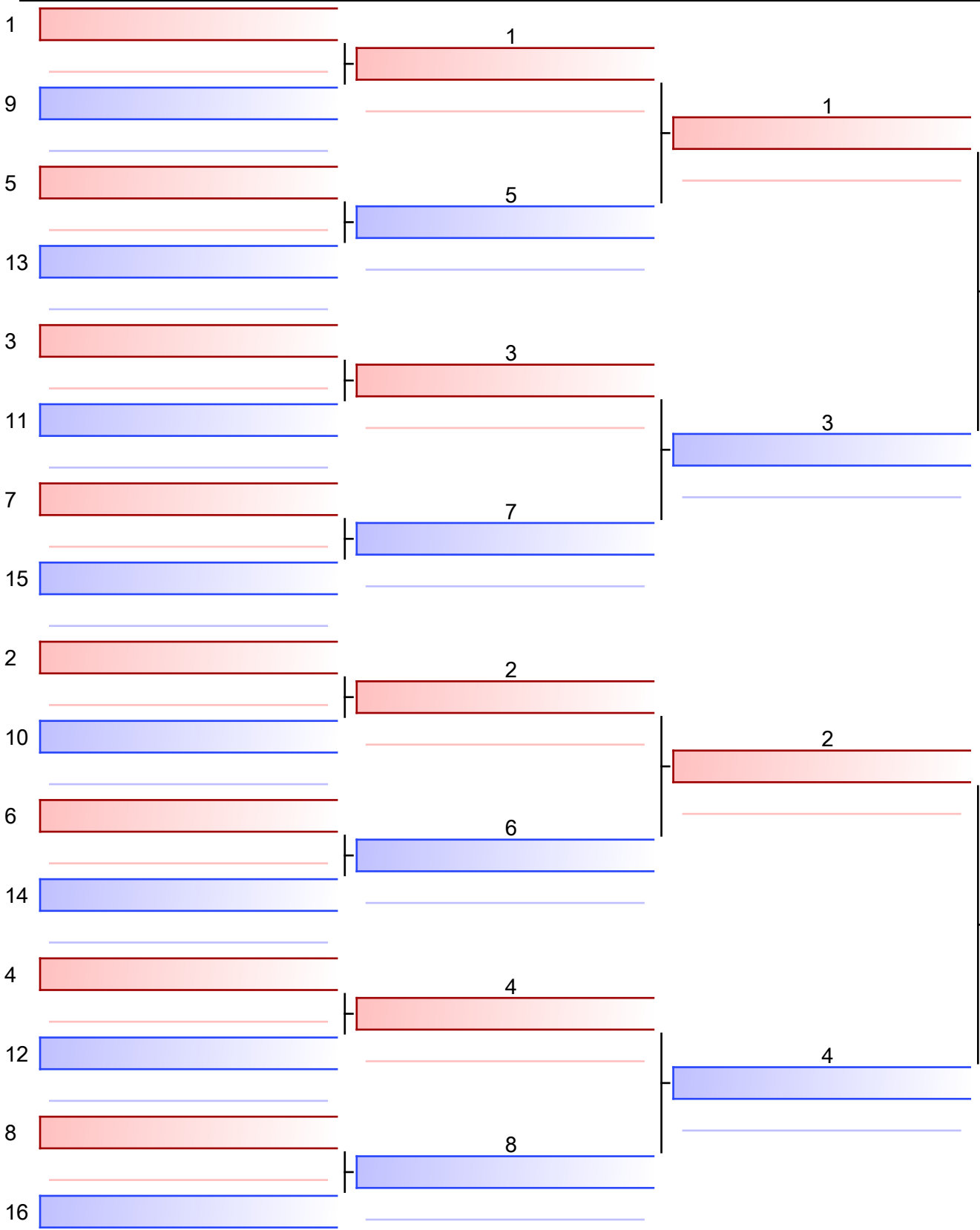

Finale

1
 LUCIANI SIRIA (12RM4246)

1

LUCIANI SIRIA (12RM4246)

2
 CAPONE BIANCA (SHIZOKU KRT AV)

0

- | |
|------------------------------------------|
| 1. LUCIANI SIRIA (12RM4246) |
| 2. CAPONE BIANCA (SHIZOKU KRT AV) |
| 3. GANDOLA VIOLA (CAO CANTU) |
| 3. BALNEARE LUDOVICA (TEAMKARATELENTINI) |
| 5. BURZO CAROLINA (ASD JK CLUB) |
| 5. ALOISI GISELLA (SPORT TARGET) |
| 7. CORSARO BENEDETTA (TKT) |
| 7. LEONI ADELE (JOHNNYS KARATE) |

Arbitri:			

Kumite Individual female Cadets -54

VENETO OPEN

2023-05-20

Tatami
2 12:35

Tabelloni - Pool
1,2

(c)sportdata GmbH & Co KG 2000-2023 (2023-05-21 20:06) v 10.0.0 build 1 (2023-02-10) Licenza: Fijlkam Karate 2023 (expire 2023-12-31)

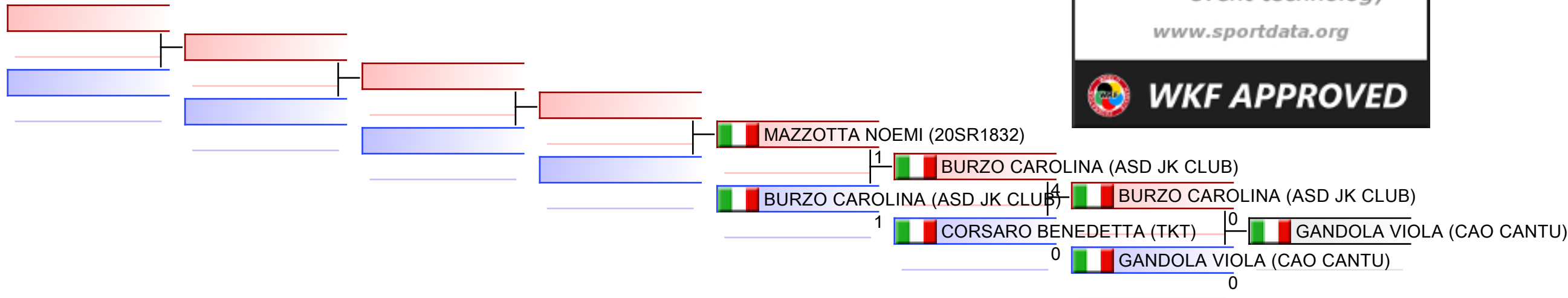

Ripescaggi: (1,2)

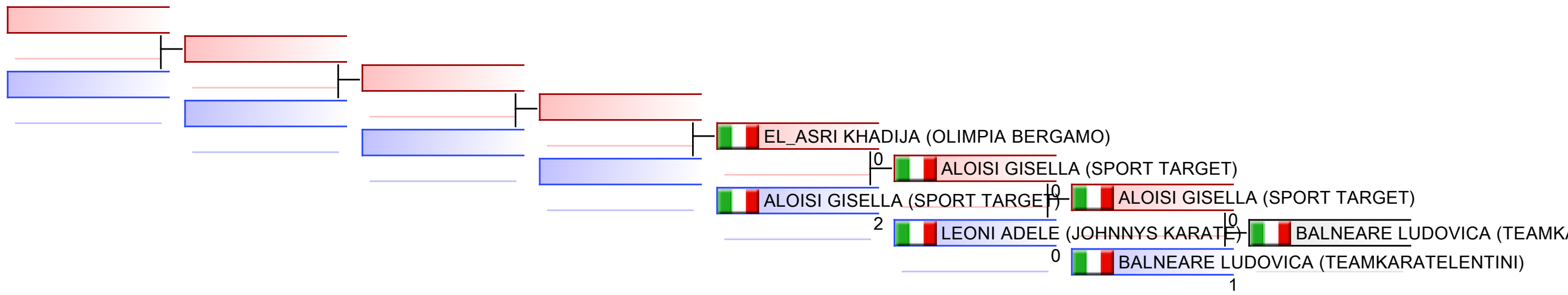

Arbitri:							
----------	--	--	--	--	--	--	--

Kumite Individual female Cadets -61

VENETO OPEN, Via S. Marco, 53, 35129 Padova PD, ITA

2023-05-20

Tatami
5 09:50

Tabelloni - Pool
1/2

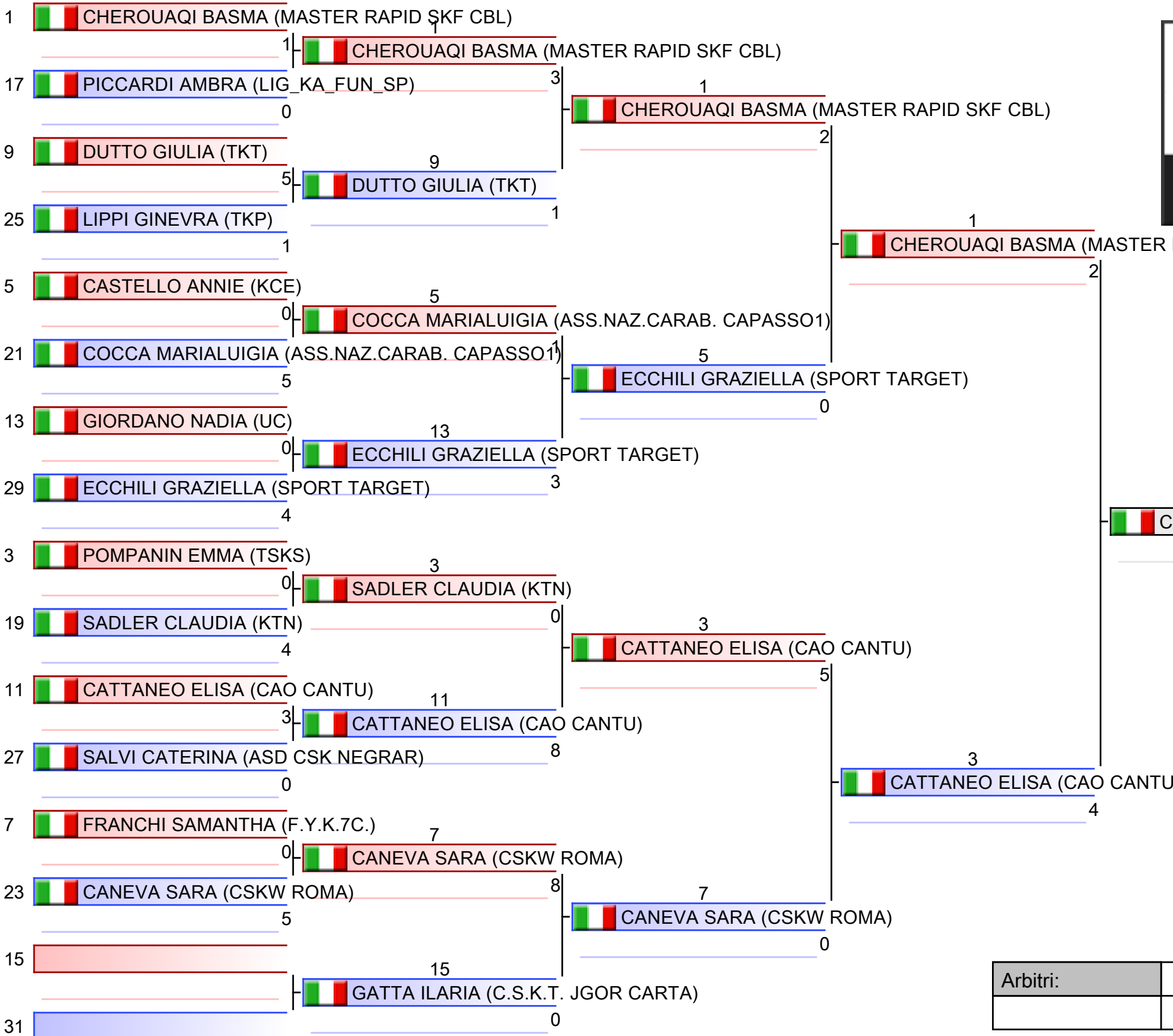

- | |
|-------------------------------------------|
| 1. CATTANEO ELISA (CAO CANTU) |
| 2. MUSSO ROBERTA (KCS - LIGURIA KARATE) |
| 3. ANSEMI CHIARA (CHAMPION CENTER) |
| 3. CHEROUAQI BASMA (MASTER RAPID SKF CBL) |
| 5. BERTON EMMA (A.S.D. SKR VENEZIA) |
| 5. SALVI CATERINA (ASD CSK NEGRAR) |
| 7. BISOL GIULIA (SAKURA VICENZA) |
| 7. CANEVA SARA (CSKW ROMA) |

Arbitri:			

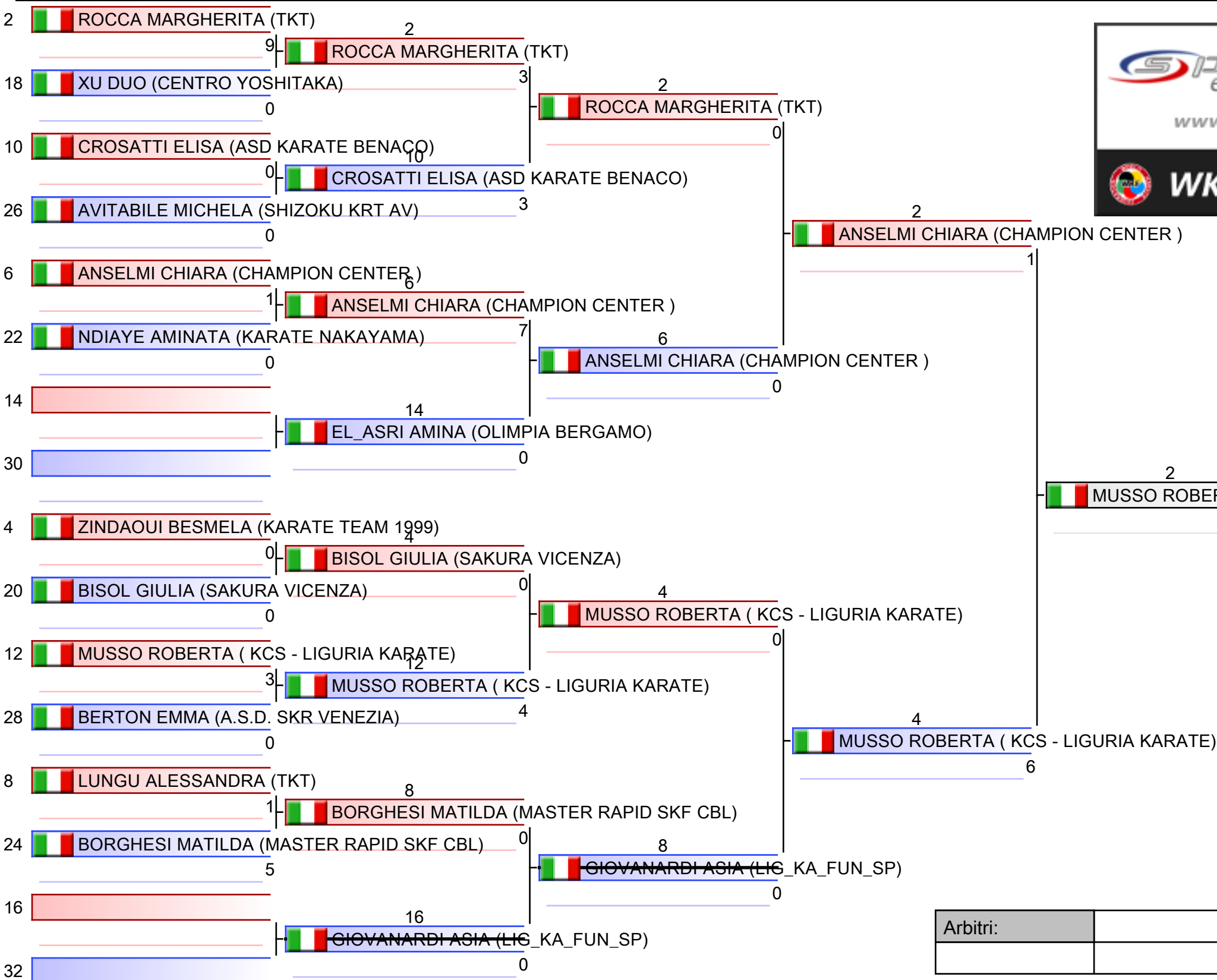

- | |
|-------------------------------------------|
| 1. CATTANEO ELISA (CAO CANTU) |
| 2. MUSO ROBERTA (KCS - LIGURIA KARATE) |
| 3. ANSEMI CHIARA (CHAMPION CENTER) |
| 3. CHEROUAQI BASMA (MASTER RAPID SKF CBL) |
| 5. BERTON EMMA (A.S.D. SKR VENEZIA) |
| 5. SALVI CATERINA (ASD CSK NEGRAR) |
| 7. BISOL GIULIA (SAKURA VICENZA) |
| 7. CANEVA SARA (CSKW ROMA) |

Arbitri:			

Vincitore di pool-Kumite Individual female Cadets -61

VENETO OPEN, Via S. Marco, 53, 35129 Padova PD, ITA

Tatami

Tabelloni - Pool

1/1

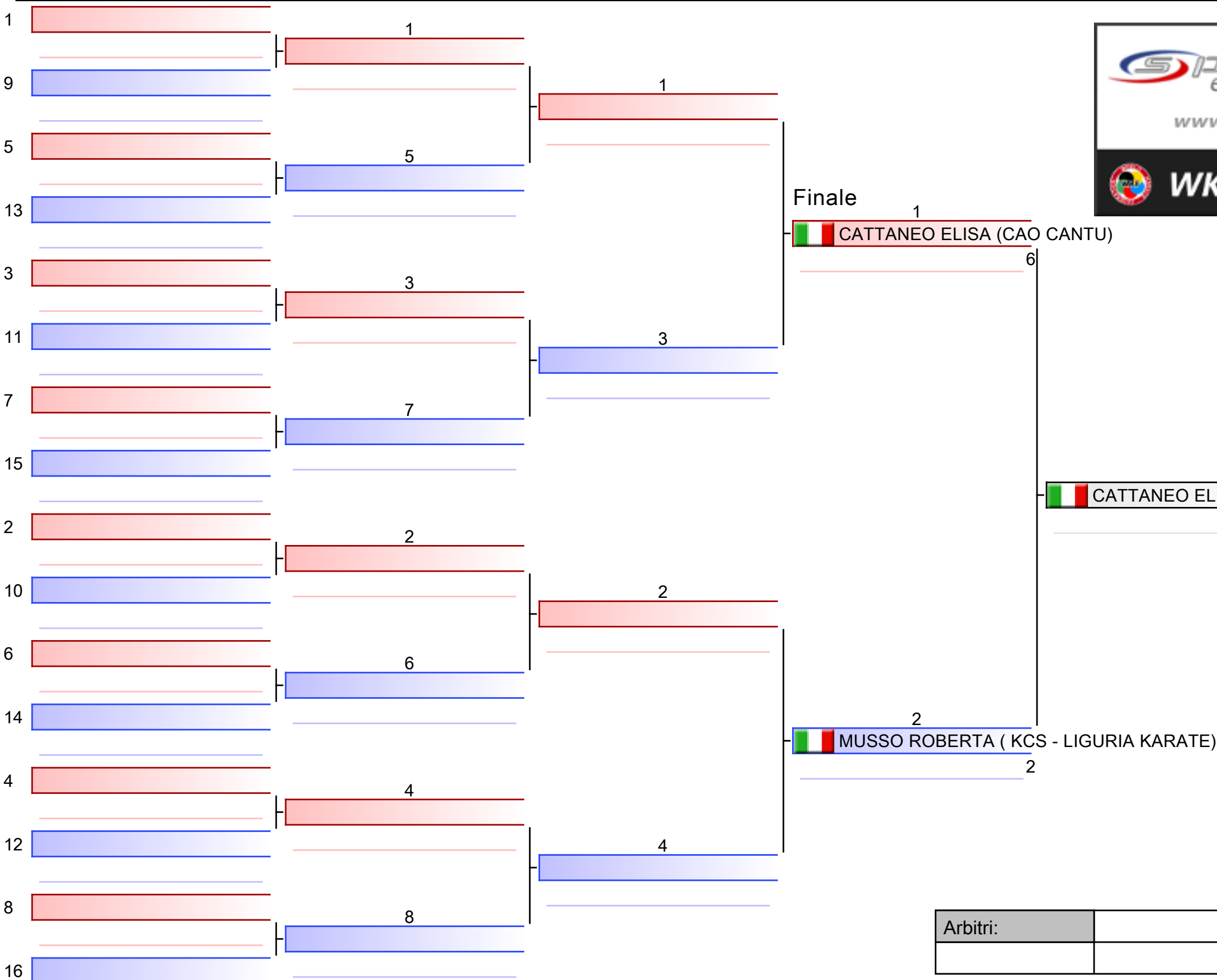

- | |
|-------------------------------------------|
| 1. CATTANEO ELISA (CAO CANTU) |
| 2. MUSSO ROBERTA (KCS - LIGURIA KARATE) |
| 3. ANSEMI CHIARA (CHAMPION CENTER) |
| 3. CHEROUAQI BASMA (MASTER RAPID SKF CBL) |
| 5. BERTON EMMA (A.S.D. SKR VENEZIA) |
| 5. SALVI CATERINA (ASD CSK NEGRAR) |
| 7. BISOL GIULIA (SAKURA VICENZA) |
| 7. CANEVA SARA (CSKW ROMA) |

Arbitri:			

Kumite Individual female Cadets -61

VENETO OPEN

2023-05-20

Tatami
3 12:05

Tabelloni - Pool
1,2

(c)sportdata GmbH & Co KG 2000-2023 (2023-05-21 20:06) v 10.0.0 build 1 (2023-02-10) Licenza: Fijlkam Karate 2023 (expire 2023-12-31)

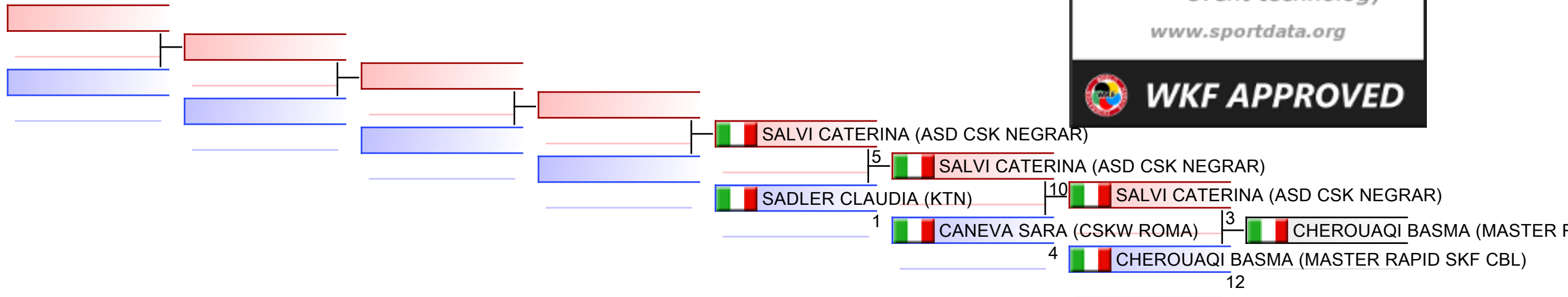

Ripescaggi: (1,2)

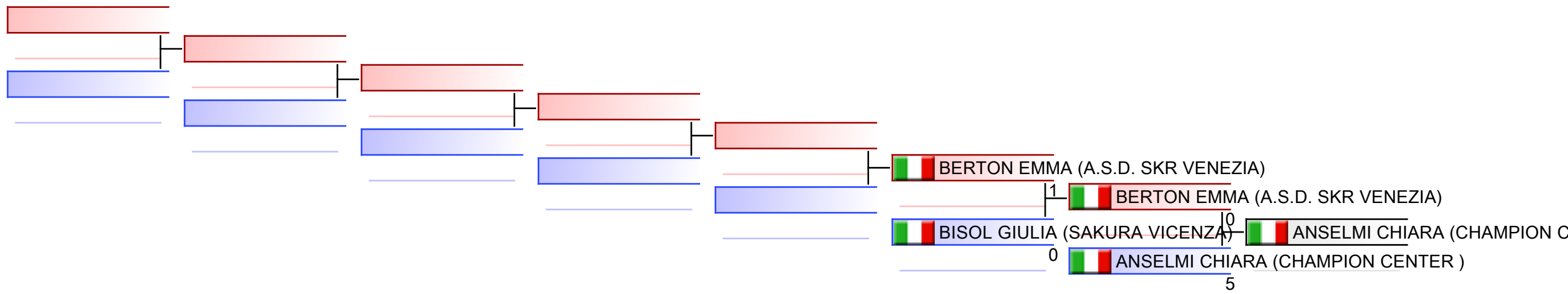

Arbitri:							
----------	--	--	--	--	--	--	--

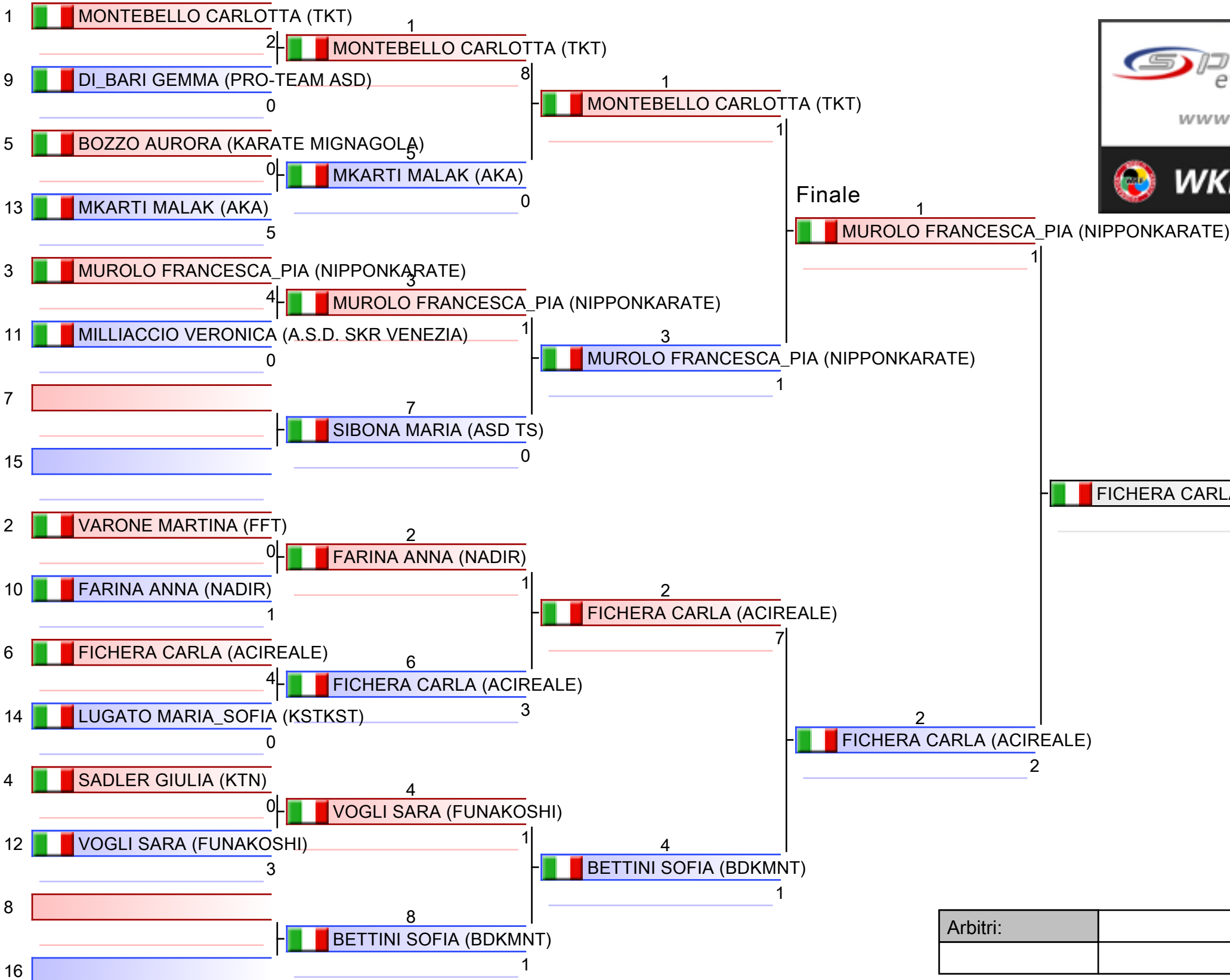

1. FICHERA CARLA (ACIREALE)
2. MUROLO FRANCESCA_PIA (NIPPONKARATE)
3. MONTEBELLO CARLOTTA (TKT)
3. FARINA ANNA (NADIR)
5. SIBONA MARIA (ASD TS)
5. BETTINI SOFIA (BDKMNT)
7. MILLIACCIO VERONICA (A.S.D. SKR VENEZIA)
7. LUGATO MARIA_SOFIA (KSTKST)

Arbitri:			

Kumite Individual female Juniors +66

VENETO OPEN

2023-05-20

Tatami
3 17:10

Tabelloni - Pool
1

(c)sportdata GmbH & Co KG 2000-2023 (2023-05-21 20:06) v 10.0.0 build 1 (2023-02-10) Licenza: Fijlkam Karate 2023 (expire 2023-12-31)

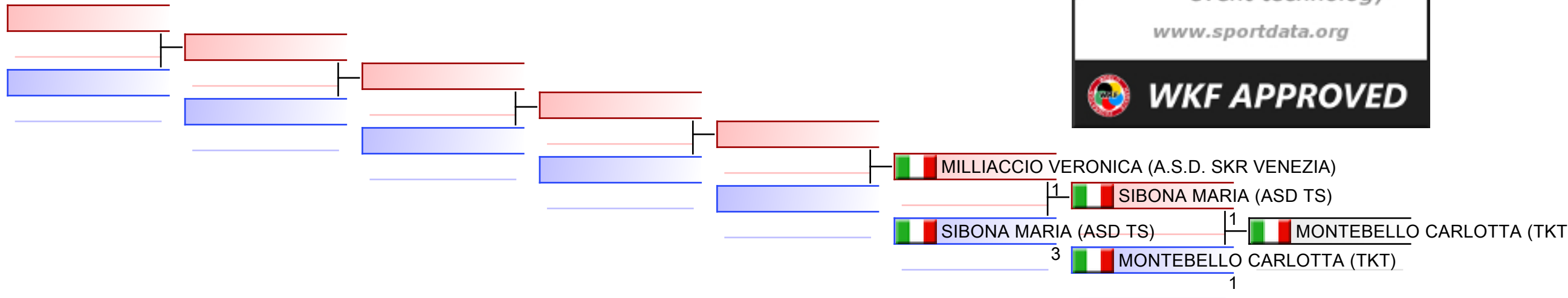

Ripescaggi: (1)

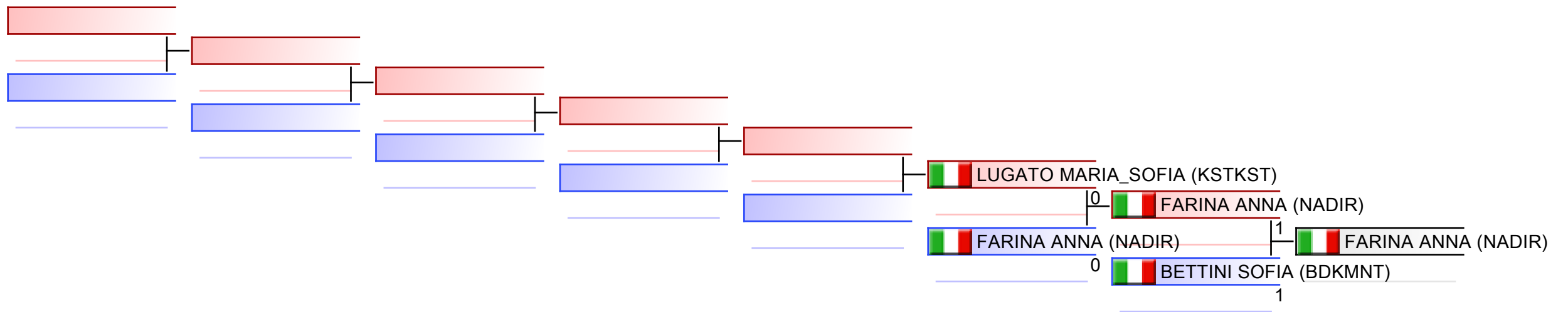

Arbitri:							
----------	--	--	--	--	--	--	--

Kumite Individual female Juniors -48

VENETO OPEN, Via S. Marco, 53, 35129 Padova PD, ITA

2023-05-20

Tatami
3 14:25

Tabelloni - Pool
1/1

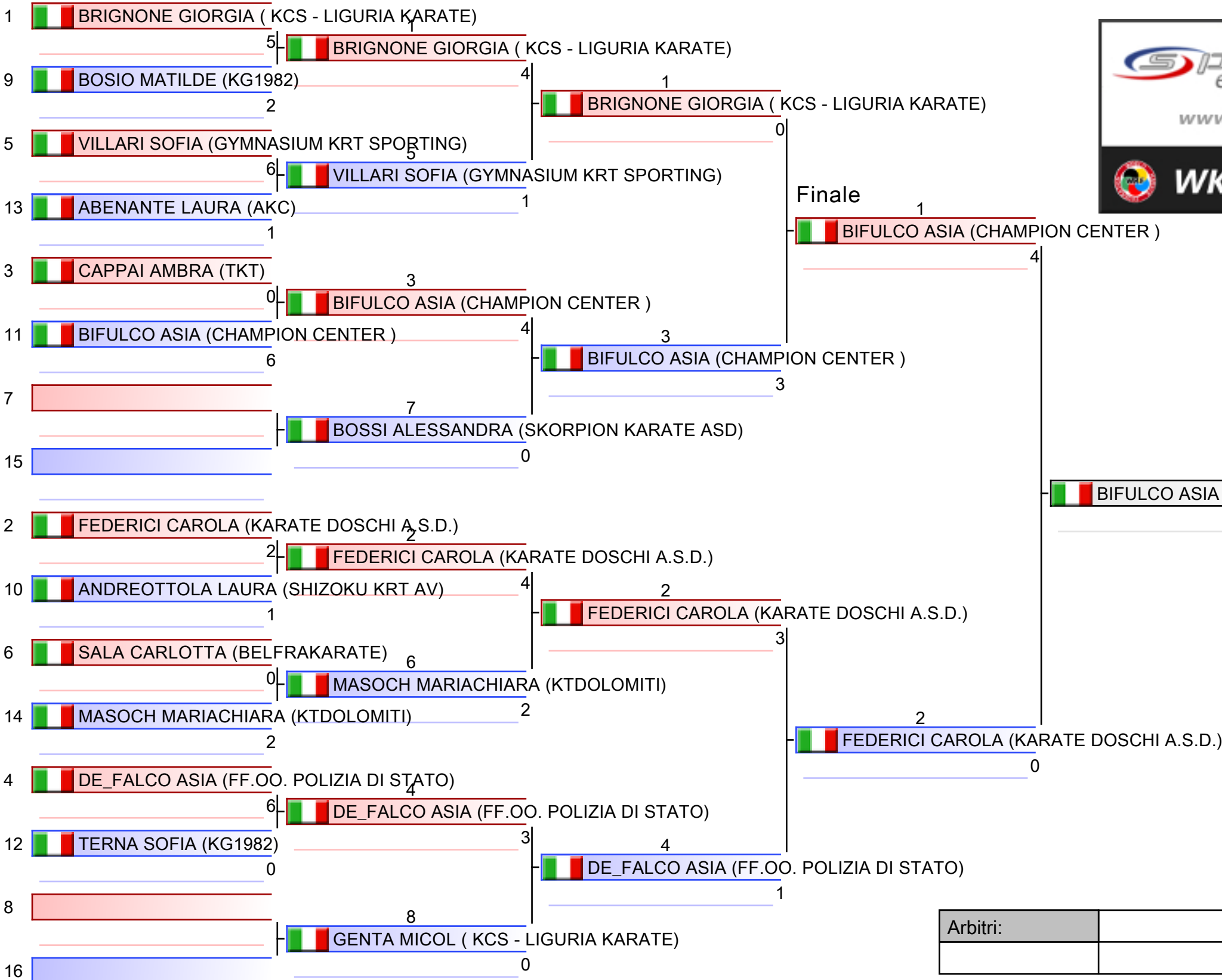

- | |
|--------------------------------------------|
| 1. BIFULCO ASIA (CHAMPION CENTER) |
| 2. FEDERICI CAROLA (KARATE DOSCHI A.S.D.) |
| 3. BOSSI ALESSANDRA (SKORPION KARATE ASD) |
| 3. DE_FALCO ASIA (FF.OO. POLIZIA DI STATO) |
| 5. BRIGNONE GIORGIA (KCS - LIGURIA KARATE) |
| 5. ANDREOTTOLA LAURA (SHIZOKU KRT AV) |
| 7. CAPPAI AMBRA (TKT) |
| 7. MASOCH MARIACHIARA (KTDOLOMITI) |

Arbitri:			

Kumite Individual female Juniors -48

VENETO OPEN

2023-05-20

Tatami
3 17:50

Tabelloni - Pool
1

(c)sportdata GmbH & Co KG 2000-2023 (2023-05-21 20:06) v 10.0.0 build 1 (2023-02-10) Licenza: Fijlkam Karate 2023 (expire 2023-12-31)

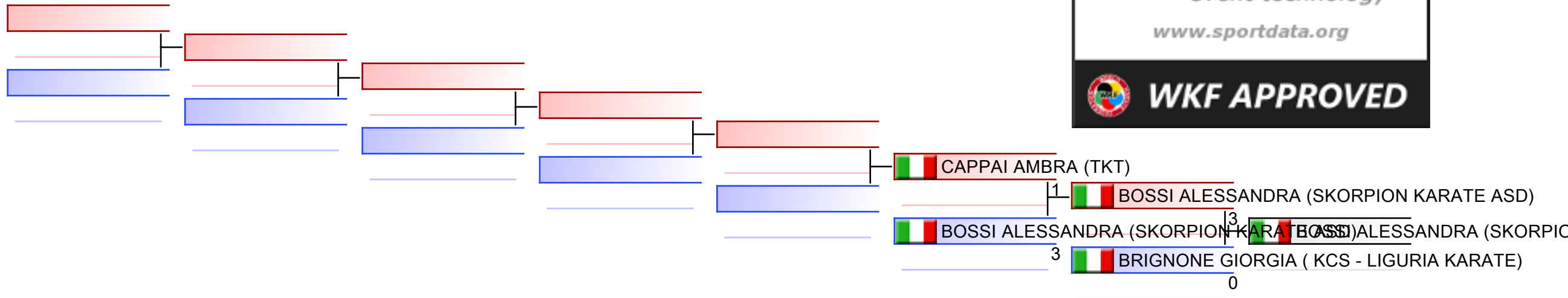

Ripescaggi: (1)

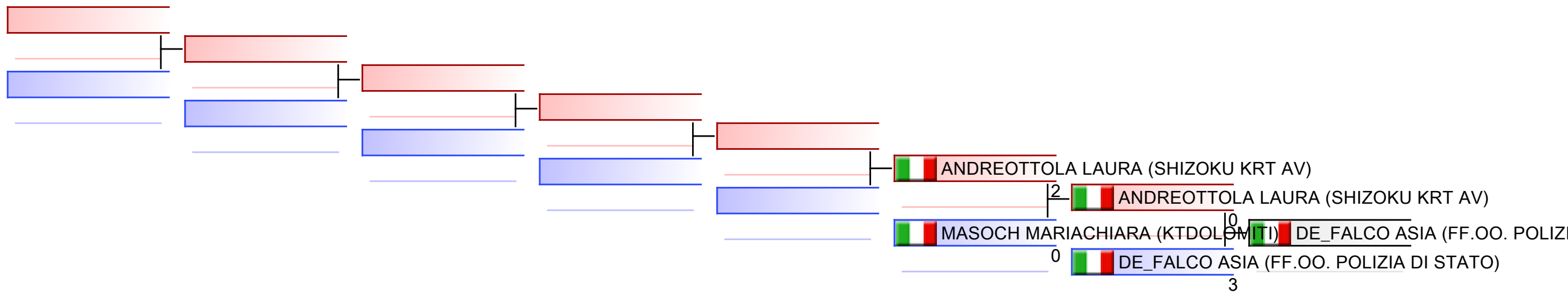

Arbitri:							
----------	--	--	--	--	--	--	--

Kumite Individual female Juniors -53

VENETO OPEN, Via S. Marco, 53, 35129 Padova PD, ITA

2023-05-20

Tatami
5 14:25

Tabelloni - Pool
1/1

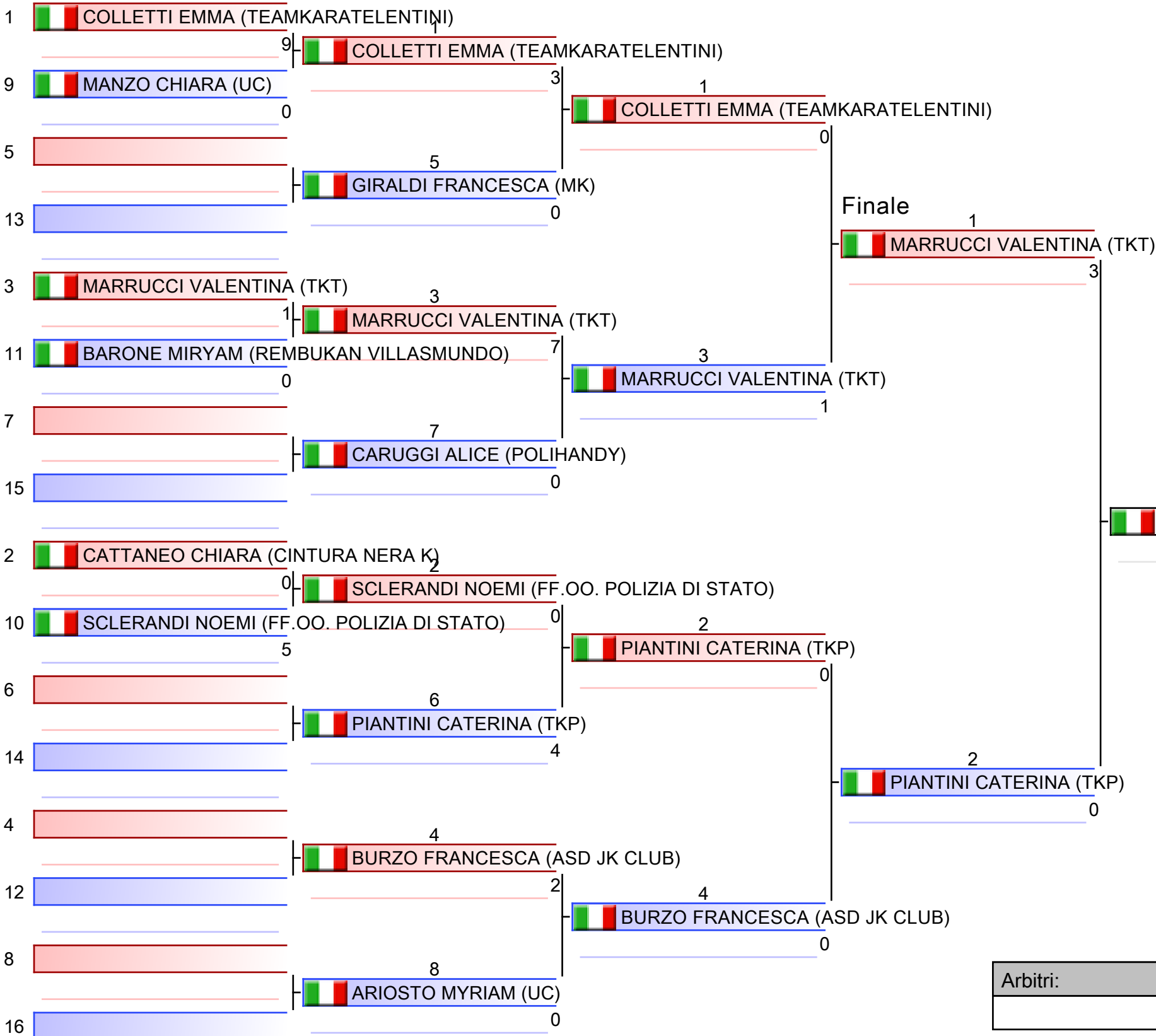

1. MARRUCCI VALENTINA (TKT)
2. PIANTINI CATERINA (TKP)
3. SCLERANDI NOEMI (FF.OO. POLIZIA DI STATO)
3. COLLETTI EMMA (TEAMKARATELENTINI)
5. BURZO FRANCESCA (ASD JK CLUB)
5. BARONE MIRYAM (REMBUKAN VILLASMUNDO)
7. CARUGGI ALICE (POLIHANDY)

Arbitri:			

Kumite Individual female Juniors -53

VENETO OPEN

2023-05-20

Tatami
3 16:50

Tabelloni - Pool
1

(c)sportdata GmbH & Co KG 2000-2023 (2023-05-21 20:06) v 10.0.0 build 1 (2023-02-10) Licenza: Fijlkam Karate 2023 (expire 2023-12-31)

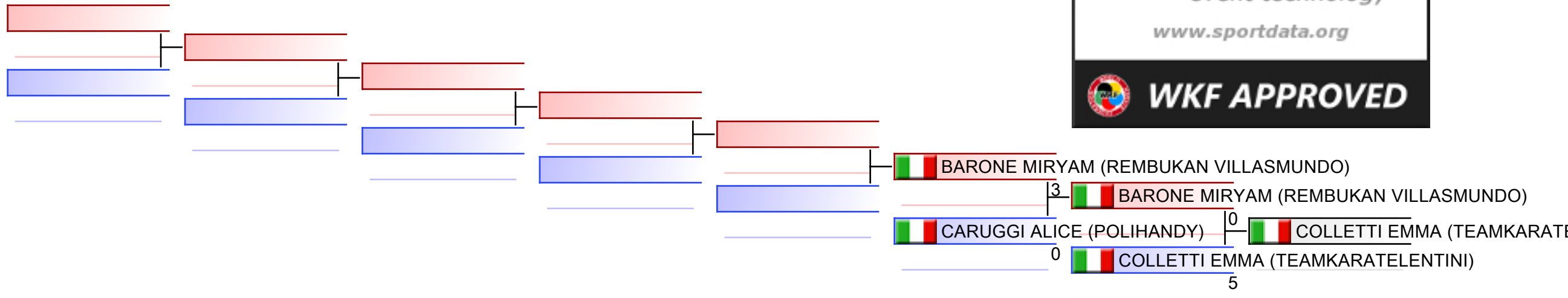

Ripescaggi: (1)

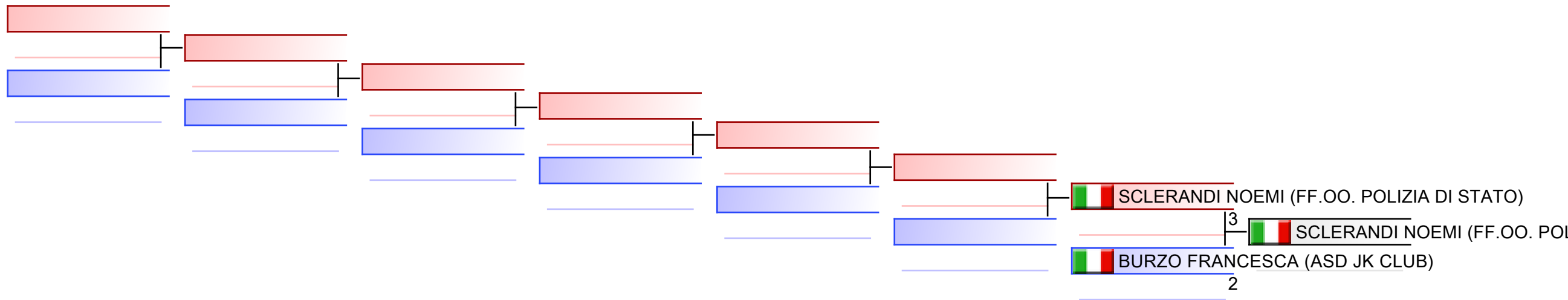

Arbitri:							
----------	--	--	--	--	--	--	--

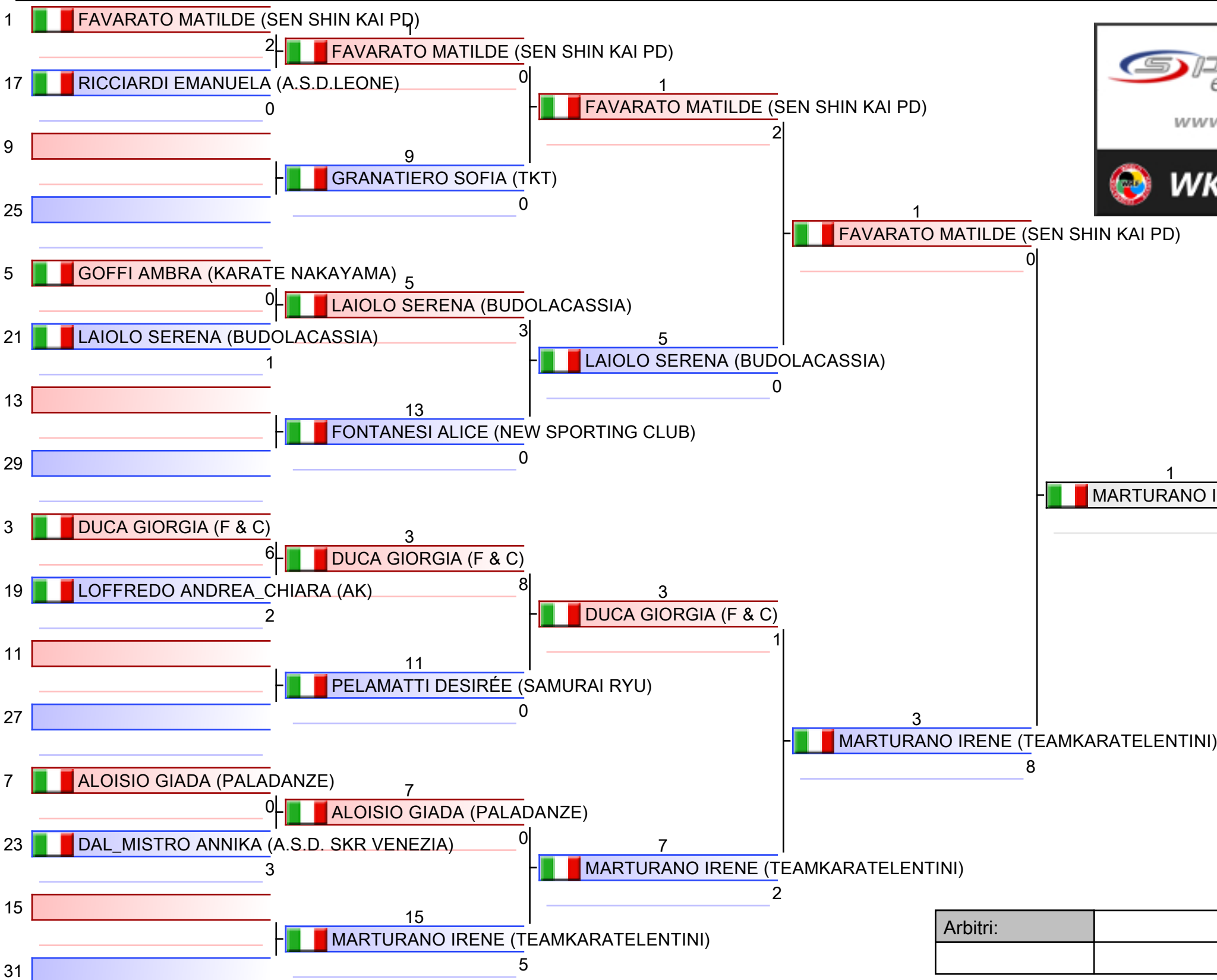

1. MARTURANO IRENE (TEAMKARATELENTINI)
2. CAPITANIO MATILDE (KTN)
3. ALOISIO GIADA (PALADANZE)
3. CRAIU BIATRIS_IONELA_ (LE ARTI NEW SCHO)
5. FAVARATO MATILDE (SEN SHIN KAI PD)
5. CARTA BEATRICE (C.S.K.T. JGOR CARTA)
7. DUCA GIORGIA (F & C)
7. BALLESTRIERI SOFIA (SHINANBAN K.)

Arbitri:			

Kumite Individual female Juniors -59

VENETO OPEN, Via S. Marco, 53, 35129 Padova PD, ITA

2023-05-20

Tatami
6 15:20

Tabelloni - Pool
2/2

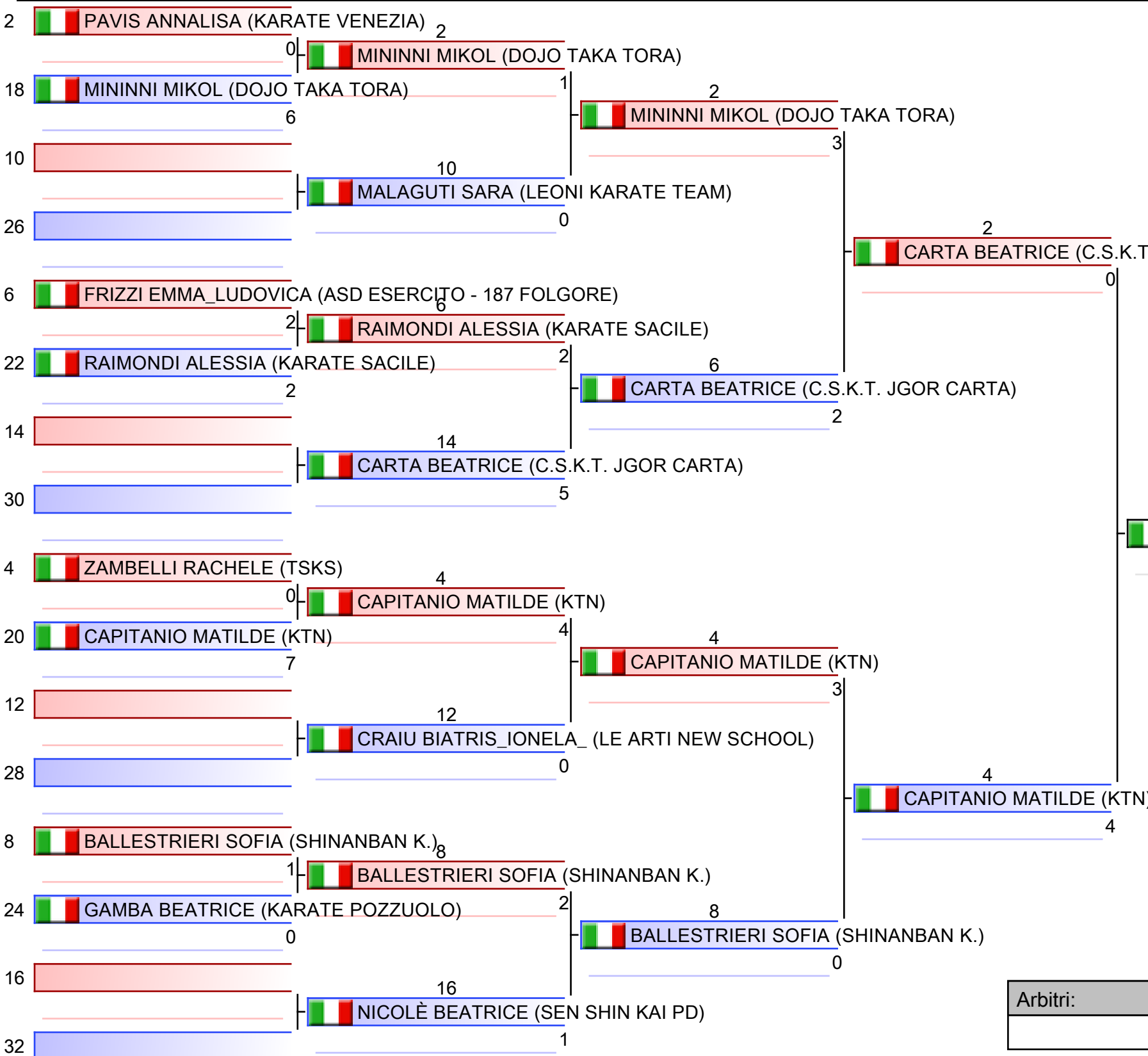

- | |
|-----------------------------------------------|
| 1. MARTURANO IRENE (TEAMKARATELENTINI) |
| 2. CAPITANIO MATILDE (KTN) |
| 3. ALOISIO GIADA (PALADANZE) |
| 3. CRAIU BIATRIS_IONELA_ (LE ARTI NEW SCHOOL) |
| 5. FAVARATO MATILDE (SEN SHIN KAI PD) |
| 5. CARTA BEATRICE (C.S.K.T. JGOR CARTA) |
| 7. DUCA GIORGIA (F & C) |
| 7. BALLESTRIERI SOFIA (SHINANBAN K.) |

Arbitri:			

Vincitore di pool-Kumite Individual female Juniors -59

VENETO OPEN, Via S. Marco, 53, 35129 Padova PD, ITA

Tatami

Tabelloni - Pool

1/1

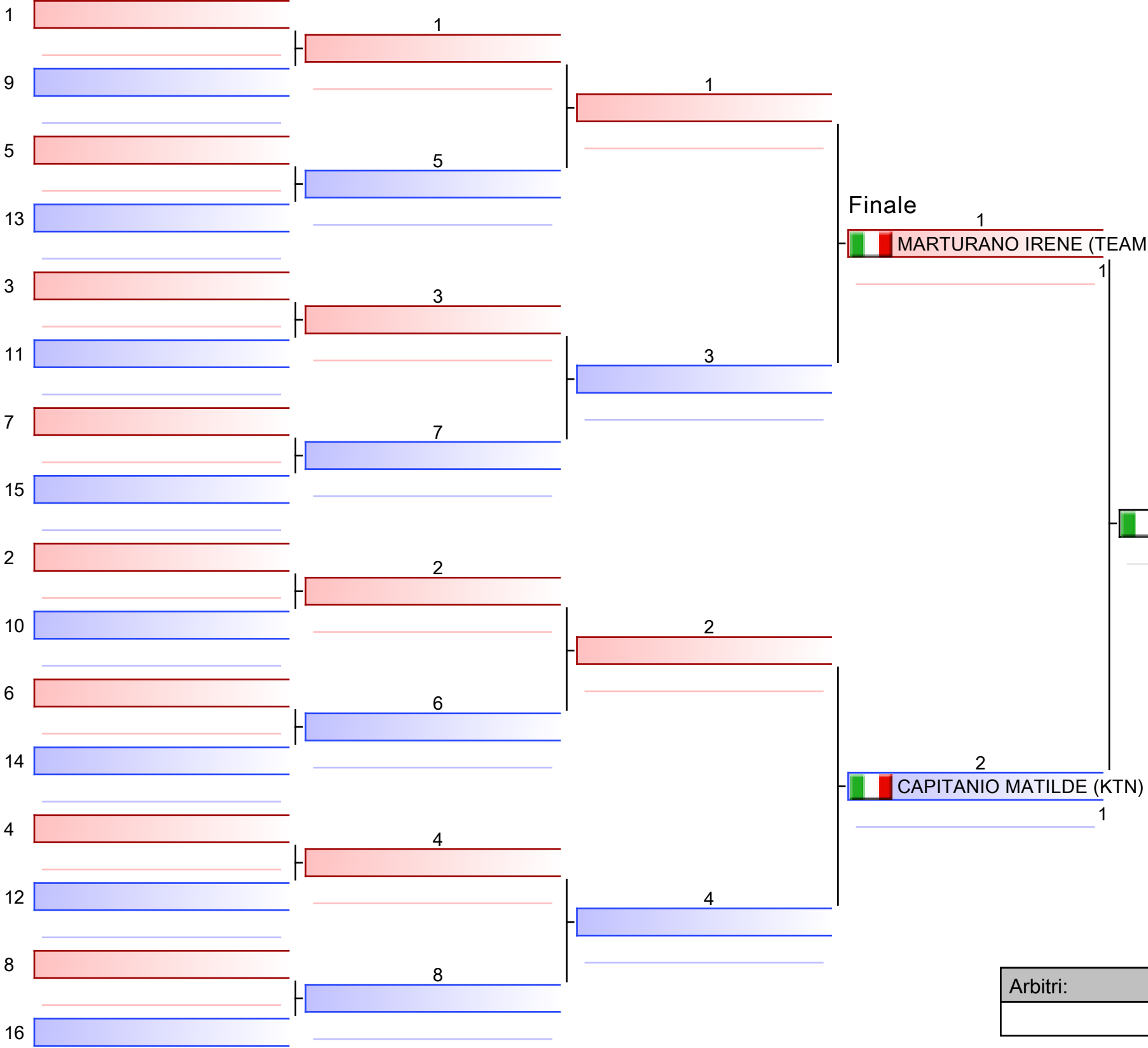

- | |
|---------------------------------------------|
| 1. MARTURANO IRENE (TEAMKARATELENTINI) |
| 2. CAPITANIO MATILDE (KTN) |
| 3. ALOISIO GIADA (PALADANZE) |
| 3. CRAIU BIATRIS_IONELA_ (LE ARTI NEW SCHO) |
| 5. FAVARATO MATILDE (SEN SHIN KAI PD) |
| 5. CARTA BEATRICE (C.S.K.T. JGOR CARTA) |
| 7. DUCA GIORGIA (F & C) |
| 7. BALLESTRIERI SOFIA (SHINANBAN K.) |

Arbitri:			

Kumite Individual female Juniors -59

VENETO OPEN

2023-05-20

Tatami
2 16:40

Tabelloni - Pool
1,2

(c)sportdata GmbH & Co KG 2000-2023 (2023-05-21 20:06) v 10.0.0 build 1 (2023-02-10) Licenza: Fijlkam Karate 2023 (expire 2023-12-31)

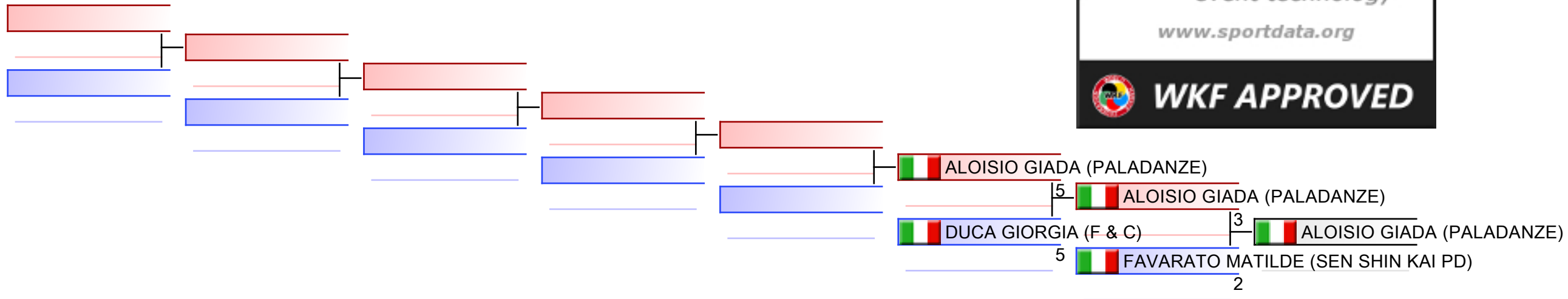

Ripescaggi: (1,2)

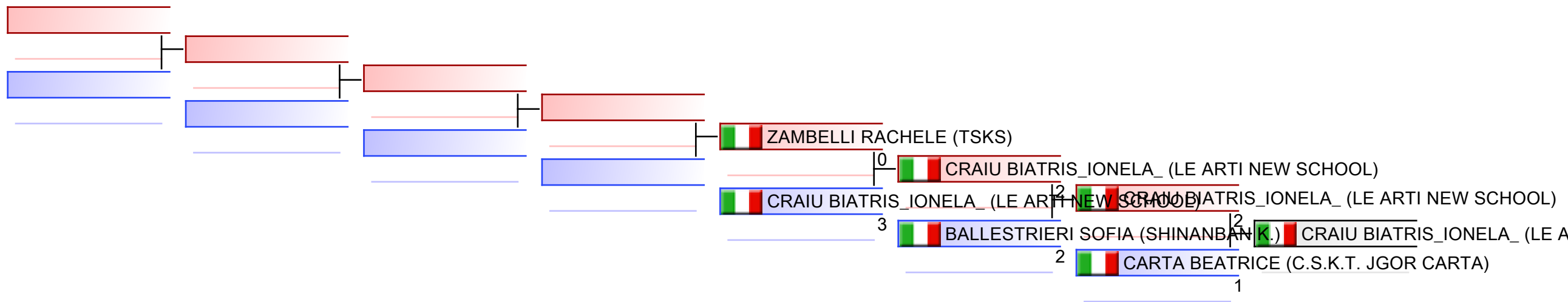

Arbitri:							
----------	--	--	--	--	--	--	--

Kumite Individual female Juniors -66

VENETO OPEN, Via S. Marco, 53, 35129 Padova PD, ITA

2023-05-20

Tatami
2 14:25

Tabelloni - Pool
1/1

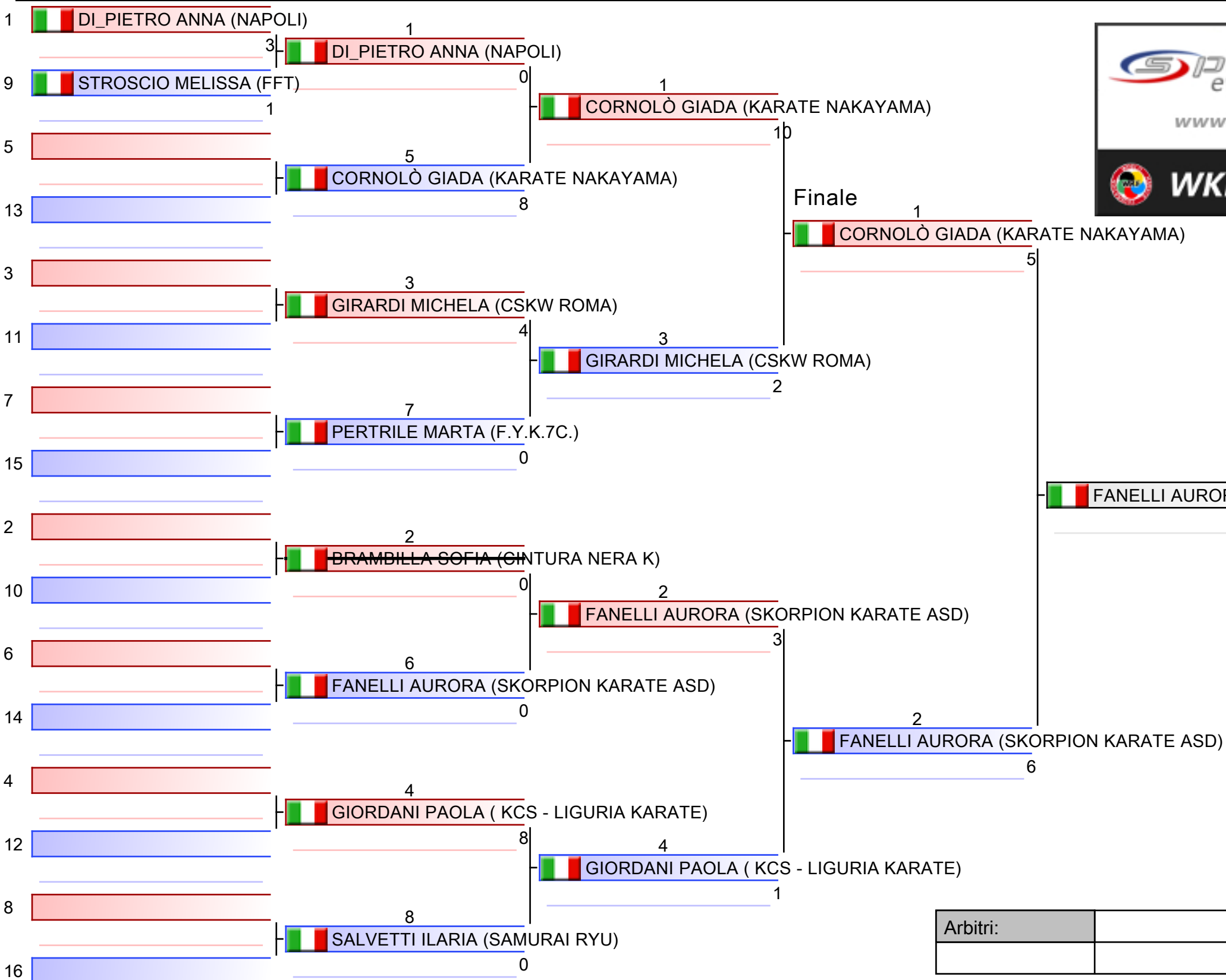

1. FANELLI AURORA (SKORPION KARATE ASD)
2. CORNOLÒ GIADA (KARATE NAKAYAMA)
3. GIORDANI PAOLA (KCS - LIGURIA KARATE)
3. GIRARDI MICHELA (CSKW ROMA)
5. DI PIETRO ANNA (NAPOLI)

Arbitri:			

Kumite Individual female Juniors -66

VENETO OPEN

2023-05-20

Tatami
3 17:30

Tabelloni - Pool
1

(c)sportdata GmbH & Co KG 2000-2023 (2023-05-21 20:06) v 10.0.0 build 1 (2023-02-10) Licenza: Fijlkam Karate 2023 (expire 2023-12-31)

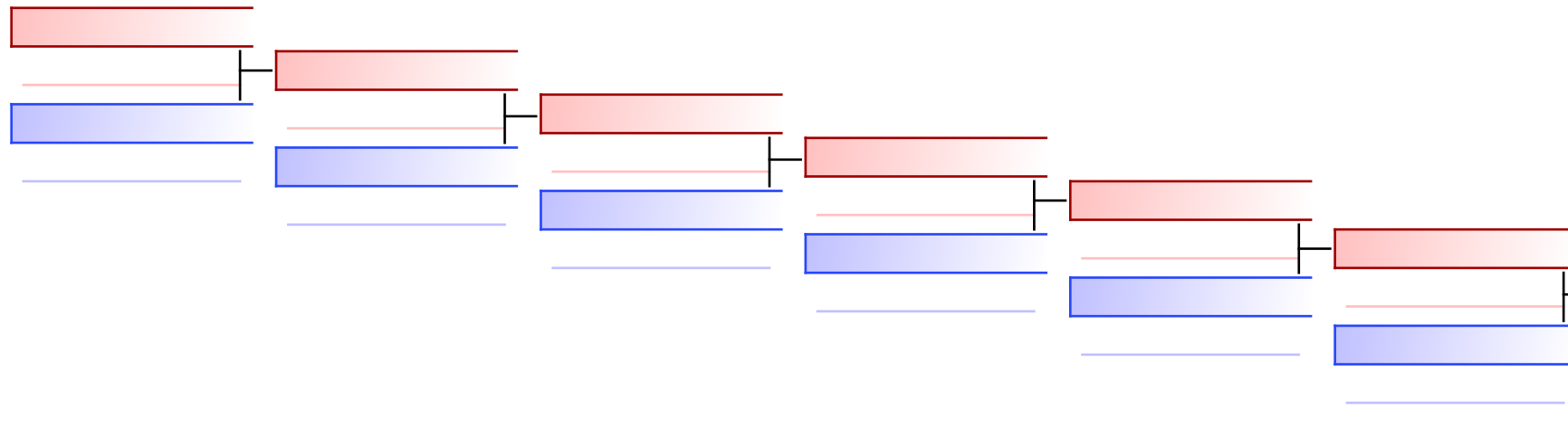

DI_PIETRO ANNA (NAPOLI)
3
GIRARDI MICHELA (CSKW ROMA)
8
GIRARDI MICHELA (CSKW ROMA)

Ripescaggi: (1)

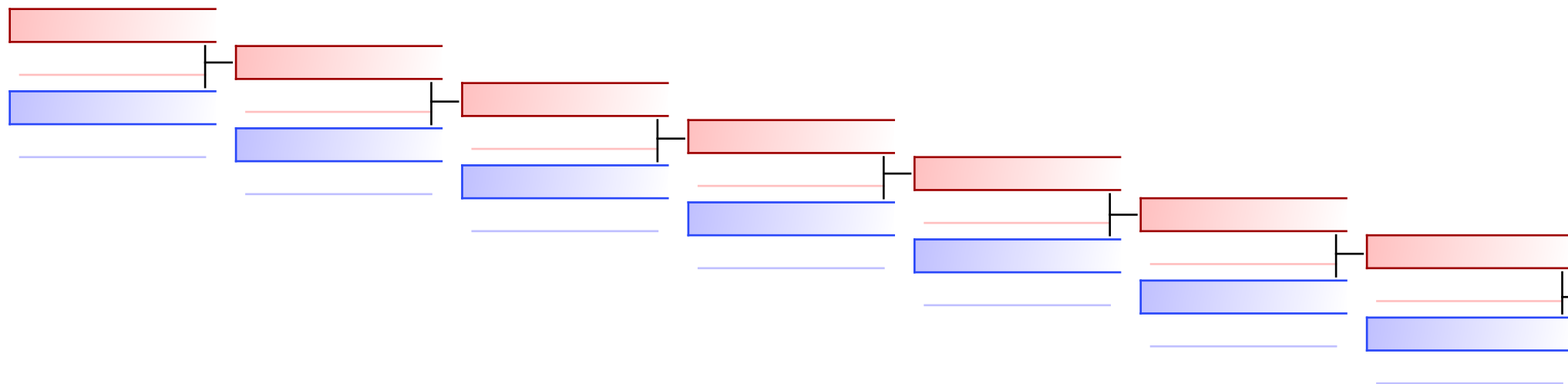

GIORDANI PAOLA (KCS - LIGURIA)

Arbitri:							
----------	--	--	--	--	--	--	--

Kumite Individual female Seniors +68

VENETO OPEN, Via S. Marco, 53, 35129 Padova PD, ITA

2023-05-19

Tatami
2 17:55

Tabelloni - Pool
1/1

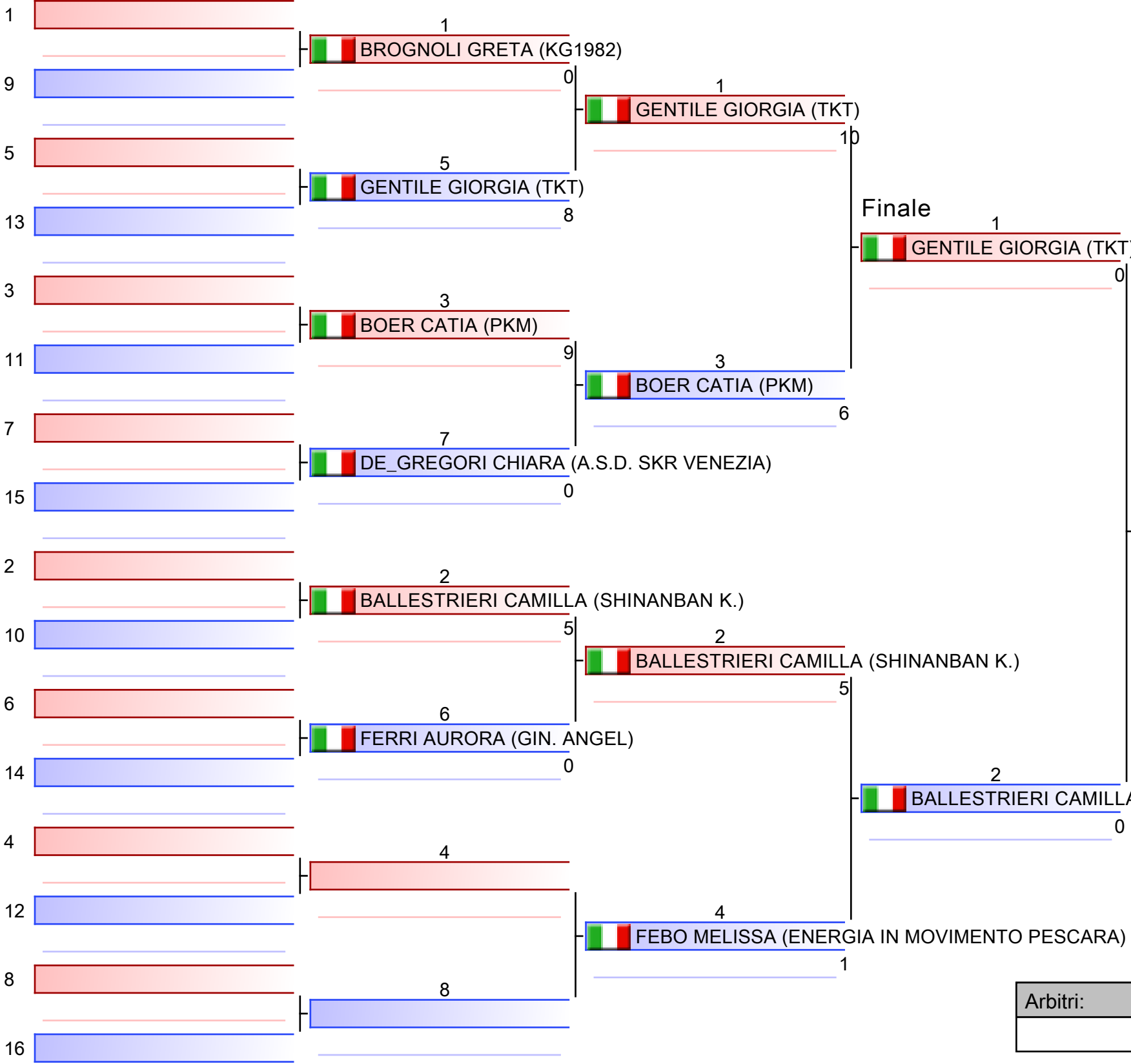

1. GENTILE GIORGIA (TKT)
2. BALLESTRIERI CAMILLA (SHINANBAN K.)
3. BOER CATIA (PKM)
3. FERRI AURORA (GIN. ANGEL)
5. BROGNOLI GRETA (KG1982)
5. FEBO MELISSA (ENERGIA IN MOVIMENTO PESCARA)

Arbitri:			

Kumite Individual female Seniors +68

VENETO OPEN

2023-05-19

Tatami
2 18:25

Tabelloni - Pool
1

(c)sportdata GmbH & Co KG 2000-2023 (2023-05-21 20:06) v 10.0.0 build 1 (2023-02-10) Licenza: Fijlkam Karate 2023 (expire 2023-12-31)

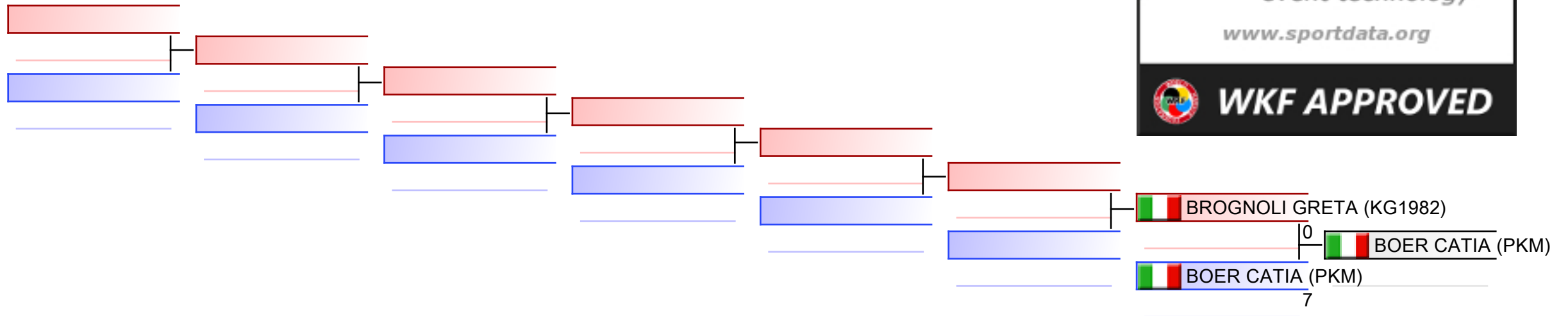

Ripescaggi: (1)

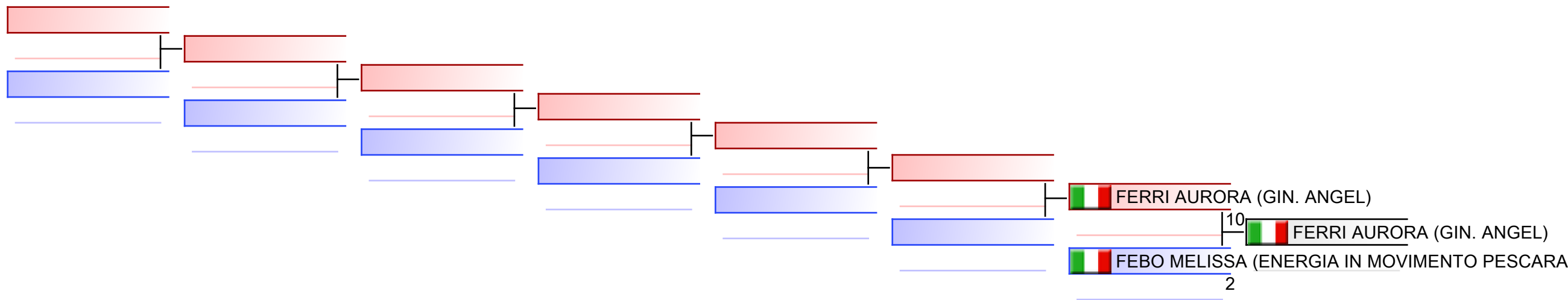

Arbitri:							
----------	--	--	--	--	--	--	--

Kumite Individual female Seniors -50

VENETO OPEN, Via S. Marco, 53, 35129 Padova PD, ITA

2023-05-19

Tatami
5 17:30

Tabelloni - Pool
1/1

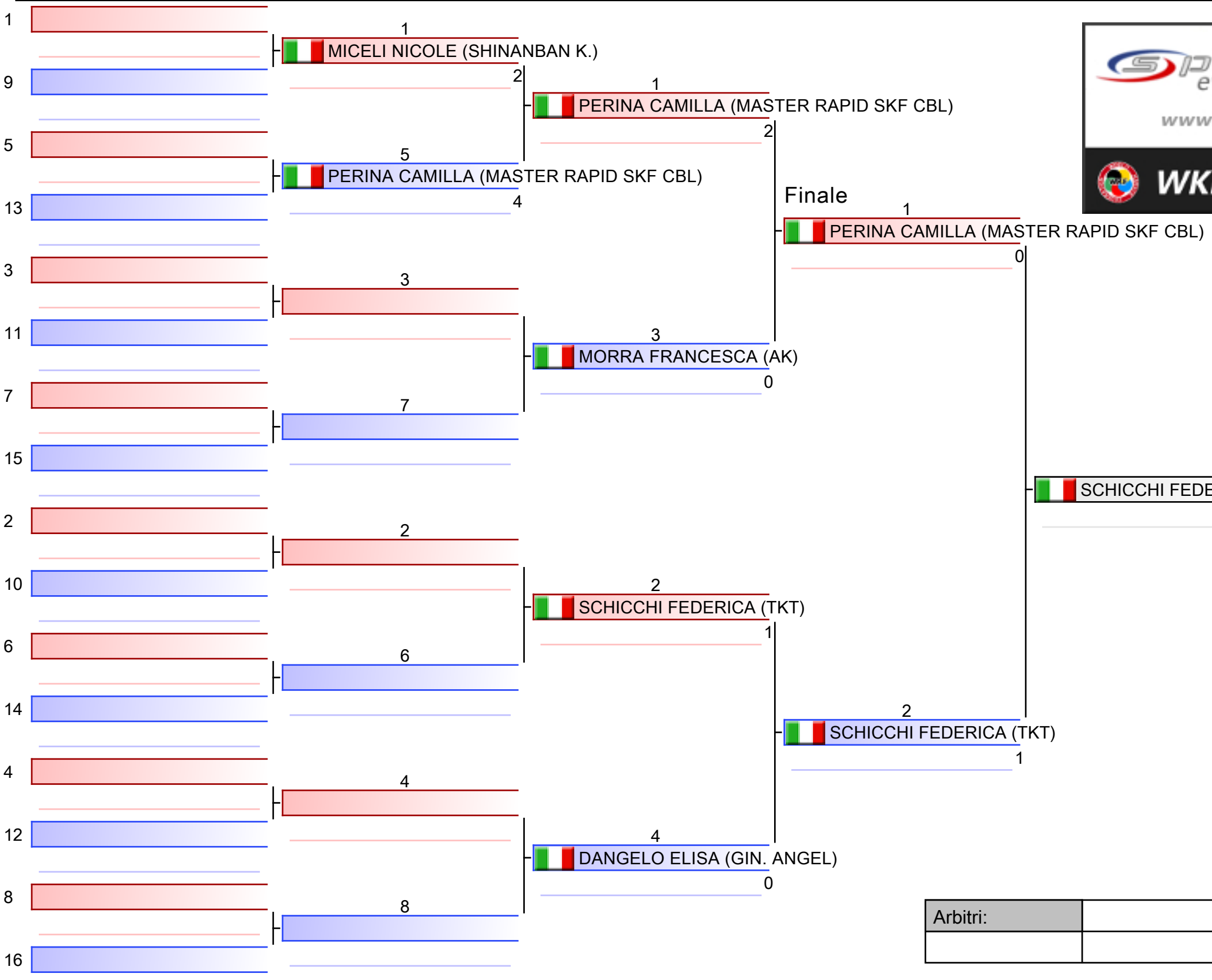

1. SCHICCHI FEDERICA (TKT)
2. PERINA CAMILLA (MASTER RAPID SKF CBL)
3. DANGELO ELISA (GIN. ANGEL)
3. MORRA FRANCESCA (AK)
5. MICELI NICOLE (SHINANBAN K.)

Arbitri:			

Kumite Individual female Seniors -50

VENETO OPEN

2023-05-19

Tatami
5 17:50

Tabelloni - Pool
1

(c)sportdata GmbH & Co KG 2000-2023 (2023-05-21 20:06) v 10.0.0 build 1 (2023-02-10) Licenza: Fijlkam Karate 2023 (expire 2023-12-31)

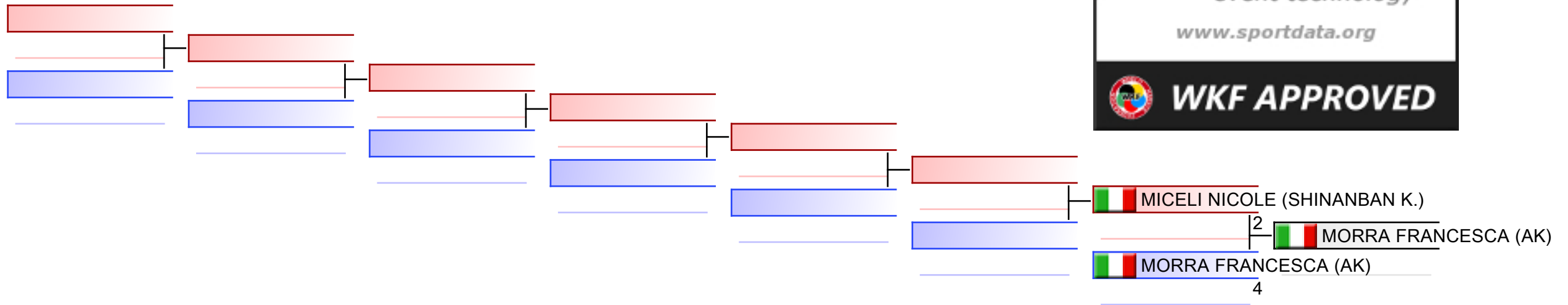

Ripescaggi: (1)

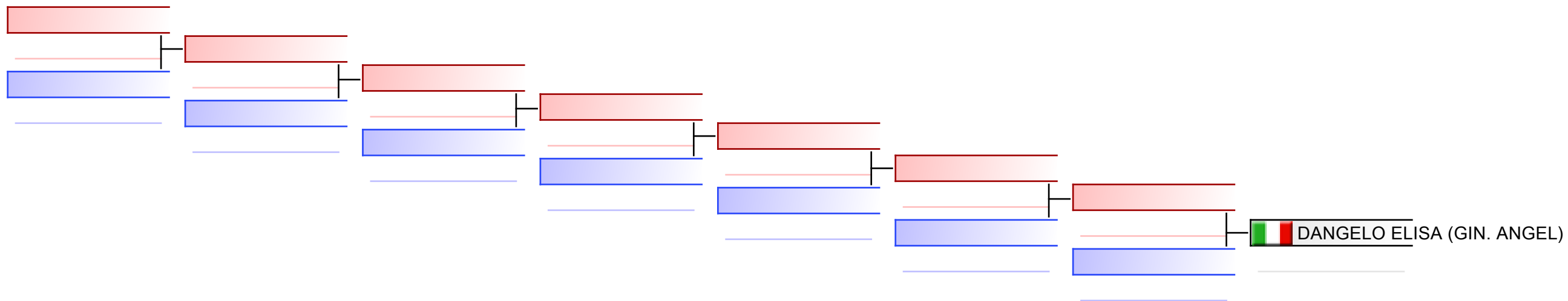

Arbitri:							
----------	--	--	--	--	--	--	--

Kumite Individual female Seniors -55

VENETO OPEN, Via S. Marco, 53, 35129 Padova PD, ITA

2023-05-19

Tatami
4 17:40

Tabelloni - Pool
1/1

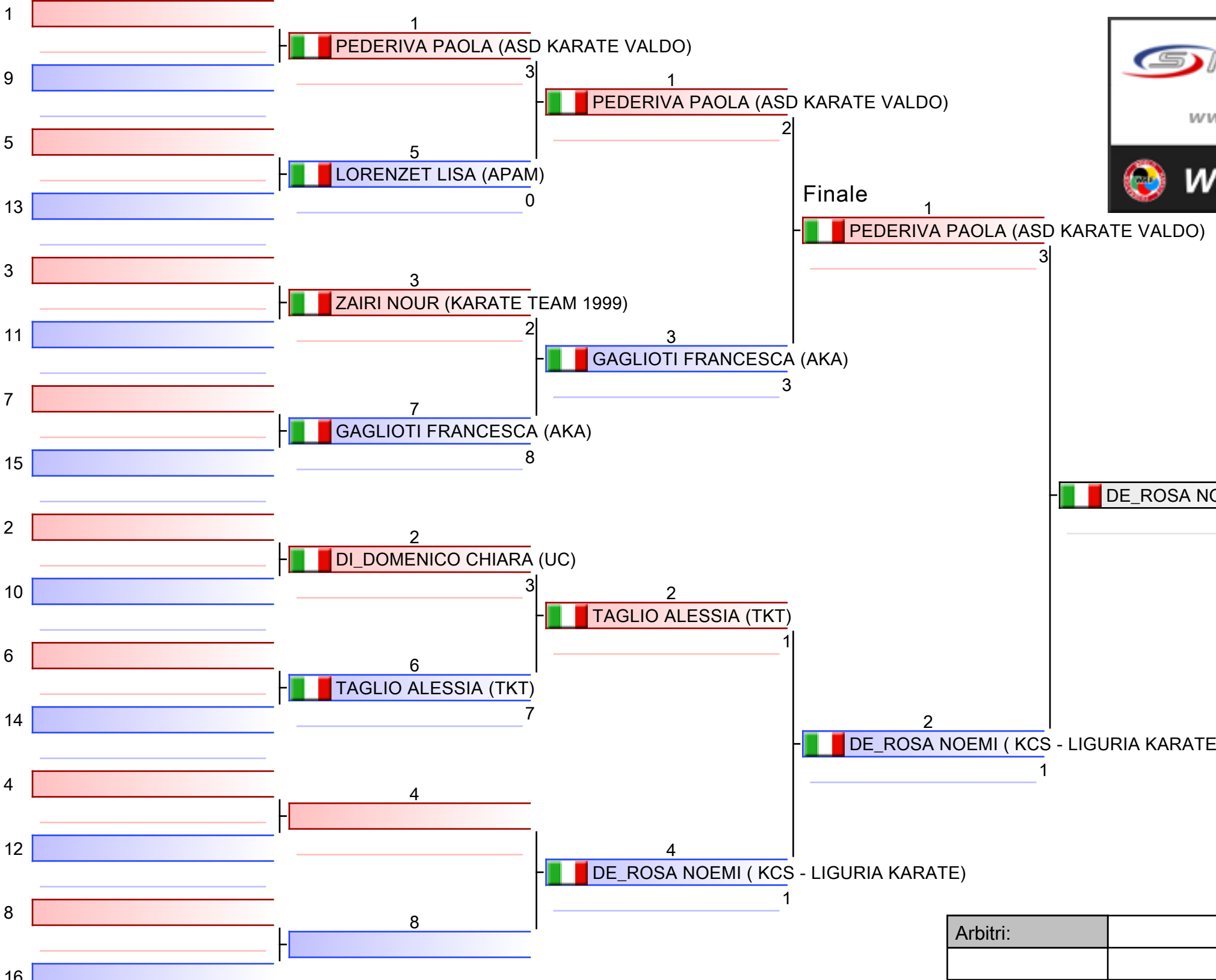

- | |
|------------------------------------------|
| 1. DE_ROSA NOEMI (KCS - LIGURIA KARATE) |
| 2. PEDERIVA PAOLA (ASD KARATE VALDO) |
| 3. TAGLIO ALESSIA (TKT) |
| 3. GAGLIOTI FRANCESCA (AKA) |
| 5. LORENZET LISA (APAM) |
| |
| |

Arbitri:			

Kumite Individual female Seniors -55

VENETO OPEN

2023-05-19

Tatami
4 18:10

Tabelloni - Pool
1

(c)sportdata GmbH & Co KG 2000-2023 (2023-05-21 20:06) v 10.0.0 build 1 (2023-02-10) Licenza: Fijlkam Karate 2023 (expire 2023-12-31)

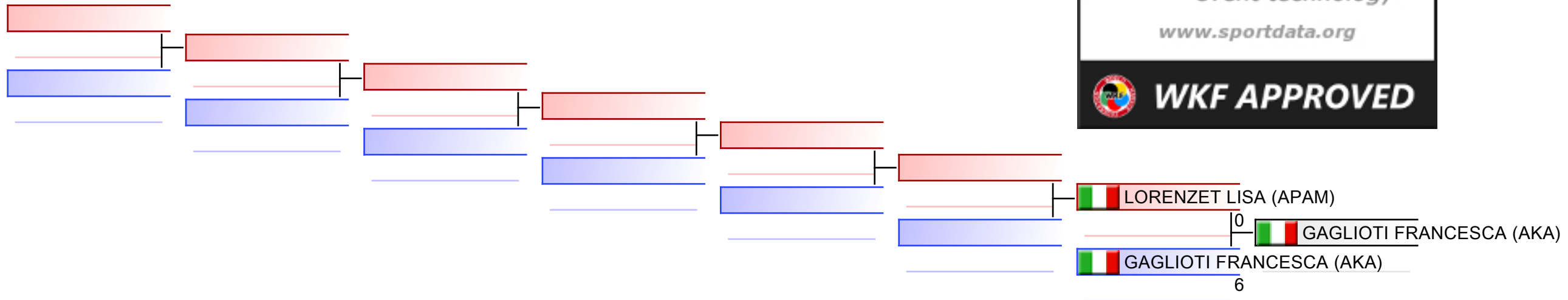

Ripescaggi: (1)

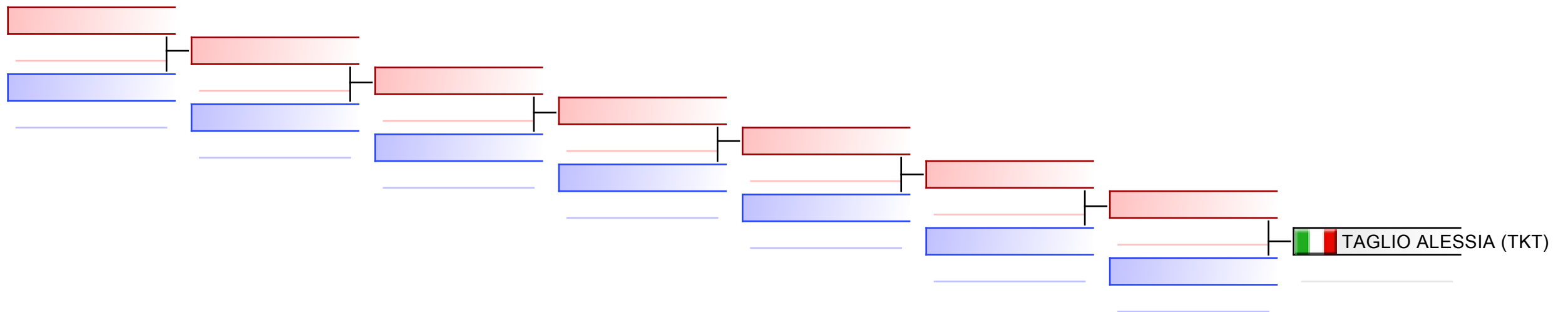

Arbitri:							
----------	--	--	--	--	--	--	--









Kumite Individual female Seniors -61 - Girone all'Italiana (tutti contro tutti)

VENETO OPEN, Via S. Marco, 53, 35129 Padova PD, ITA

2023-05-19

Tatami
3 17:45

Tabelloni - Pool
1/1

- 1  CESANELLI GIADA (CESANELLI) 0 |  PENDOLI AURORA (MASTER RAPID SKF CBL)
- 2  PENDOLI AURORA (MASTER RAPID SKF CBL) 3
- 3  DESTE FEDERICA (K 01) 3 |  DESTE FEDERICA (K 01)
- 4  CESANELLI GIADA (CESANELLI) 0
- 5  PENDOLI AURORA (MASTER RAPID SKF CBL) 1 |  DESTE FEDERICA (K 01)
- 6  DESTE FEDERICA (K 01) 1



1. DESTE FEDERICA (K 01)
2. PENDOLI AURORA (MASTER RAPID SKF CBL)
3. CESANELLI GIADA (CESANELLI)

Arbitri:			

Kumite Individual female U14 +52

VENETO OPEN, Via S. Marco, 53, 35129 Padova PD, ITA

2023-05-21

Tatami
1 09:00

Tabelloni - Pool
1/2

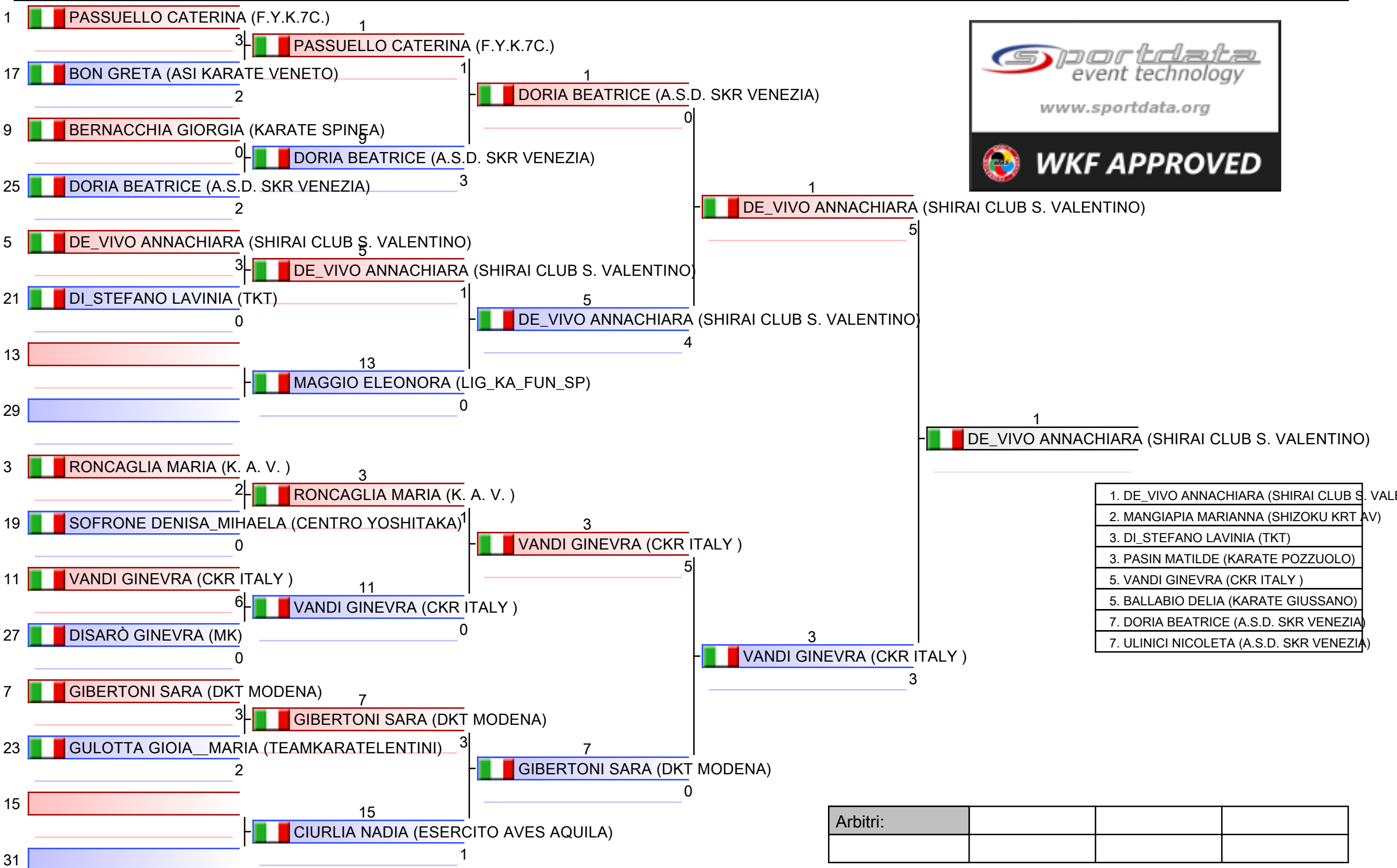

- 1. DE_VIVO ANNACHIARA (SHIRAI CLUB S. VALENTINO)
- 2. MANGIPIA MARIANNA (SHIZOKU KRT AV)
- 3. DI_STEFANO LAVINIA (TKT)
- 3. PASIN MATILDE (KARATE POZZUOLO)
- 5. VANDI GINEVRA (CKR ITALY)
- 5. BALLABIO DELIA (KARATE GIUSSANO)
- 7. DORIA BEATRICE (A.S.D. SKR VENEZIA)
- 7. ULINICI NICOLETA (A.S.D. SKR VENEZIA)

Arbitri:			

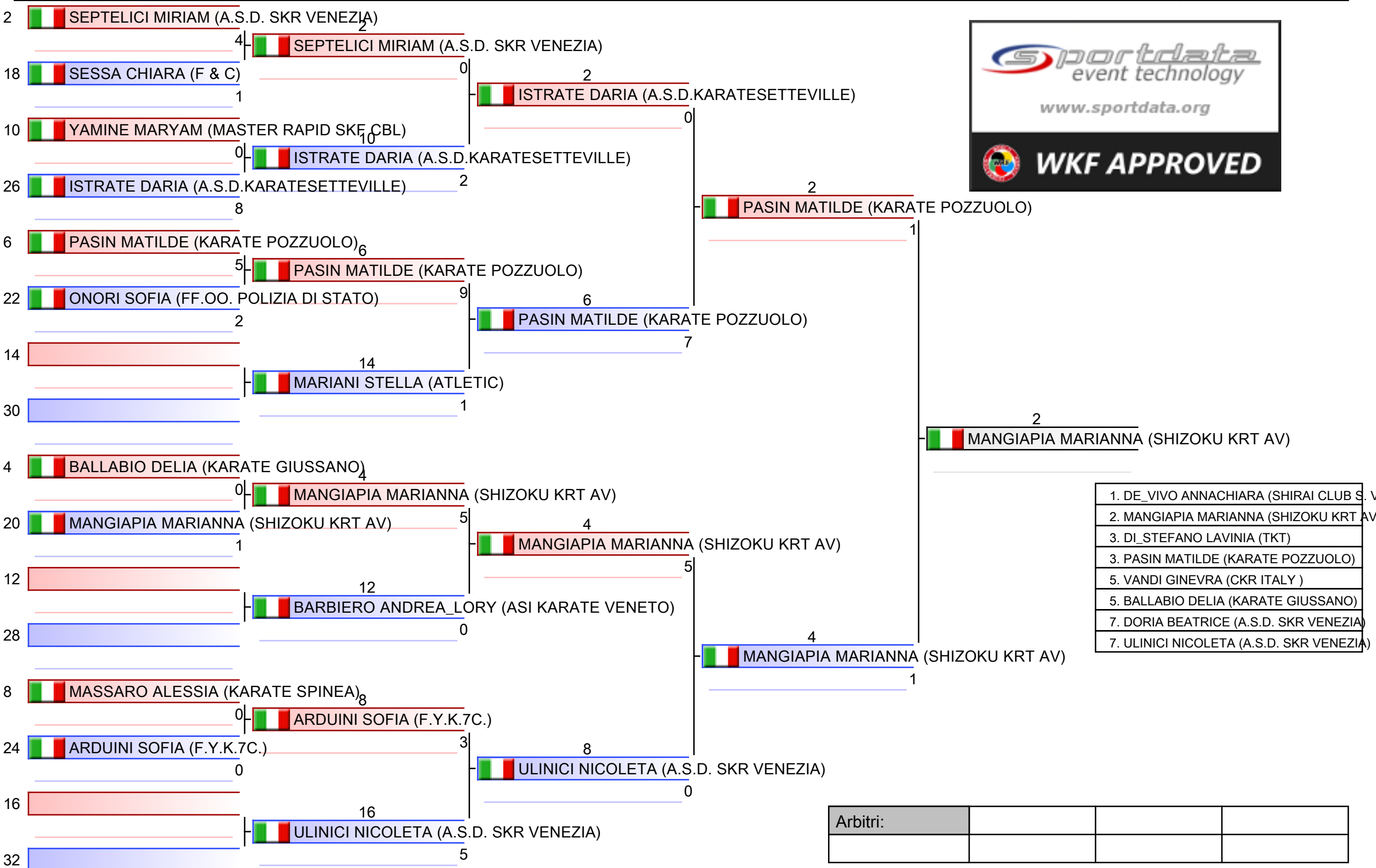

1. DE_VIVO ANNACHIARA (SHIRAI CLUB S. VALE)
2. MANGIAPIA MARIANNA (SHIZOKU KRT AV)
3. DI_STEFANO LAVINIA (TKT)
3. PASIN MATILDE (KARATE POZZUOLO)
5. VANDI GINEVRA (CKR ITALY)
5. BALLABIO DELIA (KARATE GIUSSANO)
7. DORIA BEATRICE (A.S.D. SKR VENEZIA)
7. ULINICI NICOLETA (A.S.D. SKR VENEZIA)

Arbitri:			

Vincitore di pool-Kumite Individual female U14 +52

VENETO OPEN, Via S. Marco, 53, 35129 Padova PD, ITA

Tatami

Tabelloni - Pool

1/1

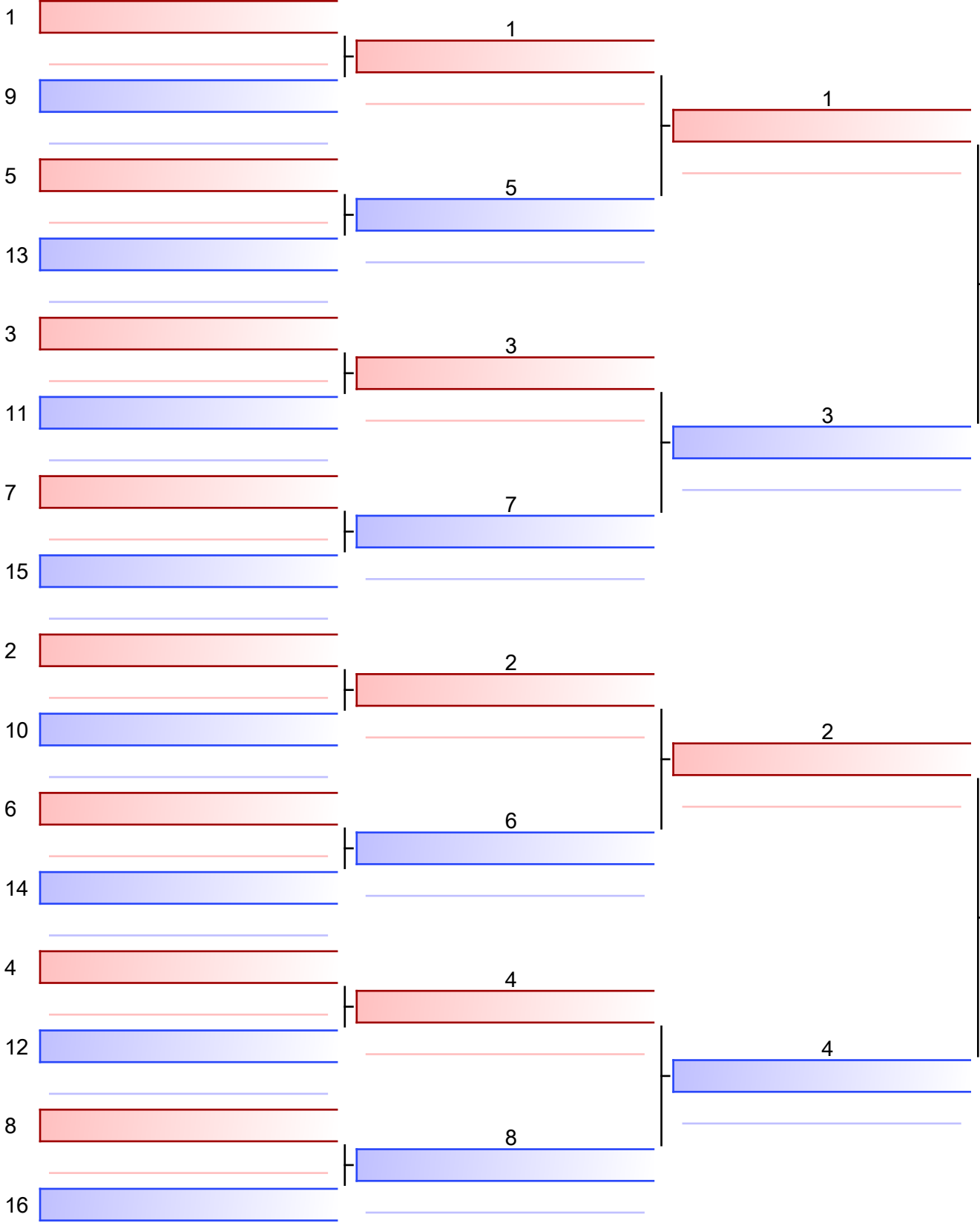

Finale

1 DE_VIVO ANNACHIARA (SHIRAI CLUB S. VALENTINO)

7

DE_VIVO ANNACHIARA (SHIRAI CLUB S. VALENTINO)

2 MANGIAPIA MARIANNA (SHIZOKU KRT AV)

0

- | |
|--------------------------------------------------|
| 1. DE_VIVO ANNACHIARA (SHIRAI CLUB S. VALENTINO) |
| 2. MANGIAPIA MARIANNA (SHIZOKU KRT AV) |
| 3. DI_STEFANO LAVINIA (TKT) |
| 3. PASIN MATILDE (KARATE POZZUOLO) |
| 5. VANDI GINEVRA (CKR ITALY) |
| 5. BALLABIO DELIA (KARATE GIUSSANO) |
| 7. DORIA BEATRICE (A.S.D. SKR VENEZIA) |
| 7. ULINICI NICOLETA (A.S.D. SKR VENEZIA) |

Arbitri:			

Kumite Individual female U14 +52

VENETO OPEN

2023-05-21

Tatami
1 11:00

Tabelloni - Pool
1,2

(c)sportdata GmbH & Co KG 2000-2023 (2023-05-21 20:06) v 10.0.0 build 1 (2023-02-10) Licenza: Fijlkam Karate 2023 (expire 2023-12-31)

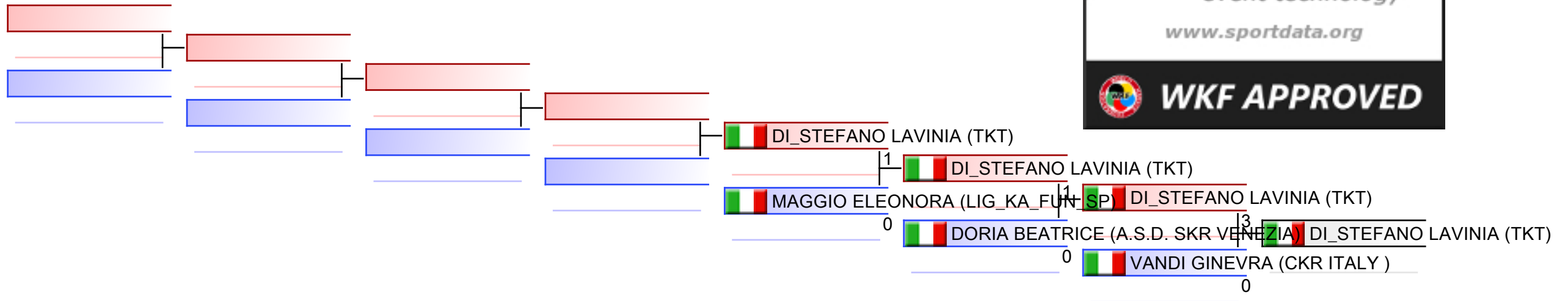

Ripescaggi: (1,2)

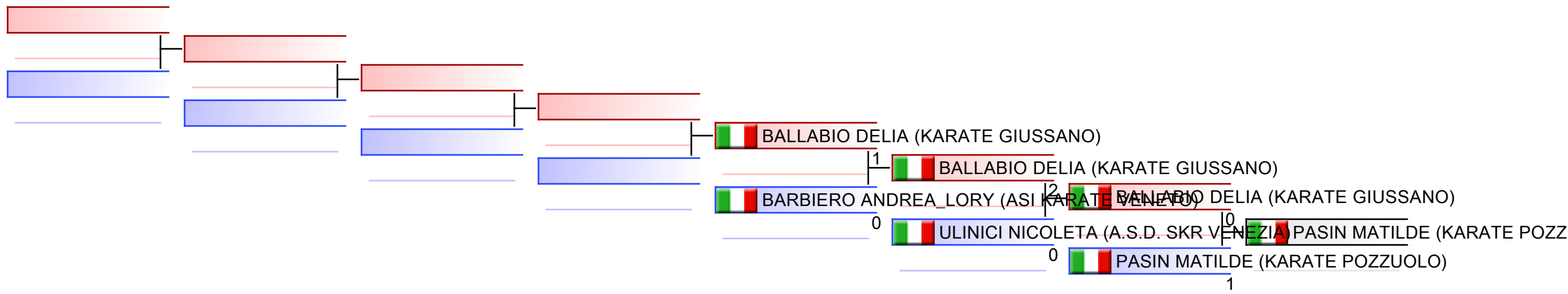

Arbitri:							
----------	--	--	--	--	--	--	--

Kumite Individual female U14 -42

VENETO OPEN, Via S. Marco, 53, 35129 Padova PD, ITA

2023-05-21

Tatami
5 09:00

Tabelloni - Pool
1/2

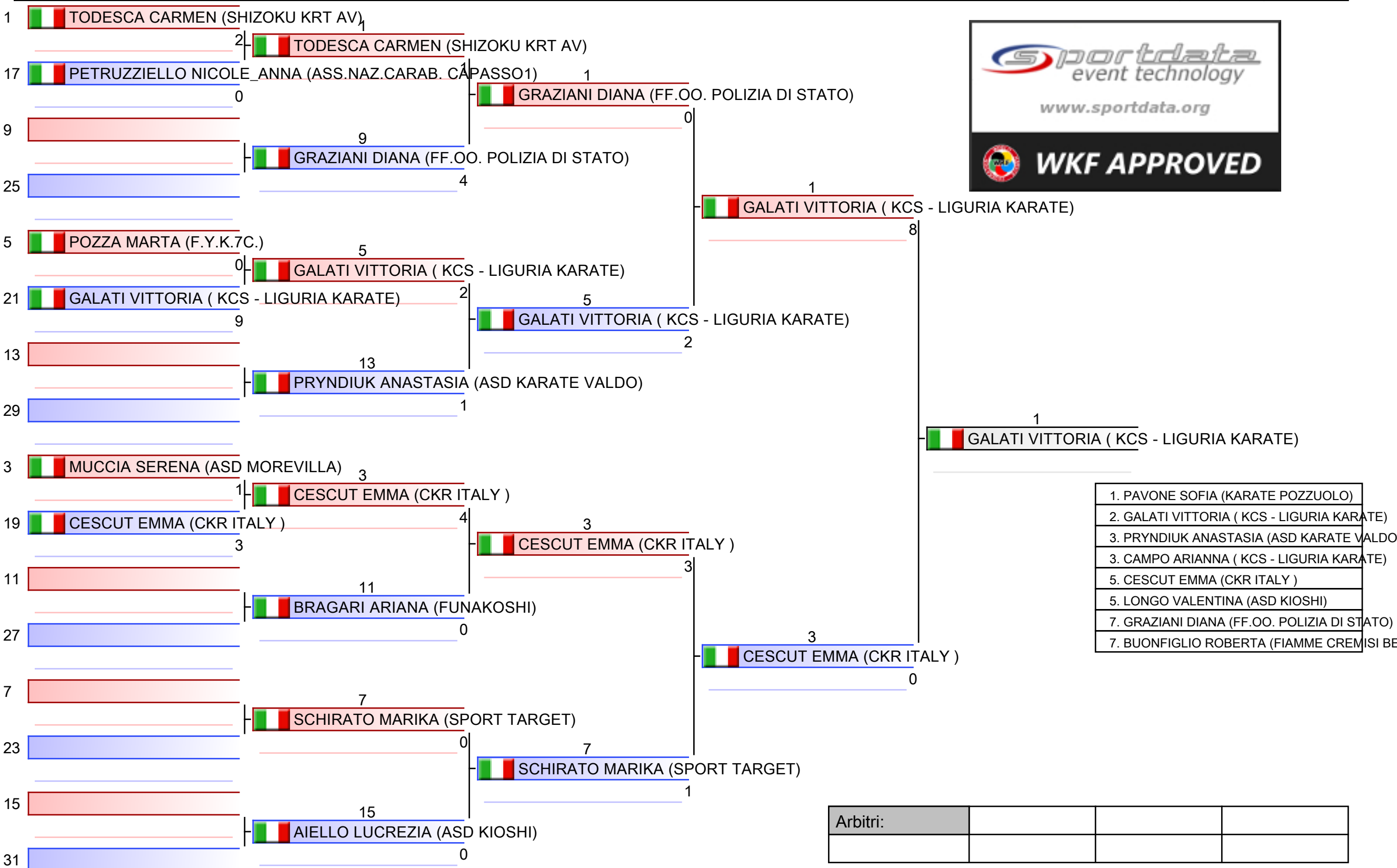

1. PAVONE SOFIA (KARATE POZZUOLO)
2. GALATI VITTORIA (KCS - LIGURIA KARATE)
3. PRYNDIUK ANASTASIA (ASD KARATE VALDO)
3. CAMPO ARIANNA (KCS - LIGURIA KARATE)
5. CESCUT EMMA (CKR ITALY)
5. LONGO VALENTINA (ASD KIOSHI)
7. GRAZIANI DIANA (FF.OO. POLIZIA DI STATO)
7. BUONFIGLIO ROBERTA (FIAMME CREMISI BE)

Arbitri:			

Kumite Individual female U14 -42

VENETO OPEN, Via S. Marco, 53, 35129 Padova PD, ITA

2023-05-21

Tatami
4 09:00

Tabelloni - Pool
2/2

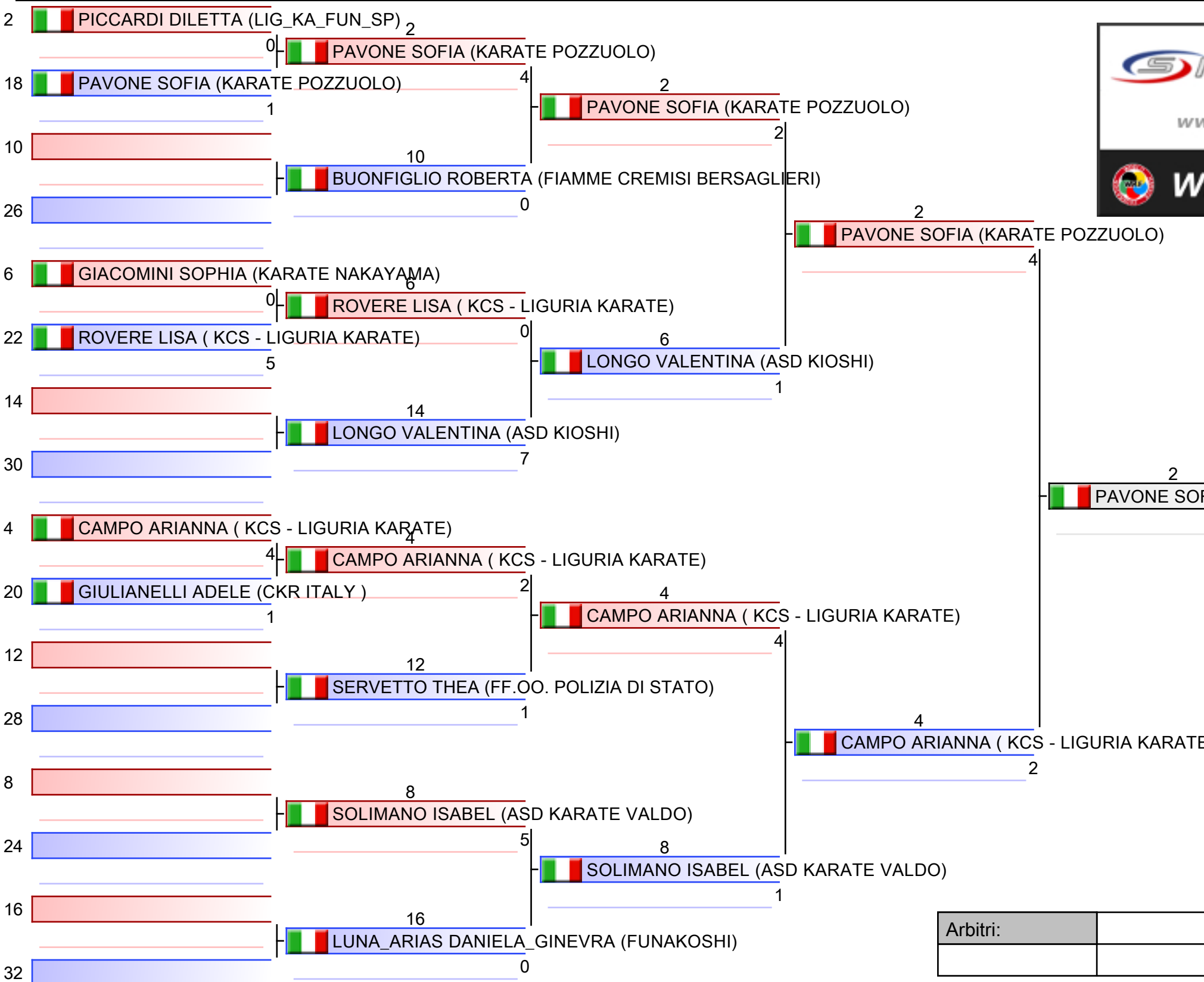

- | |
|---------------------------------------------|
| 1. PAVONE SOFIA (KARATE POZZUOLO) |
| 2. GALATI VITTORIA (KCS - LIGURIA KARATE) |
| 3. PRYNDIUK ANASTASIA (ASD KARATE VALDO) |
| 3. CAMPO ARIANNA (KCS - LIGURIA KARATE) |
| 5. CESCUT EMMA (CKR ITALY) |
| 5. LONGO VALENTINA (ASD KIOSHI) |
| 7. GRAZIANI DIANA (FF.OO. POLIZIA DI STATO) |
| 7. BUONFIGLIO ROBERTA (FIAMME CREMISI BEF) |

Arbitri:			

Vincitore di pool-Kumite Individual female U14 -42

VENETO OPEN, Via S. Marco, 53, 35129 Padova PD, ITA

Tatami

Tabelloni - Pool

1/1

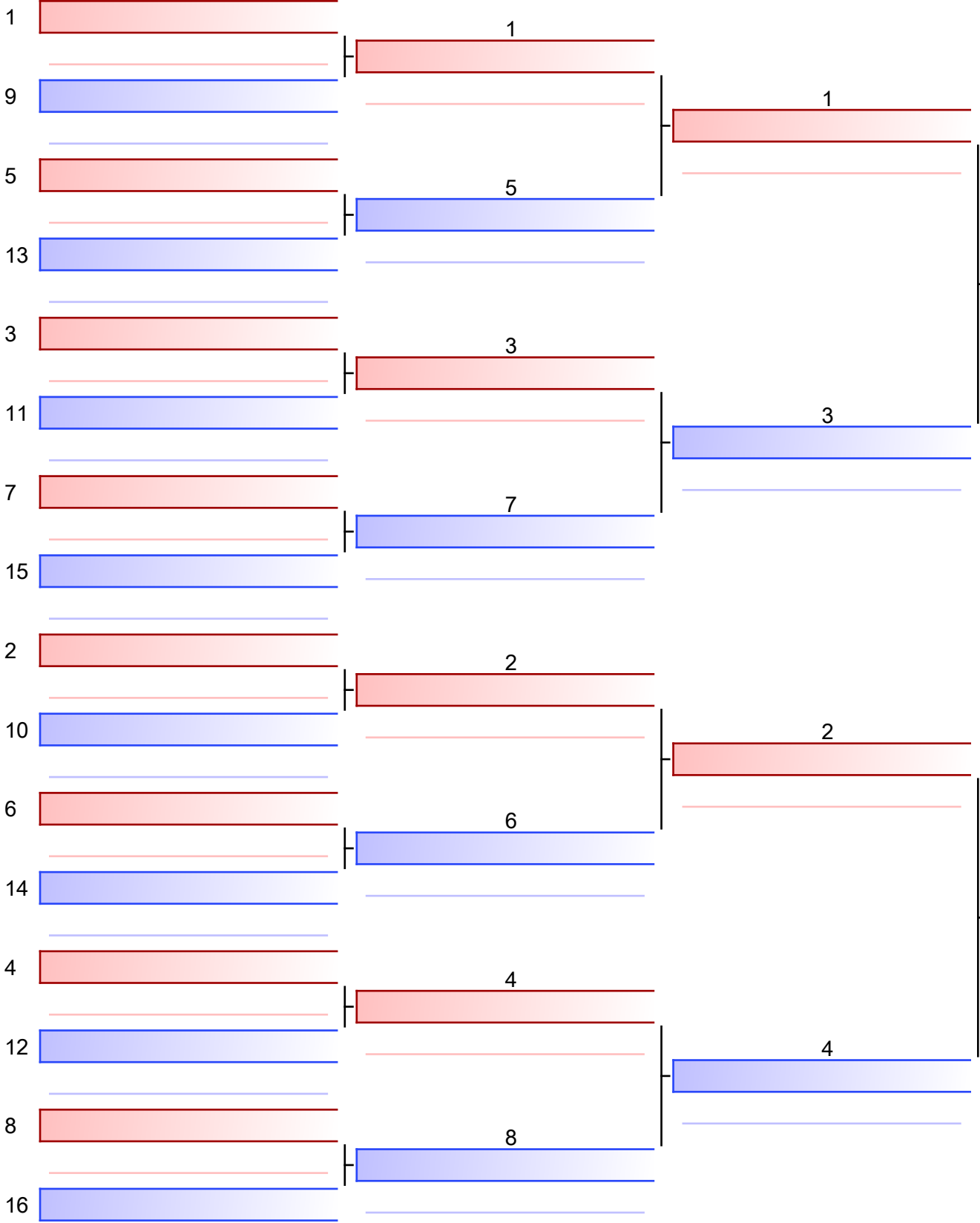

Finale

GALATI VITTORIA (KCS - LIGURIA KARATE) 1

0

PAVONE SOFIA (KARATE POZZUOLO)

PAVONE SOFIA (KARATE POZZUOLO) 2

3

- | |
|---------------------------------------------|
| 1. PAVONE SOFIA (KARATE POZZUOLO) |
| 2. GALATI VITTORIA (KCS - LIGURIA KARATE) |
| 3. PRYNDIUK ANASTASIA (ASD KARATE VALDO) |
| 3. CAMPO ARIANNA (KCS - LIGURIA KARATE) |
| 5. CESCUT EMMA (CKR ITALY) |
| 5. LONGO VALENTINA (ASD KIOSHI) |
| 7. GRAZIANI DIANA (FF.OO. POLIZIA DI STATO) |
| 7. BUONFIGLIO ROBERTA (FIAMME CREMISI BEF) |

Arbitri:			

Kumite Individual female U14 -42

VENETO OPEN

2023-05-21

Tatami
4 11:10

Tabelloni - Pool
1,2

(c)sportdata GmbH & Co KG 2000-2023 (2023-05-21 20:06) v 10.0.0 build 1 (2023-02-10) Licenza: Fijlkam Karate 2023 (expire 2023-12-31)

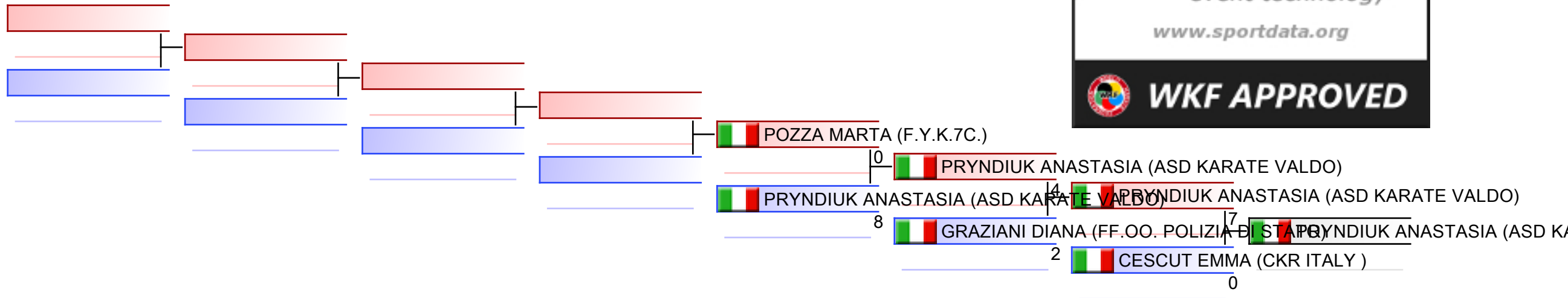

Ripescaggi: (1,2)

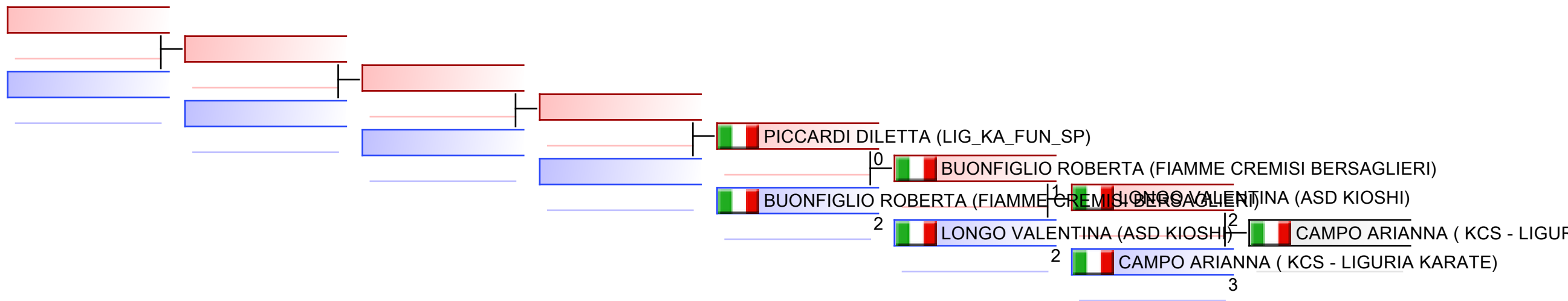

Arbitri:							
----------	--	--	--	--	--	--	--

Kumite Individual female U14 -47

VENETO OPEN, Via S. Marco, 53, 35129 Padova PD, ITA

2023-05-21

Tatami
3 09:00

Tabelloni - Pool
1/1

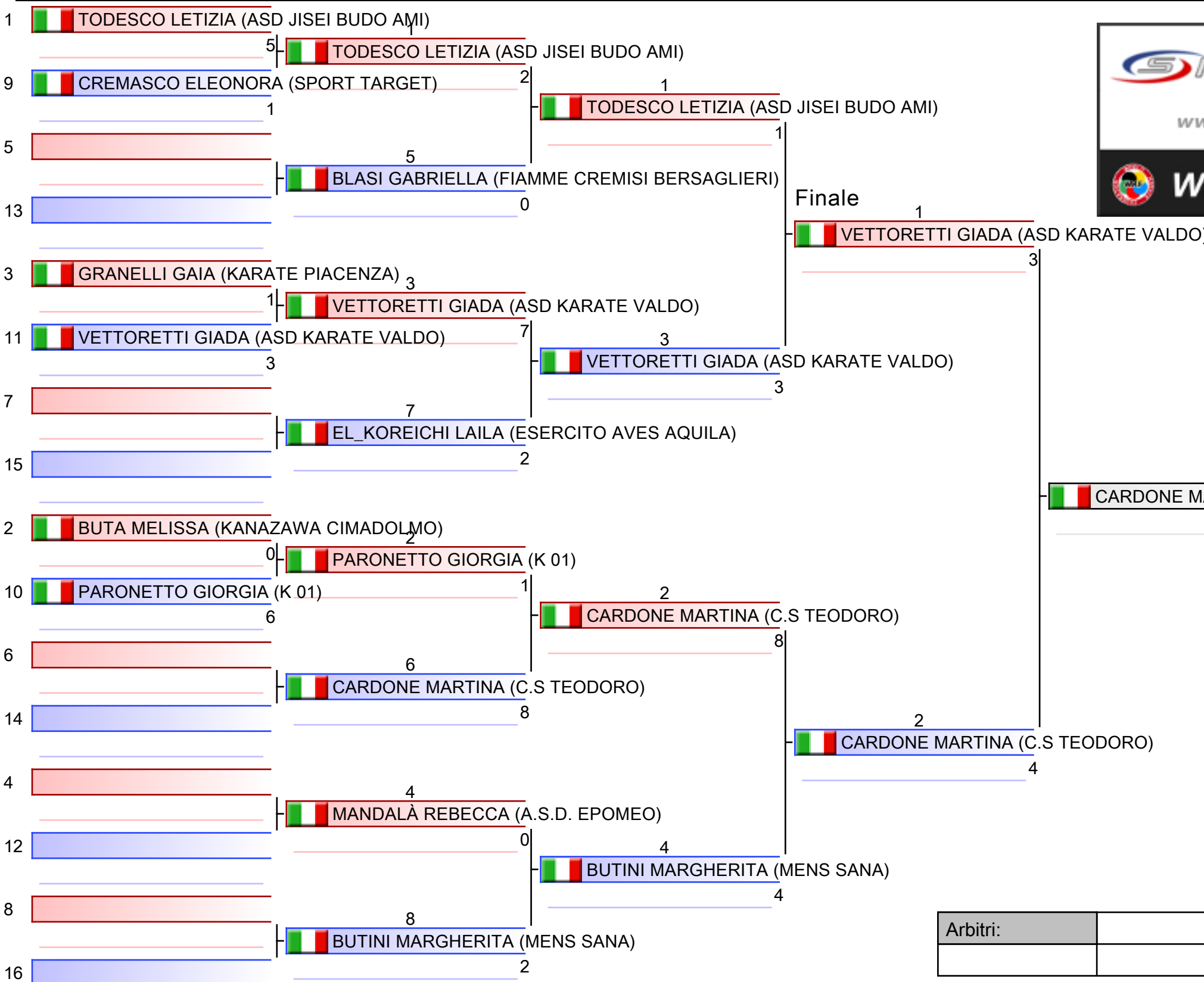

- | |
|---------------------------------------------|
| 1. CARDONE MARTINA (C.S TEODORO) |
| 2. VETTORETTI GIADA (ASD KARATE VALDO) |
| 3. BUTINI MARGHERITA (MENS SANA) |
| 3. GRANELLI GAIA (KARATE PIACENZA) |
| 5. PARONETTO GIORGIA (K 01) |
| 5. TODESCO LETIZIA (ASD JISEI BUDO AMI) |
| 7. EL_KOREICHI LAILA (ESERCITO AVES AQUILA) |

Arbitri:			

Kumite Individual female U14 -47

VENETO OPEN

2023-05-21

Tatami
3 11:00

Tabelloni - Pool
1

(c)sportdata GmbH & Co KG 2000-2023 (2023-05-21 20:06) v 10.0.0 build 1 (2023-02-10) Licenza: Fijlkam Karate 2023 (expire 2023-12-31)

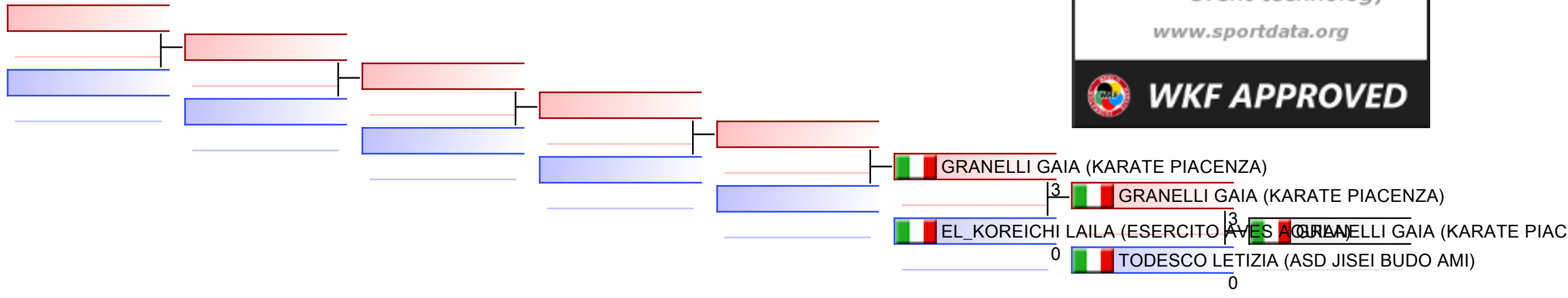

Ripescaggi: (1)

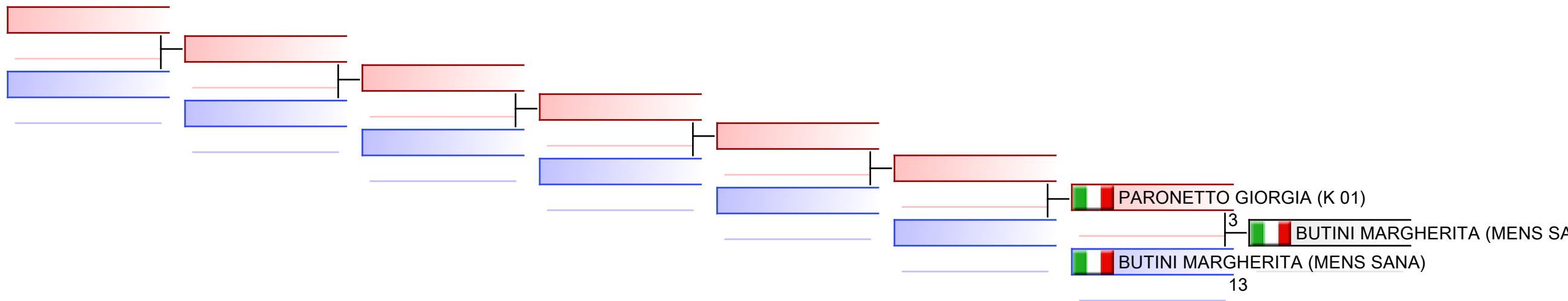

Arbitri:							
----------	--	--	--	--	--	--	--

Kumite Individual female U14 -52

VENETO OPEN, Via S. Marco, 53, 35129 Padova PD, ITA

2023-05-21

Tatami
6 09:00

Tabelloni - Pool
1/1

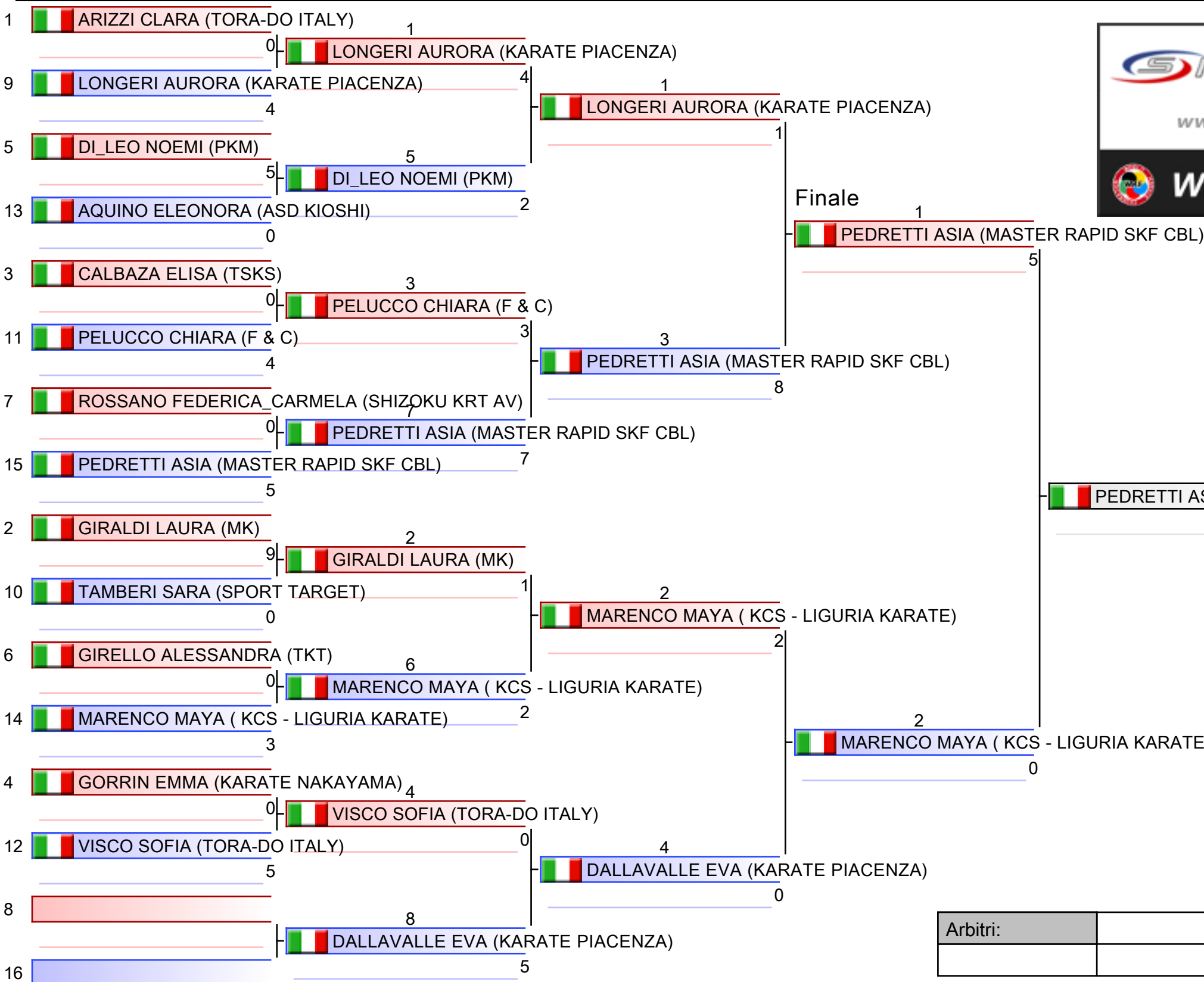

- | |
|----------------------------------------------|
| 1. PEDRETTI ASIA (MASTER RAPID SKF CBL) |
| 2. MARENCO MAYA (KCS - LIGURIA KARATE) |
| 3. ROSSANO FEDERICA_CARMELA (SHIZOKU KRT AV) |
| 3. GIRALDI LAURA (MK) |
| 5. LONGERI AURORA (KARATE PIACENZA) |
| 5. DALLAVALLE EVA (KARATE PIACENZA) |
| 7. PELUCCO CHIARA (F & C) |
| 7. GIRELLO ALESSANDRA (TKT) |

Arbitri:			

Kumite Individual female U14 -52

VENETO OPEN

2023-05-21

Tatami
6 11:00

Tabelloni - Pool
1

(c)sportdata GmbH & Co KG 2000-2023 (2023-05-21 20:06) v 10.0.0 build 1 (2023-02-10) Licenza: Fijlkam Karate 2023 (expire 2023-12-31)

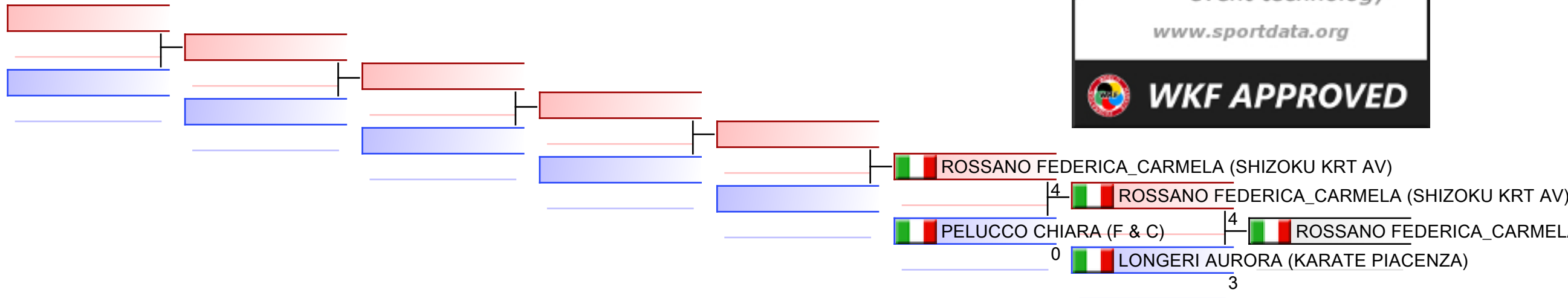

Ripescaggi: (1)

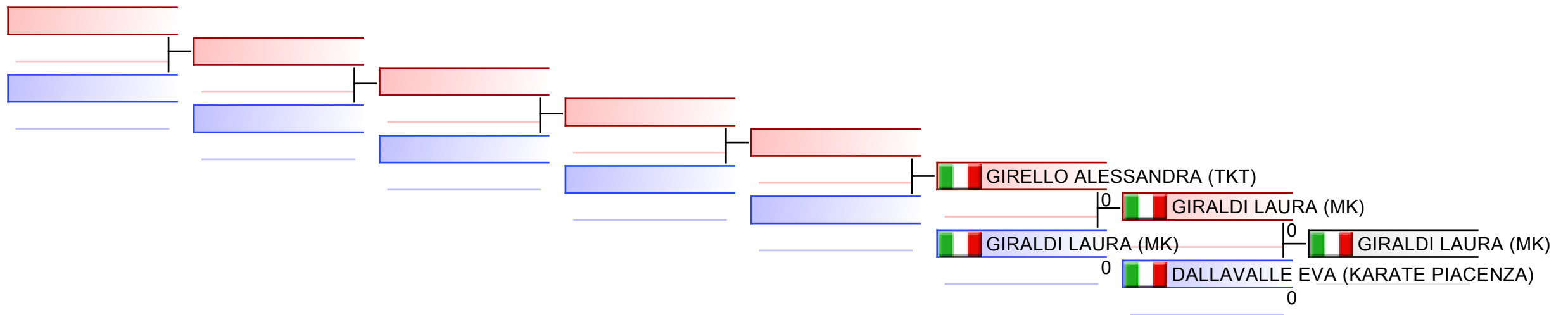

Arbitri:							
----------	--	--	--	--	--	--	--

Kumite Individual female U21 +68 - Girone all'Italiana (tutti contro tutti)

VENETO OPEN, Via S. Marco, 53, 35129 Padova PD, ITA

2023-05-19

Tatami
2 14:30

Tabelloni - Pool
1/1

- 1  PERGOLESIS AURORA (TKP) 2 |  FERRI AURORA (GIN. ANGEL)
- 2  FERRI AURORA (GIN. ANGEL) 4
- 3  DE_GREGORI CHIARA (A.S.D. SKR VENEZIA) 7 |  DE_GREGORI CHIARA (A.S.D. SKR VENEZIA)
- 4  SANTI NOEMI (LIG_KA_FUN_SP) 0
- 5  DE_GREGORI CHIARA (A.S.D. SKR VENEZIA) 0 |  PERGOLESIS AURORA (TKP)
- 6  PERGOLESIS AURORA (TKP) 8
- 7  SANTI NOEMI (LIG_KA_FUN_SP) 4 |  FERRI AURORA (GIN. ANGEL)
- 8  FERRI AURORA (GIN. ANGEL) 6
- 9  PERGOLESIS AURORA (TKP) 0 |  PERGOLESIS AURORA (TKP)
- 10  SANTI NOEMI (LIG_KA_FUN_SP) 0
- 11  FERRI AURORA (GIN. ANGEL) 4 |  FERRI AURORA (GIN. ANGEL)
- 12  DE_GREGORI CHIARA (A.S.D. SKR VENEZIA) 2



1. FERRI AURORA (GIN. ANGEL)
2. PERGOLESIS AURORA (TKP)
3. DE_GREGORI CHIARA (A.S.D. SKR VENEZIA)
4. SANTI NOEMI (LIG_KA_FUN_SP)

Arbitri:			

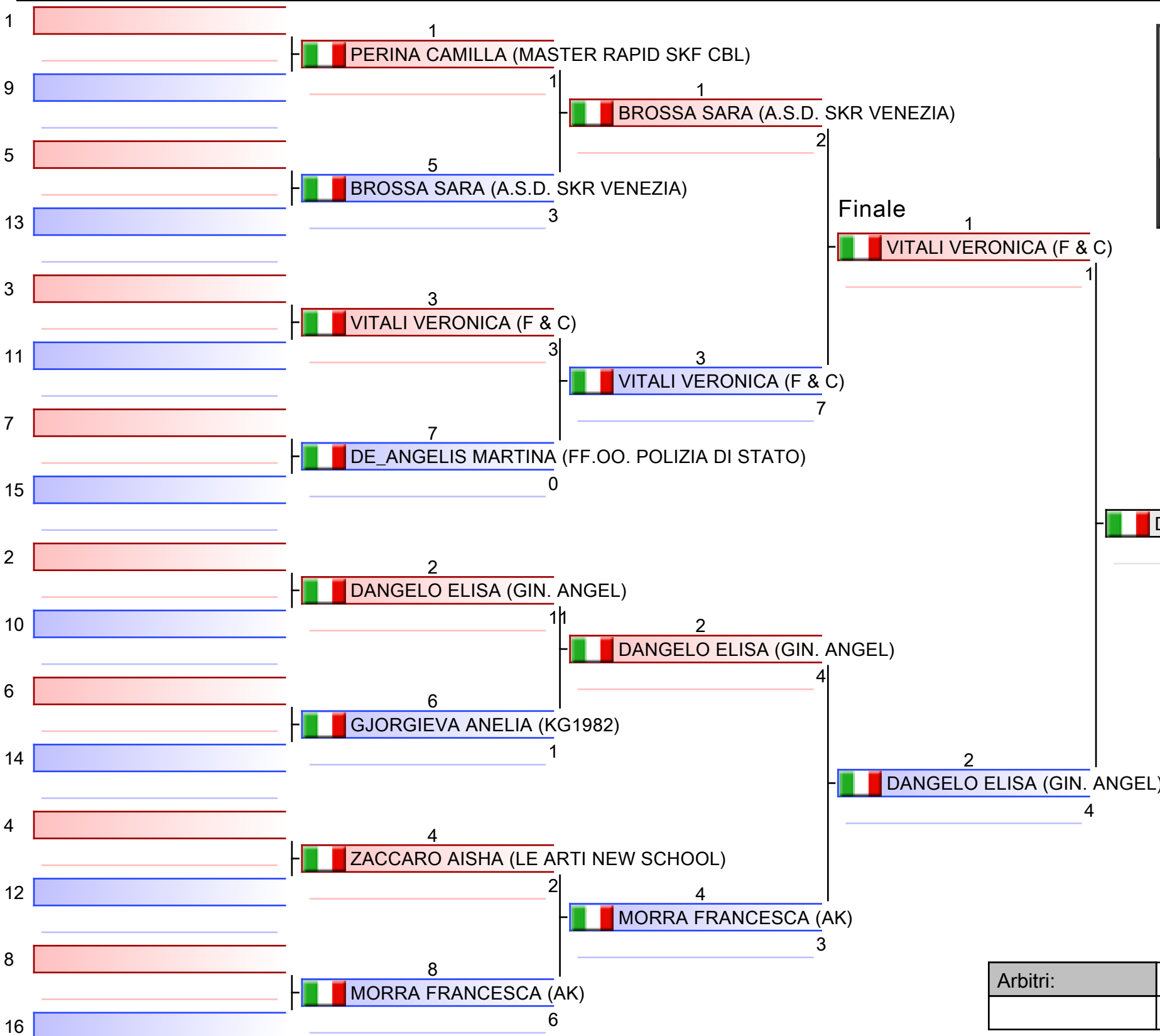

1. DANGELO ELISA (GIN. ANGEL)
2. VITALI VERONICA (F & C)
3. BROSSA SARA (A.S.D. SKR VENEZIA)
3. MORRA FRANCESCA (AK)
5. DE_ANGELIS MARTINA (FF.OO. POLIZIA DI STATO)
5. GJORGIEVA ANELIA (KG1982)

Arbitri:			

Kumite Individual female U21 -50

VENETO OPEN

2023-05-19

Tatami
3 15:20

Tabelloni - Pool
1

(c)sportdata GmbH & Co KG 2000-2023 (2023-05-21 20:06) v 10.0.0 build 1 (2023-02-10) Licenza: Fijlkam Karate 2023 (expire 2023-12-31)

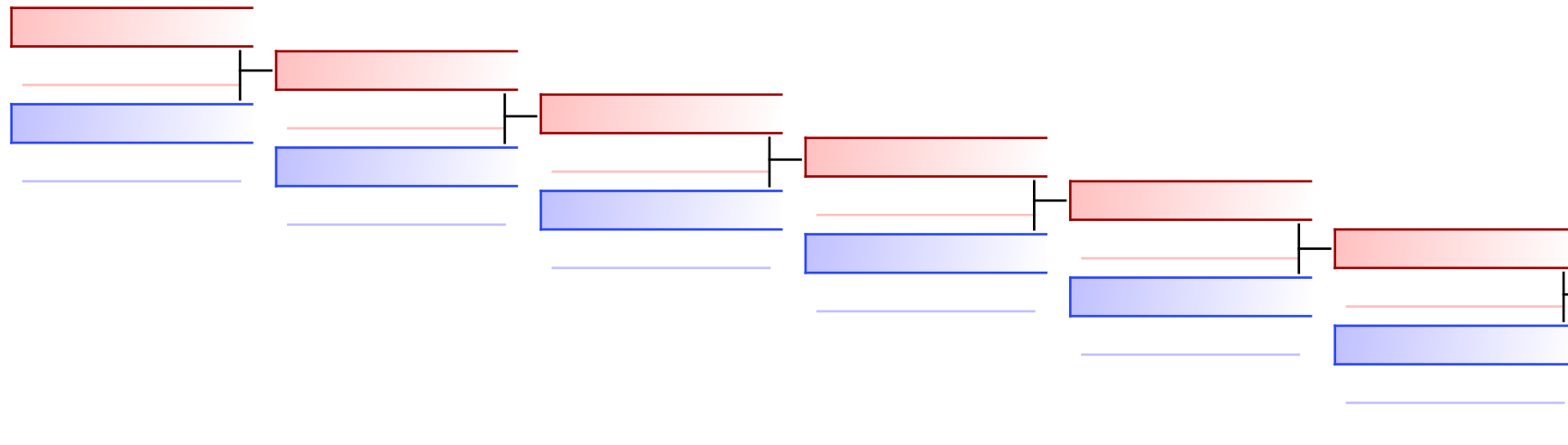

DE_ANGELIS MARTINA (FF.OO. POLIZIA DI STATO)
3
BROSSA SARA (A.S.D. SKR VENEZIA)
3
BROSSA SARA (A.S.D. SKR VENEZIA)
3

Ripescaggi: (1)

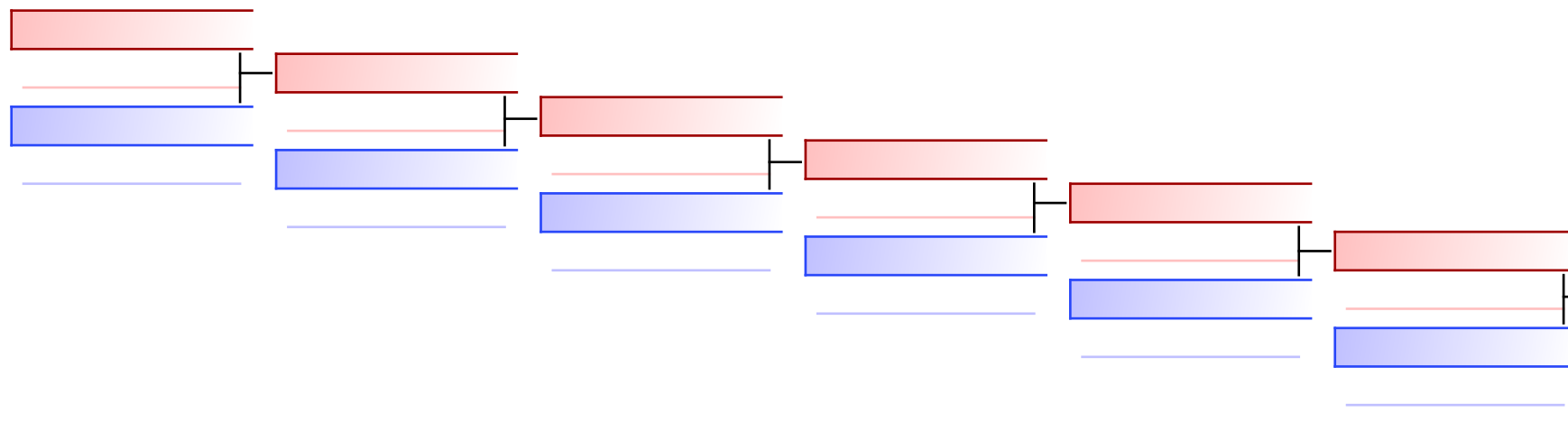

GJORGIEVA ANELIA (KG1982)
0
MORRA FRANCESCA (AK)
6
MORRA FRANCESCA (AK)

Arbitri:							
----------	--	--	--	--	--	--	--

Kumite Individual female U21 -55

VENETO OPEN, Via S. Marco, 53, 35129 Padova PD, ITA

2023-05-19

Tatami
4 14:30

Tabelloni - Pool
1/1

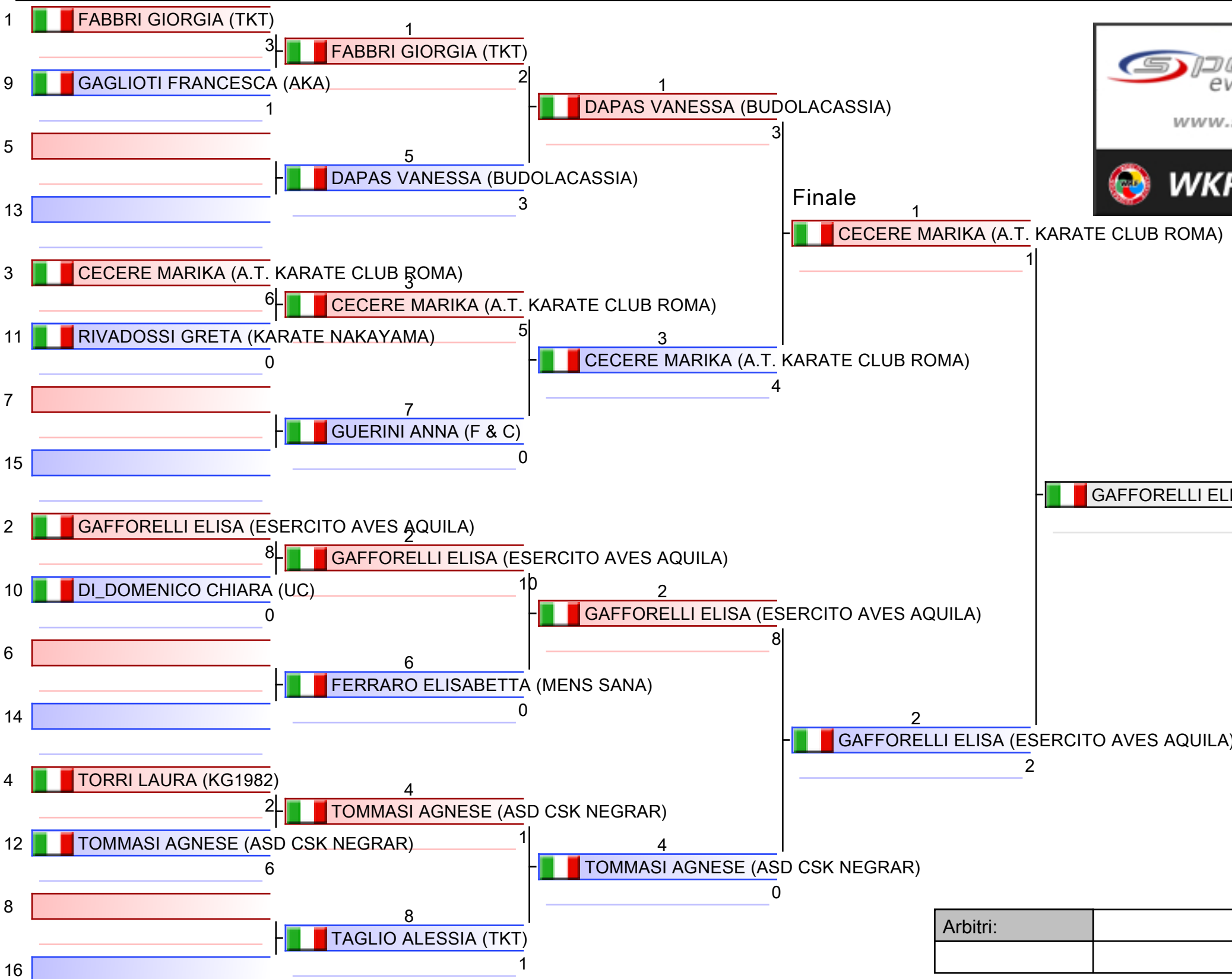

- | |
|--------------------------------------------|
| 1. GAFFORELLI ELISA (ESERCITO AVES AQUILA) |
| 2. CECERE MARIKA (A.T. KARATE CLUB ROMA) |
| 3. DAPAS VANESSA (BUDOLACASSIA) |
| 3. DI_DOMENICO CHIARA (UC) |
| 5. RIVADOSSI GRETA (KARATE NAKAYAMA) |
| 5. TOMMASI AGNESE (ASD CSK NEGRAR) |
| 7. GUERINI ANNA (F & C) |
| 7. FERRARO ELISABETTA (MENS SANA) |

Arbitri:			

Kumite Individual female U21 -55

VENETO OPEN

2023-05-19

Tatami
4 15:35

Tabelloni - Pool
1

(c)sportdata GmbH & Co KG 2000-2023 (2023-05-21 20:06) v 10.0.0 build 1 (2023-02-10) Licenza: Fijlkam Karate 2023 (expire 2023-12-31)

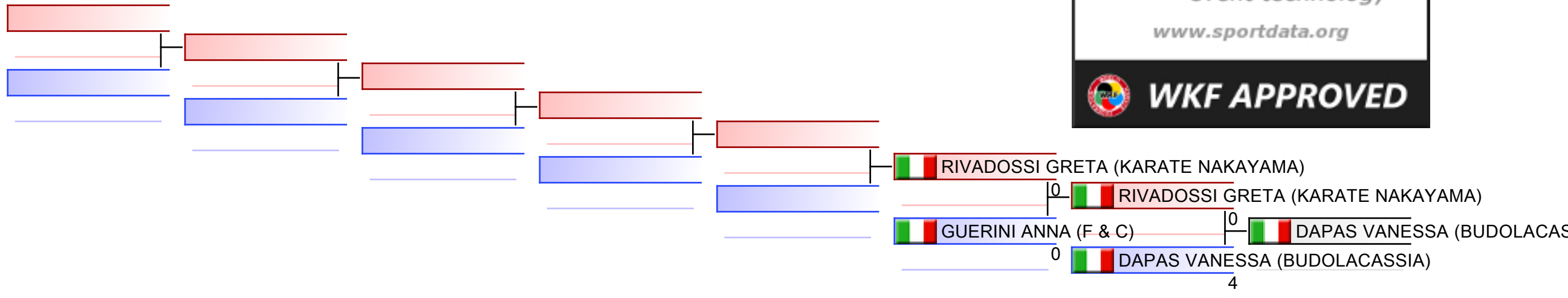

Ripescaggi: (1)

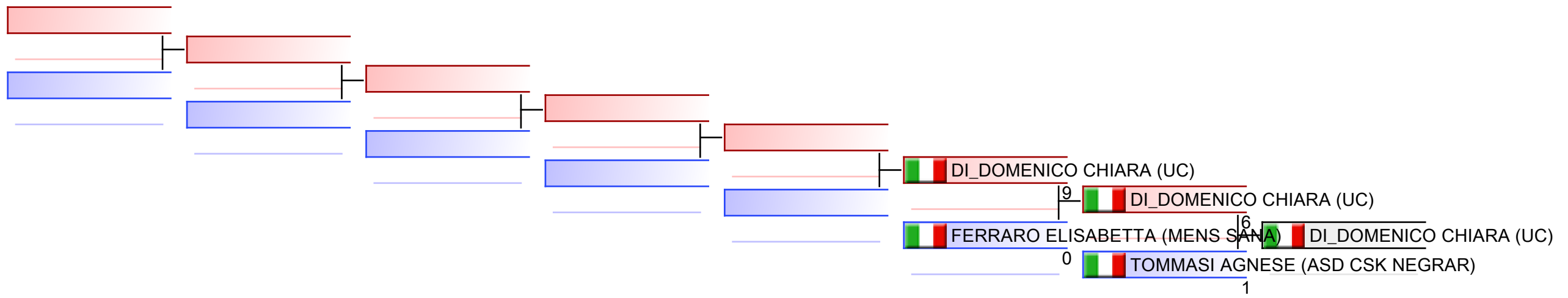

Arbitri:							
----------	--	--	--	--	--	--	--

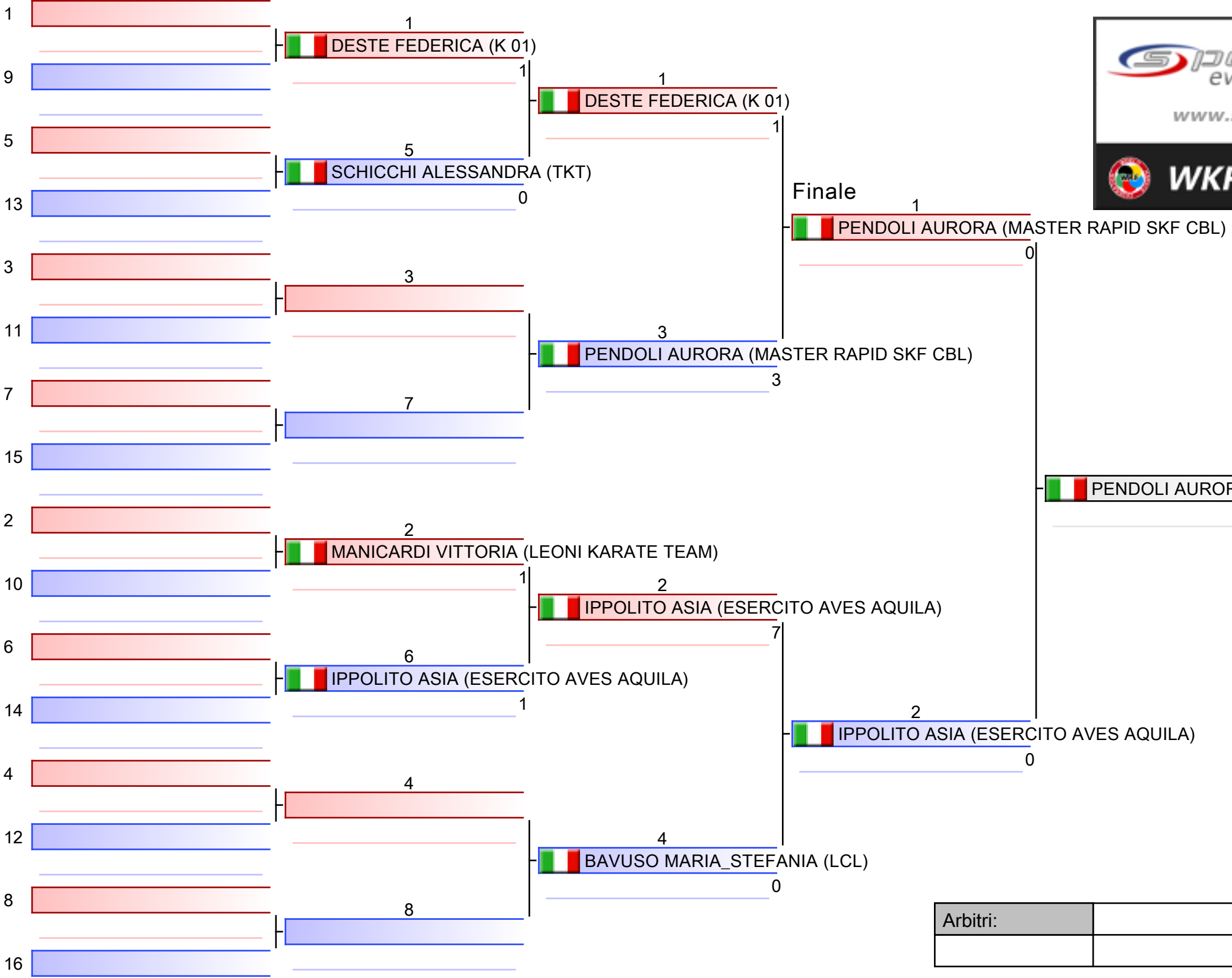

1. PENDOLI AURORA (MASTER RAPID SKF CBL)
2. IPPOLITO ASIA (ESERCITO AVES AQUILA)
3. DESTE FEDERICA (K 01)
3. BAVUSO MARIA_STEFANIA (LCL)
5. MANICARDI VITTORIA (LEONI KARATE TEAM)

Arbitri:			

Kumite Individual female U21 -61

VENETO OPEN

2023-05-19

Tatami
2 15:45

Tabelloni - Pool
1

(c)sportdata GmbH & Co KG 2000-2023 (2023-05-21 20:06) v 10.0.0 build 1 (2023-02-10) Licenza: Fijlkam Karate 2023 (expire 2023-12-31)

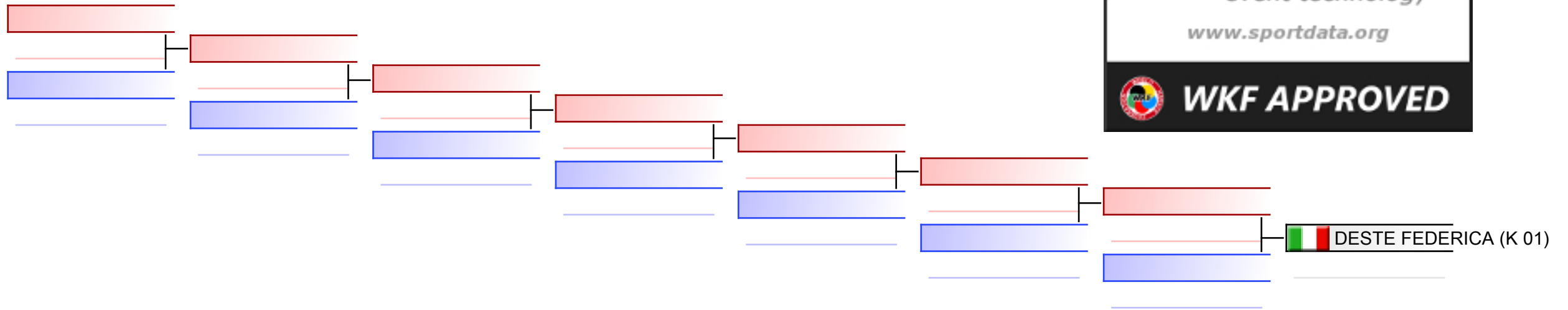

Ripescaggi: (1)

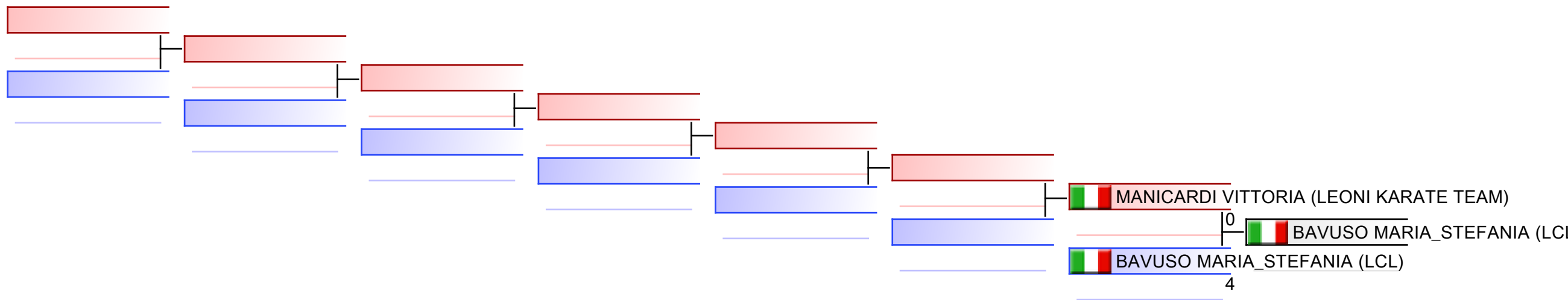

Arbitri:							
----------	--	--	--	--	--	--	--

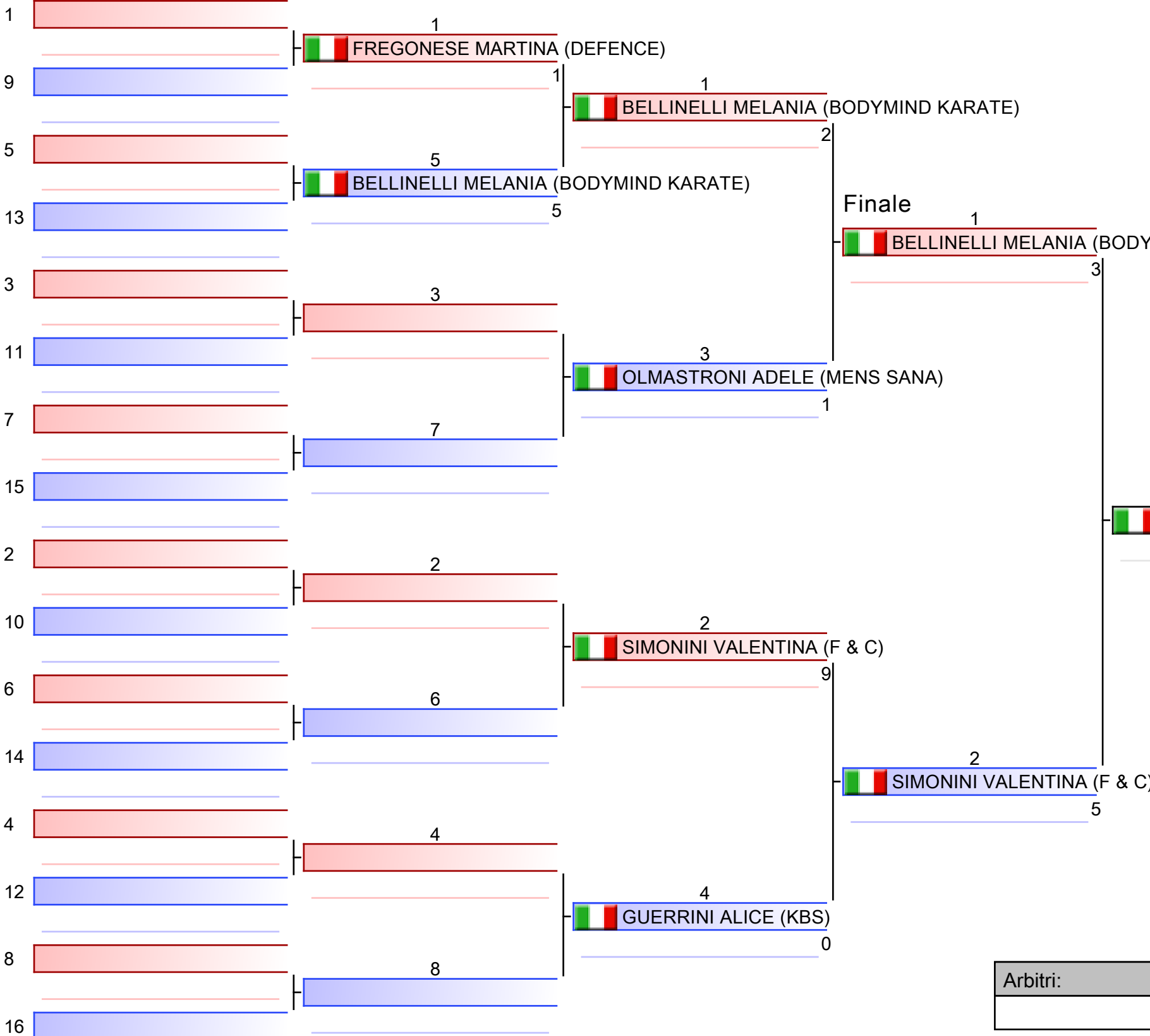

1. SIMONINI VALENTINA (F & C)
2. BELLINELLI MELANIA (BODYMIND KARATE)
3. GUERRINI ALICE (KBS)
3. FREGONESE MARTINA (DEFENCE)
5. OLMASTRONI ADELE (MENS SANA)

Arbitri:			

Kumite Individual female U21 -68

VENETO OPEN

2023-05-19

Tatami
5 14:50

Tabelloni - Pool
1

(c)sportdata GmbH & Co KG 2000-2023 (2023-05-21 20:06) v 10.0.0 build 1 (2023-02-10) Licenza: Fijlkam Karate 2023 (expire 2023-12-31)

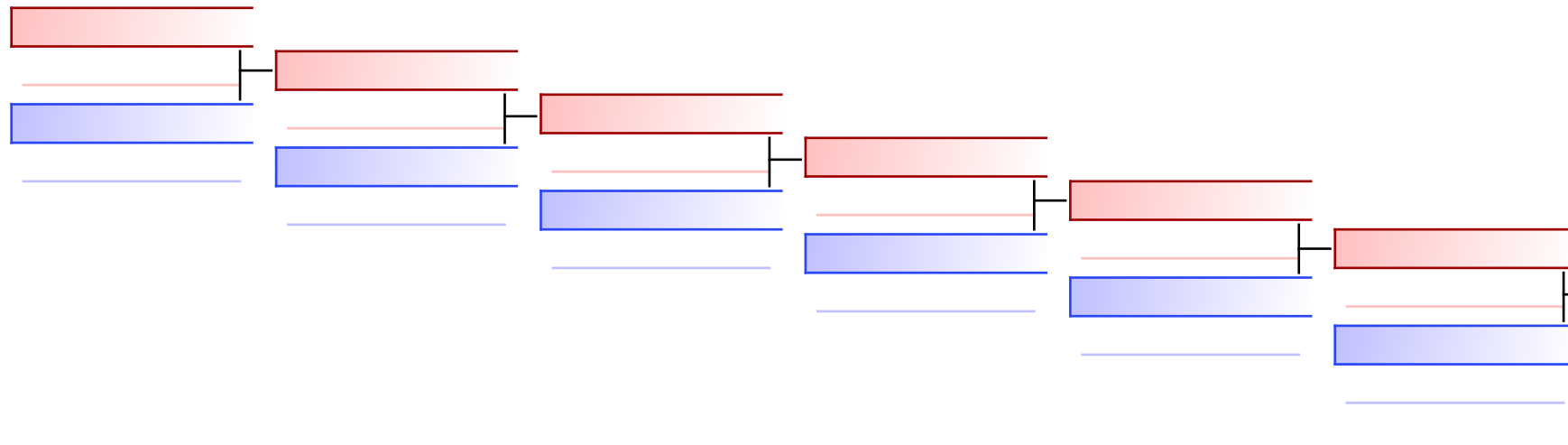

 FREGONESE MARTINA (DEFENCE) 4
 FREGONESE MARTINA (DEFENCE)
 OLMASTRONI ADELE (MENS SANA) 1

Ripescaggi: (1)

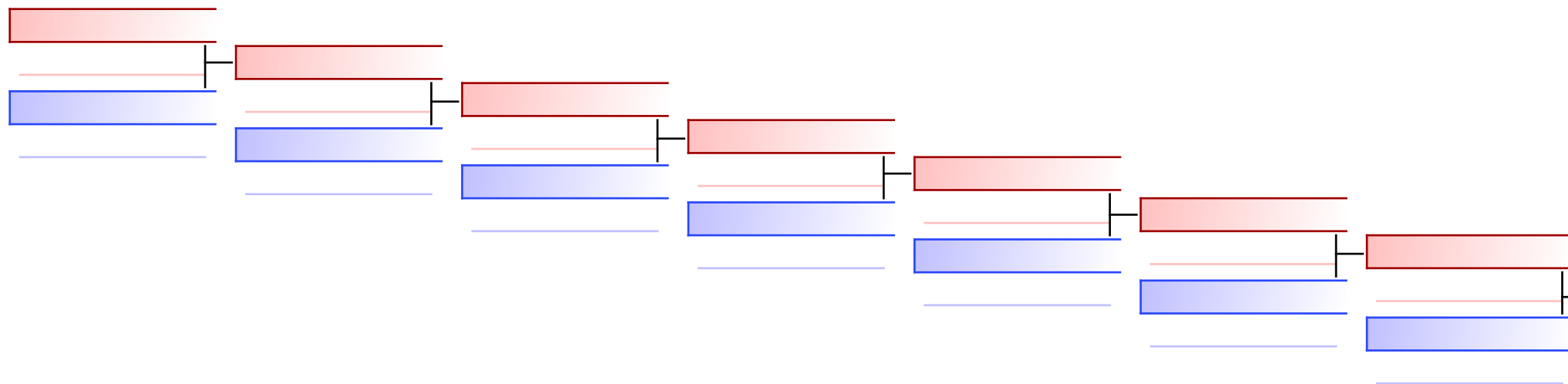

 GUERRINI ALICE (KBS)

Arbitri:							
----------	--	--	--	--	--	--	--

Kumite Individual male Cadets +70

VENETO OPEN, Via S. Marco, 53, 35129 Padova PD, ITA

2023-05-20

Tatami
5 12:25

Tabelloni - Pool
1/2

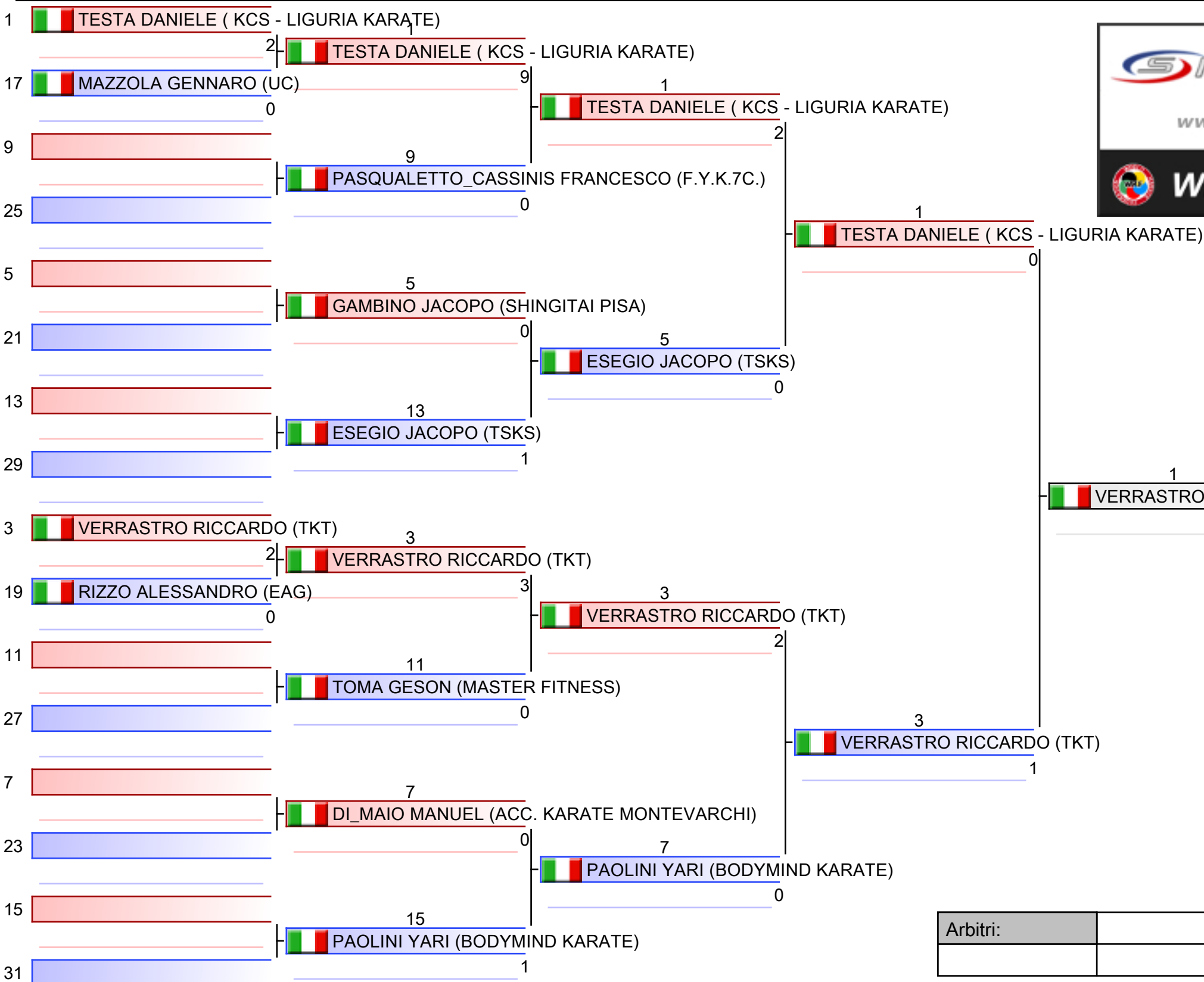

1. VERRASTRO RICCARDO (TKT)
2. RISITO MATTEO (AKS FIRENZE)
3. LIBERTI SANTINO (AK)
3. TESTA DANIELE (KCS - LIGURIA KARATE)
5. OSELLI TOMMASO (LE ARTI NEW SCHOOL)
5. TOMA GESON (MASTER FITNESS)
7. BERTI RAFAEL (KCB)
7. PAOLINI YARI (BODYMIND KARATE)

Arbitri:			

Kumite Individual male Cadets +70

VENETO OPEN, Via S. Marco, 53, 35129 Padova PD, ITA

2023-05-20

Tatami
6 12:25

Tabelloni - Pool
2/2

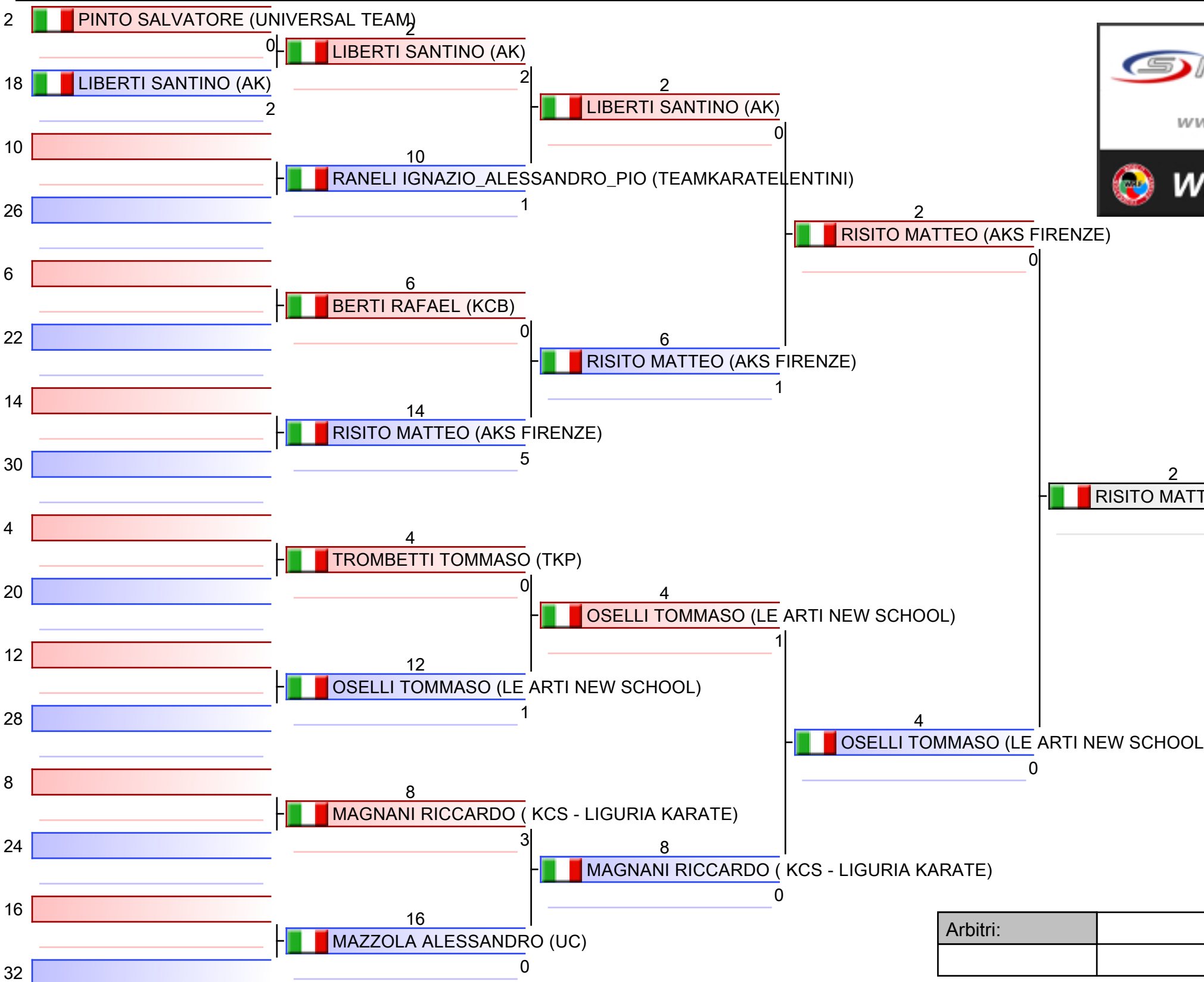

Arbitri:			

Vincitore di pool-Kumite Individual male Cadets +70

VENETO OPEN, Via S. Marco, 53, 35129 Padova PD, ITA

Tatami

Tabelloni - Pool

1/1

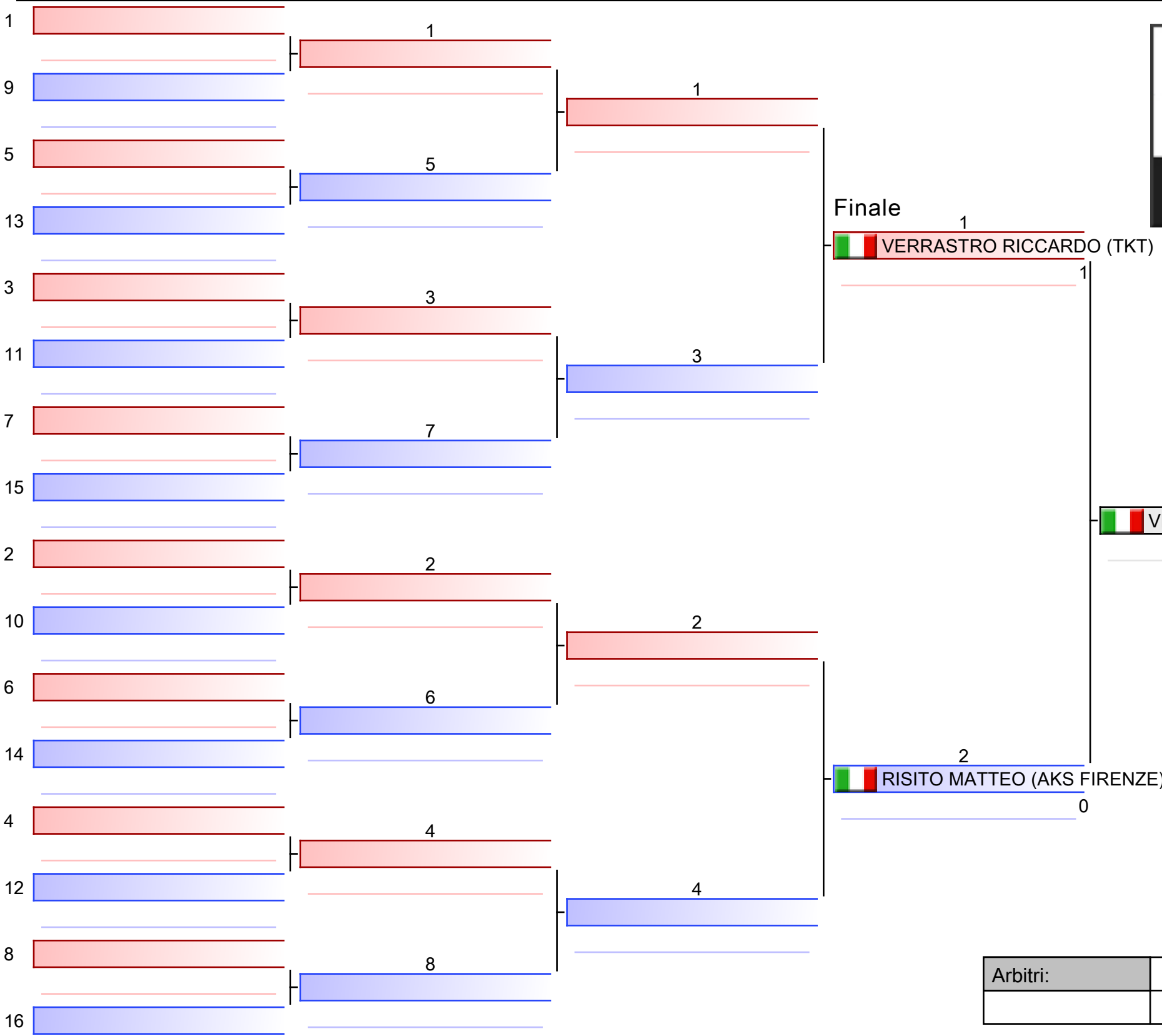

Finale

1
 VERRASTRO RICCARDO (TKT)

VERRASTRO RICCARDO (TKT)

2
 RISITO MATTEO (AKS FIRENZE)

1. VERRASTRO RICCARDO (TKT)
2. RISITO MATTEO (AKS FIRENZE)
3. LIBERTI SANTINO (AK)
3. TESTA DANIELE (KCS - LIGURIA KARATE)
5. OSELLI TOMMASO (LE ARTI NEW SCHOOL)
5. TOMA GESON (MASTER FITNESS)
7. BERTI RAFAEL (KCB)
7. PAOLINI YARI (BODYMIND KARATE)

Arbitri:			

Kumite Individual male Cadets +70

VENETO OPEN

2023-05-20

Tatami
5 13:10

Tabelloni - Pool
1

(c)sportdata GmbH & Co KG 2000-2023 (2023-05-21 20:06) v 10.0.0 build 1 (2023-02-10) Licenza: Fijlkam Karate 2023 (expire 2023-12-31)

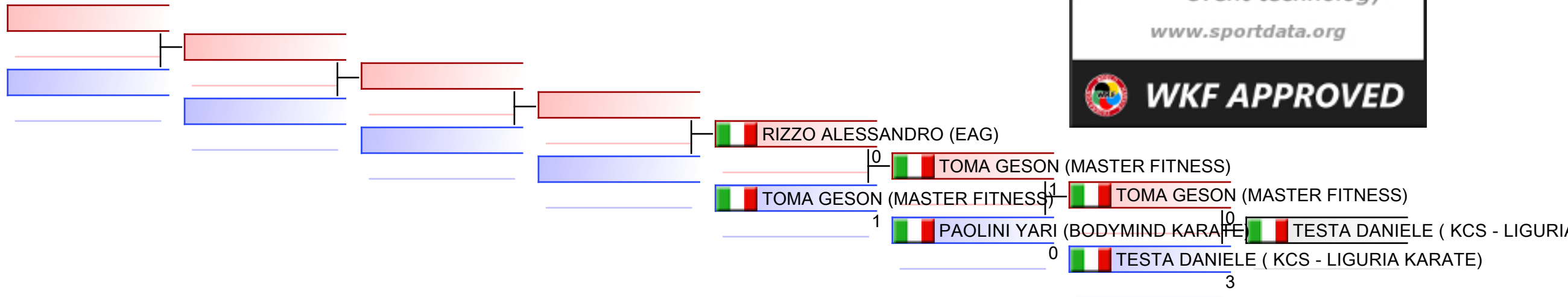

Ripescaggi: (1)

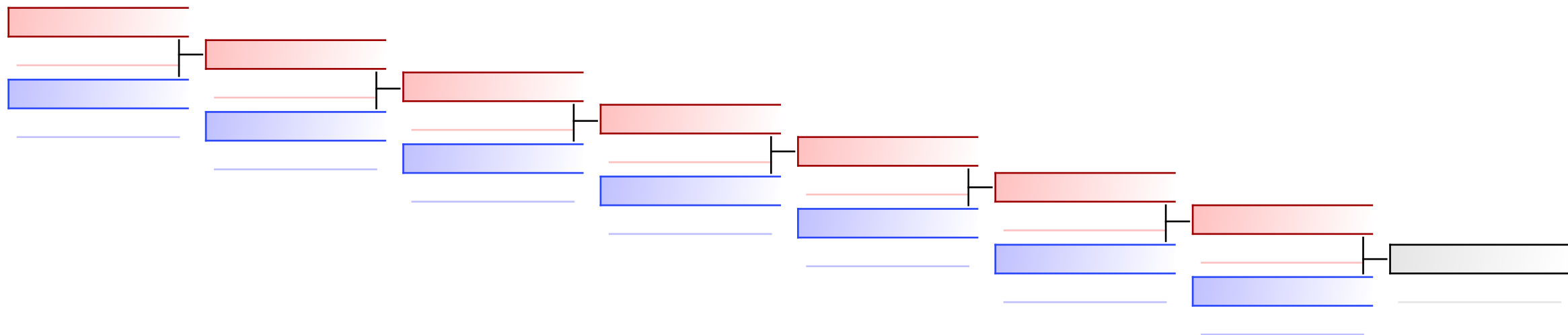

Arbitri:							
----------	--	--	--	--	--	--	--

Kumite Individual male Cadets +70

VENETO OPEN

2023-05-20

Tatami
6 13:10

Tabelloni - Pool
2

(c)sportdata GmbH & Co KG 2000-2023 (2023-05-21 20:06) v 10.0.0 build 1 (2023-02-10) Licenza: Fijlkam Karate 2023 (expire 2023-12-31)

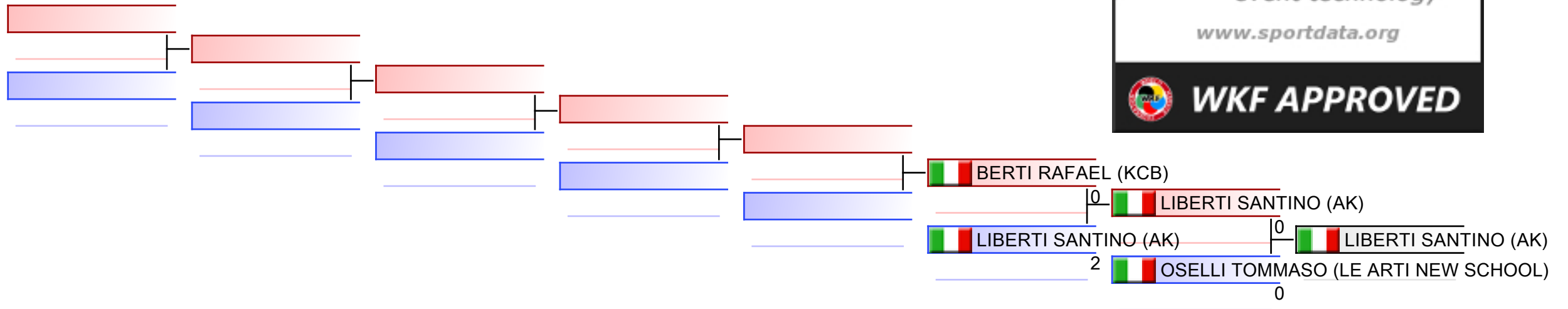

Ripescaggi: (2)

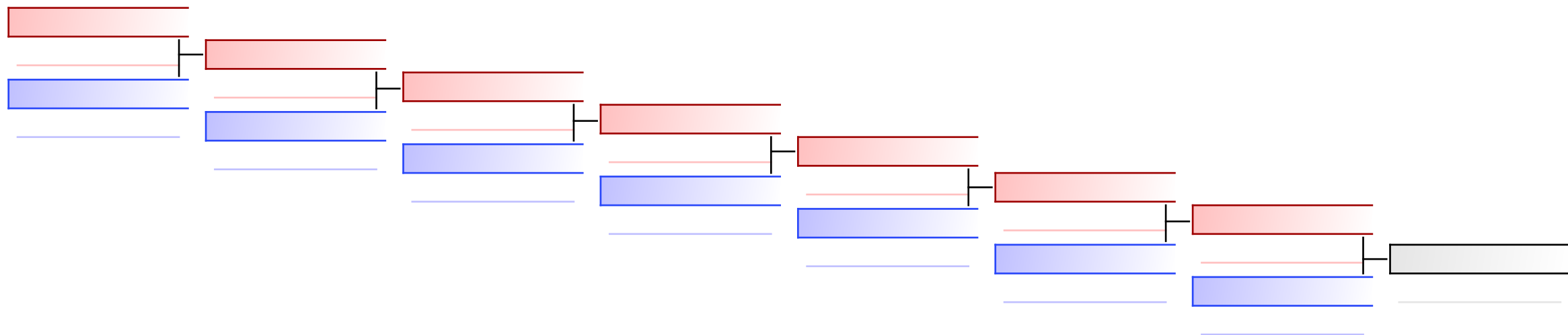

Arbitri:							
----------	--	--	--	--	--	--	--

Kumite Individual male Cadets -52

VENETO OPEN, Via S. Marco, 53, 35129 Padova PD, ITA

2023-05-20

Tatami
2 11:15

Tabelloni - Pool
1/2

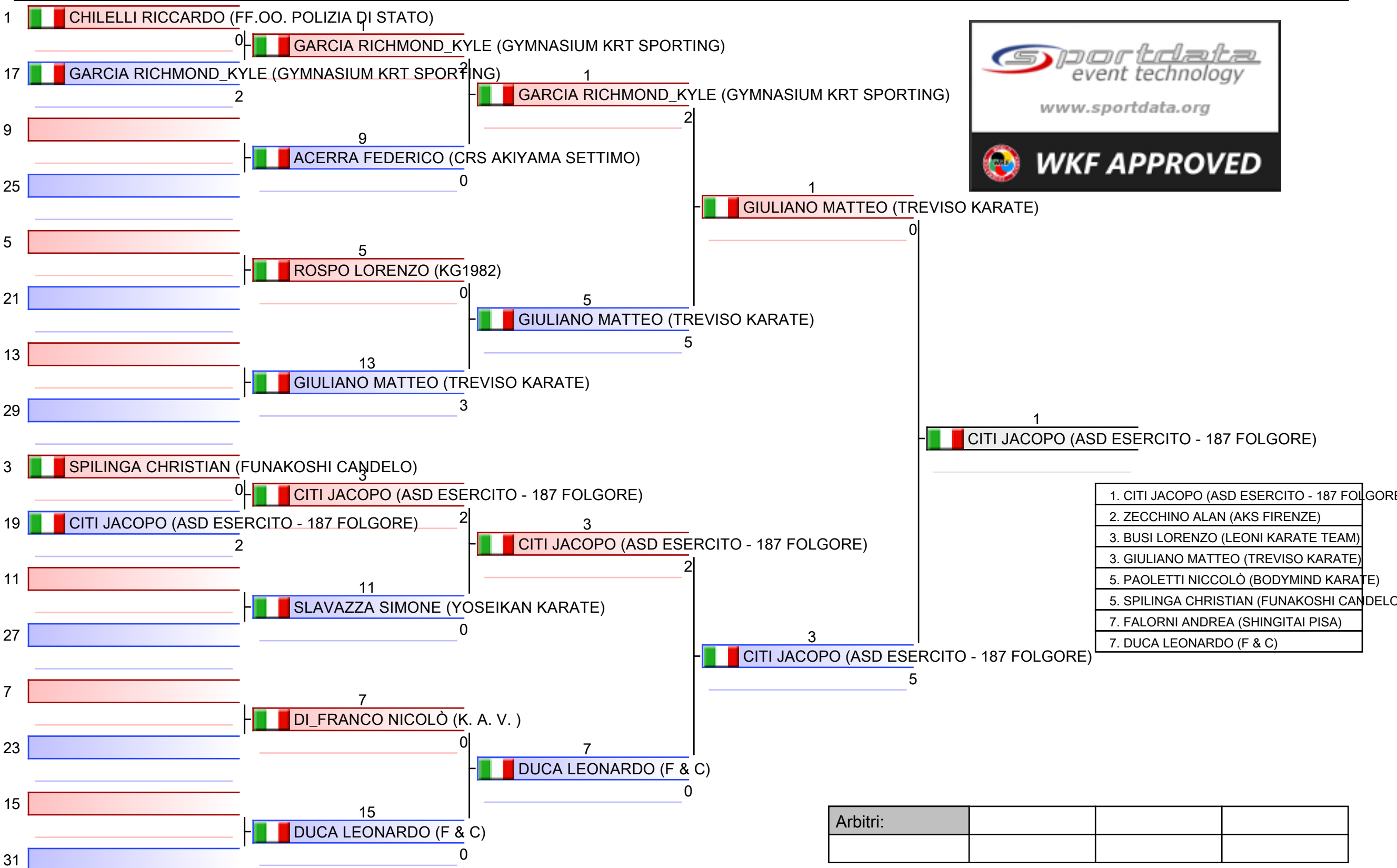

- | |
|---------------------------------------------|
| 1. CITI JACOPO (ASD ESERCITO - 187 FOLGORE) |
| 2. ZECCHINO ALAN (AKS FIRENZE) |
| 3. BUSI LORENZO (LEONI KARATE TEAM) |
| 3. GIULIANO MATTEO (TREVISO KARATE) |
| 5. PAOLETTI NICCOLÒ (BODYMIND KARATE) |
| 5. SPILINGA CHRISTIAN (FUNAKOSHI CANDELO) |
| 7. FALORNI ANDREA (SHINGITAI PISA) |
| 7. DUCA LEONARDO (F & C) |

Arbitri:			

Kumite Individual male Cadets -52

VENETO OPEN, Via S. Marco, 53, 35129 Padova PD, ITA

2023-05-20

Tatami
3 11:15

Tabelloni - Pool
2/2

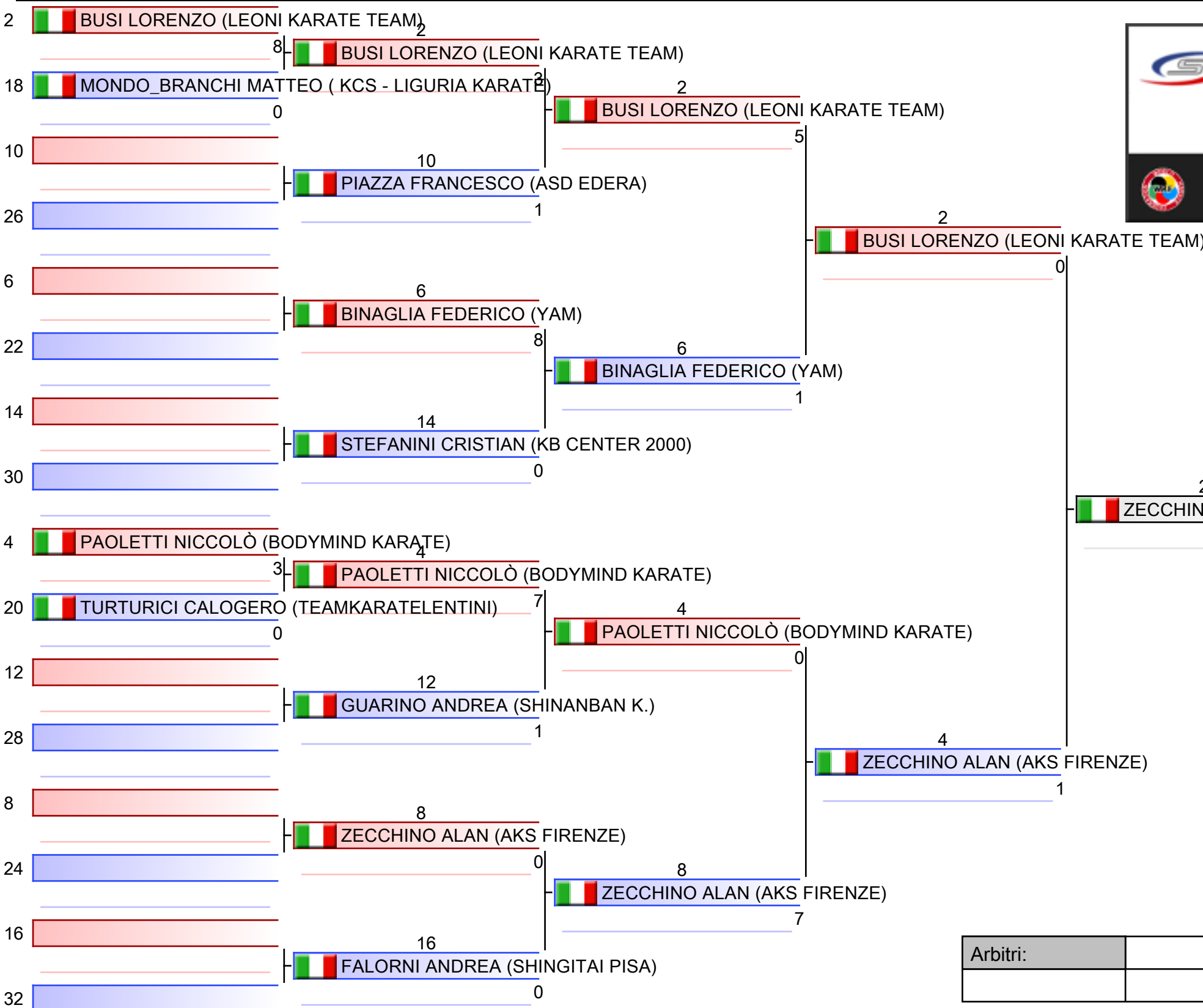

- | |
|---------------------------------------------|
| 1. CITI JACOPO (ASD ESERCITO - 187 FOLGORE) |
| 2. ZECCHINO ALAN (AKS FIRENZE) |
| 3. BUSI LORENZO (LEONI KARATE TEAM) |
| 3. GIULIANO MATTEO (TREVISO KARATE) |
| 5. PAOLETTI NICCOLÒ (BODYMIND KARATE) |
| 5. SPILINGA CHRISTIAN (FUNAKOSHI CANDELO) |
| 7. FALORNI ANDREA (SHINGITAI PISA) |
| 7. DUCA LEONARDO (F & C) |

Arbitri:			

Vincitore di pool-Kumite Individual male Cadets -52

VENETO OPEN, Via S. Marco, 53, 35129 Padova PD, ITA

Tatami

Tabelloni - Pool

1/1

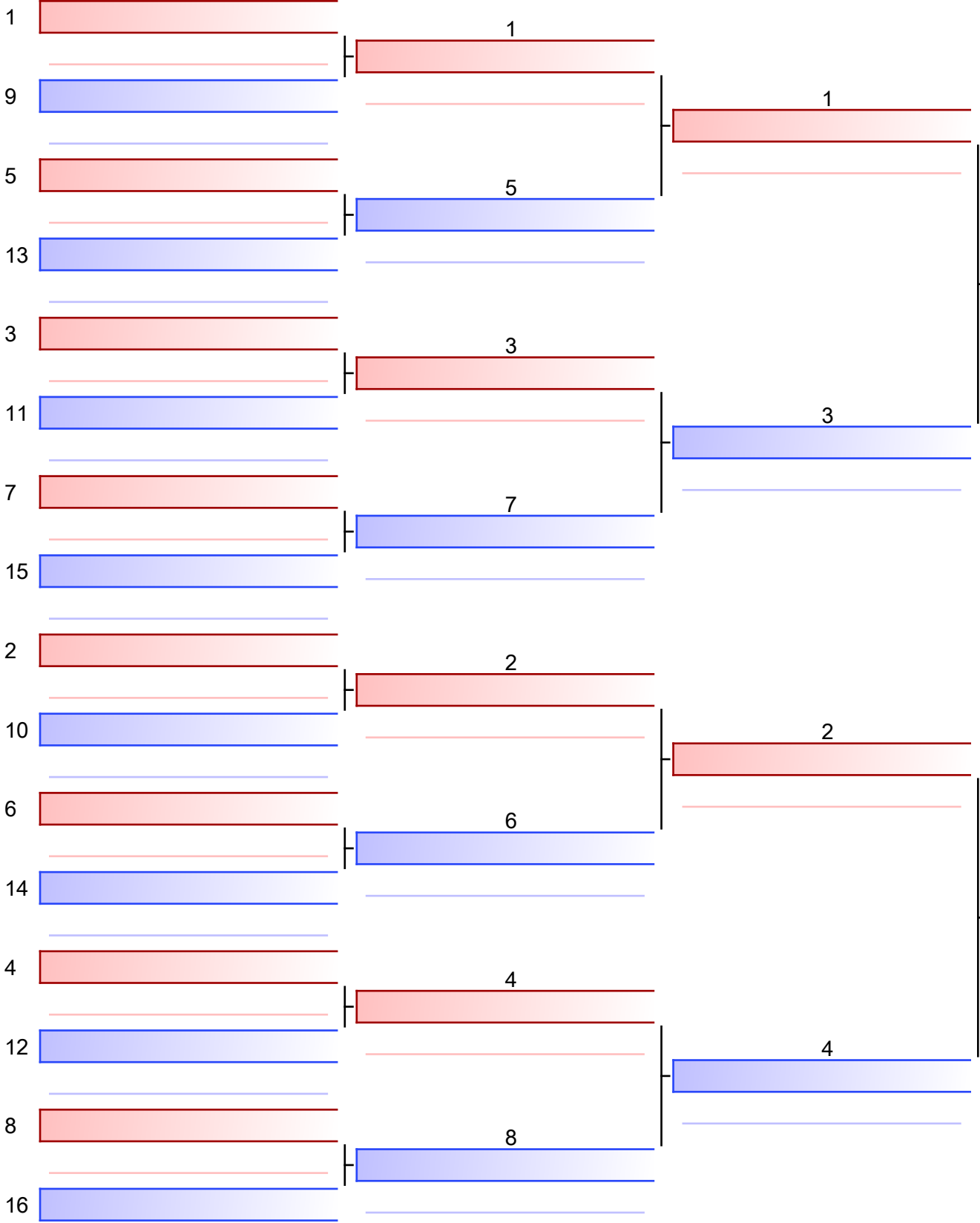

Finale

1 CITI JACOPO (ASD ESERCITO - 187 FOLGORE)

6

CITI JACOPO (ASD ESERCITO - 187 FOLGORE)

2 ZECCHINO ALAN (AKS FIRENZE)

2

- | |
|---------------------------------------------|
| 1. CITI JACOPO (ASD ESERCITO - 187 FOLGORE) |
| 2. ZECCHINO ALAN (AKS FIRENZE) |
| 3. BUSI LORENZO (LEONI KARATE TEAM) |
| 3. GIULIANO MATTEO (TREVISO KARATE) |
| 5. PAOLETTI NICCOLÒ (BODYMIND KARATE) |
| 5. SPILINGA CHRISTIAN (FUNAKOSHI CANDELO) |
| 7. FALORNI ANDREA (SHINGITAI PISA) |
| 7. DUCA LEONARDO (F & C) |

Arbitri:			

Kumite Individual male Cadets -52

VENETO OPEN

2023-05-20

Tatami
2 13:05

Tabelloni - Pool
1,2

(c)sportdata GmbH & Co KG 2000-2023 (2023-05-21 20:06) v 10.0.0 build 1 (2023-02-10) Licenza: Fijlkam Karate 2023 (expire 2023-12-31)

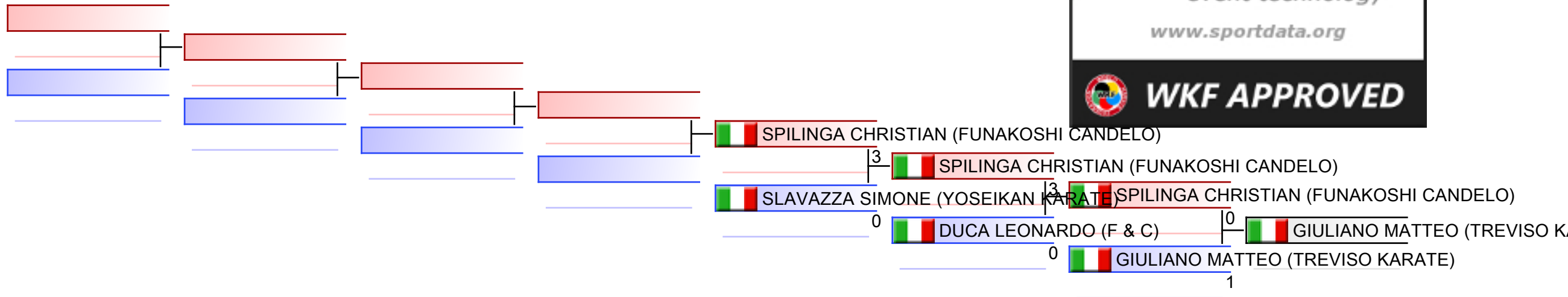

Ripescaggi: (1,2)

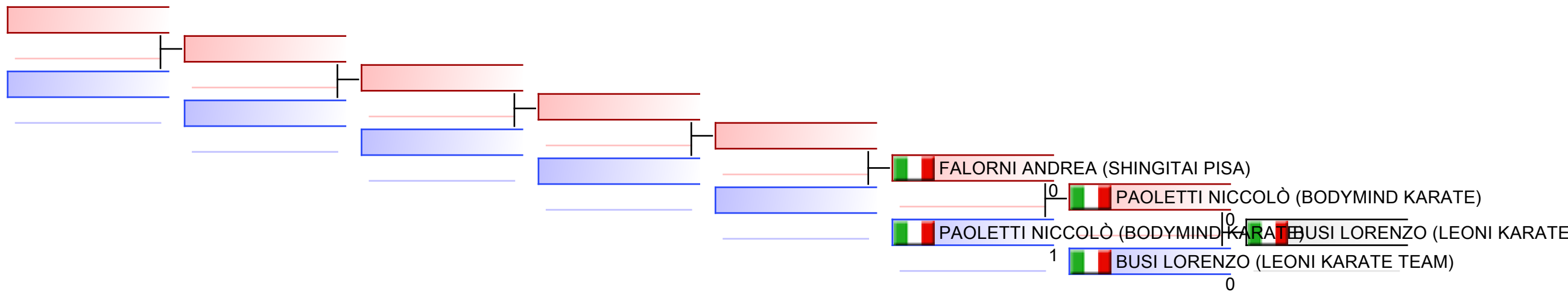

Arbitri:							
----------	--	--	--	--	--	--	--

Kumite Individual male Cadets -57

VENETO OPEN, Via S. Marco, 53, 35129 Padova PD, ITA

2023-05-20

Tatami
2 10:05

Tabelloni - Pool
1/2

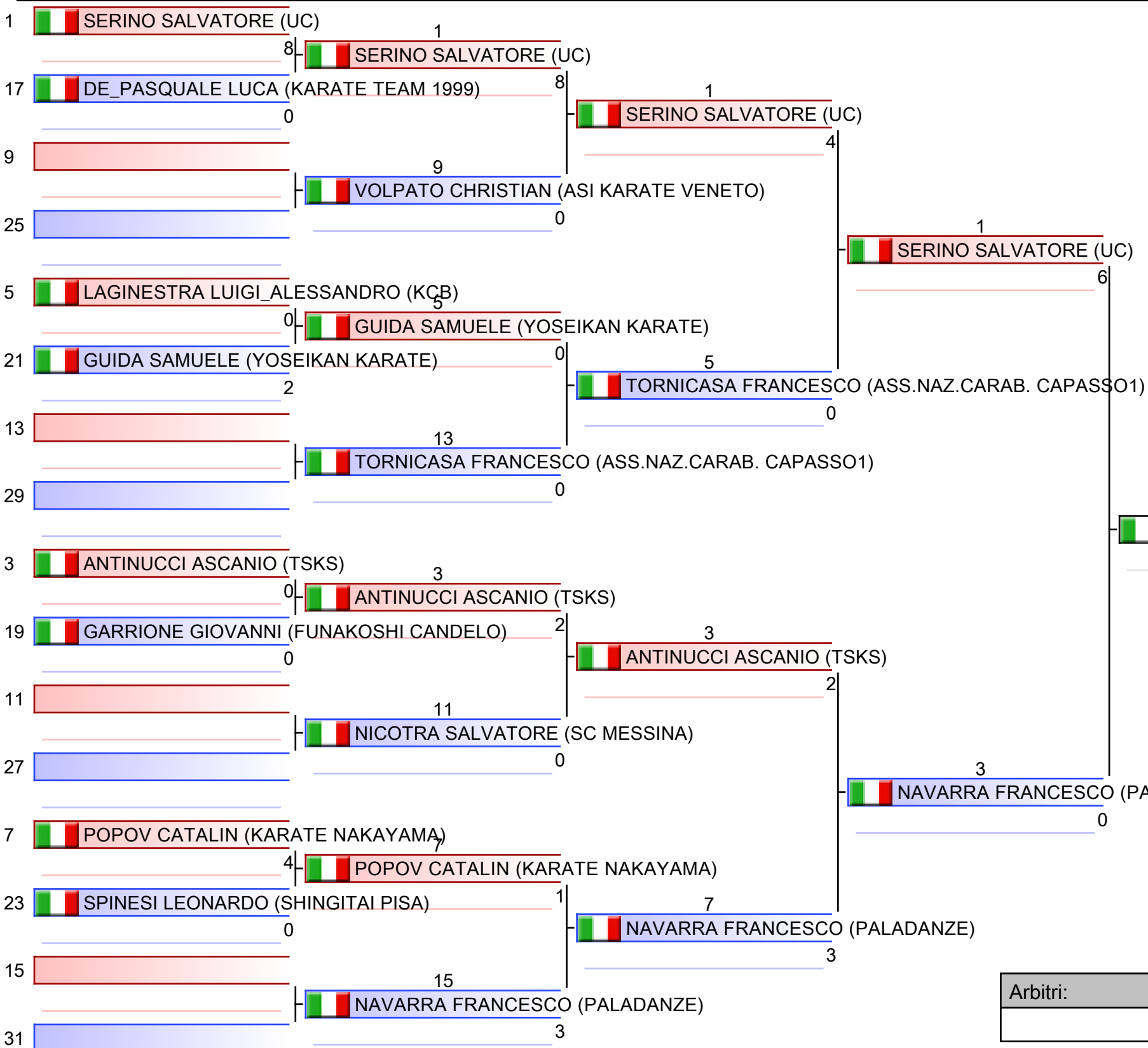

- 1. DE_STEFANO EMANUELE (SHIZOKU KRT AV)
- 2. SERINO SALVATORE (UC)
- 3. TORNICASA FRANCESCO (ASS.NAZ.CARAB. C)
- 3. ZANNI FEDERICO (KARATE POZZUOLO)
- 5. NAVARRA FRANCESCO (PALADANZE)
- 5. MOI GIOELE (KARATE TEAM 1999)
- 7. DE_PASQUALE LUCA (KARATE TEAM 1999)
- 7. GENTA JACOPO (KCS - LIGURIA KARATE)

Arbitri:			

Kumite Individual male Cadets -57

VENETO OPEN, Via S. Marco, 53, 35129 Padova PD, ITA

2023-05-20

Tatami
3 10:05

Tabelloni - Pool
2/2

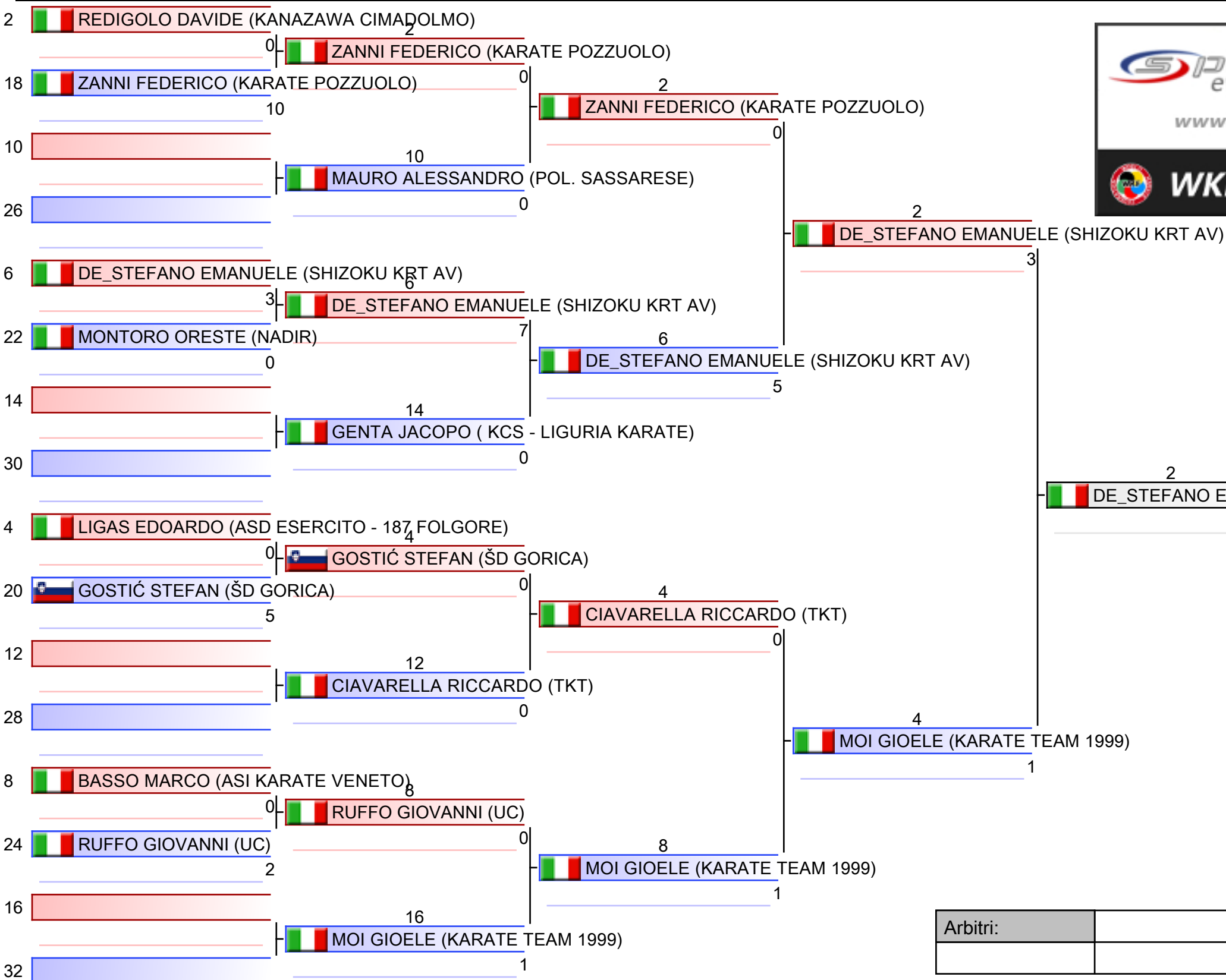

- | |
|-------------------------------------------|
| 1. DE_STEFANO EMANUELE (SHIZOKU KRT AV) |
| 2. SERINO SALVATORE (UC) |
| 3. TORNICASA FRANCESCO (ASS.NAZ.CARAB. C) |
| 3. ZANNI FEDERICO (KARATE POZZUOLO) |
| 5. NAVARRA FRANCESCO (PALADANZE) |
| 5. MOI GIOELE (KARATE TEAM 1999) |
| 7. DE_PASQUALE LUCA (KARATE TEAM 1999) |
| 7. GENTA JACOPO (KCS - LIGURIA KARATE) |

Arbitri:			

Vincitore di pool-Kumite Individual male Cadets -57

VENETO OPEN, Via S. Marco, 53, 35129 Padova PD, ITA

Tatami

Tabelloni - Pool

1/1

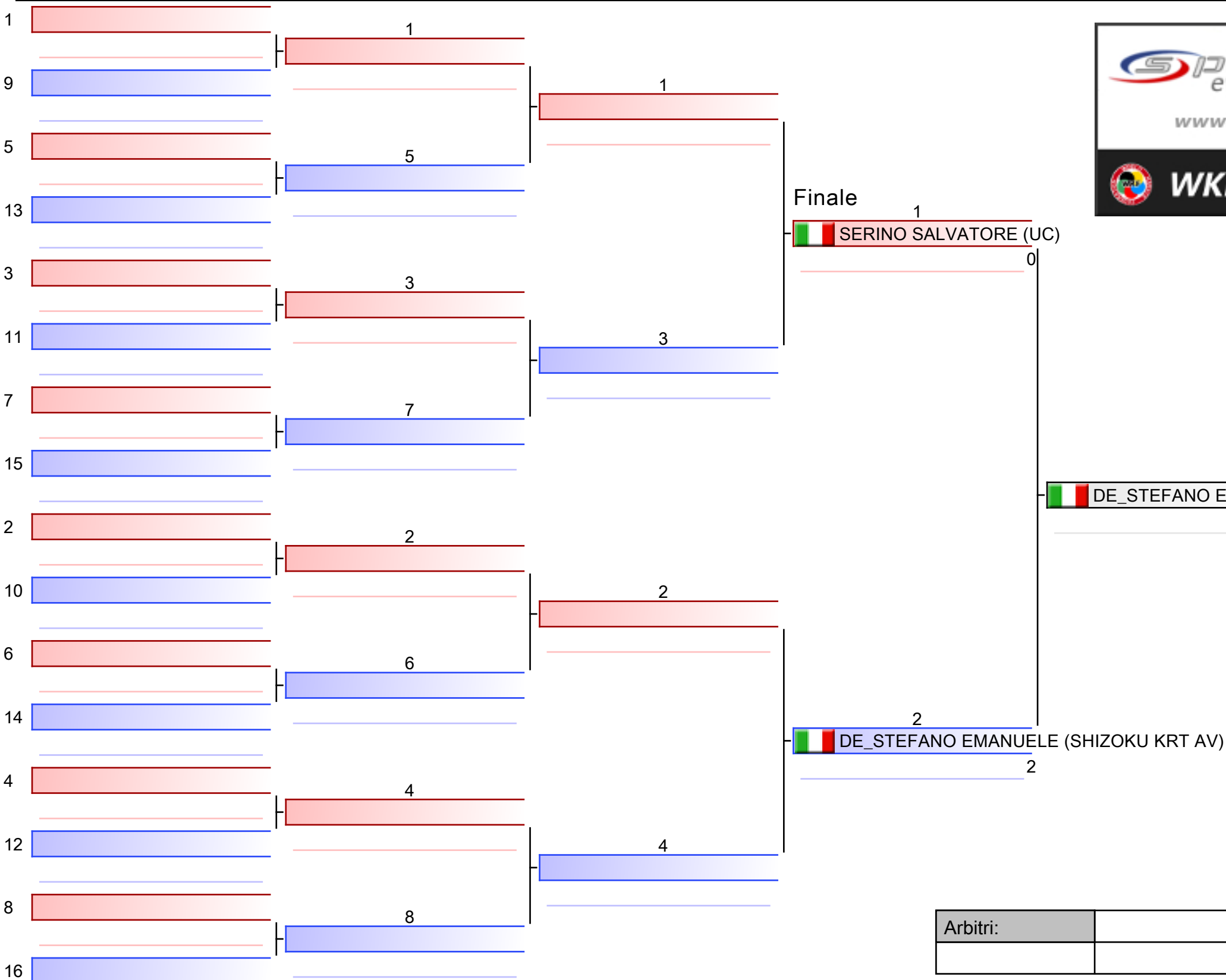

- | |
|-------------------------------------------|
| 1. DE_STEFANO EMANUELE (SHIZOKU KRT AV) |
| 2. SERINO SALVATORE (UC) |
| 3. TORNICASA FRANCESCO (ASS.NAZ.CARAB. C) |
| 3. ZANNI FEDERICO (KARATE POZZUOLO) |
| 5. NAVARRA FRANCESCO (PALADANZE) |
| 5. MOI GIOELE (KARATE TEAM 1999) |
| 7. DE_PASQUALE LUCA (KARATE TEAM 1999) |
| 7. GENTA JACOPO (KCS - LIGURIA KARATE) |

Arbitri:			

Kumite Individual male Cadets -57

VENETO OPEN

2023-05-20

Tatami
4 12:45

Tabelloni - Pool
1,2

(c)sportdata GmbH & Co KG 2000-2023 (2023-05-21 20:06) v 10.0.0 build 1 (2023-02-10) Licenza: Fijlkam Karate 2023 (expire 2023-12-31)

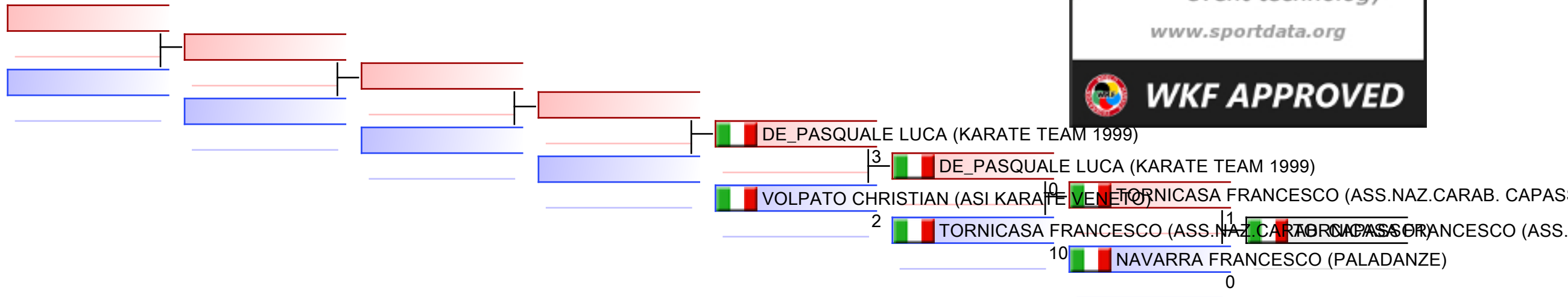

Ripescaggi: (1,2)

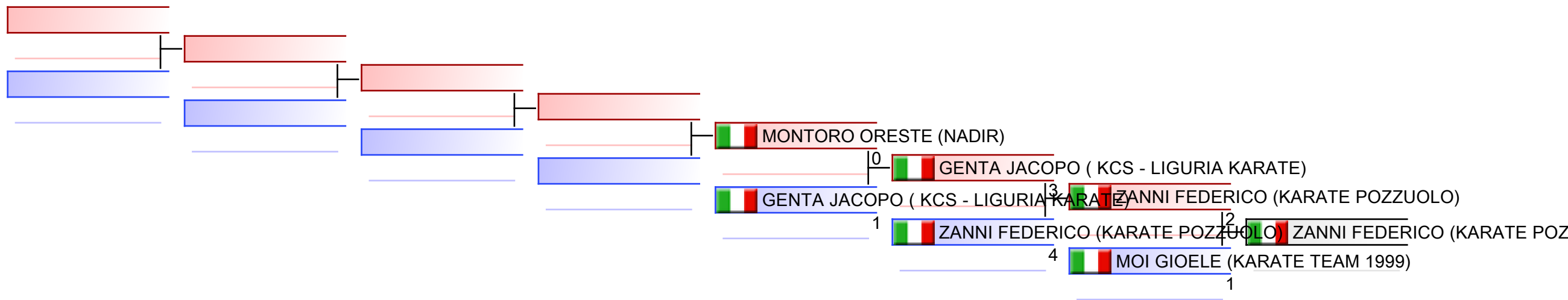

Arbitri:							
----------	--	--	--	--	--	--	--

Kumite Individual male Cadets -63

VENETO OPEN, Via S. Marco, 53, 35129 Padova PD, ITA

2023-05-20

Tatami
5 11:10

Tabelloni - Pool
1/2

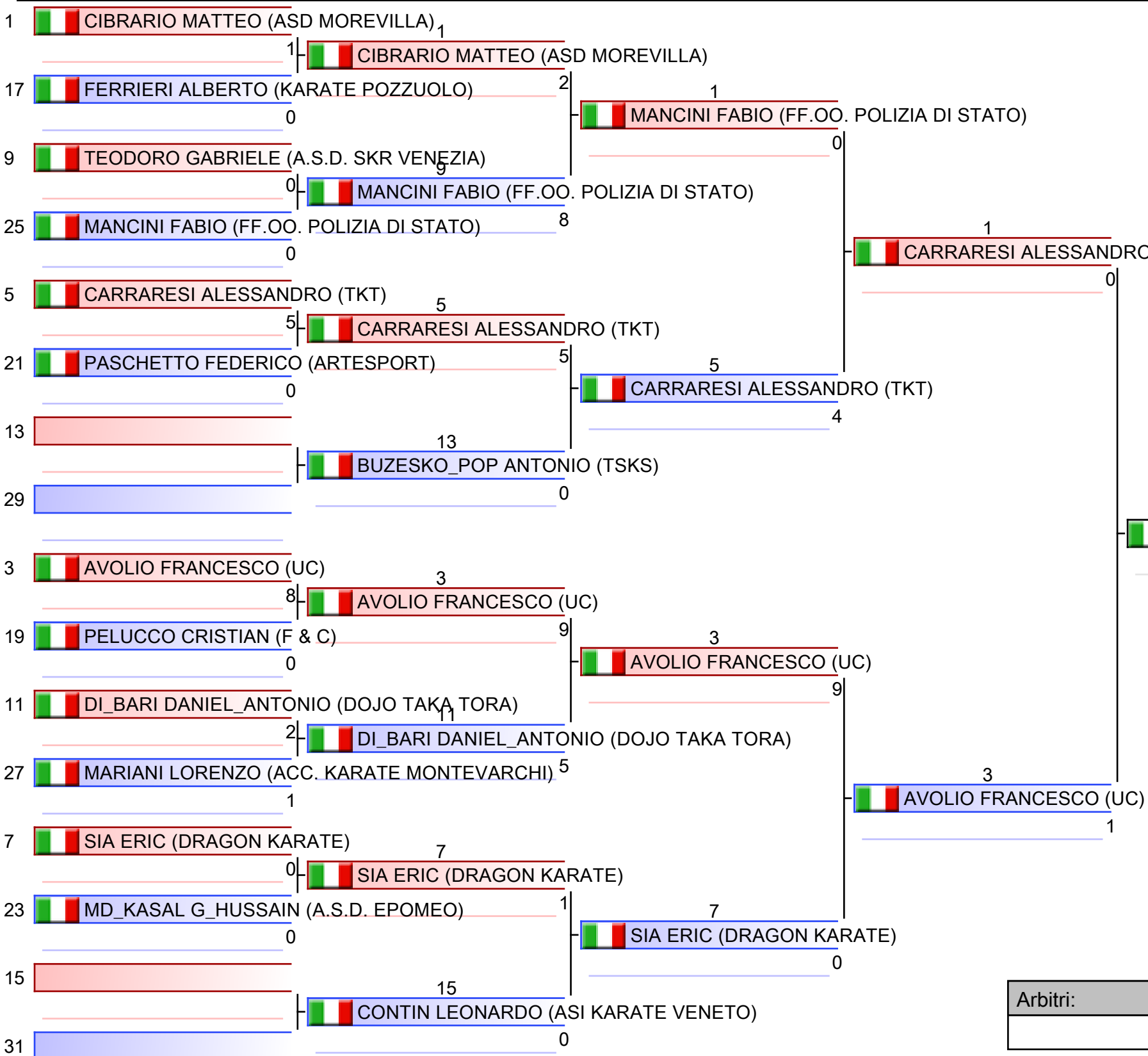

1. AVOLIO FRANCESCO (UC)
2. PANICO VALENTINO (C.S TEODORO)
3. DI_BARI DANIEL_ANTONIO (DOJO TAKA TORA)
3. RUSSOMANNO GIOELE_ANTONIO (SHIRAI CLU)
5. CARRARESI ALESSANDRO (TKT)
5. CASTELLAZZI CHRISTIAN (LEONI KARATE TEA)
7. SIA ERIC (DRAGON KARATE)
7. PAPPAPCENA GIUSEPPE (NADIR)

Arbitri:			

Kumite Individual male Cadets -63

VENETO OPEN, Via S. Marco, 53, 35129 Padova PD, ITA

2023-05-20

Tatami
6 11:10

Tabelloni - Pool
2/2

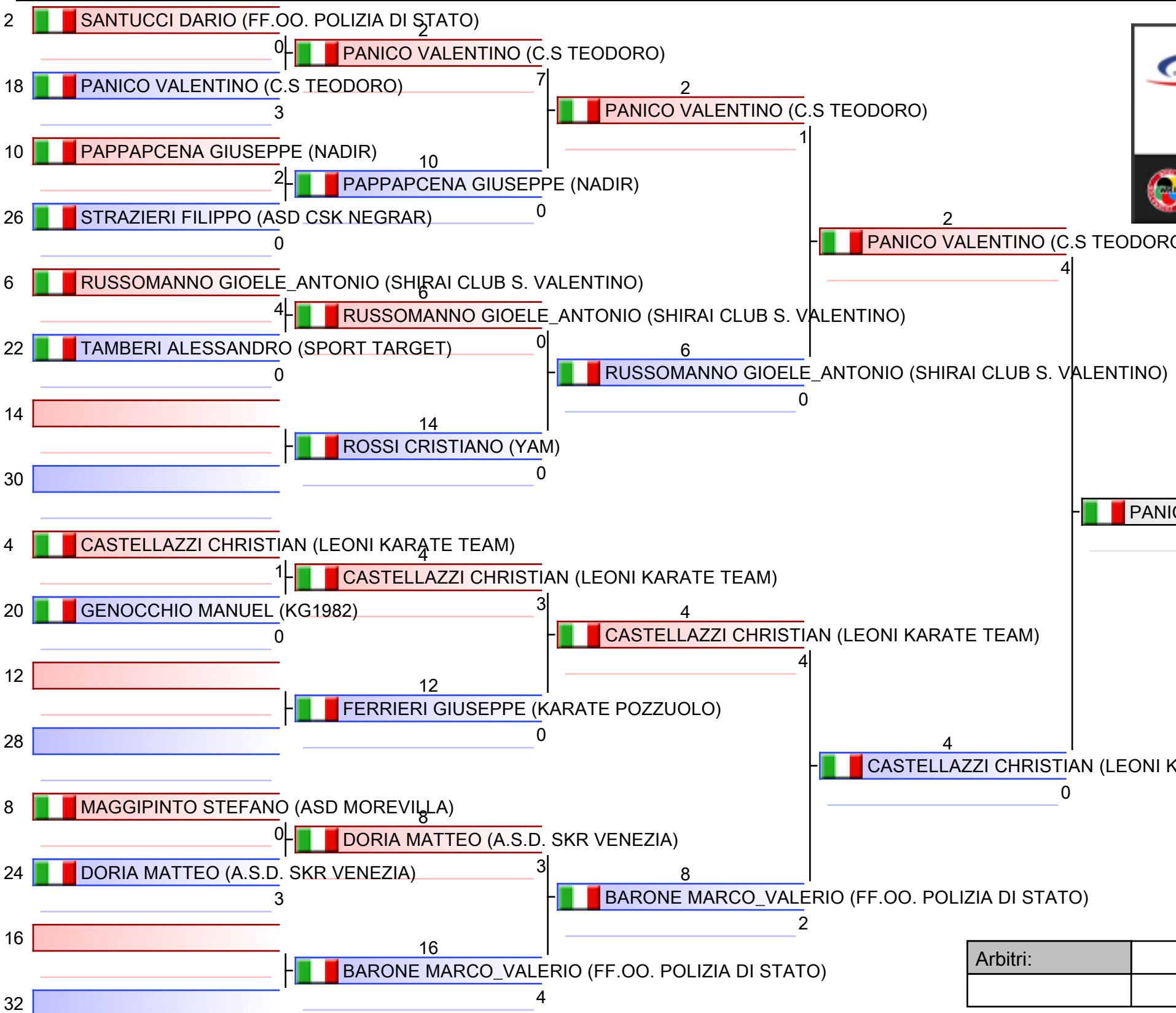

1. AVOLIO FRANCESCO (UC)
2. PANICO VALENTINO (C.S TEODORO)
3. DI_BARI DANIEL_ ANTONIO (DOJO TAKA TORA)
3. RUSSOMANNO GIOELE_ ANTONIO (SHIRAI CLUB S. VALENTINO)
5. CARRARESI ALESSANDRO (TKT)
5. CASTELLAZZI CHRISTIAN (LEONI KARATE TEAM)
7. SIA ERIC (DRAGON KARATE)
7. PAPPAPCENA GIUSEPPE (NADIR)

Arbitri:			

Vincitore di pool-Kumite Individual male Cadets -63

VENETO OPEN, Via S. Marco, 53, 35129 Padova PD, ITA

Tatami

Tabelloni - Pool

1/1

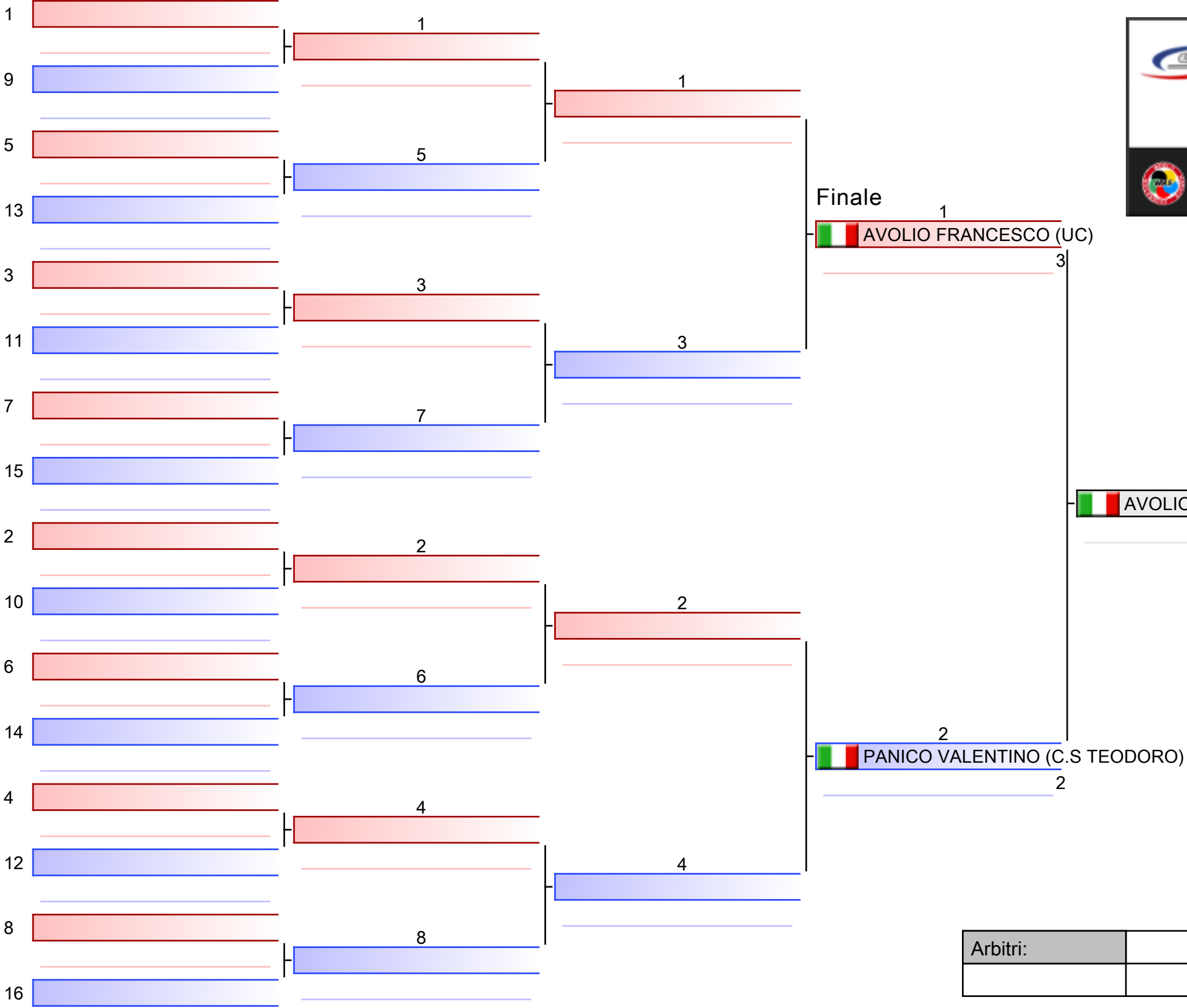

- | |
|---------------------------------------------|
| 1. AVOLIO FRANCESCO (UC) |
| 2. PANICO VALENTINO (C.S TEODORO) |
| 3. DI_BARI DANIEL_ANTONIO (DOJO TAKA TORA) |
| 3. RUSSOMANNO GIOELE_ANTONIO (SHIRAI CLU) |
| 5. CARRARESI ALESSANDRO (TKT) |
| 5. CASTELLAZZI CHRISTIAN (LEONI KARATE TEA) |
| 7. SIA ERIC (DRAGON KARATE) |
| 7. PAPPAPCENA GIUSEPPE (NADIR) |

Arbitri:			

Kumite Individual male Cadets -63

VENETO OPEN

2023-05-20

Tatami
3 12:35

Tabelloni - Pool
1,2

(c)sportdata GmbH & Co KG 2000-2023 (2023-05-21 20:06) v 10.0.0 build 1 (2023-02-10) Licenza: Fijlkam Karate 2023 (expire 2023-12-31)

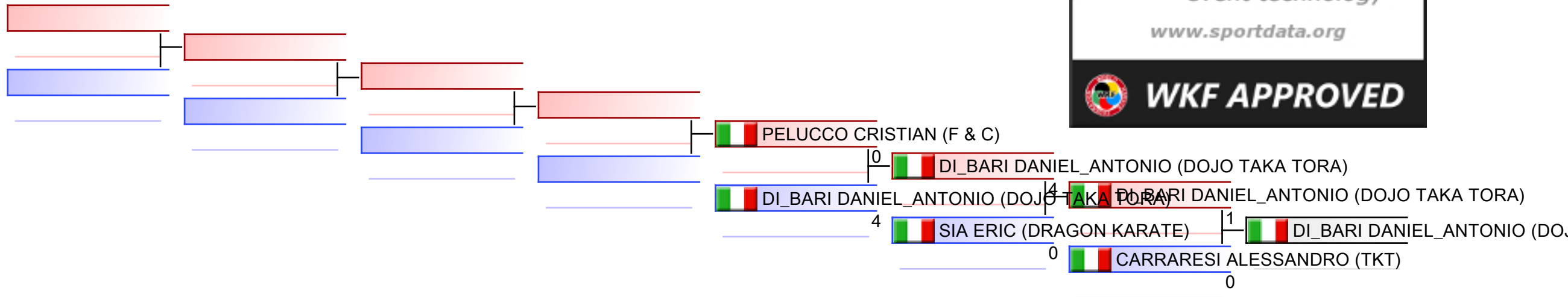

Ripescaggi: (1,2)

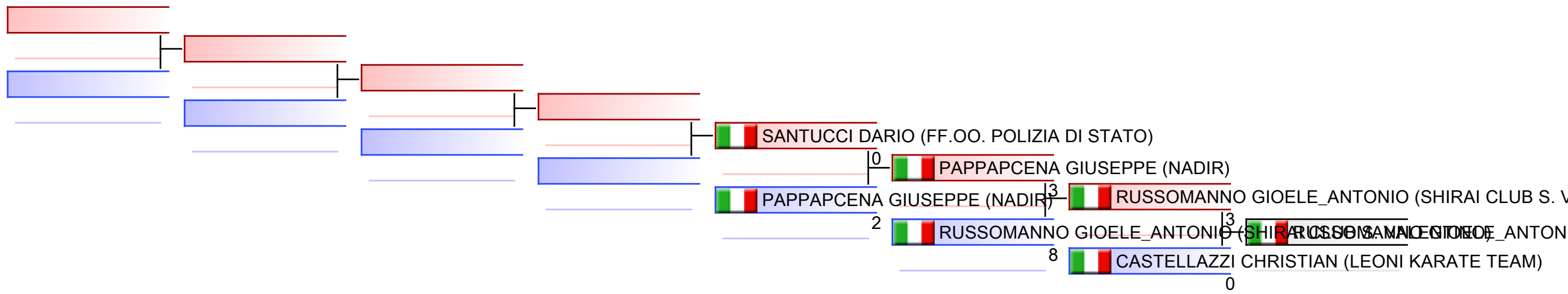

Arbitri:							
----------	--	--	--	--	--	--	--

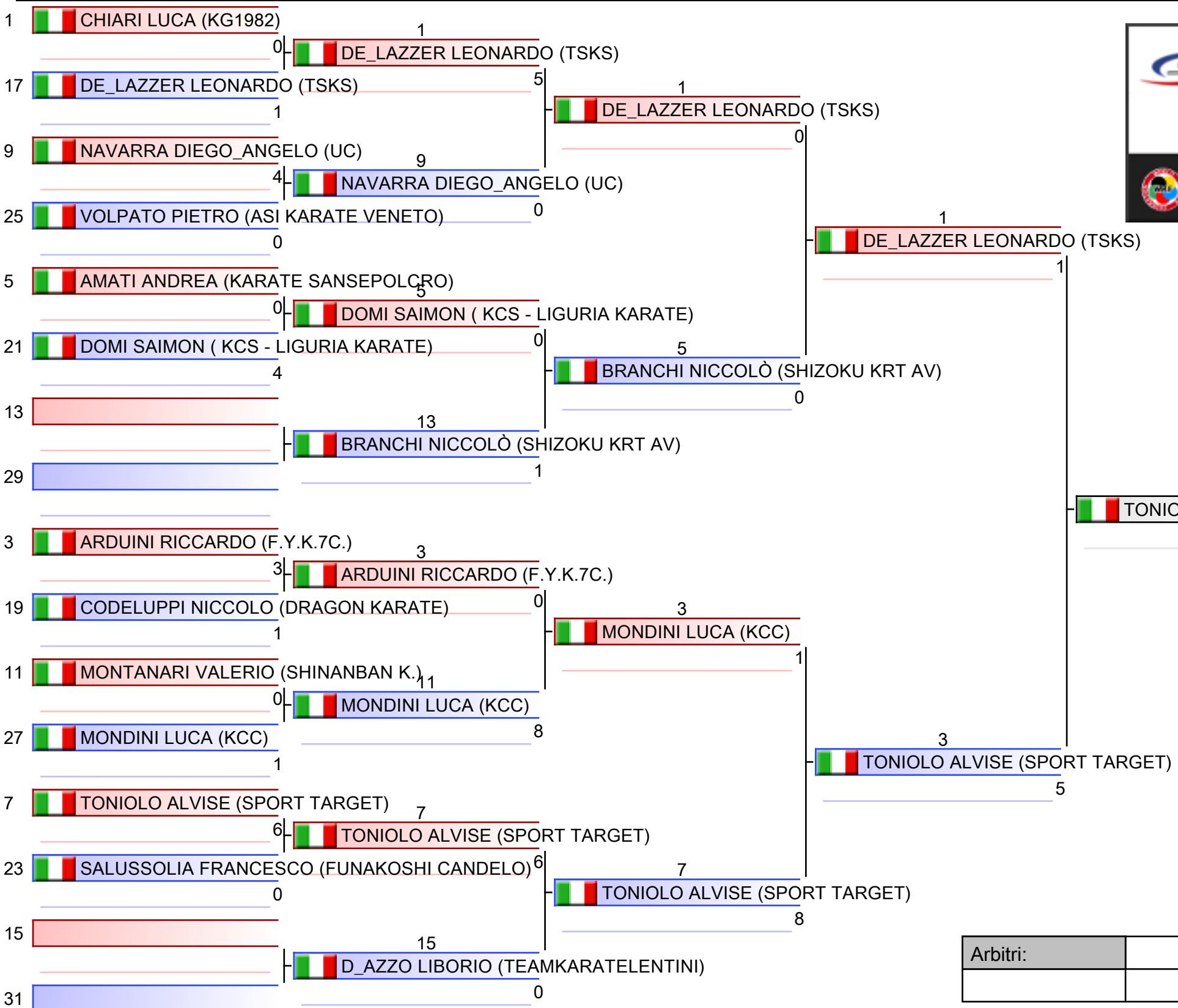

1. TONIOLO ALVISE (SPORT TARGET)
2. FERRARINI FRANCESCO (ASD JK CLUB)
3. BASILE MANUEL (PALADANZE)
3. MONDINI LUCA (KCC)
5. REALINI NICCOLÒ (KG1982)
5. DE_LAZZER LEONARDO (TSKS)
7. NICOLAI RICCARDO (AI DAI CLUB)
7. SALUSSOLIA FRANCESCO (FUNAKOSHI CAND)

Arbitri:			

Kumite Individual male Cadets -70

VENETO OPEN, Via S. Marco, 53, 35129 Padova PD, ITA

2023-05-20

Tatami
4 11:15

Tabelloni - Pool
2/2

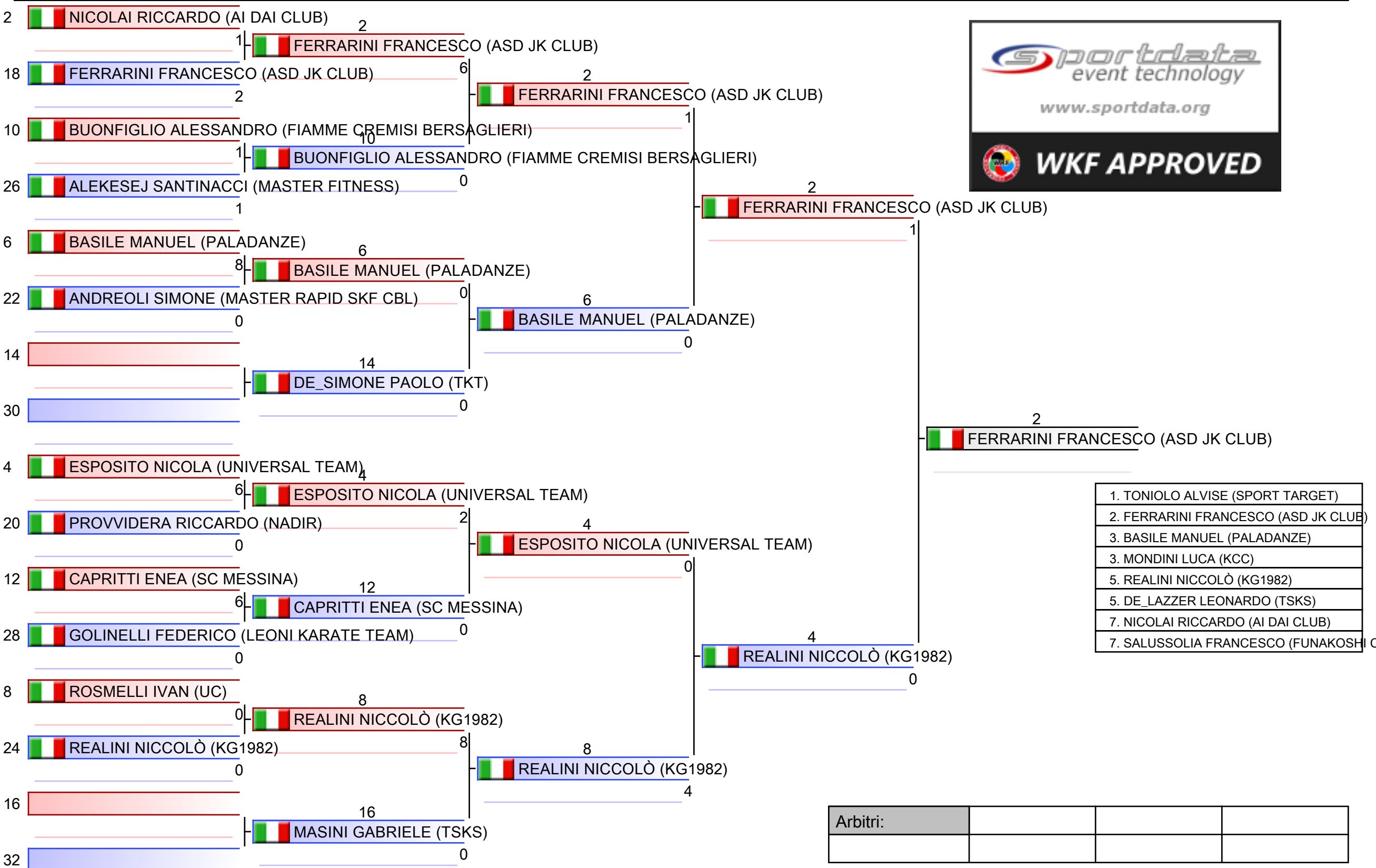

- | |
|------------------------------------------|
| 1. TONIOLO ALVISE (SPORT TARGET) |
| 2. FERRARINI FRANCESCO (ASD JK CLUB) |
| 3. BASILE MANUEL (PALADANZE) |
| 3. MONDINI LUCA (KCC) |
| 5. REALINI NICCOLÒ (KG1982) |
| 5. DE_LAZZER LEONARDO (TSKS) |
| 7. NICOLAI RICCARDO (AI DAI CLUB) |
| 7. SALUSSOLIA FRANCESCO (FUNAKOSHI CAND) |

Arbitri:			

Vincitore di pool-Kumite Individual male Cadets -70

VENETO OPEN, Via S. Marco, 53, 35129 Padova PD, ITA

Tatami

Tabelloni - Pool

1/1

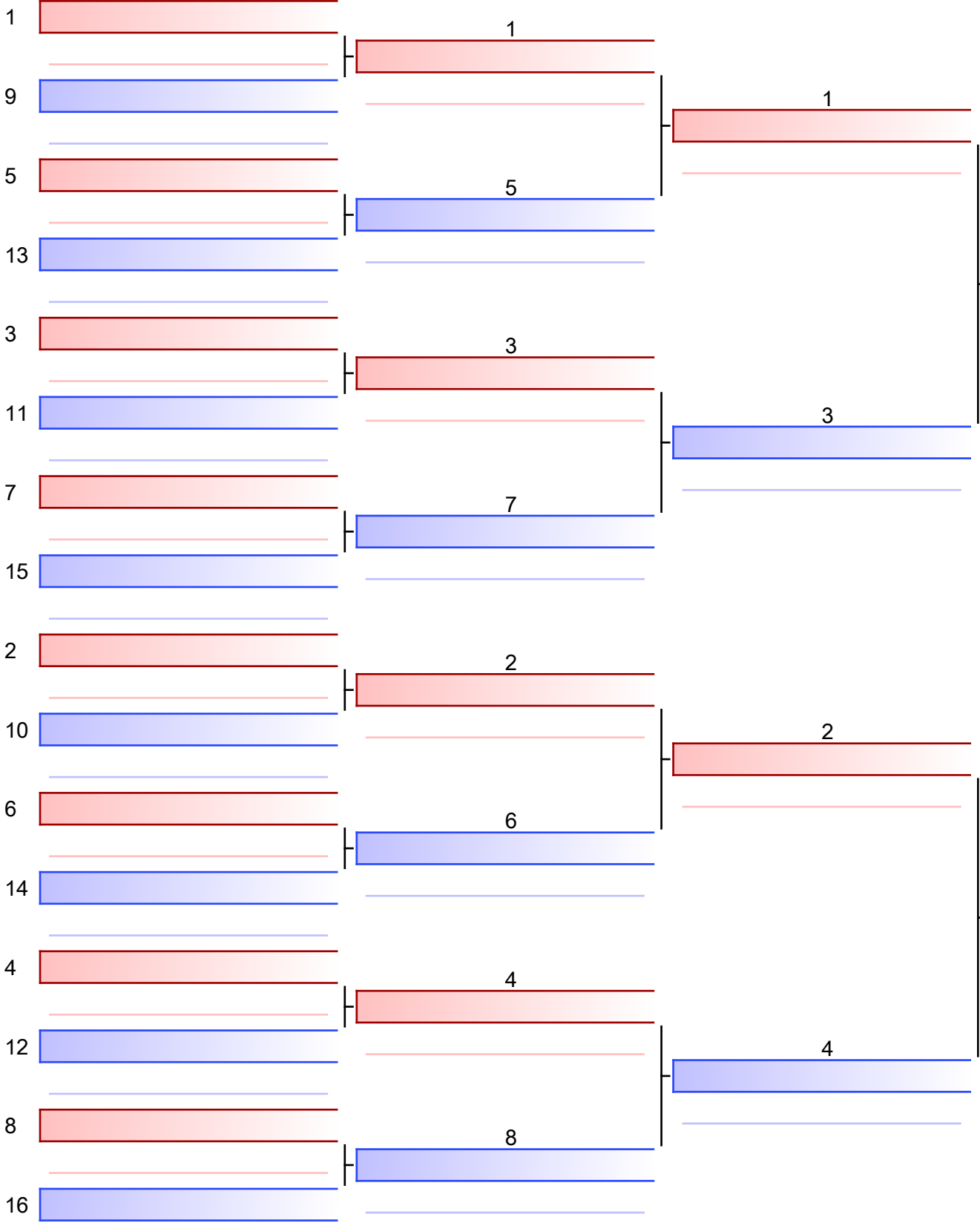

Finale

TONIOLO ALVISE (SPORT TARGET)

2

TONIOLO ALVISE (SPORT TARGET)

FERRARINI FRANCESCO (ASD JK CLUB)

0

1. TONIOLO ALVISE (SPORT TARGET)
2. FERRARINI FRANCESCO (ASD JK CLUB)
3. BASILE MANUEL (PALADANZE)
3. MONDINI LUCA (KCC)
5. REALINI NICCOLÒ (KG1982)
5. DE_LAZZER LEONARDO (TSKS)
7. NICOLAI RICCARDO (AI DAI CLUB)
7. SALUSSOLIA FRANCESCO (FUNAKOSHI CAND)

Arbitri:			

Kumite Individual male Cadets -70

VENETO OPEN

2023-05-20

Tatami
3 13:05

Tabelloni - Pool
1,2

(c)sportdata GmbH & Co KG 2000-2023 (2023-05-21 20:06) v 10.0.0 build 1 (2023-02-10) Licenza: Fijlkam Karate 2023 (expire 2023-12-31)

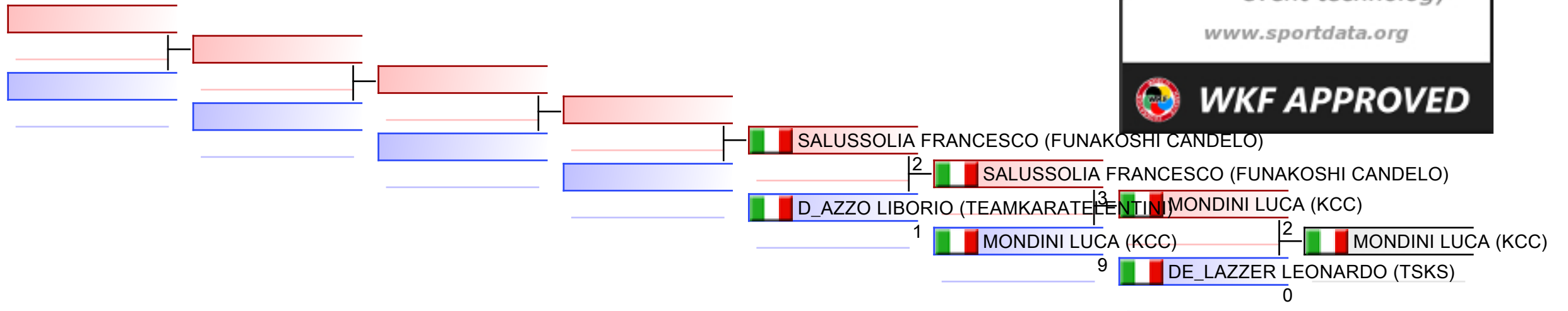

Ripescaggi: (1,2)

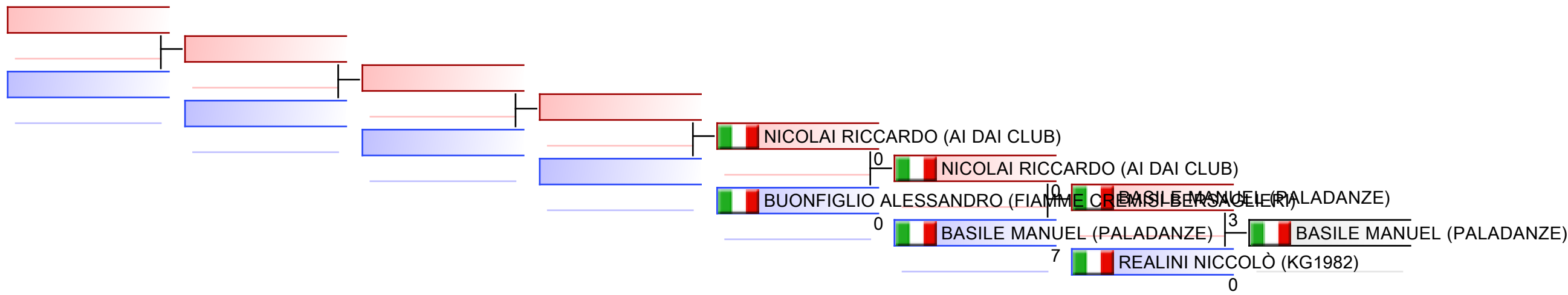

Arbitri:							
----------	--	--	--	--	--	--	--

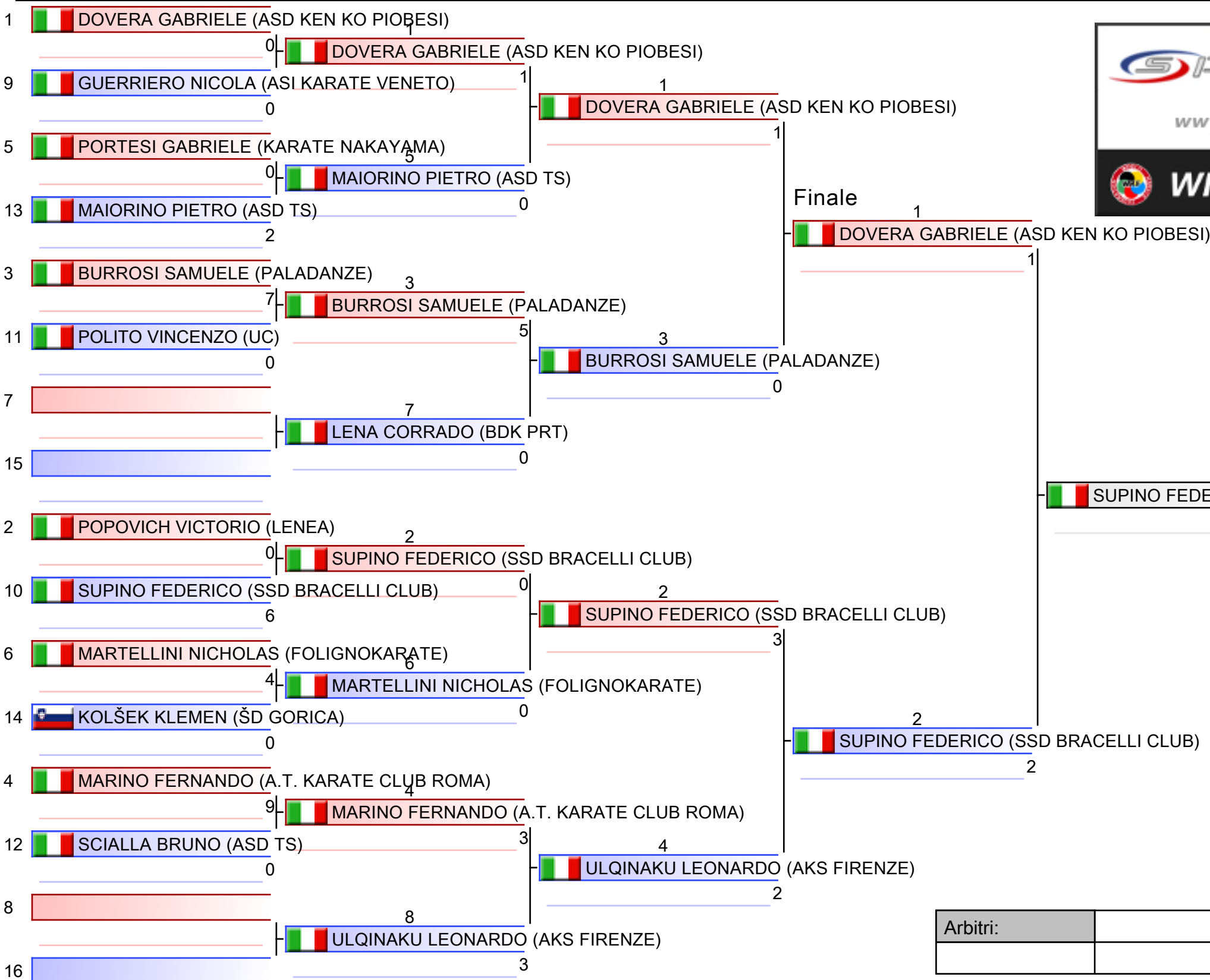

- | |
|-----------------------------------------|
| 1. SUPINO FEDERICO (SSD BRACELLI CLUB) |
| 2. DOVERA GABRIELE (ASD KEN KO PIOBESI) |
| 3. BURROSI SAMUELE (PALADANZE) |
| 3. MARTELLINI NICHOLAS (FOLIGNOKARATE) |
| 5. GUERRIERO NICOLA (ASI KARATE VENETO) |
| 5. ULQINAKU LEONARDO (AKS FIRENZE) |
| 7. MAIORINO PIETRO (ASD TS) |
| 7. POPOVICH VICTORIO (LENEA) |

Arbitri:			

Kumite Individual male Juniors +76

VENETO OPEN

2023-05-20

Tatami
2 17:35

Tabelloni - Pool
1

(c)sportdata GmbH & Co KG 2000-2023 (2023-05-21 20:06) v 10.0.0 build 1 (2023-02-10) Licenza: Fijlkam Karate 2023 (expire 2023-12-31)

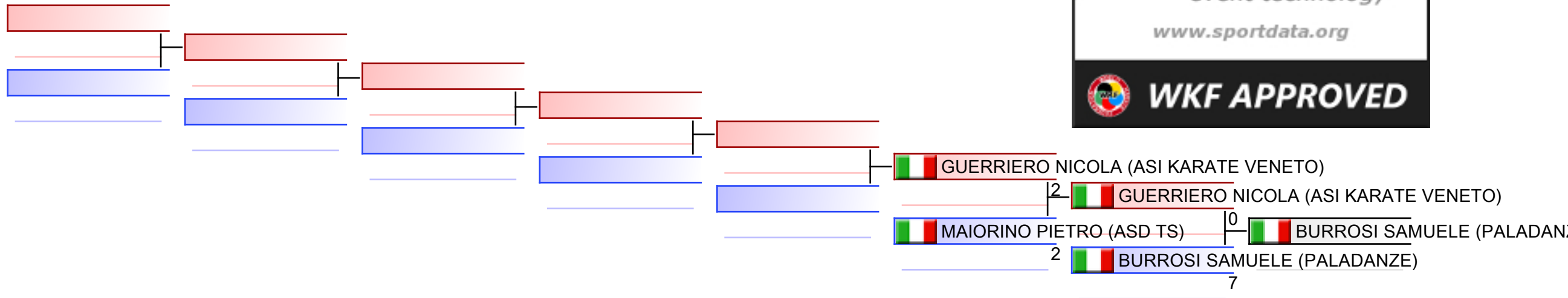

Ripescaggi: (1)

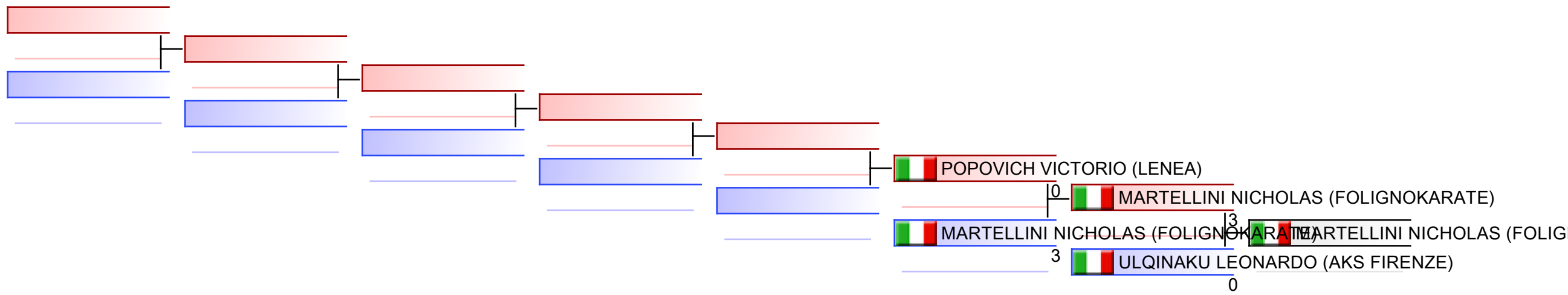

Arbitri:							
----------	--	--	--	--	--	--	--

Kumite Individual male Juniors -55

VENETO OPEN, Via S. Marco, 53, 35129 Padova PD, ITA

2023-05-20

Tatami
3 15:35

Tabelloni - Pool
1/1

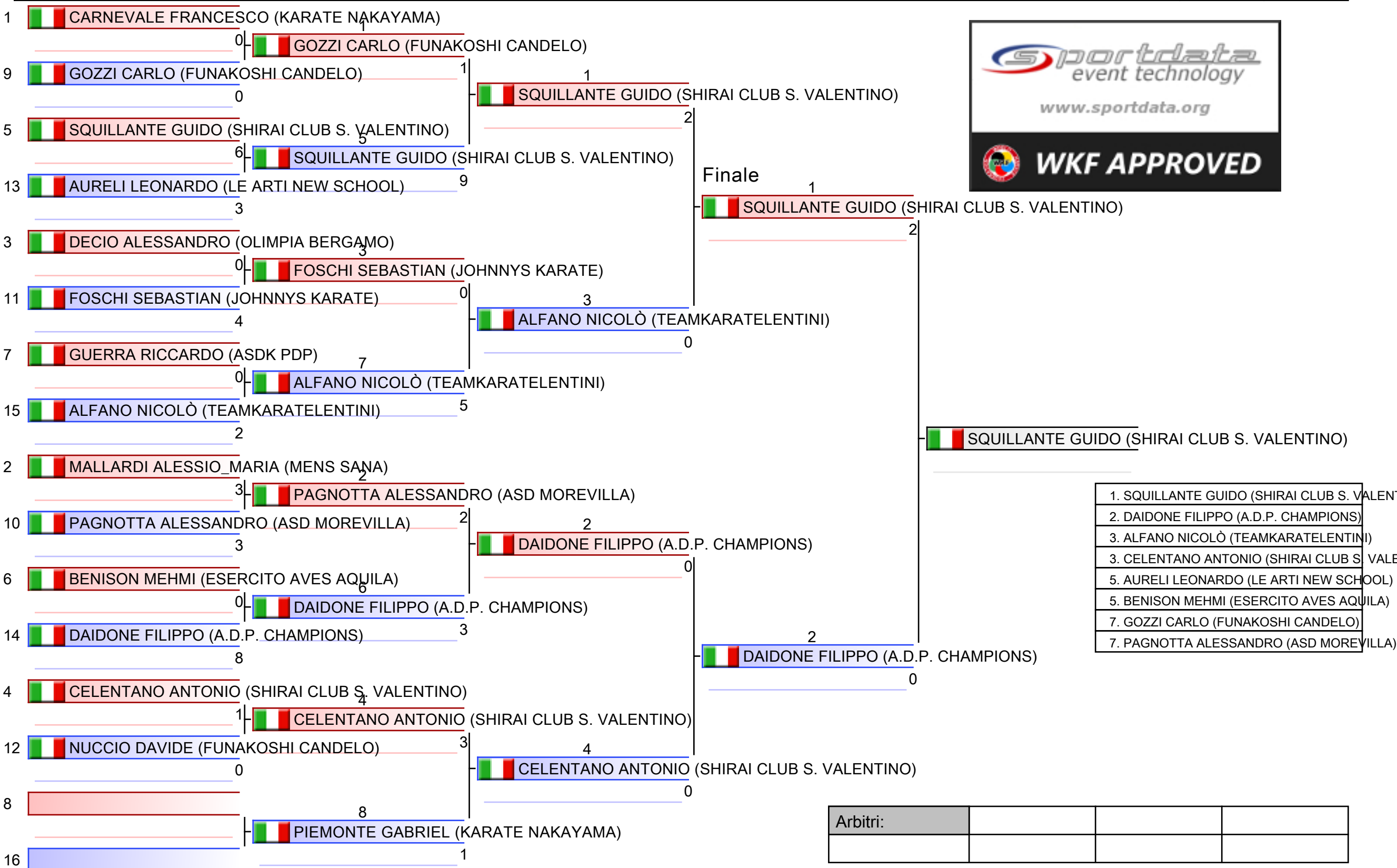

1. SQUILLANTE GUIDO (SHIRAI CLUB S. VALENTINO)
2. DAIDONE FILIPPO (A.D.P. CHAMPIONS)
3. ALFANO NICOLÒ (TEAMKARATELENTINI)
3. CELENTANO ANTONIO (SHIRAI CLUB S. VALENTINO)
5. AURELI LEONARDO (LE ARTI NEW SCHOOL)
5. BENISON MEHMI (ESERCITO AVES AQUILA)
7. GOZZI CARLO (FUNAKOSHI CANDELO)
7. PAGNOTTA ALESSANDRO (ASD MOREVILLA)

Arbitri:			

Kumite Individual male Juniors -55

VENETO OPEN

2023-05-20

Tatami
2 17:15

Tabelloni - Pool
1

(c)sportdata GmbH & Co KG 2000-2023 (2023-05-21 20:07) v 10.0.0 build 1 (2023-02-10) Licenza: Fijlkam Karate 2023 (expire 2023-12-31)

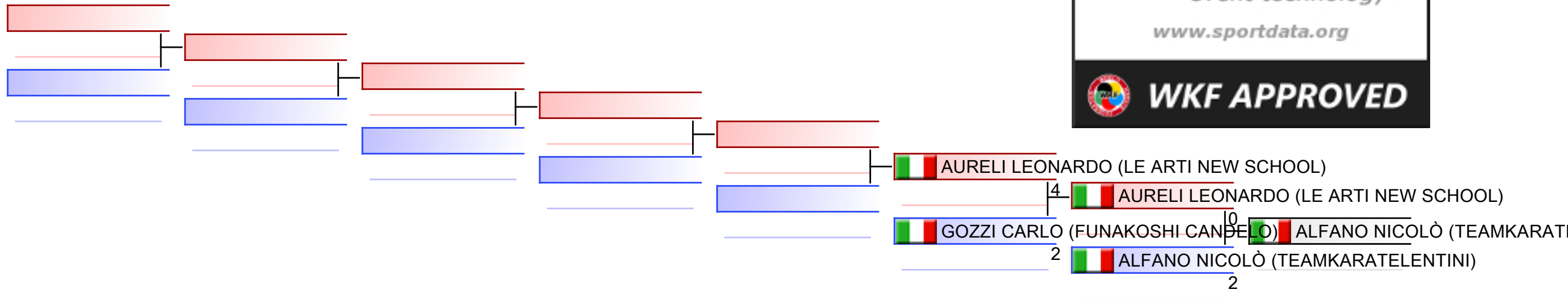

Ripescaggi: (1)

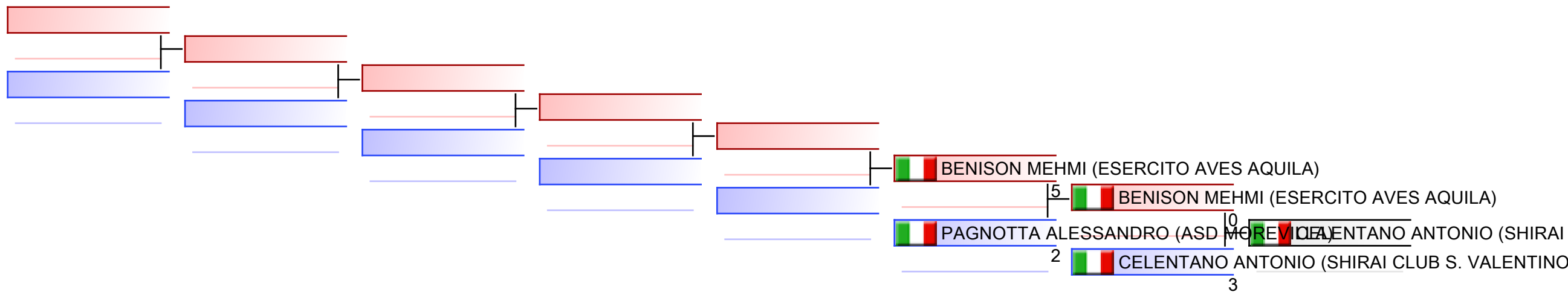

Arbitri:							
----------	--	--	--	--	--	--	--

Kumite Individual male Juniors -61

VENETO OPEN, Via S. Marco, 53, 35129 Padova PD, ITA

2023-05-20

Tatami
4 16:40

Tabelloni - Pool
1/2

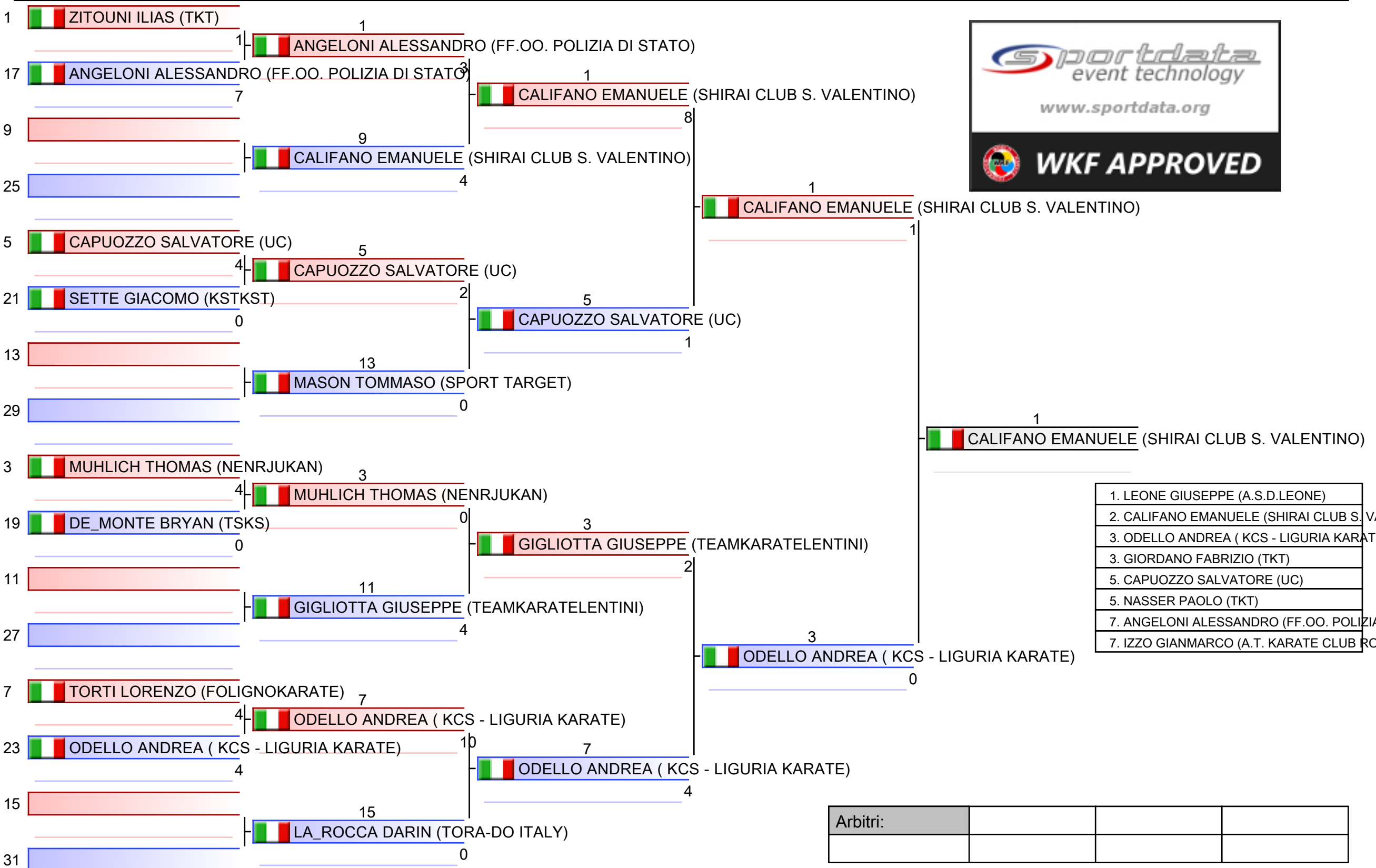

1. LEONE GIUSEPPE (A.S.D.LEONE)
2. CALIFANO EMANUELE (SHIRAI CLUB S. VALENTINO)
3. ODELLO ANDREA (KCS - LIGURIA KARATE)
3. GIORDANO FABRIZIO (TKT)
5. CAPUOZZO SALVATORE (UC)
5. NASSER PAOLO (TKT)
7. ANGELONI ALESSANDRO (FF.OO. POLIZIA DI STATO)
7. IZZO GIANMARCO (A.T. KARATE CLUB ROMA)

Arbitri:			

Kumite Individual male Juniors -61

VENETO OPEN, Via S. Marco, 53, 35129 Padova PD, ITA

2023-05-20

Tatami
5 16:40

Tabelloni - Pool
2/2

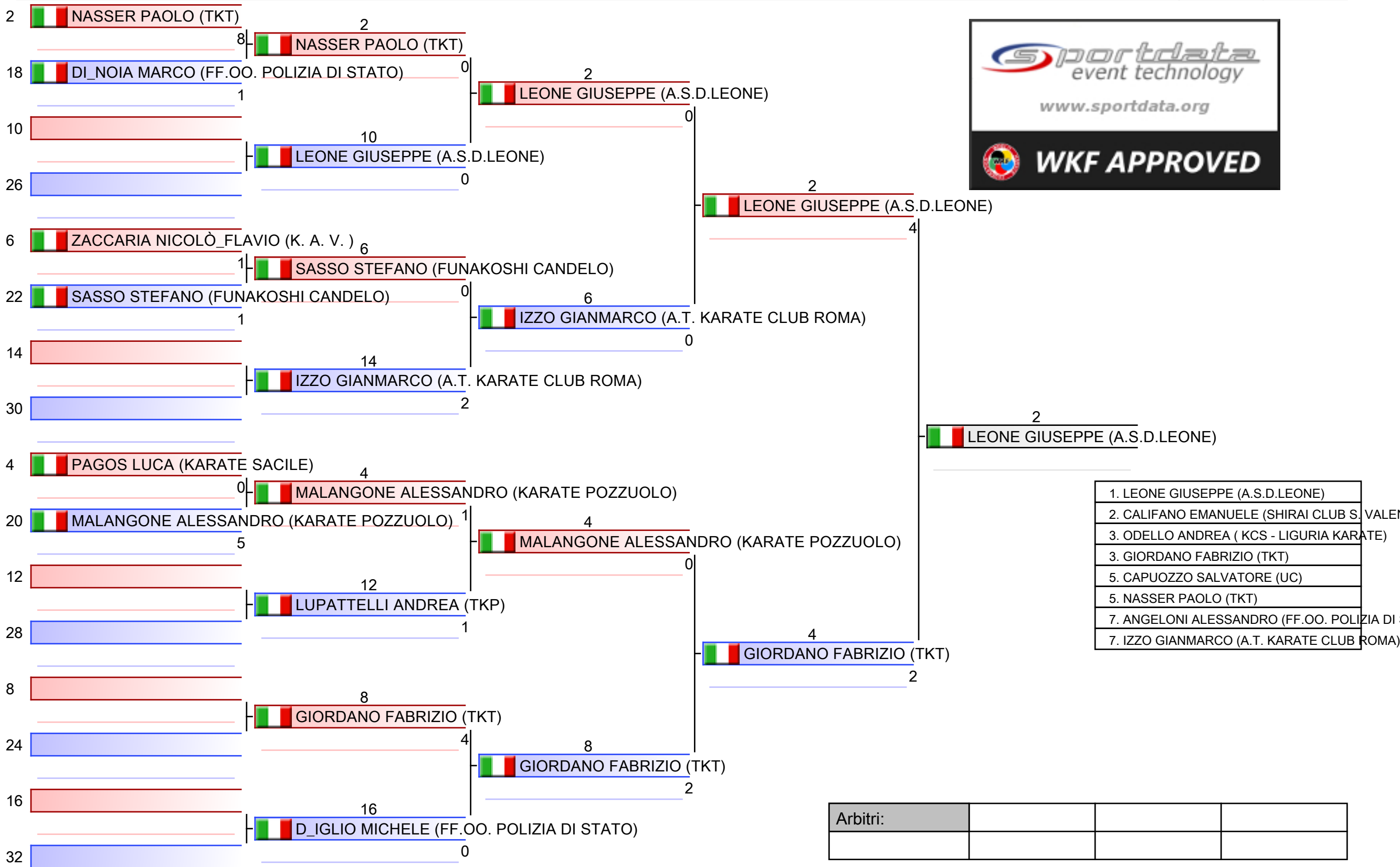

Vincitore di pool-Kumite Individual male Juniors -61

VENETO OPEN, Via S. Marco, 53, 35129 Padova PD, ITA

Tatami

Tabelloni - Pool

1/1

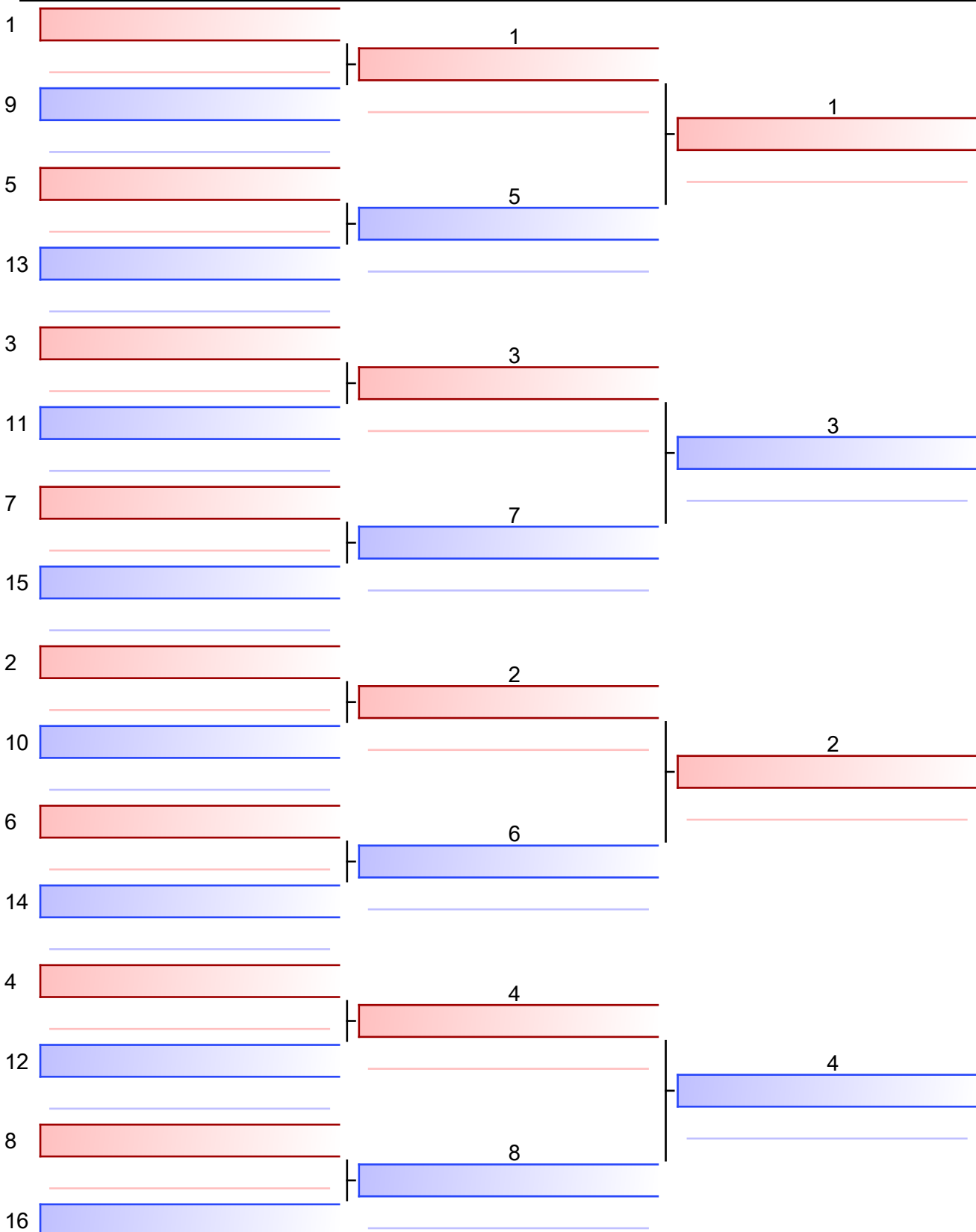

Finale

1
 CALIFANO EMANUELE (SHIRAI CLUB S. VALENTINO)

0

LEONE GIUSEPPE (A.S.D.LEONE)

2
 LEONE GIUSEPPE (A.S.D.LEONE)

4

- | |
|-------------------------------------------------|
| 1. LEONE GIUSEPPE (A.S.D.LEONE) |
| 2. CALIFANO EMANUELE (SHIRAI CLUB S. VALENTINO) |
| 3. ODELLO ANDREA (KCS - LIGURIA KARATE) |
| 3. GIORDANO FABRIZIO (TKT) |
| 5. CAPUOZZO SALVATORE (UC) |
| 5. NASSER PAOLO (TKT) |
| 7. ANGELONI ALESSANDRO (FF.OO. POLIZIA DI S... |
| 7. IZZO GIANMARCO (A.T. KARATE CLUB ROMA) |

Arbitri:			

Kumite Individual male Juniors -61

VENETO OPEN

2023-05-20

Tatami
5 17:40

Tabelloni - Pool
1,2

(c)sportdata GmbH & Co KG 2000-2023 (2023-05-21 20:07) v 10.0.0 build 1 (2023-02-10) Licenza: Fijlkam Karate 2023 (expire 2023-12-31)

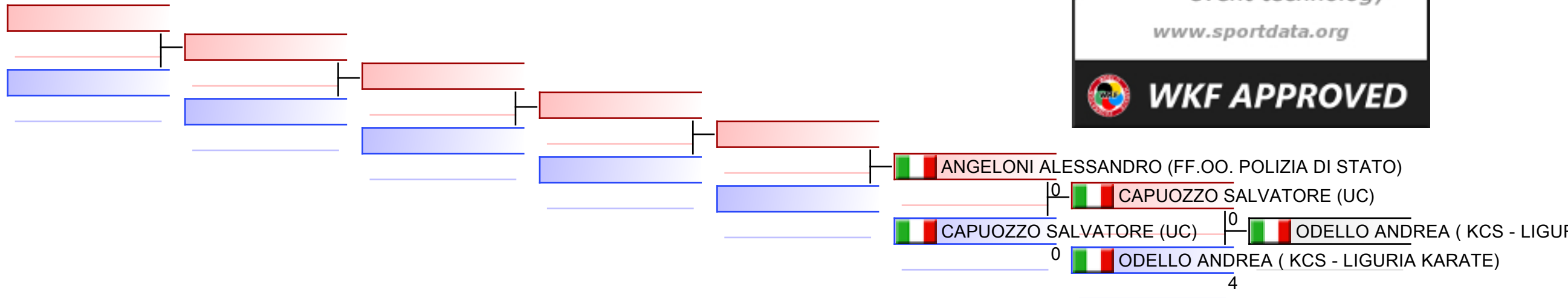

Ripescaggi: (1,2)

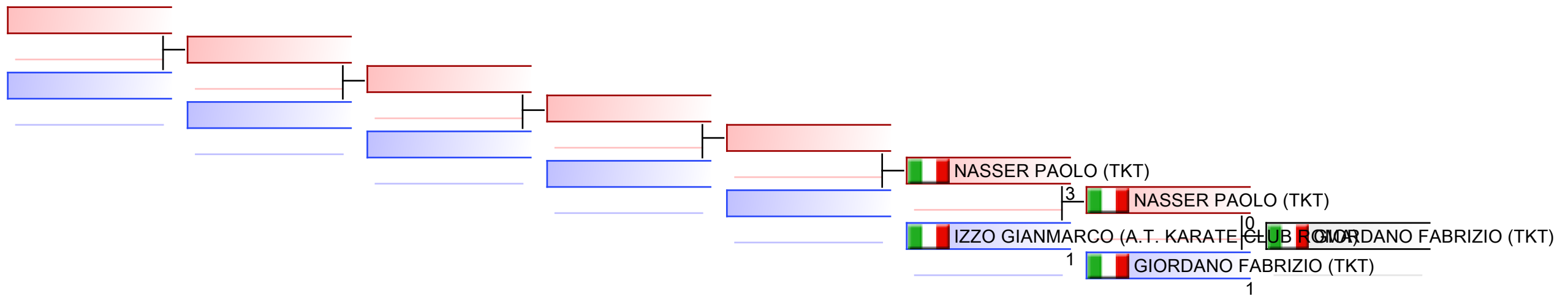

Arbitri:							
----------	--	--	--	--	--	--	--

Kumite Individual male Juniors -68

VENETO OPEN, Via S. Marco, 53, 35129 Padova PD, ITA

2023-05-20

Tatami
5 15:25

Tabelloni - Pool
1/2

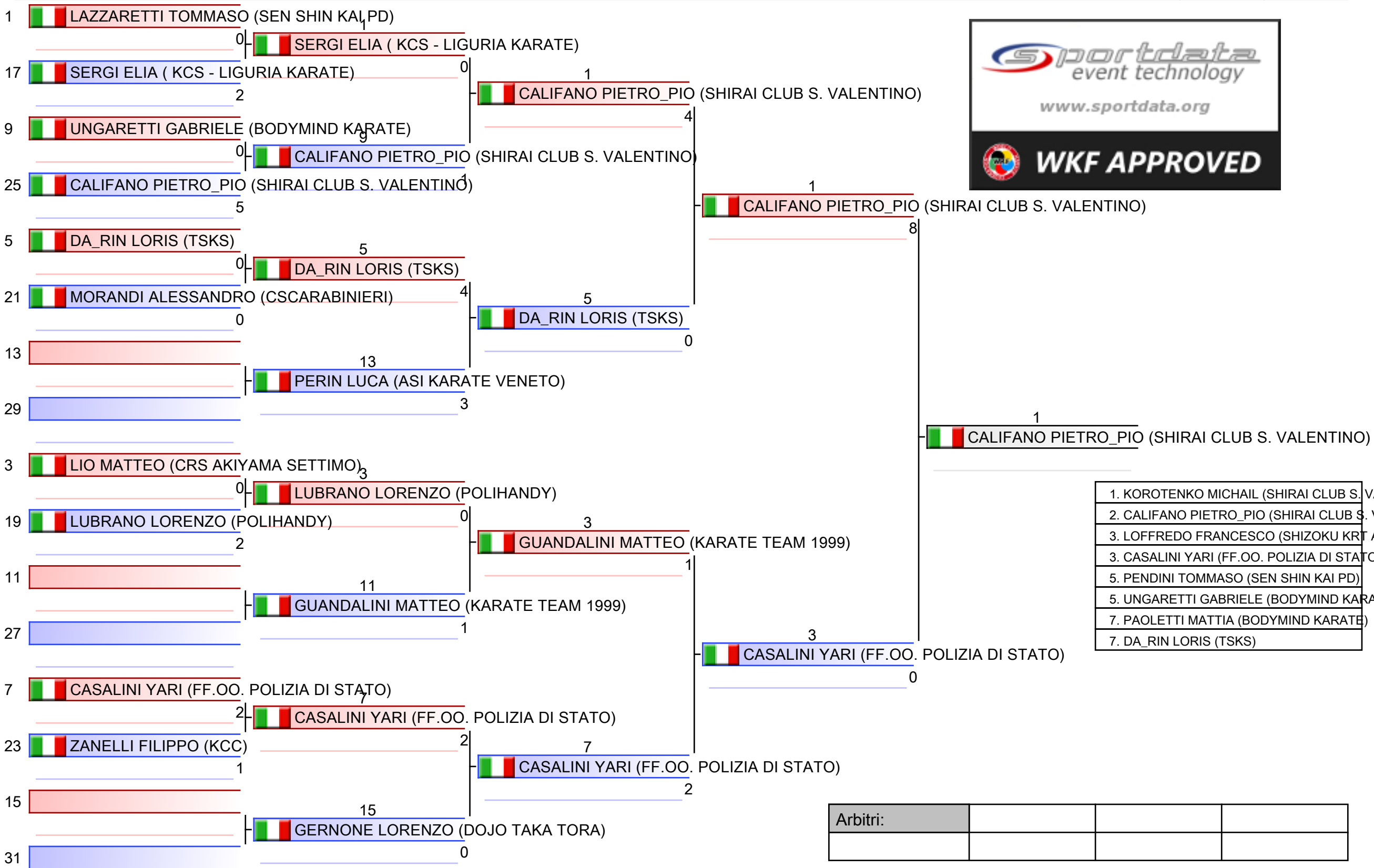

- 1. KOROTENKO MICHAEL (SHIRAI CLUB S. VALENTINO)
- 2. CALIFANO PIETRO_PIO (SHIRAI CLUB S. VALENTINO)
- 3. LOFFREDO FRANCESCO (SHIZOKU KRIT AV)
- 3. CASALINI YARI (FF.OO. POLIZIA DI STATO)
- 5. PENDINI TOMMASO (SEN SHIN KAI PD)
- 5. UNGARETTI GABRIELE (BODYMIND KARATE)
- 7. PAOLETTI MATTIA (BODYMIND KARATE)
- 7. DA_RIN LORIS (TSKS)

Arbitri:			

Kumite Individual male Juniors -68

VENETO OPEN, Via S. Marco, 53, 35129 Padova PD, ITA

2023-05-20

Tatami
4 15:30

Tabelloni - Pool
2/2

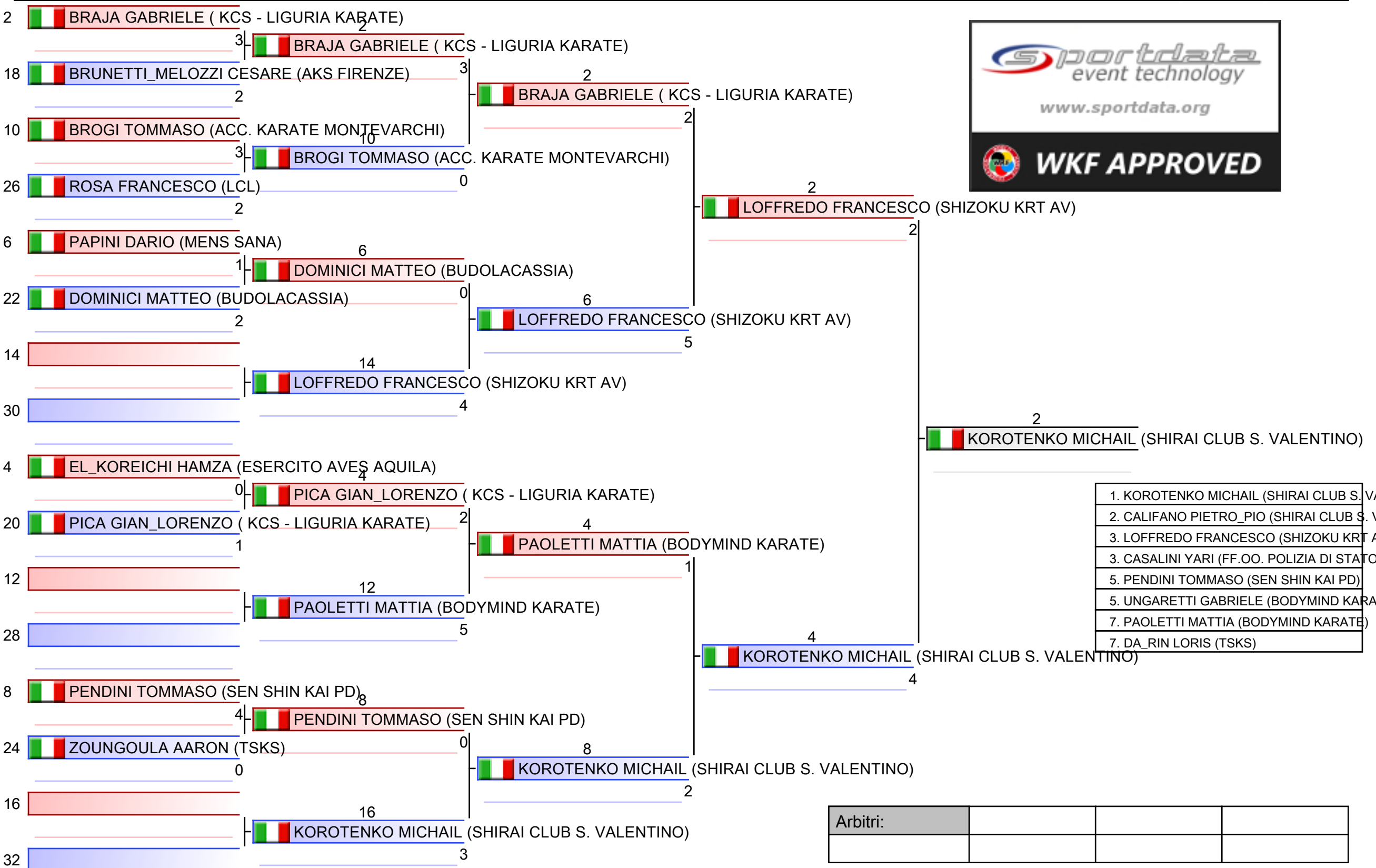

- 1. KOROTENKO MICHAÏL (SHIRAI CLUB S. VALENTINO)
- 2. CALIFANO PIETRO_PIO (SHIRAI CLUB S. VALENTINO)
- 3. LOFFREDO FRANCESCO (SHIZOKU KRT AV)
- 3. CASALINI YARI (FF.OO. POLIZIA DI STATO)
- 5. PENDINI TOMMASO (SEN SHIN KAI PD)
- 5. UNGARETTI GABRIELE (BODYMIND KARATE)
- 7. PAOLETTI MATTIA (BODYMIND KARATE)
- 7. DA_RIN LORIS (TSKS)

Arbitri:			

Vincitore di pool-Kumite Individual male Juniors -68

VENETO OPEN, Via S. Marco, 53, 35129 Padova PD, ITA

Tatami

Tabelloni - Pool

1/1

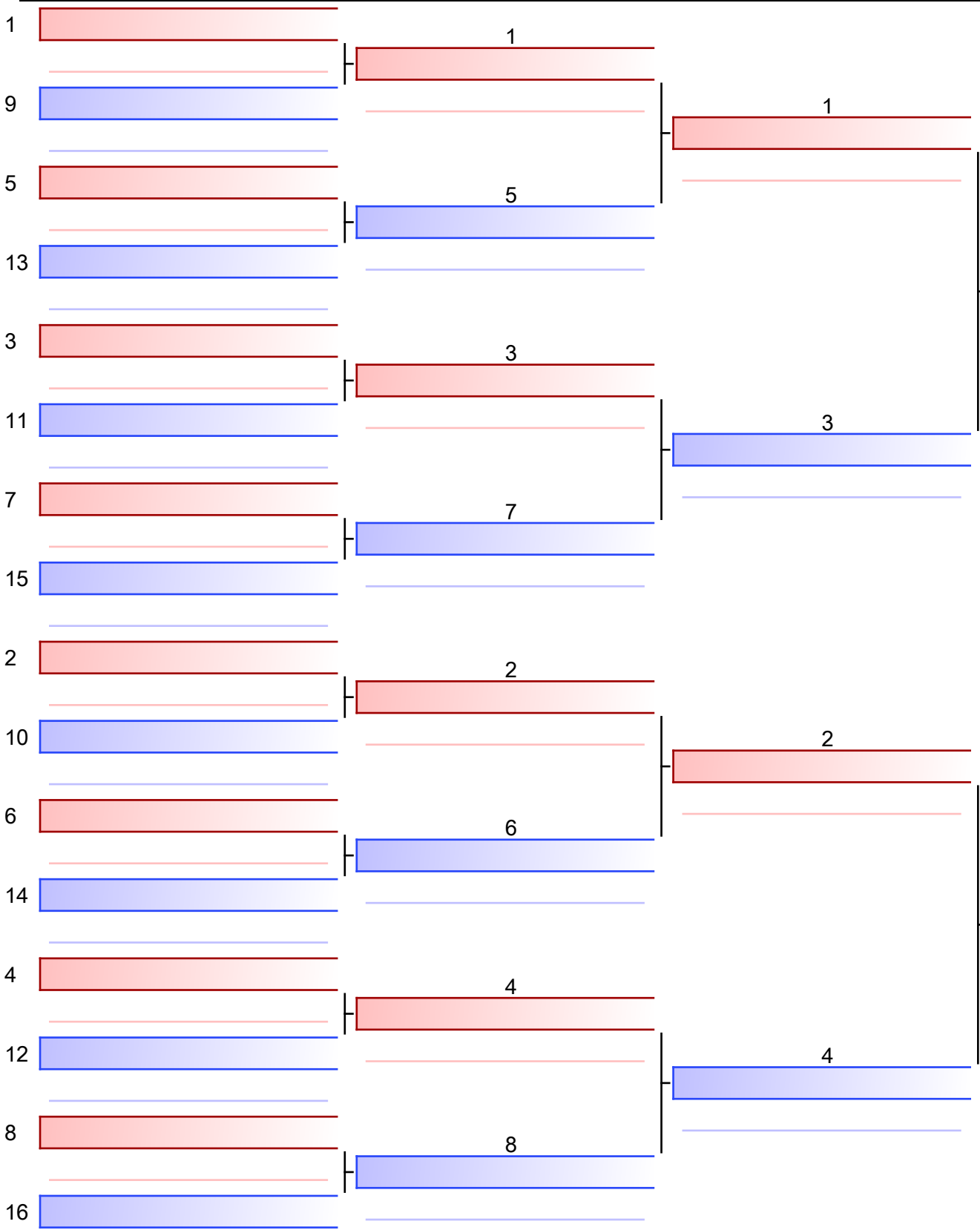

Finale

1
 CALIFANO PIETRO_PIO (SHIRAI CLUB S. VALENTINO)

0

KOROTENKO MICHAIL (SHIRAI CLUB S. VALENTINO)

2
 KOROTENKO MICHAIL (SHIRAI CLUB S. VALENTINO)

1

- | |
|---------------------------------------------------|
| 1. KOROTENKO MICHAIL (SHIRAI CLUB S. VALENTINO) |
| 2. CALIFANO PIETRO_PIO (SHIRAI CLUB S. VALENTINO) |
| 3. LOFFREDO FRANCESCO (SHIZOKU KARATE AV) |
| 3. CASALINI YARI (FF.OO. POLIZIA DI STATO) |
| 5. PENDINI TOMMASO (SEN SHIN KAI PD) |
| 5. UNGARETTI GABRIELE (BODYMIND KARATE) |
| 7. PAOLETTI MATTIA (BODYMIND KARATE) |
| 7. DA_RIN LORIS (TSKS) |

Arbitri:			

Kumite Individual male Juniors -68

VENETO OPEN

2023-05-20

Tatami
4 17:40

Tabelloni - Pool
1,2

(c)sportdata GmbH & Co KG 2000-2023 (2023-05-21 20:07) v 10.0.0 build 1 (2023-02-10) Licenza: Fijlkam Karate 2023 (expire 2023-12-31)

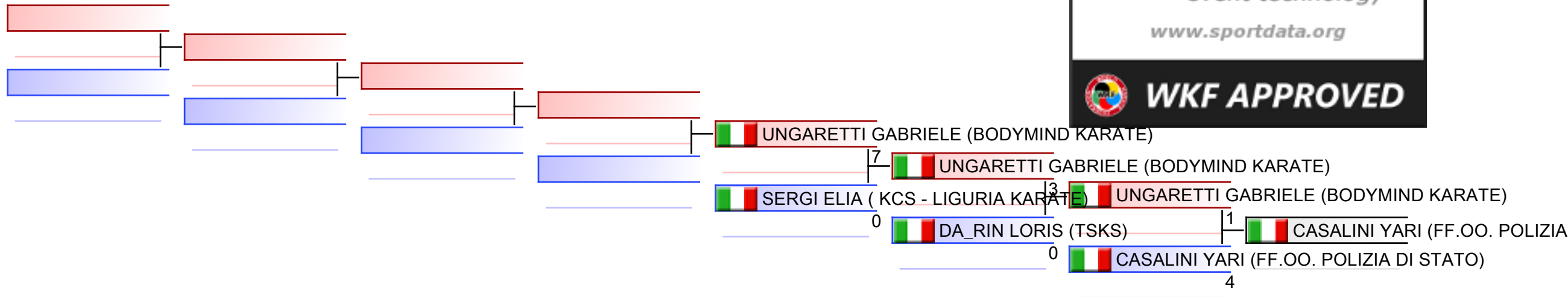

Ripescaggi: (1,2)

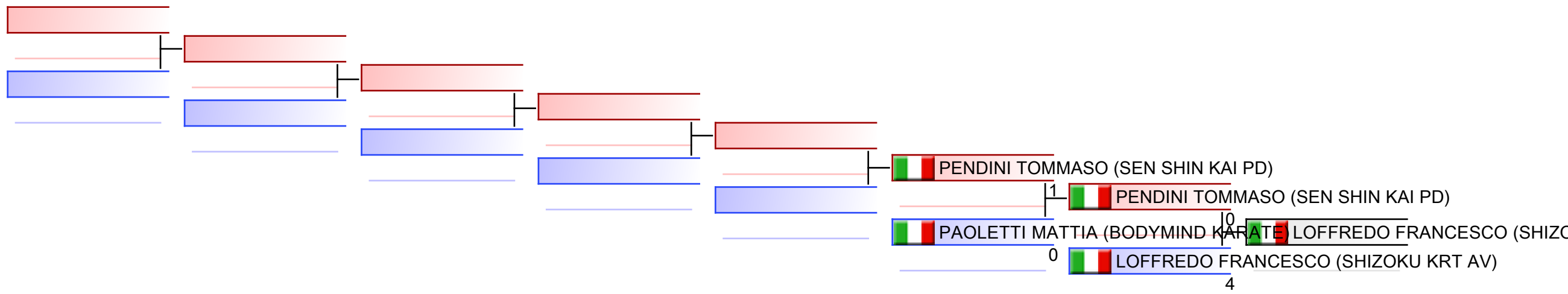

Arbitri:							
----------	--	--	--	--	--	--	--

Kumite Individual male Juniors -76

VENETO OPEN, Via S. Marco, 53, 35129 Padova PD, ITA

2023-05-20

Tatami
6 16:20

Tabelloni - Pool
1/1

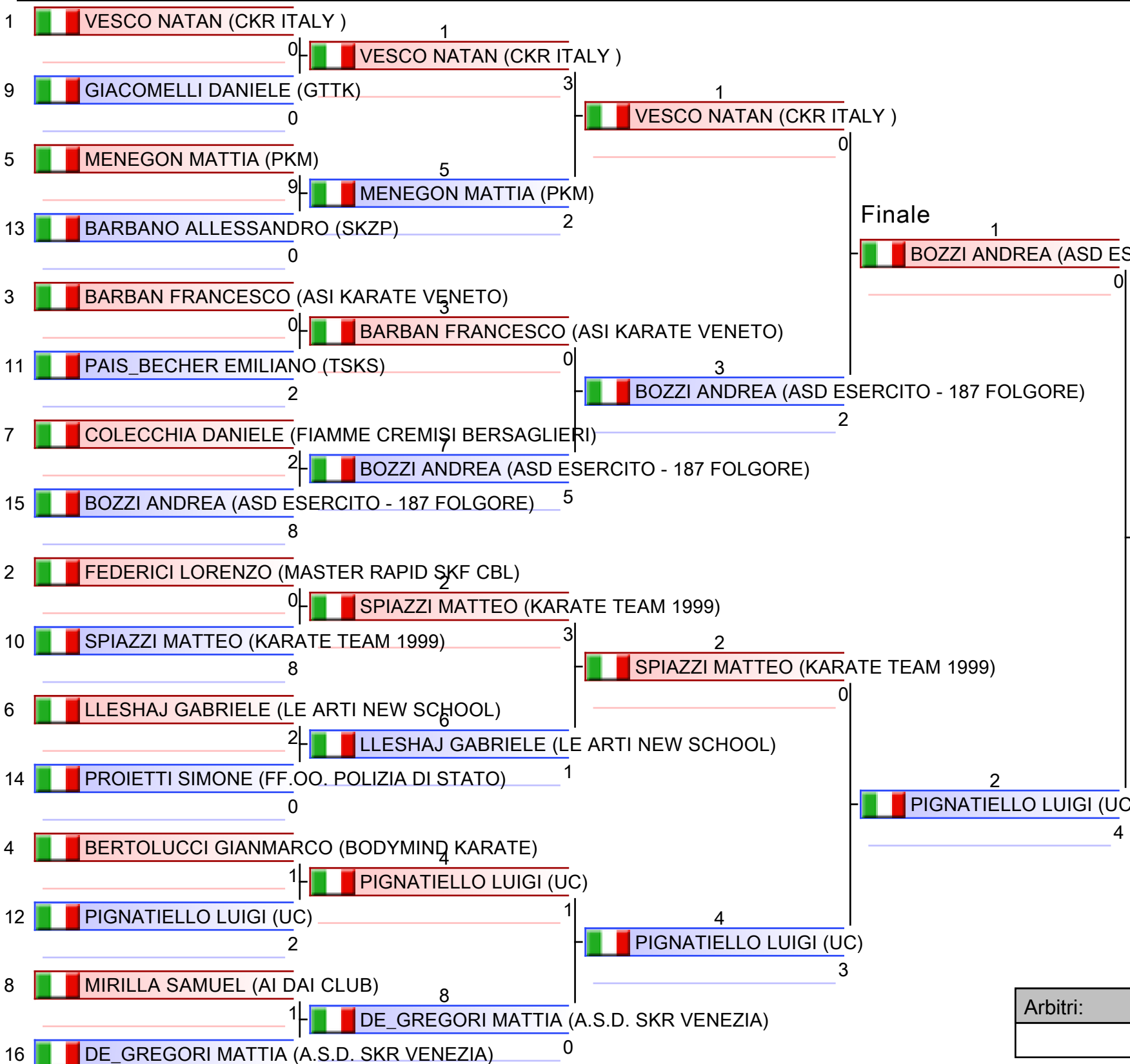

1. PIGNATIELLO LUIGI (UC)
2. BOZZI ANDREA (ASD ESERCITO - 187 FOLGORE)
3. VESCO NATAN (CKR ITALY)
3. SPIAZZI MATTEO (KARATE TEAM 1999)
5. COLECCHIA DANIELE (FIAMME CREMISI BERSAGLIERI)
5. DE_GREGORI MATTIA (A.S.D. SKR VENEZIA)
7. BARBAN FRANCESCO (ASI KARATE VENETO)
7. BERTOLUCCI GIANMARCO (BODYMIND KARATE)

Arbitri:			

Kumite Individual male Juniors -76

VENETO OPEN

2023-05-20

Tatami
6 17:55

Tabelloni - Pool
1

(c)sportdata GmbH & Co KG 2000-2023 (2023-05-21 20:07) v 10.0.0 build 1 (2023-02-10) Licenza: Fijlkam Karate 2023 (expire 2023-12-31)

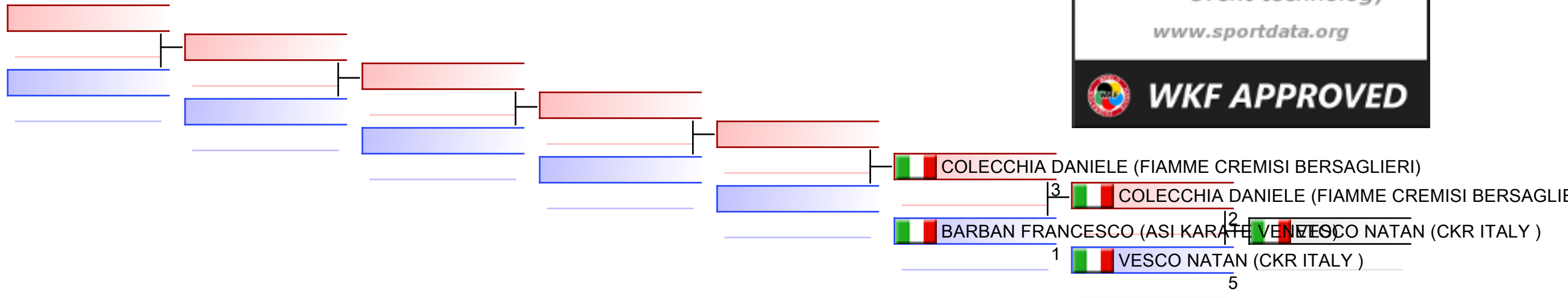

Ripescaggi: (1)

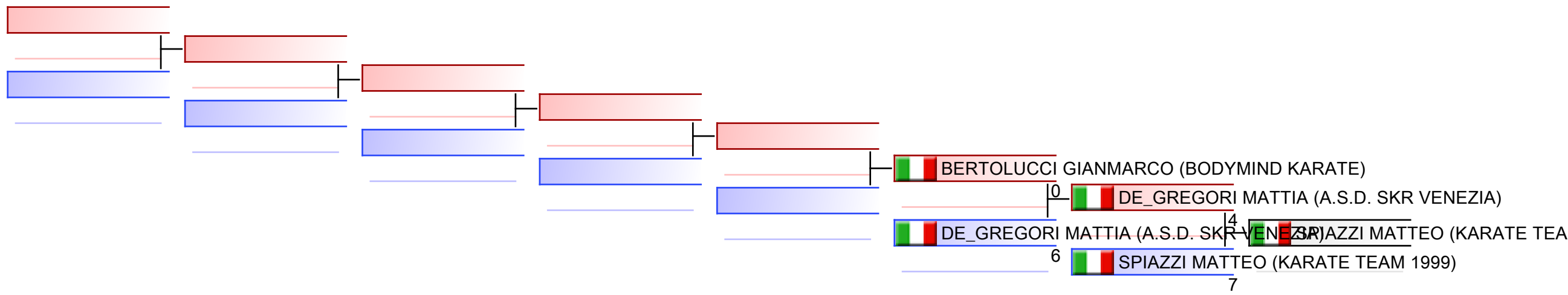

Arbitri:							
----------	--	--	--	--	--	--	--

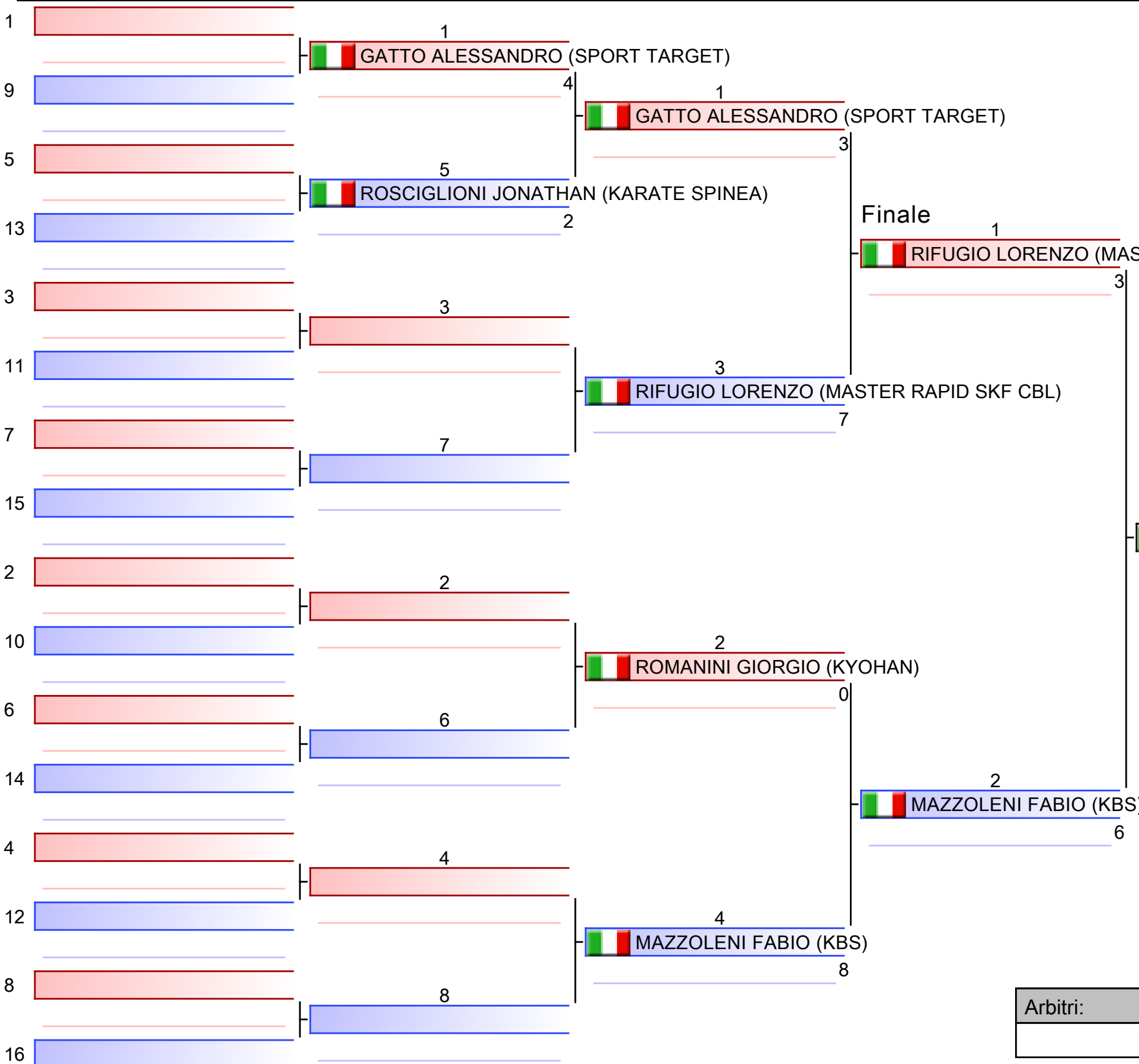

1. MAZZOLENI FABIO (KBS)
2. RIFUGIO LORENZO (MASTER RAPID SKF CBL)
3. GATTO ALESSANDRO (SPORT TARGET)
3. ROMANINI GIORGIO (KYOHAN)

Arbitri:			

Kumite Individual male Seniors +84

VENETO OPEN

2023-05-19

Tatami
3 18:30

Tabelloni - Pool
1

(c)sportdata GmbH & Co KG 2000-2023 (2023-05-21 20:07) v 10.0.0 build 1 (2023-02-10) Licenza: Fijlkam Karate 2023 (expire 2023-12-31)

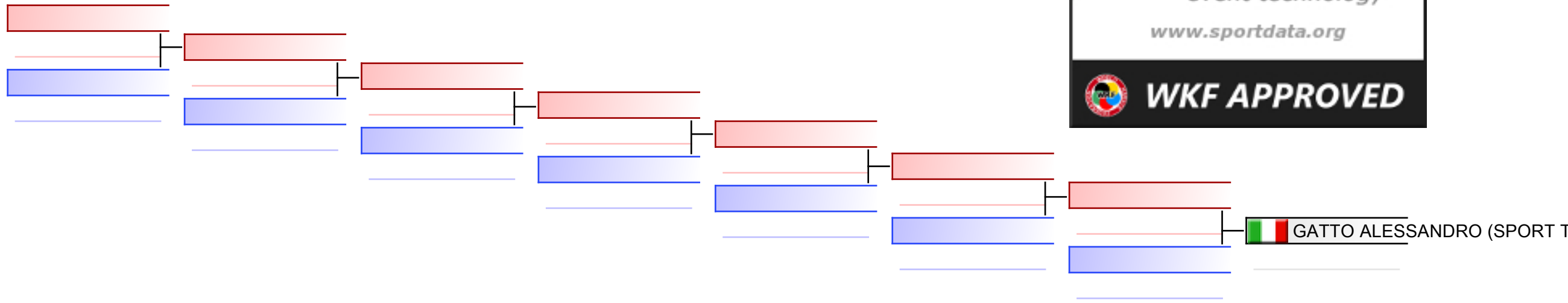

Ripescaggi: (1)

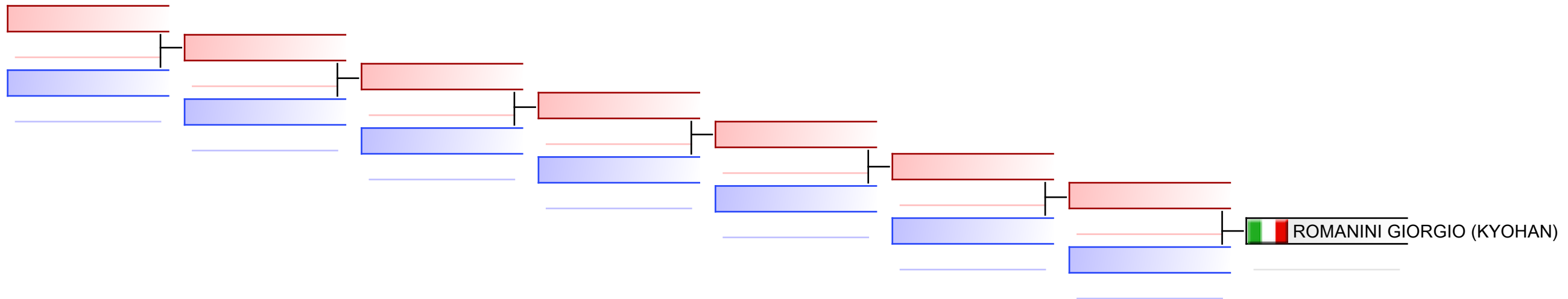

Arbitri:							
----------	--	--	--	--	--	--	--

Kumite Individual male Seniors -60 - Girone all'Italiana (tutti contro tutti)

VENETO OPEN, Via S. Marco, 53, 35129 Padova PD, ITA

2023-05-19

Tatami
2 18:50

Tabelloni - Pool
1/1

- 1  NANOCCHIO GIUSEPPE (TKT)
 - 9  NANOCCHIO GIUSEPPE (TKT)
- 2  PAGOS LORENZO (KARATE SACILE)
 - 1
- 3  LANDI MATTEO (MASTER RAPID SKF CBL)
 - 6  LANDI MATTEO (MASTER RAPID SKF CBL)
- 4  AGLIANO SAMUELE (KARATE POZZUOLO)
 - 0
- 5  LANDI MATTEO (MASTER RAPID SKF CBL)
 - 7  LANDI MATTEO (MASTER RAPID SKF CBL)
- 6  NANOCCHIO GIUSEPPE (TKT)
 - 3
- 7  AGLIANO SAMUELE (KARATE POZZUOLO)
 - 2  AGLIANO SAMUELE (KARATE POZZUOLO)
- 8  PAGOS LORENZO (KARATE SACILE)
 - 0
- 9  NANOCCHIO GIUSEPPE (TKT)
 - 1  NANOCCHIO GIUSEPPE (TKT)
- 10  AGLIANO SAMUELE (KARATE POZZUOLO)
 - 0
- 11  PAGOS LORENZO (KARATE SACILE)
 - 0  LANDI MATTEO (MASTER RAPID SKF CBL)
- 12  LANDI MATTEO (MASTER RAPID SKF CBL)
 - 10



1. LANDI MATTEO (MASTER RAPID SKF CBL)
2. NANOCCHIO GIUSEPPE (TKT)
3. AGLIANO SAMUELE (KARATE POZZUOLO)
4. PAGOS LORENZO (KARATE SACILE)

Arbitri:			

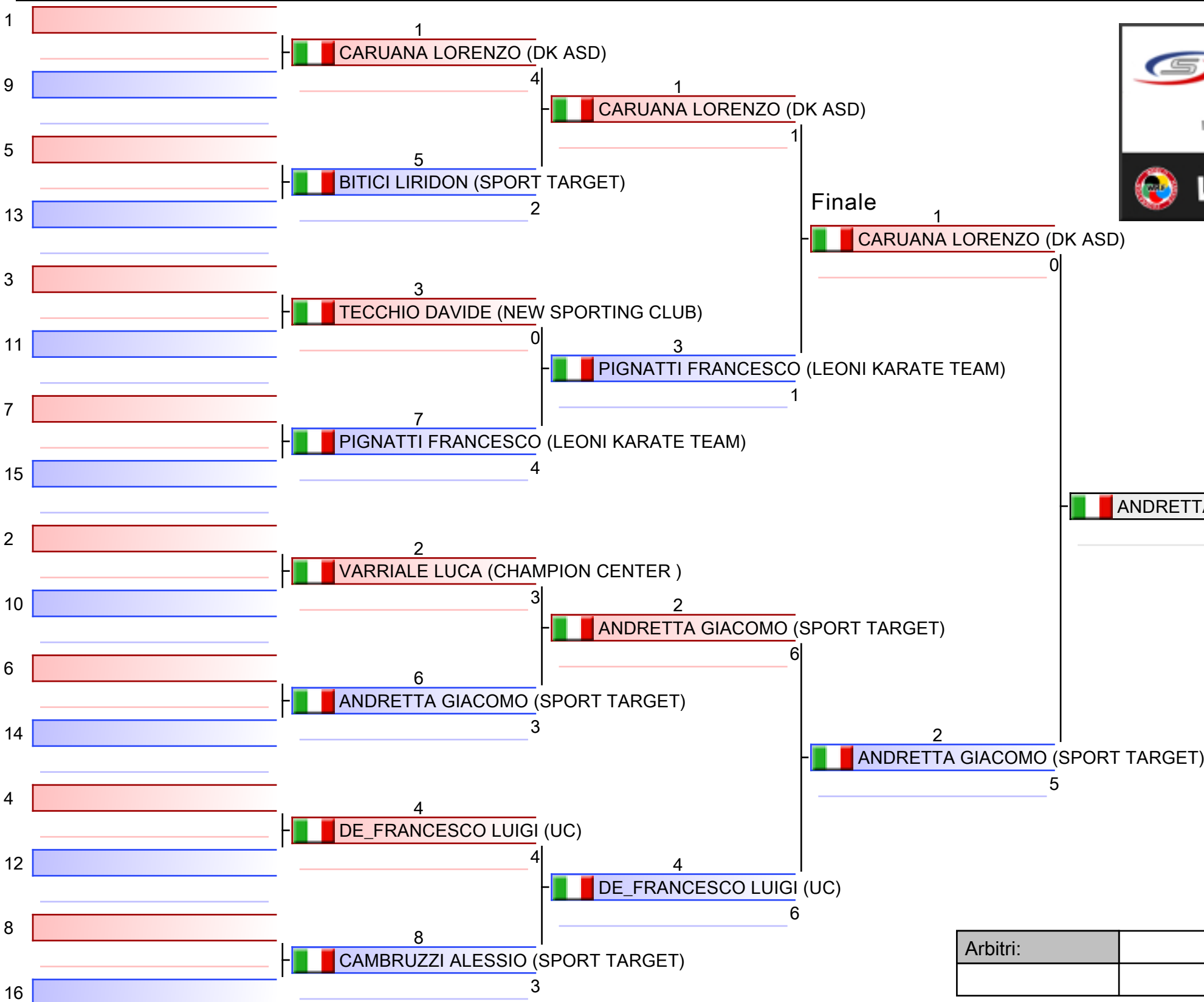

1. ANDRETTA GIACOMO (SPORT TARGET)
2. CARUANA LORENZO (DK ASD)
3. PIGNATTI FRANCESCO (LEONI KARATE TEAM)
3. DE_FRANCESCO LUIGI (UC)
5. BITICI LIRIDON (SPORT TARGET)
5. VARRIALE LUCA (CHAMPION CENTER)

Arbitri:			

Kumite Individual male Seniors -67

VENETO OPEN

2023-05-19

Tatami
5 18:55

Tabelloni - Pool
1

(c)sportdata GmbH & Co KG 2000-2023 (2023-05-21 20:07) v 10.0.0 build 1 (2023-02-10) Licenza: Fijlkam Karate 2023 (expire 2023-12-31)

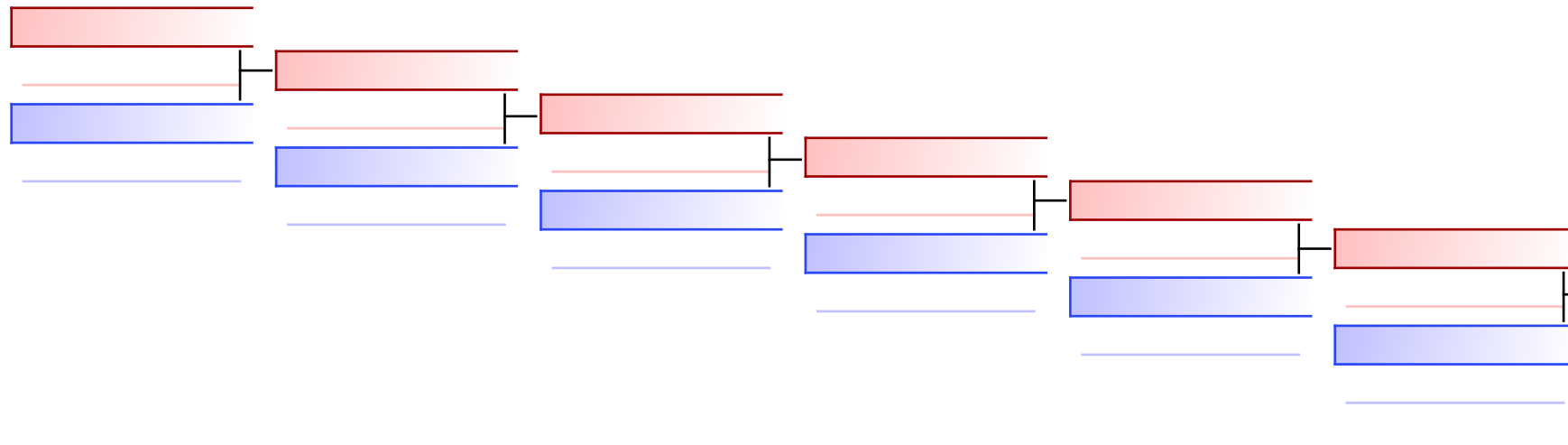

BITICI LIRIDON (SPORT TARGET)
 3
 PIGNATTI FRANCESCO (LEONI KARATE TEAM)
 3

Ripescaggi: (1)

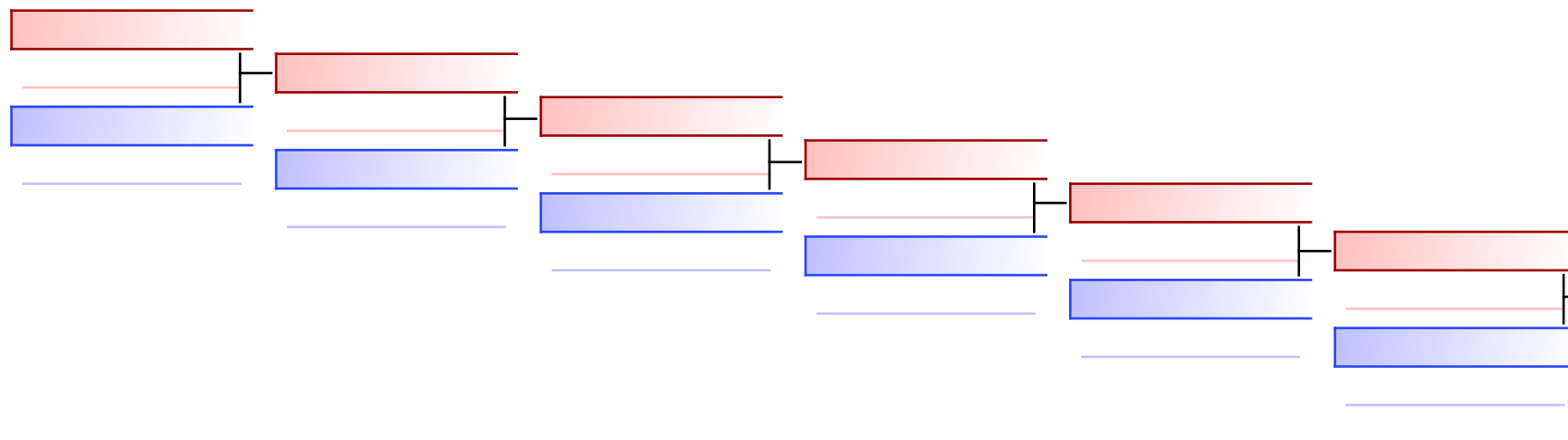

VARRIALE LUCA (CHAMPION CENTER)
 1
 DE_FRANCESCO LUIGI (UC)
 1

Arbitri:							
----------	--	--	--	--	--	--	--

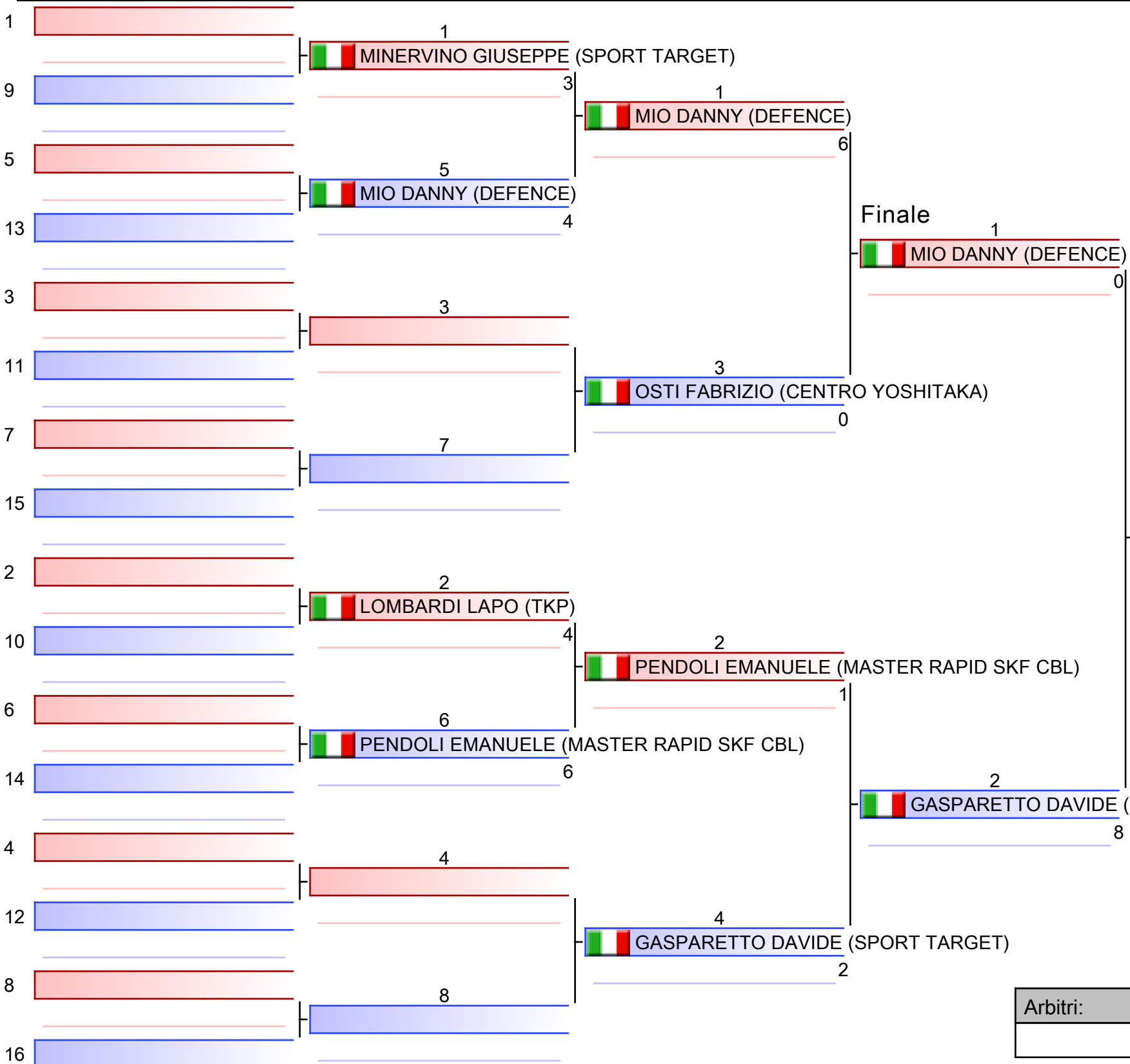

1. GASPARETTO DAVIDE (SPORT TARGET)
2. MIO DANNY (DEFENCE)
3. PENDOLI EMANUELE (MASTER RAPID SKF CBL)
3. MINERVINO GIUSEPPE (SPORT TARGET)
5. OSTI FABRIZIO (CENTRO YOSHITAKA)

Arbitri:			

Kumite Individual male Seniors -75

VENETO OPEN

2023-05-19

Tatami
4 19:05

Tabelloni - Pool
1

(c)sportdata GmbH & Co KG 2000-2023 (2023-05-21 20:07) v 10.0.0 build 1 (2023-02-10) Licenza: Fijlkam Karate 2023 (expire 2023-12-31)

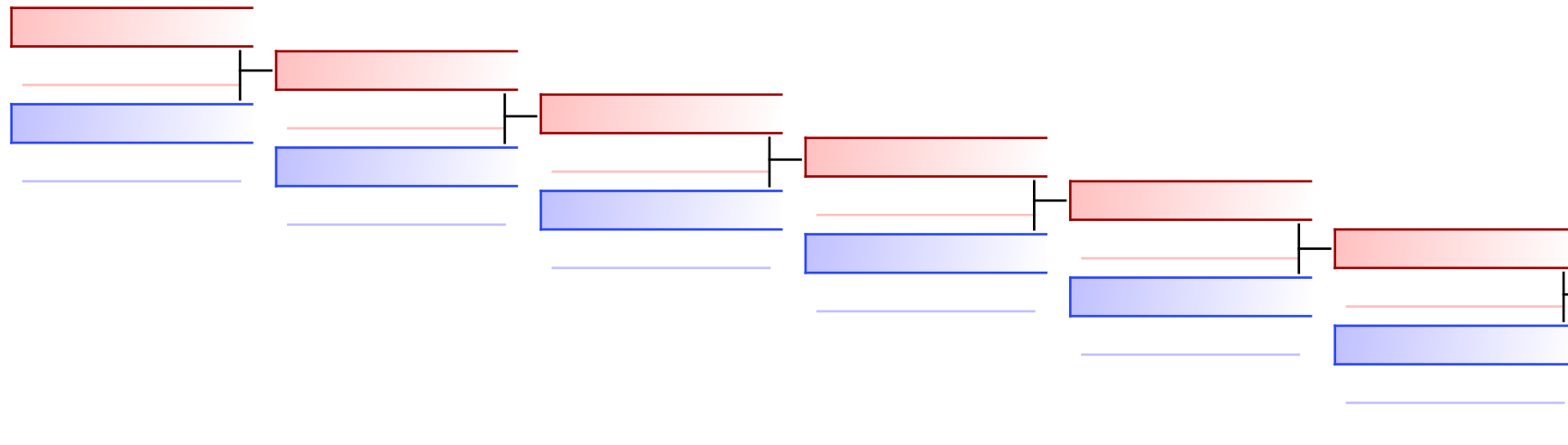

MINERVINO GIUSEPPE (SPORT TARGET)
8
 MINERVINO GIUSEPPE (SPORT TARGET)
 OSTI FABRIZIO (CENTRO YOSHITAKA)
0

Ripescaggi: (1)

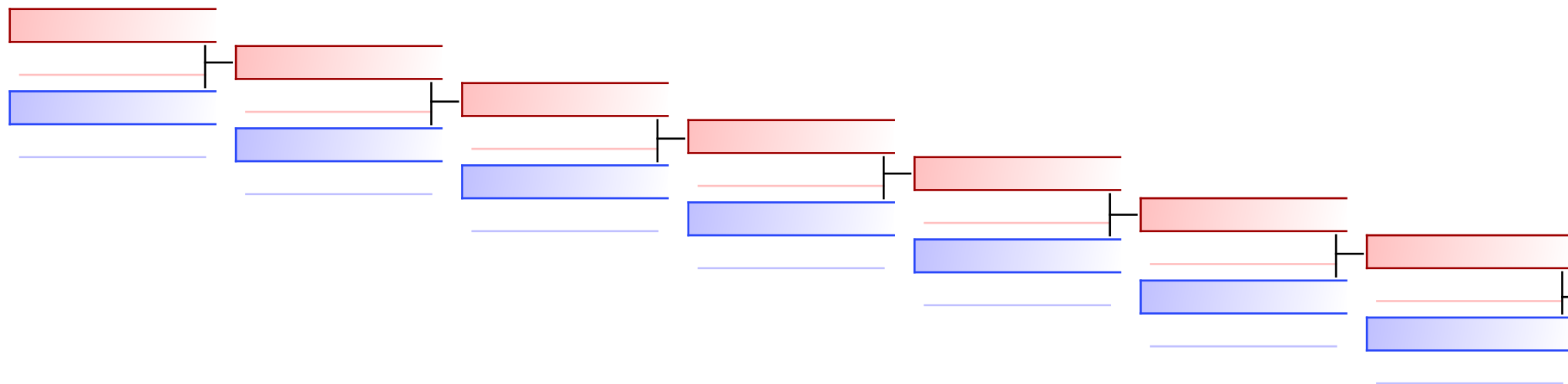

PENDOLI EMANUELE (MASTER)

Arbitri:							
----------	--	--	--	--	--	--	--









Kumite Individual male Seniors -84 - Girone all'Italiana (tutti contro tutti)

VENETO OPEN, Via S. Marco, 53, 35129 Padova PD, ITA

2023-05-19

Tatami
3 18:55

Tabelloni - Pool
1/1

- 1  MILANTA RAFFAELLO (TKP) 8 |  MILANTA RAFFAELLO (TKP)
- 2  PARISI LORENZO (FF.OO. POLIZIA DI STATO) 0
- 3  MORALDI AMUN_ENEA (TKP) 4 |  MORALDI AMUN_ENEA (TKP)
- 4  MILANTA RAFFAELLO (TKP) 0
- 5  PARISI LORENZO (FF.OO. POLIZIA DI STATO) 2 |  PARISI LORENZO (FF.OO. POLIZIA DI STATO)
- 6  MORALDI AMUN_ENEA (TKP) 2



1. MILANTA RAFFAELLO (TKP)
2. MORALDI AMUN_ENEA (TKP)
3. PARISI LORENZO (FF.OO. POLIZIA DI STATO)

Arbitri:			

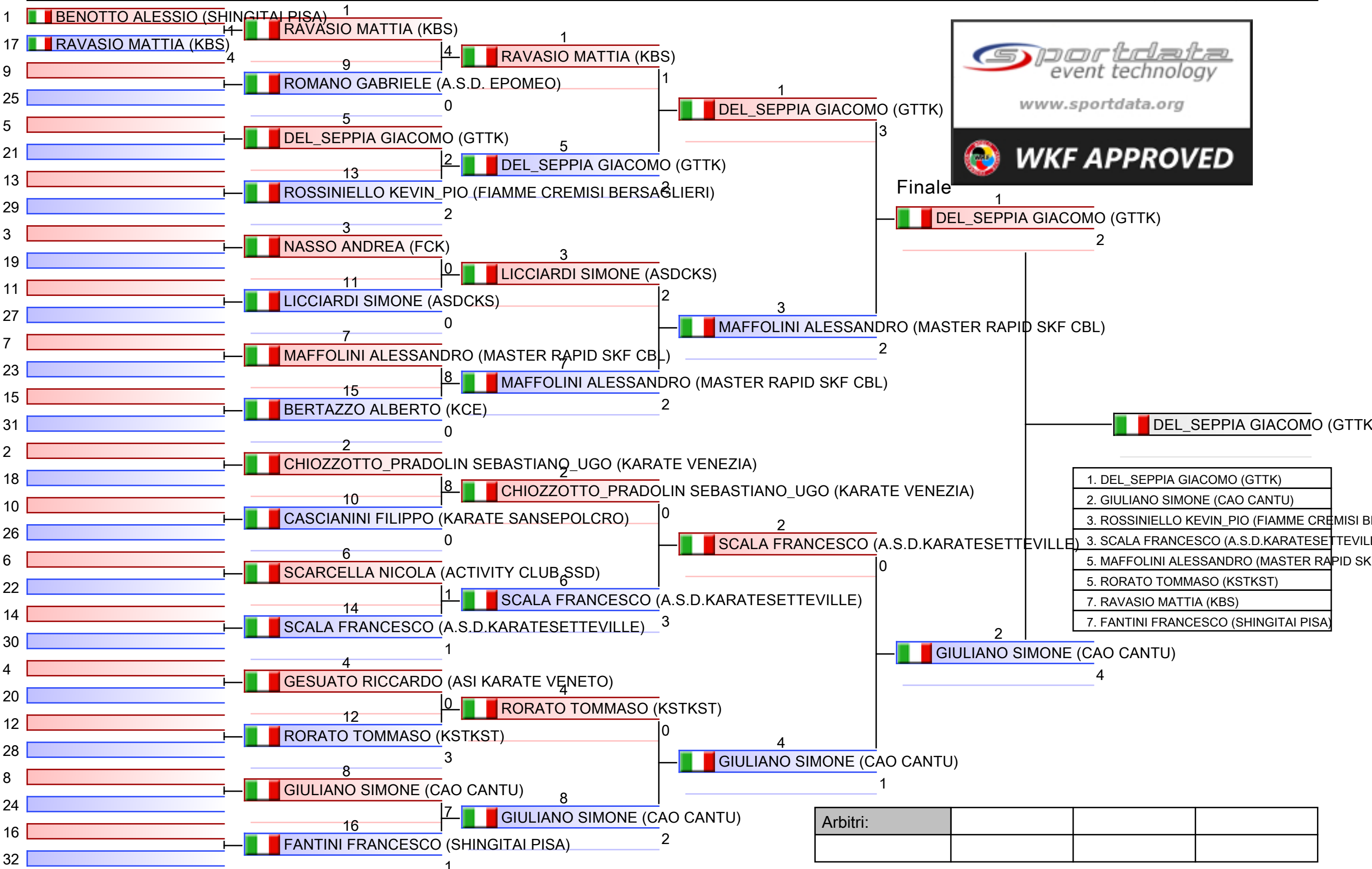

Arbitri:			

Kumite Individual male U14 +55

VENETO OPEN

2023-05-21

Tatami
3 11:15

Tabelloni - Pool
1

(c)sportdata GmbH & Co KG 2000-2023 (2023-05-21 20:07) v 10.0.0 build 1 (2023-02-10) Licenza: Fijlkam Karate 2023 (expire 2023-12-31)

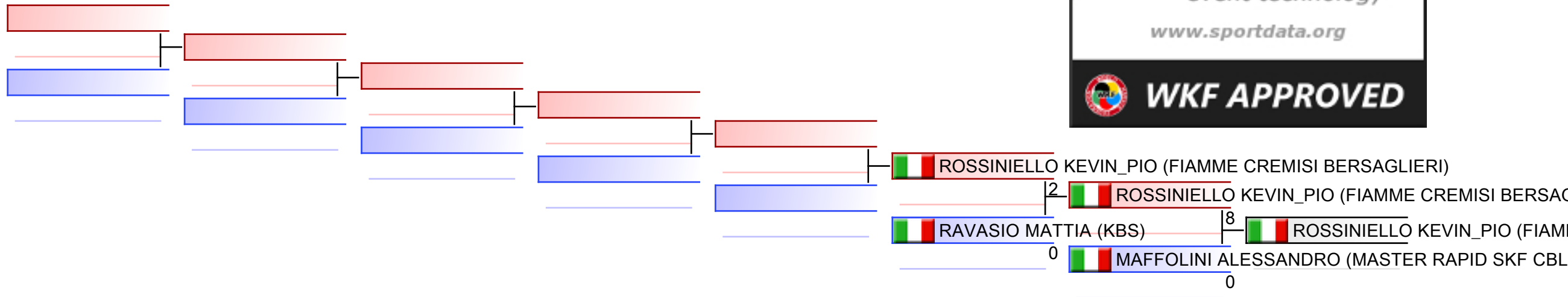

Ripescaggi: (1)

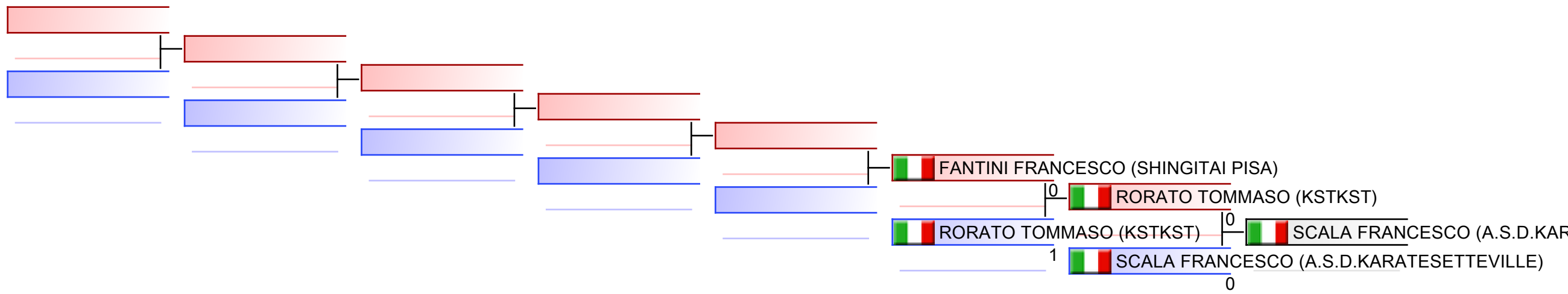

Arbitri:							
----------	--	--	--	--	--	--	--

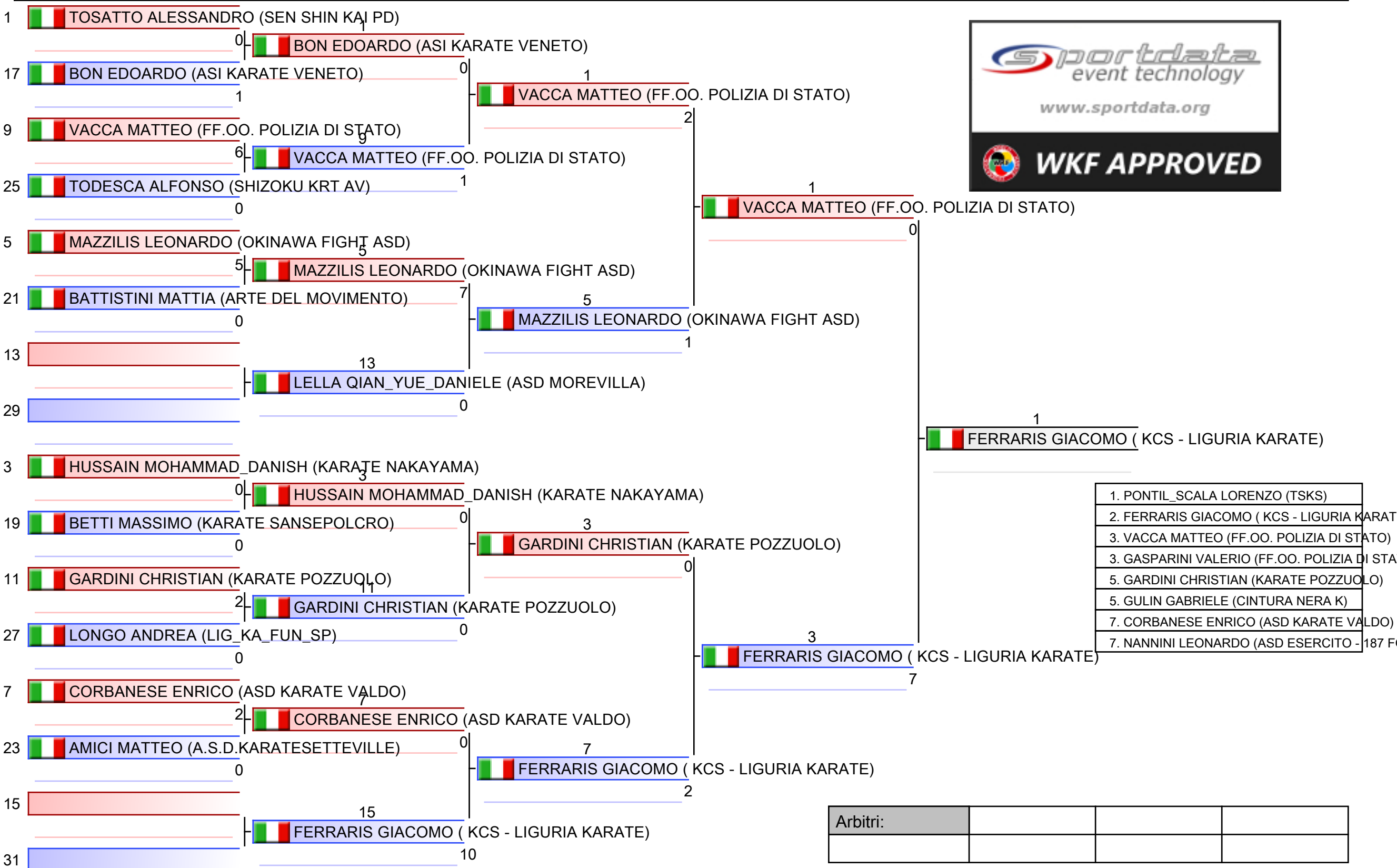

1. PONTIL_SCALA LORENZO (TSKS)
2. FERRARIS GIACOMO (KCS - LIGURIA KARATE)
3. VACCA MATTEO (FF.OO. POLIZIA DI STATO)
3. GASPARINI VALERIO (FF.OO. POLIZIA DI STATO)
5. GARDINI CHRISTIAN (KARATE POZZUOLO)
5. GULIN GABRIELE (CINTURA NERA K)
7. CORBANESE ENRICO (ASD KARATE VALDO)
7. NANNINI LEONARDO (ASD ESERCITO - 187 FO)

Arbitri:			

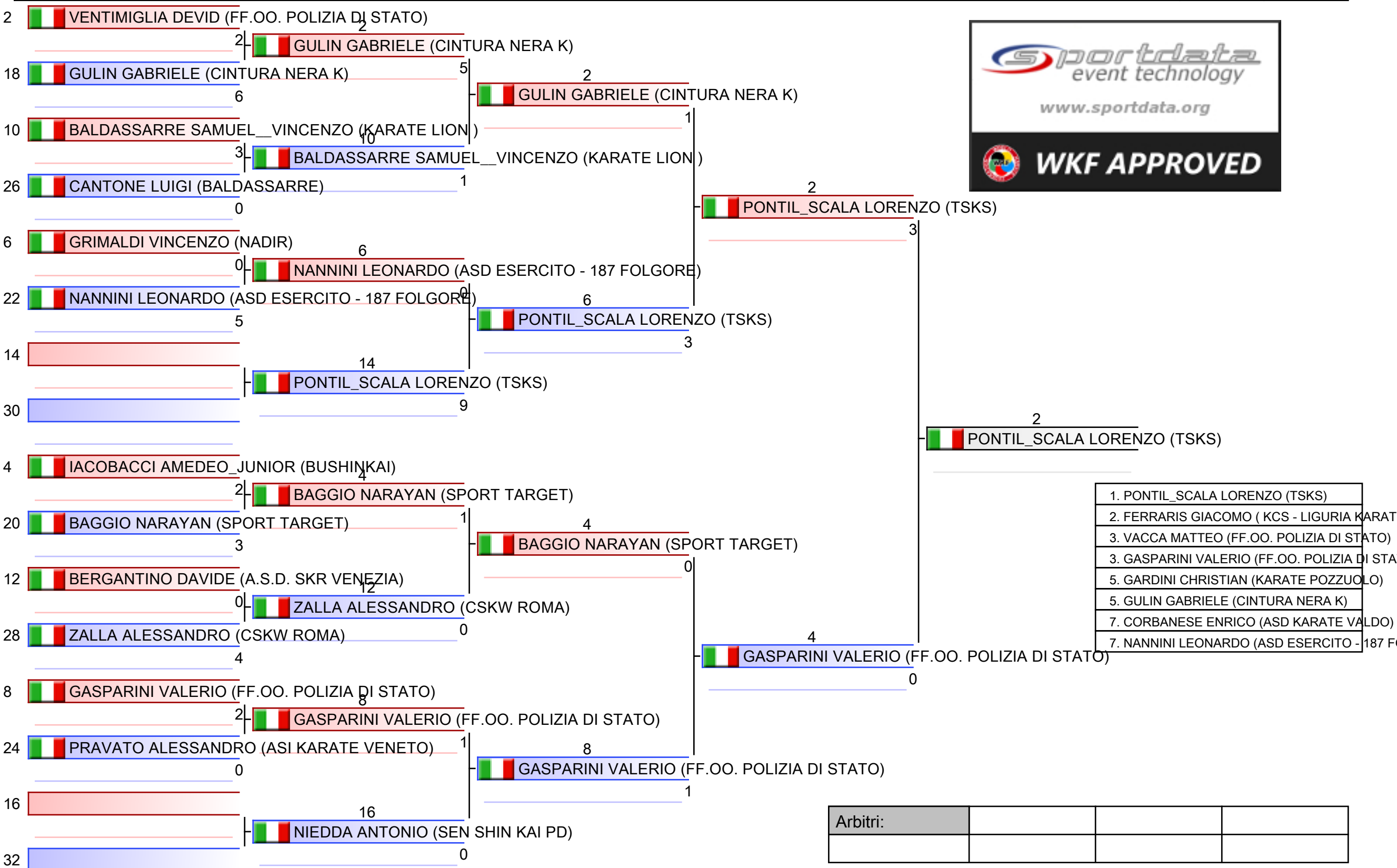

Arbitri:			

Vincitore di pool-Kumite Individual male U14 -40

VENETO OPEN, Via S. Marco, 53, 35129 Padova PD, ITA

Tatami

Tabelloni - Pool

1/1

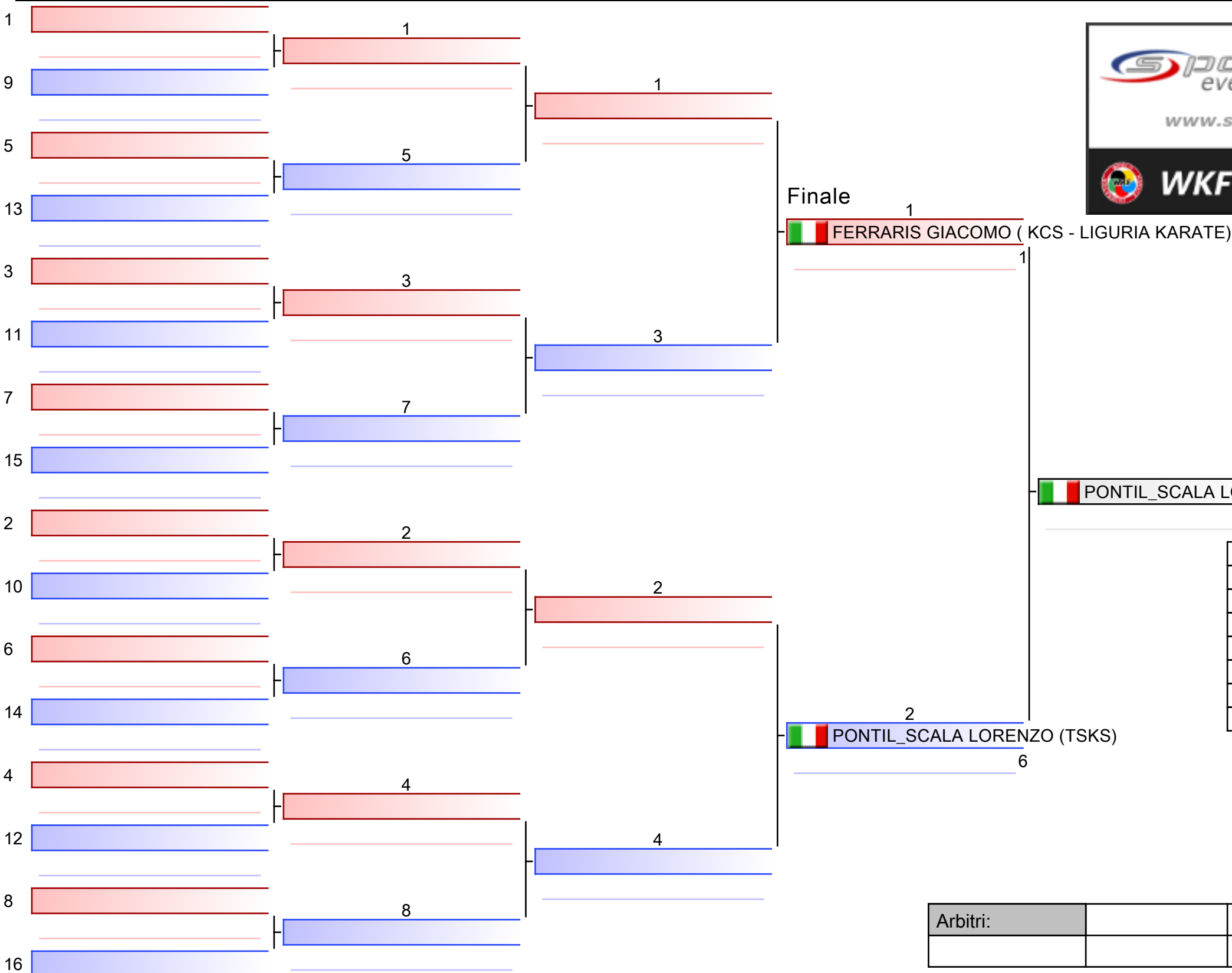

- | |
|------------------------------------------------|
| 1. PONTIL_SCALA LORENZO (TSKS) |
| 2. FERRARIS GIACOMO (KCS - LIGURIA KARATE) |
| 3. VACCA MATTEO (FF.OO. POLIZIA DI STATO) |
| 3. GASPARINI VALERIO (FF.OO. POLIZIA DI STATO) |
| 5. GARDINI CHRISTIAN (KARATE POZZUOLO) |
| 5. GULIN GABRIELE (CINTURA NERA K) |
| 7. CORBANESE ENRICO (ASD KARATE VALDO) |
| 7. NANNINI LEONARDO (ASD ESERCITO - 187 FO) |

Arbitri:			

Kumite Individual male U14 -40

VENETO OPEN

2023-05-21

Tatami
2 11:00

Tabelloni - Pool
1,2

(c)sportdata GmbH & Co KG 2000-2023 (2023-05-21 20:07) v 10.0.0 build 1 (2023-02-10) Licenza: Fijlkam Karate 2023 (expire 2023-12-31)

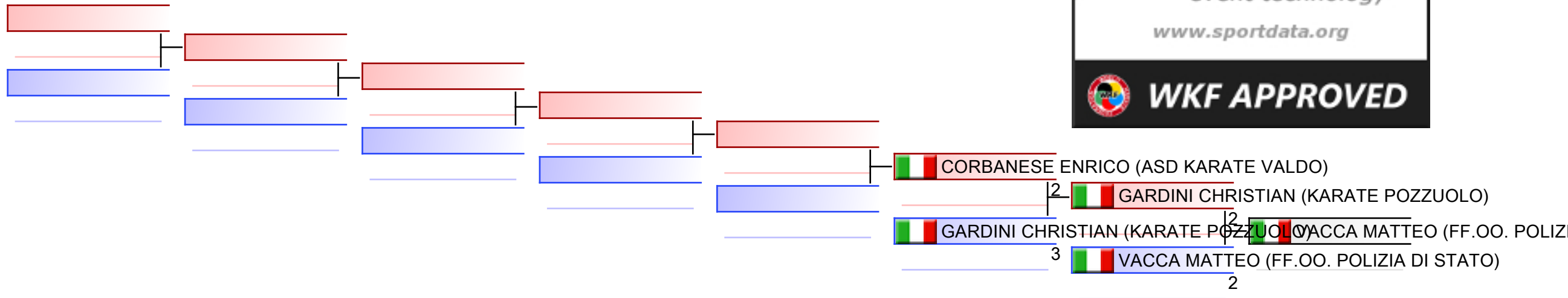

Ripescaggi: (1,2)

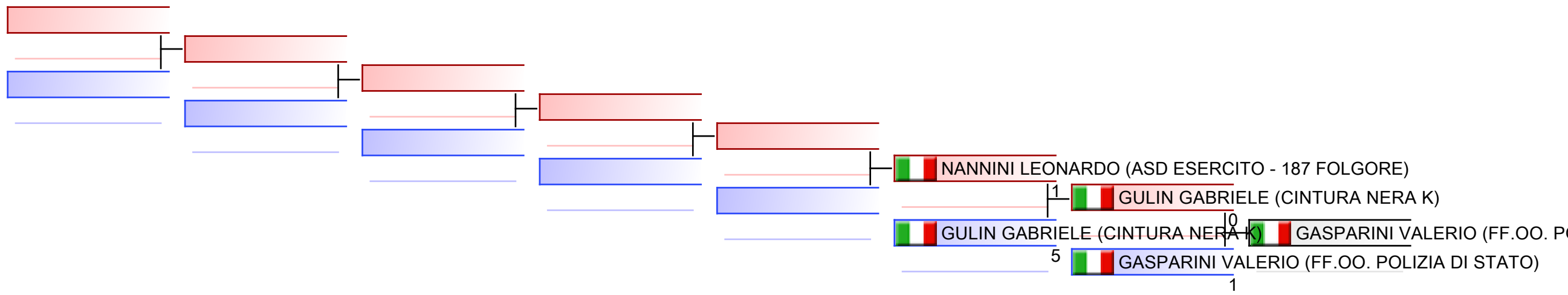

Arbitri:							
----------	--	--	--	--	--	--	--

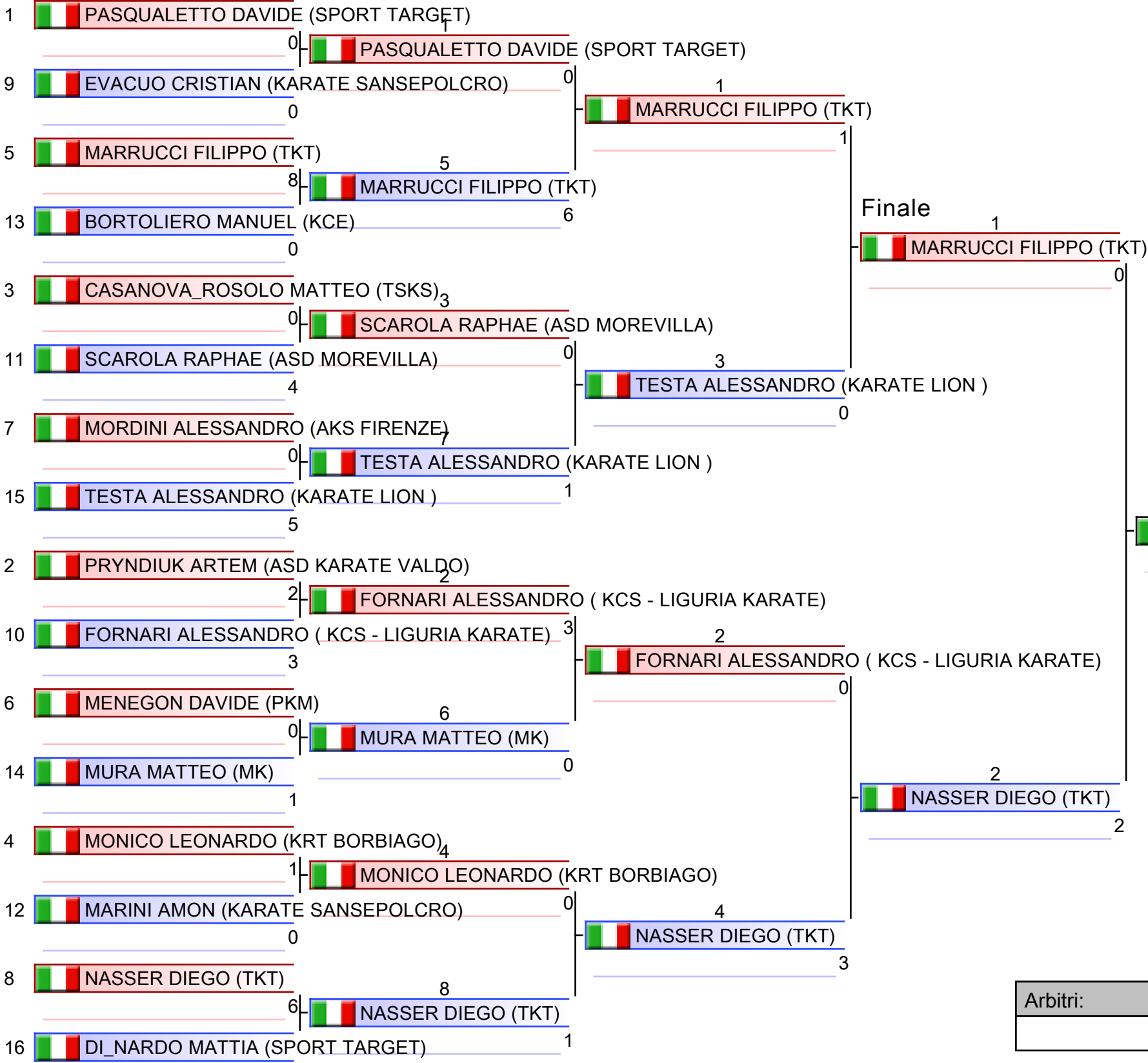

1. NASSER DIEGO (TKT)
2. MARRUCCI FILIPPO (TKT)
3. TESTA ALESSANDRO (KARATE LION)
3. FORNARI ALESSANDRO (KCS - LIGURIA KARATE)
5. PASQUALETTO DAVIDE (SPORT TARGET)
5. DI_NARDO MATTIA (SPORT TARGET)
7. BORTOLIERO MANUEL (KCE)
7. MONICO LEONARDO (KRT BORBIAGO)

Arbitri:			

Kumite Individual male U14 -45

VENETO OPEN

2023-05-21

Tatami
1 11:30

Tabelloni - Pool
1

(c)sportdata GmbH & Co KG 2000-2023 (2023-05-21 20:07) v 10.0.0 build 1 (2023-02-10) Licenza: Fijlkam Karate 2023 (expire 2023-12-31)

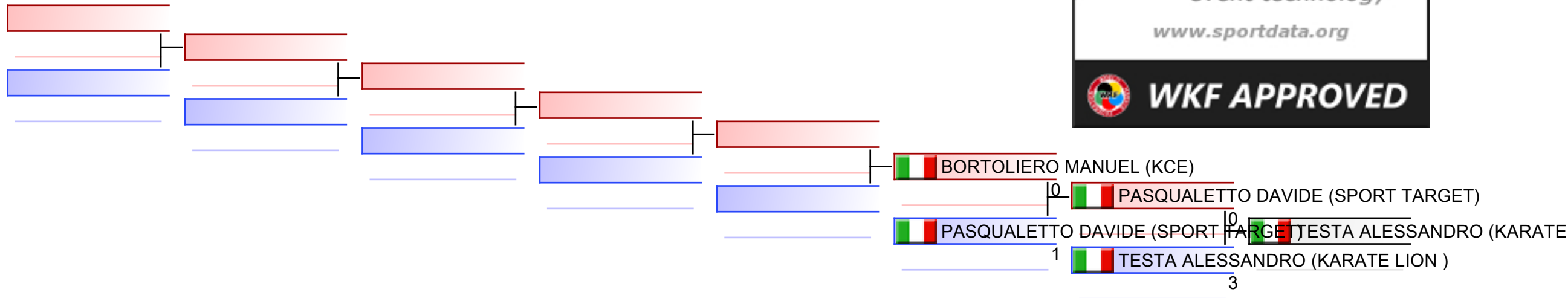

Ripescaggi: (1)

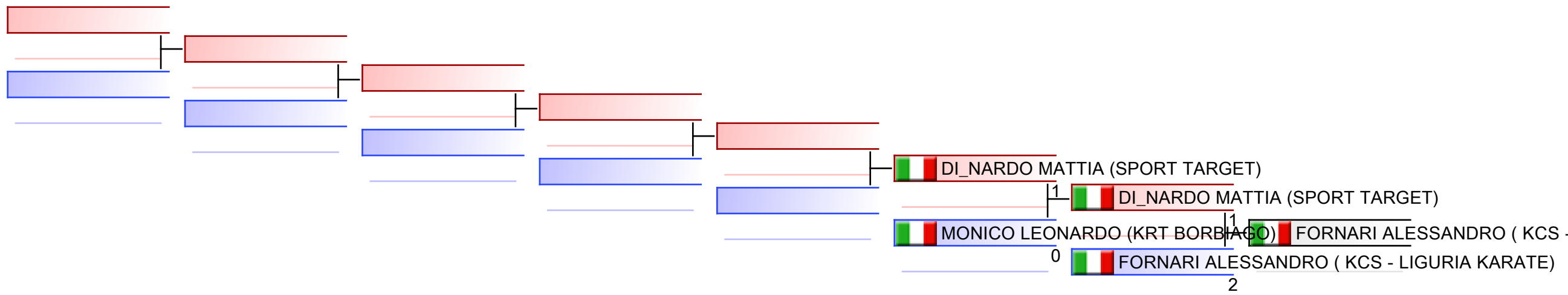

Arbitri:							
----------	--	--	--	--	--	--	--

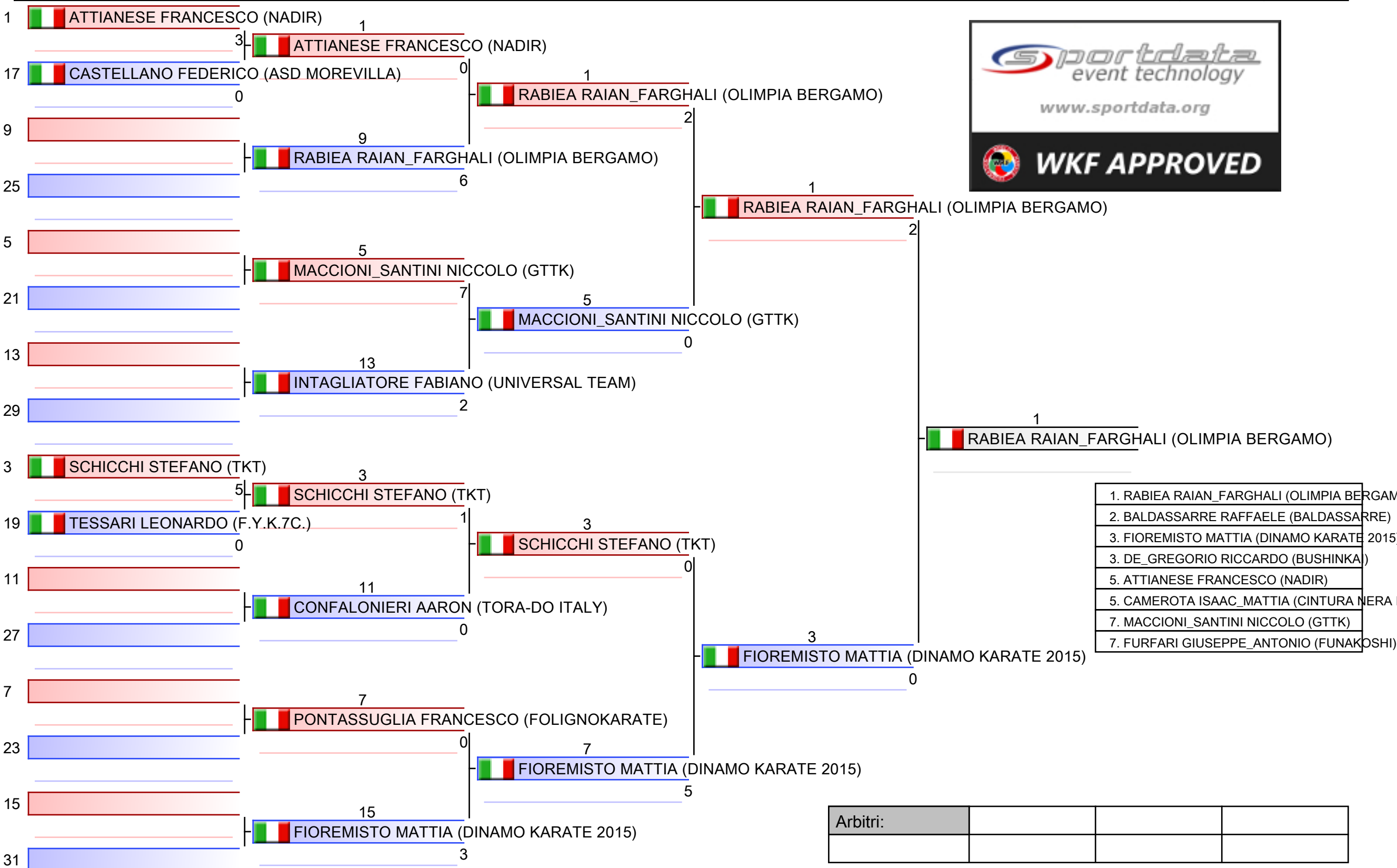

Arbitri:			

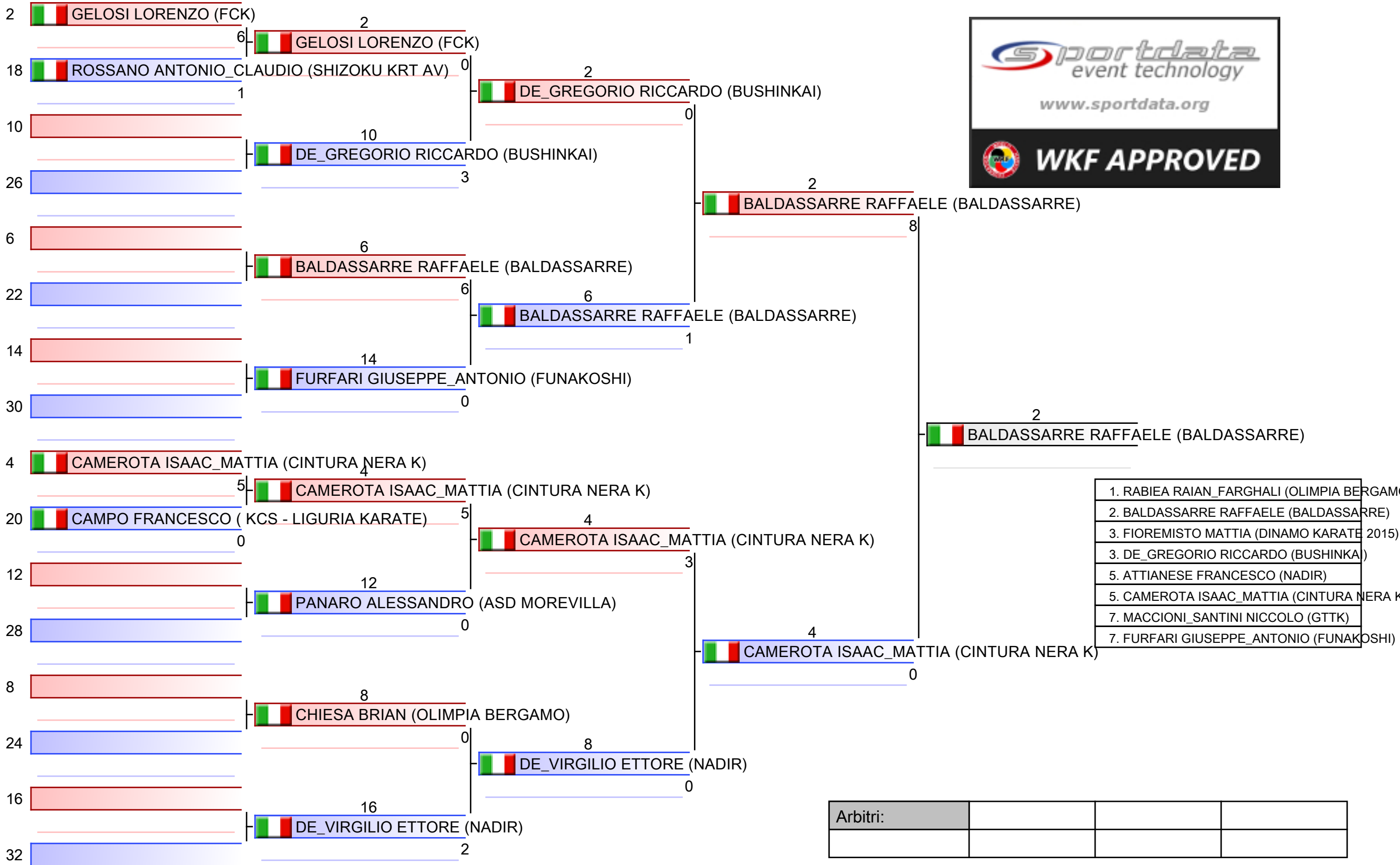

Vincitore di pool-Kumite Individual male U14 -50

VENETO OPEN, Via S. Marco, 53, 35129 Padova PD, ITA

Tatami

Tabelloni - Pool

1/1

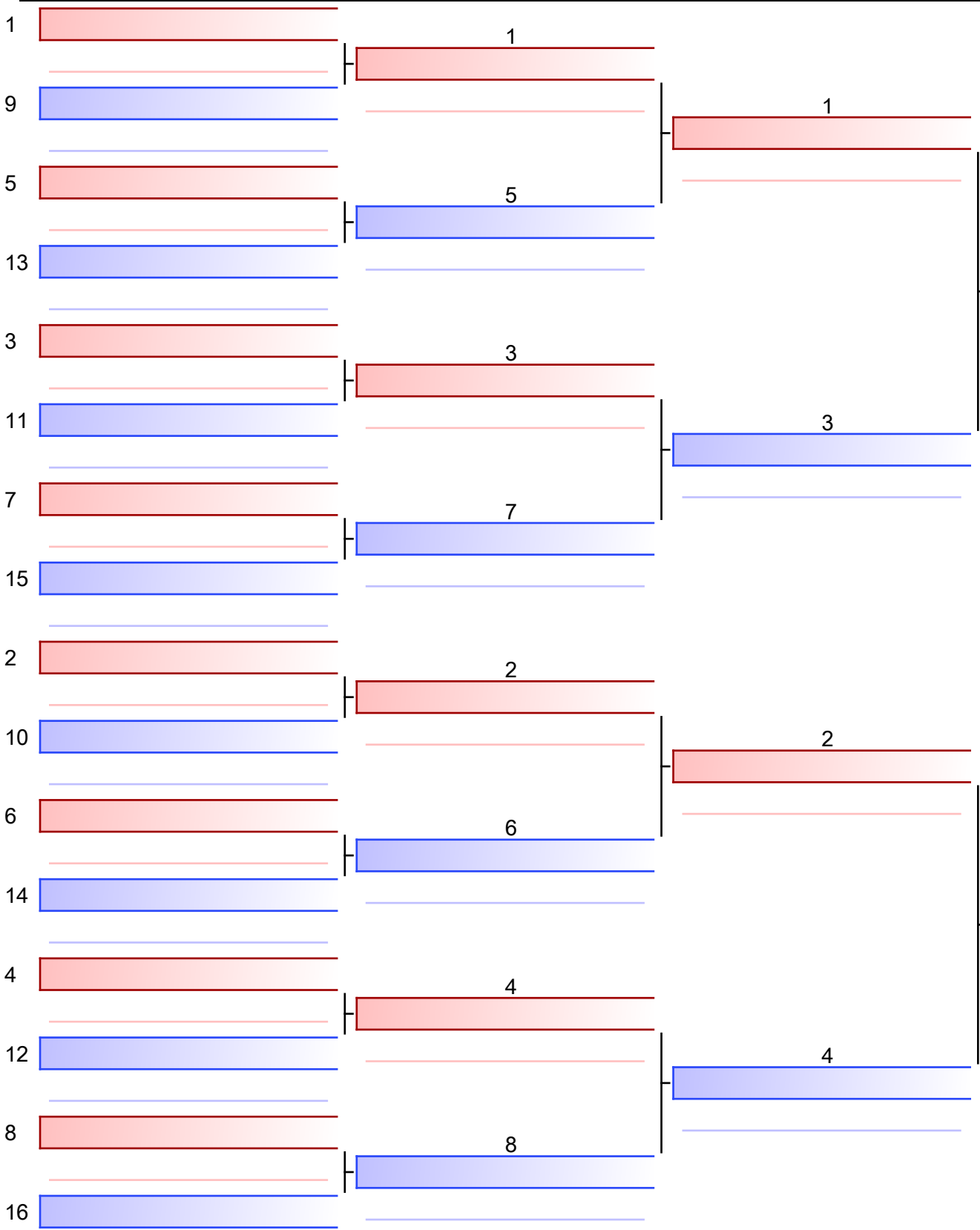

Finale

1 RABIEA RAIAN_FARGHALI (OLIMPIA BERGAMO)

RABIEA RAIAN_FARGHALI (OLIMPIA BERGAMO)

2 BALDASSARRE RAFFAELE (BALDASSARRE)

- | |
|--------------------------------------------|
| 1. RABIEA RAIAN_FARGHALI (OLIMPIA BERGAMO) |
| 2. BALDASSARRE RAFFAELE (BALDASSARRE) |
| 3. FIOREMISTO MATTIA (DINAMO KARATE 2015) |
| 3. DE_GREGORIO RICCARDO (BUSHINKA) |
| 5. ATTIANESE FRANCESCO (NADIR) |
| 5. CAMEROTA ISAAC_MATTIA (CINTURA NERA K) |
| 7. MACCIONI_SANTINI NICCOLO (GTTK) |
| 7. FURFARI GIUSEPPE_ANTONIO (FUNAKOSHI) |

Arbitri:			

Kumite Individual male U14 -50

VENETO OPEN

2023-05-21

Tatami
6 11:15

Tabelloni - Pool
1,2

(c)sportdata GmbH & Co KG 2000-2023 (2023-05-21 20:07) v 10.0.0 build 1 (2023-02-10) Licenza: Fijlkam Karate 2023 (expire 2023-12-31)

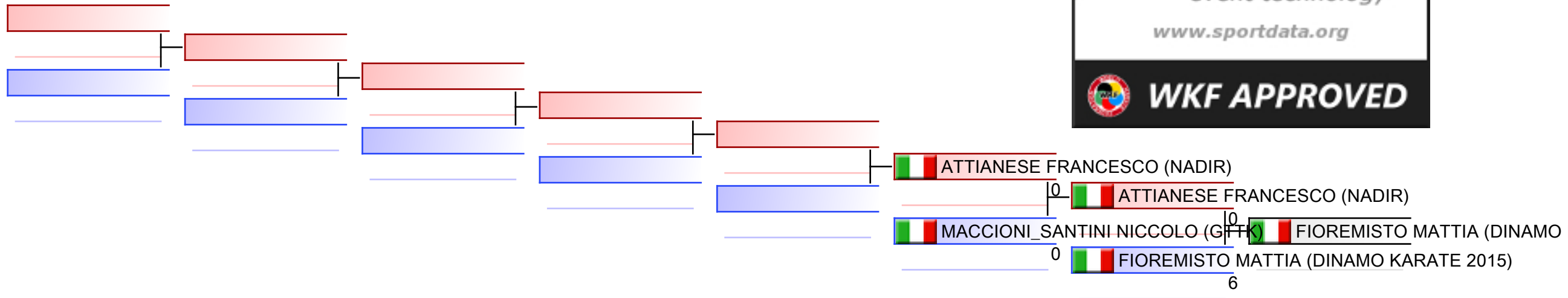

Ripescaggi: (1,2)

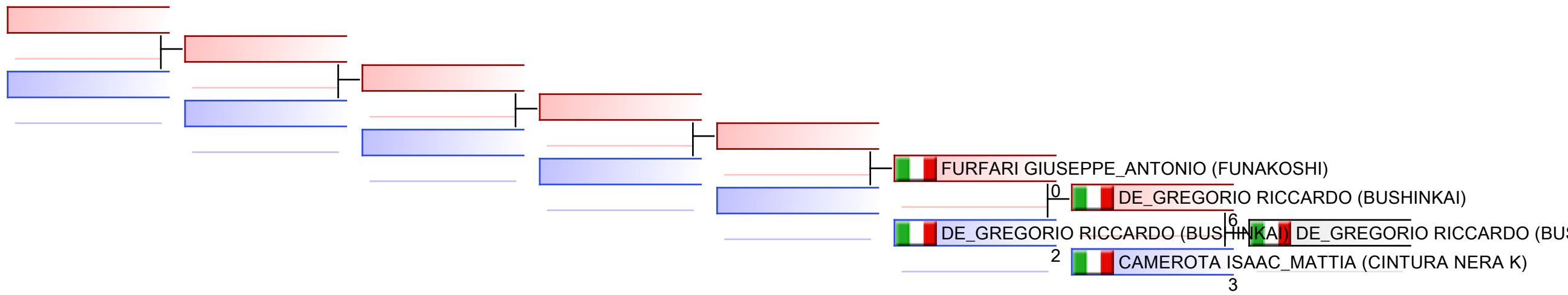

Arbitri:							
----------	--	--	--	--	--	--	--

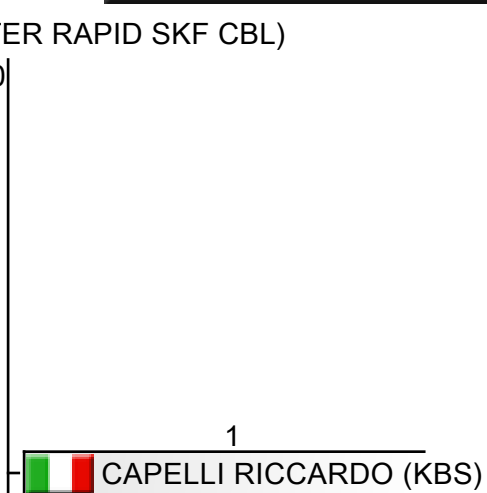
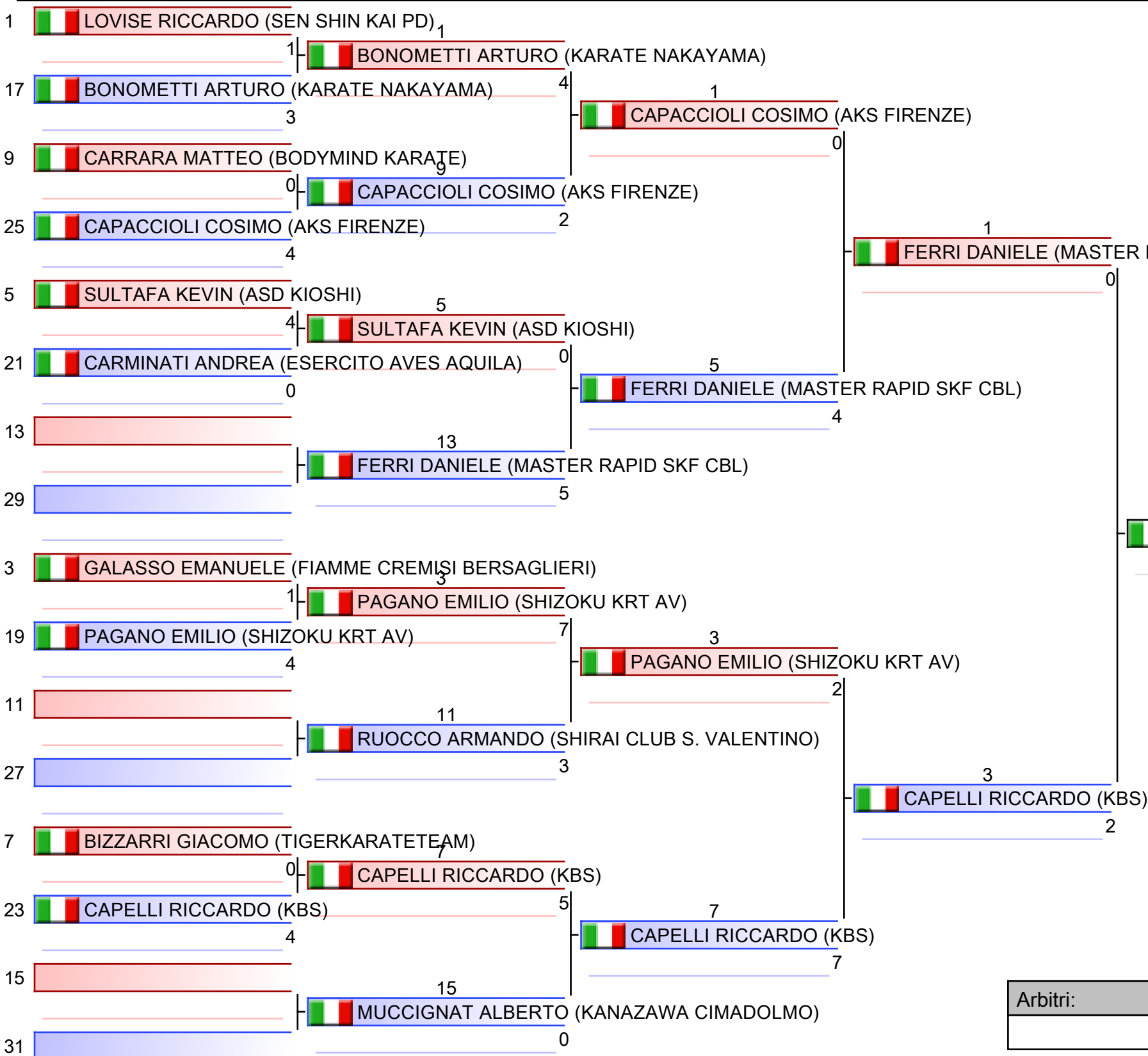

1. CAPELLI RICCARDO (KBS)
2. SCARICO MARIO (UNIVERSAL TEAM)
3. PAGANO EMILIO (SHIZOKU KRT AV)
3. SEGANTINI ANDREA (YOSEIKAN KARATE)
5. FERRI DANIELE (MASTER RAPID SKF CBL)
5. CECCHINI JACOPO (KARATE VENEZIA)
7. BIZZARRI GIACOMO (TIGERKARATETEAM)
7. SERA SIMONE (KTN)

Arbitri:			

Vincitore di pool-Kumite Individual male U14 -55

VENETO OPEN, Via S. Marco, 53, 35129 Padova PD, ITA

Tatami

Tabelloni - Pool

1/1

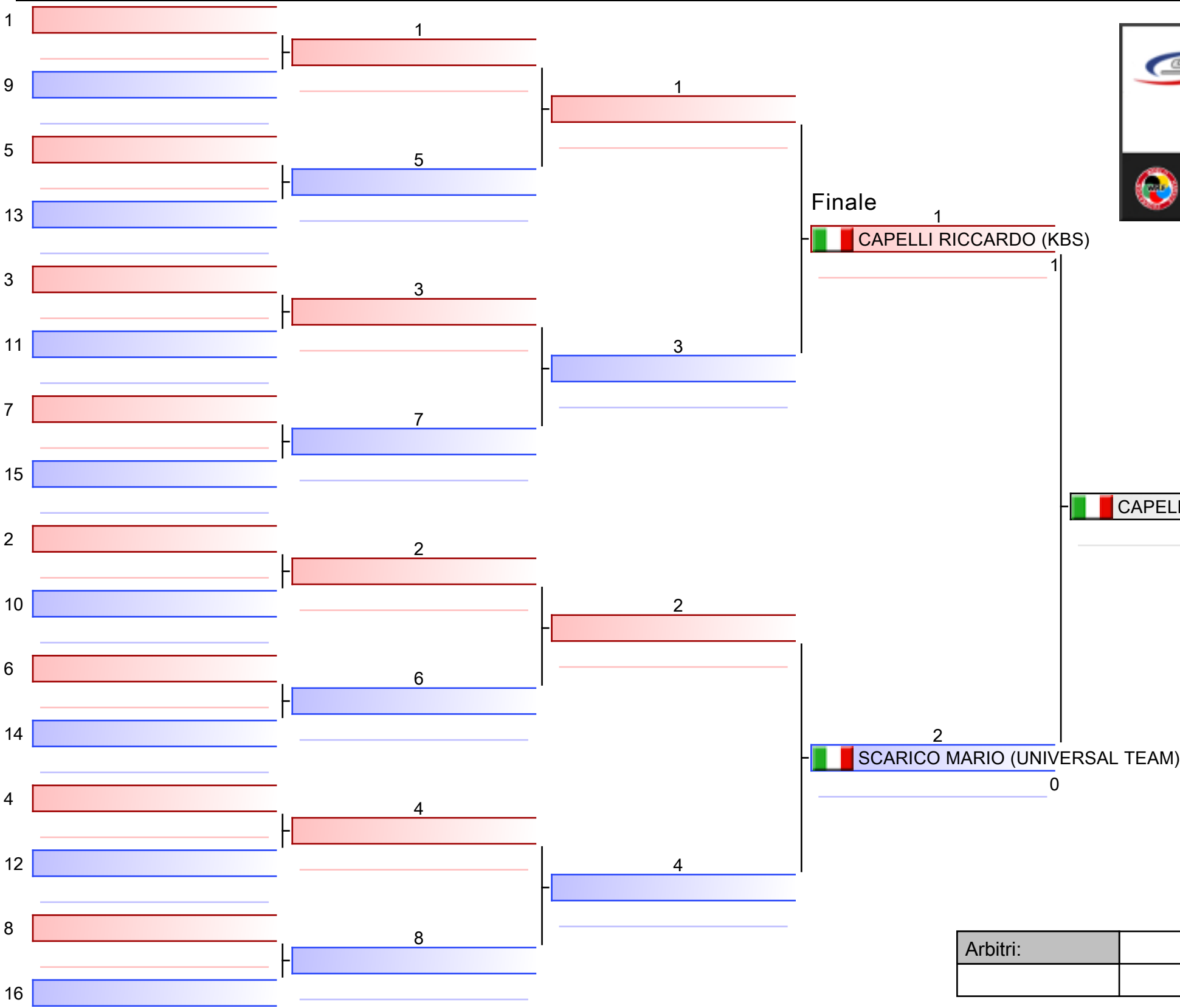

- | |
|-----------------------------------------|
| 1. CAPELLI RICCARDO (KBS) |
| 2. SCARICO MARIO (UNIVERSAL TEAM) |
| 3. PAGANO EMILIO (SHIZOKU KRT AV) |
| 3. SEGANTINI ANDREA (YOSEIKAN KARATE) |
| 5. FERRI DANIELE (MASTER RAPID SKF CBL) |
| 5. CECCHINI JACOPO (KARATE VENEZIA) |
| 7. BIZZARRI GIACOMO (TIGERKARATETEAM) |
| 7. SERA SIMONE (KTN) |

Arbitri:			

Kumite Individual male U14 -55

VENETO OPEN

2023-05-21

Tatami
5 11:10

Tabelloni - Pool
1

(c)sportdata GmbH & Co KG 2000-2023 (2023-05-21 20:07) v 10.0.0 build 1 (2023-02-10) Licenza: Fijlkam Karate 2023 (expire 2023-12-31)

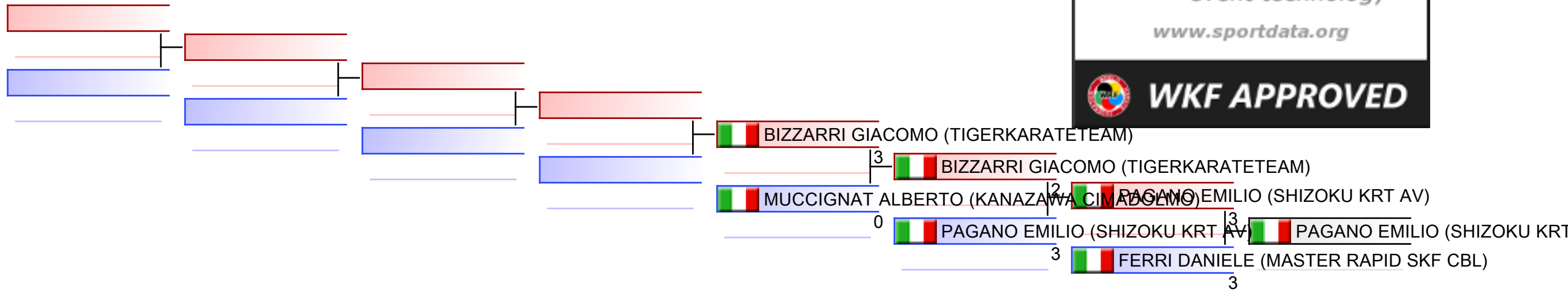

Ripescaggi: (1)

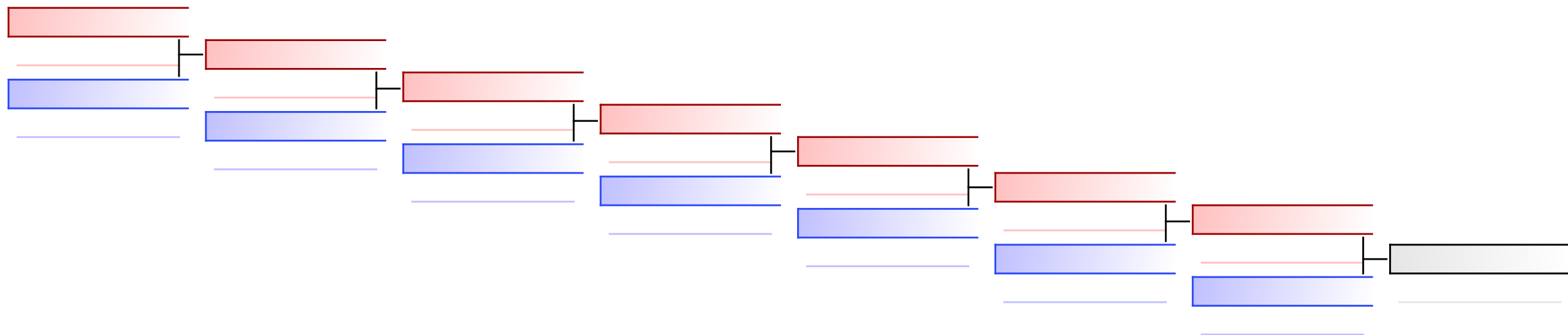

Arbitri:							
----------	--	--	--	--	--	--	--

Kumite Individual male U14 -55

VENETO OPEN

2023-05-21

Tatami
5 11:25

Tabelloni - Pool
2

(c)sportdata GmbH & Co KG 2000-2023 (2023-05-21 20:07) v 10.0.0 build 1 (2023-02-10) Licenza: Fijlkam Karate 2023 (expire 2023-12-31)

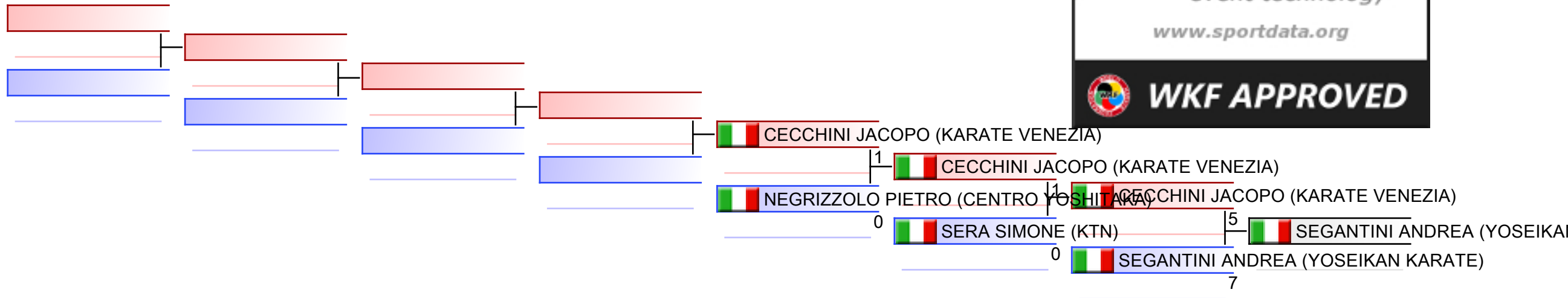

Ripescaggi: (2)

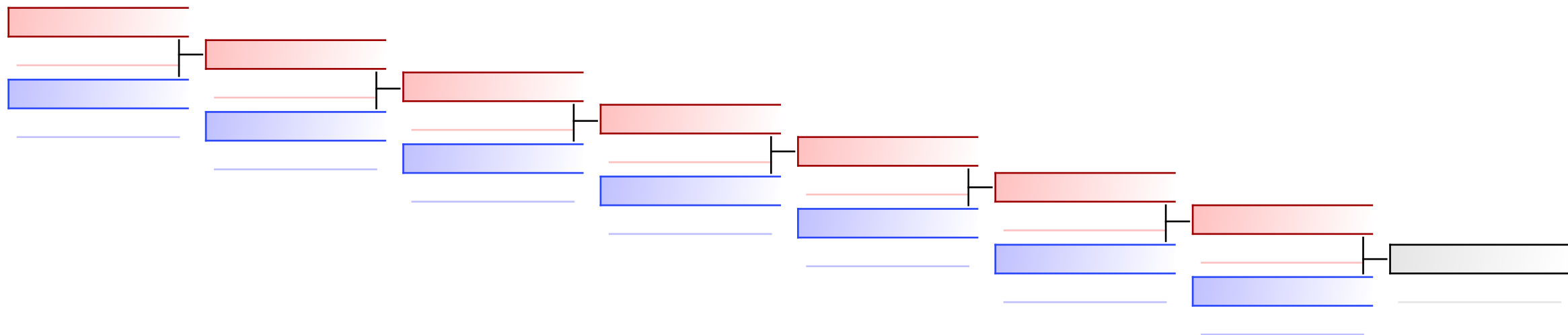

Arbitri:							
----------	--	--	--	--	--	--	--

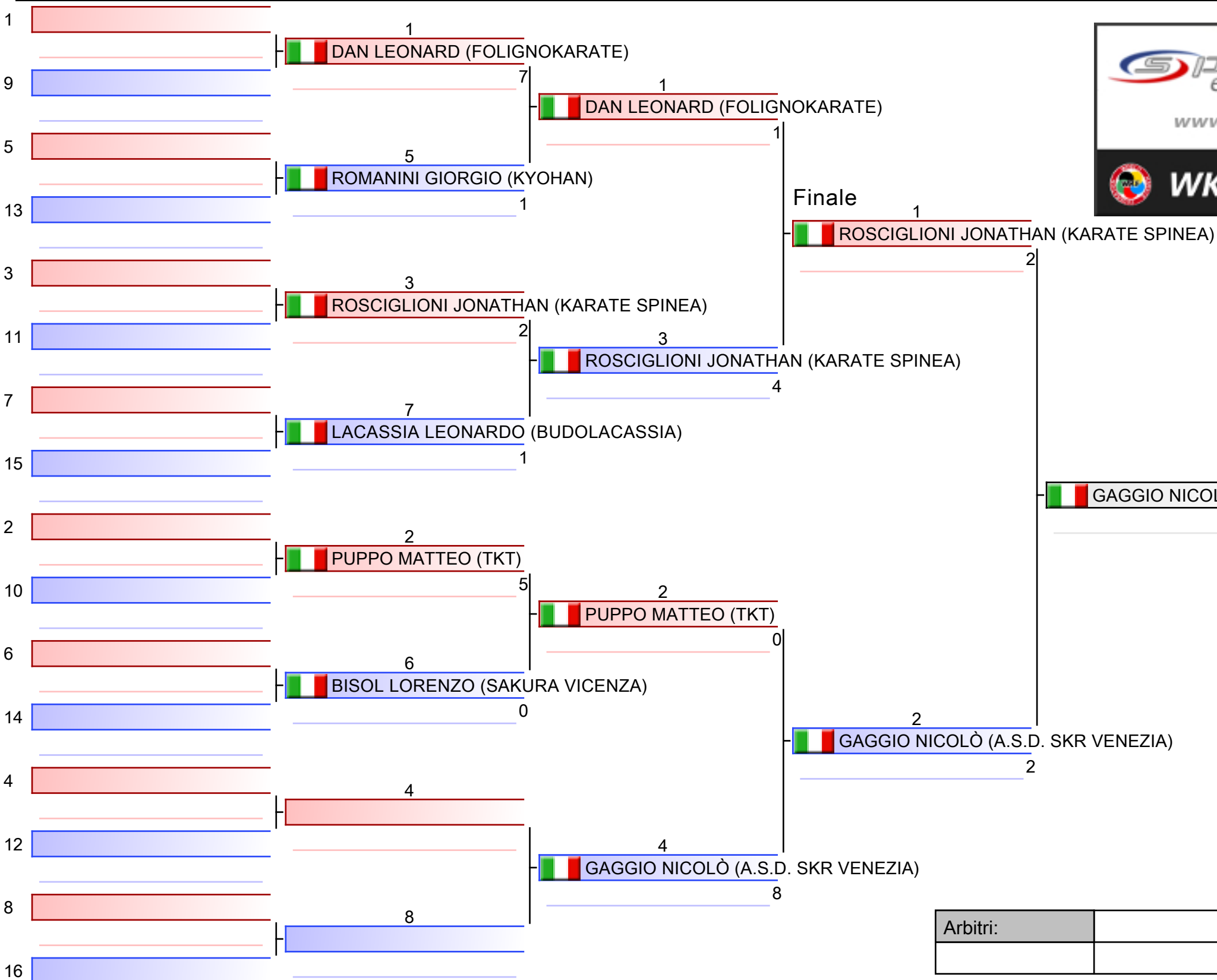

1. GAGGIO NICOLÒ (A.S.D. SKR VENEZIA)
2. ROSCIGLIONI JONATHAN (KARATE SPINEA)
3. PUPPO MATTEO (TKT)
3. DAN LEONARD (FOLIGNOKARATE)
5. LACASSIA LEONARDO (BUDOLACASSIA)

Arbitri:			

Kumite Individual male U21 +84

VENETO OPEN

2023-05-19

Tatami
3 16:25

Tabelloni - Pool
1

(c)sportdata GmbH & Co KG 2000-2023 (2023-05-21 20:07) v 10.0.0 build 1 (2023-02-10) Licenza: Fijlkam Karate 2023 (expire 2023-12-31)

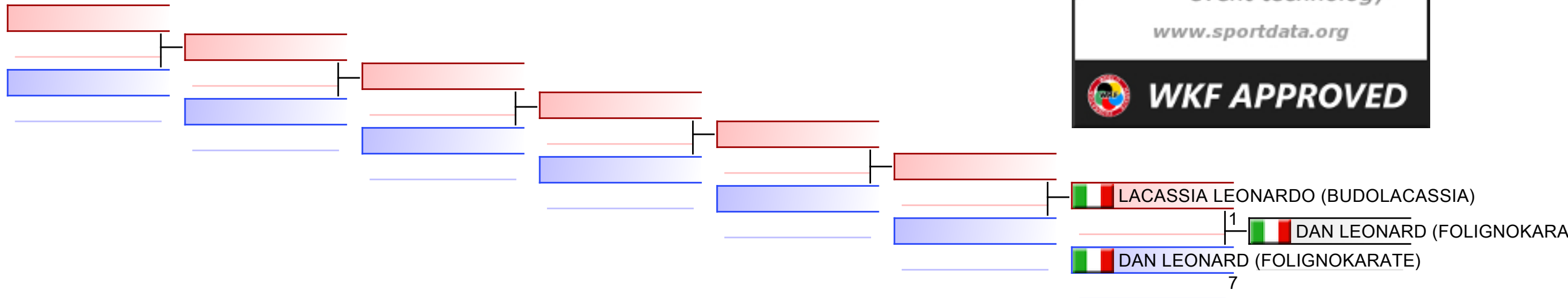

Ripescaggi: (1)

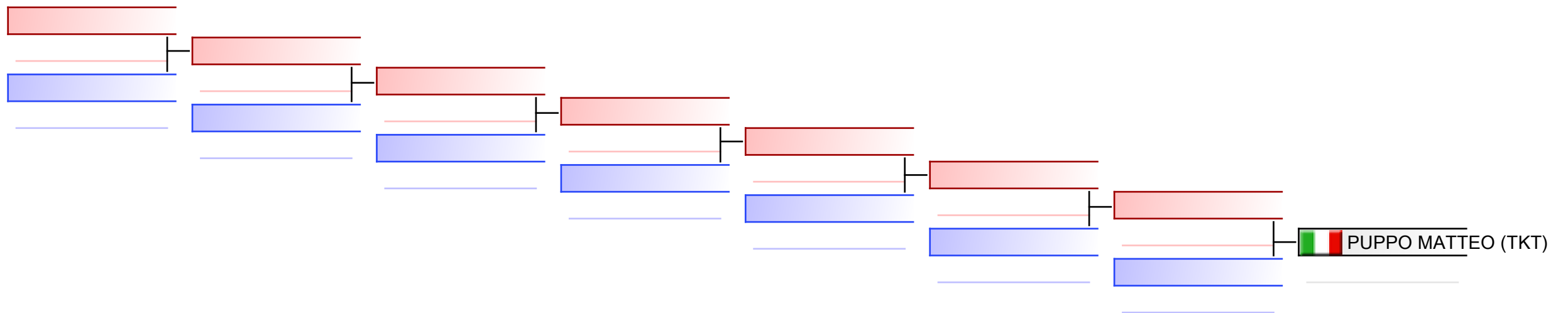

Arbitri:							
----------	--	--	--	--	--	--	--

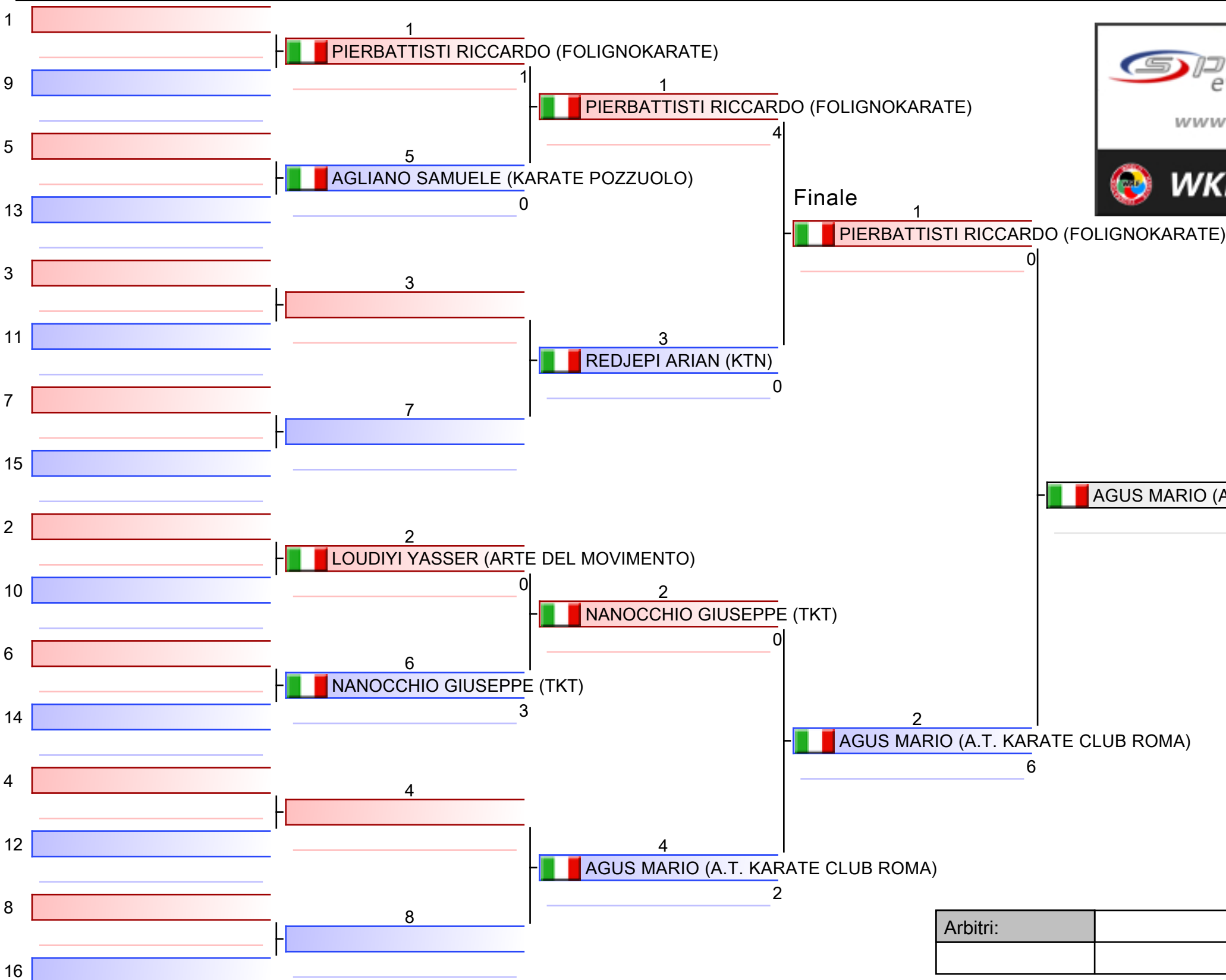

1. AGUS MARIO (A.T. KARATE CLUB ROMA)
2. PIERBATTISTI RICCARDO (FOLIGNOKARATE)
3. NANOCCHIO GIUSEPPE (TKT)
3. AGLIANO SAMUELE (KARATE POZZUOLO)
5. REDJEPI ARIAN (KTN)

Arbitri:			

Kumite Individual male U21 -60

VENETO OPEN

2023-05-19

Tatami
3 17:20

Tabelloni - Pool
1

(c)sportdata GmbH & Co KG 2000-2023 (2023-05-21 20:07) v 10.0.0 build 1 (2023-02-10) Licenza: Fijlkam Karate 2023 (expire 2023-12-31)

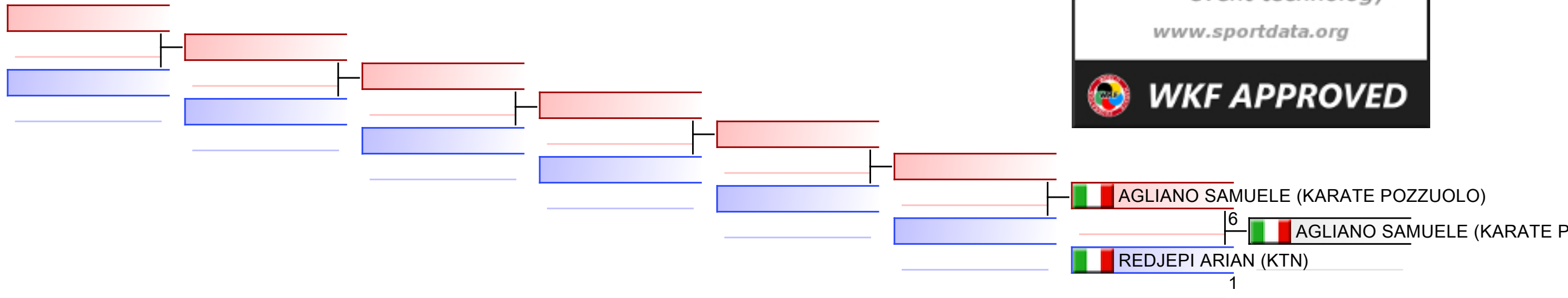

Ripescaggi: (1)

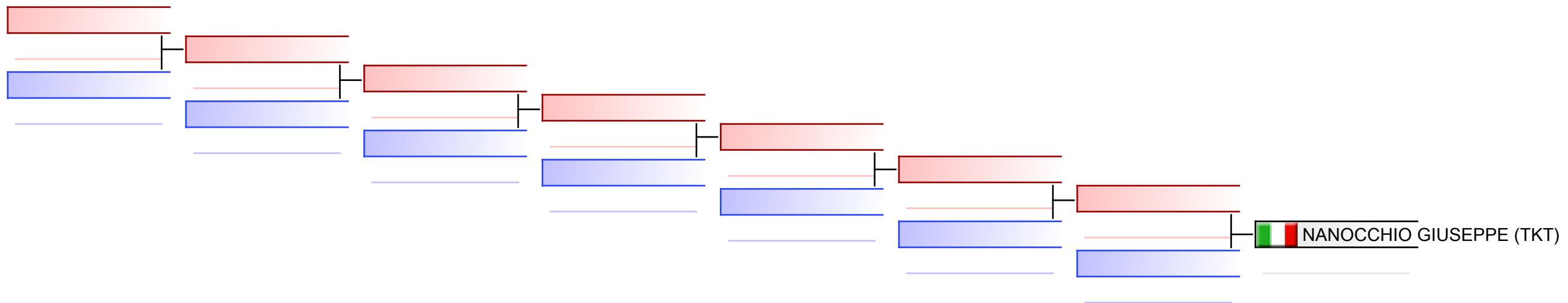

Arbitri:							
----------	--	--	--	--	--	--	--

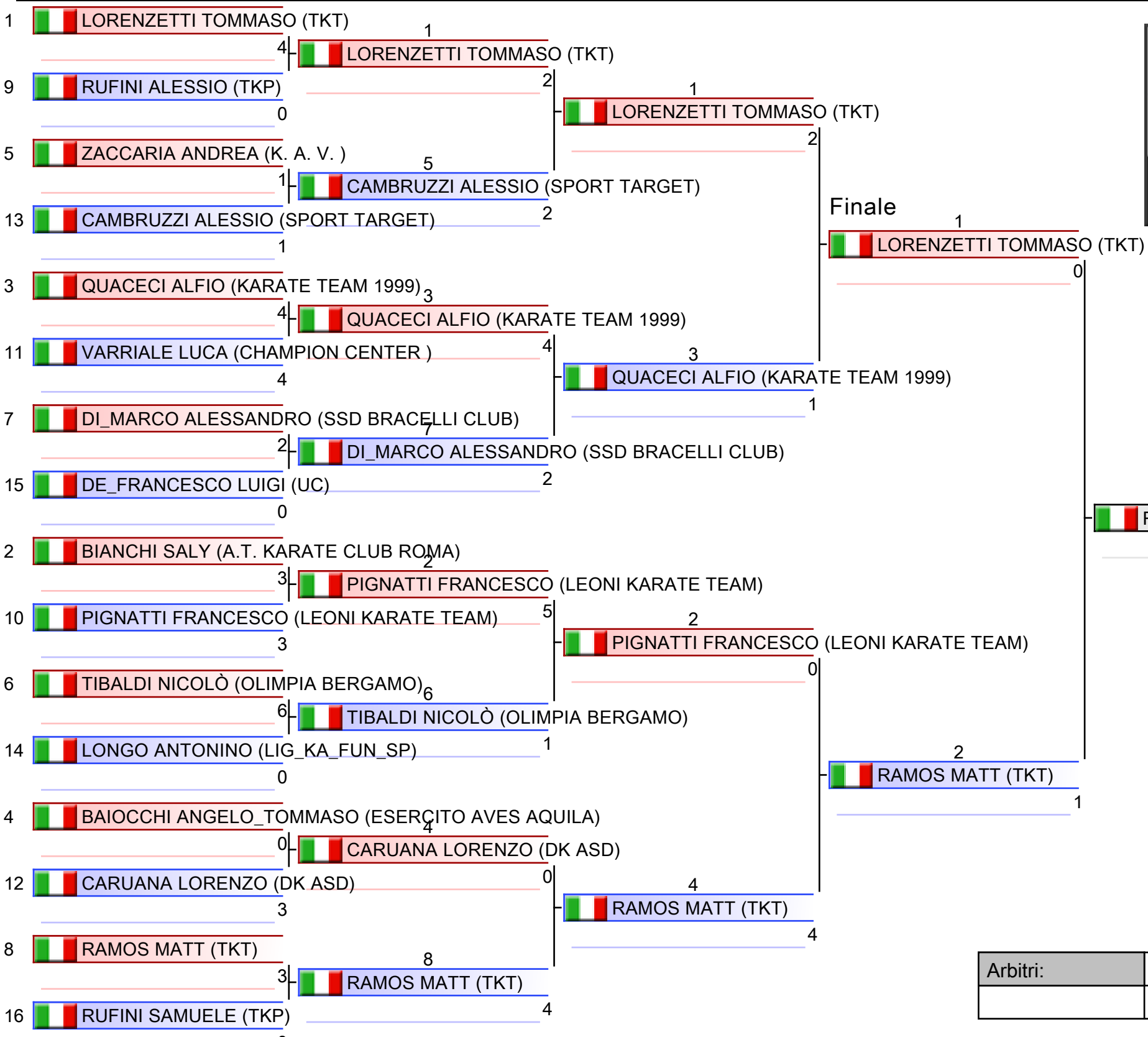

1. RAMOS MATT (TKT)
2. LORENZETTI TOMMASO (TKT)
3. QUACECI ALFIO (KARATE TEAM 1999)
3. RUFINI SAMUELE (TKP)
5. RUFINI ALESSIO (TKP)
5. PIGNATTI FRANCESCO (LEONI KARATE TEAM)
7. CAMBRUZZI ALESSIO (SPORT TARGET)
7. CARUANA LORENZO (DK ASD)

Arbitri:			

Kumite Individual male U21 -67

VENETO OPEN

2023-05-19

Tatami
5 16:45

Tabelloni - Pool
1

(c)sportdata GmbH & Co KG 2000-2023 (2023-05-21 20:07) v 10.0.0 build 1 (2023-02-10) Licenza: Fijlkam Karate 2023 (expire 2023-12-31)

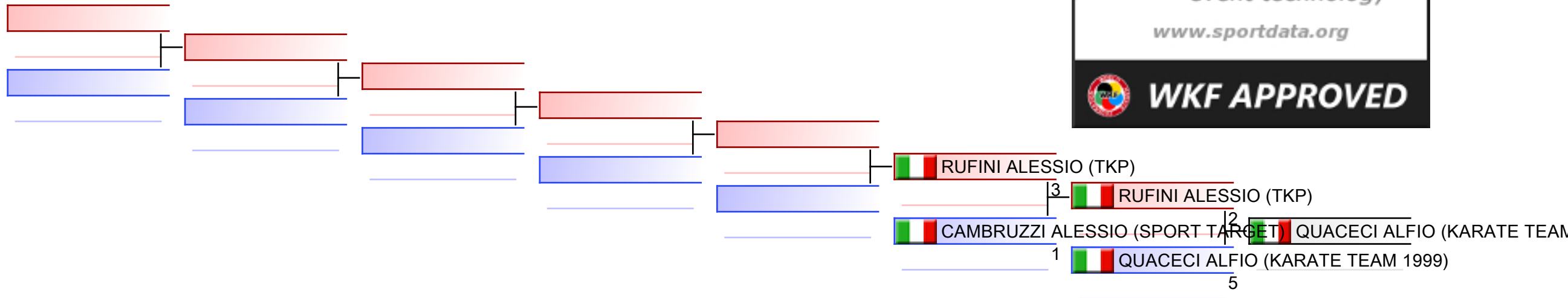

Ripescaggi: (1)

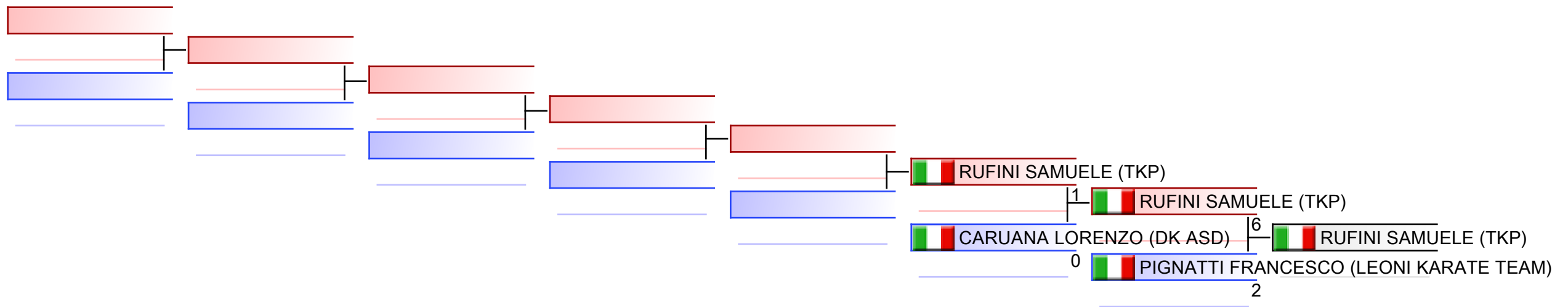

Arbitri:							
----------	--	--	--	--	--	--	--

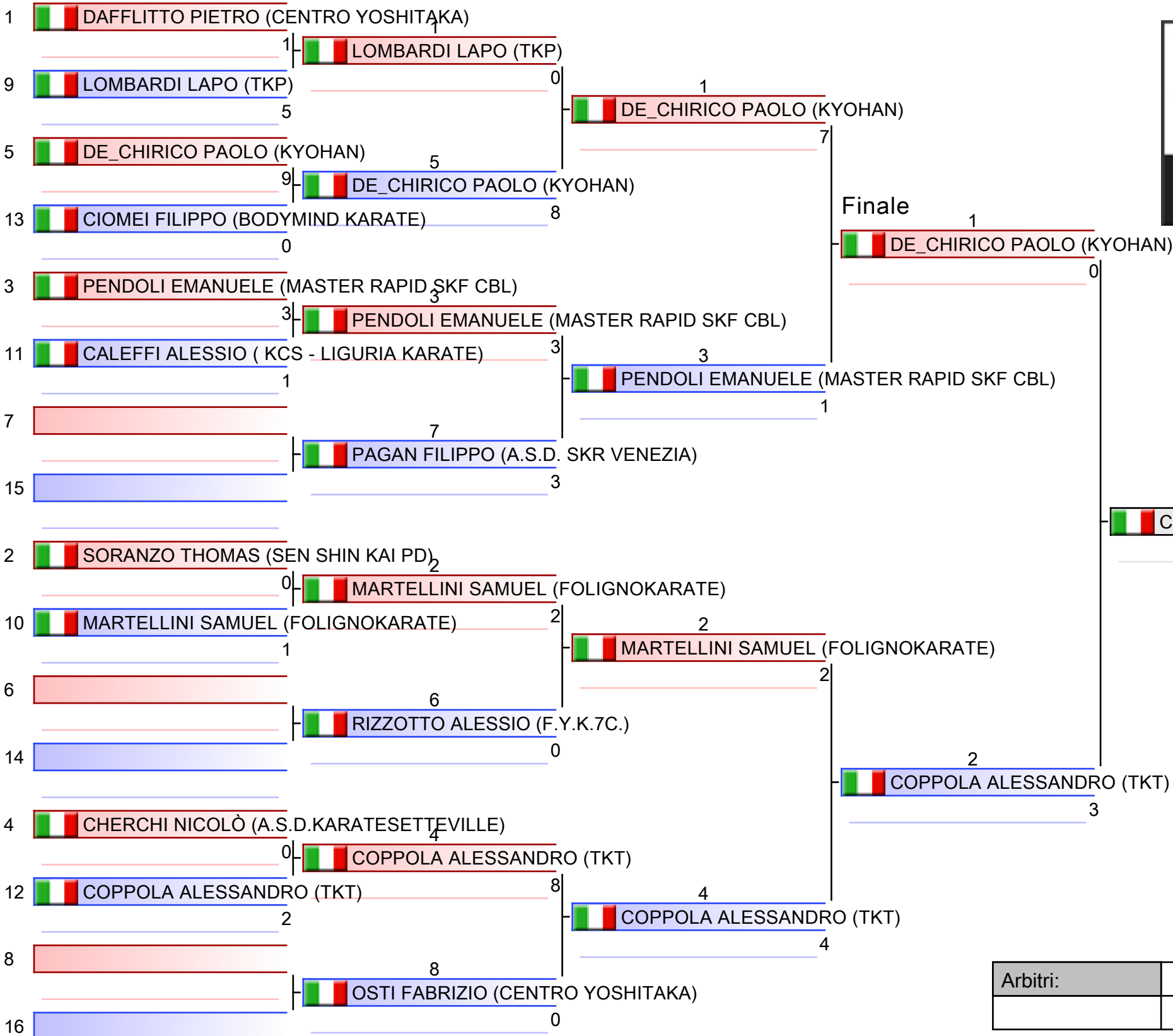

- | |
|--------------------------------------------|
| 1. COPPOLA ALESSANDRO (TKT) |
| 2. DE_CHIRICO PAOLO (KYOHAN) |
| 3. PENDOLI EMANUELE (MASTER RAPID SKF CBL) |
| 3. CHERCHI NICOLÒ (A.S.D.KARATESETTEVILLE) |
| 5. LOMBARDI LAPO (TKP) |
| 5. MARTELLINI SAMUEL (FOLIGNOKARATE) |
| 7. CIOMEI FILIPPO (BODYMIND KARATE) |
| 7. OSTI FABRIZIO (CENTRO YOSHITAKA) |

Arbitri:			

Kumite Individual male U21 -75

VENETO OPEN

2023-05-19

Tatami
2 17:15

Tabelloni - Pool
1

(c)sportdata GmbH & Co KG 2000-2023 (2023-05-21 20:07) v 10.0.0 build 1 (2023-02-10) Licenza: Fijlkam Karate 2023 (expire 2023-12-31)

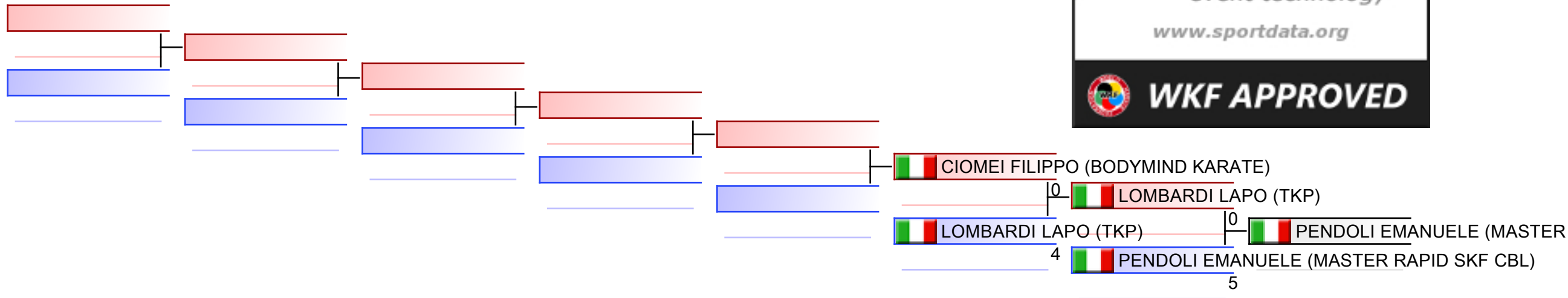

Ripescaggi: (1)

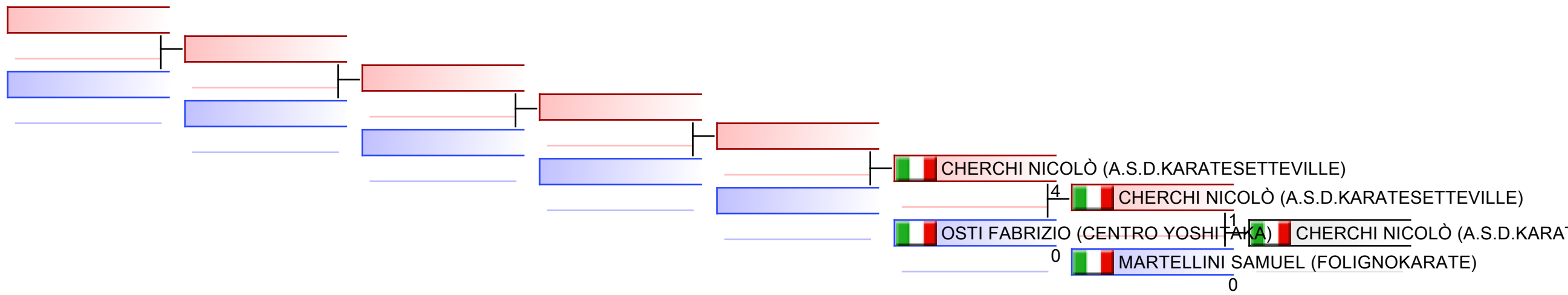

Arbitri:							
----------	--	--	--	--	--	--	--

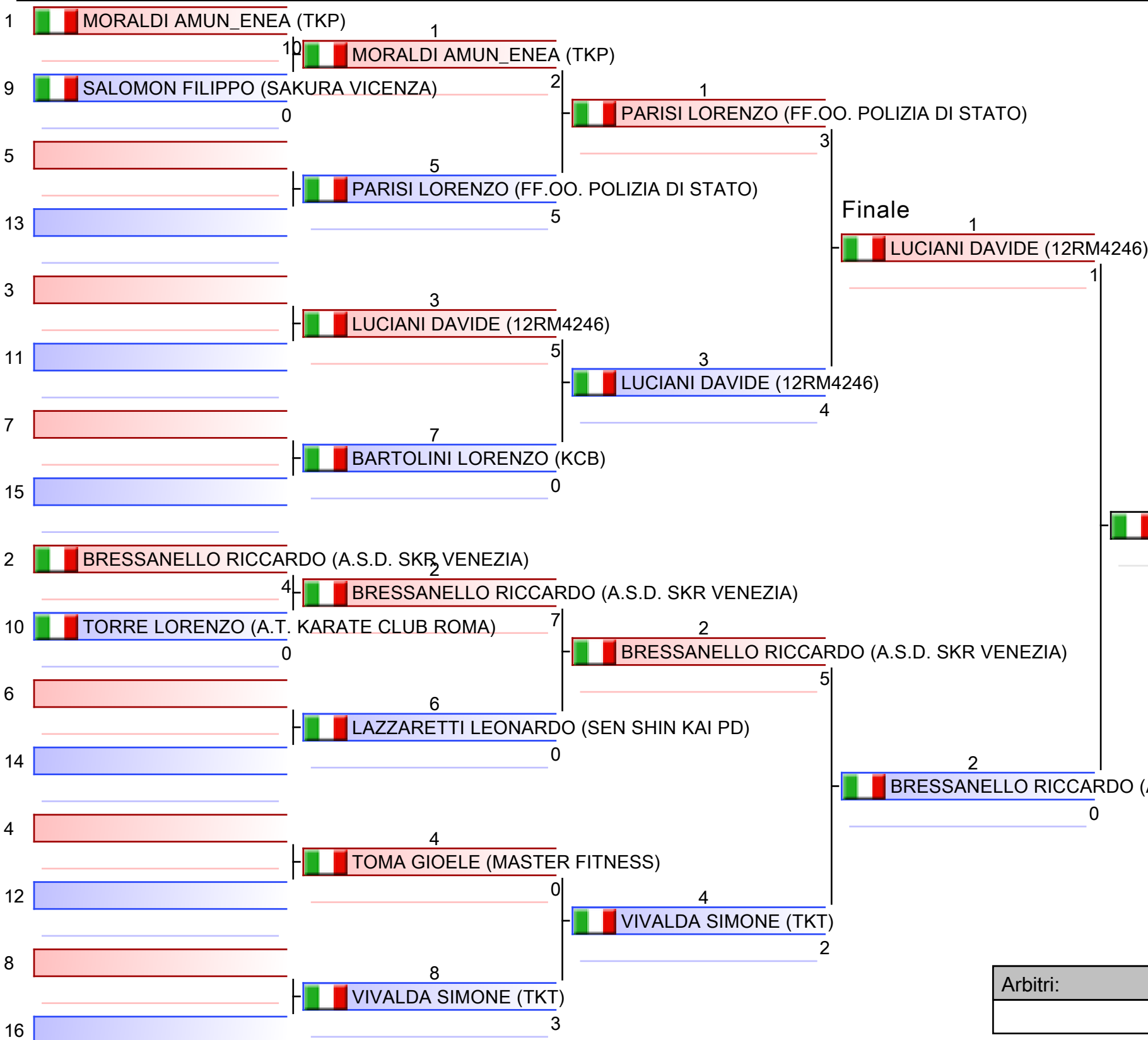

1. LUCIANI DAVIDE (12RM4246)
2. BRESSANELLO RICCARDO (A.S.D. SKR VENEZIA)
3. PARISI LORENZO (FF.OO. POLIZIA DI STATO)
3. VIVALDA SIMONE (TKT)
5. BARTOLINI LORENZO (KCB)
5. TORRE LORENZO (A.T. KARATE CLUB ROMA)
7. LAZZARETTI LEONARDO (SEN SHIN KAI PD)

Arbitri:			

Kumite Individual male U21 -84

VENETO OPEN

2023-05-19

Tatami
4 17:05

Tabelloni - Pool
1

(c)sportdata GmbH & Co KG 2000-2023 (2023-05-21 20:07) v 10.0.0 build 1 (2023-02-10) Licenza: Fijlkam Karate 2023 (expire 2023-12-31)

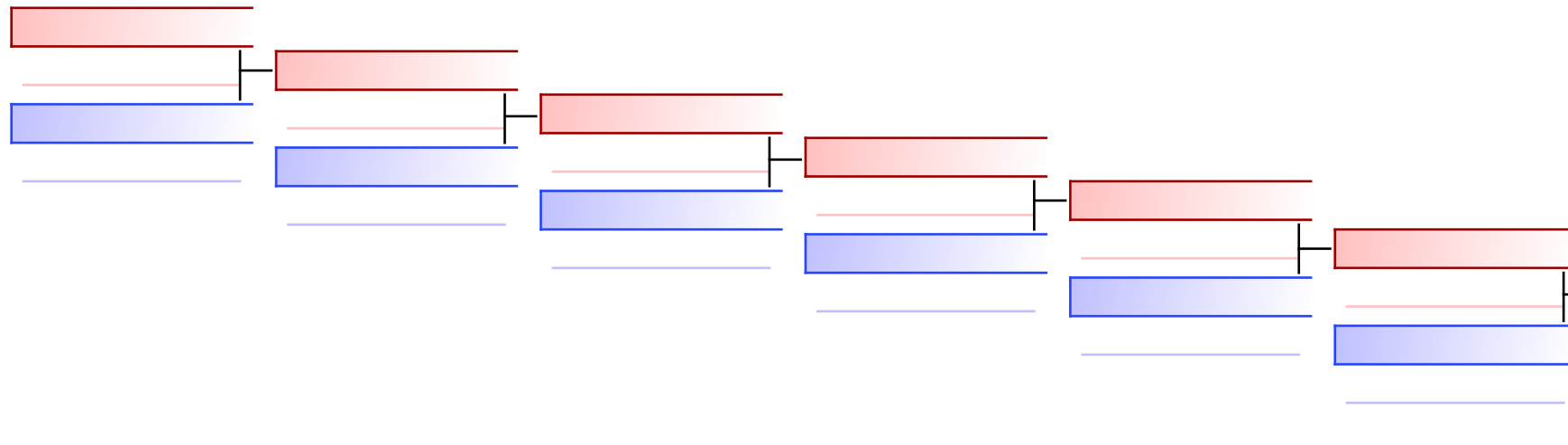

BARTOLINI LORENZO (KCB) 0
 PARISI LORENZO (FF.OO. POLIZIA DI STATO) 8

Ripescaggi: (1)

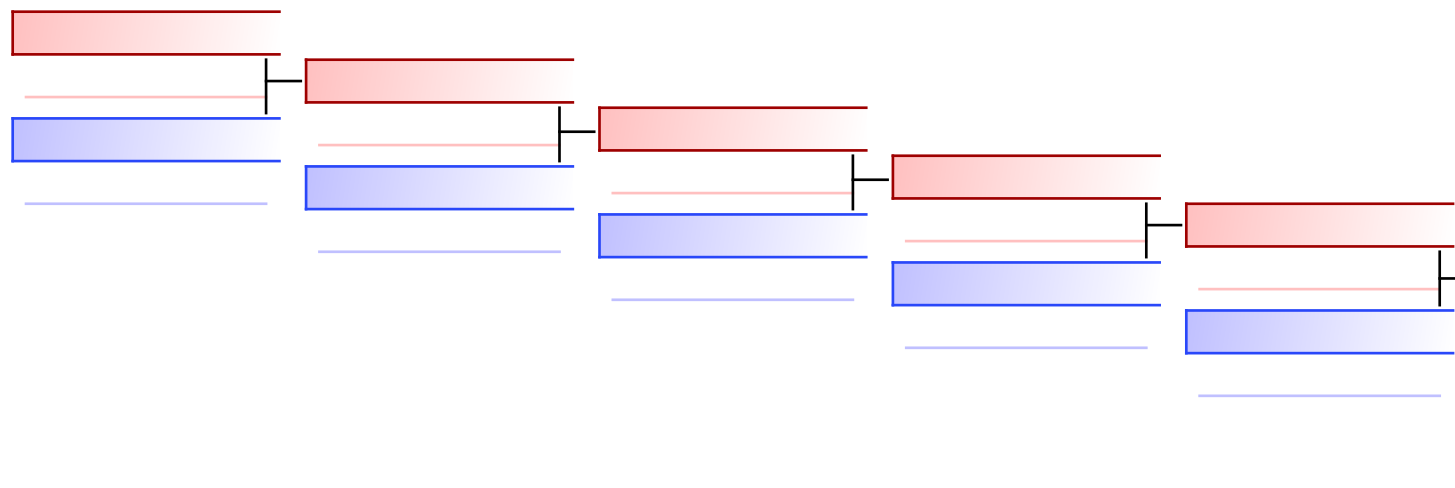

TORRE LORENZO (A.T. KARATE CLUB ROMA) 8
 TORRE LORENZO (A.T. KARATE CLUB ROMA) 2
 LAZZARETTI LEONARDO (SEN SEN KAI) 2
 VIVALDA SIMONE (TKT) 3

Arbitri:							
----------	--	--	--	--	--	--	--

VENETO OPEN - 2023-05-19

Lista ufficiale dei risultati

Kata Individual female Cadets				
1	ORSETTI ANNA	CENTRO KARATE RICCIONE 1		ITA - ITALY
2	MICHELI MATILDE	ASD ESERCITO - 3° RGT AVES AQUILA		ITA - ITALY
3	MARCONI MARIA	CENTRO KARATE RICCIONE		ITA - ITALY
3	PREDA GIADA	ASD ESERCITO - 3° RGT AVES AQUILA		ITA - ITALY
5	OBERTO VIVIEN	ASD TALARICO KARATE TEAM APS		ITA - ITALY
5	DUBLINO SOFIA	ASD TALARICO KARATE TEAM APS		ITA - ITALY
7	PUNTA MICAELA	CENTRO SPORTIVO KARATE WADO RYU ROMA		ITA - ITALY
7	ESPOSITO EMILIA	UNIVERSAL TEAM - CSO ARCOBALENO		ITA - ITALY
9	TAGLIABUE SILVIA	ISTITUTO KARATE SHOTOKAN SONDRIO		ITA - ITALY
9	BACCHINI CHIARA	CENTRO KARATE RICCIONE		ITA - ITALY
11	NATALINI GIULIA GINEVRA	ASD ESERCITO - 3° RGT AVES AQUILA		ITA - ITALY
11	ANDREINI MARTA	AKS FIRENZE		ITA - ITALY
13	PARIMBELLI CAROLINA	MASTER RAPID SKF CBL		ITA - ITALY
13	VILLA MARTINA	ASD ESERCITO - 3° RGT AVES AQUILA		ITA - ITALY
15	FORCELLA ELEONORA	ASD FENICE KARATE TEAM		ITA - ITALY
15	COSELLI LINDA	A.S.D. TIGER KARATE TEAM		ITA - ITALY
17	BELLARDI MARIA SOFIA	ASD CENTRO KARATE SPORTIVO		ITA - ITALY
17	BONETTI NICOLE	ATLAS KARATE		ITA - ITALY
17	GALLUZZI REBECCA	ASD CENTRO KARATE SPORTIVO		ITA - ITALY
17	BENCIVENGA FRANCESCA	G.S.FF.OO. POLIZIA DI STATO		ITA - ITALY
21	GAUDENZI CECILIA	A.S.D. KAMEJU KARATE-DO		ITA - ITALY
21	FERRA EMMA	GOLDEN TIGER TEAM KARATE - MUAY THAI		ITA - ITALY
21	GABRIELE MIRIAM	POLIHANDY ASD		ITA - ITALY
21	GATTA LINDA	ASD CENTRO KARATE SPORTIVO		ITA - ITALY
25	BERTOCCHI ELISA	A.S.D. TIGER KARATE TEAM		ITA - ITALY
25	ALGERI OLIMPIA	CENTRO KARATE RICCIONE		ITA - ITALY
25	DE PACE MARIA LUISA	A.S.D. SPORT KARATE CURINGA		ITA - ITALY
25	NICOSIA VALERIA	ATLAS KARATE		ITA - ITALY
29	MATTUGINI ESTER	SPAZIO SPORT FORTE DEI MARMI		ITA - ITALY

VENETO OPEN - 2023-05-19

Lista ufficiale dei risultati

29	FUSCO BENEDETTA	BERRETTONI		ITA - ITALY	
29	NAGLEIN EMMA	ASD KARATE NINJA CLUB		ITA - ITALY	
29	BALDRIGHI CHIARA	ASD FENICE KARATE TEAM		ITA - ITALY	
33	CERATO GIORGIA	A.S.D. FIGHTERS KARATE TEAM		ITA - ITALY	
33	TOGNETTI MARIA CHIARA	ASD CAM LUCCA		ITA - ITALY	
33	ORTALLI NINA	CENTRO KARATE RICCIONE		ITA - ITALY	
33	MALLEGNI MARTA	ASD CAM LUCCA		ITA - ITALY	

Kata Individual female Juniors

1	DOMINICI ROBERTA	SKORPION KARATE ASD		ITA - ITALY	
2	PADOAN MARTINA	CENTRO KARATE RICCIONE		ITA - ITALY	
3	GRUPPIONI ASIA	ASD FENICE KARATE TEAM		ITA - ITALY	
3	EDERAR MIRIAM	MASTER RAPID SKF CBL		ITA - ITALY	
5	VERDONE MELISSA	MASTER RAPID SKF CBL		ITA - ITALY	
5	ROSSI GIULIA	G.S.FF.OO. POLIZIA DI STATO		ITA - ITALY	
7	STANGHERLIN SOFIA	SPORT TARGET		ITA - ITALY	
7	SERINELLI AURORA	CENTRO KARATE RICCIONE		ITA - ITALY	
9	BACCHINI CHIARA	CENTRO KARATE RICCIONE		ITA - ITALY	
9	DE GREGORIO GABRIELLA	A.S.D. POLISPORTIVA TEVERE		ITA - ITALY	
11	GRAZIA NICOL	G.S.FF.OO. POLIZIA DI STATO		ITA - ITALY	
11	NORIS GIADA	MASTER RAPID SKF CBL		ITA - ITALY	
13	MARCELLI ANNA	ASD KARATE CAMAIORE		ITA - ITALY	
13	CRUCITTI FRANCESCA	A.S.D. ARTESPORT		ITA - ITALY	
15	POLI GRETA	ISTITUTO KARATE SHOTOKAN SONDRIO		ITA - ITALY	
15	BRAMBILLA CHIARA	MASTER RAPID SKF CBL		ITA - ITALY	
17	MUGNANI MIRIAM	ASD CAM LUCCA		ITA - ITALY	
17	LA MACCHIA CRISTINA	ACCADEMIA TENRYU KARATE ASD		ITA - ITALY	
17	MACHETTI IRENE	ETRURIA KARATE		ITA - ITALY	
17	VIELMI ELISA	MASTER RAPID SKF CBL		ITA - ITALY	
21	NICHETTI VALERIA	ASD CENTRO KARATE SPORTIVO		ITA - ITALY	
21	CAMPISCIANO ALESSIA	ASD KB CENTER 2000		ITA - ITALY	
21	BONDI EVITA	A.S.D. REN.BU.KAN FORLÌ		ITA - ITALY	
21	SCATENA LETIZIA	ASD CAM LUCCA		ITA - ITALY	

VENETO OPEN - 2023-05-19

Lista ufficiale dei risultati

25	BUOSO CHIARA	A.S.D. SEN SHIN KAI ROVIGO		ITA - ITALY	
25	GULIZIA BIANCA ANNA	A.S.D. DYNAMIK REVOLUTION KARATE		ITA - ITALY	
25	BULGARELLI IRENE	ASD KARATE TEAM 1999		ITA - ITALY	
25	IPPOLITI IRENE	ASD SHOTOKAN KARATE POZZUOLO DEL FRIULI		ITA - ITALY	
29	DALLE FUSINE ANNA	A.S.D. NENRJUKAN KARATE		ITA - ITALY	

Kata Individual female Sen

1	EDERAR MIRIAM	MASTER RAPID SKF CBL		ITA - ITALY	
2	REALE FRANCESCA	A.S.D. ASI KARATE VENETO		ITA - ITALY	
3	GRUPPIONI ASIA	ASD FENICE KARATE TEAM		ITA - ITALY	
3	MARCHETTI GIULIA	SPORT TARGET		ITA - ITALY	
5	GAROFOLI SOFIA	G.S.FF.OO. POLIZIA DI STATO		ITA - ITALY	
5	NORIS GIADA	MASTER RAPID SKF CBL		ITA - ITALY	
7	ROSSI GIULIA	G.S.FF.OO. POLIZIA DI STATO		ITA - ITALY	
7	TAGLIAFIERRO CHIARA	G.S.FF.OO. POLIZIA DI STATO		ITA - ITALY	
9	SALVATI ERICA	A.S.D. KARATESETTEVILLE		ITA - ITALY	
9	PADOAN MARTINA	CENTRO KARATE RICCIONE		ITA - ITALY	
11	BIONDO ILARIA	ASD KARATE 2001		ITA - ITALY	
11	VERDONE MELISSA	MASTER RAPID SKF CBL		ITA - ITALY	
13	MORBINI GAIA	ASD CAM LUCCA		ITA - ITALY	
13	CIANCHI MARTINA	ASD KARATE NINJA CLUB		ITA - ITALY	
15	GOLINO SIMONETTA	KARATE BALDASSARRE		ITA - ITALY	
15	PERUZZI GIADA	SPORT TARGET		ITA - ITALY	
17	MORO SOFIA	ASD CENTRO KARATE SPORTIVO		ITA - ITALY	
17	CRIPPA ANNA	ATLAS KARATE		ITA - ITALY	
17	VIELMI ELISA	MASTER RAPID SKF CBL		ITA - ITALY	
17	VEDOVELLI GIULIA	ASD RYUKO		ITA - ITALY	
21	SIMONCINI SOPHIA	ASD KARATE CAMAIORE		ITA - ITALY	
21	BATTIOLI ELISA	JKS CASTANO PRIMO		ITA - ITALY	
21	PAOLETTI ILARIA	AKS FIRENZE		ITA - ITALY	
21	CALDI ARIANNA	MASTER RAPID SKF CBL		ITA - ITALY	
25	SOLOTCHI TANIA	A.S.D. KAMEJU KARATE-DO		ITA - ITALY	
25	IACOVONE MARTINA	A.S.D. TIGER KARATE TEAM		ITA - ITALY	

VENETO OPEN - 2023-05-19

Lista ufficiale dei risultati

25	STANGHERLIN SOFIA	SPORT TARGET		ITA - ITALY	
25	BACCHINI CHIARA	CENTRO KARATE RICCIONE		ITA - ITALY	
29	MAESTRI ERIKA	MASTER RAPID SKF CBL		ITA - ITALY	
29	DUSI SERENA	ASD KARATE TEAM 1999		ITA - ITALY	
29	DOMINIJANNI ELISA	BERRETTONI		ITA - ITALY	
29	BRAMBILLA CHIARA	MASTER RAPID SKF CBL		ITA - ITALY	
33	SERINELLI AURORA	CENTRO KARATE RICCIONE		ITA - ITALY	
33	SCABIN FRANCESCA	A.S.D. NENRJUKAN KARATE		ITA - ITALY	
33	MACHETTI IRENE	ETRURIA KARATE		ITA - ITALY	
33	GAUDENZI ELEONORA	A.S.D. KAMEJU KARATE-DO		ITA - ITALY	
37	LA MACCHIA CRISTINA	ACCADEMIA TENRYU KARATE ASD		ITA - ITALY	
37	LORENZONI ELENA	SPAZIO SPORT FORTE DEI MARMI		ITA - ITALY	

Kata Individual female U14

1	CRUCITTI SOFIA	A.S.D. ARTESPORT		ITA - ITALY	
2	AUDIA ASIA	KAIGI KARATE FITNESS A.S.D.		ITA - ITALY	
3	VALENTI JENNIFER	MASTER RAPID SKF CBL		ITA - ITALY	
3	FRIGENI MICHELA	MASTER RAPID SKF CBL		ITA - ITALY	
5	STAGI NICOLE	SPAZIO SPORT FORTE DEI MARMI		ITA - ITALY	
5	LENZONI EMMA	ASD KARATE CAMAIORE		ITA - ITALY	
7	SEREN DIANA	A.S.D. TATAKAI KARATE TEAM		ITA - ITALY	
7	RICCIARDI ANGELA	KARATE BALDASSARRE		ITA - ITALY	
9	MACIAS VINCI ANGELICA	ASD TALARICO KARATE TEAM APS		ITA - ITALY	
9	CARDAROPOLI ISABEL	CENTRO KARATE RICCIONE		ITA - ITALY	
11	CUMBO GRETA	ATLAS KARATE		ITA - ITALY	
11	DAMI GIORGIA	ASD TALARICO KARATE TEAM APS		ITA - ITALY	
13	ROCCHI ASIA	ASD KARATE DO NOVENTA		ITA - ITALY	
13	VIACAVA CAMILLA	PRO RECCO KARATE ASD		ITA - ITALY	
15	DELL'AMICO GIOIA	A.S.D. TIGER KARATE TEAM		ITA - ITALY	
15	ZOCCOLA LISA	A.S.D. ARTESPORT		ITA - ITALY	
17	VIACAVA CATERINA	PRO RECCO KARATE ASD		ITA - ITALY	
17	CIELOK IRENE	ASD ESERCITO - 3° RGT AVES AQUILA		ITA - ITALY	
19	GARGIULO TERRY	UNIVERSAL TEAM - CSO ARCOBALENO		ITA - ITALY	

VENETO OPEN - 2023-05-19

Lista ufficiale dei risultati

Kata Individual female U21					
1	TAGLIAFIERRO CHIARA	G.S.FF.OO. POLIZIA DI STATO		ITA - ITALY	
2	DOMINIJANNI ELISA	BERRETTONI		ITA - ITALY	
3	MARCHETTI GIULIA	SPORT TARGET		ITA - ITALY	
3	RIGONI CLELIA	A. S. D. SCUOLA KARATE OMEGNA		ITA - ITALY	
5	PERUZZI GIADA	SPORT TARGET		ITA - ITALY	
5	ZANI CHIARA	MASTER RAPID SKF CBL		ITA - ITALY	
7	CIANCHI MARTINA	ASD KARATE NINJA CLUB		ITA - ITALY	
7	CHERUBINI SOFIA	CENTRO KARATE RICCIONE		ITA - ITALY	
9	ČVOROVIĆ ALEKSANDRA	ŠPORTNO DRUŠTVO GORICA		SLO - SLOVENIA	
9	BOZZI REBECCA	ASD CAM LUCCA		ITA - ITALY	
11	RIFUGIO LUDOVICA	MASTER RAPID SKF CBL		ITA - ITALY	
11	BRESCIANI LARA	MASTER RAPID SKF CBL		ITA - ITALY	
13	CALDI ARIANNA	MASTER RAPID SKF CBL		ITA - ITALY	
13	MAESTRI ERIKA	MASTER RAPID SKF CBL		ITA - ITALY	
15	SALANI AURORA	ASD CAM LUCCA		ITA - ITALY	
15	SOLOTCHI TANIA	A.S.D. KAMEJU KARATE-DO		ITA - ITALY	
17	GAUDENZI ELEONORA	A.S.D. KAMEJU KARATE-DO		ITA - ITALY	
17	CAPPELLATO MARIA	A.S.D. SEN SHIN KAI ROVIGO		ITA - ITALY	
19	BONAVOLONTA FRANCESCA	ASD KB CENTER 2000		ITA - ITALY	
19	ACQUATI MICOLE	KAIGI KARATE FITNESS A.S.D.		ITA - ITALY	
21	BIANCHINI ELISON	MASTER RAPID SKF CBL		ITA - ITALY	
21	BATTIOLI ELISA	JKS CASTANO PRIMO		ITA - ITALY	
23	ALEGRE LAMARQUE MAIA	A.S.D. NENRJUKAN KARATE		ITA - ITALY	

Kata Individual male Cadets					
1	MORETTI OSCAR	MASTER RAPID SKF CBL		ITA - ITALY	
2	CALABRESE FILIPPO	MASTER RAPID SKF CBL		ITA - ITALY	
3	ZHOU MARCO	A.S.D. KARATESETTEVILLE		ITA - ITALY	
3	BICOS NIKITA	A.S.D. SEN SHIN KAI ROVIGO		ITA - ITALY	
5	PUTELLI NICOLÒ	ASD TALARICO KARATE TEAM APS		ITA - ITALY	
5	CAPONERA EMANUELE	A.S.D. KARATE ROMA		ITA - ITALY	
7	DI LAZZARO LEONARDO	G.S.FF.OO. POLIZIA DI STATO		ITA - ITALY	

VENETO OPEN - 2023-05-19

Lista ufficiale dei risultati

7	MARCHESE LUCIO	ASD VIP CENTER MOTTA		ITA - ITALY	
9	FALCO SAMUELE	ASD TALARICO KARATE TEAM APS		ITA - ITALY	
9	BERETTA FEDERICO	ASD CSK MASTER		ITA - ITALY	
11	LAM GABRIELE	TSKS BELLUNO		ITA - ITALY	
11	DI PUCCHIO ROBERTO	MASTER RAPID SKF CBL		ITA - ITALY	
13	BRUNDU CRISTIAN	ASD CISTELLUM JUDO KARATE		ITA - ITALY	
13	OLLAGNERO GIOVANNI SEBASTIAN	A.S.D. ARTESPORT		ITA - ITALY	
15	CAMPAGNA SAMUELE	ACCADEMIA TENRYU KARATE ASD		ITA - ITALY	
15	FIORAVANTI RICCARDO	AKS FIRENZE		ITA - ITALY	
17	SALAMITI GIUSEPPE	LIFE CHAMPION MADDALONI		ITA - ITALY	
17	BURALI DAVIDE	A.S.D. MASTER FITNESS		ITA - ITALY	
17	ZAMBOTTO NICOLO	CENTRO RICERCHE SPORT KARATE		ITA - ITALY	
17	BRASILE ANTONIO	LIFE CHAMPION MADDALONI		ITA - ITALY	
21	TRAVIA MATTEO	TORA-DO KARATE TEAM A.S.D.		ITA - ITALY	
21	ROSIELLO MARCO	ACCADEMIA KARATE UNION TEAM		ITA - ITALY	
21	CAMANZO SALVATORE	ASD NIPPON CLUB NAPOLI KARATE		ITA - ITALY	
21	BAGAROLO THOMAS	CENTRO KARATE RICCIONE 1		ITA - ITALY	
25	VARVA ALESSANDRO	A.S.D. SEN SHIN KAI ROVIGO		ITA - ITALY	
25	PARABOSCHI MATTEO	ASSOCIAZIONE SPORTIVA DILETTANTISTICA SHU REN KAN		ITA - ITALY	
25	VASTANO MICHELE	KARATE BALDASSARRE		ITA - ITALY	
25	TARTAGLIONE GAETANO PIO	KARATE BALDASSARRE		ITA - ITALY	
29	MUNI ALESSANDRO	KARATE BALDASSARRE		ITA - ITALY	
29	SCIANNELLI GIULIO	ASD ATLETIC KARATE DO AZZANO X		ITA - ITALY	
29	CARMINATI ANDREA	ASD ESERCITO - 3° RGT AVES AQUILA		ITA - ITALY	
33	PIZZAMIGLIO ALESSIO	ASD KARATE TEAM 1999		ITA - ITALY	
33	PINTO ALESSIO	A.S.D. JOHNNYS KARATE BORGO SISA		ITA - ITALY	
33	ANGELLOTTI DANIELE	UNIVERSAL TEAM - CSO ARCOBALENO		ITA - ITALY	

Kata Individual male Juniors

1	MATACCHIONI LUIGI	G.S.FF.OO. POLIZIA DI STATO		ITA - ITALY	
---	-------------------	--------------------------------	-------------------------------------------------------------------------------------	-------------	--

VENETO OPEN - 2023-05-19

Lista ufficiale dei risultati

2	COSCI GIUSEPPE	ASD KARATE CAMAIORE		ITA - ITALY	
3	DI RUBBA LUIGI	ASD TIGER S STYLE TEAM IODICE		ITA - ITALY	
3	ROSIELLO GIUSEPPE	G.S.FF.OO. POLIZIA DI STATO		ITA - ITALY	
5	BOMBARDI LEONARDO	MASTER RAPID SKF CBL		ITA - ITALY	
5	EDERAR KARIM	MASTER RAPID SKF CBL		ITA - ITALY	
7	FUSCAGNI ALEX	A.S.D. KARATESETTEVILLE		ITA - ITALY	
7	ALBERTIN LORENZO	A.S.D. SEN SHIN KAI ROVIGO		ITA - ITALY	
9	SERGI FRANCESCO	A.S.D. METROPOLITAN KARATE BRINDISI		ITA - ITALY	
9	CALDI LEONARDO	MASTER RAPID SKF CBL		ITA - ITALY	
11	CALVI FILIPPO	MASTER RAPID SKF CBL		ITA - ITALY	
11	PORTOGALLO MATTEO	ASD TALARICO KARATE TEAM APS		ITA - ITALY	
13	MARZANO MICHELE	ASD TALARICO KARATE TEAM APS		ITA - ITALY	
13	CARUGATI CRISTIAN	JKS CASTANO PRIMO		ITA - ITALY	
15	MELANI MATTEO	AKS FIRENZE		ITA - ITALY	
15	MASSAGLIA MARCO	SPAZIO SPORT FORTE DEI MARMI		ITA - ITALY	
17	ALOISE LEONARDO	ASD LE ARTI NEW SCHOOL DOJO SHOTOKAN ROMA EST		ITA - ITALY	
17	CORVAGLIA SAMUELE	ASD ESERCITO - 187° FOLGORE		ITA - ITALY	
17	VACCA THOMAS	ASD TIGER S STYLE TEAM IODICE		ITA - ITALY	
17	GIOVAGNONI GIOELE	A.S.D. KARATESETTEVILLE		ITA - ITALY	
21	COLOMBI PIETRO	ATLAS KARATE		ITA - ITALY	
21	BELLASIO SEBASTIANO	KAIGI KARATE FITNESS A.S.D.		ITA - ITALY	
21	CARCHESIO JACOPO	ACCADEMIA TENRYU KARATE ASD		ITA - ITALY	
21	BARONI EDOARDO	ASD ESERCITO - 187° FOLGORE		ITA - ITALY	
25	NASSIVERA PIETRO	TSKS BELLUNO		ITA - ITALY	
25	ZANIRATO FRANCESCO	A.S.D. SEN SHIN KAI ROVIGO		ITA - ITALY	
25	TESORIATI ALESSANDRO	ASSOCIAZIONE SPORTIVA DILETTANTISTICA SHU REN KAN		ITA - ITALY	
25	ABBRUSCATO GABRIELE	CENTRO KARATE RICCIONE		ITA - ITALY	
29	PARI FABRIZIO	ASD RYUKO		ITA - ITALY	
29	ROSSI FRANCESCO	SSD POLISPORTIVA TERNANA		ITA - ITALY	

VENETO OPEN - 2023-05-19

Lista ufficiale dei risultati

29	RAPIS MASSIMO	ASD ESERCITO - 3° RGT AVES AQUILA		ITA - ITALY	
----	---------------	--------------------------------------	-----------------------------------------------------------------------------------	-------------	--

Kata Individual male Sen					
1	BINOTTO PIETRO	SPORT TARGET		ITA - ITALY	
2	GRAZIA MANUEL	G.S.FF.OO. POLIZIA DI STATO		ITA - ITALY	
3	POLSINELLI GUIDO	G.S.FF.OO. POLIZIA DI STATO		ITA - ITALY	
3	PANAGIA GIUSEPPE	G.S.FF.OO. POLIZIA DI STATO		ITA - ITALY	
5	PICCIONI EDOARDO	SSD POLISPORTIVA TERNANA		ITA - ITALY	
5	MATACCHIONI LUIGI	G.S.FF.OO. POLIZIA DI STATO		ITA - ITALY	
7	GAGLIO ANDREA	A.S.D. KARATESETTEVILLE		ITA - ITALY	
7	EDERAR KARIM	MASTER RAPID SKF CBL		ITA - ITALY	
9	BOMBARDI LEONARDO	MASTER RAPID SKF CBL		ITA - ITALY	
9	CICCHETTI LORENZO	A.S.D. KARATESETTEVILLE		ITA - ITALY	
11	BERLINGERIO JACOPO BRUNO	A.S.D. KARATESETTEVILLE		ITA - ITALY	
11	CORVAGLIA SAMUELE	ASD ESERCITO - 187° FOLGORE		ITA - ITALY	
13	ROSSI FRANCESCO	SSD POLISPORTIVA TERNANA		ITA - ITALY	
13	CARCHESIO JACOPO	ACCADEMIA TENRYU KARATE ASD		ITA - ITALY	
15	BARLETTA LEONARDO	MASTER RAPID SKF CBL		ITA - ITALY	
15	MANFIO ANDREA	A.S.D. SEN SHIN KAI ROVIGO		ITA - ITALY	
17	SENATORI ANDREA	ASD POLISPORTIVA TRE PIETRE FIRENZE		ITA - ITALY	
17	FOGLIENI GABRIELE	MASTER RAPID SKF CBL		ITA - ITALY	
17	COLOMBI PIETRO	ATLAS KARATE		ITA - ITALY	
17	CALDI LEONARDO	MASTER RAPID SKF CBL		ITA - ITALY	
21	GUERRINI MAURIZIO	ASD SHOURI TEAM KARATE		ITA - ITALY	
21	MORANDI ANDREA	ASD CISTELLUM JUDO KARATE		ITA - ITALY	
21	CORVAGLIA VINCENZO	ASD ESERCITO - 187° FOLGORE		ITA - ITALY	
21	CARUGATI CRISTIAN	JKS CASTANO PRIMO		ITA - ITALY	
25	PRIOLO RICCARDO	ASD KB CENTER 2000		ITA - ITALY	
25	ZANIRATO FRANCESCO	A.S.D. SEN SHIN KAI ROVIGO		ITA - ITALY	
25	CORONA MATTIA	ASD KARATE CAMAIORE		ITA - ITALY	
25	BOTANICI LUCA	A.S.D. KARATESETTEVILLE		ITA - ITALY	
29	BARONI EDOARDO	ASD ESERCITO - 187° FOLGORE		ITA - ITALY	

VENETO OPEN - 2023-05-19

Lista ufficiale dei risultati

29	BARBI SIMONE	JKS CASTANO PRIMO		ITA - ITALY	
29	NANNI GIACOMO	A.S.D. NENRJUKAN KARATE		ITA - ITALY	
29	DE MARCHI SERGIO	WMAC ITALIA		ITA - ITALY	
33	ZANGELIDIS CHRISTOS	FUNAKOSHI MILANO		ITA - ITALY	

Kata Individual male U14

1	NARDACCIO MATTEO	ASD FC MOREVILLA		ITA - ITALY	
2	DE MEO MARCO	AKS FIRENZE		ITA - ITALY	
3	MORETTI EROS	MASTER RAPID SKF CBL		ITA - ITALY	
3	TURCATO GIACOMO FILIPPO	SPORT TARGET		ITA - ITALY	
5	FREDA MATTEO	ASD TALARICO KARATE TEAM APS		ITA - ITALY	
5	BORROMETI OMAR	A.S.D. TIGER KARATE TEAM		ITA - ITALY	
7	QUATTROCCHI DANIELE	ASD TALARICO KARATE TEAM APS		ITA - ITALY	
7	LATTANZI CRISTIAN	A.S.D. KARATESETTEVILLE		ITA - ITALY	
9	PANFILE DAVID	SPAZIO SPORT FORTE DEI MARMI		ITA - ITALY	
9	ZANET THOMAS	ASD ATHLETIC KARATE DO AZZANO X		ITA - ITALY	
11	PAVAN SEBASTIANO	ASD SHOTOKAN KARATE POZZUOLO DEL FRIULI		ITA - ITALY	
11	DIPAOLA DIEGO	MASTER RAPID SKF CBL		ITA - ITALY	
13	MERLUZZO ANTONIO	UNIVERSAL TEAM - CSO ARCOBALENO		ITA - ITALY	
13	FERRI DANIELE	MASTER RAPID SKF CBL		ITA - ITALY	
15	GUZZETTI RICCARDO	A.S.D. MANTUANO KARATE TEAM		ITA - ITALY	
15	MASSIGNANI TOMMASO	ASD ESERCITO - 3° RGT AVES AQUILA		ITA - ITALY	
17	DI SANTE SIMONE	CENTRO KARATE RIMINI		ITA - ITALY	

Kata Individual male U21

1	POLSINELLI GUIDO	G.S.FF.OO. POLIZIA DI STATO		ITA - ITALY	
2	BINOTTO PIETRO	SPORT TARGET		ITA - ITALY	
3	GRAZIA MANUEL	G.S.FF.OO. POLIZIA DI STATO		ITA - ITALY	
3	PICCIONI EDOARDO	SSD POLISPORTIVA TERNANA		ITA - ITALY	
5	BERLINGERIO JACOPO BRUNO	A.S.D. KARATESETTEVILLE		ITA - ITALY	
5	GAGLIO ANDREA	A.S.D. KARATESETTEVILLE		ITA - ITALY	
7	GALEOTTI THOMAS	ASD TALARICO KARATE TEAM APS		ITA - ITALY	
7	FOGLIENI GABRIELE	MASTER RAPID SKF CBL		ITA - ITALY	

VENETO OPEN - 2023-05-19

Lista ufficiale dei risultati

9	MIRANDA MARIO	G.S.FF.OO. POLIZIA DI STATO		ITA - ITALY	
9	GAVIOLI CLAUDIO	MASTER RAPID SKF CBL		ITA - ITALY	
11	BARLETTA LEONARDO	MASTER RAPID SKF CBL		ITA - ITALY	
11	BARBI SIMONE	JKS CASTANO PRIMO		ITA - ITALY	
13	BOTANICI LUCA	A.S.D. KARATESETTEVILLE		ITA - ITALY	
13	MANFIO ANDREA	A.S.D. SEN SHIN KAI ROVIGO		ITA - ITALY	
15	ACQUAIOLI TOMMASO	AKS FIRENZE		ITA - ITALY	
15	NANNI GIACOMO	A.S.D. NENRJUKAN KARATE		ITA - ITALY	
17	ESPOSITO GABRIELE	ASD POLISPORTIVA TRE PIETRE FIRENZE		ITA - ITALY	

Kumite Individual female Cadets +61

1	DE VIVO ERMELINDA	SHIRAI CLUB S. VALENTINO		ITA - ITALY	
2	BOCCHIOLA NOEMI	KARATE POZZUOLO		ITA - ITALY	
3	PALUMBO VITTORIA PIA	OLIMPIA KARATE BERGAMO ASD		ITA - ITALY	
3	APUZZO AURORA	ASD TIGER S STYLE TEAM IODICE		ITA - ITALY	
5	GRIECO LUCREZIA	A.S.D. TIGER KARATE TEAM		ITA - ITALY	
5	MONTANARI ALESSIA MARINA	ASD LEONI KARATE TEAM		ITA - ITALY	
7	RONCAGLIA GIULIA	KARATE ALTO VICENTINO		ITA - ITALY	
7	FUSO VERONICA	ASD YAMAGUCHI		ITA - ITALY	

Kumite Individual female Cadets -47

1	GANDOLA GRETA	CLUB ARTI ORIENTALI CANTU ASD		ITA - ITALY	
2	CAPATTI GIADA	ASD TALARICO KARATE TEAM APS		ITA - ITALY	
3	MURGIA ALESSIA	ASD CINTURA NERA KARATE		ITA - ITALY	
3	LEONE ILARIA	ASSOCIAZIONE SPORTIVA DILETTANTISTICA LEONE		ITA - ITALY	
5	GIORDANO AURORA	ASD TALARICO KARATE TEAM APS		ITA - ITALY	
5	CHIAPPARELLI GIADA	A.S.D. JOHNNYS KARATE BORGO SISA		ITA - ITALY	
7	SEVERINO GIUSTINA	UNIVERSAL CENTER		ITA - ITALY	

Kumite Individual female Cadets -54

1	LUCIANI SIRIA	A.S.D. POLISPORTIVA TEVERE		ITA - ITALY	
2	CAPONE BIANCA	A.S.D. SHIZOKU KARATE AVELLINO		ITA - ITALY	

VENETO OPEN - 2023-05-19

Lista ufficiale dei risultati

3	GANDOLA VIOLA	CLUB ARTI ORIENTALI CANTU ASD		ITA - ITALY	
3	BALNEARE LUDOVICA	TEAM KARATE LENTINI		ITA - ITALY	
5	BURZO CAROLINA	ASD JUDO KARATE CLUB		ITA - ITALY	
5	ALOISI GISELLA	SPORT TARGET		ITA - ITALY	
7	CORSARO BENEDETTA	ASD TALARICO KARATE TEAM APS		ITA - ITALY	
7	LEONI ADELE	A.S.D. JOHNNYS KARATE BORGO SISA		ITA - ITALY	
9	MAZZOTTA NOEMI	S.S.DILETTANTISTICA C.K.S. 2000		ITA - ITALY	
9	EL ASRI KHADIJA	OLIMPIA KARATE BERGAMO ASD		ITA - ITALY	

Kumite Individual female Cadets -61

1	CATTANEO ELISA	CLUB ARTI ORIENTALI CANTU ASD		ITA - ITALY	
2	MUSSO ROBERTA	KARATE CLUB SAVONA		ITA - ITALY	
3	ANSELMI CHIARA	A.S.D. CHAMPION CENTER		ITA - ITALY	
3	CHEROUAI BASMA	MASTER RAPID SKF CBL		ITA - ITALY	
5	BERTON EMMA	A.S.D. SHOTOKAN KARATE RYU VENEZIA		ITA - ITALY	
5	SALVI CATERINA	ASD CENTRO STUDI KARATE NEGRAR		ITA - ITALY	
7	BISOL GIULIA	ASS. CENTRO SPORTIVO SAKURA		ITA - ITALY	
7	CANEVA SARA	CENTRO SPORTIVO KARATE WADO RYU ROMA		ITA - ITALY	
9	SADLER CLAUDIA	KARATE TRENTO ASD		ITA - ITALY	

Kumite Individual female Juniors +66

1	FICHERA CARLA	ASD SHOTOKAN ACIREALE		ITA - ITALY	
2	MUROLO FRANCESCA PIA	ASD NIPPON CLUB NAPOLI KARATE		ITA - ITALY	
3	MONTEBELLO CARLOTTA	ASD TALARICO KARATE TEAM APS		ITA - ITALY	
3	FARINA ANNA	NADIR TRATTI D ORIENTE SSD		ITA - ITALY	
5	SIBONA MARIA	ASD TIGER S STYLE TEAM IODICE		ITA - ITALY	
5	BETTINI SOFIA	BUDOKAN MONTELUPO		ITA - ITALY	
7	MILLIACCIO VERONICA	A.S.D. SHOTOKAN KARATE RYU VENEZIA		ITA - ITALY	
7	LUGATO MARIA SOFIA	KARATE SPORTING TEAM		ITA - ITALY	

VENETO OPEN - 2023-05-19

Lista ufficiale dei risultati

Kumite Individual female Juniors -48				
1	BIFULCO ASIA	A.S.D. CHAMPION CENTER		ITA - ITALY
2	FEDERICI CAROLA	KARATE DOSCHI ASS.NE SPORTIVA DILETTANTISTICA		ITA - ITALY
3	BOSSI ALESSANDRA	SKORPION KARATE ASD		ITA - ITALY
3	DE FALCO ASIA	G.S.FF.OO. POLIZIA DI STATO		ITA - ITALY
5	BRIGNONE GIORGIA	KARATE CLUB SAVONA		ITA - ITALY
5	ANDREOTTOLA LAURA	A.S.D. SHIZOKU KARATE AVELLINO		ITA - ITALY
7	CAPPAI AMBRA	ASD TALARICO KARATE TEAM APS		ITA - ITALY
7	MASOCH MARIACHIARA	KARATE TEAM DOLOMITI		ITA - ITALY

Kumite Individual female Juniors -53				
1	MARRUCCI VALENTINA	ASD TALARICO KARATE TEAM APS		ITA - ITALY
2	PIANTINI CATERINA	TEAM KARATE PULEO FIRENZE		ITA - ITALY
3	SCLERANDI NOEMI	G.S.FF.OO. POLIZIA DI STATO		ITA - ITALY
3	COLLETTI EMMA	TEAM KARATE LENTINI		ITA - ITALY
5	BURZO FRANCESCA	ASD JUDO KARATE CLUB		ITA - ITALY
5	BARONE MIRYAM	ASD REMBUKAN KARATE VILLASMUNDO		ITA - ITALY
7	CARUGGI ALICE	POLIHANDY ASD		ITA - ITALY

Kumite Individual female Juniors -59				
1	MARTURANO IRENE	TEAM KARATE LENTINI		ITA - ITALY
2	CAPITANIO MATILDE	KARATE TRENTO ASD		ITA - ITALY
3	ALOISIO GIADA	ASD INTERNATIONAL PALADANZE		ITA - ITALY
3	CRAIU BIATRIS IONELA	ASD LE ARTI NEW SCHOOL DOJO SHOTOKAN ROMA EST		ITA - ITALY
5	FAVARATO MATILDE	A.S.D SEN SHIN KAI PADOVA		ITA - ITALY
5	CARTA BEATRICE	CSKT KARATE TEAM		ITA - ITALY
7	DUCA GIORGIA	FORZA E COSTANZA - BRESCIA		ITA - ITALY
7	BALLESTRIERI SOFIA	LUCIANO BADERNA		ITA - ITALY
9	ZAMBELLI RACHELE	TSKS BELLUNO		ITA - ITALY

Kumite Individual female Juniors -66				
1	FANELLI AURORA	SKORPION KARATE ASD		ITA - ITALY
2	CORNOLO GIADA	KARATE NAKAYAMA		ITA - ITALY

VENETO OPEN - 2023-05-19

Lista ufficiale dei risultati

3	GIORDANI PAOLA	KARATE CLUB SAVONA		ITA - ITALY	
3	GIRARDI MICHELA	CENTRO SPORTIVO KARATE WADO RYU ROMA		ITA - ITALY	
5	DI PIETRO ANNA	NAPOLI		ITA - ITALY	

Kumite Individual female Seniors +68

1	GENTILE GIORGIA	ASD TALARICO KARATE TEAM APS		ITA - ITALY	
2	BALLESTRIERI CAMILLA	LUCIANO BADERNA		ITA - ITALY	
3	BOER CATIA	POLISPORTIVA KARATE MOGLIANO		ITA - ITALY	
3	FERRI AURORA	GIN. ANGEL FIUMICINO		ITA - ITALY	
5	BROGNOLI GRETA	ASD KARATE GENOCCHIO		ITA - ITALY	
5	FEBO MELISSA	ENERGIA IN MOVIMENTO SSD ARL		ITA - ITALY	

Kumite Individual female Seniors -50

1	SCHICCHI FEDERICA	ASD TALARICO KARATE TEAM APS		ITA - ITALY	
2	PERINA CAMILLA	MASTER RAPID SKF CBL		ITA - ITALY	
3	DANGELO ELISA	GIN. ANGEL FIUMICINO		ITA - ITALY	
3	MORRA FRANCESCA	ACCADEMIA KARATE UNION TEAM		ITA - ITALY	
5	MICELI NICOLE	LUCIANO BADERNA		ITA - ITALY	

Kumite Individual female Seniors -55

1	DE ROSA NOEMI	KARATE CLUB SAVONA		ITA - ITALY	
2	PEDERIVA PAOLA	ASD KARATE CLUB VALDOBBIADENE CROCETTA		ITA - ITALY	
3	TAGLIO ALESSIA	ASD TALARICO KARATE TEAM APS		ITA - ITALY	
3	GAGLIOTI FRANCESCA	ASD ACCADEMIA KARATE AREZZO		ITA - ITALY	
5	LORENZET LISA	ASD APAM		ITA - ITALY	

Kumite Individual female Seniors -61

1	DESTE FEDERICA	ASD KARATE 2001		ITA - ITALY	
2	PENDOLI AURORA	MASTER RAPID SKF CBL		ITA - ITALY	
3	CESANELLI GIADA	CESANELLI		ITA - ITALY	

Kumite Individual female Seniors -68

1	GUERRINI ALICE	KARATE POLISPORTIVA BREMBATE SOPRA		ITA - ITALY	
---	----------------	------------------------------------	-------------------------------------------------------------------------------------	-------------	--

VENETO OPEN - 2023-05-19

Lista ufficiale dei risultati

Kumite Individual female U14 +52				
1	DE VIVO ANNACHIARA	SHIRAI CLUB S. VALENTINO		ITA - ITALY
2	MANGIAPIA MARIANNA	A.S.D. SHIZOKU KARATE AVELLINO		ITA - ITALY
3	DI STEFANO LAVINIA	ASD TALARICO KARATE TEAM APS		ITA - ITALY
3	PASIN MATILDE	KARATE POZZUOLO		ITA - ITALY
5	VANDI GINEVRA	CENTRO KARATE RICCIONE		ITA - ITALY
5	BALLABIO DELIA	A.S.D. KARATE WA YU KAI GIUSSANO		ITA - ITALY
7	DORIA BEATRICE	A.S.D. SHOTOKAN KARATE RYU VENEZIA		ITA - ITALY
7	ULINICI NICOLETA	A.S.D. SHOTOKAN KARATE RYU VENEZIA		ITA - ITALY
9	MAGGIO ELEONORA	LIGURIA_KARATE_FUNA SPEZIA		ITA - ITALY
9	BARBIERO ANDREA LORY	A.S.D. ASI KARATE VENETO		ITA - ITALY

Kumite Individual female U14 -42				
1	PAVONE SOFIA	KARATE POZZUOLO		ITA - ITALY
2	GALATI VITTORIA	KARATE CLUB SAVONA		ITA - ITALY
3	PRYNDIUK ANASTASIA	ASD KARATE CLUB VALDOBBIADENE CROCETTA		ITA - ITALY
3	CAMPO ARIANNA	KARATE CLUB SAVONA		ITA - ITALY
5	CESCUT EMMA	CENTRO KARATE RICCIONE		ITA - ITALY
5	LONGO VALENTINA	A.S.D KI-OSHI		ITA - ITALY
7	GRAZIANI DIANA	G.S.FF.OO. POLIZIA DI STATO		ITA - ITALY
7	BUONFIGLIO ROBERTA	G.S.FIAMME CREMISI BERSAGLIERI FOGGIA		ITA - ITALY
9	POZZA MARTA	A.S.D. FUJI-YAMA KARATE-DO SETTE COMUNI		ITA - ITALY
9	PICCARDI DILETTA	LIGURIA_KARATE_FUNA SPEZIA		ITA - ITALY

Kumite Individual female U14 -47				
1	CARDONE MARTINA	ASD CENTRO SPORTIVO TEODORO MONTEPARANO		ITA - ITALY
2	VETTORETTI GIADA	ASD KARATE CLUB VALDOBBIADENE CROCETTA		ITA - ITALY
3	BUTINI MARGHERITA	MENS SANA SIENA		ITA - ITALY
3	GRANELLI GAIA	CENTRO SPORTIVO FARNESIANA KARATE PIACENZA		ITA - ITALY
5	PARONETTO GIORGIA	ASD KARATE 2001		ITA - ITALY

VENETO OPEN - 2023-05-19

Lista ufficiale dei risultati

5	TODESCO LETIZIA	A.S.D. JISEI BUDO A.M.I.		ITA - ITALY	
7	EL KOREICHI LAILA	ASD ESERCITO - 3° RGT AVES AQUILA		ITA - ITALY	

Kumite Individual female U14 -52

1	PEDRETTI ASIA	MASTER RAPID SKF CBL		ITA - ITALY	
2	MARENCO MAYA	KARATE CLUB SAVONA		ITA - ITALY	
3	ROSSANO FEDERICA CARMELA	A.S.D. SHIZOKU KARATE AVELLINO		ITA - ITALY	
3	GIRALDI LAURA	A.S.D. MILLENNIUM KARATE		ITA - ITALY	
5	LONGERI AURORA	CENTRO SPORTIVO FARNESIANA KARATE PIACENZA		ITA - ITALY	
5	DALLAVALLE EVA	CENTRO SPORTIVO FARNESIANA KARATE PIACENZA		ITA - ITALY	
7	PELUCCO CHIARA	FORZA E COSTANZA - BRESCIA		ITA - ITALY	
7	GIRELLO ALESSANDRA	ASD TALARICO KARATE TEAM APS		ITA - ITALY	

Kumite Individual female U21 +68

1	FERRI AURORA	GIN. ANGEL FIUMICINO		ITA - ITALY	
2	PERGOLES I AURORA	TEAM KARATE PULEO FIRENZE		ITA - ITALY	
3	DE GREGORI CHIARA	A.S.D. SHOTOKAN KARATE RYU VENEZIA		ITA - ITALY	
4	SANTI NOEMI	LIGURIA_KARATE_FUNA SPEZIA		ITA - ITALY	

Kumite Individual female U21 -50

1	DANGELO ELISA	GIN. ANGEL FIUMICINO		ITA - ITALY	
2	VITALI VERONICA	FORZA E COSTANZA - BRESCIA		ITA - ITALY	
3	BROSSA SARA	A.S.D. SHOTOKAN KARATE RYU VENEZIA		ITA - ITALY	
3	MORRA FRANCESCA	ACCADEMIA KARATE UNION TEAM		ITA - ITALY	
5	DE ANGELIS MARTINA	G.S.FF.OO. POLIZIA DI STATO		ITA - ITALY	
5	GJORGIEVA ANELIA	ASD KARATE GENOCCHIO		ITA - ITALY	

Kumite Individual female U21 -55

1	GAFFORELLI ELISA	ASD ESERCITO - 3° RGT AVES AQUILA		ITA - ITALY	
2	CECERE MARIKA	A.T. KARATE CLUB ROMA		ITA - ITALY	
3	DAPAS VANESSA	ACSD BUDO LACASSIA TORINO		ITA - ITALY	
3	DI DOMENICO CHIARA	UNIVERSAL CENTER		ITA - ITALY	

VENETO OPEN - 2023-05-19

Lista ufficiale dei risultati

5	RIVADOSSI GRETA	KARATE NAKAYAMA		ITA - ITALY	
5	TOMMASI AGNESE	ASD CENTRO STUDI KARATE NEGRAR		ITA - ITALY	
7	GUERINI ANNA	FORZA E COSTANZA - BRESCIA		ITA - ITALY	
7	FERRARO ELISABETTA	MENS SANA SIENA		ITA - ITALY	

Kumite Individual female U21 -61

1	PENDOLI AURORA	MASTER RAPID SKF CBL		ITA - ITALY	
2	IPPOLITO ASIA	ASD ESERCITO - 3° RGT AVES AQUILA		ITA - ITALY	
3	DESTE FEDERICA	ASD KARATE 2001		ITA - ITALY	
3	BAVUSO MARIA STEFANIA	ASD LIBERTAS CLUB LAVELLO		ITA - ITALY	
5	MANICARDI VITTORIA	ASD LEONI KARATE TEAM		ITA - ITALY	

Kumite Individual female U21 -68

1	SIMONINI VALENTINA	FORZA E COSTANZA - BRESCIA		ITA - ITALY	
2	BELLINELLI MELANIA	BODYMIND KARATE		ITA - ITALY	
3	GUERRINI ALICE	KARATE POLISPORTIVA BREMBATE SOPRA		ITA - ITALY	
3	FREGONESE MARTINA	ASD DEFENCE KARATE 2000 PRAVISDOMINI		ITA - ITALY	
5	OLMASTRONI ADELE	MENS SANA SIENA		ITA - ITALY	

Kumite Individual male Cadets +70

1	VERRASTRO RICCARDO	ASD TALARICO KARATE TEAM APS		ITA - ITALY	
2	RISITO MATTEO	AKS FIRENZE		ITA - ITALY	
3	LIBERTI SANTINO	ACCADEMIA KARATE UNION TEAM		ITA - ITALY	
3	TESTA DANIELE	KARATE CLUB SAVONA		ITA - ITALY	
5	OSELLI TOMMASO	ASD LE ARTI NEW SCHOOL DOJO SHOTOKAN ROMA EST		ITA - ITALY	
5	TOMA GESON	A.S.D. MASTER FITNESS		ITA - ITALY	
7	BERTI RAFAEL	ASD KARATE CENTER BOLOGNA		ITA - ITALY	
7	PAOLINI YARI	BODYMIND KARATE		ITA - ITALY	
9	RIZZO ALESSANDRO	EAGLES CLUB 2007		ITA - ITALY	

Kumite Individual male Cadets -52

1	CITI JACOPO	ASD ESERCITO - 187° FOLGORE		ITA - ITALY	
2	ZECCHINO ALAN	AKS FIRENZE		ITA - ITALY	
3	BUSI LORENZO	ASD LEONI KARATE TEAM		ITA - ITALY	

VENETO OPEN - 2023-05-19

Lista ufficiale dei risultati

3	GIULIANO MATTEO	ASD TREVISO KARATE		ITA - ITALY	
5	PAOLETTI NICCOLÒ	BODYMIND KARATE		ITA - ITALY	
5	SPILINGA CHRISTIAN	FUNAKOSHI 1976 ASD		ITA - ITALY	
7	FALORNI ANDREA	ASD SHINGITAI PISA		ITA - ITALY	
7	DUCA LEONARDO	FORZA E COSTANZA - BRESCIA		ITA - ITALY	
9	SLAVAZZA SIMONE	YOSEIKAN KARATE OPEN WKF		ITA - ITALY	

Kumite Individual male Cadets -57

1	DE STEFANO EMANUELE	A.S.D. SHIZOKU KARATE AVELLINO		ITA - ITALY	
2	SERINO SALVATORE	UNIVERSAL CENTER		ITA - ITALY	
3	TORNICASA FRANCESCO	ASS.NAZ.CARAB. CAPASSO1		ITA - ITALY	
3	ZANNI FEDERICO	KARATE POZZUOLO		ITA - ITALY	
5	NAVARRA FRANCESCO	ASD INTERNATIONAL PALADANZE		ITA - ITALY	
5	MOI GIOELE	ASD KARATE TEAM 1999		ITA - ITALY	
7	DE PASQUALE LUCA	ASD KARATE TEAM 1999		ITA - ITALY	
7	GENTA JACOPO	KARATE CLUB SAVONA		ITA - ITALY	
9	VOLPATO CHRISTIAN	A.S.D. ASI KARATE VENETO		ITA - ITALY	
9	MONTORO ORESTE	NADIR TRATTI D ORIENTE SSD		ITA - ITALY	

Kumite Individual male Cadets -63

1	AVOLIO FRANCESCO	UNIVERSAL CENTER		ITA - ITALY	
2	PANICO VALENTINO	ASD CENTRO SPORTIVO TEODORO MONTEPARANO		ITA - ITALY	
3	DI BARI DANIEL ANTONIO	A.S.D. DOJO TAKA TORA		ITA - ITALY	
3	RUSSOMANNO GIOELE ANTONIO	SHIRAI CLUB S. VALENTINO		ITA - ITALY	
5	CARRARESI ALESSANDRO	ASD TALARICO KARATE TEAM APS		ITA - ITALY	
5	CASTELLAZZI CHRISTIAN	ASD LEONI KARATE TEAM		ITA - ITALY	
7	SIA ERIC	ASD DRAGON KARATE		ITA - ITALY	
7	PAPPAPCENA GIUSEPPE	NADIR TRATTI D ORIENTE SSD		ITA - ITALY	
9	PELUCCO CRISTIAN	FORZA E COSTANZA - BRESCIA		ITA - ITALY	
9	SANTUCCI DARIO	G.S.FF.OO. POLIZIA DI STATO		ITA - ITALY	

Kumite Individual male Cadets -70

1	TONIOLO ALVISE	SPORT TARGET		ITA - ITALY	
2	FERRARINI FRANCESCO	ASD JUDO KARATE CLUB		ITA - ITALY	

VENETO OPEN - 2023-05-19

Lista ufficiale dei risultati

3	BASILE MANUEL	ASD INTERNATIONAL PALADANZE		ITA - ITALY	
3	MONDINI LUCA	KARATE CAMUNO CHINTE		ITA - ITALY	
5	REALINI NICCOLO	ASD KARATE GENOCCHIO		ITA - ITALY	
5	DE LAZZER LEONARDO	TSKS BELLUNO		ITA - ITALY	
7	NICOLAI RICCARDO	AI DAI CLUB VILLA ADRIANA		ITA - ITALY	
7	SALUSSOLIA FRANCESCO	FUNAKOSHI 1976 ASD		ITA - ITALY	
9	BUONFIGLIO ALESSANDRO	G.S.FIAMME CREMISI BERSAGLIERI FOGGIA		ITA - ITALY	
9	D AZZO LIBORIO	TEAM KARATE LENTINI		ITA - ITALY	

Kumite Individual male Juniors +76

1	SUPINO FEDERICO	SSD BRACELLI CLUB		ITA - ITALY	
2	DOVERA GABRIELE	ASD KEN KO PIOBESI		ITA - ITALY	
3	BURROSI SAMUELE	ASD INTERNATIONAL PALADANZE		ITA - ITALY	
3	MARTELLINI NICHOLAS	ASD FOLIGNO,KARATE CLUB,		ITA - ITALY	
5	GUERRIERO NICOLA	A.S.D. ASI KARATE VENETO		ITA - ITALY	
5	ULQINAKU LEONARDO	AKS FIRENZE		ITA - ITALY	
7	MAIORINO PIETRO	ASD TIGER S STYLE TEAM IODICE		ITA - ITALY	
7	POPOVICH VICTORIO	A.S.D. LENE TEAM SARNATARO KARATE		ITA - ITALY	

Kumite Individual male Juniors -55

1	SQUILLANTE GUIDO	SHIRAI CLUB S. VALENTINO		ITA - ITALY	
2	DAIDONE FILIPPO	A.D.P. CHAMPIONS		ITA - ITALY	
3	ALFANO NICOLÒ	TEAM KARATE LENTINI		ITA - ITALY	
3	CELENTANO ANTONIO	SHIRAI CLUB S. VALENTINO		ITA - ITALY	
5	AURELI LEONARDO	ASD LE ARTI NEW SCHOOL DOJO SHOTOKAN ROMA EST		ITA - ITALY	
5	BENISON MEHMI	ASD ESERCITO - 3° RGT AVES AQUILA		ITA - ITALY	
7	GOZZI CARLO	FUNAKOSHI 1976 ASD		ITA - ITALY	
7	PAGNOTTA ALESSANDRO	ASD FC MOREVILLA		ITA - ITALY	

Kumite Individual male Juniors -61

1	LEONE GIUSEPPE	ASSOCIAZIONE SPORTIVA DILETTANTISTICA LEONE		ITA - ITALY	
2	CALIFANO EMANUELE	SHIRAI CLUB S. VALENTINO		ITA - ITALY	

VENETO OPEN - 2023-05-19

Lista ufficiale dei risultati

3	ODELLO ANDREA	KARATE CLUB SAVONA		ITA - ITALY	
3	GIORDANO FABRIZIO	ASD TALARICO KARATE TEAM APS		ITA - ITALY	
5	CAPUOZZO SALVATORE	UNIVERSAL CENTER		ITA - ITALY	
5	NASSER PAOLO	ASD TALARICO KARATE TEAM APS		ITA - ITALY	
7	ANGELONI ALESSANDRO	G.S.FF.OO. POLIZIA DI STATO		ITA - ITALY	
7	IZZO GIANMARCO	A.T. KARATE CLUB ROMA		ITA - ITALY	

Kumite Individual male Juniors -68

1	KOROTENKO MICHAIL	SHIRAI CLUB S. VALENTINO		ITA - ITALY	
2	CALIFANO PIETRO PIO	SHIRAI CLUB S. VALENTINO		ITA - ITALY	
3	LOFFREDO FRANCESCO	A.S.D. SHIZOKU KARATE AVELLINO		ITA - ITALY	
3	CASALINI YARI	G.S.FF.OO. POLIZIA DI STATO		ITA - ITALY	
5	PENDINI TOMMASO	A.S.D SEN SHIN KAI PADOVA		ITA - ITALY	
5	UNGARETTI GABRIELE	BODYMIND KARATE		ITA - ITALY	
7	PAOLETTI MATTIA	BODYMIND KARATE		ITA - ITALY	
7	DA RIN LORIS	TSKS BELLUNO		ITA - ITALY	
9	SERGI ELIA	KARATE CLUB SAVONA		ITA - ITALY	

Kumite Individual male Juniors -76

1	PIGNATIELLO LUIGI	UNIVERSAL CENTER		ITA - ITALY	
2	BOZZI ANDREA	ASD ESERCITO - 187° FOLGORE		ITA - ITALY	
3	VESCO NATAN	CENTRO KARATE RICCIONE		ITA - ITALY	
3	SPIAZZI MATTEO	ASD KARATE TEAM 1999		ITA - ITALY	
5	COLECCHIA DANIELE	G.S.FIAMME CREMISI BERSAGLIERI FOGGIA		ITA - ITALY	
5	DE GREGORI MATTIA	A.S.D. SHOTOKAN KARATE RYU VENEZIA		ITA - ITALY	
7	BARBAN FRANCESCO	A.S.D. ASI KARATE VENETO		ITA - ITALY	
7	BERTOLUCCI GIANMARCO	BODYMIND KARATE		ITA - ITALY	

Kumite Individual male Seniors +84

1	MAZZOLENI FABIO	KARATE POLISPORTIVA BREMBATE SOPRA		ITA - ITALY	
2	RIFUGIO LORENZO	MASTER RAPID SKF CBL		ITA - ITALY	
3	GATTO ALESSANDRO	SPORT TARGET		ITA - ITALY	
3	ROMANINI GIORGIO	KYOHAN SIMMI		ITA - ITALY	

VENETO OPEN - 2023-05-19

Lista ufficiale dei risultati

Kumite Individual male Seniors -60					
1	LANDI MATTEO	MASTER RAPID SKF CBL		ITA - ITALY	
2	NANOCCHIO GIUSEPPE	ASD TALARICO KARATE TEAM APS		ITA - ITALY	
3	AGLIANO SAMUELE	KARATE POZZUOLO		ITA - ITALY	
4	PAGOS LORENZO	ASD KARATE SACILE		ITA - ITALY	

Kumite Individual male Seniors -67					
1	ANDRETTA GIACOMO	SPORT TARGET		ITA - ITALY	
2	CARUANA LORENZO	DYNAMIC KARATE ASD		ITA - ITALY	
3	PIGNATTI FRANCESCO	ASD LEONI KARATE TEAM		ITA - ITALY	
3	DE FRANCESCO LUIGI	UNIVERSAL CENTER		ITA - ITALY	
5	BITICI LIRIDON	SPORT TARGET		ITA - ITALY	
5	VARRIALE LUCA	A.S.D. CHAMPION CENTER		ITA - ITALY	

Kumite Individual male Seniors -75					
1	GASPARETTO DAVIDE	SPORT TARGET		ITA - ITALY	
2	MIO DANNY	ASD DEFENCE KARATE 2000 PRAVISDOMINI		ITA - ITALY	
3	PENDOLI EMANUELE	MASTER RAPID SKF CBL		ITA - ITALY	
3	MINERVINO GIUSEPPE	SPORT TARGET		ITA - ITALY	
5	OSTI FABRIZIO	CENTRO YOSHITAKA		ITA - ITALY	

Kumite Individual male Seniors -84					
1	MILANTA RAFFAELLO	TEAM KARATE PULEO FIRENZE		ITA - ITALY	
2	MORALDI AMUN ENEA	TEAM KARATE PULEO FIRENZE		ITA - ITALY	
3	PARISI LORENZO	G.S.FF.OO. POLIZIA DI STATO		ITA - ITALY	

Kumite Individual male U14 +55					
1	DEL SEPPIA GIACOMO	GOLDEN TIGER TEAM KARATE - MUAY THAI		ITA - ITALY	
2	GIULIANO SIMONE	CLUB ARTI ORIENTALI CANTU ASD		ITA - ITALY	
3	ROSSINIELLO KEVIN PIO	G.S.FIAMME CREMISI BERSAGLIERI FOGGIA		ITA - ITALY	
3	SCALA FRANCESCO	A.S.D. KARATESETTEVILLE		ITA - ITALY	
5	MAFFOLINI ALESSANDRO	MASTER RAPID SKF CBL		ITA - ITALY	
5	RORATO TOMMASO	KARATE SPORTING TEAM		ITA - ITALY	
7	RAVASIO MATTIA	KARATE POLISPORTIVA BREMBATE SOPRA		ITA - ITALY	

VENETO OPEN - 2023-05-19

Lista ufficiale dei risultati

7	FANTINI FRANCESCO	ASD SHINGITAI PISA		ITA - ITALY	
---	-------------------	--------------------	-----------------------------------------------------------------------------------	-------------	--

Kumite Individual male U14 -40

1	PONTIL SCALA LORENZO	TSKS BELLUNO		ITA - ITALY	
2	FERRARIS GIACOMO	KARATE CLUB SAVONA		ITA - ITALY	
3	VACCA MATTEO	G.S.FF.OO. POLIZIA DI STATO		ITA - ITALY	
3	GASPARINI VALERIO	G.S.FF.OO. POLIZIA DI STATO		ITA - ITALY	
5	GARDINI CHRISTIAN	KARATE POZZUOLO		ITA - ITALY	
5	GULIN GABRIELE	ASD CINTURA NERA KARATE		ITA - ITALY	
7	CORBANESE ENRICO	ASD KARATE CLUB VALDOBBIADENE CROCETTA		ITA - ITALY	
7	NANNINI LEONARDO	ASD ESERCITO - 187° FOLGORE		ITA - ITALY	



Kumite Individual male U14 -45

1	NASSER DIEGO	ASD TALARICO KARATE TEAM APS		ITA - ITALY	
2	MARRUCCI FILIPPO	ASD TALARICO KARATE TEAM APS		ITA - ITALY	
3	TESTA ALESSANDRO	KARATE LION		ITA - ITALY	
3	FORNARI ALESSANDRO	KARATE CLUB SAVONA		ITA - ITALY	
5	PASQUALETTO DAVIDE	SPORT TARGET		ITA - ITALY	
5	DI NARDO MATTIA	SPORT TARGET		ITA - ITALY	
7	BORTOLIERO MANUEL	KARATE COLLI EUGANEI		ITA - ITALY	
7	MONICO LEONARDO	KARATE BORBIAGO VE		ITA - ITALY	

Kumite Individual male U14 -50

1	RABIEA RAIAN FARGHALI	OLIMPIA KARATE BERGAMO ASD		ITA - ITALY	
2	BALDASSARRE RAFFAELE	KARATE BALDASSARRE		ITA - ITALY	
3	FIOREMISTO MATTIA	ASD_DINAMO_KARATE		ITA - ITALY	
3	DE GREGORIO RICCARDO	ASD BUSHINKAI		ITA - ITALY	
5	ATTIANESE FRANCESCO	NADIR TRATTI D ORIENTE SSD		ITA - ITALY	
5	CAMEROTA ISAAC MATTIA	ASD CINTURA NERA KARATE		ITA - ITALY	
7	MACCIONI SANTINI NICCOLO	GOLDEN TIGER TEAM KARATE - MUAY THAI		ITA - ITALY	
7	FURFARI GIUSEPPE ANTONIO	ASD CLUB FUNAKOSHI		ITA - ITALY	

Kumite Individual male U14 -55

1	CAPELLI RICCARDO	KARATE POLISPORTIVA BREMBATE SOPRA		ITA - ITALY	
2	SCARICO MARIO	UNIVERSAL TEAM - CSO ARCOBALENO		ITA - ITALY	

VENETO OPEN - 2023-05-19

Lista ufficiale dei risultati

3	PAGANO EMILIO	A.S.D. SHIZOKU KARATE AVELLINO		ITA - ITALY	
3	SEGANTINI ANDREA	YOSEIKAN KARATE OPEN WKF		ITA - ITALY	
5	FERRI DANIELE	MASTER RAPID SKF CBL		ITA - ITALY	
5	CECCHINI JACOPO	A.S.D.KARATE VENEZIA		ITA - ITALY	
7	BIZZARRI GIACOMO	A.S.D. TIGER KARATE TEAM		ITA - ITALY	
7	SERA SIMONE	KARATE TRENTO ASD		ITA - ITALY	
9	MUCCIGNAT ALBERTO	ASD KARATE CLUB KANAZAWA		ITA - ITALY	
9	NEGRIZZOLO PIETRO	CENTRO YOSHITAKA		ITA - ITALY	

Kumite Individual male U21 +84

1	GAGGIO NICOLÒ	A.S.D. SHOTOKAN KARATE RYU VENEZIA		ITA - ITALY	
2	ROSCIGLIONI JONATHAN	A.S.D. DOJO KARATE WADORYU SPINEA		ITA - ITALY	
3	PUPPO MATTEO	ASD TALARICO KARATE TEAM APS		ITA - ITALY	
3	DAN LEONARD	ASD FOLIGNO,KARATE CLUB,		ITA - ITALY	
5	LACASSIA LEONARDO	ACSD BUDO LACASSIA TORINO		ITA - ITALY	

Kumite Individual male U21 -60

1	AGUS MARIO	A.T. KARATE CLUB ROMA		ITA - ITALY	
2	PIERBATTISTI RICCARDO	ASD FOLIGNO,KARATE CLUB,		ITA - ITALY	
3	NANOCCHIO GIUSEPPE	ASD TALARICO KARATE TEAM APS		ITA - ITALY	
3	AGLIANO SAMUELE	KARATE POZZUOLO		ITA - ITALY	
5	REDJEPI ARIAN	KARATE TRENTO ASD		ITA - ITALY	

Kumite Individual male U21 -67

1	RAMOS MATT	ASD TALARICO KARATE TEAM APS		ITA - ITALY	
2	LORENZETTI TOMMASO	ASD TALARICO KARATE TEAM APS		ITA - ITALY	
3	QUACECI ALFIO	ASD KARATE TEAM 1999		ITA - ITALY	
3	RUFINI SAMUELE	TEAM KARATE PULEO FIRENZE		ITA - ITALY	
5	RUFINI ALESSIO	TEAM KARATE PULEO FIRENZE		ITA - ITALY	
5	PIGNATTI FRANCESCO	ASD LEONI KARATE TEAM		ITA - ITALY	
7	CAMBRUZZI ALESSIO	SPORT TARGET		ITA - ITALY	
7	CARUANA LORENZO	DYNAMIC KARATE ASD		ITA - ITALY	

VENETO OPEN - 2023-05-19















































Lista ufficiale dei risultati

Kumite Individual male U21 -75					
1	COPPOLA ALESSANDRO	ASD TALARICO KARATE TEAM APS		ITA - ITALY	
2	DE CHIRICO PAOLO	KYOHAN SIMMI		ITA - ITALY	
3	PENDOLI EMANUELE	MASTER RAPID SKF CBL		ITA - ITALY	
3	CHERCHI NICOLÒ	A.S.D. KARATESETTEVILLE		ITA - ITALY	
5	LOMBARDI LAPO	TEAM KARATE PULEO FIRENZE		ITA - ITALY	
5	MARTELLINI SAMUEL	ASD FOLIGNO,KARATE CLUB,		ITA - ITALY	
7	CIOMEI FILIPPO	BODYMIND KARATE		ITA - ITALY	
7	OSTI FABRIZIO	CENTRO YOSHITAKA		ITA - ITALY	

Kumite Individual male U21 -84					
1	LUCIANI DAVIDE	A.S.D. POLISPORTIVA TEVERE		ITA - ITALY	
2	BRESSANELLO RICCARDO	A.S.D. SHOTOKAN KARATE RYU VENEZIA		ITA - ITALY	
3	PARISI LORENZO	G.S.FF.OO. POLIZIA DI STATO		ITA - ITALY	
3	VIVALDA SIMONE	ASD TALARICO KARATE TEAM APS		ITA - ITALY	
5	BARTOLINI LORENZO	ASD KARATE CENTER BOLOGNA		ITA - ITALY	
5	TORRE LORENZO	A.T. KARATE CLUB ROMA		ITA - ITALY	
7	LAZZARETTI LEONARDO	A.S.D SEN SHIN KAI PADOVA		ITA - ITALY	

VENETO OPEN - 2023-05-19

Statistica Medaglie - Club

Classifica	Club	1. posto	2. posto	3. posto
1	 ASD TALARICO KARATE TEAM APS, ITA	7	4	7
2	 MASTER RAPID SKF CBL, ITA	5	4	7
3	 G.S.FF.OO. POLIZIA DI STATO, ITA	3	1	11
4	 SPORT TARGET, ITA	4	1	5
5	 KARATE CLUB SAVONA, ITA	1	4	5
6	 SHIRAI CLUB S. VALENTINO, ITA	4	2	2
7	 A.S.D. SHIZOKU KARATE AVELLINO, ITA	1	2	3
8	 KARATE POZZUOLO, ITA	1	1	4
9	 TEAM KARATE PULEO FIRENZE, ITA	1	3	1
10	 UNIVERSAL CENTER, ITA	2	1	2
11	 KARATE POLISPORTIVA BREMBATE SOPRA, ITA	3	0	1
12	 CLUB ARTI ORIENTALI CANTU ASD, ITA	2	1	1
13	 ASD ESERCITO - 3° RGT AVES AQUILA, ITA	1	2	1
14	 GIN. ANGEL FIUMICINO, ITA	2	0	2
15	 A.S.D. SHOTOKAN KARATE RYU VENEZIA, ITA	1	1	2
16	 TEAM KARATE LENTINI, ITA	1	0	3
17	 SKORPION KARATE ASD, ITA	2	0	1
18	 AKS FIRENZE, ITA	0	3	0
19	 ASD KARATE CLUB VALDOBBIADENE CROCETTA, ITA	0	2	1
20	 A.S.D. POLISPORTIVA TEVERE, ITA	2	0	0
21	 CENTRO KARATE RICCIONE, ITA	0	1	2
	 ASD FOLIGNO, KARATE CLUB,, ITA	0	1	2
23	 ASD CENTRO SPORTIVO TEODORO MONTEPARANO, ITA	1	1	0
24	 ACCADEMIA KARATE UNION TEAM, ITA	0	0	3
25	 FORZA E COSTANZA - BRESCIA, ITA	1	1	0
	 A.T. KARATE CLUB ROMA, ITA	1	1	0
27	 ASD INTERNATIONAL PALADANZE, ITA	0	0	3
28	 ASD ESERCITO - 187° FOLGORE, ITA	1	1	0
29	 A.S.D. KARATESETTEVILLE, ITA	0	0	3
30	 A.S.D. CHAMPION CENTER, ITA	1	0	1
	 OLIMPIA KARATE BERGAMO ASD, ITA	1	0	1
	 ASSOCIAZIONE SPORTIVA DILETTANTISTICA LEONE, ITA	1	0	1
	 ASD KARATE 2001, ITA	1	0	1
34	 ASD DEFENCE KARATE 2000 PRAVISDOMINI, ITA	0	1	1
	 KYOHAN SIMMI, ITA	0	1	1
36	 ASD LEONI KARATE TEAM, ITA	0	0	2
	 ASD FENICE KARATE TEAM, ITA	0	0	2
	 ASD KARATE TEAM 1999, ITA	0	0	2
	 ASD TIGER S STYLE TEAM IODICE, ITA	0	0	2
40	 ASD FC MOREVILLA, ITA	1	0	0
	 SSD BRACELLI CLUB, ITA	1	0	0
	 ASD SHOTOKAN ACIREALE, ITA	1	0	0
	 A.S.D. ARTESPORT, ITA	1	0	0
	 CENTRO KARATE RICCIONE 1, ITA	1	0	0
	 GOLDEN TIGER TEAM KARATE - MUAY THAI, ITA	1	0	0
	 TSKS BELLUNO, ITA	1	0	0
47	 BODYMIND KARATE, ITA	0	1	0

VENETO OPEN - 2023-05-19

Statistica Medaglie - Club

	 KAIGI KARATE FITNESS A.S.D., ITA	0	1	0
	 ASD NIPPON CLUB NAPOLI KARATE, ITA	0	1	0
	 KARATE DOSCHI ASS.NE SPORTIVA DILETTANTISTICA, ITA	0	1	0
	 ASD JUDO KARATE CLUB, ITA	0	1	0
	 ASD KARATE CAMAIORE, ITA	0	1	0
	 ASD KEN KO PIOBESI, ITA	0	1	0
	 KARATE TRENTO ASD, ITA	0	1	0
	 A.D.P. CHAMPIONS, ITA	0	1	0
	 A.S.D. ASI KARATE VENETO, ITA	0	1	0
	 KARATE NAKAYAMA, ITA	0	1	0
	 DYNAMIC KARATE ASD, ITA	0	1	0
	 LUCIANO BADERNA, ITA	0	1	0
	 BERRETTONI, ITA	0	1	0
	 KARATE BALDASSARRE, ITA	0	1	0
	 UNIVERSAL TEAM - CSO ARCOBALENO, ITA	0	1	0
	 A.S.D. DOJO KARATE WADORYU SPINEA, ITA	0	1	0
64	 ASD LE ARTI NEW SCHOOL DOJO SHOTOKAN ROMA EST, ITA	0	0	1
	 CESANELLI, ITA	0	0	1
	 ASD TREVISO KARATE, ITA	0	0	1
	 ASS.NAZ.CARAB. CAPASSO1, ITA	0	0	1
	 A.S.D. DOJO TAKA TORA, ITA	0	0	1
	 NADIR TRATTI D ORIENTE SSD, ITA	0	0	1
	 KARATE CAMUNO CHINTE, ITA	0	0	1
	 CENTRO SPORTIVO KARATE WADO RYU ROMA, ITA	0	0	1
	 MENS SANA SIENA, ITA	0	0	1
	 CENTRO SPORTIVO FARNESIANA KARATE PIACENZA, ITA	0	0	1
	 A.S.D. MILLENNIUM KARATE, ITA	0	0	1
	 SSD POLISPORTIVA TERNANA, ITA	0	0	1
	 POLISPORTIVA KARATE MOGLIANO, ITA	0	0	1
	 A. S. D. SCUOLA KARATE OMEGNA, ITA	0	0	1
	 ACSD BUDO LACASSIA TORINO, ITA	0	0	1
	 G.S.FIAMME CREMISI BERSAGLIERI FOGGIA, ITA	0	0	1
	 A.S.D. SEN SHIN KAI ROVIGO, ITA	0	0	1
	 KARATE LION, ITA	0	0	1
	 ASD LIBERTAS CLUB LAVELLO, ITA	0	0	1
	 ASD_DINAMO_KARATE_2015, ITA	0	0	1
	 ASD BUSHINKAI, ITA	0	0	1
	 ASD CINTURA NERA KARATE, ITA	0	0	1
	 YOSEIKAN KARATE OPEN WKF, ITA	0	0	1
	 ASD ACCADEMIA KARATE AREZZO, ITA	0	0	1