

KUMITE GIRLS 11-12 YEARS +54KG

31ST KARATE GRAND PRIX CROATIA, CITY SPORTS HALL SAMOBOR, ANDRIJE HEBRANGA 26A, SAMOBOR, CROATIA, CRO

2023-01-22

Tatami
6 17:05

Pool
1/1

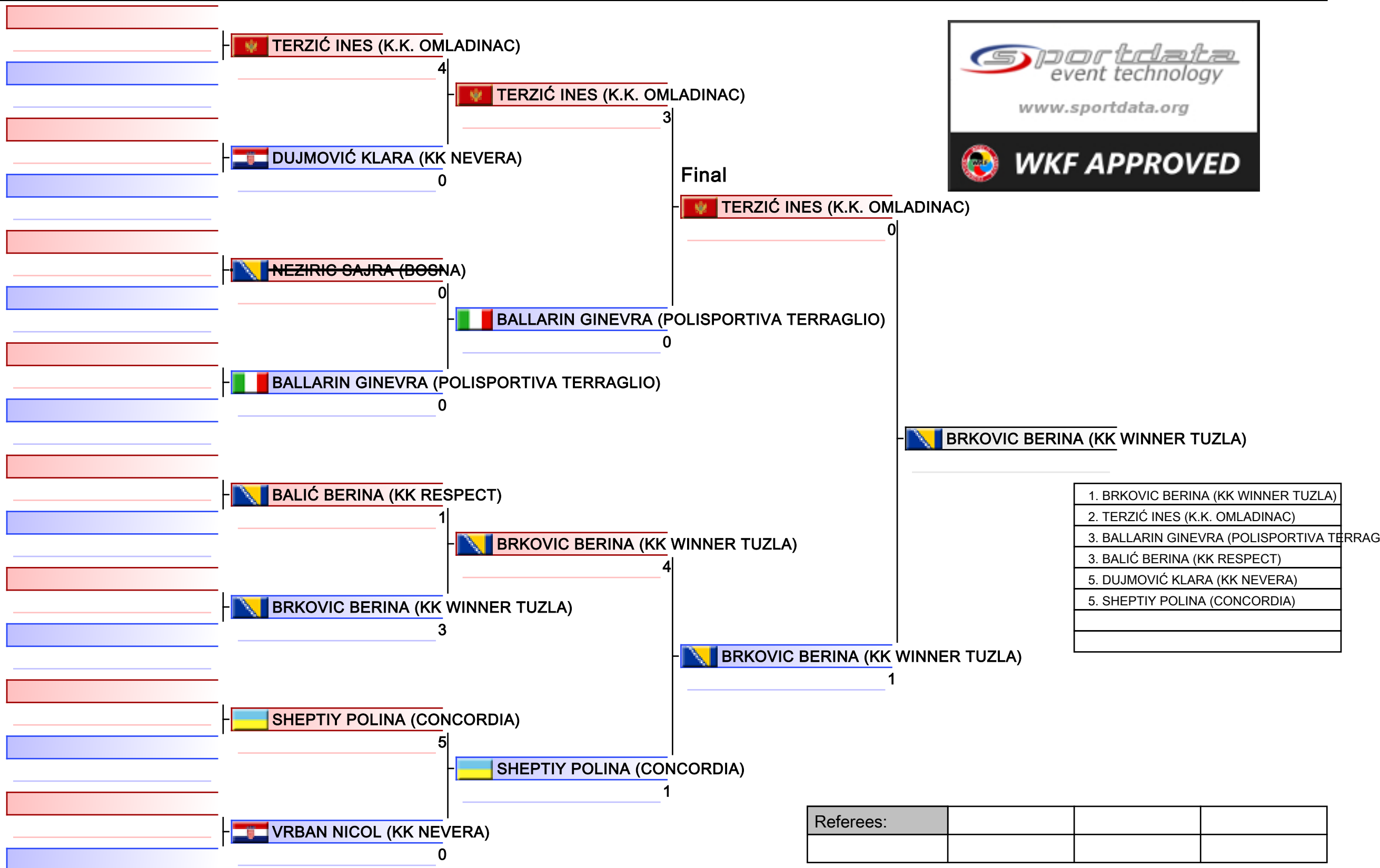

31ST KARATE GRAND PRIX CROATIA - 2023-01-20

kata female U21

R1 G1/2 (11) Tatami 1 13:00(2023-01-20)

Competitors	Kata	1	2	3	4	5	6	7	TOTAL	Extra Total Rank
1 ČVOROVIĆ ALEKSANDRA (ŠD GORICA)	020 GOJUSHIHO DAI	(7.8)	7.6	(6.8)	6.9	7.6			22.1	22.1 8
2 PERUZZI GIADA (SPORT TARGET)	002 ANAN DAI	(6.9)	(8.0)	7.2	7.1	7.2			21.5	21.5 9
3 NADIŽAR LANA_TISA (KK KRANJ SLO)	068 PAPUREN	(7.3)	(8.4)	7.6	7.3	7.4			22.3	22.3 5
4 IPPOLITI IRENE (SKZP)	068 PAPUREN	6.5	(7.3)	7.0	6.7	(6.4)			20.2	20.2 10
5 BRAMBILLA CHIARA (MASTER RAPID SKF CBL)	064 OHAN DAI	(6.1)	(6.8)	6.7	6.5	6.7			19.9	19.9 11
6 BRAJA KLARA (KK OMEGA)	008 CHATANYARA KUSHANKU	(7.1)	7.5	7.6	(7.7)	7.1			22.2	22.2 7
7 VIELMI ELISA (MASTER RAPID SKF CBL)	068 PAPUREN	(6.7)	7.7	7.9	7.9	(8.0)			23.5	23.5 4
8 MEŠIĆ MINA (RODA BEOGRAD)	020 GOJUSHIHO DAI	(7.0)	8.1	8.0	(8.3)	7.8			23.9	23.9 2
9 CRESCENZI ELISA (FF.OO. POLIZIA DI STATO)	068 PAPUREN	8.0	7.8	7.7	(7.4)	(8.2)			23.5	23.5 3
10 ROVERSI ELENA (ITALY)	002 ANAN DAI	(8.2)	8.3	8.3	(8.5)	8.5			25.1	25.1 1
11 JELEN NIKA (KKSA) (*2)	041 KANKU SHO	7.9	(8.2)	7.2	7.2	(7.1)			22.3	22.3 6

R1 G2/2 (11) Tatami 2 13:00(2023-01-20)

Competitors	Kata	1	2	3	4	5	6	7	TOTAL	Extra Total Rank
1 STANGHERLIN SOFIA (SPORT TARGET)	068 PAPUREN	7.0	(6.5)	(7.3)	6.7	7.3			21.0	21.0 10
2 MESAGLIO MARTINA (SKZP)	068 PAPUREN	(6.8)	7.0	(7.6)	7.5	7.5			22.0	22.0 7
3 TAKAČOVA TEREZA (SVK)	068 PAPUREN	7.2	(6.9)		7.4	(7.7)			21.6	21.6 9
4 EUSEPI ALESSIA (A.S.D. KARATE ROMA)	068 PAPUREN	(7.3)	7.4	7.9	(8.1)	8.0			23.3	23.3 2
5 DI LELIO ELENA (ASD ESERCITO - 187 FOLGORE)	068 PAPUREN	7.5	(7.2)	7.5	7.8	(8.2)			22.8	22.8 4
6 NORIS GIADA (MASTER RAPID SKF CBL)	030 HEIKU	(7.6)	7.8	7.7	7.7	(8.3)			23.2	23.2 3
7 NIKOLIC MINA (BEOGRAD)	020 GOJUSHIHO DAI	7.7	7.7	(7.1)	7.2	(8.5)			22.6	22.6 5
8 MARCHETTI GIULIA (SPORT TARGET)	068 PAPUREN	7.8	(6.9)	7.2	6.9	(8.1)			21.9	21.9 8
9 VERDONE MELISSA (MASTER RAPID SKF CBL)	064 OHAN DAI	7.4	(7.3)	7.5	7.3	(7.9)			22.2	22.2 6
10 MAESTRI ERIKA (MASTER RAPID SKF CBL)	030 HEIKU	7.1	(6.2)	6.8	6.2	(7.2)			20.1	20.1 11
11 RAGUZ IVANA (KKHD) (*1)	021 GOJUSHIHO SHO	(7.5)	7.6	7.8	8.0	(8.6)			23.4	23.4 1

R2-G1

Competitors	Kata	1	2	3	4	5	6	7	TOTAL	Extra Total Rank
1 MEŠIĆ MINA (RODA BEOGRAD)	021 GOJUSHIHO SHO	8.2	(8.6)	7.9	7.8	(7.6)			23.9	23.9 3
2 CRESCENZI ELISA (FF.OO. POLIZIA DI STATO)	064 OHAN DAI	7.9	(7.8)	(8.1)	8.0	8.0			23.9	23.9 2
3 ROVERSI ELENA (ITALY)	064 OHAN DAI	8.4	(7.8)	(8.6)	8.5	8.4			25.3	25.3 1
4 VIELMI ELISA (MASTER RAPID SKF CBL)	002 ANAN DAI	8.0	7.9	7.8	(7.7)	(8.3)			23.7	23.7 4

R2-G2

Competitors	Kata	1	2	3	4	5	6	7	TOTAL	Extra Total Rank
1 DI LELIO ELENA (ASD ESERCITO - 187 FOLGORE)	047 KURURUNFA	7.7	(8.1)	(7.3)	7.9	7.8			23.4	23.4 4
2 NORIS GIADA (MASTER RAPID SKF CBL)	002 ANAN DAI	8.0	(7.5)	7.6	8.0	(8.4)			23.6	23.6 3
3 RAGUZ IVANA (KKHD)	020 GOJUSHIHO DAI	8.2	(7.6)	7.8	(8.3)	7.9			23.9	23.9 2
4 EUSEPI ALESSIA (A.S.D. KARATE ROMA)	002 ANAN DAI	(8.4)	(7.4)	8.2	8.2	8.2			24.6	24.6 1

R3 Bronze Medal Match 1

Competitors	Kata	1	2	3	4	5	6	7	TOTAL	Extra Total Rank
1 CRESCENZI ELISA (FF.OO. POLIZIA DI STATO)	002 ANAN DAI									
2 NORIS GIADA (MASTER RAPID SKF CBL)	068 PAPUREN									

R3 Bronze Medal Match 2

Competitors	Kata	1	2	3	4	5	6	7	TOTAL	Extra Total Rank
1 MEŠIĆ MINA (RODA BEOGRAD)	041 KANKU SHO									
2 RAGUZ IVANA (KKHD)	041 KANKU SHO									

R3 Gold Medal Match

31ST KARATE GRAND PRIX CROATIA - 2023-01-20

kata female U21

Competitors	Kata	1	2	3	4	5	6	7	TOTAL	Extra Total Rank
1 ROVERSI ELENA (ITALY)	068 PAPUREN									
2 EUSEPI ALESSIA (A.S.D. KARATE ROMA)	009 CHIBANA NO KUSHANKU									

Results

1	ROVERSI ELENA	ITALIAN NATIONAL TEAM		ITALY
2	EUSEPI ALESSIA	A.S.D. KARATE ROMA		ITALY
3	NORIS GIADA	MASTER RAPID SKF CBL		ITALY
3	RAGUZ IVANA	KARATE KLUB HRVATSKI DRAGOVOLJAC		CROATIA
5	CRESCENZI ELISA	G.S.FF.OO. POLIZIA DI STATO		ITALY
5	MEŠIĆ MINA	KARATE KLUB ČUKARIČKI RODA BEOGRAD		SERBIA
7	VIELMI ELISA	MASTER RAPID SKF CBL		ITALY
7	DI LELIO ELENA	ASD ESERCITO - 187° FOLGORE		ITALY
9	NADIŽAR LANA TISA	KARATE KLUB KRANJ		SLOVENIA
9	NIKOLIC MINA	SKIPPER		SERBIA
11	JELEN NIKA	KK SAMOBOR		CROATIA
11	VERDONE MELISSA	MASTER RAPID SKF CBL		ITALY
13	BRAJA KLARA	KARATE KLUB OMEGA		CROATIA
13	MESAGLIO MARTINA	ASD SHOTOKAN KARATE POZZUOLO DEL FRIULI		ITALY
15	ČVOROVIĆ ALEKSANDRA	ŠPORTNO DRUŠTVO GORICA		SLOVENIA
15	MARCHETTI GIULIA	SPORT TARGET		ITALY
17	PERUZZI GIADA	SPORT TARGET		ITALY
17	TAKACOVA TEREZA	SLOVAK NATIONAL TEAM		SLOVAKIA
19	IPPOLITI IRENE	ASD SHOTOKAN KARATE POZZUOLO DEL FRIULI		ITALY
19	STANGHERLIN SOFIA	SPORT TARGET		ITALY
21	BRAMBILLA CHIARA	MASTER RAPID SKF CBL		ITALY
21	MAESTRI ERIKA	MASTER RAPID SKF CBL		ITALY

KUMITE GIRLS 11-12 YEARS -34KG

31ST KARATE GRAND PRIX CROATIA, CITY SPORTS HALL SAMOBOR, ANDRIJE HEBRANGA 26A, SAMOBOR, CROATIA, CRO

2023-01-22

Tatami
1 17:20

Pool
1/1

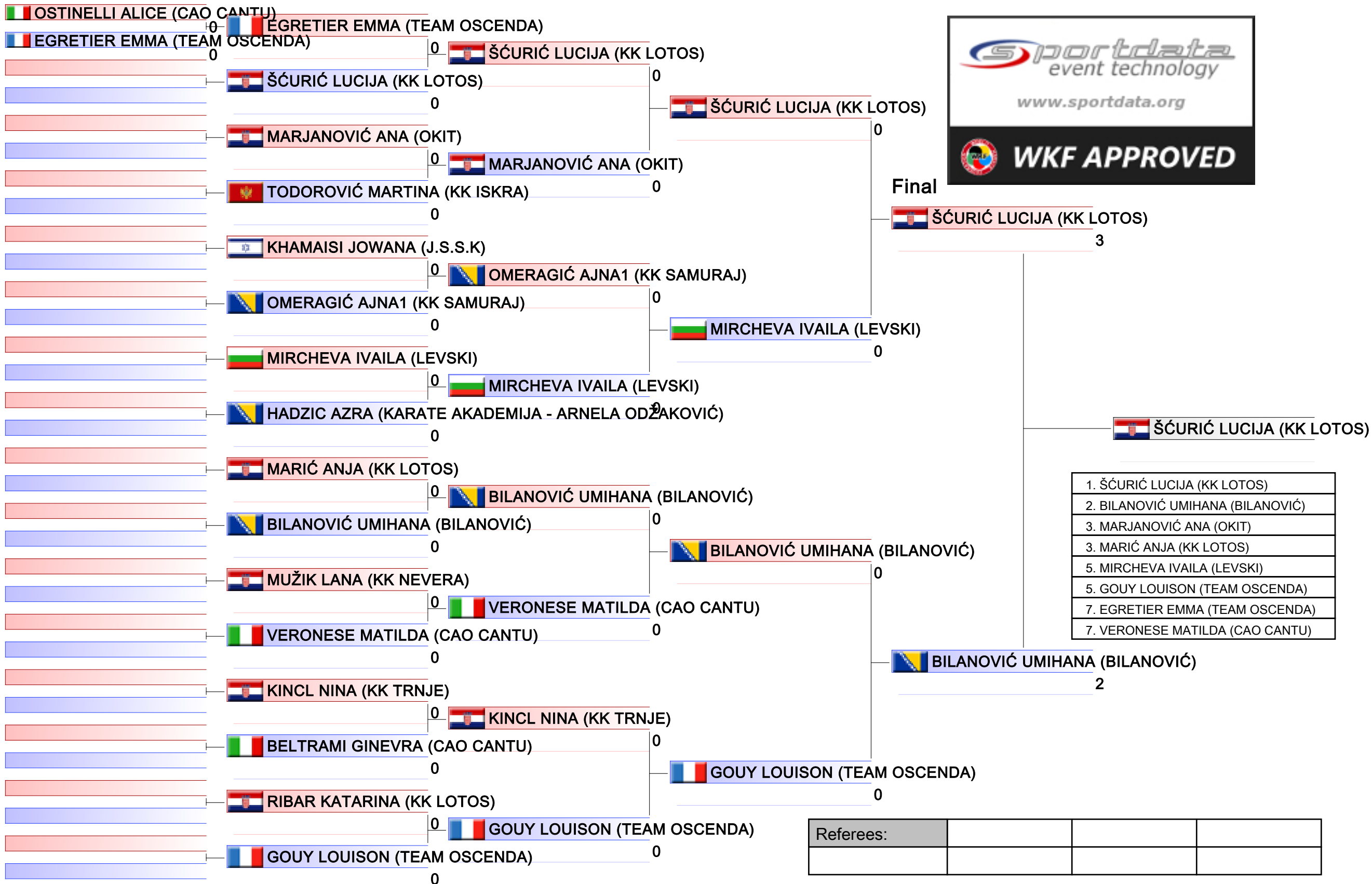

Referees:			

KUMITE GIRLS 11-12 YEARS -39KG

31ST KARATE GRAND PRIX CROATIA, CITY SPORTS HALL SAMOBOR, ANDRIJE HEBRANGA 26A, SAMOBOR, CROATIA, CRO

2023-01-22

Tatami
2 17:40

Pool
1/1

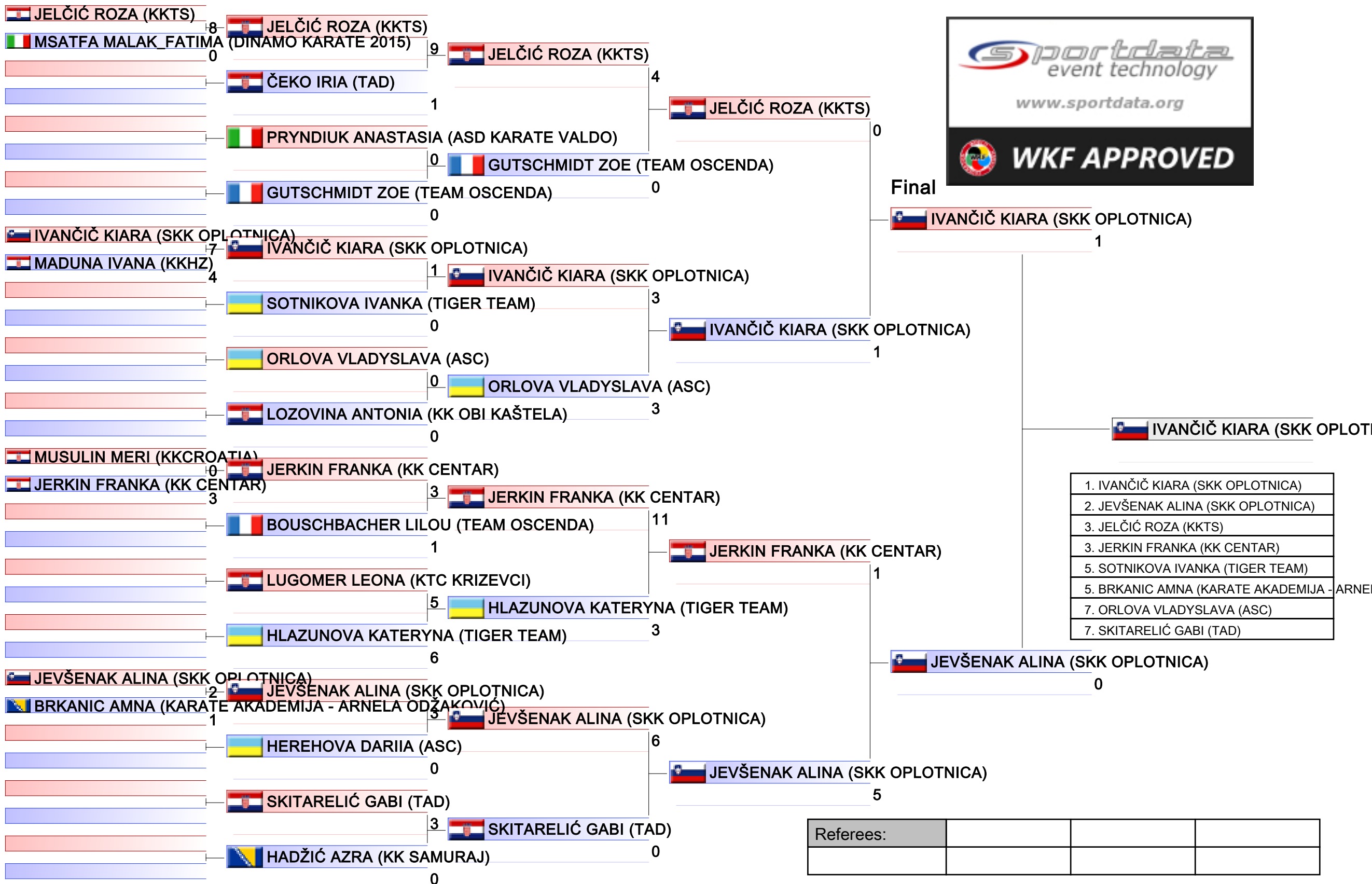

KUMITE GIRLS 11-12 YEARS -44KG

31ST KARATE GRAND PRIX CROATIA, CITY SPORTS HALL SAMOBOR, ANDRIJE HEBRANGA 26A, SAMOBOR, CROATIA, CRO

2023-01-22

Tatami
4 16:15

Pool
1/1

 KADIĆ NOLA (KK LOTOS)

5  KADIĆ NOLA (KK LOTOS)

 PEZZINO FLAVIA (AKASHIDO PALERMO)

0

 STELLA FEDERICA (PRO-TEAM ASD)

1

 STELLA FEDERICA (PRO-TEAM ASD)

1

Final

 STELLA FEDERICA (PRO-TEAM ASD)

1

 PHILIP SHIRA (JKSISR)

 ORLOVA VLADYSLAVA (ASC)

1

 ORLOVA VLADYSLAVA (ASC)

 KALTAK LARISA (BILANOVIĆ)

 ZAMBERLAN EMMA (KARATE TEAM 1999)

 ZAMBERLAN EMMA (KARATE TEAM 1999)

0

 ŠEVČÍKOVÁ NATÁLIA (SVK)

3

 ŠEVČÍKOVÁ NATÁLIA (SVK)

8

 ŠEVČÍKOVÁ NATÁLIA (SVK)

3

 BUKVA AJSA (KARATE AKADEMIJA - ARNELA ODŽAKOVIĆ)

0

 MURASHKINA VARVARA (LEON KARATE CLUB)

0

 MURASHKINA VARVARA (LEON KARATE CLUB)

7

 ŠEVČÍKOVÁ NATÁLIA (SVK)

1. ŠEVČÍKOVÁ NATÁLIA (SVK)
2. STELLA FEDERICA (PRO-TEAM ASD)
3. ORLOVA VLADYSLAVA (ASC)
3. ZAMBERLAN EMMA (KARATE TEAM 1999)
5. KADIĆ NOLA (KK LOTOS)
5. MURASHKINA VARVARA (LEON KARATE CLUB)

Referees:			



31ST KARATE GRAND PRIX CROATIA

2023.01.20 - 2023.01.22

CITY SPORTS HALL SAMOBOR, ANDRIJE HEBRANGA 26A, SAMOBOR,
CROATIA

CROATIA,CRO























31ST KARATE GRAND PRIX CROATIA

CROATIA

2023.01.20 - 2023.01.22

CITY SPORTS HALL SAMOBOR, ANDRIJE HEBRANGA 26A, SAMOBOR, CROATIA

Participation List (by Club/Team)

#	Code	Club	Male	Female	Total Entries	Total Athletes
1	 AUT	ASKÖ Karate Kara(Kara)	0	1	1	1
2	 AUT	Inoue-ha Karate-do Feldkirchen(KC Feldkirchen)	2	1	3	3
3	 AUT	KARATE VORARLBERG(KARATE VORARLBERG)	2	0	2	2
4	 AUT	Karate-Do Weiz(Karate-Do Weiz)	1	0	1	1
5	 AUT	LZ KARATE NIEDERÖSTERREICH(LZKNÖ)	2	3	5	5
6	 AUT	Shiai Karate-Do Wien(Shiai Karate-Do)	0	1	1	1
7	 AZE	National Karate Federation[1](NKF[1])	25	11	36	32
8	 BIH	Bilanović(Bilanović)	2	6	8	8
9	 BIH	KARATE AKADEMIJA - ARNELA ODŽAKOVIĆ(KARATE AKADEMIJA - ARNELA ODŽAKOVIĆ)	5	12	17	15
10	 BIH	KARATE KLUB FENIKS(KK FENIKS)	1	0	1	1
11	 BIH	KARATE KLUB RESPECT(KK RESPECT)	5	4	9	9
12	 BIH	KARATE KLUB WINNER TUZLA(KK WINNER TUZLA)	0	1	1	1
13	 BIH	KBES 5.11-BK BOSANSKA KRUPA(KBES 5.11-BK)	4	1	5	4
14	 BIH	KK BOSNJAK KONJIC(KK BOSNJAK KONJIC)	1	0	1	1
15	 BIH	KK IPPON Sarajevo(IPPON SARAJEVO)	0	3	3	3
16	 BIH	KK Master Bugojno[5](Master[5])	4	2	6	6
17	 BIH	KK Mladost Vitez[2](KK Mladost[2])	1	3	4	4
18	 BIH	KK Perfekt Sarajevo(KK Perfekt Sarajevo)	2	0	2	1
19	 BIH	Karate Klub Energija(Energija)	6	1	7	6
20	 BIH	Karate Klub Regeneracija(KK Regeneracija)	9	1	10	7
21	 BIH	Karate Klub Sampioni[1](Sampioni[1])	5	0	5	4
22	 BIH	Karate Klub Vezir[1](KK Vezir[1])	6	4	10	9
23	 BIH	Karate klub DO Tuzla[1](KK DO Tuzla[1])	1	2	3	3
24	 BIH	Karate klub Kumite(KK KUMITE Jajce)	7	4	11	11
25	 BIH	Karate klub Posušje(KK Posušje)	0	1	1	1
26	 BIH	Karate klub Rašid Buća(K.K Rašid Buća)	5	3	8	8
27	 BIH	Karate klub Sambon - Vogosca(KK Sambon - Vogosca)	3	0	3	3
28	 BIH	Karate klub Slavija(KK Slavija)	2	1	3	3
29	 BIH	Karate klub Travnik GS-TMT(KK Travnim GS-TMT)	4	3	7	6
30	 BIH	Karate klub ZANSHIN Sarajevo[1](KK ZANSHIN[1])	4	1	5	5
31	 BIH	Karate klub Zanshin Banja Luka(KK Zanshin BL)	1	0	1	1
32	 BIH	Karate klub ŠIROKI Široki Brijeg(KK ŠIROKI[1])	2	0	2	2
33	 BIH	Karate klub Šampion[1](Kk Šampion[1])	4	1	5	4









































31ST KARATE GRAND PRIX CROATIA

CROATIA

2023.01.20 - 2023.01.22

CITY SPORTS HALL SAMOBOR, ANDRIJE HEBRANGA 26A, SAMOBOR, CROATIA

Participation List (by Club/Team)

34		BIH	Klub borilačkih sportova Tuzla[2](KBS Tuzla[2])	7	4	11	10
35		BIH	MAWASHI SARAJEVO(BOSNA)	4	3	7	7
36		BIH	Samuraj[1](KK Samuraj[1])	2	5	7	7
37		BIH	Univerzitetski karate klub VRBAS Banja Luka[1](UKK VRBAS Banja Luka BiH)	3	0	3	3
38		BIH	_Karate klub Novi Grad Sarajevo_(_KK Novi Grad Sa_)	1	1	2	2
39		BUL	Karate Club Shuriken(SHURIKEN[1])	4	0	4	2
40		BUL	DARIS(Sofia)	1	0	1	1
41		BUL	KARATE CLUB TSANEV(KC TSANEV)	0	2	2	2
42		BUL	Karate club Kaloyan[1](KK Kaloyan[1])	0	4	4	4
43		BUL	Ronin11 Sofia(Ronin11)	6	5	11	9
44		BUL	SHIELD NOVI ISKAR - CSKA(SHIELD - CSKA)	2	0	2	1
45		BUL	k.k. LEVSKI SPARTAK(LEVSKI)	6	5	11	8
46		BUL	Файтърс-НСА(Fighters-NSA)	3	0	3	2
47		CRO	CBS PULA(CBS PULA)	1	1	2	2
48		CRO	ENPI RAB(ENPI rab)	5	0	5	5
49		CRO	GLOBUS ČAKOVEC(GLOBUS)	12	9	21	19
50		CRO	HERCEGOVINA-ZAGREB(KKHZ)	1	0	1	1
51		CRO	HERCEGOVINA-ZAGREB[1](KKHZ[1])	22	14	36	34
52		CRO	K.K. SOKOL(K.K. SOKOL)	0	3	3	3
53		CRO	KARATE KLUB ALFA(KK ALFA)	9	5	14	14
54		CRO	KARATE KLUB HRVATSKI SOKOL OSIJEK(KK HRVATSKI SOKOL)	0	1	1	1
55		CRO	KARATE KLUB IPON ZAGREB (KK IPON ZAGREB)	10	8	18	16
56		CRO	KARATE KLUB KTC KRIZEVCI[1](KTC KRIZEVCI[1])	2	4	6	6
57		CRO	KARATE KLUB OMEGA(KK OMEGA)	0	2	2	2
58		CRO	KARATE KLUB TEMPO[2](KK TEMPO[2])	3	4	7	7
59		CRO	KARATE KLUB TRNJE(KK TRNJE)	7	5	12	12
60		CRO	KK JADRAN(KK Jadran)	0	1	1	1
61		CRO	KK LOTOS ZAGREB(KK LOTOS)	4	6	10	9
62		CRO	KK OPATIJA(Opatija)	1	3	4	4
63		CRO	KK Okinawa Mali Bukovec[1](KK Okinawa[1])	2	0	2	2
64		CRO	KK Samobor (kksa)	20	7	27	23
65		CRO	KK VIROVITICA[1](VIROVITICA[1])	4	1	5	5
66		CRO	Karate Akademija Osijek KAO(KAO)	2	2	4	3
67		CRO	Karate Dojo Brač[4](Bushij[4])	0	2	2	2
68		CRO	Karate Klub Max Ivankovo(KK Max)	1	3	4	4
69		CRO	Karate Klub Novi Zagreb(KK Novi Zagreb)	7	2	9	9
70		CRO	Karate Klub Pula[1](K.K.Pula[1])	0	2	2	1
71		CRO	Karate Klub Tigar Sisak [3](KKTS[3])	6	7	13	13
72		CRO	Karate Klub Zrinski(KKZ)	0	3	3	3
73		CRO	Karate klub 10.DAN(KK 10.DAN)	1	3	4	4
74		CRO	Karate klub BUSHIDO, Zagreb(KK BUSHIDO, Zagreb)	1	4	5	5



















31ST KARATE GRAND PRIX CROATIA

CROATIA

2023.01.20 - 2023.01.22

CITY SPORTS HALL SAMOBOR, ANDRIJE HEBRANGA 26A, SAMOBOR, CROATIA

Participation List (by Club/Team)

75		CRO	Karate klub Bregana(KK Bregana)	3	6	9	8
76		CRO	Karate klub CROHERC[2](CROHERC[2])	5	2	7	7
77		CRO	Karate klub Centar(KK Centar)	1	2	3	2
78		CRO	Karate klub Champion Rijeka(CHAMPION RIJEKA)	5	12	17	17
79		CRO	Karate klub Croatia[1](KKCroatia[1])	2	2	4	4
80		CRO	Karate klub Hrvatski Dragovoljac[3](KKHD[3])	7	5	12	12
81		CRO	Karate klub KLENOVNIK(K.K.Klenovnik)	1	1	2	2
82		CRO	Karate klub Kaptol Zagreb(Kaptol)	6	0	6	4
83		CRO	Karate klub Kastav[2](KK Kastav[2])	10	4	14	13
84		CRO	Karate klub Kostrena[1](KK Kostrena[1])	4	4	8	8
85		CRO	Karate klub Metal - Jurdani(kkmetal_jurdani)	2	0	2	1
86		CRO	Karate klub Međimurje[1](KK Međimurje[1])	1	0	1	1
87		CRO	Karate klub NEVERA[1](KK NEVERA[1])	3	4	7	7
88		CRO	Karate klub No Kachi[18](KKK[18])	0	2	2	2
89		CRO	Karate klub Obi Kaštela(KK Obi Kaštela)	0	3	3	3
90		CRO	Karate klub Polet Zagreb(Polet Zagreb)	1	3	4	3
91		CRO	Karate klub Sakura Zagreb(SakuraZG)	0	2	2	2
92		CRO	Karate klub Shihan - Zagreb(KKShihan)	2	1	3	3
93		CRO	Karate klub Sportslife Zg(kk.sportslife)	2	1	3	3
94		CRO	Karate klub Stijena(KK Stijena)	1	1	2	2
95		CRO	Karate klub Tinjan(Tinjan)	2	0	2	2
96		CRO	Karate klub Varaždin(KK Varaždin)	2	0	2	1
97		CRO	Karate klub Velika Gorica[1](VG[1])	9	10	19	14
98		CRO	Karate klub Zanshin, Split[3](Karate klub Zanshin, Split[3])	0	1	1	1
99		CRO	Karate klub Šibenik 1066(KKŠ1066)	2	0	2	2
100		CRO	Mladost[1](Mladost[1])	4	1	5	5
101		CRO	Okit Vodice(Okit)	3	7	10	10
102		CRO	SLAVKO KRIVSKI TERMAL DARUVAR(HKK SKT DARUVAR)	4	1	5	5
103		CRO	Slavonski Brod (SB_CRO)	0	2	2	1
104		CRO	TAD RIJEKA[4](TAD[4])	3	2	5	5
105		CRO	ZAMET[2](RI[2])	1	3	4	4
106		CRO	karate klub karlovac 1969(karlovac)	5	1	6	6
107		CRO	rijeka[1](rijeka[1])	0	1	1	1
108		DEN	Itosu-kai Bosatsu(Bosatsu)	8	2	10	8
109		DEN	Sportskarate.dk[4](SPD[4])	4	7	11	7
110		FRA	TEAM OSCENDA KARATÉ(TEAM OSCENDA)	7	7	14	13
111		GRE	ATHLITIKOS SYLLOGOS AMAROUSIOU(GR_482)	6	4	10	5
112		GRE	ΑΣ ΠΑΡΘΕΝΩΝ ΚΟΡΥΔΑΛΛΟΥ(526-XA08)	0	1	1	1
113		GRE	ΑΣΑ ΣΟΤΟΚΑΝ ΚΑΡΑΤΕ(371-ΦΝ68)	2	0	2	2
114		GRE	ΑΣΣΚ ΠΕΡΣΕΑΣ(492-ΦΩ37)	4	0	4	3
115		HUN	BVSC-Zuglói[5](Bvsc[5])	0	1	1	1
116		HUN	Bátaszék SE[2](BSE[2])	1	0	1	1

































31ST KARATE GRAND PRIX CROATIA

CROATIA

2023.01.20 - 2023.01.22

CITY SPORTS HALL SAMOBOR, ANDRIJE HEBRANGA 26A, SAMOBOR, CROATIA

Participation List (by Club/Team)

117		HUN	GASTROYAL SE[1](GASTROYAL SE[1])	0	1	1	1
118		HUN	KARATE KLUB SPORTINGBUDO[1](PORTINGBUDO[1])	2	0	2	1
119		HUN	KSI Hungary[9](KSI[9])	3	3	6	4
120		HUN	Karate Klub Sportingbudo(Sportingbudo)	2	1	3	3
121		HUN	MTK Budapest[3](MTK[3])	1	5	6	6
122		HUN	SZARVAS(SZARVAS)	5	1	6	5
123		HUN	TISZA VOLÁN SC(TISZA VOLÁN SC)	1	0	1	1
124		HUN	Toriki Sportkarate Club Zalaegerszeg[2](TORIKI[2])	0	2	2	2
125		HUN	UTE HUNGARY(UTE)	1	0	1	1
126		IND	Diamond International Dojo(Diamond International Dojo)	4	0	4	4
127		IND	SURINDER SALARIA[1](SURINDER SALARIA[1])	1	1	2	2
128		ISR	Azkokai Makabi Bat-yam(Azkokai Makabi Bat-yam)	11	1	12	12
129		ISR	JAMAL SAADA SHOTOKAN KARATE(J.S.S.K)	14	3	17	14
130		ISR	JKS ISRAEL[1](JKSISR[1])	15	13	28	12
131		ISR	KSK Israel[3](KSK[3])	1	0	1	1
132		ISR	ROGOZARSKI DOJO(ROG)	2	1	3	3
133		ISR	S.I.K(yoel)	3	2	5	4
134		ISR	SHINDOKAN MACCABI ISRAEL (shindokan[1])	3	2	5	5
135		ISR	Shitokai Israel(shogun-IL)	1	0	1	1
136		ISR	israel meitar wcsk(md)	0	3	3	3
137		ISR	Club Desert Star Karate(Ikws)	2	0	2	2
138		ITA	A.S.D. ACADEMIA HYDRA(HYDRA KARATE LAB)	0	2	2	1
139		ITA	A.S.D. Asi Karate Veneto[2](Asi Karate Veneto[2])	4	2	6	6
140		ITA	A.S.D. Champion Center (Champion Center)	1	5	6	4
141		ITA	A.S.D. JISEI BUDO A.M.I.[1](ASD JISEI BUDO AMI)	0	1	1	1
142		ITA	A.S.D. JOHNNYS KARATE BORGOSISA(JOHNYS KARATE)	2	0	2	2
143		ITA	A.S.D. MABUNI CLUB CIVITAVECCHIA(mabuni)	1	0	1	1
144		ITA	A.S.D. POL. POLO VERDE(POLO VERDE-PALERMO)	2	0	2	1
145		ITA	A.S.D. SHIZOKU KARATE AVELLINO(SHIZOKU KRT AV)	7	2	9	7
146		ITA	A.S.D. Sen Shin Kai Rovigo(SSKR)	5	2	7	3
147		ITA	A.S.D. TEAM KARATE ARZACHENA(Team Karate ARZACHENA)	1	2	3	3
148		ITA	A.S.D. VILLA PIGNA KARATE(A.S.D. VILLA PIGNA KARATE)	2	0	2	1
149		ITA	A.T. karate club Roma(A.T. karate club Roma)	0	1	1	1

31ST KARATE GRAND PRIX CROATIA

CROATIA

2023.01.20 - 2023.01.22

CITY SPORTS HALL SAMOBOR, ANDRIJE HEBRANGA 26A, SAMOBOR, CROATIA

Participation List (by Club/Team)

150		ITA	A.s.d Centro Sport(A.s.d Centro Sport)	0	2	2	2
151		ITA	A.s.d real società Monreale(Real Società)	3	0	3	2
152		ITA	ACADEMY PONTE DI PIAVE ASD(ASDK PDP)	2	0	2	2
153		ITA	ACCADEMIA KARATE UNION TEAM(AK[1])	3	0	3	3
154		ITA	ACSD BUDO LACASSIA torino(BudoLacassia)	2	1	3	3
155		ITA	ASCD ATLANTIDE(ATLANTIDE TROINA)	0	1	1	1
156		ITA	ASD CENTRO STUDI KARATE NEGRAR[1](ASD CSK NEGRAR[1])	0	2	2	2
157		ITA	ASD ESERCITO - 187° FOLGORE(ASD ESERCITO - 187 FOLGORE)	7	3	10	7
158		ITA	ASD FC MOREVILLA[1](Asd Morevilla[1][1])	2	0	2	1
159		ITA	ASD Fitness Club Nuova Florida(12RM1604)	0	1	1	1
160		ITA	ASD IPPON 2(I 2 K)	2	1	3	3
161		ITA	ASD KARATE 2001(K 01)	0	1	1	1
162		ITA	ASD KARATE CLUB VALDOBBIADENE CROCETTA(ASD KARATE VALDO)	2	5	7	7
163		ITA	ASD KARATE SACILE(KARATE SACILE)	2	1	3	2
164		ITA	ASD Karate club kanazawa[1](Kanazawa Cimadolmo[1][1])	2	3	5	5
165		ITA	ASD OKINAWA FIGHT(OKINAWA FIGHT ASD)	2	0	2	2
166		ITA	ASD REMBUKAN KARATE VILLASMUNDO[1](REMBUKAN VILLASMUNDO[1])	5	1	6	5
167		ITA	ASD RENSHUKAN TORINO(RENSHUKAN)	1	0	1	1
168		ITA	ASD SHOTOKAN ACIREALE[2](ACIREALE[2])	7	2	9	6
169		ITA	ASD Shotokan Karate Pozzuolo del Friuli(SKZP)	1	4	5	3
170		ITA	ASD TALARICO KARATE TEAM APS(TKT[1])	3	3	6	6
171		ITA	Accademia Karate Montevarchi A.S.D.(Acc. Karate Montevarchi)	4	0	4	2
172		ITA	Akashido(Akashido Palermo)	0	6	6	4
173		ITA	Asd_Dinamo_Karate_2015(Dinamo Karate 2015)	5	8	13	13
174		ITA	BERRETTONI FEDERICO(ROMA 12)	1	1	2	2
175		ITA	Bodymind Karate[2](Bodymind Karate[2])	3	1	4	4
176		ITA	Bushido Karate Perugia[1](BKP[1])	4	0	4	2
177		ITA	CENTRO KARATE RIMINI[3](CKR[3])	1	0	1	1
178		ITA	CLUB ARTI ORIENTALI CANTU asd(CAO CANTU)	19	6	25	20
179		ITA	CRS AKIYAMA Settimo(CRS AKIYAMA Settimo)	2	0	2	2









































31ST KARATE GRAND PRIX CROATIA

CROATIA

2023.01.20 - 2023.01.22

CITY SPORTS HALL SAMOBOR, ANDRIJE HEBRANGA 26A, SAMOBOR, CROATIA

Participation List (by Club/Team)

180		ITA	Evolution Team Karate(ETK)	2	0	2	2
181		ITA	FORZA E COSTANZA - BRESCIA(F & C)	5	3	8	5
182		ITA	G.S.FF.OO. POLIZIA DI STATO(FF.OO. POLIZIA DI STATO)	2	4	6	4
183		ITA	Italian National Team[4](Italy[4])	18	17	35	35
184		ITA	KARATE CLUB SAVONA (KCS - LIGURIA KARATE)	0	2	2	2
185		ITA	KARATE DO TRIESTE(KARATE DO TRIESTE)	0	2	2	2
186		ITA	Karate Alto Vicentino (K. A. V.)	1	3	4	3
187		ITA	Karate Nakayama[1](Karate Nakayama[1])	1	2	3	3
188		ITA	Karate Team Dolomiti[1](KTDolomiti[1])	0	3	3	3
189		ITA	MASTER RAPID SKF CBL(MASTER RAPID SKF CBL)	17	23	40	21
190		ITA	PRO-TEAM ASD(PRO-TEAM ASD)	2	11	13	8
191		ITA	RARI NANTES ALBANO[1](RARI NANTES B.[1])	1	2	3	2
192		ITA	RENZI(RENZI)	1	0	1	1
193		ITA	SHIRAI CLUB S. VALENTINO(SHIRAI CLUB S. VALENTINO)	1	0	1	1
194		ITA	SPORT TARGET (SPORT TARGET)	1	8	9	6
195		ITA	SSD Polisportiva Ternana(karateterni)	2	0	2	1
196		ITA	SSD Polisportiva Terraglio[1](Polisportiva Terraglio[1])	9	11	20	17
197		ITA	Spazio Sport Forte dei Marmi(Spazio Sport)	3	4	7	5
198		ITA	TSKS BELLUNO(TSKS)	5	0	5	5
199		ITA	Team Karate Puleo Firenze(TKP)	3	0	3	3
200		ITA	UNIVERSAL CENTER[1](UC[1])	8	4	12	12
201		ITA	World wellness karate Sorso[3](Wwkr Sorso[3])	1	2	3	2
202		ITA	a.s.d. karate roma(a.s.d. karate roma)	1	1	2	2
203		ITA	asd KARATE TEAM 1999(KARATE TEAM 1999)	4	2	6	6
204		ITA	asd judo karate club(asd jk club)	2	1	3	2
205		ITA	asd karate team isernia(karate team isernia)	1	0	1	1
206		ITA	karate trento asd(ktn)	0	1	1	1
207		ITA	skorpion karate asd(skorpion karate asd)	0	2	2	1
208		ITA	sport center messina[1](sc messina[1])	1	0	1	1
209		ITA	ssd braccelli club[1](ssd braccelli club[1])	2	0	2	2
210		MAR	The Lions team[4](Lions[4])	1	0	1	1
211		MDA	BARS BALTI WKF(BARS BALTI)	7	0	7	4
212		MKD	Bottoni[1](BOTTONI[1])	2	0	2	2
213		MKD	KK FATI TETOVĚ(KK Fati)	0	2	2	2
214		MKD	KUSHTRIMI(K.K. Kushtrimi)	2	0	2	2
215		MKD	Makpetrol MKD(Makpetrol MKD)	7	3	10	10
216		MKD	RINIA MATEÇ(K.K. RINIA)	2	0	2	2
217		MKD	Uskana-Kërçovë(Uskana-Kercove)	0	1	1	1
218		MKD	d[5](d[5])	0	1	1	1
219		MKD	Карате клуб Штип(Арсовски)	2	0	2	2

31ST KARATE GRAND PRIX CROATIA

CROATIA

2023.01.20 - 2023.01.22

CITY SPORTS HALL SAMOBOR, ANDRIJE HEBRANGA 26A, SAMOBOR, CROATIA

Participation List (by Club/Team)

220		MKD	Кизаме(Кизаме)	2	2	4	4
221		MKD	Олимпик Спорт 2007 - Скопје(Олимпик Спорт 2007 - Скопје)	6	3	9	7
222		MKD	Цветан Димов - Скопје(Цветан Димов - Скопје)	0	1	1	1
223		MKD	Чоле - Охрид(Чоле - Охрид)	2	1	3	3
224		MNE	KARATE KLUB PANTER(KK PANTER)	3	2	5	5
225		MNE	Karate klub ISKRA(KK ISKRA)	4	3	7	7
226		MNE	Karate klub Kondor(KK Kondor)	0	1	1	1
227		MNE	Montenegro[9](Montenegro[9])	15	9	24	23
228		MNE	k.k. Omladinac(k.k. Omladinac)	2	4	6	6
229		MNE	kkPotoci(Potoci)	4	2	6	4
230		NED	Karateschool Fightin Nabil(KSFN, NED)	0	1	1	1
231		PHI	Association for the Advancement of Karatedo(AAK Philippines)	1	0	1	1
232		ROU	Crişul sport club Oradeaa(C. S. Crişul)	3	1	4	4
233		SLO	DRUŠTVO ZA KARATE CELJE(DK CELJE)	2	1	3	3
234		SLO	KARATE KLUB BREŽICE[1](KARATE KLUB BREŽICE[1])	1	2	3	3
235		SLO	KARATE KLUB BUSHIDO, ROGASKA SLATINA(KK BUSHIDO)	4	1	5	3
236		SLO	KARATE KLUB LJUBLJANA[1](KK LJUBLJANA[1])	8	5	13	11
237		SLO	KARATE KLUB POSTOJNA[4](KK POSTOJNA[4])	1	0	1	1
238		SLO	KARATE KLUB TRBOVLJE[1](TRBOVLJE[1])	6	0	6	4
239		SLO	KARATE KLUB VELENJE[5](KK VELENJE[5])	10	7	17	9
240		SLO	Karate Klub Cerknica(KK Cerknica)	1	0	1	1
241		SLO	Karate Klub Kolektor Idrija[3](KKK Idrija[3])	7	4	11	11
242		SLO	Karate Klub Kovinar Maribor(KK Kovinar Maribor)	3	0	3	3
243		SLO	Karate Klub Radenci Shotokan(KK Radenci Shotokan)	1	0	1	1
244		SLO	Karate klub Sokol, Ljubljana(Sokol[2])	1	2	3	2
245		SLO	Karate klub Kranj(KK Kranj SLO)	1	5	6	5
246		SLO	Karate klub Limbuš(kutnjak[1])	0	2	2	1
247		SLO	Karate klub Mawashi Postojna(KK Mawashi)	4	5	9	8
248		SLO	Karate klub Polzela[3](KK Polzela[3])	0	3	3	3
249		SLO	Karate klub SEKI[1](KK Seki[1])	9	11	20	12
250		SLO	Karate klub Zalec[1](kk zalec[1])	2	0	2	2
251		SLO	Karate sekcija TVD Partizan Ljutomer(Karate Ljutomer)	0	3	3	3
252		SLO	Klub borilnih veščin FIGHT CLUB SHONY(Klub BVFC SHONY)	1	1	2	2
253		SLO	SHOTOKAN KARATE KLUB OPLOTNICA[1](SKK OPLOTNICA[1])	2	8	10	6
254		SLO	lovrenc na pohorju(lovrenc)	1	3	4	3
255		SLO	ŠPORTNO DRUŠTVO GORICA[1](ŠD GORICA[1])	3	1	4	4

31ST KARATE GRAND PRIX CROATIA

CROATIA

2023.01.20 - 2023.01.22

CITY SPORTS HALL SAMOBOR, ANDRIJE HEBRANGA 26A, SAMOBOR, CROATIA

Participation List (by Club/Team)

256		SRB	KK Mladost Novo Milosevo(KK Mladost Novo Milosevo)	0	1	1	1
257		SRB	Karate Academy Bushido(KA Bushido)	1	1	2	2
258		SRB	Karate Klub Hajduk Kula(K.K. Hajduk Kula)	0	1	1	1
259		SRB	Karate klub Borac 021[1](KK Borac 021[1])	2	0	2	2
260		SRB	Karate klub Dinamo Pančevo(KK Dinamo Pančevo)	4	0	4	4
261		SRB	Karate klub Elid-Niš(KK Elid-Niš)	1	0	1	1
262		SRB	Karate klub Poletarac(KK Poletarac)	0	1	1	1
263		SRB	Karate klub Zadrugar(Lazarevo)	0	1	1	1
264		SRB	Karate klub Zandarmerija(KK Zandarmerija)	2	2	4	3
265		SRB	Karate klub Šampioni - Banja Koviljaca(KK Šampioni - BK)	1	1	2	2
266		SRB	Klub kontaktnih sportova Borac - Čačak(KKS Borac - Čačak)	8	5	13	13
267		SRB	Partizan[1](Kkpartizan[1])	0	2	2	2
268		SRB	Skipper(Beograd)	1	2	3	2
269		SRB	Sportsko udruženje Spartanci 026 - S. Palanka(SU Spartanci 026 - S.Palanka)	2	0	2	1
270		SRB	Studentski grad(Stg)	4	0	4	3
271		SRB	karate klub Čukarički Roda Beograd(Roda Beograd)	1	2	3	2
272		SVK	KARATE KLUB KRETOVIČ KOŠICE(KK KRETOVIČ Košice)	1	2	3	3
273		SVK	KARATE KLUB SHIHAN POPRAD(SHIHAN POPRAD)	2	0	2	1
274		SVK	Karate Klub Seiwa Bratislava(KKSBA)	1	0	1	1
275		SVK	Slovak National Team[5](SVK[5])	38	24	62	55
276		SVK	Sport School Karate Bratislava[1](SSK BA[1])	9	3	12	7
277		SVK	Tornado Karate team(KKTORNR)	1	1	2	2
278		SVK	UPJŠ Košice[2](UPJŠ KE[2])	1	0	1	1
279		SVK	karate klub Detva[3](kk.Detva[3])	0	1	1	1
280		SVK	ŠK CMK Banská Bystrica[6](CMK BB[6])	8	7	15	15
281		SVK	ŠK KARATE KACHI Nitra[2][3](KACHI[3])	1	0	1	1
282		UKR	Alpha Sport Karate Club(ASC)	3	5	8	6
283		UKR	Champion Karate Club(Champion Karate Club)	23	8	31	24
284		UKR	KARATE TEAM CONCORDIA[3](CONCORDIA[3])	16	3	19	14
285		UKR	Katana (Katana)	15	9	24	19
286		UKR	LEON karate club(LEON karate club)	0	5	5	4
287		UKR	Leader Team(Leader)	14	3	17	15
288		UKR	Legion-Odessa(Legion-Odessa)	1	0	1	1
289		UKR	MOWGLY KARATE CLUB[11](MOWGLY KC)	1	3	4	3
290		UKR	OKINAWA[5](oki[5])	4	8	12	6
291		UKR	Senbin karate club(Senbin)	3	0	3	3
292		UKR	Shogun Sports Corporation - Kyiv(SFC KYIV)	1	3	4	3





31ST KARATE GRAND PRIX CROATIA

CROATIA

2023.01.20 - 2023.01.22

CITY SPORTS HALL SAMOBOR, ANDRIJE HEBRANGA 26A, SAMOBOR, CROATIA



Participation List (by Club/Team)

293		UKR	Taikan Ukraine(Taikan Ukraine)	0	1	1	1
294		UKR	Tiger Team[2](Tiger Team[2])	25	12	37	24
295		UKR	UNION TEAM(Union team)	6	2	8	8
296		UKR	Zakhyst karate club(Zakhyst)	2	2	4	2
297		USA	Singleton(Singleton)	0	3	3	2
Totals:				1011	750	1761	1491

31ST KARATE GRAND PRIX CROATIA

CROATIA 2023.01.20 - 2023.01.22
CITY SPORTS HALL SAMOBOR, ANDRIJE HEBRANGA 26A, SAMOBOR, CROATIA

Tournament Participation (Entries) by Club

 AUSTRIA					
 ASKÖ Karate Kara(Kara)					
ID	Sex	Family Name	Given Name	Category	
1	Female	Hollweger	Anja	Kata female seniors	

Entries: 1

31ST KARATE GRAND PRIX CROATIA

CROATIA

2023.01.20 - 2023.01.22

CITY SPORTS HALL SAMOBOR, ANDRIJE HEBRANGA 26A, SAMOBOR, CROATIA

Tournament Participation (Entries) by Club

 Inoue-ha Karate-do Feldkirchen(KC Feldkirchen)					
ID	Sex	Family Name	Given Name	Category	
2	Male	Köstenbaumer	Hannes	Kata male seniors R2-G1	
3	Male	Köstenbaumer	Hannes	Kata male seniors	
4	Female	Rath	Jutta	Kata female seniors	
5	Male	Valet	Patrick	Kata male seniors R3-G2	
6	Male	Valet	Patrick	Kata male seniors	
7	Male	Valet	Patrick	Kata male seniors R2-G2	

Entries: 6

31ST KARATE GRAND PRIX CROATIA

CROATIA

2023.01.20 - 2023.01.22

CITY SPORTS HALL SAMOBOR, ANDRIJE HEBRANGA 26A, SAMOBOR, CROATIA

Tournament Participation (Entries) by Club

 KARATE VORARLBERG(KARATE VORARLBERG)					
	ID	Sex	Family Name	Given Name	Category
8	AUT2029	Male	Deger	Alper	Kata male seniors
9	AUT2057	Male	Forster	Vincent	Kata male seniors

Entries: 2

31ST KARATE GRAND PRIX CROATIA

CROATIA

2023.01.20 - 2023.01.22

CITY SPORTS HALL SAMOBOR, ANDRIJE HEBRANGA 26A, SAMOBOR, CROATIA

Tournament Participation (Entries) by Club

 Karate-Do Weiz(Karate-Do Weiz)					
ID	Sex	Family Name	Given Name	Category	
10	SD581336	Male	List	Fabio	KATA BOYS 14 YEARS

Entries: 1

31ST KARATE GRAND PRIX CROATIA

CROATIA 2023.01.20 - 2023.01.22
CITY SPORTS HALL SAMOBOR, ANDRIJE HEBRANGA 26A, SAMOBOR, CROATIA

Tournament Participation (Entries) by Club

 LZ KARATE NIEDERÖSTERREICH(LZKNÖ)					
ID	Sex	Family Name	Given Name	Category	
11	Female	Celo	Funda	Kata female seniors R3 Bronze Medal Match 1	
12	Female	Celo	Funda	Kata female seniors	
13	Female	Celo	Funda	Kata female seniors R2-G1	
14	Female	Celo	Isra	Kata female seniors	
15	Female	Celo	Sima	KATA FEMALE JUNIORS	
16	Female	Celo	Sima	KATA FEMALE JUNIORS R4 Gold Medal Match	
17	Female	Celo	Sima	KATA FEMALE JUNIORS R3-G1	
18	Female	Celo	Sima	KATA FEMALE JUNIORS R2-G1	
19	Male	Matky	Ronald	Kata male seniors	
20	Male	Zöchling	Florian	Kata male seniors	
21	Male	Zöchling	Florian	Kata male seniors R2-G1	

Entries: 11

31ST KARATE GRAND PRIX CROATIA

CROATIA

2023.01.20 - 2023.01.22

CITY SPORTS HALL SAMOBOR, ANDRIJE HEBRANGA 26A, SAMOBOR, CROATIA

Tournament Participation (Entries) by Club



 Shiai Karate-Do Wien(Shiai Karate-Do)					
ID	Sex	Family Name	Given Name	Category	
22	Female	Kovacevic	Leoni	KUMITE GIRLS 13-14 YEARS -59KG	

Entries: 1

31ST KARATE GRAND PRIX CROATIA

CROATIA 2023.01.20 - 2023.01.22
CITY SPORTS HALL SAMOBOR, ANDRIJE HEBRANGA 26A, SAMOBOR, CROATIA

Tournament Participation (Entries) by Club

 AZERBAIJAN					
 National Karate Federation(NKF)					
ID	Sex	Family Name	Given Name	Category	
23	Male	Ahadov	Sahib	K12 - MALE SENIORS VISUALLY IMPAIRED	
24	Male	Ahadov	Sahib	K11 - MALE SENIORS VISUALLY IMPAIRED	
25	Male	Ahmadzada	Turan	KATA male cadets	
26	Male	Almuradli	Shahin	KUMITE BOYS 11-12 YEARS -34KG	
27	Male	Azim	Rahib	Kumite male juniors -76kg	
28	Male	Gurbanli	Eldar	KUMITE BOYS 9-10 YEARS -27KG	
29	Female	Gurbanzade	Zahra	K22 - FEMALE SENIORS INTELLECTUALLY IMPAIRED	
30	Female	Gurbanzade	Zahra	kata female U21	
31	Female	Gurbanzade	Zahra	Kata female seniors	
32	Male	Hasanov	Vahid	Kumite male juniors +76kg	
33	Female	Heydarova	Ramila	KATA female cadets	
34	Male	Huseynzade	Huseyn	Kumite Male U21 -84kg	
35	Male	Ismayilov	Musa	KUMITE BOYS 9-10 YEARS -27KG	
36	Male	Karimli	Nijat	Kumite Male U21 -75kg	
37	Male	Karimzada	Nihad	Kumite male juniors -76kg	
38	Male	Khamoyev	Ismayil	Kumite male cadets -52kg	
39	Male	Khamoyev	Mahammad	Kumite male juniors -68kg	
40	Male	Khamoyev	Mahammad	Kumite male juniors -76kg	
41	Male	Mahmudov	Adil	Kumite male juniors +76kg	
42	Male	Mammadli	Huseyn	Kumite Male U21 -67kg	
43	Female	Mammadova	Fatima	Kumite female cadets -47kg	
44	Female	Mammadova	Samira	KATA FEMALE JUNIORS	
45	Male	Mammadzada	Nihat	K11 - MALE SENIORS VISUALLY IMPAIRED	
46	Female	Mitlinova	Ariana	K11 - FEMALE SENIORS VISUALLY IMPAIRED	
47	Female	Mitlinova	Emiliya	K11 - FEMALE SENIORS VISUALLY IMPAIRED	
48	Female	Nakonechnaya	Oksana	Kumite female juniors -59kg	
49	Male	Osmanli	Osman	Kumite Male U21 +84kg	
50	Male	Rahib	Azim	Kumite male cadets +70kg	
51	Female	Rahimova	Ayshah	K11 - FEMALE SENIORS VISUALLY IMPAIRED	
52	Female	Rzazade	Ayla	Kumite Female U21 - 61kg	
53	Male	Rzazade	Nuran	Kumite Male U21 -67kg	
54	Male	Salmanov	Salman	KATA male cadets	
55	Male	SAVADOV	FARID	Kumite male juniors -55kg	
56	Male	Suleymanov	Rashid	Kumite male juniors -68kg	
57	Male	Talibov	Ali	KUMITE BOYS 13-14 YEARS -49KG	
58	Male	Yadigarli	Amin	Kumite male juniors -61kg	

Entries: 36

31ST KARATE GRAND PRIX CROATIA

CROATIA 2023.01.20 - 2023.01.22
CITY SPORTS HALL SAMOBOR, ANDRIJE HEBRANGA 26A, SAMOBOR, CROATIA

Tournament Participation (Entries) by Club

BOSNIA AND HERZEGOVINA					
Karate klub Novi Grad Sarajevo(_KK Novi Grad Sa_)					
ID	Sex	Family Name	Given Name	Category	
59	Male	Delić	Alija	Kumite Male U21 -75kg	
60	Female	Rudalija	Šila	Kumite female Juniors +66kg	

Entries: 2

31ST KARATE GRAND PRIX CROATIA

CROATIA

2023.01.20 - 2023.01.22

CITY SPORTS HALL SAMOBOR, ANDRIJE HEBRANGA 26A, SAMOBOR, CROATIA

Tournament Participation (Entries) by Club

 Bilanović(Bilanović)					
ID	Sex	Family Name	Given Name	Category	
61	Female	Bilanović	ADNA	Kumite Female U21 -55kg	
62	Male	Bilanović	Imran	Kumite male cadets +70kg	
63	Female	Bilanović	umihana	KUMITE GIRLS 11-12 YEARS -34KG	
64	Female	hana	vražalica	KUMITE GIRLS 9-10 YEARS -31kg	
65	Female	imamovic	nejla	KUMITE GIRLS 13-14 YEARS -54KG	
66	Male	kaltak	alen	Kumite male cadets -63kg	
67	Female	kaltak	larisa	KUMITE GIRLS 11-12 YEARS -44KG	
68	Female	sahinovic	medina	KUMITE GIRLS 13-14 YEARS -64KG	

Entries: 8

31ST KARATE GRAND PRIX CROATIA

CROATIA 2023.01.20 - 2023.01.22
CITY SPORTS HALL SAMOBOR, ANDRIJE HEBRANGA 26A, SAMOBOR, CROATIA

Tournament Participation (Entries) by Club

 KARATE AKADEMIJA - ARNELA ODŽAKOVIĆ(KARATE AKADEMIJA - ARNELA ODŽAKOVI..					
ID	Sex	Family Name	Given Name	Category	
69	Female	Brkanic	Amna	KUMITE GIRLS 11-12 YEARS -39KG	
70	Female	Bubalo	Nahla	KUMITE GIRLS 13-14 YEARS -59KG	
71	Female	BUKVA	AJSA	KUMITE GIRLS 11-12 YEARS -44KG	
72	Female	Curovac	Sena	Kumite Female U21 - 61kg	
73	Male	Gracic	Dan	KUMITE BOYS 11-12 YEARS -49KG	
74	Female	Hadzic	Azra	KATA GIRLS 11 YEARS	
75	Female	Hadzic	Azra	KUMITE GIRLS 11-12 YEARS -34KG	
76	Female	Islamagic	Ilda	KUMITE GIRLS 11-12 YEARS -49KG	
77	Male	Kadric	Faruk	Kumite male juniors -55kg	
78	Male	Memišević	Kenan	Kumite Male U21 -67kg	
79	Female	Rastoder	Hena	Kumite female cadets -54kg	
80	Female	Rebronja	Adna	Kumite Female U21 -50kg	
81	Male	Serdarevic	Nedim	KATA MALE JUNIORS	
82	Female	Siljak	Asija	Kumite female Juniors -66kg	
83	Female	Talic	Lejla	KATA GIRLS 10 YEARS	
84	Female	Talic	Lejla	KUMITE GIRLS 9-10 YEARS -31kg	
85	Female	Topic	Kaja	Kumite female Cadets +61kg	

Entries: 17

31ST KARATE GRAND PRIX CROATIA

CROATIA

2023.01.20 - 2023.01.22

CITY SPORTS HALL SAMOBOR, ANDRIJE HEBRANGA 26A, SAMOBOR, CROATIA

Tournament Participation (Entries) by Club

 Karate klub DO Tuzla(KK DO Tuzla)					
ID	Sex	Family Name	Given Name	Category	
86	Female	Ascic	Sejla	KUMITE GIRLS 13-14 YEARS -59KG	
87	Female	Ibrahimovic	Melina	Kumite female Juniors +66kg	
88	Male	Kresic	Sandro	Kumite Male U21 +84kg	

Entries: 3

31ST KARATE GRAND PRIX CROATIA

CROATIA

2023.01.20 - 2023.01.22

CITY SPORTS HALL SAMOBOR, ANDRIJE HEBRANGA 26A, SAMOBOR, CROATIA

Tournament Participation (Entries) by Club

Karate Klub Energija(Energija)					
ID	Sex	Family Name	Given Name	Category	
89	Male	Dujaković	Pavle	Kumite Male U21 -60kg	
90	Male	Pejić	Luka	Kumite male juniors -61kg	
91	Male	Popović	Luka	Kumite male juniors -55kg	
92	Male	Stanić	Mihajlo	Kumite Male U21 -60kg	
93	Male	Zrnić	Mihajlo	Kumite Male U21 -67kg	
94	Male	Zrnić	Mihajlo	Kumite male juniors -68kg	
95	Female	Čučak	Nikolina	Kumite female juniors -59kg	

Entries: 7

31ST KARATE GRAND PRIX CROATIA

CROATIA

2023.01.20 - 2023.01.22

CITY SPORTS HALL SAMOBOR, ANDRIJE HEBRANGA 26A, SAMOBOR, CROATIA

Tournament Participation (Entries) by Club

KARATE KLUB FENIKS(KK FENIKS)					
ID	Sex	Family Name	Given Name	Category	
96	Male	MUSIC	ADIN	KATA male cadets	

Entries: 1

31ST KARATE GRAND PRIX CROATIA

CROATIA 2023.01.20 - 2023.01.22
CITY SPORTS HALL SAMOBOR, ANDRIJE HEBRANGA 26A, SAMOBOR, CROATIA

Tournament Participation (Entries) by Club

Karate klub Kumite(KK KUMITE Jajce)					
ID	Sex	Family Name	Given Name	Category	
97	Male	Barisic	Ivan	KUMITE BOYS 11-12 YEARS -44KG	
98	Male	Bungic	Petar	KUMITE BOYS 11-12 YEARS -44KG	
99	Male	Durakovic	Hamza	KUMITE BOYS 13-14 YEARS -44KG	
100	Female	Hadžić	Azra	KUMITE GIRLS 11-12 YEARS -54KG	
101	Female	Hajder	Ajna	KUMITE GIRLS 13-14 YEARS -54KG	
102	Male	Hrnjic	Ahmed	KUMITE BOYS 13-14 YEARS -44KG	
103	Male	Hrnjic	Ismail	KUMITE BOYS 13-14 YEARS -44KG	
104	Female	Jurisic	Patricija	Kumite female cadets -47kg	
105	Male	Katic	Ivan	Kumite male juniors -76kg	
106	Male	Kulenovic	Sergej	Kumite male juniors -76kg	
107	Female	Đakovic	Nikolina	Kumite female Cadets -61kg	

Entries: 11

31ST KARATE GRAND PRIX CROATIA

CROATIA

2023.01.20 - 2023.01.22

CITY SPORTS HALL SAMOBOR, ANDRIJE HEBRANGA 26A, SAMOBOR, CROATIA

Tournament Participation (Entries) by Club

Karate klub Posušje(KK Posušje)					
ID	Sex	Family Name	Given Name	Category	
108	Female	Rezo	Lea	Kumite female Cadets +61kg	

Entries: 1

31ST KARATE GRAND PRIX CROATIA

CROATIA 2023.01.20 - 2023.01.22
CITY SPORTS HALL SAMOBOR, ANDRIJE HEBRANGA 26A, SAMOBOR, CROATIA

Tournament Participation (Entries) by Club

Karate klub Rašid Buća(K.K Rašid Buća)					
ID	Sex	Family Name	Given Name	Category	
109	Male	BRKIĆ	IMRAN	Kumite male juniors -61kg	
110	Male	Habibović	Nasko	KUMITE BOYS 13-14 YEARS -49KG	
111	Female	Hasanović	Alisa	KUMITE GIRLS 13-14 YEARS -54KG	
112	Male	Herić	Nedim	KUMITE BOYS 11-12 YEARS -44KG	
113	Female	Jusić	Saudina	KUMITE GIRLS 13-14 YEARS -54KG	
114	Male	Kadrić	Muamer	Kumite male juniors -68kg	
115	Male	Pjevo	Armin	KUMITE BOYS 11-12 YEARS -49KG	
116	Female	Softić	Ajna	KUMITE GIRLS 13-14 YEARS +64KG	

Entries: 8

31ST KARATE GRAND PRIX CROATIA

CROATIA 2023.01.20 - 2023.01.22
CITY SPORTS HALL SAMOBOR, ANDRIJE HEBRANGA 26A, SAMOBOR, CROATIA

Tournament Participation (Entries) by Club

Karate Klub Regeneracija(KK Regeneracija)					
ID	Sex	Family Name	Given Name	Category	
117	Male	Beganović	Aris	KATA BOYS 7 YEARS	
118	Male	Beganović	Taris	KATA BOYS 13 YEARS	
119	Male	Beganović	Taris	KUMITE BOYS 13-14 YEARS -49KG	
120	Male	Dizdarević	Armen	KUMITE BOYS 13-14 YEARS -69KG	
121	Male	Miskiċ	Elmin	KUMITE BOYS 11-12 YEARS -49KG	
122	Male	Miskiċ	Elmin	KATA BOYS 12 YEARS	
123	Male	Pajzetović	Danis	KATA BOYS 10 YEARS	
124	Male	Pajzetović	Danis	KUMITE BOYS 9-10 YEARS -35kg	
125	Female	Ružnić	Iman	Kumite female Cadets -61kg	
126	Male	Šakinović	Adnan	KUMITE BOYS 11-12 YEARS -44KG	

Entries: **10**

31ST KARATE GRAND PRIX CROATIA

CROATIA 2023.01.20 - 2023.01.22
CITY SPORTS HALL SAMOBOR, ANDRIJE HEBRANGA 26A, SAMOBOR, CROATIA

Tournament Participation (Entries) by Club

KARATE KLUB RESPECT(KK RESPECT)					
ID	Sex	Family Name	Given Name	Category	
127	Female	ALIBALIĆ	ZARA	KATA GIRLS 13 YEARS	
128	Female	BALIĆ	BERINA	KUMITE GIRLS 11-12 YEARS +54KG	
129	Female	BAŠAGIĆ	EDNA	KATA GIRLS 12 YEARS	
130	Male	FAZLIĆ	KAAN	KATA BOYS 10 YEARS	
131	Male	GADŽO	ADIS	KUMITE BOYS 13-14 YEARS -54KG	
132	Male	HERCEGOVAC	TARIK	KUMITE BOYS 11-12 YEARS +54KG	
133	Male	KORJENIĆ	TARIK	KUMITE BOYS 13-14 YEARS -54KG	
134	Female	MEHANOVIĆ	BERINA	KATA GIRLS 14 YEARS	
135	Male	RAHMANOVIĆ	IMRAN	KUMITE BOYS 13-14 YEARS -59KG	

Entries: 9

31ST KARATE GRAND PRIX CROATIA

CROATIA

2023.01.20 - 2023.01.22

CITY SPORTS HALL SAMOBOR, ANDRIJE HEBRANGA 26A, SAMOBOR, CROATIA

Tournament Participation (Entries) by Club

 Karate klub Sambon - Vogosca(KK Sambon - Vogosca)					
ID	Sex	Family Name	Given Name	Category	
136	Male	Smajic	Harun	Kumite male cadets -70kg	
137	Male	Zundja	Amir	KUMITE BOYS 11-12 YEARS -54KG	
138	Male	Zunda	Emir	KUMITE BOYS 11-12 YEARS +54KG	

Entries: 3

31ST KARATE GRAND PRIX CROATIA

CROATIA

2023.01.20 - 2023.01.22

CITY SPORTS HALL SAMOBOR, ANDRIJE HEBRANGA 26A, SAMOBOR, CROATIA

Tournament Participation (Entries) by Club

 Karate Klub Sampioni(Sampioni)					
ID	Sex	Family Name	Given Name	Category	
139	Male	Markovic	Lazar	Kumite Male U21 -67kg	
140	Male	Novicki	Aleksandar	Kumite Male U21 +84kg	
141	Male	Paljevac	Sinan	Kumite male juniors -68kg	
142	Male	Simic	Milos	Kumite male juniors +76kg	
143	Male	Simic	Milos	Kumite male juniors -76kg	

Entries: 5

31ST KARATE GRAND PRIX CROATIA

CROATIA 2023.01.20 - 2023.01.22
CITY SPORTS HALL SAMOBOR, ANDRIJE HEBRANGA 26A, SAMOBOR, CROATIA

Tournament Participation (Entries) by Club

 Karate klub Slavija(KK Slavija)					
ID	Sex	Family Name	Given Name	Category	
144	Male	Kovačević	Stefan	Kumite male juniors -68kg	
145	Female	Kurteš	Marina	Kumite Female U21 - 61kg	
146	Male	Čuković	Luka	Kumite Male U21 -67kg	

Entries: 3

31ST KARATE GRAND PRIX CROATIA

CROATIA

2023.01.20 - 2023.01.22

CITY SPORTS HALL SAMOBOR, ANDRIJE HEBRANGA 26A, SAMOBOR, CROATIA

Tournament Participation (Entries) by Club

Karate klub Travnik GS-TMT(KK Travnim GS-TMT)					
ID	Sex	Family Name	Given Name	Category	
147	Male	Arnautović	Ali	Kumite male cadets -57kg	
148	Female	Arnautović	Zahra	KUMITE GIRLS 11-12 YEARS -34KG	
149	Male	Halilović	Salih	Kumite Male U21 +84kg	
150	BIH03169	Male	Jašarević	Kerim	Kumite male juniors -61kg
151	Female	Pašić	Karla	KATA GIRLS 10 YEARS	
152	Female	Pašić	Karla	KUMITE GIRLS 9-10 YEARS -27kg	
153	Male	Šiljak	Kenan	Kumite male juniors -61kg	

Entries: 7

31ST KARATE GRAND PRIX CROATIA

CROATIA 2023.01.20 - 2023.01.22
CITY SPORTS HALL SAMOBOR, ANDRIJE HEBRANGA 26A, SAMOBOR, CROATIA

Tournament Participation (Entries) by Club

Karate Klub Vezir(KK Vezir)					
ID	Sex	Family Name	Given Name	Category	
154	Male	Berbić	Ibrahim-Džan	KATA BOYS 10 YEARS	
155	Male	Berbić	Ibrahim-Džan	KATA BOYS 9 YEARS	
156	Male	Gradinčić	Vedad	KUMITE BOYS 11-12 YEARS -34KG	
157	Male	Halep	Eman	KUMITE BOYS 9-10 YEARS -35kg	
158	Female	Kasumović	Nejla	KUMITE GIRLS 13-14 YEARS -49KG	
159	Male	Muratović	El Harun	Kumite male juniors -76kg	
160	Female	Palić	Adna	Kumite female juniors -53kg	
161	Female	Selman	Ajra	Kumite female Cadets +61kg	
162	BIH2823	Male	Zolota	Kumite male juniors -55kg	
163	Female	Čurić	Berina	Kumite female Cadets +61kg	

Entries: **10**

31ST KARATE GRAND PRIX CROATIA

CROATIA

2023.01.20 - 2023.01.22

CITY SPORTS HALL SAMOBOR, ANDRIJE HEBRANGA 26A, SAMOBOR, CROATIA

Tournament Participation (Entries) by Club

 KARATE KLUB WINNER TUZLA(KK WINNER TUZLA)					
ID	Sex	Family Name	Given Name	Category	
164	Female	BRKOVIC	BERINA	KUMITE GIRLS 11-12 YEARS +54KG	

Entries: 1

31ST KARATE GRAND PRIX CROATIA

CROATIA

2023.01.20 - 2023.01.22

CITY SPORTS HALL SAMOBOR, ANDRIJE HEBRANGA 26A, SAMOBOR, CROATIA

Tournament Participation (Entries) by Club

 Karate klub Zanshin Banja Luka(KK Zanshin BL)					
ID	Sex	Family Name	Given Name	Category	
165	Male	GRADAN	VEDAD	KATA BOYS 9 YEARS	

Entries: 1

31ST KARATE GRAND PRIX CROATIA

CROATIA

2023.01.20 - 2023.01.22

CITY SPORTS HALL SAMOBOR, ANDRIJE HEBRANGA 26A, SAMOBOR, CROATIA

Tournament Participation (Entries) by Club

 Karate klub ZANSHIN Sarajevo(KK ZANSHIN)					
ID	Sex	Family Name	Given Name	Category	
166	Male	BARLOV	ADIN	Kumite Male U21 -75kg	
167	Male	Efendić	Mak	Kumite Male U21 -75kg	
168	Male	Gibanica	Ermin	Kumite male cadets +70kg	
169	Female	Gušo	Džejlan	Kumite Female U21 - 68kg	
170	Male	ĆUBARA	EMAN	Kumite male cadets -70kg	

Entries: 5

31ST KARATE GRAND PRIX CROATIA

CROATIA

2023.01.20 - 2023.01.22

CITY SPORTS HALL SAMOBOR, ANDRIJE HEBRANGA 26A, SAMOBOR, CROATIA

Tournament Participation (Entries) by Club

 Karate klub Šampion(Kk Šampion)					
ID	Sex	Family Name	Given Name	Category	
171	Male	Dabić	Milan BL	Kumite male juniors -68kg	
172	Male	Jovanović	Luka	Kumite male juniors +76kg	
173	Male	Jovanović	Srđan	KUMITE MALE SENIORS	
174	Male	Jovanović	Srđan	Kumite Male U21 +84kg	
175	Female	Marić	Marija	Kumite female Cadets +61kg	

Entries: 5

31ST KARATE GRAND PRIX CROATIA

CROATIA 2023.01.20 - 2023.01.22
CITY SPORTS HALL SAMOBOR, ANDRIJE HEBRANGA 26A, SAMOBOR, CROATIA

Tournament Participation (Entries) by Club

 Karate klub ŠIROKI Široki Brijeg(KK ŠIROKI)					
ID	Sex	Family Name	Given Name	Category	
176	Male	Bilać	Karlo	KUMITE BOYS 9-10 YEARS -31kg	
177	Male	Čolak	Stanko	KUMITE BOYS 13-14 YEARS +69KG	

Entries: 2

31ST KARATE GRAND PRIX CROATIA

CROATIA 2023.01.20 - 2023.01.22
CITY SPORTS HALL SAMOBOR, ANDRIJE HEBRANGA 26A, SAMOBOR, CROATIA

Tournament Participation (Entries) by Club

KBES 5.11-BK BOSANSKA KRUPA(KBES 5.11-BK)					
ID	Sex	Family Name	Given Name	Category	
178	Female	Hena	Ramić	KATA GIRLS 12 YEARS	
179	Male	Ramić	Faris	KATA male cadets	
180	Male	Veladžić	Alem	KATA BOYS 14 YEARS	
181	213	Male	Veladžić	Senaid	Kata male seniors R2-G2
182	213	Male	Veladžić	Senaid	kata male U21
183	213	Male	Veladžić	Senaid	Kata male seniors R4 Bronze Medal Match 2
184	213	Male	Veladžić	Senaid	kata male U21 R2-G1
185	213	Male	Veladžić	Senaid	Kata male seniors R3-G2
186	213	Male	Veladžić	Senaid	Kata male seniors

Entries: 9

31ST KARATE GRAND PRIX CROATIA

CROATIA

2023.01.20 - 2023.01.22

CITY SPORTS HALL SAMOBOR, ANDRIJE HEBRANGA 26A, SAMOBOR, CROATIA

Tournament Participation (Entries) by Club

 KK BOSNJAK KONJIC(KK BOSNJAK KONJIC)					
ID	Sex	Family Name	Given Name	Category	
187	BIH2358	Male	Halilović	Omar	Kumite male juniors +76kg

Entries: 1

31ST KARATE GRAND PRIX CROATIA

CROATIA 2023.01.20 - 2023.01.22
CITY SPORTS HALL SAMOBOR, ANDRIJE HEBRANGA 26A, SAMOBOR, CROATIA

Tournament Participation (Entries) by Club

 KK IPPON Sarajevo(IPPON SARAJEVO)					
ID	Sex	Family Name	Given Name	Category	
188	Female	Sipovic	Ajla	Kumite female Juniors -66kg	
189	Female	Sipovic	Emina	Kumite Female U21 - 61kg	
190	Female	Sipovic	Nejra	Kumite Female U21 -55kg	

Entries: 3

31ST KARATE GRAND PRIX CROATIA

CROATIA 2023.01.20 - 2023.01.22
CITY SPORTS HALL SAMOBOR, ANDRIJE HEBRANGA 26A, SAMOBOR, CROATIA

Tournament Participation (Entries) by Club

KK Master Bugojno(Master)					
ID	Sex	Family Name	Given Name	Category	
191	Male	Beganović	Ahmed	KUMITE BOYS 13-14 YEARS -54KG	
192	Male	Beganović	Mehmed	KUMITE BOYS 13-14 YEARS -44KG	
193	Male	Kriezju	Mario	Kumite Male U21 -75kg	
194	Female	Omanović	Lamija	KUMITE GIRLS 11-12 YEARS -49KG	
195	Male	Tihak	Amar	Kumite male cadets -63kg	
196	Female	Čepalo	Ajna	KUMITE GIRLS 13-14 YEARS -59KG	

Entries: 6

31ST KARATE GRAND PRIX CROATIA

CROATIA

2023.01.20 - 2023.01.22

CITY SPORTS HALL SAMOBOR, ANDRIJE HEBRANGA 26A, SAMOBOR, CROATIA

Tournament Participation (Entries) by Club

 KK Mladost Vitez(KK Mladost)					
ID	Sex	Family Name	Given Name	Category	
197	Male	Adilovic	Hamza	KUMITE BOYS 9-10 YEARS -31kg	
198	Female	Adilovic	Zahra	KATA GIRLS 9 YEARS	
199	Female	Bešić	Ema	Kumite female cadets -54kg	
200	Female	Maleš	Dominika	Kumite female Cadets -61kg	

Entries: 4

31ST KARATE GRAND PRIX CROATIA

CROATIA

2023.01.20 - 2023.01.22

CITY SPORTS HALL SAMOBOR, ANDRIJE HEBRANGA 26A, SAMOBOR, CROATIA

Tournament Participation (Entries) by Club

 KK Perfekt Sarajevo(KK Perfekt Sarajevo)					
ID	Sex	Family Name	Given Name	Category	
201	Male	Tarik	Salkic	KATA MALE JUNIORS R3-G1	
202	Male	Tarik	Salkic	KATA MALE JUNIORS R2-G1	
203	Male	Tarik	Salkic	KATA MALE JUNIORS	
204	Male	Tarik	Salkic	Kumite male juniors -68kg	

Entries: 4

31ST KARATE GRAND PRIX CROATIA

CROATIA 2023.01.20 - 2023.01.22
CITY SPORTS HALL SAMOBOR, ANDRIJE HEBRANGA 26A, SAMOBOR, CROATIA

Tournament Participation (Entries) by Club

 Klub borilačkih sportova Tuzla(KBS Tuzla)					
ID	Sex	Family Name	Given Name	Category	
205	Male	Alić	Faris	Kumite male cadets +70kg	
206	Female	Dahalić	Azra	Kumite Female U21 + 68kg	
207	Male	Džinović	Damir	KATA BOYS 12 YEARS	
208	Male	Džinović	Damir	KATA BOYS 13 YEARS	
209	Female	Gutić	Erna	Kumite female Cadets -61kg	
210	Female	Mujanović	Irna	Kumite female juniors -48kg	
211	Male	Osmanbegović	Nedim	Kumite male cadets -70kg	
212	Male	Pipal	Adi	Kumite male cadets +70kg	
213	Male	Pipal	Tony	Kumite male juniors +76kg	
214	Male	Sinanović	Faris	Kumite male juniors -76kg	
215	Female	Softić	Lamija	Kumite female cadets -54kg	

Entries: 11

31ST KARATE GRAND PRIX CROATIA

CROATIA

2023.01.20 - 2023.01.22

CITY SPORTS HALL SAMOBOR, ANDRIJE HEBRANGA 26A, SAMOBOR, CROATIA

Tournament Participation (Entries) by Club

 MAWASHI SARAJEVO(BOSNA)					
ID	Sex	Family Name	Given Name	Category	
216	Male	Busnov	Ahmed	KUMITE BOYS 13-14 YEARS -59KG	
217	Female	Busnov	Almedina	Kumite Female U21 - 68kg	
218	Female	Hodzic	Ismihana	KUMITE GIRLS 13-14 YEARS +64KG	
219	Male	Jasarspahic	Miralem	Kata male seniors	
220	Female	Nezirc	Sajra	KUMITE GIRLS 11-12 YEARS +54KG	
221	Male	Nidal	Helac	KUMITE BOYS 11-12 YEARS +54KG	
222	Male	Setic	Tarik	Kumite male cadets +70kg	

Entries: 7

31ST KARATE GRAND PRIX CROATIA

CROATIA 2023.01.20 - 2023.01.22
CITY SPORTS HALL SAMOBOR, ANDRIJE HEBRANGA 26A, SAMOBOR, CROATIA

Tournament Participation (Entries) by Club

 Samuraj(KK Samuraj)					
ID	Sex	Family Name	Given Name	Category	
223	Female	Hadžić	Azra	KUMITE GIRLS 11-12 YEARS -39KG	
224	Female	Hadžić	Sumeja	Kumite female juniors -59kg	
225	Male	Karamustafić	Faruk	Kumite male cadets -63kg	
226	Male	Nokto	Ahmed	Kumite male juniors +76kg	
227	Female	Omeragić	Ajna1	KUMITE GIRLS 11-12 YEARS -34KG	
228	Male	Omeragić	Ajna1	KUMITE GIRLS 11-12 YEARS -34KG	
229	Female	Omeragić	Asja	Kumite female cadets -54kg	

Entries: 7

31ST KARATE GRAND PRIX CROATIA

CROATIA

2023.01.20 - 2023.01.22

CITY SPORTS HALL SAMOBOR, ANDRIJE HEBRANGA 26A, SAMOBOR, CROATIA

Tournament Participation (Entries) by Club



 Univerzitetski karate klub VRBAS Banja Luka(UKK VRBAS Banja Luka BiH)					
ID	Sex	Family Name	Given Name	Category	
230	Male	Dejanovic	Milos	KUMITE MALE SENIORS	
231	Male	Jelicic	Nemanja	Kumite male cadets +70kg	
232	Male	Zeljic	Nikola	KUMITE MALE SENIORS	

Entries: 3

31ST KARATE GRAND PRIX CROATIA

CROATIA 2023.01.20 - 2023.01.22
CITY SPORTS HALL SAMOBOR, ANDRIJE HEBRANGA 26A, SAMOBOR, CROATIA

Tournament Participation (Entries) by Club

 BULGARIA					
 Karate Club Shuriken(SHURIKEN)					
ID	Sex	Family Name	Given Name	Category	
233	Male	Aprilov	Denis	KATA male cadets	
234	Male	Aprilov	Denis	KATA MALE JUNIORS R2-G1	
235	Male	Aprilov	Denis	KATA MALE JUNIORS	
236	BUL2139	Matuski	Georgi	KATA MALE JUNIORS R4 Gold Medal Match	
237	BUL2139	Matuski	Georgi	kata male U21	
238	BUL2139	Matuski	Georgi	KATA MALE JUNIORS	
239	BUL2139	Matuski	Georgi	KATA MALE JUNIORS R3-G2	
240	BUL2139	Matuski	Georgi	KATA MALE JUNIORS R2-G2	
241	BUL2139	Matuski	Georgi	kata male U21 R2-G1	

Entries: 9

31ST KARATE GRAND PRIX CROATIA

CROATIA

2023.01.20 - 2023.01.22

CITY SPORTS HALL SAMOBOR, ANDRIJE HEBRANGA 26A, SAMOBOR, CROATIA

Tournament Participation (Entries) by Club

 DARIS(Sofia)					
ID	Sex	Family Name	Given Name	Category	
242	Male	Nastev	Todor	Kumite Male U21 -60kg	

Entries: 1

31ST KARATE GRAND PRIX CROATIA

CROATIA 2023.01.20 - 2023.01.22
CITY SPORTS HALL SAMOBOR, ANDRIJE HEBRANGA 26A, SAMOBOR, CROATIA

Tournament Participation (Entries) by Club

 k.k. LEVSKI SPARTAK(LEVSKI)					
ID	Sex	Family Name	Given Name	Category	
243	Male	Ivanov	Emanuil	Kumite male cadets -57kg	
244	Male	Ivanov	Velin	Kumite Male U21 -60kg	
245	Male	Ivanov	Velin	Kumite male juniors -55kg	
246	Female	Mihailova	Kristina	Kumite female cadets -47kg	
247	Female	Mihailova	Kristina	KUMITE GIRLS 13-14 YEARS -49KG	
248	Female	Mircheva	Ivaila	KUMITE GIRLS 11-12 YEARS -34KG	
249	Female	Mircheva	Verzhiniq	Kumite Female U21 -55kg	
250	Female	Mircheva	Verzhiniq	Kumite female juniors -59kg	
251	Male	Petrov	Venislav	KUMITE BOYS 13-14 YEARS -59KG	
252	Male	Stoychev	Simeon	KUMITE MALE SENIORS	
253	Male	Velinov	Kaloyan	Kumite male cadets -52kg	

Entries: 11

31ST KARATE GRAND PRIX CROATIA

CROATIA

2023.01.20 - 2023.01.22

CITY SPORTS HALL SAMOBOR, ANDRIJE HEBRANGA 26A, SAMOBOR, CROATIA

Tournament Participation (Entries) by Club

 Karate club Kaloyan(KK Kaloyan)					
ID	Sex	Family Name	Given Name	Category	
254	Female	Boyadjieva	Adriana	Kumite female cadets -47kg	
255	Female	Marinova	Grasiela	Kumite female juniors -59kg	
256	Female	P3tkova	Mariela	Kumite Female U21 -55kg	
257	Female	Petkova	Mariela	Kumite female juniors -59kg	

Entries: 4

31ST KARATE GRAND PRIX CROATIA

CROATIA

2023.01.20 - 2023.01.22

CITY SPORTS HALL SAMOBOR, ANDRIJE HEBRANGA 26A, SAMOBOR, CROATIA

Tournament Participation (Entries) by Club

 KARATE CLUB TSANEV(KC TSANEV)					
ID	Sex	Family Name	Given Name	Category	
258	Female	Stoimenova	Veneta	Kumite female juniors -59kg	
259	Female	Tsaneva	Teodora	Kumite female juniors -53kg	

Entries: 2

31ST KARATE GRAND PRIX CROATIA

CROATIA 2023.01.20 - 2023.01.22
CITY SPORTS HALL SAMOBOR, ANDRIJE HEBRANGA 26A, SAMOBOR, CROATIA

Tournament Participation (Entries) by Club

 Ronin11 Sofia(Ronin11)					
ID	Sex	Family Name	Given Name	Category	
260	Female	Georgieva	Iveta	KUMITE GIRLS 13-14 YEARS -59KG	
261	Female	Georgieva	Iveta	Kumite female Cadets -61kg	
262	Male	Handzhiev	Boris	KUMITE BOYS 13-14 YEARS -49KG	
263	Male	Mihaylov	Petar	Kumite male juniors -61kg	
264	Male	Mihaylov	Petar	Kumite male cadets -57kg	
265	Male	Mihov	Martin	Kumite male cadets -57kg	
266	Male	Mihov	Martin	KUMITE BOYS 13-14 YEARS -59KG	
267	Female	Nikiforova	Plamena	Kumite female cadets -54kg	
268	Female	Nikolova	Viktorija	Kumite female cadets -47kg	
269	Female	Plamena	Nikiforova	Kumite female juniors -53kg	
270	Male	Vakarelov	Vladislav	Kumite male juniors -68kg	

Entries: 11

31ST KARATE GRAND PRIX CROATIA

CROATIA

2023.01.20 - 2023.01.22

CITY SPORTS HALL SAMOBOR, ANDRIJE HEBRANGA 26A, SAMOBOR, CROATIA

Tournament Participation (Entries) by Club

 SHIELD NOVI ISKAR - CSKA(SHIELD - CSKA)					
ID	Sex	Family Name	Given Name	Category	
271	Male	Bistrichanov	Michael	Kumite male juniors +76kg	
272	Male	Bistrichanov	Michael	Kumite Male U21 +84kg	

Entries: 2

31ST KARATE GRAND PRIX CROATIA

CROATIA

2023.01.20 - 2023.01.22

CITY SPORTS HALL SAMOBOR, ANDRIJE HEBRANGA 26A, SAMOBOR, CROATIA

Tournament Participation (Entries) by Club



 Файтърс-НСА(Fighters-NSA)					
ID	Sex	Family Name	Given Name	Category	
273	Male	Tsvyatkov	nikolay	KUMITE BOYS 7-8 YEARS -28kg	
274	Male	Tsvyatkov	nikolay	KATA BOYS 8 YEARS	
275	Male	valkov	nikolay	KUMITE BOYS 13-14 YEARS -59KG	

Entries: 3

31ST KARATE GRAND PRIX CROATIA

CROATIA 2023.01.20 - 2023.01.22
CITY SPORTS HALL SAMOBOR, ANDRIJE HEBRANGA 26A, SAMOBOR, CROATIA

Tournament Participation (Entries) by Club

 CROATIA					
 CBS PULA(CBS PULA)					
ID	Sex	Family Name	Given Name	Category	
276	Female	MILAS	MIA	Kumite female juniors -59kg	
277	Male	udović	ivan	Kumite male juniors -55kg	

Entries: 2

31ST KARATE GRAND PRIX CROATIA

CROATIA

2023.01.20 - 2023.01.22

CITY SPORTS HALL SAMOBOR, ANDRIJE HEBRANGA 26A, SAMOBOR, CROATIA

Tournament Participation (Entries) by Club

 ENPI RAB(ENPI rab)					
ID	Sex	Family Name	Given Name	Category	
278	Male	BRAVARIĆ ĆILO	DAMJAN	KATA MALE JUNIORS	
279	Male	FAFANDEL	DORIAN	kata male U21	
280	Male	KEKO	LUKA	KATA MALE JUNIORS	
281	Male	MATUŠAN	ANTONIO	kata male U21	
282	Male	TOMIČIĆ	IVANO	KATA male cadets	

Entries: 5

31ST KARATE GRAND PRIX CROATIA

CROATIA 2023.01.20 - 2023.01.22
CITY SPORTS HALL SAMOBOR, ANDRIJE HEBRANGA 26A, SAMOBOR, CROATIA

Tournament Participation (Entries) by Club

 GLOBUS ČAKOVEC(GLOBUS)					
ID	Sex	Family Name	Given Name	Category	
283	Female	Balog	Tesa	KUMITE GIRLS 9-10 YEARS -39kg	
284	Male	Bermanec	David	KUMITE BOYS 13-14 YEARS -54KG	
285	Male	Farkaš	Lovro	Kumite male juniors -61kg	
286	Female	FILIPOVIĆ	ANA	Kumite Female U21 + 68kg	
287	Male	Filipović	Petar	KUMITE BOYS 11-12 YEARS +54KG	
288	Female	Gulija	Leona.	Kumite female Juniors -66kg	
289	Female	Magdalenić	Paulina	KUMITE GIRLS 13-14 YEARS -54KG	
290	Female	MARČEC	EMA	Kumite female Juniors -66kg	
291	Male	Novak	Leon	KUMITE BOYS 9-10 YEARS -35kg	
292	Male	Panić	Tino	KUMITE BOYS 13-14 YEARS -44KG	
293	Male	Slukić	Petar	KUMITE BOYS 13-14 YEARS -54KG	
294	Female	STRAHIJA	LAURA	Kumite female Cadets -61kg	
295	Male	STRAHIJA	SVEN	Kumite male cadets -70kg	
296	Male	Topličanec	Kristian	Kumite Male U21 -60kg	
297	Male	Topličanec	Nikola	Kumite male juniors -55kg	
298	Male	Topličanec	Nikola	Kumite Male U21 -60kg	
299	Female	TRSTENJAK	AIDA	Kumite female cadets -47kg	
300	Female	Vurušić	Tena	KUMITE GIRLS 11-12 YEARS -54KG	
301	Female	Šestak	Dalia	KUMITE GIRLS 9-10 YEARS -35kg	
302	Male	Šoltić	Ervin	Kumite male cadets -63kg	
303	Male	Šoltić	Ervin	KUMITE BOYS 13-14 YEARS -64KG	

Entries: 21

31ST KARATE GRAND PRIX CROATIA

CROATIA 2023.01.20 - 2023.01.22
CITY SPORTS HALL SAMOBOR, ANDRIJE HEBRANGA 26A, SAMOBOR, CROATIA

Tournament Participation (Entries) by Club

 HERCEGOVINA-ZAGREB(KKHZ)					
ID	Sex	Family Name	Given Name	Category	
304	Male	Pehar	Ivan	KUMITE MALE SENIORS	
305	Male	DRAŽIĆ	IVAN	KUMITE BOYS 9-10 YEARS -31kg	
306	Male	Dubravčić	Axel	Kumite male juniors -76kg	
307	Male	FAJERBACH	MAX	Kumite male juniors +76kg	
308	Female	Filipović	Marta	Kumite female Cadets +61kg	
309	Female	Filipović	Marta	KUMITE GIRLS 13-14 YEARS -64KG	
310	Male	FRANK	KRISTIЈAN	Kumite male juniors -68kg	
311	Male	HORVAT	VID	KUMITE BOYS 9-10 YEARS +43kg	
312	Female	Ivančić	Dorotea	Kumite female juniors -53kg	
313	Female	Juričić	Ema	Kumite Female U21 - 68kg	
314	Male	Karačić	Ivan	KUMITE BOYS 11-12 YEARS -39KG	
315	Male	KVESIĆ	ANĐELO	Kumite male Seniors Open Final	
316	Male	KVESIĆ	ANĐELO	KUMITE MALE SENIORS	
317	Male	KVESIĆ	IVAN	KUMITE MALE SENIORS	
318	Male	Kvesić	Luka	Kumite Male U21 +84kg	
319	Male	Kvesić	Viktor	KUMITE BOYS 11-12 YEARS -49KG	
320	Female	Ledić	Irma	KUMITE GIRLS 13-14 YEARS +64KG	
321	Male	Leskovar	Sven	KUMITE BOYS 13-14 YEARS -44KG	
322	Male	Lončar	Bože	Kumite male cadets -70kg	
323	Female	Lovrić	Klara	KUMITE GIRLS 13-14 YEARS +64KG	
324	Female	Lukenda	Nina	Kumite female Juniors +66kg	
325	Female	MADUNA	IVANA	KUMITE GIRLS 11-12 YEARS -39KG	
326	Female	Marić	Iva	KUMITE GIRLS 13-14 YEARS -49KG	
327	Male	Marjanović	Nikola	KUMITE BOYS 13-14 YEARS -49KG	
328	CRO332	MARTINAC	IVAN	KUMITE MALE SENIORS	
329	Female	PEROVIĆ	LUCIJA	Kumite female juniors -53kg	
330	Male	Pinjuh	Bruno	KUMITE BOYS 11-12 YEARS -44KG	
331	Male	Sambol	Ivano	Kumite male cadets -57kg	
332	Female	Sambol	Ivona	Kumite female Juniors -66kg	
333	Female	Tomić	Sara	Kumite female Cadets +61kg	
334	Male	Tomljanović	Luka	Kumite Male U21 -67kg	
335	Male	TUŠKAN	SVEN	Kumite male cadets -57kg	
336	Female	Vidović	Carla	KUMITE GIRLS 13-14 YEARS -54KG	
337	Female	VRBAN	MAŠA	KUMITE GIRLS 9-10 YEARS -27kg	
338	Male	VUKOЈA	LOVRO	Kumite male cadets +70kg	
339	Male	Zeljko	Leon	Kumite male cadets -57kg	
340	Male	Zeljko	Matej	Kumite male cadets -70kg	

Entries: 37

31ST KARATE GRAND PRIX CROATIA

CROATIA

2023.01.20 - 2023.01.22

CITY SPORTS HALL SAMOBOR, ANDRIJE HEBRANGA 26A, SAMOBOR, CROATIA

Tournament Participation (Entries) by Club

 K.K. SOKOL(K.K. SOKOL)					
ID	Sex	Family Name	Given Name	Category	
341	Female	LISAC	LAURA	Kumite Female U21 - 61kg	
342	Female	ROSS	ADRIANA	Kumite Female U21 - 68kg	
343	Female	Šnajder	Darja	Kumite female juniors -59kg	

Entries: 3

31ST KARATE GRAND PRIX CROATIA

CROATIA

2023.01.20 - 2023.01.22

CITY SPORTS HALL SAMOBOR, ANDRIJE HEBRANGA 26A, SAMOBOR, CROATIA

Tournament Participation (Entries) by Club

 Karate Akademija Osijek KAO(KAO)					
ID	Sex	Family Name	Given Name	Category	
344	Male	MESIĆ	LUKA	KUMITE BOYS 11-12 YEARS -49KG	
345	Male	MESIĆ	LUKA	KUMITE BOYS 9-10 YEARS +43kg	
346	Female	OGREBIĆ	TENA	KUMITE GIRLS 7-8 YEARS -24kg	
347	Female	ĆUK	JOSIPA	KUMITE GIRLS 9-10 YEARS -31kg	

Entries: 4

31ST KARATE GRAND PRIX CROATIA

CROATIA

2023.01.20 - 2023.01.22

CITY SPORTS HALL SAMOBOR, ANDRIJE HEBRANGA 26A, SAMOBOR, CROATIA

Tournament Participation (Entries) by Club

 Karate Dojo Brač(Bushi)					
ID	Sex	Family Name	Given Name	Category	
348	Female	Kostadinova	Aleksandra	KATA GIRLS 10 YEARS	
349	Female	Lišnić	Nicoll Carina	KATA GIRLS 10 YEARS	

Entries: 2

31ST KARATE GRAND PRIX CROATIA

CROATIA

2023.01.20 - 2023.01.22

CITY SPORTS HALL SAMOBOR, ANDRIJE HEBRANGA 26A, SAMOBOR, CROATIA

Tournament Participation (Entries) by Club

 Karate klub 10.DAN(KK 10.DAN)					
ID	Sex	Family Name	Given Name	Category	
350	CRO2627	Female	CACKO	MIA	Kumite female Juniors -66kg
351		Female	GRGUREVIC	LEA	Kumite female cadets -47kg
352		Female	Hoxhaj	Elena	Kumite female Juniors +66kg
353		Male	Krušlin	Sven	Kumite male cadets +70kg

Entries: 4

31ST KARATE GRAND PRIX CROATIA

CROATIA 2023.01.20 - 2023.01.22
CITY SPORTS HALL SAMOBOR, ANDRIJE HEBRANGA 26A, SAMOBOR, CROATIA

Tournament Participation (Entries) by Club

 KARATE KLUB ALFA(KK ALFA)					
ID	Sex	Family Name	Given Name	Category	
354	Female	BARIC	ANTONIJA	KATA female cadets	
355	Male	BARIC	STIPE	K22 - MALE SENIORS INTELLECTUALLY IMPAIRED	
356	Female	BENIC	SARA	Kumite Female U21 - 61kg	
357	Male	BODULJAK	ROKO	K22 - MALE SENIORS INTELLECTUALLY IMPAIRED	
358	Female	BRKAN	LUKRECIJA	KATA FEMALE JUNIORS	
359	Male	FILEŠ	MARK	KATA male cadets R4 Bronze Medal Match 1	
360	Male	FILEŠ	MARK	KATA male cadets	
361	Male	FILEŠ	MARK	KATA male cadets R3-G2	
362	Male	FILEŠ	MARK	KATA male cadets R2-G2	
363	Male	HUIĆ	DINO	KATA MALE JUNIORS R3-G1	
364	Male	HUIĆ	DINO	KATA MALE JUNIORS R2-G1	
365	Male	HUIĆ	DINO	KATA MALE JUNIORS	
366	Male	HUIĆ	DINO	KATA MALE JUNIORS R4 Bronze Medal Match 1	
367	Female	Krsnik	Nika	KATA FEMALE JUNIORS	
368	Male	Krsnik	Vito	KATA male cadets	
369	Male	Kukić	Ivan	KATA male cadets R2-G1	
370	Male	Kukić	Ivan	KATA male cadets	
371	Female	TOPIĆ	DANIELA	K22 - FEMALE SENIORS INTELLECTUALLY IMPAIRED	
372	Male	ČIZMIĆ	MATEJ	KATA BOYS 9 YEARS	
373	Male	Šteko	Josip	K11 - MALE SENIORS VISUALLY IMPAIRED	
374	Male	Žeinski	Ivan	KATA male cadets R3-G1	
375	Male	Žeinski	Ivan	KATA male cadets R2-G1	
376	Male	Žeinski	Ivan	KATA male cadets	

Entries: 23

31ST KARATE GRAND PRIX CROATIA

CROATIA 2023.01.20 - 2023.01.22
CITY SPORTS HALL SAMOBOR, ANDRIJE HEBRANGA 26A, SAMOBOR, CROATIA

Tournament Participation (Entries) by Club

 Karate klub Bregana(KK Bregana)					
ID	Sex	Family Name	Given Name		Category
377	Female	Jurjević	Alisa Ema		Kumite female cadets -47kg
378	Female	Jurjević	Alisa Ema		KUMITE GIRLS 13-14 YEARS -49KG
379	Female	Kos	Tina		Kumite female Cadets -61kg
380	Female	Mustafić	Emilija		Kumite female Cadets -61kg
381	Male	STANIC	BORNA		Kumite Male U21 -75kg
382	Male	Svinjarić	Tin		Kumite male cadets -52kg
383	Female	WEISMANN	LARA		Kumite Female U21 -50kg
384	Female	WEISMANN	LUNA		Kumite Female U21 -55kg
385	Female	Zorko	Nika		Kumite female cadets -54kg

Entries: **9**

31ST KARATE GRAND PRIX CROATIA

CROATIA

2023.01.20 - 2023.01.22

CITY SPORTS HALL SAMOBOR, ANDRIJE HEBRANGA 26A, SAMOBOR, CROATIA

Tournament Participation (Entries) by Club

 Karate klub BUSHIDO, Zagreb(KK BUSHIDO, Zagreb)					
ID	Sex	Family Name	Given Name	Category	
386	Female	Beljo	Eliana	Kumite female cadets -54kg	
387	Female	Hudina	Tea	KATA GIRLS 14 YEARS	
388	Female	Marković	Nicole	KUMITE GIRLS 13-14 YEARS -54KG	
389	Female	Medić	Toni	Kumite female cadets -54kg	
390	Male	Vicković	Mihovil	KUMITE BOYS 11-12 YEARS -49KG	

Entries: 5

31ST KARATE GRAND PRIX CROATIA

CROATIA

2023.01.20 - 2023.01.22

CITY SPORTS HALL SAMOBOR, ANDRIJE HEBRANGA 26A, SAMOBOR, CROATIA

Tournament Participation (Entries) by Club

 Karate klub Centar(KK Centar)					
ID	Sex	Family Name	Given Name	Category	
391	Male	Brletić	Antonio	KUMITE BOYS 13-14 YEARS -44KG	
392	Female	Jerkin	Franka	KUMITE GIRLS 11-12 YEARS -39KG	
393	Female	Jerkin	Franka	KUMITE GIRLS 13-14 YEARS -44KG	

Entries: 3

31ST KARATE GRAND PRIX CROATIA

CROATIA 2023.01.20 - 2023.01.22
CITY SPORTS HALL SAMOBOR, ANDRIJE HEBRANGA 26A, SAMOBOR, CROATIA

Tournament Participation (Entries) by Club

 Karate klub Champion Rijeka(CHAMPION RIJEKA)					
ID	Sex	Family Name	Given Name	Category	
394	Female	Gavran	Lara	KUMITE GIRLS 9-10 YEARS -31kg	
395	Female	Guščić	Noa	Kumite female Cadets -61kg	
396	Female	Guščić	Nora	Kumite female Juniors -66kg	
397	Female	Halaba	Lana	KUMITE GIRLS 9-10 YEARS -27kg	
398	Female	Jurković	Katja	Kumite female Cadets -61kg	
399	Female	Knežević	Petra	KUMITE GIRLS 13-14 YEARS -59KG	
400	Male	Končurat	Lovro	KUMITE BOYS 13-14 YEARS -64KG	
401	Female	Krizman	Lena	KUMITE GIRLS 13-14 YEARS +64KG	
402	Female	Krmpotić	Nika	Kumite female Cadets -61kg	
403	Male	Laginja	Josip	KUMITE BOYS 13-14 YEARS -64KG	
404	Male	Magzan	Ivano	Kumite male cadets -63kg	
405	Female	Pejnović	Alessia	KUMITE GIRLS 11-12 YEARS -49KG	
406	Female	Sgardelli	Ema	Kumite Female U21 -50kg	
407	Female	Sgardelli Ljatifi	Ella	KUMITE GIRLS 9-10 YEARS -27kg	
408	Female	Sgardelli Ljatifi	Tea	Kumite female juniors -48kg	
409	Male	Vranković	Mario	Kumite male cadets +70kg	
410	Female	Zejnić	Emma	Kumite female Juniors -66kg	

Entries: 17

31ST KARATE GRAND PRIX CROATIA

CROATIA

2023.01.20 - 2023.01.22

CITY SPORTS HALL SAMOBOR, ANDRIJE HEBRANGA 26A, SAMOBOR, CROATIA

Tournament Participation (Entries) by Club

 Karate klub Croatia(KKCroatia)					
ID	Sex	Family Name	Given Name	Category	
411	Male	Budiščak	Matej	KUMITE MALE SENIORS	
412	Male	Jeleković	Mauro	Kumite male cadets -57kg	
413	Female	Musulín	Meri	KUMITE GIRLS 11-12 YEARS -39KG	
414	Female	Višnjíc	Ema	KUMITE GIRLS 11-12 YEARS -54KG	

Entries: 4

31ST KARATE GRAND PRIX CROATIA

CROATIA 2023.01.20 - 2023.01.22
CITY SPORTS HALL SAMOBOR, ANDRIJE HEBRANGA 26A, SAMOBOR, CROATIA

Tournament Participation (Entries) by Club

 Karate klub CROHERC(CROHERC)					
ID	Sex	Family Name	Given Name	Category	
415	Female	Bulic	Stela	KUMITE GIRLS 13-14 YEARS -44KG	
416	Male	Cule	Oliver	Kumite Male U21 +84kg	
417	Male	Juričić	Dane	Kumite male cadets -57kg	
418	Male	Paponja	David	KUMITE BOYS 13-14 YEARS -44KG	
419	Male	Pervan	Zeljko	Kumite male cadets -57kg	
420	Female	Prga	Patricija	Kumite female juniors -53kg	
421	Male	Puce	Jure	Kumite Male U21 +84kg	

Entries: 7

31ST KARATE GRAND PRIX CROATIA

CROATIA 2023.01.20 - 2023.01.22
CITY SPORTS HALL SAMOBOR, ANDRIJE HEBRANGA 26A, SAMOBOR, CROATIA

Tournament Participation (Entries) by Club

 Karate klub Hrvatski Dragovoljac(KKHD)					
ID	Sex	Family Name	Given Name	Category	
422	Female	Bilać	Laura	KUMITE GIRLS 13-14 YEARS -49KG	
423	Male	Hršak	Filip	KUMITE BOYS 11-12 YEARS +54KG	
424	Male	Mrvicic	Ante	KUMITE MALE SENIORS	
425	Female	Prusina	Jana	Kumite female juniors -59kg	
426	Female	Raguz	Ivana	kata female U21 R3 Bronze Medal Match 2	
427	Female	Raguz	Ivana	kata female U21	
428	Female	Raguz	Ivana	kata female U21 R2-G2	
429	Male	Raguž	Karlo	KUMITE MALE SENIORS	
430	Male	Sesar	Tomo	Kumite male cadets -63kg	
431	Male	Vasilj	David	Kumite male cadets +70kg	
432	Male	Zovko	Ante	Kumite male cadets -57kg	
433	Female	Čamber	Ivana	Kumite female cadets -47kg	
434	Male	Čutura	Toni	Kumite male juniors +76kg	
435	Female	Šulek	Tihana	Kumite Female U21 -55kg	

Entries: **14**

31ST KARATE GRAND PRIX CROATIA

CROATIA

2023.01.20 - 2023.01.22

CITY SPORTS HALL SAMOBOR, ANDRIJE HEBRANGA 26A, SAMOBOR, CROATIA

Tournament Participation (Entries) by Club

 KARATE KLUB HRVATSKI SOKOL OSIJEK(KK HRVATSKI SOKOL)					
ID	Sex	Family Name	Given Name	Category	
436	Female	Šegavčić	Katia	KATA female cadets	
437	Female	Šegavčić	Katia	KATA female cadets R3-G2	
438	Female	Šegavčić	Katia	KATA female cadets R2-G2	
439	Female	Šegavčić	Katia	KATA female cadets R4 Bronze Medal Match 1	

Entries: 4

31ST KARATE GRAND PRIX CROATIA

CROATIA 2023.01.20 - 2023.01.22
CITY SPORTS HALL SAMOBOR, ANDRIJE HEBRANGA 26A, SAMOBOR, CROATIA

Tournament Participation (Entries) by Club

 KARATE KLUB IPON ZAGREB (KK IPON ZAGREB)					
ID	Sex	Family Name	Given Name	Category	
440	Male	DRAŽENović	DAMIAN	Kumite male juniors -55kg	
441	Male	GAVIC	KRISTIJAN	Kumite male cadets -57kg	
442	Male	KALABIC	ALEKSANDAR	Kumite Male U21 -84kg	
443	Male	KALABIC	ALEKSANDAR	KUMITE MALE SENIORS	
444	Female	KAVAN GREGURić	TEA	Kumite female cadets -54kg	
445	Male	Kisić	Fran	KATA male cadets	
446	Female	KOCKAREVIC	LANA	Kumite female juniors -48kg	
447	Female	LOVRić	MIRTA	Kumite Female U21 -55kg	
448	Male	Mabić	Filip	Kumite male cadets -57kg	
449	Male	Maslov	Lovro	Kumite male cadets -52kg	
450	Male	PANIĆ	KARLO	Kumite male cadets -63kg	
451	Female	PANIĆ	PAULA	KUMITE GIRLS 13-14 YEARS -49KG	
452	Female	Radić	Lorena	Kumite female cadets -54kg	
453	Female	Radić	Lorena	KUMITE GIRLS 13-14 YEARS -54KG	
454	Male	Rumenjak	Noa	Kumite Male U21 -60kg	
455	Female	Rumenjak	Rafaela	Kumite female cadets -54kg	
456	Female	Vajda	Magdalena	Kumite female juniors -53kg	
457	Male	ZELENIKA	MATKO	Kumite male juniors +76kg	

Entries: **18**

31ST KARATE GRAND PRIX CROATIA

CROATIA

2023.01.20 - 2023.01.22

CITY SPORTS HALL SAMOBOR, ANDRIJE HEBRANGA 26A, SAMOBOR, CROATIA

Tournament Participation (Entries) by Club

 Karate klub Kaptol Zagreb(Kaptol)					
ID	Sex	Family Name	Given Name	Category	
458	Male	Bunjevac	Jakov	Kumite male Seniors Open Final	
459	Male	Bunjevac	Jakov	KUMITE MALE SENIORS	
460	Male	Cesar	Jan	KATA BOYS 11 YEARS	
461	Male	Cesar	Jan	KATA BOYS 10 YEARS	
462	Male	Grgić	Antonio	KUMITE MALE SENIORS	
463	Male	Tomljanović	Leon	KUMITE MALE SENIORS	

Entries: 6

31ST KARATE GRAND PRIX CROATIA

CROATIA

2023.01.20 - 2023.01.22

CITY SPORTS HALL SAMOBOR, ANDRIJE HEBRANGA 26A, SAMOBOR, CROATIA

Tournament Participation (Entries) by Club

 karate klub karlovac 1969(karlovac)					
ID	Sex	Family Name	Given Name	Category	
464	Male	Baršić	Vito	KUMITE BOYS 9-10 YEARS -27KG	
465	Male	Buturajac	Mark	KUMITE BOYS 9-10 YEARS -35kg	
466	Male	Grubešić	Petar	KUMITE BOYS 11-12 YEARS -44KG	
467	Male	Ožura	Andrej	KUMITE BOYS 9-10 YEARS -31kg	
468	Male	Puklavec	Mislav	KUMITE BOYS 9-10 YEARS -31kg	
469	Female	Šegavić	Lucija	Kumite female Cadets +61kg	

Entries: 6

31ST KARATE GRAND PRIX CROATIA

CROATIA 2023.01.20 - 2023.01.22
CITY SPORTS HALL SAMOBOR, ANDRIJE HEBRANGA 26A, SAMOBOR, CROATIA

Tournament Participation (Entries) by Club

 Karate klub Kastav(KK Kastav)					
ID	Sex	Family Name	Given Name	Category	
470	Male	Buršić	Leon	Kumite male cadets -63kg	
471	Male	Jakovljević	Dino	Kumite male cadets -52kg	
472	Male	Kadić	Endi	KUMITE BOYS 13-14 YEARS -64KG	
473	Female	Karlovic	Noeli	KUMITE GIRLS 13-14 YEARS -59KG	
474	Female	Marin	Lena	KUMITE GIRLS 13-14 YEARS -59KG	
475	Male	Marić	Jan	KUMITE BOYS 9-10 YEARS -27KG	
476	Male	Matijević	Ante	KUMITE BOYS 13-14 YEARS -59KG	
477	Male	Obajdin	Filip	KUMITE BOYS 13-14 YEARS -59KG	
478	Male	Ozbolt	Ivan	Kumite male cadets -70kg	
479	Male	Ozbolt	Luka	Kumite male cadets +70kg	
480	Male	Verić Nikšić	Jan	KUMITE BOYS 13-14 YEARS -69KG	
481	Male	Vučak	David	KUMITE BOYS 11-12 YEARS -49KG	
482	Female	Šimundić	Nika	KUMITE GIRLS 13-14 YEARS -59KG	
483	Female	Šimundić	Nika	Kumite female Cadets -61kg	

Entries: **14**

31ST KARATE GRAND PRIX CROATIA

CROATIA

2023.01.20 - 2023.01.22

CITY SPORTS HALL SAMOBOR, ANDRIJE HEBRANGA 26A, SAMOBOR, CROATIA

Tournament Participation (Entries) by Club

 Karate klub KLENOVNIK(K.K.Klenovnik)					
ID	Sex	Family Name	Given Name	Category	
484	Female	Kokotec	Ines	Kumite female juniors -59kg	
485	Male	STANČIĆ	ADRIAN	Kumite male juniors -68kg	

Entries: 2

31ST KARATE GRAND PRIX CROATIA

CROATIA 2023.01.20 - 2023.01.22
CITY SPORTS HALL SAMOBOR, ANDRIJE HEBRANGA 26A, SAMOBOR, CROATIA

Tournament Participation (Entries) by Club

 Karate klub Kostrena(KK Kostrena)					
ID	Sex	Family Name	Given Name	Category	
486	Male	Babić	Borna	KUMITE BOYS 13-14 YEARS -59KG	
487	Male	Duvnjak	Borna	KUMITE BOYS 11-12 YEARS -54KG	
488	Male	Katnić	Vito	KUMITE BOYS 11-12 YEARS -44KG	
489	Male	Lorencin	LEVAN	KUMITE BOYS 11-12 YEARS -34KG	
490	Female	LOZO	Milla Vita	KUMITE GIRLS 9-10 YEARS -31kg	
491	Female	Pranjić	Vita	KUMITE GIRLS 9-10 YEARS -31kg	
492	Female	Tadej	Sara	Kumite female Cadets -61kg	
493	Female	Žugaj	Sara	KUMITE GIRLS 9-10 YEARS -27kg	

Entries: 8

31ST KARATE GRAND PRIX CROATIA

CROATIA

2023.01.20 - 2023.01.22

CITY SPORTS HALL SAMOBOR, ANDRIJE HEBRANGA 26A, SAMOBOR, CROATIA

Tournament Participation (Entries) by Club

 KARATE KLUB KTC KRIZEVCI(KTC KRIZEVCI)					
ID	Sex	Family Name	Given Name	Category	
494	Female	Dvorski	Mia	KUMITE GIRLS 11-12 YEARS -49KG	
495	Male	HABJANOVIĆ	KARLO	KUMITE BOYS 13-14 YEARS -49KG	
496	Female	KATALENAC	IVA	Kumite female Cadets -61kg	
497	Male	KOMARICA	FILIP	Kumite male cadets -52kg	
498	Female	LUGOMER	LARISA	Kumite female juniors -53kg	
499	Female	LUGOMER	LEONA	KUMITE GIRLS 11-12 YEARS -39KG	

Entries: 6

31ST KARATE GRAND PRIX CROATIA

CROATIA

2023.01.20 - 2023.01.22

CITY SPORTS HALL SAMOBOR, ANDRIJE HEBRANGA 26A, SAMOBOR, CROATIA

Tournament Participation (Entries) by Club

 Karate Klub Max Ivankovo(KK Max)					
ID	Sex	Family Name	Given Name	Category	
500	Female	Kockarević	Emanuela	Kumite female juniors -59kg	
501	Female	Kockarević	Iva	KUMITE GIRLS 11-12 YEARS -54KG	
502	Female	Požega	Eva	KUMITE GIRLS 13-14 YEARS -54KG	
503	Male	Požega	Luka	Kumite male cadets -63kg	

Entries: 4

31ST KARATE GRAND PRIX CROATIA

CROATIA 2023.01.20 - 2023.01.22
CITY SPORTS HALL SAMOBOR, ANDRIJE HEBRANGA 26A, SAMOBOR, CROATIA

Tournament Participation (Entries) by Club

 Karate klub Metal - Jurdani(kkmetal_jurdani)					
ID	Sex	Family Name	Given Name	Category	
504	Male	Miliovich	David	Kumite Male U21 -67kg	
505	Male	Miliovich	David	Kumite male juniors -68kg	

Entries: 2

31ST KARATE GRAND PRIX CROATIA

CROATIA

2023.01.20 - 2023.01.22

CITY SPORTS HALL SAMOBOR, ANDRIJE HEBRANGA 26A, SAMOBOR, CROATIA

Tournament Participation (Entries) by Club

 Karate klub Međimurje(KK Međimurje)					
ID	Sex	Family Name	Given Name	Category	
506	Male	MARCIUS	LEON	KUMITE MALE SENIORS	

Entries: 1

31ST KARATE GRAND PRIX CROATIA

CROATIA

2023.01.20 - 2023.01.22

CITY SPORTS HALL SAMOBOR, ANDRIJE HEBRANGA 26A, SAMOBOR, CROATIA

Tournament Participation (Entries) by Club

 Karate klub NEVERA(KK NEVERA)					
ID	Sex	Family Name	Given Name	Category	
507	Male	Dmiović	Matej	Kumite male cadets -63kg	
508	Female	Dujmović	Klara	KUMITE GIRLS 11-12 YEARS +54KG	
509	Female	Mužik	Lana	KUMITE GIRLS 11-12 YEARS -34KG	
510	Male	Pejin	Ivan	KUMITE BOYS 11-12 YEARS -34KG	
511	Female	Sabljak	Matea	KUMITE GIRLS 11-12 YEARS -49KG	
512	Male	Trinajstić	Fran	KUMITE BOYS 11-12 YEARS -44KG	
513	Female	Vrban	Nicol	KUMITE GIRLS 11-12 YEARS +54KG	

Entries: 7

31ST KARATE GRAND PRIX CROATIA

CROATIA 2023.01.20 - 2023.01.22
CITY SPORTS HALL SAMOBOR, ANDRIJE HEBRANGA 26A, SAMOBOR, CROATIA

Tournament Participation (Entries) by Club

 Karate klub No Kachi(KKK)					
ID	Sex	Family Name	Given Name	Category	
514	Female	Bajrić	Ajla	KUMITE GIRLS 11-12 YEARS -44KG	
515	Female	Šerić	Lara	Kumite female Cadets +61kg	

Entries: 2

31ST KARATE GRAND PRIX CROATIA

CROATIA 2023.01.20 - 2023.01.22
CITY SPORTS HALL SAMOBOR, ANDRIJE HEBRANGA 26A, SAMOBOR, CROATIA

Tournament Participation (Entries) by Club

 Karate Klub Novi Zagreb(KK Novi Zagreb)					
ID	Sex	Family Name	Given Name	Category	
516	Female	Azinović	Ruža	KUMITE GIRLS 9-10 YEARS -27kg	
517	Male	Babić	Ivan	KUMITE BOYS 13-14 YEARS -54KG	
518	Female	Mohler	Katja	KUMITE GIRLS 9-10 YEARS -31kg	
519	Male	Nasteski	Matija	Kumite male juniors -61kg	
520	Male	Nedić	Leon	Kumite male juniors -76kg	
521	039-27914	Novak	Bruno	Kumite male cadets -63kg	
522	Male	Perković	Bartol	KUMITE BOYS 9-10 YEARS -35kg	
523	Male	Vitelić Paprika	Tibor	Kumite male juniors -76kg	
524	Male	Zeljko	Ivan	KUMITE BOYS 13-14 YEARS -54KG	

Entries: **9**

31ST KARATE GRAND PRIX CROATIA

CROATIA

2023.01.20 - 2023.01.22

CITY SPORTS HALL SAMOBOR, ANDRIJE HEBRANGA 26A, SAMOBOR, CROATIA

Tournament Participation (Entries) by Club

 Karate klub Obi Kaštela(KK Obi Kaštela)					
ID	Sex	Family Name	Given Name	Category	
525	Female	BEŠLIJA	NIKA	Kumite female juniors -59kg	
526	Female	Ivaković	Lolita Lana	Kumite Female U21 - 68kg	
527	Female	Lozovina	Antonia	KUMITE GIRLS 11-12 YEARS -39KG	

Entries: 3

31ST KARATE GRAND PRIX CROATIA

CROATIA

2023.01.20 - 2023.01.22

CITY SPORTS HALL SAMOBOR, ANDRIJE HEBRANGA 26A, SAMOBOR, CROATIA

Tournament Participation (Entries) by Club

 KARATE KLUB OMEGA(KK OMEGA)					
ID	Sex	Family Name	Given Name	Category	
528	CRO2507	Female	Braja	Klara	kata female U21
529		Female	Pervan	Jurja	KATA female cadets

Entries: 2

31ST KARATE GRAND PRIX CROATIA

CROATIA

2023.01.20 - 2023.01.22

CITY SPORTS HALL SAMOBOR, ANDRIJE HEBRANGA 26A, SAMOBOR, CROATIA

Tournament Participation (Entries) by Club

 Karate klub Polet Zagreb(Polet Zagreb)					
ID	Sex	Family Name	Given Name	Category	
530	Female	Vladić	Mila	KATA GIRLS 8 YEARS	
531	Male	Šturić	Luka	KATA MALE JUNIORS	
532	Female	Šturić	Maša	KATA GIRLS 12 YEARS	
533	Female	Šturić	Maša	KATA GIRLS 11 YEARS	

Entries: 4

31ST KARATE GRAND PRIX CROATIA

CROATIA

2023.01.20 - 2023.01.22

CITY SPORTS HALL SAMOBOR, ANDRIJE HEBRANGA 26A, SAMOBOR, CROATIA

Tournament Participation (Entries) by Club

 Karate Klub Pula(K.K.Pula)					
ID	Sex	Family Name	Given Name	Category	
534	Female	Brletić	Elena	Kumite female cadets -47kg	
535	Female	Brletić	Elena	KUMITE GIRLS 13-14 YEARS -49KG	

Entries: 2

31ST KARATE GRAND PRIX CROATIA

CROATIA

2023.01.20 - 2023.01.22

CITY SPORTS HALL SAMOBOR, ANDRIJE HEBRANGA 26A, SAMOBOR, CROATIA

Tournament Participation (Entries) by Club

 Karate klub Sakura Zagreb(SakuraZG)					
ID	Sex	Family Name	Given Name	Category	
536	Female	RAVLIĆ	Anamarija	Kumite Female U21 + 68kg	
537	Female	ŽUGČIĆ	Dora	Kumite Female U21 - 61kg	

Entries: 2

31ST KARATE GRAND PRIX CROATIA

CROATIA

2023.01.20 - 2023.01.22

CITY SPORTS HALL SAMOBOR, ANDRIJE HEBRANGA 26A, SAMOBOR, CROATIA

Tournament Participation (Entries) by Club

 Karate klub Shihan - Zagreb(KKShihan)					
ID	Sex	Family Name	Given Name	Category	
538	Female	Buljan	Tea	KATA FEMALE JUNIORS	
539	Male	Petrušić	Luka	KATA BOYS 9 YEARS	
540	Male	Petrušić	Vedran	KATA BOYS 11 YEARS	

Entries: 3

31ST KARATE GRAND PRIX CROATIA

CROATIA

2023.01.20 - 2023.01.22

CITY SPORTS HALL SAMOBOR, ANDRIJE HEBRANGA 26A, SAMOBOR, CROATIA

Tournament Participation (Entries) by Club

 Karate klub Sportslife Zg(kk.sportslife)					
ID	Sex	Family Name	Given Name	Category	
541	Male	Ljutić	Nikola	Kumite male cadets -70kg	
542	Male	Martić	Antonio	Kumite Male U21 -84kg	
543	Female	Štivić	Ema	Kumite Female U21 -55kg	

Entries: 3

31ST KARATE GRAND PRIX CROATIA

CROATIA

2023.01.20 - 2023.01.22

CITY SPORTS HALL SAMOBOR, ANDRIJE HEBRANGA 26A, SAMOBOR, CROATIA

Tournament Participation (Entries) by Club

 Karate klub Stijena(KK Stijena)					
ID	Sex	Family Name	Given Name	Category	
544	Male	Gluhinić	Dario	Kumite Male U21 +84kg	
545	Female	Zorko	Mia Greta	Kumite Female U21 - 68kg	

Entries: 2

31ST KARATE GRAND PRIX CROATIA

CROATIA

2023.01.20 - 2023.01.22

CITY SPORTS HALL SAMOBOR, ANDRIJE HEBRANGA 26A, SAMOBOR, CROATIA

Tournament Participation (Entries) by Club

 KARATE KLUB TEMPO(KK TEMPO)					
ID	Sex	Family Name	Given Name	Category	
546	Male	Borojević	Mario	kata male U21	
547	Female	Garibović	Ajna	KUMITE GIRLS 11-12 YEARS -54KG	
548	Male	Garibović	Dino	Kumite male juniors -68kg	
549	Female	Kosić	Ana	KATA GIRLS 9 YEARS	
550	Female	Mihaljević	Anamaria	Kumite female juniors -59kg	
551	Male	Salopek	Leon	KATA BOYS 12 YEARS	
552	Female	Salopek	Martina	KATA GIRLS 14 YEARS	

Entries: 7

31ST KARATE GRAND PRIX CROATIA

CROATIA 2023.01.20 - 2023.01.22
CITY SPORTS HALL SAMOBOR, ANDRIJE HEBRANGA 26A, SAMOBOR, CROATIA

Tournament Participation (Entries) by Club

 Karate Klub Tigar Sisak (KKTS)					
ID	Sex	Family Name	Given Name	Category	
553	Female	Barukčić	Ana Marie	KUMITE GIRLS 13-14 YEARS +64KG	
554	Male	Berend	Marko	KATA BOYS 11 YEARS	
555	Male	Crnkovic	Borna	KUMITE BOYS 7-8 YEARS -28kg	
556	Male	Dumbović	Roko	Kumite Male U21 -67kg	
557	Female	Ferčić	Lucija	KUMITE GIRLS 9-10 YEARS -39kg	
558	Female	Golomboš	Nikolina	Kumite Female U21 + 68kg	
559	Female	Jelčić	Roza	KUMITE GIRLS 11-12 YEARS -39KG	
560	Female	Kiš	Lana	KUMITE GIRLS 11-12 YEARS -54KG	
561	Female	Klarić	Korina	Kumite female cadets -54kg	
562	Male	Makar	David	KATA BOYS 14 YEARS	
563	Female	Makar	Tena	KATA GIRLS 9 YEARS	
564	Male	Plesivčak	Mislav	Kumite male juniors +76kg	
565	Male	Čopić	Niko	KATA BOYS 11 YEARS	

Entries: 13

31ST KARATE GRAND PRIX CROATIA

CROATIA 2023.01.20 - 2023.01.22
CITY SPORTS HALL SAMOBOR, ANDRIJE HEBRANGA 26A, SAMOBOR, CROATIA

Tournament Participation (Entries) by Club

 Karate klub Tinjan(Tinjan)					
ID	Sex	Family Name	Given Name	Category	
566	CRO03139	Male	Turković	Vito	Kumite male cadets +70kg
567	CRO03138	Male	Đurić Vadinjof	Josip	Kumite male juniors -68kg

Entries: 2

31ST KARATE GRAND PRIX CROATIA

CROATIA 2023.01.20 - 2023.01.22
CITY SPORTS HALL SAMOBOR, ANDRIJE HEBRANGA 26A, SAMOBOR, CROATIA

Tournament Participation (Entries) by Club

 KARATE KLUB TRNJE(KK TRNJE)					
ID	Sex	Family Name	Given Name	Category	
568	Female	Kincl	Nina	KUMITE GIRLS 11-12 YEARS -34KG	
569	Male	Kurti	Niko	KUMITE BOYS 11-12 YEARS -34KG	
570	Female	LONČAR	LUCIJA	KUMITE GIRLS 13-14 YEARS -44KG	
571	Female	Medić	Tia	KATA GIRLS 11 YEARS	
572	Female	Mesarek	Anja	KATA GIRLS 11 YEARS	
573	Male	MUCIĆ	DOMINIK	KUMITE BOYS 11-12 YEARS +54KG	
574	Male	MUCIĆ	MIHAEL	Kumite male cadets -70kg	
575	Male	Puzić	Leon	Kumite male cadets -70kg	
576	Male	Čavar	Mateo	KATA BOYS 11 YEARS	
577	Female	Štokić	Matea	KATA GIRLS 8 YEARS	
578	Male	Župan	Patrik	KATA BOYS 8 YEARS	
579	Male	ŽURA	ANTE	KUMITE BOYS 11-12 YEARS -39KG	

Entries: **12**

31ST KARATE GRAND PRIX CROATIA

CROATIA

2023.01.20 - 2023.01.22

CITY SPORTS HALL SAMOBOR, ANDRIJE HEBRANGA 26A, SAMOBOR, CROATIA

Tournament Participation (Entries) by Club

 Karate klub Varaždin(KK Varaždin)					
ID	Sex	Family Name	Given Name	Category	
580	Male	Garibović	Enes	Kumite male Seniors Open Final	
581	Male	Garibović	Enes	KUMITE MALE SENIORS	

Entries: 2

31ST KARATE GRAND PRIX CROATIA

CROATIA 2023.01.20 - 2023.01.22
CITY SPORTS HALL SAMOBOR, ANDRIJE HEBRANGA 26A, SAMOBOR, CROATIA

Tournament Participation (Entries) by Club

 Karate klub Velika Gorica(VG)					
ID	Sex	Family Name	Given Name	Category	
582	Female	Braica	Katja	Kumite female Cadets -61kg	
583	Female	Filković	Ema	Kumite female Juniors -66kg	
584	Female	Filković	Ema	Kumite female Cadets +61kg	
585	Female	Gusić	Mara	Kumite female cadets -47kg	
586	Female	Gusić	Mara	KUMITE GIRLS 13-14 YEARS -44KG	
587	Male	Hulina	Vito	Kumite male cadets -52kg	
588	Male	Hulina	Vito	KUMITE BOYS 13-14 YEARS -49KG	
589	Male	Jeromić	Noel	Kumite male cadets -63kg	
590	Female	Jukić	Ema	Kumite female cadets -47kg	
591	Female	Kirinić	Lucija	Kumite female juniors -48kg	
592	Female	Kordić	Matea	Kumite female cadets -54kg	
593	Male	Krmpotić	Petar Krešimir	Kumite male cadets -52kg	
594	Male	Krmpotić	Petar Krešimir	KUMITE BOYS 13-14 YEARS -49KG	
595	Male	Lovrinović	David	KUMITE BOYS 13-14 YEARS -64KG	
596	Male	Lovrinović	David	Kumite male cadets -63kg	
597	Male	Lukačić	Luka	Kumite male cadets -70kg	
598	Female	Mirosavljević	Nika	Kumite female cadets -54kg	
599	Male	Vuković	Matej	Kumite male juniors -76kg	
600	Female	Čunčić	Mia	KUMITE GIRLS 13-14 YEARS -44KG	

Entries: **19**

31ST KARATE GRAND PRIX CROATIA

CROATIA

2023.01.20 - 2023.01.22

CITY SPORTS HALL SAMOBOR, ANDRIJE HEBRANGA 26A, SAMOBOR, CROATIA

Tournament Participation (Entries) by Club

 Karate klub Zanshin, Split(Karate klub Zanshin, Split)					
ID	Sex	Family Name	Given Name	Category	
601	Female	Pavlović	Domina	Kumite Female U21 + 68kg	

Entries: 1

31ST KARATE GRAND PRIX CROATIA

CROATIA

2023.01.20 - 2023.01.22

CITY SPORTS HALL SAMOBOR, ANDRIJE HEBRANGA 26A, SAMOBOR, CROATIA

Tournament Participation (Entries) by Club

 Karate Klub Zrinski(KKZ)					
ID	Sex	Family Name	Given Name	Category	
602	Female	Bandić	Petra	Kumite female cadets -54kg	
603	Female	Mandić	Marija	Kumite female Juniors -66kg	
604	Female	Rezić	Dora	Kumite Female U21 -55kg	

Entries: 3

31ST KARATE GRAND PRIX CROATIA

CROATIA

2023.01.20 - 2023.01.22

CITY SPORTS HALL SAMOBOR, ANDRIJE HEBRANGA 26A, SAMOBOR, CROATIA

Tournament Participation (Entries) by Club

 Karate klub Šibenik 1066(KKŠ1066)					
ID	Sex	Family Name	Given Name	Category	
605	Male	Mileta	Toma	Kumite male juniors -76kg	
606	Male	Ramljak	Karlo	Kumite male juniors -55kg	

Entries: 2

31ST KARATE GRAND PRIX CROATIA

CROATIA

2023.01.20 - 2023.01.22

CITY SPORTS HALL SAMOBOR, ANDRIJE HEBRANGA 26A, SAMOBOR, CROATIA

Tournament Participation (Entries) by Club

 KK JADRAN(KK Jadran)					
ID	Sex	Family Name	Given Name	Category	
607	Female	BERIŠA	TONKA	Kumite female juniors -48kg	

Entries: 1

31ST KARATE GRAND PRIX CROATIA

CROATIA

2023.01.20 - 2023.01.22

CITY SPORTS HALL SAMOBOR, ANDRIJE HEBRANGA 26A, SAMOBOR, CROATIA

Tournament Participation (Entries) by Club

 KK LOTOS ZAGREB(KK LOTOS)					
ID	Sex	Family Name	Given Name	Category	
608	Male	Janjić	Franko	KUMITE BOYS 13-14 YEARS -49KG	
609	Male	KADIĆ	BARTOL	Kumite male cadets -63kg	
610	Female	Kadić	Nola	KUMITE GIRLS 11-12 YEARS -44KG	
611	Female	Marić	Anja	KUMITE GIRLS 11-12 YEARS -34KG	
612	Female	Marić	Anja	KUMITE GIRLS 9-10 YEARS -31kg	
613	Female	Ribar	Katarina	KUMITE GIRLS 11-12 YEARS -34KG	
614	Male	Ribar	Toma	KUMITE BOYS 9-10 YEARS -31kg	
615	Female	Smolčić	Tia	Kumite female cadets -47kg	
616	Male	Šonje	Dominik	Kumite male juniors -68kg	
617	Female	Ščurić	Lucija	KUMITE GIRLS 11-12 YEARS -34KG	

Entries: **10**

31ST KARATE GRAND PRIX CROATIA

CROATIA

2023.01.20 - 2023.01.22

CITY SPORTS HALL SAMOBOR, ANDRIJE HEBRANGA 26A, SAMOBOR, CROATIA

Tournament Participation (Entries) by Club

 KK Okinawa Mali Bukovec(KK Okinawa)					
ID	Sex	Family Name	Given Name	Category	
618	Male	Biškup	Teo	KATA BOYS 8 YEARS	
619	Male	Tkalčec	Tomislav	kata male U21	
620	Male	Tkalčec	Tomislav	kata male U21 R2-G2	

Entries: 3

31ST KARATE GRAND PRIX CROATIA

CROATIA

2023.01.20 - 2023.01.22

CITY SPORTS HALL SAMOBOR, ANDRIJE HEBRANGA 26A, SAMOBOR, CROATIA

Tournament Participation (Entries) by Club

 KK OPATIJA(Opatija)					
ID	Sex	Family Name	Given Name	Category	
621	Male	BAŽDARIĆ	ANTON	Kumite Male U21 +84kg	
622	Female	REDŽIĆ	ELA	KUMITE GIRLS 11-12 YEARS -49KG	
623	Female	REDŽIĆ	JANA	Kumite female Cadets -61kg	
624	Female	ROGOVIĆ	LANA	Kumite female cadets -54kg	

Entries: 4

31ST KARATE GRAND PRIX CROATIA

CROATIA 2023.01.20 - 2023.01.22
CITY SPORTS HALL SAMOBOR, ANDRIJE HEBRANGA 26A, SAMOBOR, CROATIA

Tournament Participation (Entries) by Club

 KK Samobor (kksa)					
ID	Sex	Family Name	Given Name	Category	
625	Male	BAŠIĆ	ANTONIJO	Kumite male cadets -57kg	
626	Male	BLAŽEVIĆ	KARLO	KUMITE BOYS 11-12 YEARS -44KG	
627	Female	JELEN	NIKA	kata female U21	
628	Female	JELEN	NIKA	Kata female seniors	
629	Male	KATANEC	JAN	Kumite male juniors +76kg	
630	Male	KATANEC	JAN	Kumite Male U21 +84kg	
631	Male	KOS	VIJEKO	KUMITE BOYS 13-14 YEARS -49KG	
632	Male	KRIŽETIĆ	MIHAEL	Kumite male cadets +70kg	
633	Female	LUČIĆ	LORENA	KUMITE GIRLS 13-14 YEARS -44KG	
634	Female	MAJSEC	ISKRA	Kumite Female U21 -50kg	
635	Female	MAJSEC	ISKRA	Kumite female juniors -53kg	
636	Male	PELD	PATRIK	KATA BOYS 14 YEARS	
637	Female	POŽGAJ	DORA	KATA GIRLS 12 YEARS	
638	Female	POŽGAJ	VITA	KATA GIRLS 11 YEARS	
639	Male	PRUSINA	IVAN NIKO	Kumite Male U21 -75kg	
640	Male	TERIHAIJ	IVAN	Kumite Male U21 -75kg	
641	Male	UDOVIČIĆ	JAKOV	KUMITE BOYS 13-14 YEARS -54KG	
642	Male	UDOVIČIĆ	MARKO	KUMITE BOYS 11-12 YEARS -44KG	
643	Male	VUKSANOVIĆ	ANDRIJA	KATA BOYS 13 YEARS	
644	Female	ČIČKA	ALBENA	KATA GIRLS 13 YEARS	
645	Male	ČIČKA	PAVEL	KATA BOYS 11 YEARS	
646	Male	ŠELJA	BORNA	KUMITE BOYS 11-12 YEARS -39KG	
647	Male	ŠELJA	LOVRO	KUMITE BOYS 11-12 YEARS -39KG	
648	Male	ŠESTAN	VIKTOR	KUMITE BOYS 11-12 YEARS -54KG	
649	Male	ŠIMUNEC	DINO	Kumite Male U21 -75kg	
650	Male	ŠIMUNEC	DINO	KUMITE MALE SENIORS	
651	Male	ŠUNJIĆ	BORNA	Kumite male juniors -61kg	

Entries: 27

31ST KARATE GRAND PRIX CROATIA

CROATIA 2023.01.20 - 2023.01.22
CITY SPORTS HALL SAMOBOR, ANDRIJE HEBRANGA 26A, SAMOBOR, CROATIA

Tournament Participation (Entries) by Club

 KK VIROVITICA(VIROVITICA)					
ID	Sex	Family Name	Given Name	Category	
652	Male	Gondi	Nikola	Kumite male juniors +76kg	
653	Male	MALČEC	CHRIS	Kumite male juniors -61kg	
654	Female	MALČEC	SARA	Kata female seniors	
655	Male	RELIĆ	MATIJA	kata male U21	
656	Male	RELIĆ	MATIJA	kata male U21 R3-G1	
657	Male	RELIĆ	MATIJA	kata male U21 R2-G1	
658	Male	Šenjug	Maks Luka	Kata male seniors	

Entries: 7

31ST KARATE GRAND PRIX CROATIA

CROATIA

2023.01.20 - 2023.01.22

CITY SPORTS HALL SAMOBOR, ANDRIJE HEBRANGA 26A, SAMOBOR, CROATIA

Tournament Participation (Entries) by Club

 Mladost(Mladost)					
ID	Sex	Family Name	Given Name	Category	
659	Male	Crnogaj	Teo	Kumite male juniors -76kg	
660	Male	Huzanić	Ivan	Kumite male juniors +76kg	
661	Male	Suhina	Matej	Kumite male cadets -70kg	
662	Male	Vujević	Antun	Kumite Male U21 -75kg	
663	Female	Zetica	Mia	Kumite female juniors -53kg	

Entries: 5

31ST KARATE GRAND PRIX CROATIA

CROATIA

2023.01.20 - 2023.01.22

CITY SPORTS HALL SAMOBOR, ANDRIJE HEBRANGA 26A, SAMOBOR, CROATIA

Tournament Participation (Entries) by Club

 Okit Vodice(Okit)					
ID	Sex	Family Name	Given Name	Category	
664	Female	Adžaga	Ela	KUMITE GIRLS 13-14 YEARS -44KG	
665	Female	Grubelić	Gabrijela	KUMITE GIRLS 11-12 YEARS -49KG	
666	Female	Ianachi Čopić	Elin	KUMITE GIRLS 11-12 YEARS -49KG	
667	Female	Jukić	Nora	Kumite female Cadets -61kg	
668	Female	Jukić	Tara	KUMITE GIRLS 13-14 YEARS -54KG	
669	Female	Klarin	Lili	KUMITE GIRLS 9-10 YEARS -35kg	
670	Male	Križanović Mimica	Noah	KUMITE BOYS 11-12 YEARS -34KG	
671	Male	Križanović Mimica	Oliver	KUMITE BOYS 7-8 YEARS -24kg	
672	Female	Marjanović	Ana	KUMITE GIRLS 11-12 YEARS -34KG	
673	Male	Perković	Noa Adrian	KUMITE BOYS 7-8 YEARS -36kg	

Entries: **10**

31ST KARATE GRAND PRIX CROATIA

CROATIA

2023.01.20 - 2023.01.22

CITY SPORTS HALL SAMOBOR, ANDRIJE HEBRANGA 26A, SAMOBOR, CROATIA

Tournament Participation (Entries) by Club

 rijeka(rijeka)					
ID	Sex	Family Name	Given Name	Category	
674	Female	Krešić	Tea	Kumite female Juniors -66kg	

Entries: 1

31ST KARATE GRAND PRIX CROATIA

CROATIA

2023.01.20 - 2023.01.22

CITY SPORTS HALL SAMOBOR, ANDRIJE HEBRANGA 26A, SAMOBOR, CROATIA

Tournament Participation (Entries) by Club

 SLAVKO KRIVSKI TERMAL DARUVAR(HKK SKT DARUVAR)					
ID	Sex	Family Name	Given Name	Category	
675	Male	Ivković	Aleksandar	KATA BOYS 12 YEARS	
676	Male	Kozina	Emanuel	KATA BOYS 13 YEARS	
677	Female	Pavičić	Esther	KUMITE GIRLS 13-14 YEARS -49KG	
678	Male	Pilizzari	Leo	KATA BOYS 12 YEARS	
679	Male	Vlahović	Lukas	KATA BOYS 12 YEARS	

Entries: 5

31ST KARATE GRAND PRIX CROATIA

CROATIA

2023.01.20 - 2023.01.22

CITY SPORTS HALL SAMOBOR, ANDRIJE HEBRANGA 26A, SAMOBOR, CROATIA

Tournament Participation (Entries) by Club

 Slavonski Brod (SB_CRO)					
ID	Sex	Family Name	Given Name	Category	
680	CRO 03408	Female	Lujčić	ANA	KATA FEMALE JUNIORS R2-G2
681	CRO 03408	Female	Lujčić	ANA	Kumite female juniors -53kg
682	CRO 03408	Female	Lujčić	ANA	KATA FEMALE JUNIORS

Entries: 3

31ST KARATE GRAND PRIX CROATIA

CROATIA

2023.01.20 - 2023.01.22

CITY SPORTS HALL SAMOBOR, ANDRIJE HEBRANGA 26A, SAMOBOR, CROATIA

Tournament Participation (Entries) by Club

 TAD RIJEKA(TAD)					
ID	Sex	Family Name	Given Name	Category	
683	Male	Donadić	Nino	Kumite Male U21 -60kg	
684	Male	Maćešić	Mihael	KUMITE BOYS 9-10 YEARS -27KG	
685	Female	Skitarelić	Gabi	KUMITE GIRLS 11-12 YEARS -39KG	
686	Male	Vedriš	Raul	Kumite male cadets -63kg	
687	Female	Čeko	Iria	KUMITE GIRLS 11-12 YEARS -39KG	

Entries: 5

31ST KARATE GRAND PRIX CROATIA

CROATIA

2023.01.20 - 2023.01.22

CITY SPORTS HALL SAMOBOR, ANDRIJE HEBRANGA 26A, SAMOBOR, CROATIA

Tournament Participation (Entries) by Club



 ZAMET(RI)					
ID	Sex	Family Name	Given Name	Category	
688	Female	Cvetković Meier	Amelia Victoria	KUMITE GIRLS 9-10 YEARS -39kg	
689	Female	Duduković	Nina	KUMITE GIRLS 13-14 YEARS -64KG	
690	Female	Memić	Sara	KUMITE GIRLS 11-12 YEARS -54KG	
691	Male	Žutelija	Niko	K12 - MALE CADETS/JUNIORS VISUALLY IMPAIRED	

Entries: 4

31ST KARATE GRAND PRIX CROATIA

CROATIA 2023.01.20 - 2023.01.22
CITY SPORTS HALL SAMOBOR, ANDRIJE HEBRANGA 26A, SAMOBOR, CROATIA

Tournament Participation (Entries) by Club

 DENMARK					
 Itosu-kai Bosatsu(Bosatsu)					
ID	Sex	Family Name	Given Name	Category	
692	Female	Bohnhoff	Karla	Kumite female juniors -59kg	
693	Male	Borup Hansen	Esben	KUMITE BOYS 13-14 YEARS -44KG	
694	Male	Brandt	Villads	Kumite male cadets -63kg	
695	Female	Emerslund Henriksen	Vanessa	Kumite female Juniors +66kg	
696	Male	Hristov	andreas	Kumite Male U21 -84kg	
697	Male	Hristov	andreas	Kumite male juniors +76kg	
698	Male	Midjord	Jonathan	Kumite Male U21 -67kg	
699	Male	Poulsen	Alvin	Kumite male cadets -52kg	
700	Male	Poulsen	Alvin	Kumite male juniors -55kg	
701	Male	Udahl	Mathias	Kumite male cadets -63kg	

Entries: **10**

31ST KARATE GRAND PRIX CROATIA

CROATIA 2023.01.20 - 2023.01.22
CITY SPORTS HALL SAMOBOR, ANDRIJE HEBRANGA 26A, SAMOBOR, CROATIA

Tournament Participation (Entries) by Club

 Sportskarate.dk(SPD)					
ID	Sex	Family Name	Given Name	Category	
702	Female	Bath	Astamaja	Kumite female Cadets -61kg	
703	Female	Bath	Astamaja	Kumite female Juniors -66kg	
704	Female	Bath	Hannah	Kumite female Cadets -61kg	
705	Female	Bath	Hannah	KUMITE GIRLS 13-14 YEARS -59KG	
706	Female	Bath	Sofia	Kumite female juniors -48kg	
707	Female	Bath	Sofia	Kumite female cadets -47kg	
708	Female	Bonderup	Alberte	KUMITE GIRLS 13-14 YEARS -59KG	
709	Male	Bonderup	Alexander	Kumite Male U21 -75kg	
710	Male	Kristensen	Hailemichael	Kumite male juniors -61kg	
711	Male	Kristensen	Simon	Kumite male cadets -57kg	
712	Male	Kristensen	Simon	Kumite male juniors -55kg	

Entries: 11

31ST KARATE GRAND PRIX CROATIA

CROATIA 2023.01.20 - 2023.01.22
CITY SPORTS HALL SAMOBOR, ANDRIJE HEBRANGA 26A, SAMOBOR, CROATIA

Tournament Participation (Entries) by Club

FRANCE					
TEAM OSCENDA KARATÉ(Team OSCENDA)					
ID	Sex	Family Name	Given Name	Category	
713	Female	Bouschbacher	Lilou	KUMITE GIRLS 11-12 YEARS -39KG	
714	Female	Egretier	Emma	KUMITE GIRLS 11-12 YEARS -34KG	
715	Female	Franchini	Julia	KUMITE GIRLS 9-10 YEARS -27kg	
716	Male	Freyburger	Nathan	KUMITE BOYS 11-12 YEARS -34KG	
717	Female	Gouy	Louison	KUMITE GIRLS 11-12 YEARS -34KG	
718	Female	Gutschmidt	Zoe	KUMITE GIRLS 11-12 YEARS -39KG	
719	Female	Jaillard	Nell	KUMITE GIRLS 9-10 YEARS -35kg	
720	Male	Jaminet	Samuel	KUMITE BOYS 9-10 YEARS -39kg	
721	Female	Komorowski	Inès	KUMITE GIRLS 9-10 YEARS -27kg	
722	Male	Miranda	William	KUMITE BOYS 9-10 YEARS -27KG	
723	Male	Mollard	Aleth	KUMITE BOYS 7-8 YEARS -28kg	
724	Male	Pogosyan	Shirak	Kumite male cadets -70kg	
725	Male	Pogosyan	Shirak	Kumite male juniors -68kg	
726	Male	Wurtz	Nolan	KUMITE BOYS 11-12 YEARS -44KG	

Entries: 14

31ST KARATE GRAND PRIX CROATIA

CROATIA 2023.01.20 - 2023.01.22
CITY SPORTS HALL SAMOBOR, ANDRIJE HEBRANGA 26A, SAMOBOR, CROATIA

Tournament Participation (Entries) by Club

🇬🇷 GREECE					
🇬🇷 ATHLITIKOS SYLLOGOS AMAROUSIOU(GR_482)					
ID	Sex	Family Name	Given Name	Category	
727	Male	KARAGIANNIS	STAVROS	KUMITE BOYS 11-12 YEARS -44KG	
728	Male	NIKIFOROS	MICHAIL	KUMITE BOYS 9-10 YEARS -27KG	
729	Male	NIKIFOROS	MICHAIL	KATA BOYS 10 YEARS	
730	Male	NIKIFOROS	MICHAIL	KATA BOYS 9 YEARS	
731	Female	PERGALIA	AGATHI AGAPI	KUMITE GIRLS 13-14 YEARS -54KG	
732	Female	PERGALIA	AGATHI AGAPI	KUMITE GIRLS 11-12 YEARS -54KG	
733	Female	PERGALIA	ANASTASIA EIRINI	KUMITE GIRLS 13-14 YEARS -54KG	
734	Female	PERGALIA	ANASTASIA EIRINI	KUMITE GIRLS 11-12 YEARS -54KG	
735	Male	VYTHOULKAS	GEORGIOS	KATA BOYS 12 YEARS	
736	Male	VYTHOULKAS	GEORGIOS	KATA BOYS 13 YEARS	

Entries: **10**

31ST KARATE GRAND PRIX CROATIA

CROATIA 2023.01.20 - 2023.01.22
CITY SPORTS HALL SAMOBOR, ANDRIJE HEBRANGA 26A, SAMOBOR, CROATIA

Tournament Participation (Entries) by Club

 ΑΣ ΠΑΡΘΕΝΩΝ ΚΟΡΥΔΑΛΛΟΥ(526-ΧΑ08)					
ID	Sex	Family Name	Given Name	Category	
737	Female	ΠΑΠΑΣΠΥΡΟΥ	ΒΑΣΙΛΙΚΗ	KATA GIRLS 13 YEARS	

Entries: 1

31ST KARATE GRAND PRIX CROATIA

CROATIA

2023.01.20 - 2023.01.22

CITY SPORTS HALL SAMOBOR, ANDRIJE HEBRANGA 26A, SAMOBOR, CROATIA

Tournament Participation (Entries) by Club

 ΑΣΑ ΣΟΤΟΚΑΝ ΚΑΡΑΤΕ(371-ΦΝ68)					
ID	Sex	Family Name	Given Name	Category	
738	Male	ΜΩΡΑΪΤΗΣ	ΑΓΓΕΛΟΣ	Kumite male cadets -52kg	
739	Male	ΜΩΡΑΪΤΗΣ	ΝΙΚΟΛΑΟΣ	Kumite male juniors +76kg	

Entries: 2

31ST KARATE GRAND PRIX CROATIA

CROATIA

2023.01.20 - 2023.01.22

CITY SPORTS HALL SAMOBOR, ANDRIJE HEBRANGA 26A, SAMOBOR, CROATIA

Tournament Participation (Entries) by Club

 ΑΣΣΚ ΠΕΡΣΕΑΣ(492-ΦΩ37)					
ID	Sex	Family Name	Given Name	Category	
740	Male	ΒΑΣΙΛΟΠΟΥΛΟΣ	ΓΕΩΡΓΙΟΣ	Kumite male juniors -76kg	
741	Male	ΤΡΑΓΑΣ	ΝΙΚΟΛΑΟΣ	Kumite Male U21 -67kg	
742	Male	ΤΡΑΓΑΣ	ΣΩΤΗΡΙΟΣ	Kumite Male U21 -84kg	
743	Male	ΤΡΑΓΑΣ	ΣΩΤΗΡΙΟΣ	KUMITE MALE SENIORS	

Entries: 4



31ST KARATE GRAND PRIX CROATIA

CROATIA

2023.01.20 - 2023.01.22

CITY SPORTS HALL SAMOBOR, ANDRIJE HEBRANGA 26A, SAMOBOR, CROATIA

Tournament Participation (Entries) by Club

 HUNGARY					
 BVSC-Zugló(Bvsc)					
ID	Sex	Family Name	Given Name	Category	
744	Female	Ádám	Alexandra	Kumite Female U21 - 68kg	

Entries: 1

31ST KARATE GRAND PRIX CROATIA

CROATIA

2023.01.20 - 2023.01.22

CITY SPORTS HALL SAMOBOR, ANDRIJE HEBRANGA 26A, SAMOBOR, CROATIA

Tournament Participation (Entries) by Club

 Bátaszék SE(BSE)					
ID	Sex	Family Name	Given Name	Category	
745	Male	Nagy-Jánosi	Bátor	KUMITE BOYS 9-10 YEARS -31kg	

Entries: 1

31ST KARATE GRAND PRIX CROATIA

CROATIA 2023.01.20 - 2023.01.22
CITY SPORTS HALL SAMOBOR, ANDRIJE HEBRANGA 26A, SAMOBOR, CROATIA

Tournament Participation (Entries) by Club

 GASTROYAL SE(GASTROYAL SE)					
ID	Sex	Family Name	Given Name	Category	
746	Female	Szodorai	Bianka	Kumite Female U21 -55kg	

Entries: 1

31ST KARATE GRAND PRIX CROATIA

CROATIA

2023.01.20 - 2023.01.22

CITY SPORTS HALL SAMOBOR, ANDRIJE HEBRANGA 26A, SAMOBOR, CROATIA

Tournament Participation (Entries) by Club

 Karate Klub Sportingbudo(Sportingbudo)					
ID	Sex	Family Name	Given Name	Category	
747	Female	Bárdos	Anna	Kumite female cadets -47kg	
748	Male	Bárdos	Ádám	kata male U21	
749	Male	Bárdos	Ádám	kata male U21 R3-G2	
750	Male	Bárdos	Ádám	kata male U21 R2-G2	
751	Male	Bárdos	Ádám	kata male U21 R4 Gold Medal Match	
752	Male	Szócs	Ambrus	Kumite male juniors -55kg	

Entries: 6

31ST KARATE GRAND PRIX CROATIA

CROATIA

2023.01.20 - 2023.01.22

CITY SPORTS HALL SAMOBOR, ANDRIJE HEBRANGA 26A, SAMOBOR, CROATIA

Tournament Participation (Entries) by Club

 KARATE KLUB SPORTINGBUDO(PORTINGBUDO)					
ID	Sex	Family Name	Given Name	Category	
753	Male	Szocs	Lazar Miksa	KUMITE BOYS 13-14 YEARS -44KG	
754	Male	Szocs	Lazar Miksa	Kumite male cadets -52kg	

Entries: 2

31ST KARATE GRAND PRIX CROATIA

CROATIA 2023.01.20 - 2023.01.22
CITY SPORTS HALL SAMOBOR, ANDRIJE HEBRANGA 26A, SAMOBOR, CROATIA

Tournament Participation (Entries) by Club

 KSI Hungary(KSI)					
ID	Sex	Family Name	Given Name	Category	
755	Male	Beke	Bálint	Kata male seniors	
756	Male	Beke	Bálint	kata male U21	
757	Male	Beke	Bálint	kata male U21 R2-G1	
758	Female	Fodor	Amira	KATA FEMALE JUNIORS R4 Bronze Medal Match 1	
759	Female	Fodor	Amira	KATA female cadets	
760	Female	Fodor	Amira	KATA female cadets R4 Bronze Medal Match 2	
761	Female	Fodor	Amira	KATA FEMALE JUNIORS R3-G1	
762	Female	Fodor	Amira	KATA female cadets R3-G2	
763	Female	Fodor	Amira	KATA FEMALE JUNIORS R2-G1	
764	Female	Fodor	Amira	KATA female cadets R2-G2	
765	Female	Fodor	Amira	KATA FEMALE JUNIORS	
766	Male	Szabó	Marcell	Kumite Male U21 -60kg	
767	Female	Szilágyi	Emma	KATA female cadets R2-G1	
768	Female	Szilágyi	Emma	KATA female cadets	

Entries: 14

31ST KARATE GRAND PRIX CROATIA

CROATIA

2023.01.20 - 2023.01.22

CITY SPORTS HALL SAMOBOR, ANDRIJE HEBRANGA 26A, SAMOBOR, CROATIA

Tournament Participation (Entries) by Club

 MTK Budapest(MTK)					
ID	Sex	Family Name	Given Name	Category	
769	Female	Bacsó	Kata	KATA GIRLS 14 YEARS	
770	Female	Benkó	Nóra	KATA GIRLS 11 YEARS	
771	Female	Benkó	Szonja Lola	KATA GIRLS 13 YEARS	
772	Female	Fleischer	Dóra	Kumite female Juniors +66kg	
773	Female	Gáspár	Laura	Kumite female juniors -48kg	
774	Male	Knirsch	Patrik	Kumite Male U21 -75kg	

Entries: 6

31ST KARATE GRAND PRIX CROATIA

CROATIA

2023.01.20 - 2023.01.22

CITY SPORTS HALL SAMOBOR, ANDRIJE HEBRANGA 26A, SAMOBOR, CROATIA

Tournament Participation (Entries) by Club

 SZARVAS(SZARVAS)					
ID	Sex	Family Name	Given Name	Category	
775	Male	Bagi	Ádám	KUMITE BOYS 11-12 YEARS -39KG	
776	Female	Bagosi	Marianna	KUMITE GIRLS 13-14 YEARS -64KG	
777	Male	KELEMEN	KERTI	Kumite Male U21 -67kg	
778	Male	Müller	Márton	KUMITE BOYS 13-14 YEARS -44KG	
779	Male	Ruzsinszki	Balázs	Kumite male cadets -52kg	
780	Male	Ruzsinszki	Balázs	KUMITE BOYS 13-14 YEARS -54KG	

Entries: 6

31ST KARATE GRAND PRIX CROATIA

CROATIA

2023.01.20 - 2023.01.22

CITY SPORTS HALL SAMOBOR, ANDRIJE HEBRANGA 26A, SAMOBOR, CROATIA

Tournament Participation (Entries) by Club

 TISZA VOLÁN SC(TISZA VOLÁN SC)					
ID	Sex	Family Name	Given Name	Category	
781	Male	FRANKÓ	DÁNIEL	Kumite Male U21 +84kg	

Entries: 1

31ST KARATE GRAND PRIX CROATIA

CROATIA

2023.01.20 - 2023.01.22

CITY SPORTS HALL SAMOBOR, ANDRIJE HEBRANGA 26A, SAMOBOR, CROATIA

Tournament Participation (Entries) by Club

 Toriki Sportkarate Club Zalaegerszeg(TORIKI)					
ID	Sex	Family Name	Given Name	Category	
782	Female	Osbáth	Hanna	Kumite female Cadets +61kg	
783	Female	Osbáth	Lora	Kumite female Cadets +61kg	

Entries: 2

31ST KARATE GRAND PRIX CROATIA

CROATIA

2023.01.20 - 2023.01.22

CITY SPORTS HALL SAMOBOR, ANDRIJE HEBRANGA 26A, SAMOBOR, CROATIA

Tournament Participation (Entries) by Club



 UTE HUNGARY(UTE)					
ID	Sex	Family Name	Given Name	Category	
784	Male	Gulyas	Gergely	KATA male cadets R2-G2	
785	Male	Gulyas	Gergely	KATA male cadets	

Entries: 2

31ST KARATE GRAND PRIX CROATIA

CROATIA 2023.01.20 - 2023.01.22
CITY SPORTS HALL SAMOBOR, ANDRIJE HEBRANGA 26A, SAMOBOR, CROATIA

Tournament Participation (Entries) by Club

 INDIA					
 Diamond International Dojo(Diamond International Dojo)					
ID	Sex	Family Name	Given Name	Category	
786	Male	Ghai	Jeevan Lal	KUMITE MALE SENIORS	
787	Male	Gurpreet	Gurpreet	Kumite Male U21 -60kg	
788	Male	Kumar	Raj	KUMITE MALE SENIORS	
789	Male	Singh	Lovepreet	Kumite Male U21 -60kg	

Entries: 4

31ST KARATE GRAND PRIX CROATIA

CROATIA

2023.01.20 - 2023.01.22

CITY SPORTS HALL SAMOBOR, ANDRIJE HEBRANGA 26A, SAMOBOR, CROATIA

Tournament Participation (Entries) by Club

 SURINDER SALARIA(SURINDER SALARIA)					
ID	Sex	Family Name	Given Name	Category	
790	Male	Kumar	Naresh	KUMITE MALE SENIORS	
791	Female	Rani	Shobha	Kata female seniors	

Entries: 2

31ST KARATE GRAND PRIX CROATIA

CROATIA 2023.01.20 - 2023.01.22
CITY SPORTS HALL SAMOBOR, ANDRIJE HEBRANGA 26A, SAMOBOR, CROATIA

Tournament Participation (Entries) by Club

ISRAEL					
Azkokai Makabi Bat-yam(Azkokai Makabi Bat-yam)					
ID	Sex	Family Name	Given Name	Category	
792	Male	Abramchayev	Netanel	KUMITE BOYS 13-14 YEARS -44KG	
793	Female	Abramchayev	Nicol	Kumite female Juniors +66kg	
794	Male	Aminov	Ronen Yosef	Kumite male juniors -76kg	
795	Male	Barkan	Moshe	KUMITE BOYS 13-14 YEARS -44KG	
796	Male	Cohen	Yali	KUMITE BOYS 13-14 YEARS -44KG	
797	Male	Gerasimov	Ivan	Kumite male juniors -55kg	
798	Male	Grinberg	David	Kumite male juniors -55kg	
799	Male	Kimyagarov	Arel	Kumite male cadets -52kg	
800	Male	Kirnosov	Andrey	KUMITE BOYS 11-12 YEARS -44KG	
801	Male	Samadov	Ilgar	KUMITE BOYS 11-12 YEARS -44KG	
802	Male	Verchilovsky	Liam	KUMITE BOYS 11-12 YEARS -39KG	
803	Male	Zlatin	David	Kumite male cadets -70kg	

Entries: 12

31ST KARATE GRAND PRIX CROATIA

CROATIA

2023.01.20 - 2023.01.22

CITY SPORTS HALL SAMOBOR, ANDRIJE HEBRANGA 26A, SAMOBOR, CROATIA

Tournament Participation (Entries) by Club

 israel meitar wcsk(md)					
ID	Sex	Family Name	Given Name	Category	
804	Female	fox	Lia	Kumite female cadets -47kg	
805	Female	gerlic	Annie	Kumite female cadets -47kg	
806	Female	Kreh	Klil	Kumite female cadets -47kg	

Entries: 3

31ST KARATE GRAND PRIX CROATIA

CROATIA 2023.01.20 - 2023.01.22
CITY SPORTS HALL SAMOBOR, ANDRIJE HEBRANGA 26A, SAMOBOR, CROATIA

Tournament Participation (Entries) by Club

JAMAL SAADA SHOTOKAN KARATE(J.S.S.K)					
ID	Sex	Family Name	Given Name	Category	
807	Female	ababsa	lilas	Kumite female cadets -54kg	
808	Male	awawdi	hosni	KUMITE BOYS 11-12 YEARS -49KG	
809	Male	elias	wasim	KUMITE BOYS 9-10 YEARS +43kg	
810	Male	elias	wasim	KATA BOYS 10 YEARS	
811	Male	elias	wasim	KUMITE BOYS 11-12 YEARS -49KG	
812	Male	hamdan	nasser	KUMITE BOYS 9-10 YEARS -43kg	
813	Male	husam	issa	KUMITE BOYS 13-14 YEARS -69KG	
814	Female	khamaisi	jowana	KUMITE GIRLS 11-12 YEARS -34KG	
815	Male	khateeb	ezat	Kumite male cadets -70kg	
816	Male	khazen	khazen	KUMITE BOYS 13-14 YEARS -44KG	
817	Male	kutt	munir	KUMITE MALE SENIORS	
818	Male	qassem	zin el din	KUMITE BOYS 13-14 YEARS -44KG	
819	Male	sawaed	adi	KUMITE BOYS 9-10 YEARS -27KG	
820	Male	sawaed	adi	KATA BOYS 9 YEARS	
821	Male	sawaed	tarek	KUMITE BOYS 13-14 YEARS +69KG	
822	Female	sawaed	tolin	KATA GIRLS 13 YEARS	
823	Male	wissam	issa	KUMITE BOYS 11-12 YEARS -54KG	

Entries: 17

31ST KARATE GRAND PRIX CROATIA

CROATIA 2023.01.20 - 2023.01.22
CITY SPORTS HALL SAMOBOR, ANDRIJE HEBRANGA 26A, SAMOBOR, CROATIA

Tournament Participation (Entries) by Club

JKS ISRAEL(JKSISR)					
ID	Sex	Family Name	Given Name	Category	
824	Male	BUGANIM	TOMER	KATA MALE JUNIORS	
825	Male	BUGANIM	TOMER	Kumite male cadets -63kg	
826	Male	Chikorel	Lior	KATA MALE JUNIORS	
827	Male	Chikorel	Lior	Kumite male juniors +76kg	
828	Male	Chikorel	Lior	Kumite Male U21 -84kg	
829	Male	Cohen	Roe	KATA BOYS 14 YEARS	
830	Male	Cohen	Roe	Kumite male cadets -52kg	
831	Male	KATZIR	ASAF	KUMITE BOYS 13-14 YEARS -54KG	
832	Male	KATZIR	ASAF	KATA BOYS 13 YEARS	
833	Male	Katzir	Evyatar	KUMITE BOYS 11-12 YEARS -44KG	
834	Male	Katzir	Evyatar	KATA BOYS 11 YEARS	
835	Female	Mizrahi	Yaara	KUMITE GIRLS 13-14 YEARS -64KG	
836	Female	Mizrahi	Yaara	KATA female cadets	
837	Female	Mizrahi	Yaara	KATA GIRLS 14 YEARS	
838	Female	Mizrahi	Yaara	Kumite female Cadets -61kg	
839	Female	NOAM	YUVAL	Kumite female Cadets +61kg	
840	Female	NOAM	YUVAL	KATA FEMALE JUNIORS	
841	Female	NOAM	YUVAL	KATA female cadets	
842	Female	Philip	Shira	KATA GIRLS 12 YEARS	
843	Female	Philip	Shira	KUMITE GIRLS 11-12 YEARS -44KG	
844	Female	Philip	Shira	KATA GIRLS 11 YEARS	
845	Male	PINKUS	NIMROD	Kata male seniors	
846	Male	PINKUS	NIMROD	KUMITE MALE SENIORS	
847	Female	Shor	Simona	Kata female seniors	
848	Female	Steinberg	Ella	KATA female cadets	
849	Female	Steinberg	Ella	Kumite female Cadets -61kg	
850	Male	TESLER	TOMER	KATA BOYS 14 YEARS	
851	Male	TESLER	TOMER	Kumite male cadets -52kg	

Entries: 28

31ST KARATE GRAND PRIX CROATIA

CROATIA

2023.01.20 - 2023.01.22

CITY SPORTS HALL SAMOBOR, ANDRIJE HEBRANGA 26A, SAMOBOR, CROATIA

Tournament Participation (Entries) by Club

KSK Israel(KSK)					
ID	Sex	Family Name	Given Name	Category	
852	Male	Meir	Yonatan	Kumite male cadets -57kg	

Entries: 1

31ST KARATE GRAND PRIX CROATIA

CROATIA

2023.01.20 - 2023.01.22

CITY SPORTS HALL SAMOBOR, ANDRIJE HEBRANGA 26A, SAMOBOR, CROATIA

Tournament Participation (Entries) by Club

 ROGOZARSKI DOJO(ROG)					
ID	Sex	Family Name	Given Name	Category	
853	Female	HADAD	NETA	Kumite female cadets -47kg	
854	Male	MALAMUD	YONATAN	Kumite male juniors -61kg	
855	Male	ROGOZARSKI	NIKOLA	Kumite Male U21 -75kg	

Entries: 3

31ST KARATE GRAND PRIX CROATIA

CROATIA

2023.01.20 - 2023.01.22

CITY SPORTS HALL SAMOBOR, ANDRIJE HEBRANGA 26A, SAMOBOR, CROATIA

Tournament Participation (Entries) by Club

S.I.K(yoel)					
ID	Sex	Family Name	Given Name	Category	
856	Male	Bar Mashiah	Shaked	Kumite male juniors -61kg	
857	Female	benaroche	maya	Kumite Female U21 -55kg	
858	Female	benaroche	maya	Kumite Female U21 -50kg	
859	Male	Shahar	Yaniv	Kumite male cadets -63kg	
860	Female	varsescu	noga	Kumite female Cadets -61kg	

Entries: 5

31ST KARATE GRAND PRIX CROATIA

CROATIA

2023.01.20 - 2023.01.22

CITY SPORTS HALL SAMOBOR, ANDRIJE HEBRANGA 26A, SAMOBOR, CROATIA

Tournament Participation (Entries) by Club

 SHINDOKAN MACCABI ISRAEL (shindokan)					
ID	Sex	Family Name	Given Name	Category	
861	Female	adel	sando	Kumite female cadets -54kg	
862	Male	nikolay	sando	Kumite male cadets -63kg	
863	Male	tamir	shon	Kumite male cadets -70kg	
864	Male	uresko	tigran	Kumite male cadets -63kg	
865	Female	vaideslaver	karin	Kumite female Juniors -66kg	

Entries: 5

31ST KARATE GRAND PRIX CROATIA

CROATIA

2023.01.20 - 2023.01.22

CITY SPORTS HALL SAMOBOR, ANDRIJE HEBRANGA 26A, SAMOBOR, CROATIA

Tournament Participation (Entries) by Club

Shitokai Israel(shogun-IL)					
ID	Sex	Family Name	Given Name	Category	
866	Male	keidar	URI	Kumite male cadets -52kg	

Entries: 1

31ST KARATE GRAND PRIX CROATIA

CROATIA

2023.01.20 - 2023.01.22

CITY SPORTS HALL SAMOBOR, ANDRIJE HEBRANGA 26A, SAMOBOR, CROATIA

Tournament Participation (Entries) by Club

 Club Desert Star Karate(Ikws)					
ID	Sex	Family Name	Given Name	Category	
867	Ward	Male	Abo grara	Fahd	Kumite male juniors -61kg
868	Ward	Male	Abu Aarara	Haitam	KATA male cadets

Entries: 2

31ST KARATE GRAND PRIX CROATIA

CROATIA 2023.01.20 - 2023.01.22
CITY SPORTS HALL SAMOBOR, ANDRIJE HEBRANGA 26A, SAMOBOR, CROATIA

Tournament Participation (Entries) by Club

🇮🇹 ITALY					
🇮🇹 A.s.d Centro Sport(A.s.d Centro Sport)					
ID	Sex	Family Name	Given Name	Category	
869	Female	Comparin	Gloria	KUMITE GIRLS 13-14 YEARS -44KG	
870	Female	Dalle Fusine	Maria Carlotta	Kumite female Juniors -66kg	

Entries: 2

31ST KARATE GRAND PRIX CROATIA

CROATIA

2023.01.20 - 2023.01.22

CITY SPORTS HALL SAMOBOR, ANDRIJE HEBRANGA 26A, SAMOBOR, CROATIA

Tournament Participation (Entries) by Club

 A.s.d real società Monreale(Real Società)					
ID	Sex	Family Name	Given Name	Category	
871	Male	Costa	Pierluigi	Kata male seniors	
872	Male	Madonia	Filippo Maria	kata male U21	
873	Male	Madonia	Filippo Maria	KATA MALE JUNIORS	

Entries: 3

31ST KARATE GRAND PRIX CROATIA

CROATIA

2023.01.20 - 2023.01.22

CITY SPORTS HALL SAMOBOR, ANDRIJE HEBRANGA 26A, SAMOBOR, CROATIA

Tournament Participation (Entries) by Club

 A.S.D. ACADEMIA HYDRA(HYDRA KARATE LAB)					
ID	Sex	Family Name	Given Name	Category	
874	Female	Beretta	Martina	KATA GIRLS 12 YEARS	
875	Female	Beretta	Martina	KATA GIRLS 13 YEARS	

Entries: 2

31ST KARATE GRAND PRIX CROATIA

CROATIA

2023.01.20 - 2023.01.22

CITY SPORTS HALL SAMOBOR, ANDRIJE HEBRANGA 26A, SAMOBOR, CROATIA

Tournament Participation (Entries) by Club

 A.S.D. Asi Karate Veneto(Asi Karate Veneto)					
ID	Sex	Family Name	Given Name	Category	
876	Male	Barban	Francesco	Kumite Male U21 -75kg	
877	Male	Gueriero	Nicola	Kumite Male U21 +84kg	
878	Female	Miatto	Greta	KUMITE GIRLS 13-14 YEARS -64KG	
879	Female	Pansini	Alessia	KUMITE GIRLS 11-12 YEARS -49KG	
880	Male	Perin	Luca	Kumite Male U21 -67kg	
881	Male	Volpato	Pietro	Kumite male cadets -70kg	

Entries: 6

31ST KARATE GRAND PRIX CROATIA

CROATIA

2023.01.20 - 2023.01.22

CITY SPORTS HALL SAMOBOR, ANDRIJE HEBRANGA 26A, SAMOBOR, CROATIA

Tournament Participation (Entries) by Club

 A.S.D. Champion Center (Champion Center)					
ID	Sex	Family Name	Given Name	Category	
882	Female	Bifulco	Asia	Kumite female juniors -53kg	
883	Female	Cuzzolino	Mariaconcetta	Kumite female Juniors -66kg	
884	Female	Cuzzolino	Mariaconcetta	Kumite Female U21 - 68kg	
885	Male	Palma	Domenico	Kumite male cadets +70kg	
886	Female	Portoghese	Morena	Kumite female Juniors +66kg	
887	Female	Portoghese	Morena	Kumite Female U21 - 68kg	

Entries: 6

31ST KARATE GRAND PRIX CROATIA

CROATIA

2023.01.20 - 2023.01.22

CITY SPORTS HALL SAMOBOR, ANDRIJE HEBRANGA 26A, SAMOBOR, CROATIA

Tournament Participation (Entries) by Club

A.S.D. JISEI BUDO A.M.I.(ASD JISEI BUDO AMI)					
ID	Sex	Family Name	Given Name	Category	
888	Female	GUERRIERO	NICOLE	Kumite Female U21 - 61kg	

Entries: 1

31ST KARATE GRAND PRIX CROATIA

CROATIA

2023.01.20 - 2023.01.22

CITY SPORTS HALL SAMOBOR, ANDRIJE HEBRANGA 26A, SAMOBOR, CROATIA

Tournament Participation (Entries) by Club

 A.S.D. JOHNNYS KARATE BORGO SISA(JOHNYS KARATE)					
ID	Sex	Family Name	Given Name	Category	
889	Male	FOSCHI	SEBASTIAN	Kumite male cadets -52kg	
890	Male	PINTO	ALESSIO	KATA male cadets	

Entries: 2

31ST KARATE GRAND PRIX CROATIA

CROATIA 2023.01.20 - 2023.01.22
CITY SPORTS HALL SAMOBOR, ANDRIJE HEBRANGA 26A, SAMOBOR, CROATIA

Tournament Participation (Entries) by Club

 a.s.d. karate roma(a.s.d. karate roma)					
ID	Sex	Family Name	Given Name	Category	
891	Male	caponera	emanuele	KATA male cadets	
892	Male	caponera	emanuele	KATA male cadets R3-G2	
893	Male	caponera	emanuele	KATA male cadets R2-G2	
894	Male	caponera	emanuele	KATA male cadets R4 Gold Medal Match	
895	Female	Eusepi	Alessia	kata female U21 R2-G2	
896	Female	Eusepi	Alessia	kata female U21	
897	Female	Eusepi	Alessia	kata female U21 R3 Gold Medal Match	

Entries: 7

31ST KARATE GRAND PRIX CROATIA

CROATIA

2023.01.20 - 2023.01.22

CITY SPORTS HALL SAMOBOR, ANDRIJE HEBRANGA 26A, SAMOBOR, CROATIA

Tournament Participation (Entries) by Club

 A.S.D. MABUNI CLUB CIVITAVECCHIA(mabuni)					
ID	Sex	Family Name	Given Name	Category	
898	Male	Conversini	Simone	KUMITE BOYS 11-12 YEARS -54KG	

Entries: 1

31ST KARATE GRAND PRIX CROATIA

CROATIA

2023.01.20 - 2023.01.22

CITY SPORTS HALL SAMOBOR, ANDRIJE HEBRANGA 26A, SAMOBOR, CROATIA

Tournament Participation (Entries) by Club

 A.S.D. POL. POLO VERDE(POLO VERDE-PALERMO)					
ID	Sex	Family Name	Given Name	Category	
899	Male	Valdesi	Francesco	kata male U21 R2-G1	
900	Male	Valdesi	Francesco	kata male U21	
901	Male	Valdesi	Francesco	KATA MALE JUNIORS	

Entries: 3

31ST KARATE GRAND PRIX CROATIA

CROATIA

2023.01.20 - 2023.01.22

CITY SPORTS HALL SAMOBOR, ANDRIJE HEBRANGA 26A, SAMOBOR, CROATIA

Tournament Participation (Entries) by Club

 A.S.D. Sen Shin Kai Rovigo(SSKR)					
ID	Sex	Family Name	Given Name	Category	
902	Male	Bicos	Nikita	KATA MALE JUNIORS	
903	Male	Bicos	Nikita	KATA male cadets R4 Bronze Medal Match 2	
904	Male	Bicos	Nikita	KATA male cadets	
905	Male	Bicos	Nikita	KATA male cadets R3-G2	
906	Male	Bicos	Nikita	KATA male cadets R2-G2	
907	Male	Calabrese	Luca	Kata male seniors	
908	Male	Calabrese	Luca	kata male U21	
909	Male	Calabrese	Luca	KATA MALE JUNIORS	
910	Female	Cappellato	Maria	Kata female seniors	
911	Female	Cappellato	Maria	KATA FEMALE JUNIORS	

Entries: **10**

31ST KARATE GRAND PRIX CROATIA

CROATIA 2023.01.20 - 2023.01.22
CITY SPORTS HALL SAMOBOR, ANDRIJE HEBRANGA 26A, SAMOBOR, CROATIA

Tournament Participation (Entries) by Club

 A.S.D. SHIZOKU KARATE AVELLINO(SHIZOKU KRT AV)					
ID	Sex	Family Name	Given Name	Category	
912	Male	Accomando	Francesco	Kumite Male U21 -67kg	
913	Female	Andreottola	Laura	Kumite female juniors -48kg	
914	Male	Branchi	Niccolò	Kumite male cadets +70kg	
915	Male	De Stefano	Emanuele	Kumite male juniors -55kg	
916	Male	De Stefano	Emanuele	Kumite male cadets -57kg	
917	Male	Iannuzzi	Mario	Kumite male juniors -76kg	
918	Male	Iannuzzi	Mario	Kumite Male U21 -75kg	
919	Male	Loffredo	Francesco	Kumite male juniors -68kg	
920	Female	Silvestro	Giulia	Kumite Female U21 + 68kg	

Entries: **9**

31ST KARATE GRAND PRIX CROATIA

CROATIA 2023.01.20 - 2023.01.22
CITY SPORTS HALL SAMOBOR, ANDRIJE HEBRANGA 26A, SAMOBOR, CROATIA

Tournament Participation (Entries) by Club

 A.S.D. TEAM KARATE ARZACHENA(TEAM KARATE ARZACHENA)					
ID	Sex	Family Name	Given Name	Category	
921	Male	Cuccia	Riccardo	Kumite male cadets +70kg	
922	Female	Dettori	Sabrina	KATA GIRLS 11 YEARS	
923	Female	Orecchioni	Eleonora	Kumite Female U21 + 68kg	

Entries: 3

31ST KARATE GRAND PRIX CROATIA

CROATIA

2023.01.20 - 2023.01.22

CITY SPORTS HALL SAMOBOR, ANDRIJE HEBRANGA 26A, SAMOBOR, CROATIA

Tournament Participation (Entries) by Club

 A.S.D. VILLA PIGNA KARATE(A.S.D. VILLA PIGNA KARATE)					
ID	Sex	Family Name	Given Name	Category	
924	Male	DAutorio	Igor	KATA BOYS 12 YEARS	
925	Male	DAutorio	Igor	KATA BOYS 13 YEARS	

Entries: 2

31ST KARATE GRAND PRIX CROATIA

CROATIA

2023.01.20 - 2023.01.22

CITY SPORTS HALL SAMOBOR, ANDRIJE HEBRANGA 26A, SAMOBOR, CROATIA

Tournament Participation (Entries) by Club

 A.T. karate club Roma(A.T. karate club Roma)					
ID	Sex	Family Name	Given Name	Category	
926	Female	CECERE	MARIKA	Kumite Female U21 - 61kg	

Entries: 1

31ST KARATE GRAND PRIX CROATIA

CROATIA

2023.01.20 - 2023.01.22

CITY SPORTS HALL SAMOBOR, ANDRIJE HEBRANGA 26A, SAMOBOR, CROATIA

Tournament Participation (Entries) by Club

 ACADEMY PONTE DI PIAVE ASD(ASDK PDP)					
ID	Sex	Family Name	Given Name	Category	
927	Male	Guerra	Riccardo	Kumite male juniors -55kg	
928	Male	Sorci	Filippo	Kumite male juniors -55kg	

Entries: 2

31ST KARATE GRAND PRIX CROATIA

CROATIA

2023.01.20 - 2023.01.22

CITY SPORTS HALL SAMOBOR, ANDRIJE HEBRANGA 26A, SAMOBOR, CROATIA

Tournament Participation (Entries) by Club

 Accademia Karate Montevarchi A.S.D.(Acc. Karate Montevarchi)					
ID	Sex	Family Name	Given Name	Category	
929	Male	Mearini	Gioele	Kumite Male U21 -60kg	
930	Male	Mearini	Gioele	KUMITE MALE SENIORS	
931	Male	Trefoloni	Alessio	KUMITE MALE SENIORS	
932	Male	Trefoloni	Alessio	Kumite Male U21 -75kg	

Entries: 4

31ST KARATE GRAND PRIX CROATIA

CROATIA 2023.01.20 - 2023.01.22
CITY SPORTS HALL SAMOBOR, ANDRIJE HEBRANGA 26A, SAMOBOR, CROATIA

Tournament Participation (Entries) by Club

 ACCADEMIA KARATE UNION TEAM(AK)					
ID	Sex	Family Name	Given Name	Category	
933	Male	LIBERTI	Santino	Kumite male cadets +70kg	
934	Male	MAURO	Cristian	KUMITE BOYS 13-14 YEARS +69KG	
935	Male	PELAGGI	Agostino	Kumite male cadets +70kg	

Entries: 3

31ST KARATE GRAND PRIX CROATIA

CROATIA

2023.01.20 - 2023.01.22

CITY SPORTS HALL SAMOBOR, ANDRIJE HEBRANGA 26A, SAMOBOR, CROATIA

Tournament Participation (Entries) by Club

 ACSD BUDO LACASSIA torino(BudoLacassia)					
ID	Sex	Family Name	Given Name	Category	
936	Male	Dominici	Matteo	Kumite male juniors -68kg	
937	Male	LACASSIA	Leonardo	Kumite Male U21 +84kg	
938	Female	Laiolo	Serena	Kumite female juniors -59kg	

Entries: 3

31ST KARATE GRAND PRIX CROATIA

CROATIA 2023.01.20 - 2023.01.22
CITY SPORTS HALL SAMOBOR, ANDRIJE HEBRANGA 26A, SAMOBOR, CROATIA

Tournament Participation (Entries) by Club

 Akashido(Akashido Palermo)					
ID	Sex	Family Name	Given Name	Category	
939	Female	Agrati	Jennifer	Kumite female juniors -53kg	
940	Female	Agrati	Jennifer	Kumite female cadets -54kg	
941	Female	DARDANONI	EMMA	Kumite female juniors -59kg	
942	Female	DI MICELI	MIRIAM	Kumite female juniors -53kg	
943	Female	DI MICELI	MIRIAM	Kumite female cadets -54kg	
944	Female	PEZZINO	FLAVIA	KUMITE GIRLS 11-12 YEARS -44KG	

Entries: 6

31ST KARATE GRAND PRIX CROATIA

CROATIA 2023.01.20 - 2023.01.22
CITY SPORTS HALL SAMOBOR, ANDRIJE HEBRANGA 26A, SAMOBOR, CROATIA

Tournament Participation (Entries) by Club

🇮🇹 ASCD ATLANTIDE(ATLANTIDE TROINA)					
ID	Sex	Family Name	Given Name	Category	
945	Female	Pacino	valentina	Kumite Female U21 -55kg	

Entries: 1

31ST KARATE GRAND PRIX CROATIA

CROATIA 2023.01.20 - 2023.01.22
CITY SPORTS HALL SAMOBOR, ANDRIJE HEBRANGA 26A, SAMOBOR, CROATIA

Tournament Participation (Entries) by Club

 ASD CENTRO STUDI KARATE NEGRAR(ASD CSK NEGRAR)					
ID	Sex	Family Name	Given Name	Category	
946	Female	Salvi	Caterina	Kumite female Cadets -61kg	
947	Female	Tommasi	Agnese	Kumite Female U21 -55kg	

Entries: 2

31ST KARATE GRAND PRIX CROATIA

CROATIA 2023.01.20 - 2023.01.22
CITY SPORTS HALL SAMOBOR, ANDRIJE HEBRANGA 26A, SAMOBOR, CROATIA

Tournament Participation (Entries) by Club

ASD ESERCITO - 187° FOLGORE(ASD ESERCITO - 187 FOLGORE)					
ID	Sex	Family Name	Given Name	Category	
948	Male	BOZZI	ANDREA	Kumite male juniors -76kg	
949	Male	BOZZI	ANDREA	Kumite Male U21 -75kg	
950	Male	CITI	JACOPO	Kumite male cadets -52kg	
951	Female	Di Lelio	Elena	Kata female seniors	
952	Female	Di Lelio	Elena	kata female U21	
953	Female	Di Lelio	Elena	kata female U21 R2-G2	
954	Female	FRIZZI	EMMA LUDOVICA	Kumite female juniors -59kg	
955	Male	LIGAS	EDOARDO	KUMITE BOYS 13-14 YEARS -54KG	
956	Male	LIGAS	EDOARDO	Kumite male cadets -52kg	
957	Male	NANNINI	LEONARDO	KUMITE BOYS 11-12 YEARS -39KG	
958	Male	SIMONETTI	NICHOLAS	Kumite male cadets -52kg	

Entries: 11

31ST KARATE GRAND PRIX CROATIA

CROATIA 2023.01.20 - 2023.01.22
CITY SPORTS HALL SAMOBOR, ANDRIJE HEBRANGA 26A, SAMOBOR, CROATIA

Tournament Participation (Entries) by Club

 ASD FC MOREVILLA(Asd Morevilla)					
ID	Sex	Family Name	Given Name	Category	
959	435465	Male	NARDACCIO	MATTEO	KATA BOYS 13 YEARS
960	435465	Male	NARDACCIO	MATTEO	KATA BOYS 14 YEARS

Entries: 2

31ST KARATE GRAND PRIX CROATIA

CROATIA

2023.01.20 - 2023.01.22

CITY SPORTS HALL SAMOBOR, ANDRIJE HEBRANGA 26A, SAMOBOR, CROATIA

Tournament Participation (Entries) by Club

 ASD Fitness Club Nuova Florida(12RM1604)					
ID	Sex	Family Name	Given Name	Category	
961	Female	Damato	Alice	Kumite female juniors -48kg	

Entries: 1

31ST KARATE GRAND PRIX CROATIA

CROATIA 2023.01.20 - 2023.01.22
CITY SPORTS HALL SAMOBOR, ANDRIJE HEBRANGA 26A, SAMOBOR, CROATIA

Tournament Participation (Entries) by Club

 ASD IPPON 2(I 2 K)					
ID	Sex	Family Name	Given Name	Category	
962	Female	De Rosso	Cristina	Kumite female juniors -53kg	
963	Male	Giacobbe	Giulio	Kumite male juniors -55kg	
964	Male	Mosca	Filippo	Kumite male cadets -70kg	

Entries: 3

31ST KARATE GRAND PRIX CROATIA

CROATIA

2023.01.20 - 2023.01.22

CITY SPORTS HALL SAMOBOR, ANDRIJE HEBRANGA 26A, SAMOBOR, CROATIA

Tournament Participation (Entries) by Club

 asd judo karate club(asd jk club)					
ID	Sex	Family Name	Given Name	Category	
965	Female	burzo	carolina	Kumite female juniors -53kg	
966	Male	ferrarini	francesco	Kumite male cadets -70kg	
967	Male	ferrarini	francesco	KUMITE BOYS 13-14 YEARS -69KG	

Entries: 3

31ST KARATE GRAND PRIX CROATIA

CROATIA 2023.01.20 - 2023.01.22
CITY SPORTS HALL SAMOBOR, ANDRIJE HEBRANGA 26A, SAMOBOR, CROATIA

Tournament Participation (Entries) by Club

ASD KARATE 2001(K 01)					
ID	Sex	Family Name	Given Name	Category	
968	Female	DEste	Federica	Kumite Female U21 - 61kg	

Entries: 1

31ST KARATE GRAND PRIX CROATIA

CROATIA 2023.01.20 - 2023.01.22
CITY SPORTS HALL SAMOBOR, ANDRIJE HEBRANGA 26A, SAMOBOR, CROATIA

Tournament Participation (Entries) by Club

 ASD Karate club kanazawa(Kanazawa Cimadolmo)					
ID	Sex	Family Name	Given Name	Category	
969	Female	CALLEGHER	ARIANNA	K22 - FEMALE SENIORS INTELLECTUALLY IMPAIRED	
970	Male	Feletto	Gianluigi	K22 - MALE SENIORS INTELLECTUALLY IMPAIRED	
971	Female	MARCAT	STEFANIA	K21 - FEMALE SENIORS INTELLECTUALLY IMPAIRED	
972	Female	Paro	Cristiana	K22 - FEMALE SENIORS INTELLECTUALLY IMPAIRED	
973	Male	Vedelago	Christian	K21 - MALE SENIORS INTELLECTUALLY IMPAIRED	

Entries: 5

31ST KARATE GRAND PRIX CROATIA

CROATIA 2023.01.20 - 2023.01.22
CITY SPORTS HALL SAMOBOR, ANDRIJE HEBRANGA 26A, SAMOBOR, CROATIA

Tournament Participation (Entries) by Club

 ASD KARATE CLUB VALDOBBIADENE CROCETTA(ASD KARATE VALDO)					
ID	Sex	Family Name	Given Name	Category	
974	Female	BROTTO	VIOLA GERMANA	KUMITE GIRLS 11-12 YEARS -34KG	
975	Male	CORBANESE	ENRICO	KUMITE BOYS 13-14 YEARS -44KG	
976	Female	Pryndiuk	Anastasia	KUMITE GIRLS 11-12 YEARS -39KG	
977	Male	Pryndiuk	Artem	KUMITE BOYS 11-12 YEARS -44KG	
978	Female	SOLIMANO	ISABEL	KUMITE GIRLS 13-14 YEARS -44KG	
979	Female	STRAMARE	ILARIA	KUMITE GIRLS 11-12 YEARS -34KG	
980	Female	VETTORETTI	GIADA	KUMITE GIRLS 13-14 YEARS -49KG	

Entries: 7

31ST KARATE GRAND PRIX CROATIA

CROATIA 2023.01.20 - 2023.01.22
CITY SPORTS HALL SAMOBOR, ANDRIJE HEBRANGA 26A, SAMOBOR, CROATIA

Tournament Participation (Entries) by Club

 ASD KARATE SACILE(KARATE SACILE)					
ID	Sex	Family Name	Given Name	Category	
981	Male	PAGOS	LUCA	Kumite male juniors -55kg	
982	Male	PAGOS	LUCA	Kumite Male U21 -60kg	
983	Female	RAIMONDI	ALESSIA	Kumite Female U21 -55kg	

Entries: 3

31ST KARATE GRAND PRIX CROATIA

CROATIA 2023.01.20 - 2023.01.22
CITY SPORTS HALL SAMOBOR, ANDRIJE HEBRANGA 26A, SAMOBOR, CROATIA

Tournament Participation (Entries) by Club

🇮🇹 asd KARATE TEAM 1999(KARATE TEAM 1999)					
ID	Sex	Family Name	Given Name	Category	
984	Male	BELLUZZI	MATTEO	KUMITE BOYS 9-10 YEARS -43kg	
985	Male	Cielo	Luca	KUMITE BOYS 7-8 YEARS -24kg	
986	Male	GAROFALO	GABRIELE	KUMITE BOYS 9-10 YEARS -27KG	
987	Female	Gavioli	Melissa	KUMITE GIRLS 11-12 YEARS -49KG	
988	Male	MOI	GIOELE	Kumite male cadets -52kg	
989	Female	Zamberlan	Emma	KUMITE GIRLS 11-12 YEARS -44KG	

Entries: 6

31ST KARATE GRAND PRIX CROATIA

CROATIA

2023.01.20 - 2023.01.22

CITY SPORTS HALL SAMOBOR, ANDRIJE HEBRANGA 26A, SAMOBOR, CROATIA

Tournament Participation (Entries) by Club

 asd karate team isernia(karate team isernia)					
ID	Sex	Family Name	Given Name	Category	
990	Male	Di lemme	Alessandro	Kumite male juniors -55kg	

Entries: 1

31ST KARATE GRAND PRIX CROATIA

CROATIA 2023.01.20 - 2023.01.22
CITY SPORTS HALL SAMOBOR, ANDRIJE HEBRANGA 26A, SAMOBOR, CROATIA

Tournament Participation (Entries) by Club

 ASD OKINAWA FIGHT(OKINAWA FIGHT ASD)					
ID	Sex	Family Name	Given Name	Category	
991	Male	Gotti	Thomas	KUMITE BOYS 11-12 YEARS -49KG	
992	Male	Pirvu	Rafael	KUMITE BOYS 11-12 YEARS -54KG	

Entries: 2

31ST KARATE GRAND PRIX CROATIA

CROATIA

2023.01.20 - 2023.01.22

CITY SPORTS HALL SAMOBOR, ANDRIJE HEBRANGA 26A, SAMOBOR, CROATIA

Tournament Participation (Entries) by Club

 ASD REMBUKAN KARATE VILLASMUNDO(REMBUKAN VILLASMUNDO)					
ID	Sex	Family Name	Given Name	Category	
993	Female	BARONE	MIRYAM	Kumite female juniors -53kg	
994	Male	CASTRO	RICCARDO	KUMITE BOYS 13-14 YEARS -44KG	
995	Male	SANZARO	MICHELE	KUMITE BOYS 13-14 YEARS -49KG	
996	Male	SPAMPINATO	FABRIZIO	Kumite male cadets -57kg	
997	Male	SPAMPINATO	MARCO GAETANO	Kumite Male U21 -60kg	
998	Male	SPAMPINATO	MARCO GAETANO	Kumite male juniors -61kg	

Entries: 6

31ST KARATE GRAND PRIX CROATIA

CROATIA

2023.01.20 - 2023.01.22

CITY SPORTS HALL SAMOBOR, ANDRIJE HEBRANGA 26A, SAMOBOR, CROATIA

Tournament Participation (Entries) by Club

 ASD RENSHUKAN TORINO(RENSHUKAN)					
ID	Sex	Family Name	Given Name	Category	
999	Male	Ollagnero	Giovanni	KATA MALE JUNIORS	

Entries: 1

31ST KARATE GRAND PRIX CROATIA

CROATIA 2023.01.20 - 2023.01.22
CITY SPORTS HALL SAMOBOR, ANDRIJE HEBRANGA 26A, SAMOBOR, CROATIA

Tournament Participation (Entries) by Club

 ASD SHOTOKAN ACIREALE(ACIREALE)					
ID	Sex	Family Name	Given Name	Category	
1.000	Male	Caglià	Andrea	Kumite male juniors -68kg	
1.001	Male	Caglià	Andrea	Kumite Male U21 -75kg	
1.002	Male	Cristaldi	Seby	KUMITE BOYS 13-14 YEARS -44KG	
1.003	Female	FICHERA	CARLA	Kumite female Juniors -66kg	
1.004	Male	Patanè	Giuseppe	Kumite male juniors -76kg	
1.005	Male	Patanè	Giuseppe	Kumite male cadets -70kg	
1.006	Female	SAITTA	FEDERICA	Kumite Female U21 - 61kg	
1.007	Male	Torrisi	Giorgio Pietro	Kumite male cadets -52kg	
1.008	Male	Torrisi	Giorgio Pietro	KUMITE BOYS 13-14 YEARS -44KG	

Entries: 9

31ST KARATE GRAND PRIX CROATIA

CROATIA 2023.01.20 - 2023.01.22
CITY SPORTS HALL SAMOBOR, ANDRIJE HEBRANGA 26A, SAMOBOR, CROATIA

Tournament Participation (Entries) by Club

 ASD Shotokan Karate Pozzuolo del Friuli(SKZP)					
ID	Sex	Family Name	Given Name	Category	
1.009	Female	IPPOLITI	IRENE	kata female U21	
1.010	Female	IPPOLITI	IRENE	KATA FEMALE JUNIORS R2-G1	
1.011	Female	IPPOLITI	IRENE	KATA FEMALE JUNIORS	
1.012	Female	MESAGLIO	MARTINA	KATA FEMALE JUNIORS R2-G2	
1.013	Female	MESAGLIO	MARTINA	kata female U21	
1.014	Female	MESAGLIO	MARTINA	KATA FEMALE JUNIORS	
1.015	Male	PAVAN	SEBASTIANO	KATA BOYS 14 YEARS	

Entries: 7

31ST KARATE GRAND PRIX CROATIA

CROATIA 2023.01.20 - 2023.01.22
CITY SPORTS HALL SAMOBOR, ANDRIJE HEBRANGA 26A, SAMOBOR, CROATIA

Tournament Participation (Entries) by Club

 ASD TALARICO KARATE TEAM APS(TKT)					
ID	Sex	Family Name	Given Name	Category	
1.016	Male	CARRARESI	ALESSANDRO	Kumite male cadets -63kg	
1.017	Female	DUTTO	GIULIA	Kumite female Cadets -61kg	
1.018	Female	FABBRI	GIORGIA	Kumite Female U21 -50kg	
1.019	Female	GRANATIERO	SOFIA	Kumite female cadets -54kg	
1.020	Male	LORENZETTI	TOMMASO	Kumite Male U21 -67kg	
1.021	Female	SAMMARCO	REBECCA	Kumite female Cadets +61kg	

Entries: 6

31ST KARATE GRAND PRIX CROATIA

CROATIA 2023.01.20 - 2023.01.22
CITY SPORTS HALL SAMOBOR, ANDRIJE HEBRANGA 26A, SAMOBOR, CROATIA

Tournament Participation (Entries) by Club

 Asd_Dinamo_Karate_2015(Dinamo Karate 2015)					
ID	Sex	Family Name	Given Name	Category	
1.022	Male	Basile	Brayan	KUMITE BOYS 9-10 YEARS -27KG	
1.023	Male	Berton	Simone	KUMITE BOYS 11-12 YEARS -34KG	
1.024	Female	Bollani	Giulia	Kumite female Cadets +61kg	
1.025	Female	Bruschi	Elisa	KUMITE GIRLS 9-10 YEARS -35kg	
1.026	Female	Chakir	Fatima Azahra	KUMITE GIRLS 11-12 YEARS -34KG	
1.027	Male	Fioremisto	Mattia	KUMITE BOYS 13-14 YEARS -49KG	
1.028	Male	Msatfa	Adam Mourad	KUMITE BOYS 9-10 YEARS -27KG	
1.029	Female	Msatfa	Malak Fatima	KUMITE GIRLS 11-12 YEARS -39KG	
1.030	Female	Oancea	Raluca	KUMITE GIRLS 9-10 YEARS -31kg	
1.031	Male	Oancea	Vlad	Kumite male cadets +70kg	
1.032	Female	Parisi	Anyta	KUMITE GIRLS 9-10 YEARS -39kg	
1.033	Female	Pojoga	Elena	KUMITE GIRLS 9-10 YEARS -27kg	
1.034	Female	Tssouli	Sofia	KUMITE GIRLS 9-10 YEARS -27kg	

Entries: 13

31ST KARATE GRAND PRIX CROATIA

CROATIA

2023.01.20 - 2023.01.22

CITY SPORTS HALL SAMOBOR, ANDRIJE HEBRANGA 26A, SAMOBOR, CROATIA

Tournament Participation (Entries) by Club

 BERRETTONI FEDERICO(ROMA 12)					
ID	Sex	Family Name	Given Name	Category	
1.035	Female	DOMINIJANNI	ELISA	KATA FEMALE JUNIORS	
1.036	Female	DOMINIJANNI	ELISA	KATA FEMALE JUNIORS R4 Bronze Medal Match 1	
1.037	Female	DOMINIJANNI	ELISA	KATA FEMALE JUNIORS R3-G2	
1.038	Female	DOMINIJANNI	ELISA	KATA FEMALE JUNIORS R2-G2	
1.039	Male	GIUSTINIANO	ALESSIO	KATA male cadets	

Entries: 5

31ST KARATE GRAND PRIX CROATIA

CROATIA

2023.01.20 - 2023.01.22

CITY SPORTS HALL SAMOBOR, ANDRIJE HEBRANGA 26A, SAMOBOR, CROATIA

Tournament Participation (Entries) by Club

 Bodymind Karate(Bodymind Karate)					
ID	Sex	Family Name	Given Name	Category	
1.040	Female	GUISCARDI	SHARON	Kumite Female U21 - 68kg	
1.041	Male	Paoletti	Mattia	Kumite male juniors -68kg	
1.042	Male	Paolini	Yari	Kumite male juniors -76kg	
1.043	Male	ungaretti	gabriele	Kumite male juniors -68kg	

Entries: 4

31ST KARATE GRAND PRIX CROATIA

CROATIA

2023.01.20 - 2023.01.22

CITY SPORTS HALL SAMOBOR, ANDRIJE HEBRANGA 26A, SAMOBOR, CROATIA

Tournament Participation (Entries) by Club

 Bushido Karate Perugia(BKP)					
ID	Sex	Family Name	Given Name	Category	
1.044	Male	Fuscagni	Alex	KATA MALE JUNIORS R2-G2	
1.045	Male	Fuscagni	Alex	KATA MALE JUNIORS R4 Bronze Medal Match 1	
1.046	Male	Fuscagni	Alex	Kata male seniors	
1.047	Male	Fuscagni	Alex	KATA MALE JUNIORS	
1.048	Male	Fuscagni	Alex	KATA MALE JUNIORS R3-G2	
1.049	Male	Giovagnoni	Gioele	KATA MALE JUNIORS	
1.050	Male	Giovagnoni	Gioele	KATA MALE JUNIORS R2-G1	
1.051	Male	Giovagnoni	Gioele	Kata male seniors	
1.052	Male	Giovagnoni	Gioele	Kata male seniors R2-G2	

Entries: **9**

31ST KARATE GRAND PRIX CROATIA

CROATIA

2023.01.20 - 2023.01.22

CITY SPORTS HALL SAMOBOR, ANDRIJE HEBRANGA 26A, SAMOBOR, CROATIA

Tournament Participation (Entries) by Club

 CENTRO KARATE RIMINI(CKR)					
ID	Sex	Family Name	Given Name	Category	
1.053	Male	Dan	Christian	Kumite male cadets -52kg	

Entries: 1

31ST KARATE GRAND PRIX CROATIA

CROATIA 2023.01.20 - 2023.01.22
CITY SPORTS HALL SAMOBOR, ANDRIJE HEBRANGA 26A, SAMOBOR, CROATIA

Tournament Participation (Entries) by Club

 CLUB ARTI ORIENTALI CANTU asd(CAO CANTU)					
ID	Sex	Family Name	Given Name	Category	
1.054	Male	Angei Ferrario	Luca	KUMITE BOYS 13-14 YEARS -44KG	
1.055	Male	Barzagli	Jacopo	KUMITE BOYS 11-12 YEARS -49KG	
1.056	Female	BELTRAMI	GINEVRA	KUMITE GIRLS 11-12 YEARS -34KG	
1.057	Male	beltrami	massimo	KUMITE BOYS 13-14 YEARS -44KG	
1.058	Male	BERGNA	LORENZO	KUMITE BOYS 11-12 YEARS -39KG	
1.059	Male	BERGNA	LORENZO	KUMITE BOYS 13-14 YEARS -44KG	
1.060	Male	BERLUSCONI	DAVIDE	KUMITE BOYS 13-14 YEARS +69KG	
1.061	Male	Biggiogero	Matteo	KUMITE BOYS 11-12 YEARS -34KG	
1.062	Male	CAFISO	EDOARDO	KUMITE BOYS 13-14 YEARS -44KG	
1.063	Male	CAFISO	EDOARDO	KUMITE BOYS 11-12 YEARS -34KG	
1.064	Female	CATTANEO	ELISA	Kumite female Cadets -61kg	
1.065	Male	Comendulli	Leonardo	KUMITE BOYS 13-14 YEARS -44KG	
1.066	Male	Comendulli	Leonardo	KUMITE BOYS 11-12 YEARS -39KG	
1.067	Female	Gandola	Greta	Kumite female cadets -54kg	
1.068	Female	GANDOLA	VIOLA	Kumite female Cadets -61kg	
1.069	Male	GIULIANO	SIMONE	KUMITE BOYS 13-14 YEARS -69KG	
1.070	Male	GIULIANO	SIMONE	Kumite male cadets -70kg	
1.071	Male	MESITI	EDOARDO	Kumite male cadets -52kg	
1.072	Female	ostinelli	alice	KUMITE GIRLS 11-12 YEARS -34KG	
1.073	Male	PRESTIANNI	ALESSIO	KUMITE BOYS 11-12 YEARS -39KG	
1.074	Male	SESTO	ANDREA	Kumite male cadets -70kg	
1.075	Male	SOMASCHINI	FILIPPO	KUMITE BOYS 13-14 YEARS -44KG	
1.076	Male	SOMASCHINI	FILIPPO	KUMITE BOYS 11-12 YEARS -34KG	
1.077	Female	VERONESE	MATILDA	KUMITE GIRLS 11-12 YEARS -34KG	
1.078	Male	ZEMOLIN	MARCELLO	KUMITE BOYS 11-12 YEARS -49KG	

Entries: 25

31ST KARATE GRAND PRIX CROATIA

CROATIA 2023.01.20 - 2023.01.22
CITY SPORTS HALL SAMOBOR, ANDRIJE HEBRANGA 26A, SAMOBOR, CROATIA

Tournament Participation (Entries) by Club

 CRS AKIYAMA Settimo(CRS AKIYAMA Settimo)					
ID	Sex	Family Name	Given Name	Category	
1.079	Male	Comino	Lorenzo	Kumite male cadets -63kg	
1.080	Male	Lio	Matteo	Kumite male cadets -63kg	

Entries: 2

31ST KARATE GRAND PRIX CROATIA

CROATIA

2023.01.20 - 2023.01.22

CITY SPORTS HALL SAMOBOR, ANDRIJE HEBRANGA 26A, SAMOBOR, CROATIA

Tournament Participation (Entries) by Club

 Evolution Team Karate(ETK)					
ID	Sex	Family Name	Given Name	Category	
1.081	Male	CEPPARO	JACOPO	Kumite male cadets +70kg	
1.082	Male	NONIS	MATTEO	Kumite male cadets +70kg	

Entries: 2

31ST KARATE GRAND PRIX CROATIA

CROATIA 2023.01.20 - 2023.01.22
CITY SPORTS HALL SAMOBOR, ANDRIJE HEBRANGA 26A, SAMOBOR, CROATIA

Tournament Participation (Entries) by Club

 FORZA E COSTANZA - BRESCIA(F & C)					
ID	Sex	Family Name	Given Name	Category	
1.083	Male	Bontempi	Giacomo	Kumite Male U21 -84kg	
1.084	Male	GIULIANI	Mirco	Kumite Male U21 -84kg	
1.085	Male	GIULIANI	Mirco	KUMITE MALE SENIORS	
1.086	Female	Guerini	Anna	Kumite Female U21 -50kg	
1.087	Female	Simonini	Valentina	Kumite Female U21 - 68kg	
1.088	Female	Simonini	Valentina	Kumite female Juniors -66kg	
1.089	Female	Vitali	Veronica	Kumite Female U21 -50kg	
1.090	Female	Vitali	Veronica	Kumite female juniors -48kg	

Entries: 8

31ST KARATE GRAND PRIX CROATIA

CROATIA 2023.01.20 - 2023.01.22
CITY SPORTS HALL SAMOBOR, ANDRIJE HEBRANGA 26A, SAMOBOR, CROATIA

Tournament Participation (Entries) by Club

 G.S.FF.OO. POLIZIA DI STATO(FF.OO. POLIZIA DI STATO)					
ID	Sex	Family Name	Given Name	Category	
1.091	Female	CRESCENZI	ELISA	Kata female seniors	
1.092	Female	CRESCENZI	ELISA	kata female U21 R2-G1	
1.093	Female	CRESCENZI	ELISA	kata female U21	
1.094	Female	CRESCENZI	ELISA	kata female U21 R3 Bronze Medal Match 1	
1.095	Female	POIANI	VICTORIA	Kumite female juniors -59kg	
1.096	Male	Polsinelli	Guido	kata male U21 R2-G1	
1.097	Male	Polsinelli	Guido	Kata male seniors R3-G2	
1.098	Male	Polsinelli	Guido	Kata male seniors R4 Bronze Medal Match 1	
1.099	Male	Polsinelli	Guido	Kata male seniors	
1.100	Male	Polsinelli	Guido	Kata male seniors R2-G2	
1.101	Male	Polsinelli	Guido	kata male U21	
1.102	Male	Polsinelli	Guido	kata male U21 R4 Gold Medal Match	
1.103	Male	Polsinelli	Guido	kata male U21 R3-G1	
1.104	Female	SCLERANDI	NOEMI	Kumite female juniors -53kg	

Entries: **14**

31ST KARATE GRAND PRIX CROATIA

CROATIA 2023.01.20 - 2023.01.22
CITY SPORTS HALL SAMOBOR, ANDRIJE HEBRANGA 26A, SAMOBOR, CROATIA

Tournament Participation (Entries) by Club

 Italian National Team(Italy)					
ID	Sex	Family Name	Given Name	Category	
1.105	Male	AGUS	MARIO	Kumite Male U21 -60kg	
1.106	Male	Astarita	Raffaele	Kumite male juniors -61kg	
1.107	Male	Bisaccia	Andrea	Kumite Male U21 -60kg	
1.108	Male	Burrosi	Samuele	Kumite male cadets +70kg	
1.109	Male	Califano	Emanuele	Kumite male cadets -57kg	
1.110	Male	Califano	Pietro Pio	Kumite male juniors -68kg	
1.111	Female	Cherouaqui	Basma	Kumite female Cadets -61kg	
1.112	Female	Colletti	Emma	Kumite female juniors -48kg	
1.113	Female	De Falco	Asia	Kumite female cadets -47kg	
1.114	Female	Desiderio	Annapia	Kumite female Juniors -66kg	
1.115	Male	Di Rubba	Luigi	KATA male cadets	
1.116	Male	Di Rubba	Luigi	KATA male cadets R2-G2	
1.117	Female	Dominici	Roberta	KATA female cadets R2-G1	
1.118	Female	Dominici	Roberta	KATA female cadets	
1.119	Female	Dominici	Roberta	KATA female cadets R4 Gold Medal Match	
1.120	Female	Dominici	Roberta	KATA female cadets R3-G1	
1.121	Male	Dovera	Gabriele	Kumite male juniors +76kg	
1.122	Female	FRACASSI	VERONICA	Kumite Female U21 + 68kg	
1.123	Male	Giordano	Fabrizio	Kumite male juniors -61kg	
1.124	Female	Gruppioni	Asia	KATA FEMALE JUNIORS R2-G2	
1.125	Female	Gruppioni	Asia	KATA FEMALE JUNIORS	
1.126	Female	Gruppioni	Asia	KATA FEMALE JUNIORS R4 Gold Medal Match	
1.127	Female	Gruppioni	Asia	KATA FEMALE JUNIORS R3-G2	
1.128	Female	Legittimo	Ludovica	Kumite female cadets -47kg	
1.129	Female	LEIDI	MARTINA	Kumite Female U21 + 68kg	
1.130	Female	Luciani	Syria	Kumite female cadets -54kg	
1.131	Male	MARINO	FERNANDO	Kumite male juniors +76kg	
1.132	Female	Marrucci	Valentina	Kumite female cadets -54kg	
1.133	Female	Marturano	Irene	Kumite female juniors -59kg	
1.134	Female	Montebello	Carlotta	Kumite female Cadets +61kg	
1.135	Female	Ortu	Rebecca	Kumite female juniors -53kg	
1.136	Male	Panico	Valentino	Kumite male cadets -63kg	
1.137	Male	Pappalardo	Vincenzo	KATA MALE JUNIORS R3-G1	
1.138	Male	Pappalardo	Vincenzo	KATA MALE JUNIORS R2-G1	
1.139	Male	Pappalardo	Vincenzo	KATA MALE JUNIORS R4 Gold Medal Match	
1.140	Male	Pappalardo	Vincenzo	KATA MALE JUNIORS	
1.141	Female	Pazzaglia	Anita	Kumite Female U21 -55kg	
1.142	Female	Pergolesi	Asia	Kumite female Juniors +66kg	
1.143	Male	Pezzotti	Gabriele	Kumite male juniors -76kg	
1.144	Male	Ramos	Matt	Kumite Male U21 -67kg	
1.145	Female	Roversi	Elena	kata female U21 R2-G1	
1.146	Female	Roversi	Elena	kata female U21	
1.147	Female	Roversi	Elena	kata female U21 R3 Gold Medal Match	
1.148	Male	Salvati	Adriano	Kumite male juniors +76kg	
1.149	Male	Serino	Salvatore	Kumite male cadets -52kg	
1.150	Male	Squillante	Giudo	Kumite male juniors -55kg	
1.151	Male	Toniolo	Alvise	Kumite male cadets -70kg	

31ST KARATE GRAND PRIX CROATIA

CROATIA

2023.01.20 - 2023.01.22

CITY SPORTS HALL SAMOBOR, ANDRIJE HEBRANGA 26A, SAMOBOR, CROATIA

Tournament Participation (Entries) by Club

Entries: **47**

31ST KARATE GRAND PRIX CROATIA

CROATIA

2023.01.20 - 2023.01.22

CITY SPORTS HALL SAMOBOR, ANDRIJE HEBRANGA 26A, SAMOBOR, CROATIA

Tournament Participation (Entries) by Club

 Karate Alto Vicentino (K. A. V.)					
ID	Sex	Family Name	Given Name	Category	
1.152	Female	Roncaglia	Giulia	Kumite female Cadets +61kg	
1.153	Female	Roncaglia	Giulia	Kumite female Juniors +66kg	
1.154	Female	Roncaglia	Maria	KUMITE GIRLS 13-14 YEARS -64KG	
1.155	Male	Zaccaria	Andrea	Kumite Male U21 -67kg	

Entries: 4

31ST KARATE GRAND PRIX CROATIA

CROATIA 2023.01.20 - 2023.01.22
CITY SPORTS HALL SAMOBOR, ANDRIJE HEBRANGA 26A, SAMOBOR, CROATIA

Tournament Participation (Entries) by Club

 KARATE CLUB SAVONA (KCS - LIGURIA KARATE)					
ID	Sex	Family Name	Given Name	Category	
1.156	SD455207	Female	GENTA	MICOL	Kumite female juniors -48kg
1.157		Female	Giordani	Paola	Kumite female Juniors -66kg

Entries: 2

31ST KARATE GRAND PRIX CROATIA

CROATIA 2023.01.20 - 2023.01.22
CITY SPORTS HALL SAMOBOR, ANDRIJE HEBRANGA 26A, SAMOBOR, CROATIA

Tournament Participation (Entries) by Club

 KARATE DO TRIESTE(KARATE DO TRIESTE)					
ID	Sex	Family Name	Given Name	Category	
1.158	Female	GIOMBI	SOFIA	KATA female cadets	
1.159	Female	GIOMBI	SOFIA	KATA female cadets R2-G2	
1.160	Female	ZORI	ANNA	KATA FEMALE JUNIORS	

Entries: 3

31ST KARATE GRAND PRIX CROATIA

CROATIA 2023.01.20 - 2023.01.22
CITY SPORTS HALL SAMOBOR, ANDRIJE HEBRANGA 26A, SAMOBOR, CROATIA

Tournament Participation (Entries) by Club

 Karate Nakayama(Karate Nakayama)					
ID	Sex	Family Name	Given Name	Category	
1.161	Female	Cornolò	Giada	Kumite female Juniors -66kg	
1.162	Female	Delbono	Nicole	Kumite Female U21 - 61kg	
1.163	Male	PIEMONTE	GABRIEL	Kumite male juniors -55kg	

Entries: 3

31ST KARATE GRAND PRIX CROATIA

CROATIA 2023.01.20 - 2023.01.22
CITY SPORTS HALL SAMOBOR, ANDRIJE HEBRANGA 26A, SAMOBOR, CROATIA

Tournament Participation (Entries) by Club

 Karate Team Dolomiti(KTDolomiti)					
ID	Sex	Family Name	Given Name	Category	
1.164	Female	Masoch	Mariachiara	Kumite female juniors -48kg	
1.165	Female	Pasotto	Maya	Kumite female Juniors -66kg	
1.166	Female	Sirbu	Ioana	Kumite female Juniors -66kg	

Entries: 3

31ST KARATE GRAND PRIX CROATIA

CROATIA

2023.01.20 - 2023.01.22

CITY SPORTS HALL SAMOBOR, ANDRIJE HEBRANGA 26A, SAMOBOR, CROATIA

Tournament Participation (Entries) by Club

 karate trento asd(ktn)					
ID	Sex	Family Name	Given Name	Category	
1.167	Female	CAPITANIO	MATILDE	Kumite female juniors -59kg	

Entries: 1

31ST KARATE GRAND PRIX CROATIA

CROATIA

2023.01.20 - 2023.01.22

CITY SPORTS HALL SAMOBOR, ANDRIJE HEBRANGA 26A, SAMOBOR, CROATIA

Tournament Participation (Entries) by Club

MASTER RAPID SKF CBL(MASTER RAPID SKF CBL)					
ID	Sex	Family Name	Given Name	Category	
1.168	Male	ANDRADE SILVESTRI	AIRTON	Kumite male cadets -57kg	
1.169	Male	Barletta	Leonardo	Kata male seniors	
1.170	Male	Barletta	Leonardo	kata male U21	
1.171	Male	Barletta	Leonardo	KATA MALE JUNIORS	
1.172	Male	Barletta	Leonardo	KATA MALE JUNIORS R2-G2	
1.173	Male	BOMBARDI	LEONARDO	KATA MALE JUNIORS R2-G1	
1.174	Male	BOMBARDI	LEONARDO	Kata male seniors	
1.175	Male	BOMBARDI	LEONARDO	kata male U21	
1.176	Male	BOMBARDI	LEONARDO	KATA MALE JUNIORS	
1.177	Male	BOMBARDI	LEONARDO	kata male U21 R2-G2	
1.178	Female	BORGHESI	MATILDA	Kumite female Cadets -61kg	
1.179	Female	BRAMBILLA	CHIARA	KATA FEMALE JUNIORS	
1.180	Female	BRAMBILLA	CHIARA	kata female U21	
1.181	Male	Calabrese	Filippo	KATA male cadets R3-G1	
1.182	Male	Calabrese	Filippo	KATA male cadets R2-G1	
1.183	Male	Calabrese	Filippo	KATA MALE JUNIORS	
1.184	Male	Calabrese	Filippo	KATA MALE JUNIORS R2-G2	
1.185	Male	Calabrese	Filippo	KATA male cadets	
1.186	Male	Calabrese	Filippo	KATA male cadets R4 Bronze Medal Match 1	
1.187	Male	EDERAR	KARIM	KATA MALE JUNIORS	
1.188	Male	EDERAR	KARIM	KATA MALE JUNIORS R3-G2	
1.189	Male	EDERAR	KARIM	KATA MALE JUNIORS R2-G2	
1.190	Male	EDERAR	KARIM	Kata male seniors R2-G1	
1.191	Male	EDERAR	KARIM	Kata male seniors	
1.192	Male	EDERAR	KARIM	kata male U21	
1.193	Female	FRIGENI	MICHELA	KATA GIRLS 13 YEARS	
1.194	Female	FRIGENI	MICHELA	KATA female cadets	
1.195	Female	FRIGENI	MICHELA	KATA GIRLS 14 YEARS	
1.196	Female	MAESTRI	ERIKA	KATA FEMALE JUNIORS	
1.197	Female	MAESTRI	ERIKA	kata female U21	
1.198	Male	Moretti	Oscar	KATA MALE JUNIORS	
1.199	Male	Moretti	Oscar	KATA MALE JUNIORS R2-G2	
1.200	Male	Moretti	Oscar	KATA male cadets	
1.201	Male	Moretti	Oscar	KATA male cadets R2-G2	
1.202	Female	NORIS	GIADA	KATA FEMALE JUNIORS	
1.203	Female	NORIS	GIADA	Kata female seniors R2-G2	
1.204	Female	NORIS	GIADA	KATA FEMALE JUNIORS R2-G2	
1.205	Female	NORIS	GIADA	kata female U21	
1.206	Female	NORIS	GIADA	kata female U21 R3 Bronze Medal Match 1	
1.207	Female	NORIS	GIADA	Kata female seniors R3 Gold Medal Match	
1.208	Female	NORIS	GIADA	kata female U21 R2-G2	
1.209	Female	NORIS	GIADA	Kata female seniors	
1.210	Female	PARIMBELLI	CAROLINA	KATA FEMALE JUNIORS	
1.211	Female	PARIMBELLI	CAROLINA	KATA female cadets	
1.212	Male	PEDRUZZI	OMAR	Kata male seniors	
1.213	Male	PEDRUZZI	OMAR	Kata male seniors R2-G2	
1.214	Male	PEDRUZZI	THOMAS	Kata male seniors	

31ST KARATE GRAND PRIX CROATIA

CROATIA 2023.01.20 - 2023.01.22
CITY SPORTS HALL SAMOBOR, ANDRIJE HEBRANGA 26A, SAMOBOR, CROATIA

Tournament Participation (Entries) by Club

1.215	Male	PEDRUZZI	THOMAS	Kata male seniors R2-G2
1.216	Male	PEDRUZZI	THOMAS	kata male U21
1.217	Male	PEDRUZZI	THOMAS	kata male U21 R2-G2
1.218	Female	Perina	Camilla	Kumite female juniors -48kg
1.219	Female	PREVITALI	AMBRA	Kumite female cadets -54kg
1.220	Female	Rifugio	Lavinia	Kumite female Cadets +61kg
1.221	Female	Sigismondi	Noemi	KATA GIRLS 12 YEARS
1.222	Female	Sigismondi	Noemi	KATA GIRLS 13 YEARS
1.223	Female	Valenti	Jennifer	KATA GIRLS 14 YEARS
1.224	Female	VERDONE	MELISSA	kata female U21
1.225	Female	VERDONE	MELISSA	KATA FEMALE JUNIORS R2-G1
1.226	Female	VERDONE	MELISSA	KATA FEMALE JUNIORS
1.227	Female	VIELMI	ELISA	KATA FEMALE JUNIORS
1.228	Female	VIELMI	ELISA	kata female U21 R2-G1
1.229	Female	VIELMI	ELISA	kata female U21

Entries: **62**

31ST KARATE GRAND PRIX CROATIA

CROATIA 2023.01.20 - 2023.01.22
CITY SPORTS HALL SAMOBOR, ANDRIJE HEBRANGA 26A, SAMOBOR, CROATIA

Tournament Participation (Entries) by Club

 PRO-TEAM ASD(PRO-TEAM ASD)					
ID	Sex	Family Name	Given Name	Category	
1.230	Female	CAMPOBASSO	AURORA	Kumite female juniors -59kg	
1.231	Male	CELLAMARE	FEDERICO	KUMITE BOYS 13-14 YEARS -44KG	
1.232	Male	DANDRIA	COSIMO	KUMITE BOYS 13-14 YEARS -59KG	
1.233	Female	DI BARI	GEMMA	Kumite female Juniors +66kg	
1.234	Female	DI BARI	GEMMA	Kumite Female U21 + 68kg	
1.235	Female	FEROLA	GIORGIA	KUMITE GIRLS 13-14 YEARS +64KG	
1.236	Female	FEROLA	GIORGIA	Kumite female Cadets +61kg	
1.237	Female	LA GIOIA	ANGELICA	KUMITE GIRLS 13-14 YEARS -54KG	
1.238	Female	LA GIOIA	ANGELICA	Kumite female cadets -54kg	
1.239	Female	MOCCIA	MIRIAM	Kumite female Cadets -61kg	
1.240	Female	MOCCIA	MIRIAM	KUMITE GIRLS 13-14 YEARS -59KG	
1.241	Female	STELLA	FEDERICA	KUMITE GIRLS 13-14 YEARS -44KG	
1.242	Female	STELLA	FEDERICA	KUMITE GIRLS 11-12 YEARS -44KG	

Entries: **13**

31ST KARATE GRAND PRIX CROATIA

CROATIA 2023.01.20 - 2023.01.22
CITY SPORTS HALL SAMOBOR, ANDRIJE HEBRANGA 26A, SAMOBOR, CROATIA

Tournament Participation (Entries) by Club

 RARI NANTES ALBANO(RARI NANTES B.)					
ID	Sex	Family Name	Given Name	Category	
1.243	Female	Bordi	Elisa	Kumite female cadets -47kg	
1.244	Female	Bordi	Elisa	Kumite female juniors -48kg	
1.245	Male	Origlia	Alessandro	Kumite Male U21 -67kg	

Entries: 3

31ST KARATE GRAND PRIX CROATIA

CROATIA

2023.01.20 - 2023.01.22

CITY SPORTS HALL SAMOBOR, ANDRIJE HEBRANGA 26A, SAMOBOR, CROATIA

Tournament Participation (Entries) by Club

 RENZI(RENZI)					
ID	Sex	Family Name	Given Name	Category	
1.246	Female	SANTINI	VALENTINA	Kumite Female U21 -50kg	

Entries: 1

31ST KARATE GRAND PRIX CROATIA

CROATIA 2023.01.20 - 2023.01.22
CITY SPORTS HALL SAMOBOR, ANDRIJE HEBRANGA 26A, SAMOBOR, CROATIA

Tournament Participation (Entries) by Club

 SHIRAI CLUB S. VALENTINO(SHIRAI CLUB S. VALENTINO)					
ID	Sex	Family Name	Given Name	Category	
1.247	Male	SABATINO	CHRISTIAN	Kumite Male U21 -60kg	

Entries: 1

31ST KARATE GRAND PRIX CROATIA

CROATIA

2023.01.20 - 2023.01.22

CITY SPORTS HALL SAMOBOR, ANDRIJE HEBRANGA 26A, SAMOBOR, CROATIA

Tournament Participation (Entries) by Club

 skorpion karate asd(skorpion karate asd)					
ID	Sex	Family Name	Given Name	Category	
1.248	Female	Bossi	Alessandra	Kumite female juniors -48kg	
1.249	Female	Bossi	Alessandra	Kumite female cadets -47kg	

Entries: 2

31ST KARATE GRAND PRIX CROATIA

CROATIA 2023.01.20 - 2023.01.22
CITY SPORTS HALL SAMOBOR, ANDRIJE HEBRANGA 26A, SAMOBOR, CROATIA

Tournament Participation (Entries) by Club

 Spazio Sport Forte dei Marmi(Spazio Sport)					
ID	Sex	Family Name	Given Name	Category	
1.250	ITA462	Female	LORENZONI	ELENA	Kata female seniors
1.251		Male	MASSAGLIA	MARCO	kata male U21
1.252		Male	MASSAGLIA	MARCO	KATA MALE JUNIORS
1.253		Female	MATTUGINI	ESTER	KATA FEMALE JUNIORS
1.254		Female	MATTUGINI	ESTER	KATA female cadets
1.255		Female	MATTUGINI	ESTER	KATA female cadets R2-G2
1.256		Male	PANFILE	DAVID	KATA male cadets
1.257		Female	STAGI	NICOLE	KATA female cadets R2-G1
1.258		Female	STAGI	NICOLE	KATA female cadets

Entries: **9**

31ST KARATE GRAND PRIX CROATIA

CROATIA

2023.01.20 - 2023.01.22

CITY SPORTS HALL SAMOBOR, ANDRIJE HEBRANGA 26A, SAMOBOR, CROATIA

Tournament Participation (Entries) by Club

sport center messina(sc messina)					
ID	Sex	Family Name	Given Name	Category	
1.259	Male	CAPRITTI	ENEA	Kumite male cadets -70kg	

Entries: 1

31ST KARATE GRAND PRIX CROATIA

CROATIA 2023.01.20 - 2023.01.22
CITY SPORTS HALL SAMOBOR, ANDRIJE HEBRANGA 26A, SAMOBOR, CROATIA

Tournament Participation (Entries) by Club

 SPORT TARGET (SPORT TARGET)					
ID	Sex	Family Name	Given Name	Category	
1.260	Female	Aloisi	Gisella	Kumite female cadets -47kg	
1.261	Male	Binotto	Pietro	kata male U21 R4 Bronze Medal Match 2	
1.262	Male	Binotto	Pietro	kata male U21	
1.263	Male	Binotto	Pietro	kata male U21 R3-G1	
1.264	Male	Binotto	Pietro	kata male U21 R2-G1	
1.265	Female	Ecchili	Graziella	Kumite female Cadets -61kg	
1.266	Female	Marchetti	Giulia	kata female U21	
1.267	Female	Marchetti	Giulia	Kata female seniors R2-G1	
1.268	Female	Marchetti	Giulia	Kata female seniors	
1.269	Female	Marchetti	Giulia	Kata female seniors R3 Bronze Medal Match 2	
1.270	Female	PERUZZI	GIADA	Kata female seniors R2-G2	
1.271	Female	PERUZZI	GIADA	kata female U21	
1.272	Female	PERUZZI	GIADA	Kata female seniors R3 Bronze Medal Match 1	
1.273	Female	PERUZZI	GIADA	Kata female seniors	
1.274	Female	STANGHERLIN	SOFIA	kata female U21	
1.275	Female	STANGHERLIN	SOFIA	KATA FEMALE JUNIORS R2-G1	
1.276	Female	STANGHERLIN	SOFIA	KATA FEMALE JUNIORS	

Entries: **17**

31ST KARATE GRAND PRIX CROATIA

CROATIA 2023.01.20 - 2023.01.22
CITY SPORTS HALL SAMOBOR, ANDRIJE HEBRANGA 26A, SAMOBOR, CROATIA

Tournament Participation (Entries) by Club

 ssd bracelli club(ssd bracelli club)					
ID	Sex	Family Name	Given Name	Category	
1.277	Male	DI MARCO	ALESSANDRO	Kumite Male U21 -67kg	
1.278	Male	SUPINO	FEDERICO	Kumite male juniors +76kg	

Entries: 2

31ST KARATE GRAND PRIX CROATIA

CROATIA

2023.01.20 - 2023.01.22

CITY SPORTS HALL SAMOBOR, ANDRIJE HEBRANGA 26A, SAMOBOR, CROATIA

Tournament Participation (Entries) by Club

 SSD Polisportiva Ternana(karateterni)					
ID	Sex	Family Name	Given Name	Category	
1.279	Male	Piccioni	Edoardo	Kata male seniors	
1.280	Male	Piccioni	Edoardo	Kata male seniors R2-G2	
1.281	Male	Piccioni	Edoardo	kata male U21	
1.282	Male	Piccioni	Edoardo	kata male U21 R3-G2	
1.283	Male	Piccioni	Edoardo	kata male U21 R2-G2	
1.284	Male	Piccioni	Edoardo	kata male U21 R4 Bronze Medal Match 1	

Entries: 6

31ST KARATE GRAND PRIX CROATIA

CROATIA 2023.01.20 - 2023.01.22
CITY SPORTS HALL SAMOBOR, ANDRIJE HEBRANGA 26A, SAMOBOR, CROATIA

Tournament Participation (Entries) by Club

 SSD Polisportiva Terraglio(Polisportiva Terraglio)					
ID	Sex	Family Name	Given Name	Category	
1.285	Female	Agostini	Matilde	Kumite female Cadets -61kg	
1.286	Female	Agostini	Matilde	KUMITE GIRLS 13-14 YEARS -59KG	
1.287	Male	Andriolo	Federico	Kumite male juniors -76kg	
1.288	Female	Ballarin	Ginevra	KUMITE GIRLS 11-12 YEARS +54KG	
1.289	Female	Bertoldo	Monica	Kumite female cadets -54kg	
1.290	Female	Bertoldo	Monica	KUMITE GIRLS 13-14 YEARS -49KG	
1.291	Female	Birello	Giovanna	KUMITE GIRLS 13-14 YEARS -59KG	
1.292	Male	Giuge	Manuel	K30 - MALE SENIORS WHEELCHAIR USERS	
1.293	Female	Lorenza	Mel	Kata female seniors	
1.294	Male	mangano	lorenzo	Kumite male juniors -61kg	
1.295	Male	Marinelli	Rocco	Kumite male cadets -52kg	
1.296	Male	Marinelli	Rocco	KUMITE BOYS 13-14 YEARS -49KG	
1.297	Male	Monego	Edoardo	Kumite male juniors +76kg	
1.298	Male	nalesso	luca	Kumite male juniors -61kg	
1.299	Female	Tasca	Eleonora	KUMITE GIRLS 13-14 YEARS -44KG	
1.300	Female	Tomas	Annamaria	Kumite female Cadets +61kg	
1.301	Male	toso	alessandro	Kumite male juniors +76kg	
1.302	Male	Trevisan	Mattia	KUMITE BOYS 11-12 YEARS -39KG	
1.303	Female	Volpato	Nicol	KUMITE GIRLS 13-14 YEARS +64KG	
1.304	Female	Yakymashko	Federica	K21 - FEMALE SENIORS INTELLECTUALY IMPAIRED	

Entries: **20**

31ST KARATE GRAND PRIX CROATIA

CROATIA

2023.01.20 - 2023.01.22

CITY SPORTS HALL SAMOBOR, ANDRIJE HEBRANGA 26A, SAMOBOR, CROATIA

Tournament Participation (Entries) by Club

 Team Karate Puleo Firenze(TKP)					
ID	Sex	Family Name	Given Name	Category	
1.305	Male	Rufini	Samuele	Kumite male juniors -61kg	
1.306	Male	Toma	Geson	Kumite male cadets +70kg	
1.307	Male	Toma	Gioele	Kumite male juniors +76kg	

Entries: 3

31ST KARATE GRAND PRIX CROATIA

CROATIA

2023.01.20 - 2023.01.22

CITY SPORTS HALL SAMOBOR, ANDRIJE HEBRANGA 26A, SAMOBOR, CROATIA

Tournament Participation (Entries) by Club

 TSKS BELLUNO(TSKS)					
ID	Sex	Family Name	Given Name	Category	
1.308	Male	Da Rin	Loris	Kumite male juniors -68kg	
1.309	Male	De Lazzer	Leonardo	Kumite male cadets -63kg	
1.310	Male	Osti	Fabrizio	Kumite male juniors -68kg	
1.311	Male	Pontil Scala	Lorenzo	KUMITE BOYS 11-12 YEARS -34KG	
1.312	Male	Zoungoula	Aaron	Kumite male juniors -68kg	

Entries: 5

31ST KARATE GRAND PRIX CROATIA

CROATIA 2023.01.20 - 2023.01.22
CITY SPORTS HALL SAMOBOR, ANDRIJE HEBRANGA 26A, SAMOBOR, CROATIA

Tournament Participation (Entries) by Club

 UNIVERSAL CENTER(UC)					
ID	Sex	Family Name	Given Name	Category	
1.313	Female	Ariosto	Myriam	Kumite female juniors -53kg	
1.314	Male	Campanile	Giuseppe	Kumite male juniors +76kg	
1.315	Male	Capuozzo	Salvatore	Kumite male juniors -55kg	
1.316	Male	De Francesco	Luigi	Kumite Male U21 -67kg	
1.317	Female	Di Domenico	Chiara	Kumite female juniors -53kg	
1.318	Male	Gazzillo	Gianluca	Kumite Male U21 -67kg	
1.319	Male	Guglielmi	Pasquale	Kumite male juniors -55kg	
1.320	Female	Manzo	Chiara	Kumite female juniors -53kg	
1.321	Male	Mauro	Elia	Kumite Male U21 -60kg	
1.322	Male	Mazzola	Alessandro	Kumite male cadets +70kg	
1.323	Male	Mazzola	Gennaro	Kumite male cadets +70kg	
1.324	Female	Scala	Martina	Kumite Female U21 - 68kg	

Entries: 12

31ST KARATE GRAND PRIX CROATIA

CROATIA 2023.01.20 - 2023.01.22
CITY SPORTS HALL SAMOBOR, ANDRIJE HEBRANGA 26A, SAMOBOR, CROATIA

Tournament Participation (Entries) by Club

 World wellness karate Sorso(Wwkrt Sorso)					
ID	Sex	Family Name	Given Name	Category	
1.325	Female	Correddu	Nicole	KUMITE GIRLS 13-14 YEARS -64KG	
1.326	Female	Correddu	Nicole	Kumite female Cadets +61kg	
1.327	Male	Franca	Andrea	Kumite Male U21 -60kg	

Entries: 3

31ST KARATE GRAND PRIX CROATIA

CROATIA 2023.01.20 - 2023.01.22
CITY SPORTS HALL SAMOBOR, ANDRIJE HEBRANGA 26A, SAMOBOR, CROATIA

Tournament Participation (Entries) by Club



🇲🇩 MOLDOVA, REPUBLIC OF					
🇲🇩 BARS BALTI WKF(BARS BALTI)					
ID	Sex	Family Name	Given Name	Category	
1.328	MDA02267	Male	Capmoale	Alexandr	Kumite male juniors -55kg
1.329		Male	Carabulea	Egor	KUMITE BOYS 9-10 YEARS -39kg
1.330		Male	Carabulea	Egor	KUMITE BOYS 11-12 YEARS -39KG
1.331		Male	Stavarachi	Renat	KUMITE BOYS 13-14 YEARS -44KG
1.332		Male	Stavarachi	Renat	KUMITE BOYS 11-12 YEARS -34KG
1.333		Male	Ursac	Petru	KUMITE BOYS 11-12 YEARS -34KG
1.334		Male	Ursac	Petru	KUMITE BOYS 9-10 YEARS -35kg

Entries: 7

31ST KARATE GRAND PRIX CROATIA

CROATIA 2023.01.20 - 2023.01.22
CITY SPORTS HALL SAMOBOR, ANDRIJE HEBRANGA 26A, SAMOBOR, CROATIA

Tournament Participation (Entries) by Club

 MONTENEGRO					
 k.k. Omladinac(k.k. Omladinac)					
ID	Sex	Family Name	Given Name	Category	
1.335	Female	BANOVIĆ	JANJA	KUMITE GIRLS 13-14 YEARS +64KG	
1.336	Female	Gojkovic	Andrijana	KUMITE GIRLS 11-12 YEARS +54KG	
1.337	Male	Ilincic	Filip	KUMITE BOYS 11-12 YEARS -54KG	
1.338	Female	Miladinovic	Jelena	Kumite female cadets -47kg	
1.339	Male	Skataric	Veselin	KUMITE BOYS 11-12 YEARS -44KG	
1.340	Female	Terzić	Ines	KUMITE GIRLS 11-12 YEARS +54KG	

Entries: 6

31ST KARATE GRAND PRIX CROATIA

CROATIA 2023.01.20 - 2023.01.22
CITY SPORTS HALL SAMOBOR, ANDRIJE HEBRANGA 26A, SAMOBOR, CROATIA

Tournament Participation (Entries) by Club

Karate klub ISKRA(KK ISKRA)					
ID	Sex	Family Name	Given Name	Category	
1.341	Male	Kovacevic	Ilija	K21 - MALE SENIORS INTELLECTUALLY IMPAIRED	
1.342	Male	Laković	Marko	KUMITE BOYS 13-14 YEARS -49KG	
1.343	SD738206	Petrić	Saša	KATA male cadets	
1.344	Female	Prelević	Lana	KATA GIRLS 11 YEARS	
1.345	Female	Todorović	Martina	KUMITE GIRLS 11-12 YEARS -34KG	
1.346	Female	Vlahović	Katarina	KATA female cadets R2-G1	
1.347	Female	Vlahović	Katarina	KATA female cadets	
1.348	Male	Vučinić	Vuk	Kumite male cadets -63kg	

Entries: 8

31ST KARATE GRAND PRIX CROATIA

CROATIA

2023.01.20 - 2023.01.22

CITY SPORTS HALL SAMOBOR, ANDRIJE HEBRANGA 26A, SAMOBOR, CROATIA

Tournament Participation (Entries) by Club

 Karate klub Kondor(KK Kondor)					
ID	Sex	Family Name	Given Name	Category	
1.349	Female	Andjusic	Vesna	KATA GIRLS 13 YEARS	

Entries: 1

31ST KARATE GRAND PRIX CROATIA

CROATIA

2023.01.20 - 2023.01.22

CITY SPORTS HALL SAMOBOR, ANDRIJE HEBRANGA 26A, SAMOBOR, CROATIA

Tournament Participation (Entries) by Club

 KARATE KLUB PANTER(KK PANTER)					
ID	Sex	Family Name	Given Name	Category	
1.350	Female	Barac	Masa	KATA GIRLS 12 YEARS	
1.351	Male	IVANOVIC	LAZAR	KATA BOYS 11 YEARS	
1.352	Male	Nikitovic	Niksa	KATA BOYS 11 YEARS	
1.353	Female	VUJOVIC	LEONORA	KATA GIRLS 14 YEARS	
1.354	Male	Zecevic	Vuk	KATA BOYS 11 YEARS	

Entries: 5

31ST KARATE GRAND PRIX CROATIA

CROATIA

2023.01.20 - 2023.01.22

CITY SPORTS HALL SAMOBOR, ANDRIJE HEBRANGA 26A, SAMOBOR, CROATIA

Tournament Participation (Entries) by Club

 kkPotoci(Potoci)					
ID	Sex	Family Name	Given Name	Category	
1.355	Female	Beljkas	Neda	KATA GIRLS 13 YEARS	
1.356	Female	Beljkas	Neda	KATA female cadets	
1.357	Male	Borović	Dušan	KATA BOYS 12 YEARS	
1.358	Male	Cupara	Jakov	KATA BOYS 10 YEARS	
1.359	0049203	KLACAR	LUKA	KATA male cadets	
1.360	0049203	KLACAR	LUKA	KATA BOYS 14 YEARS	

Entries: **6**

31ST KARATE GRAND PRIX CROATIA

CROATIA 2023.01.20 - 2023.01.22
CITY SPORTS HALL SAMOBOR, ANDRIJE HEBRANGA 26A, SAMOBOR, CROATIA

Tournament Participation (Entries) by Club

 Montenegro(Montenegro)					
ID	Sex	Family Name	Given Name	Category	
1.361	Male	ARIFAJ	ANES	Kumite male cadets -70kg	
1.362	Female	BACKOVIC	HELENA	Kumite female juniors -48kg	
1.363	Male	Bijelic	Dusan	Kumite Male U21 -84kg	
1.364	Male	BJELAJAC	OGNJEN	Kumite male juniors -61kg	
1.365	Male	BOJIC	MATIJA	Kumite Male U21 -60kg	
1.366	Female	BORICIC	NADJA	Kumite female Cadets +61kg	
1.367	Female	CALIC	JOVANA	Kumite female juniors -59kg	
1.368	Female	DAMJANOVIC	JOVANA	Kumite female Cadets -61kg	
1.369	Male	Danilovic	Andrija	Kumite Male U21 -67kg	
1.370	Male	Danilovic	Andrija	Kumite male juniors -68kg	
1.371	Male	DJURICIC	NENAD	Kumite male cadets -63kg	
1.372	Male	GOJAKOVIC	MIHAILO	Kumite male cadets +70kg	
1.373	Male	JOVOVIC	NEMANJA	Kumite Male U21 +84kg	
1.374	Male	Jovović	Lazar	Kumite Male U21 -75kg	
1.375	Female	MARIC	LEA	Kumite female Juniors -66kg	
1.376	Female	NIKOLIC	ANJA	Kumite female juniors -59kg	
1.377	Male	POTPARA	LAZAR	Kumite male juniors +76kg	
1.378	Female	RAKOVIC	UNA	Kumite female cadets -54kg	
1.379	Male	SALJIU	EMRE	Kumite male juniors -76kg	
1.380	Male	SALJIU	JUSUF	Kumite male cadets -52kg	
1.381	Female	STOJANOVIC	JOVANA	Kumite Female U21 - 68kg	
1.382	Female	VLAHOVIC	LJUBICA	Kumite female Cadets -61kg	
1.383	Male	VOJINOVIC	BALSA	Kumite male juniors -55kg	
1.384	Male	Šoškić	Filip	Kumite male cadets -57kg	

Entries: 24

31ST KARATE GRAND PRIX CROATIA

CROATIA

2023.01.20 - 2023.01.22

CITY SPORTS HALL SAMOBOR, ANDRIJE HEBRANGA 26A, SAMOBOR, CROATIA

Tournament Participation (Entries) by Club



MOROCCO					
The Lions team(Lions)					
ID	Sex	Family Name	Given Name	Category	
1.385	Male	Elbouraoui	Youssef	KUMITE MALE SENIORS	

Entries: 1

31ST KARATE GRAND PRIX CROATIA

CROATIA 2023.01.20 - 2023.01.22
CITY SPORTS HALL SAMOBOR, ANDRIJE HEBRANGA 26A, SAMOBOR, CROATIA

Tournament Participation (Entries) by Club



 NETHERLANDS					
 Karateschool Fightin Nabil(KSFN, NED)					
ID	Sex	Family Name	Given Name	Category	
1.386	Female	Valk	Imane	Kumite female Cadets -61kg	

Entries: 1

31ST KARATE GRAND PRIX CROATIA

CROATIA 2023.01.20 - 2023.01.22
CITY SPORTS HALL SAMOBOR, ANDRIJE HEBRANGA 26A, SAMOBOR, CROATIA

Tournament Participation (Entries) by Club

 NORTH MACEDONIA					
 Bottoni(BOTTONI)					
ID	Sex	Family Name	Given Name	Category	
1.387	Male	Gelevski	Darko	Kumite Male U21 -75kg	
1.388	Male	Stojmirov	Stefan	Kumite Male U21 -67kg	

Entries: 2

31ST KARATE GRAND PRIX CROATIA

CROATIA 2023.01.20 - 2023.01.22
CITY SPORTS HALL SAMOBOR, ANDRIJE HEBRANGA 26A, SAMOBOR, CROATIA

Tournament Participation (Entries) by Club

 d(d)					
ID	Sex	Family Name	Given Name	Category	
1.389	Female	Mingovska	Anastasija	KATA FEMALE JUNIORS	

Entries: 1

31ST KARATE GRAND PRIX CROATIA

CROATIA 2023.01.20 - 2023.01.22
CITY SPORTS HALL SAMOBOR, ANDRIJE HEBRANGA 26A, SAMOBOR, CROATIA

Tournament Participation (Entries) by Club

 KK FATI TETOVĚ(KK Fati)					
ID	Sex	Family Name	Given Name	Category	
1.390	Female	Elmazi	Isa	KUMITE GIRLS 11-12 YEARS +54KG	
1.391	Female	Ziberi	Erdona	Kumite female Juniors -66kg	

Entries: 2

31ST KARATE GRAND PRIX CROATIA

CROATIA

2023.01.20 - 2023.01.22

CITY SPORTS HALL SAMOBOR, ANDRIJE HEBRANGA 26A, SAMOBOR, CROATIA

Tournament Participation (Entries) by Club

 KUSHTRIMI(K.K. Kushtrimi)					
ID	Sex	Family Name	Given Name	Category	
1.392	Male	Rushiti	Rexhep	Kumite Male U21 -67kg	
1.393	Male	Rushitii	Rexhep	Kumite male juniors -68kg	

Entries: 2

31ST KARATE GRAND PRIX CROATIA

CROATIA

2023.01.20 - 2023.01.22

CITY SPORTS HALL SAMOBOR, ANDRIJE HEBRANGA 26A, SAMOBOR, CROATIA

Tournament Participation (Entries) by Club

 Makpetrol MKD(Makpetrol MKD)					
ID	Sex	Family Name	Given Name	Category	
1.394	Male	Bozovic	Danilo	Kumite male juniors +76kg	
1.395	Female	Jovanovska	Viktorija	Kumite Female U21 - 61kg	
1.396	Male	Lozanovski	Dimitar	Kumite male juniors -76kg	
1.397	Female	Micovska	Jovana	Kumite female juniors -59kg	
1.398	Male	Petkov	Gligor	KUMITE MALE SENIORS	
1.399	Female	Petrovska	Marija	Kumite Female U21 -55kg	
1.400	MKD285	Spasenovski	Petar	KUMITE MALE SENIORS	
1.401	Male	Stojanovic	Stefan	Kumite Male U21 +84kg	
1.402	Male	Trajkovski	Vitimir	Kumite Male U21 -84kg	
1.403	Male	Zaborski	Petar	KUMITE MALE SENIORS	

Entries: **10**

31ST KARATE GRAND PRIX CROATIA

CROATIA 2023.01.20 - 2023.01.22
CITY SPORTS HALL SAMOBOR, ANDRIJE HEBRANGA 26A, SAMOBOR, CROATIA

Tournament Participation (Entries) by Club

 RINIA MATEÇ(K.K. RINIA)					
ID	Sex	Family Name	Given Name	Category	
1.404	Male	Shaqiri	Fisnik	Kumite male cadets -63kg	
1.405	Male	Shaqiri	Nedim	Kumite male juniors -55kg	

Entries: 2

31ST KARATE GRAND PRIX CROATIA

CROATIA

2023.01.20 - 2023.01.22

CITY SPORTS HALL SAMOBOR, ANDRIJE HEBRANGA 26A, SAMOBOR, CROATIA

Tournament Participation (Entries) by Club

 Uskana-Kërçovë(Uskana-Kercove)					
ID	Sex	Family Name	Given Name	Category	
1.406	Female	Минговска	Анастасија	KATA FEMALE JUNIORS	

Entries: 1

31ST KARATE GRAND PRIX CROATIA

CROATIA

2023.01.20 - 2023.01.22

CITY SPORTS HALL SAMOBOR, ANDRIJE HEBRANGA 26A, SAMOBOR, CROATIA

Tournament Participation (Entries) by Club

 Карате клуб Штип(Арсовски)					
ID	Sex	Family Name	Given Name	Category	
1.407	Male	Basarov	Andrej	Kumite male juniors +76kg	
1.408	Male	Mihajlov	Ljupco	Kumite male juniors -68kg	

Entries: 2

31ST KARATE GRAND PRIX CROATIA

CROATIA

2023.01.20 - 2023.01.22

CITY SPORTS HALL SAMOBOR, ANDRIJE HEBRANGA 26A, SAMOBOR, CROATIA

Tournament Participation (Entries) by Club

 Кизаме(Кизаме)					
ID	Sex	Family Name	Given Name	Category	
1.409	Female	Nikolova	Mila	KUMITE GIRLS 11-12 YEARS -49KG	
1.410	Female	Serafimova	Ilijana	Kumite female cadets -47kg	
1.411	Male	Stojchevski	Andrej	Kumite male cadets -57kg	
1.412	Male	Vrklevski	Jovan	Kumite male cadets -52kg	

Entries: 4

31ST KARATE GRAND PRIX CROATIA

CROATIA

2023.01.20 - 2023.01.22

CITY SPORTS HALL SAMOBOR, ANDRIJE HEBRANGA 26A, SAMOBOR, CROATIA

Tournament Participation (Entries) by Club

 Олимпик Спорт 2007 - Скопје(Олимпик Спорт 2007 - Скопје)					
ID	Sex	Family Name	Given Name	Category	
1.413	Male	Ангеловски	Андреј	Kumite male juniors -76kg	
1.414	Male	Ангеловски	Андреј	Kumite Male U21 -84kg	
1.415	Male	Белистојаноски	Матеј	Kumite Male U21 -60kg	
1.416	Male	Белистојаноски	Матеј	Kumite male juniors -61kg	
1.417	Female	Бунтевска	Марија	Kumite female juniors -59kg	
1.418	Male	Костов	Бојан	Kumite Male U21 -60kg	
1.419	Female	МИШОВСКА	МИХАЕЛА	Kumite female juniors -53kg	
1.420	Female	Пецевска	Ива	Kumite female juniors -53kg	
1.421	Male	Свинарски	Марио	Kumite Male U21 -75kg	

Entries: 9

31ST KARATE GRAND PRIX CROATIA

CROATIA

2023.01.20 - 2023.01.22

CITY SPORTS HALL SAMOBOR, ANDRIJE HEBRANGA 26A, SAMOBOR, CROATIA

Tournament Participation (Entries) by Club

 Цветан Димов - Скопје(Цветан Димов - Скопје)					
ID	Sex	Family Name	Given Name	Category	
1.422	Female	Алиу	Рудина	Kumite Female U21 - 61kg	

Entries: 1

31ST KARATE GRAND PRIX CROATIA

CROATIA

2023.01.20 - 2023.01.22

CITY SPORTS HALL SAMOBOR, ANDRIJE HEBRANGA 26A, SAMOBOR, CROATIA

Tournament Participation (Entries) by Club



 Чоле - Охрид(Чоле - Охрид)					
ID	Sex	Family Name	Given Name	Category	
1.423	Female	Petreska	Martina	Kumite female juniors -48kg	
1.424	Male	Petreski	Simon	Kumite Male U21 -84kg	
1.425	Male	Petreski	Stefan	Kumite Male U21 -67kg	

Entries: 3

31ST KARATE GRAND PRIX CROATIA

CROATIA 2023.01.20 - 2023.01.22
CITY SPORTS HALL SAMOBOR, ANDRIJE HEBRANGA 26A, SAMOBOR, CROATIA

Tournament Participation (Entries) by Club



 PHILIPPINES					
 Association for the Advancement of Karatedo(AAK Philippines)					
ID	Sex	Family Name	Given Name	Category	
1.426	Male	Batican	Alwyn	K12 - MALE SENIORS VISUALLY IMPAIRED	

Entries: 1

31ST KARATE GRAND PRIX CROATIA

CROATIA 2023.01.20 - 2023.01.22
CITY SPORTS HALL SAMOBOR, ANDRIJE HEBRANGA 26A, SAMOBOR, CROATIA

Tournament Participation (Entries) by Club



 ROMANIA					
 Crişul sport club Oradeaa(C. S. Crişul)					
ID	Sex	Family Name	Given Name	Category	
1.427	Male	Andrei	Paşca	KUMITE BOYS 9-10 YEARS -35kg	
1.428	Female	Claudia	Rácz	KUMITE GIRLS 9-10 YEARS -35kg	
1.429	Male	Eduard	Chiş	KUMITE BOYS 7-8 YEARS -28kg	
1.430	Male	Ianis	Roşu	KUMITE BOYS 9-10 YEARS -31kg	

Entries: 4

31ST KARATE GRAND PRIX CROATIA

CROATIA 2023.01.20 - 2023.01.22
CITY SPORTS HALL SAMOBOR, ANDRIJE HEBRANGA 26A, SAMOBOR, CROATIA

Tournament Participation (Entries) by Club

 SERBIA					
 Karate Academy Bushido(KA Bushido)					
ID	Sex	Family Name	Given Name	Category	
1.431	Male	Boškov	Aleksandar	KATA MALE JUNIORS R3-G1	
1.432	Male	Boškov	Aleksandar	KATA MALE JUNIORS R2-G1	
1.433	Male	Boškov	Aleksandar	KATA MALE JUNIORS R4 Bronze Medal Match 2	
1.434	Male	Boškov	Aleksandar	KATA MALE JUNIORS	
1.435	SRB260	Female	Mladežić	Bojana	Kata female seniors R3 Gold Medal Match
1.436	SRB260	Female	Mladežić	Bojana	Kata female seniors
1.437	SRB260	Female	Mladežić	Bojana	Kata female seniors R2-G1

Entries: 7

31ST KARATE GRAND PRIX CROATIA

CROATIA

2023.01.20 - 2023.01.22

CITY SPORTS HALL SAMOBOR, ANDRIJE HEBRANGA 26A, SAMOBOR, CROATIA

Tournament Participation (Entries) by Club

 Karate klub Borac 021(KK Borac 021)					
ID	Sex	Family Name	Given Name	Category	
1.438	Male	Djurdjic	Marko	Kumite male juniors -55kg	
1.439	Male	Kaurin	Marko	Kumite male cadets -57kg	

Entries: 2

31ST KARATE GRAND PRIX CROATIA

CROATIA

2023.01.20 - 2023.01.22

CITY SPORTS HALL SAMOBOR, ANDRIJE HEBRANGA 26A, SAMOBOR, CROATIA

Tournament Participation (Entries) by Club

 Karate klub Dinamo Pančevo(KK Dinamo Pančevo)					
ID	Sex	Family Name	Given Name	Category	
1.440	Male	Ivanović	Nikola	Kumite Male U21 -75kg	
1.441	Male	Salapura	Đorđe	KUMITE MALE SENIORS	
1.442	Male	Stepanov	Mateja	Kumite male cadets -57kg	
1.443	Male	Tešanović	Đorđe	KUMITE MALE SENIORS	

Entries: 4

31ST KARATE GRAND PRIX CROATIA

CROATIA

2023.01.20 - 2023.01.22

CITY SPORTS HALL SAMOBOR, ANDRIJE HEBRANGA 26A, SAMOBOR, CROATIA

Tournament Participation (Entries) by Club

 Karate klub Elid-Niš(KK Elid-Niš)					
ID	Sex	Family Name	Given Name	Category	
1.444	Male	Stanković	Andrija	Kata male seniors R3-G1	
1.445	Male	Stanković	Andrija	Kata male seniors R2-G1	
1.446	Male	Stanković	Andrija	Kata male seniors	

Entries: 3

31ST KARATE GRAND PRIX CROATIA

CROATIA

2023.01.20 - 2023.01.22

CITY SPORTS HALL SAMOBOR, ANDRIJE HEBRANGA 26A, SAMOBOR, CROATIA

Tournament Participation (Entries) by Club

 Karate Klub Hajduk Kula(K.K. Hajduk Kula)					
ID	Sex	Family Name	Given Name	Category	
1.447	Female	Kalmar	Matea	Kumite female Juniors +66kg	

Entries: 1

31ST KARATE GRAND PRIX CROATIA

CROATIA

2023.01.20 - 2023.01.22

CITY SPORTS HALL SAMOBOR, ANDRIJE HEBRANGA 26A, SAMOBOR, CROATIA

Tournament Participation (Entries) by Club

 Karate klub Poletarac(KKPoletarac)					
ID	Sex	Family Name	Given Name	Category	
1.448	BKS-KO681 1	Female	Arsić	Teodora	KATA GIRLS 13 YEARS

Entries: 1

31ST KARATE GRAND PRIX CROATIA

CROATIA

2023.01.20 - 2023.01.22

CITY SPORTS HALL SAMOBOR, ANDRIJE HEBRANGA 26A, SAMOBOR, CROATIA

Tournament Participation (Entries) by Club

 Karate klub Zadrugar(Lazarevo)					
ID	Sex	Family Name	Given Name	Category	
1.449	Female	Rajić	Dunja	Kumite female Juniors +66kg	

Entries: 1

31ST KARATE GRAND PRIX CROATIA

CROATIA

2023.01.20 - 2023.01.22

CITY SPORTS HALL SAMOBOR, ANDRIJE HEBRANGA 26A, SAMOBOR, CROATIA

Tournament Participation (Entries) by Club

 Karate klub Zandarmerija(KK Zandarmerija)					
ID	Sex	Family Name	Given Name	Category	
1.450	Female	Jevtovic	Dunja	Kumite female Juniors +66kg	
1.451	Male	Ljubisa	Maric	KUMITE MALE SENIORS	
1.452	Male	Ljubisa	Maric	Kumite male Seniors Open Final	
1.453	Female	Miranovic	Lara	Kumite female Cadets +61kg	

Entries: 4

31ST KARATE GRAND PRIX CROATIA

CROATIA

2023.01.20 - 2023.01.22

CITY SPORTS HALL SAMOBOR, ANDRIJE HEBRANGA 26A, SAMOBOR, CROATIA

Tournament Participation (Entries) by Club

 karate klub Čukarički Roda Beograd(Roda Beograd)					
ID	Sex	Family Name	Given Name	Category	
1.454	Male	Jovičić Jović	Dorian	KATA male cadets	
1.455	Female	Mešić	Mina	Kata female seniors	
1.456	Female	Mešić	Mina	kata female U21 R3 Bronze Medal Match 2	
1.457	Female	Mešić	Mina	Kata female seniors R2-G2	
1.458	Female	Mešić	Mina	kata female U21 R2-G1	
1.459	Female	Mešić	Mina	Kata female seniors R3 Bronze Medal Match 2	
1.460	Female	Mešić	Mina	kata female U21	

Entries: 7

31ST KARATE GRAND PRIX CROATIA

CROATIA

2023.01.20 - 2023.01.22

CITY SPORTS HALL SAMOBOR, ANDRIJE HEBRANGA 26A, SAMOBOR, CROATIA

Tournament Participation (Entries) by Club

 Karate klub Šampioni - Banja Koviljaca(KK Šampioni - BK)					
ID	Sex	Family Name	Given Name	Category	
1.461	Female	Negovanovic	Brankica	Kumite Female U21 -55kg	
1.462	Male	Vukasinovic	Marko	Kumite male cadets -57kg	

Entries: 2

31ST KARATE GRAND PRIX CROATIA

CROATIA

2023.01.20 - 2023.01.22

CITY SPORTS HALL SAMOBOR, ANDRIJE HEBRANGA 26A, SAMOBOR, CROATIA

Tournament Participation (Entries) by Club

 KK Mladost Novo Milosevo(KK Mladost Novo Milosevo)					
ID	Sex	Family Name	Given Name	Category	
1.463	Female	Filipov	Nevena	Kumite female juniors -59kg	

Entries: 1

31ST KARATE GRAND PRIX CROATIA

CROATIA 2023.01.20 - 2023.01.22
CITY SPORTS HALL SAMOBOR, ANDRIJE HEBRANGA 26A, SAMOBOR, CROATIA

Tournament Participation (Entries) by Club

 Klub kontaktnih sportova Borac - Čačak(KKS Borac - Čačak)					
ID	Sex	Family Name	Given Name	Category	
1.464	Female	Joksimović	Marta	Kumite female Cadets -61kg	
1.465	Female	Joksimović	Đurđa	Kumite female Cadets -61kg	
1.466	Female	Jovović	Dunja	Kumite female cadets -54kg	
1.467	Male	KAPLAREVIĆ	NIKOLA	Kumite male cadets -63kg	
1.468	Female	Krstović	Teodora	Kumite female Cadets +61kg	
1.469	Male	Krstović	Uroš	Kumite Male U21 +84kg	
1.470	Female	Ostojčić	Tijana	Kumite female cadets -47kg	
1.471	Male	Paunović	Đorđe	KATA male cadets	
1.472	Male	Pejović	Uglješa	Kumite male juniors +76kg	
1.473	Male	Purić	Lazar	Kumite male cadets -70kg	
1.474	Male	Purić	Miloš	KATA MALE JUNIORS	
1.475	Male	Radan	Uroš	Kumite Male U21 -67kg	
1.476	Male	Topuzović	Aleksandar	Kumite Male U21 -67kg	

Entries: 13

31ST KARATE GRAND PRIX CROATIA

CROATIA

2023.01.20 - 2023.01.22

CITY SPORTS HALL SAMOBOR, ANDRIJE HEBRANGA 26A, SAMOBOR, CROATIA

Tournament Participation (Entries) by Club

 Partizan(Kkpartizan)					
ID	Sex	Family Name	Given Name	Category	
1.477	Female	Grčak	Jana	Kumite Female U21 - 68kg	
1.478	Female	Radović	Anja	Kumite Female U21 - 68kg	

Entries: 2

31ST KARATE GRAND PRIX CROATIA

CROATIA

2023.01.20 - 2023.01.22

CITY SPORTS HALL SAMOBOR, ANDRIJE HEBRANGA 26A, SAMOBOR, CROATIA

Tournament Participation (Entries) by Club

 Skipper(Beograd)					
ID	Sex	Family Name	Given Name	Category	
1.479	Female	Nikolic	Mina	kata female U21	
1.480	Female	Nikolic	Mina	KATA FEMALE JUNIORS R3-G1	
1.481	Female	Nikolic	Mina	KATA FEMALE JUNIORS R4 Bronze Medal Match 2	
1.482	Female	Nikolic	Mina	KATA FEMALE JUNIORS R2-G1	
1.483	Female	Nikolic	Mina	KATA FEMALE JUNIORS	
1.484	SRB524	Male	Subota	Uros	Kata male seniors R3-G1
1.485	SRB524	Male	Subota	Uros	Kata male seniors R2-G1
1.486	SRB524	Male	Subota	Uros	Kata male seniors
1.487	SRB524	Male	Subota	Uros	Kata male seniors R4 Gold Medal Match

Entries: **9**

31ST KARATE GRAND PRIX CROATIA

CROATIA 2023.01.20 - 2023.01.22
CITY SPORTS HALL SAMOBOR, ANDRIJE HEBRANGA 26A, SAMOBOR, CROATIA

Tournament Participation (Entries) by Club

 Sportsko udruženje Spartanci 026 - S. Palanka(SU Spartanci 026 - S.Palanka)					
ID	Sex	Family Name	Given Name	Category	
1.488	Male	Jakovljević	Vasilije	KATA MALE JUNIORS	
1.489	Male	Jakovljević	Vasilije	KATA male cadets	

Entries: 2

31ST KARATE GRAND PRIX CROATIA

CROATIA

2023.01.20 - 2023.01.22

CITY SPORTS HALL SAMOBOR, ANDRIJE HEBRANGA 26A, SAMOBOR, CROATIA

Tournament Participation (Entries) by Club



 Studentski grad(Stg)					
ID	Sex	Family Name	Given Name	Category	
1.490	Male	Andjelic	Petar	Kumite male juniors -76kg	
1.491	Male	Orlandic	Petar	Kumite Male U21 -75kg	
1.492	Male	Orlandic	Petar	KUMITE MALE SENIORS	
1.493	Male	Vukovic	Luka	KUMITE MALE SENIORS	

Entries: 4

31ST KARATE GRAND PRIX CROATIA

CROATIA 2023.01.20 - 2023.01.22
CITY SPORTS HALL SAMOBOR, ANDRIJE HEBRANGA 26A, SAMOBOR, CROATIA

Tournament Participation (Entries) by Club

 SLOVAKIA					
 karate klub Detva(kk.Detva)					
ID	Sex	Family Name	Given Name	Category	
1.494	Female	Krnáčová	Natália	Kumite female cadets -47kg	

Entries: 1

31ST KARATE GRAND PRIX CROATIA

CROATIA

2023.01.20 - 2023.01.22

CITY SPORTS HALL SAMOBOR, ANDRIJE HEBRANGA 26A, SAMOBOR, CROATIA

Tournament Participation (Entries) by Club

 KARATE KLUB KRETOVIČ KOŠICE(KK KRETOVIČ Košice)					
ID	Sex	Family Name	Given Name	Category	
1.495	Female	Kollárová	Patrícia	KUMITE GIRLS 13-14 YEARS -49KG	
1.496	Female	Kretovičová	Rita	KUMITE GIRLS 13-14 YEARS -49KG	
1.497	Male	Plichta	Bruno	Kumite male cadets -52kg	

Entries: 3

31ST KARATE GRAND PRIX CROATIA

CROATIA

2023.01.20 - 2023.01.22

CITY SPORTS HALL SAMOBOR, ANDRIJE HEBRANGA 26A, SAMOBOR, CROATIA

Tournament Participation (Entries) by Club

 Karate Klub Seiwa Bratislava(KKSBA)					
ID	Sex	Family Name	Given Name	Category	
1.498	Male	Molnár	Matthias	K30 - MALE CADETS/JUNIORS WHEELCHAIR USERS	

Entries: 1

31ST KARATE GRAND PRIX CROATIA

CROATIA

2023.01.20 - 2023.01.22

CITY SPORTS HALL SAMOBOR, ANDRIJE HEBRANGA 26A, SAMOBOR, CROATIA

Tournament Participation (Entries) by Club

 KARATE KLUB SHIHAN POPRAD(SHIHAN POPRAD)					
ID	Sex	Family Name	Given Name	Category	
1.499	Male	Nedoroščik	Daniel	KATA MALE JUNIORS	
1.500	Male	Nedoroščik	Daniel	KATA male cadets R4 Bronze Medal Match 2	
1.501	Male	Nedoroščik	Daniel	KATA male cadets	
1.502	Male	Nedoroščik	Daniel	KATA MALE JUNIORS R2-G1	
1.503	Male	Nedoroščik	Daniel	KATA male cadets R3-G1	
1.504	Male	Nedoroščik	Daniel	KATA male cadets R2-G1	

Entries: 6

31ST KARATE GRAND PRIX CROATIA

CROATIA

2023.01.20 - 2023.01.22

CITY SPORTS HALL SAMOBOR, ANDRIJE HEBRANGA 26A, SAMOBOR, CROATIA

Tournament Participation (Entries) by Club

 Slovak National Team(SVK)					
ID	Sex	Family Name	Given Name	Category	
1.505	Male	Antoš	Vojtech	Kumite male juniors +76kg	
1.506	Male	Babel	Branislav	KATA BOYS 12 YEARS	
1.507	Male	Babel	Branislav	KATA BOYS 13 YEARS	
1.508	Female	Badrnová	Tamara	KUMITE GIRLS 13-14 YEARS -49KG	
1.509	Male	Bagaev	Malik	Kumite Male U21 +84kg	
1.510	Female	Bakayová	Zita	Kumite Female U21 + 68kg	
1.511	Male	Beno	Viktor	KATA BOYS 14 YEARS	
1.512	Male	Beno	Viktor	KATA BOYS 13 YEARS	
1.513	Male	Bohunický	Lukáš	Kumite male cadets +70kg	
1.514	Female	Brunanska	Kristina	Kata female seniors	
1.515	Female	Brunanska	Kristina	Kata female seniors R2-G2	
1.516	Male	Bugoš	Adam	Kumite Male U21 -60kg	
1.517	Male	Bukovič	Norbert	Kumite male juniors -61kg	
1.518	Female	Chrastinová	Petra	Kumite female Cadets +61kg	
1.519	Male	Dolnický	Adam	Kumite male juniors -55kg	
1.520	Male	Elias	Matus	KATA BOYS 14 YEARS	
1.521	Female	Erdélyiová	Nina	Kumite female Juniors +66kg	
1.522	Male	Filip	Denis	KATA MALE JUNIORS R4 Bronze Medal Match 2	
1.523	Male	Filip	Denis	KATA MALE JUNIORS	
1.524	Male	Filip	Denis	KATA MALE JUNIORS R3-G2	
1.525	Male	Filip	Denis	KATA MALE JUNIORS R2-G2	
1.526	Male	Gendes	David	KATA BOYS 14 YEARS	
1.527	Male	Gendes	David	KATA male cadets	
1.528	Male	Gendes	David	KATA male cadets R3-G2	
1.529	Male	Gendes	David	KATA male cadets R2-G2	
1.530	Male	Gendes	Juraj	KATA BOYS 12 YEARS	
1.531	Male	Gendes	Juraj	KATA BOYS 13 YEARS	
1.532	Male	Gyulaffy	Peter	KATA male cadets	
1.533	Male	Hrcka	Roman	kata male U21 R4 Bronze Medal Match 1	
1.534	Male	Hrcka	Roman	Kata male seniors R3-G1	
1.535	Male	Hrcka	Roman	Kata male seniors R2-G1	
1.536	Male	Hrcka	Roman	kata male U21 R3-G1	
1.537	Male	Hrcka	Roman	kata male U21 R2-G1	
1.538	Male	Hrcka	Roman	Kata male seniors R4 Bronze Medal Match 1	
1.539	Male	Hrcka	Roman	Kata male seniors	
1.540	Male	Hrcka	Roman	kata male U21	
1.541	Male	Ivančík	Oliver	Kumite male cadets -63kg	
1.542	Female	Jalowiczorová	Veronika	Kumite female juniors -48kg	
1.543	Male	Janovčík	Maroš	Kumite Male U21 -75kg	
1.544	Male	Jesenič	Peter	KUMITE BOYS 13-14 YEARS -64KG	
1.545	Female	Jeseničová	Nina	Kumite female Cadets -61kg	
1.546	Female	Kadlecajova	Viktoria	KATA female cadets R4 Bronze Medal Match 1	
1.547	Female	Kadlecajova	Viktoria	KATA female cadets R3-G1	
1.548	Female	Kadlecajova	Viktoria	KATA female cadets R2-G1	
1.549	Female	Kadlecajova	Viktoria	KATA female cadets	
1.550	Male	Kešefak	Dominik	Kumite Male U21 -84kg	
1.551	Female	Kisskova	Karolina	KATA GIRLS 14 YEARS	

31ST KARATE GRAND PRIX CROATIA

CROATIA 2023.01.20 - 2023.01.22
CITY SPORTS HALL SAMOBOR, ANDRIJE HEBRANGA 26A, SAMOBOR, CROATIA

Tournament Participation (Entries) by Club

1.552	Male	Krivda	Marek	Kumite male cadets -57kg
1.553	Female	Krivdová	Sára	Kumite Female U21 - 68kg
1.554	Female	Luptáková	Natália Lea	Kumite female juniors -59kg
1.555	Male	Michálek	Jakub	KUMITE BOYS 13-14 YEARS -69KG
1.556	Female	Mierna	Adriana	Kumite female cadets -47kg
1.557	Male	Miklovics	Damian	Kata male seniors
1.558	Male	Miklovics	Damian	Kata male seniors R3-G1
1.559	Male	Miklovics	Damian	Kata male seniors R2-G1
1.560	Male	Miklovics	Damian	Kata male seniors R4 Bronze Medal Match 2
1.561	Female	Mrazova	Rebeca	KATA FEMALE JUNIORS R2-G2
1.562	Female	Mrazova	Rebeca	KATA FEMALE JUNIORS R4 Bronze Medal Match 2
1.563	Female	Mrazova	Rebeca	KATA FEMALE JUNIORS
1.564	Female	Mrazova	Rebeca	KATA FEMALE JUNIORS R3-G2
1.565	Female	Mrázová	Lucia	Kumite Female U21 -50kg
1.566	Male	Muller	Juraj	KATA male cadets R3-G1
1.567	Male	Muller	Juraj	KATA male cadets R2-G1
1.568	Male	Muller	Juraj	KATA male cadets R4 Gold Medal Match
1.569	Male	Muller	Juraj	KATA male cadets
1.570	Male	Naňo	Tomáš	KUMITE BOYS 13-14 YEARS -59KG
1.571	Female	Okolicanyova	Rebeka	KATA GIRLS 14 YEARS
1.572	Male	Oravcik	Juraj	KATA BOYS 14 YEARS
1.573	Male	Oravcik	Juraj	KATA BOYS 13 YEARS
1.574	Male	Pirčák	Vasil	Kumite male juniors -76kg
1.575	Male	Poliak	Jakub	Kumite Male U21 -84kg
1.576	Female	Polónyová	Bianka	Kumite female juniors -59kg
1.577	Male	Slehofer	Richard	Kata male seniors
1.578	Male	Slehofer	Richard	Kata male seniors R2-G2
1.579	Female	Snopková	Viktória	Kumite Female U21 + 68kg
1.580	Female	Streicherova	Romana	KATA GIRLS 14 YEARS
1.581	Male	Szolar	Pavol	Kata male seniors R3-G2
1.582	Male	Szolar	Pavol	Kata male seniors
1.583	Male	Szolar	Pavol	Kata male seniors R4 Gold Medal Match
1.584	Male	Szolar	Pavol	Kata male seniors R2-G2
1.585	Female	Takacova	Tereza	kata female U21
1.586	Female	Takacova	Tereza	Kata female seniors
1.587	Male	Turčaník	Richard	Kumite male cadets -70kg
1.588	Male	Tvrdoň	Andrej	Kumite Male U21 -67kg
1.589	Female	Vanusanikova	Jana	Kata female seniors
1.590	Female	Verebová	Sára	Kumite female cadets -47kg
1.591	Female	Váczy	Anna	Kumite female Juniors -66kg
1.592	Female	Zeumerová	Alexandra	Kumite female cadets -54kg
1.593	Male	Čiaky	Martin	Kumite Male U21 -60kg
1.594	Female	Ševčíková	Natália	KUMITE GIRLS 11-12 YEARS -44KG

Entries: 90

31ST KARATE GRAND PRIX CROATIA

CROATIA 2023.01.20 - 2023.01.22
CITY SPORTS HALL SAMOBOR, ANDRIJE HEBRANGA 26A, SAMOBOR, CROATIA

Tournament Participation (Entries) by Club

 Sport School Karate Bratislava(SSK BA)					
ID	Sex	Family Name	Given Name	Category	
1.595	Female	Babelova	Daniela	KATA female cadets	
1.596	Male	Bugan	Leo	KATA BOYS 12 YEARS	
1.597	Male	Bugan	Leo	KATA BOYS 11 YEARS	
1.598	Female	Buganova	Ela	KATA GIRLS 8 YEARS	
1.599	Female	Buganova	Ela	KATA GIRLS 9 YEARS	
1.600	Male	Lopatka	Ladislav	Kumite male juniors +76kg	
1.601	Male	Lopatka	Martin	KUMITE BOYS 11-12 YEARS +54KG	
1.602	Male	Palka	Adam	KATA BOYS 8 YEARS	
1.603	Male	Palka	Adam	KATA BOYS 7 YEARS	
1.604	Male	Palka	Patrik	KUMITE BOYS 9-10 YEARS -27KG	
1.605	Male	Palka	Patrik	KATA BOYS 10 YEARS	
1.606	Male	Palka	Patrik	KATA BOYS 11 YEARS	

Entries: 12

31ST KARATE GRAND PRIX CROATIA

CROATIA

2023.01.20 - 2023.01.22

CITY SPORTS HALL SAMOBOR, ANDRIJE HEBRANGA 26A, SAMOBOR, CROATIA

Tournament Participation (Entries) by Club

 Tornado Karate team(KKTORNR)					
ID	Sex	Family Name	Given Name	Category	
1.607	Male	Kováčik	Šimon	KUMITE BOYS 13-14 YEARS -44KG	
1.608	Female	Ševčíková	Viktória	KUMITE GIRLS 13-14 YEARS -44KG	

Entries: 2

31ST KARATE GRAND PRIX CROATIA

CROATIA

2023.01.20 - 2023.01.22

CITY SPORTS HALL SAMOBOR, ANDRIJE HEBRANGA 26A, SAMOBOR, CROATIA

Tournament Participation (Entries) by Club

 UPJŠ Košice(UPJŠ KE)					
ID	Sex	Family Name	Given Name	Category	
1.609	Male	Papp	Zoltán	Kumite male juniors -76kg	

Entries: 1

31ST KARATE GRAND PRIX CROATIA

CROATIA

2023.01.20 - 2023.01.22

CITY SPORTS HALL SAMOBOR, ANDRIJE HEBRANGA 26A, SAMOBOR, CROATIA

Tournament Participation (Entries) by Club

ŠK CMK Banská Bystrica(CMK BB)					
ID	Sex	Family Name	Given Name	Category	
1.610	Female	Boboková	Zoja	Kumite female Cadets -61kg	
1.611	Male	Chrenko	Ján	Kumite male cadets -52kg	
1.612	Female	Dvorská	Lucia	Kumite female Juniors -66kg	
1.613	Male	Gašpar	Martin	KUMITE BOYS 11-12 YEARS -39KG	
1.614	Male	Gašpar	Miroslav	Kumite male cadets -52kg	
1.615	SVK02623	Kováč	Simon	Kumite male juniors -68kg	
1.616	Male	Krajan	Teo	Kumite male juniors -61kg	
1.617	Male	Králik	Tomáš	Kumite male juniors +76kg	
1.618	Female	Kuliková	Vira	Kumite female Cadets +61kg	
1.619	Female	Majdiaková	Laura	Kumite female cadets -54kg	
1.620	Female	Malá	Liliana	Kumite female juniors -53kg	
1.621	Male	Maňko	Jakub	Kumite Male U21 -75kg	
1.622	Female	Ozsvaldova	Lea	Kumite female Juniors +66kg	
1.623	Female	Rumanovská	Zoe	Kumite female cadets -54kg	
1.624	SVK02501	Sečkář	Šimon	Kumite male juniors -68kg	

Entries: 15

31ST KARATE GRAND PRIX CROATIA

CROATIA 2023.01.20 - 2023.01.22
CITY SPORTS HALL SAMOBOR, ANDRIJE HEBRANGA 26A, SAMOBOR, CROATIA

Tournament Participation (Entries) by Club

ŠK KARATE KACHI Nitra(KACHI)					
ID	Sex	Family Name	Given Name	Category	
1.625	Male	Elias	Oliver	KATA BOYS 7 YEARS	

Entries: 1



31ST KARATE GRAND PRIX CROATIA

CROATIA

2023.01.20 - 2023.01.22

CITY SPORTS HALL SAMOBOR, ANDRIJE HEBRANGA 26A, SAMOBOR, CROATIA

Tournament Participation (Entries) by Club

 SLOVENIA					
 DRUŠTVO ZA KARATE CELJE(DK CELJE)					
ID	Sex	Family Name	Given Name	Category	
1.626	Male	Golež	Peter	KUMITE BOYS 13-14 YEARS -59KG	
1.627	Female	Medič	Adela	KUMITE GIRLS 13-14 YEARS -59KG	
1.628	Male	RAKOVNIK	SVEN	Kumite Male U21 -60kg	

Entries: 3

31ST KARATE GRAND PRIX CROATIA

CROATIA

2023.01.20 - 2023.01.22

CITY SPORTS HALL SAMOBOR, ANDRIJE HEBRANGA 26A, SAMOBOR, CROATIA

Tournament Participation (Entries) by Club

 Karate klub Sokol, Ljubljana(Sokol)					
ID	Sex	Family Name	Given Name	Category	
1.629	Female	Bračun Mašera	Iris	KUMITE GIRLS 13-14 YEARS -64KG	
1.630	Female	Bračun Mašera	Iris	KATA GIRLS 13 YEARS	
1.631	Male	Erdelić	Žan	KUMITE BOYS 13-14 YEARS -54KG	

Entries: 3

31ST KARATE GRAND PRIX CROATIA

CROATIA

2023.01.20 - 2023.01.22

CITY SPORTS HALL SAMOBOR, ANDRIJE HEBRANGA 26A, SAMOBOR, CROATIA

Tournament Participation (Entries) by Club

 KARATE KLUB BREŽICE(KARATE KLUB BREŽICE)					
ID	Sex	Family Name	Given Name	Category	
1.632	Male	CICVARIĆ	LUKA	KATA male cadets	
1.633	Male	CICVARIĆ	LUKA	KATA male cadets R2-G1	
1.634	Female	LAKNER	MAJA	KATA female cadets	
1.635	Female	LAKNER	MAJA	KATA female cadets R2-G2	
1.636	Female	LAZANSKI	MAJA	KATA female cadets R2-G1	
1.637	Female	LAZANSKI	MAJA	KATA female cadets	

Entries: **6**

31ST KARATE GRAND PRIX CROATIA

CROATIA

2023.01.20 - 2023.01.22

CITY SPORTS HALL SAMOBOR, ANDRIJE HEBRANGA 26A, SAMOBOR, CROATIA

Tournament Participation (Entries) by Club

 KARATE KLUB BUSHIDO, ROGASKA SLATINA(KK BUSHIDO)					
ID	Sex	Family Name	Given Name	Category	
1.638	SLO2213	Male	Jordan	Timotej	KUMITE MALE SENIORS
1.639	SLO2213	Male	Jordan	Timotej	Kumite Male U21 -84kg
1.640		Male	JURAJA	VINKO	KATA BOYS 14 YEARS
1.641		Male	JURAJA	VINKO	KATA BOYS 13 YEARS
1.642		Female	MASTNAK	MIA	KUMITE GIRLS 11-12 YEARS -49KG

Entries: 5

31ST KARATE GRAND PRIX CROATIA

CROATIA

2023.01.20 - 2023.01.22

CITY SPORTS HALL SAMOBOR, ANDRIJE HEBRANGA 26A, SAMOBOR, CROATIA

Tournament Participation (Entries) by Club

Karate Klub Cerknica(KK Cerknica)					
ID	Sex	Family Name	Given Name	Category	
1.643	Male	Tekavc	Žiga	KATA BOYS 10 YEARS	

Entries: 1

31ST KARATE GRAND PRIX CROATIA

CROATIA 2023.01.20 - 2023.01.22
CITY SPORTS HALL SAMOBOR, ANDRIJE HEBRANGA 26A, SAMOBOR, CROATIA

Tournament Participation (Entries) by Club

 Karate Klub Kolektor Idrija(KKK Idrija)					
ID	Sex	Family Name	Given Name	Category	
1.644	Male	Božič	Cene	Kumite male juniors -76kg	
1.645	Male	Filipič	Mark	Kumite male cadets -52kg	
1.646	Female	Humar	Gaja	Kumite female Cadets +61kg	
1.647	Female	Krvina	Lia	KUMITE GIRLS 13-14 YEARS -54KG	
1.648	Male	Mlakar	Luka	Kumite male cadets -70kg	
1.649	Female	Mlakar	Nika	KUMITE GIRLS 13-14 YEARS -44KG	
1.650	Male	Muhić	Din	Kumite male cadets -52kg	
1.651	Male	Permozer	Marc	KUMITE BOYS 13-14 YEARS -54KG	
1.652	Male	Primožič	Neo	KUMITE BOYS 11-12 YEARS -39KG	
1.653	Female	Zupančič	Nana	KUMITE GIRLS 13-14 YEARS -49KG	
1.654	Male	Čuk	Danijel	KUMITE BOYS 11-12 YEARS -49KG	

Entries: 11

31ST KARATE GRAND PRIX CROATIA

CROATIA

2023.01.20 - 2023.01.22

CITY SPORTS HALL SAMOBOR, ANDRIJE HEBRANGA 26A, SAMOBOR, CROATIA

Tournament Participation (Entries) by Club

 Karate Klub Kovinar Maribor(KK Kovinar Maribor)					
ID	Sex	Family Name	Given Name	Category	
1.655	Male	Bauman	Gal	Kumite male cadets -57kg	
1.656	Male	Rola	Luka	Kumite male cadets -63kg	
1.657	Male	Zarić	Vid	Kumite male juniors -61kg	

Entries: 3

31ST KARATE GRAND PRIX CROATIA

CROATIA

2023.01.20 - 2023.01.22

CITY SPORTS HALL SAMOBOR, ANDRIJE HEBRANGA 26A, SAMOBOR, CROATIA

Tournament Participation (Entries) by Club

 Karate klub Kranj(KK Kranj SLO)					
ID	Sex	Family Name	Given Name	Category	
1.658	Male	GAČIĆ	ALEKSANDER	Kumite male cadets -70kg	
1.659	Female	Leben	Tinkara	Kumite female cadets -54kg	
1.660	Female	Nadižar	Lana Tisa	kata female U21	
1.661	Female	Nadižar	Lana Tisa	Kata female seniors R2-G1	
1.662	Female	Nadižar	Lana Tisa	Kata female seniors	
1.663	Female	Polak	Tia	KATA female cadets	
1.664	Female	Čeru	Jerneja	Kumite female Cadets -61kg	

Entries: 7

31ST KARATE GRAND PRIX CROATIA

CROATIA

2023.01.20 - 2023.01.22

CITY SPORTS HALL SAMOBOR, ANDRIJE HEBRANGA 26A, SAMOBOR, CROATIA

Tournament Participation (Entries) by Club

 Karate klub Limbuš(kutnjak)					
ID	Sex	Family Name	Given Name	Category	
1.665	Female	Kutnjak	Urška	Kumite female juniors -53kg	
1.666	Female	Kutnjak	Urška	Kumite female cadets -54kg	

Entries: 2

31ST KARATE GRAND PRIX CROATIA

CROATIA 2023.01.20 - 2023.01.22
CITY SPORTS HALL SAMOBOR, ANDRIJE HEBRANGA 26A, SAMOBOR, CROATIA

Tournament Participation (Entries) by Club

 KARATE KLUB LJUBLJANA(KK LJUBLJANA)					
ID	Sex	Family Name	Given Name	Category	
1.667	Female	Debeljak	Hana	Kumite Female U21 - 61kg	
1.668	Male	Gorišek	Matej	KUMITE MALE SENIORS	
1.669	Male	Gorišek	Matej	Kumite Male U21 -75kg	
1.670	Male	KOŠMRLJ	ERIK TEO	Kumite Male U21 -67kg	
1.671	Male	Kržišnik	Gal	Kumite male juniors +76kg	
1.672	Male	KRŽIŠNIK	LAN	KUMITE BOYS 13-14 YEARS -64KG	
1.673	Male	KRŽIŠNIK	LAN	KUMITE BOYS 13-14 YEARS -59KG	
1.674	Female	KURBEGOVIĆ	EDNA	Kumite female cadets -54kg	
1.675	Female	MOLNAR	ELIZABETA	Kumite Female U21 - 68kg	
1.676	Female	Muzik	Taša	Kumite female Juniors +66kg	
1.677	Male	Turković	Jan	KUMITE BOYS 11-12 YEARS +54KG	
1.678	Male	ŽIBRET	BOR	Kumite male juniors -68kg	
1.679	Female	ŽIBRET	ZALA MARIA	Kumite Female U21 + 68kg	

Entries: 13

31ST KARATE GRAND PRIX CROATIA

CROATIA 2023.01.20 - 2023.01.22
CITY SPORTS HALL SAMOBOR, ANDRIJE HEBRANGA 26A, SAMOBOR, CROATIA

Tournament Participation (Entries) by Club

 Karate klub Mawashi Postojna(KK Mawashi)					
ID	Sex	Family Name	Given Name	Category	
1.680	Female	Bešić	Lana	KATA GIRLS 13 YEARS	
1.681	Female	Bešić	Lana	KATA GIRLS 12 YEARS	
1.682	Female	GOMBAČ	Laura	KATA GIRLS 8 YEARS	
1.683	Female	Kobal Pahor	Lea	KATA FEMALE JUNIORS	
1.684	Female	Kobal Pahor	Lea	KATA FEMALE JUNIORS R3-G2	
1.685	Female	Kobal Pahor	Lea	KATA FEMALE JUNIORS R2-G2	
1.686	Female	Kontrec	Alja	KATA FEMALE JUNIORS	
1.687	Female	Magajna	Maša	Kumite Female U21 -50kg	
1.688	Male	Sterniša	Nejc	kata male U21 R3-G2	
1.689	Male	Sterniša	Nejc	kata male U21	
1.690	Male	Sterniša	Nejc	kata male U21 R2-G2	
1.691	Female	Đaković	Lara	Kumite Female U21 -50kg	
1.692	Male	Šabec	Aljoša	KUMITE BOYS 11-12 YEARS -39KG	

Entries: **13**

31ST KARATE GRAND PRIX CROATIA

CROATIA

2023.01.20 - 2023.01.22

CITY SPORTS HALL SAMOBOR, ANDRIJE HEBRANGA 26A, SAMOBOR, CROATIA

Tournament Participation (Entries) by Club

 Karate klub Polzela(KK Polzela)					
ID	Sex	Family Name	Given Name	Category	
1.693	Female	Avžner	Zoja	Kumite Female U21 - 68kg	
1.694	Female	Bergant	Laura	Kumite Female U21 -55kg	
1.695	Female	Jesenek Rojšek	Aneja	Kumite female Juniors -66kg	

Entries: 3

31ST KARATE GRAND PRIX CROATIA

CROATIA 2023.01.20 - 2023.01.22
CITY SPORTS HALL SAMOBOR, ANDRIJE HEBRANGA 26A, SAMOBOR, CROATIA

Tournament Participation (Entries) by Club

 KARATE KLUB POSTOJNA(KK POSTOJNA)					
ID	Sex	Family Name	Given Name	Category	
1.696	Male	SUBOTIĆ	FILIP	KATA BOYS 14 YEARS	

Entries: 1

31ST KARATE GRAND PRIX CROATIA

CROATIA

2023.01.20 - 2023.01.22

CITY SPORTS HALL SAMOBOR, ANDRIJE HEBRANGA 26A, SAMOBOR, CROATIA

Tournament Participation (Entries) by Club

 Karate Klub Radenci Shotokan(KK Radenci Shotokan)					
ID	Sex	Family Name	Given Name	Category	
1.697	Male	Tamse Marinic	Niklas	Kumite Male U21 -67kg	

Entries: 1

31ST KARATE GRAND PRIX CROATIA

CROATIA 2023.01.20 - 2023.01.22
CITY SPORTS HALL SAMOBOR, ANDRIJE HEBRANGA 26A, SAMOBOR, CROATIA

Tournament Participation (Entries) by Club

 Karate klub SEKI(KK Seki)					
ID	Sex	Family Name	Given Name	Category	
1.698	Female	HUSIĆ	LANA	KATA GIRLS 9 YEARS	
1.699	Female	HUSIĆ	LANA	KATA GIRLS 8 YEARS	
1.700	Female	JERŠIĆ	ŽANA	KATA GIRLS 13 YEARS	
1.701	Female	JERŠIĆ	ŽANA	KATA GIRLS 12 YEARS	
1.702	Male	KOTNIK	LIAM	KATA BOYS 8 YEARS	
1.703	Female	KREGAR	GABRIJELA	KATA female cadets	
1.704	Female	KRISTIĆ	KAROLINA	KATA GIRLS 11 YEARS	
1.705	Male	MAVSAR	TADEJ	KATA BOYS 10 YEARS	
1.706	Male	MAVSAR	TADEJ	KATA BOYS 11 YEARS	
1.707	Male	MAVSAR	TADEJ	KUMITE BOYS 11-12 YEARS -34KG	
1.708	Male	MAVSAR	TADEJ	KUMITE BOYS 9-10 YEARS -31kg	
1.709	Female	MAVSAR	TAJDA	KATA GIRLS 14 YEARS	
1.710	Male	MILJATOVIĆ	ALEKSA	KATA BOYS 13 YEARS	
1.711	Male	MILJATOVIĆ	ALEKSA	KATA BOYS 14 YEARS	
1.712	Female	MILJATOVIĆ	ANDJELA	KATA GIRLS 13 YEARS	
1.713	Female	MILJATOVIĆ	ANDJELA	KATA GIRLS 12 YEARS	
1.714	Male	SLUGA	JURE	kata male U21 R4 Bronze Medal Match 2	
1.715	Male	SLUGA	JURE	Kata male seniors	
1.716	Male	SLUGA	JURE	kata male U21	
1.717	Male	SLUGA	JURE	kata male U21 R3-G2	
1.718	Male	SLUGA	JURE	kata male U21 R2-G2	
1.719	Male	SLUGA	JURE	Kata male seniors R2-G1	
1.720	Female	SREBRE	LANA	KATA GIRLS 8 YEARS	
1.721	Female	TOMAŽIĆ	EVA	KATA FEMALE JUNIORS	

Entries: **24**

31ST KARATE GRAND PRIX CROATIA

CROATIA

2023.01.20 - 2023.01.22

CITY SPORTS HALL SAMOBOR, ANDRIJE HEBRANGA 26A, SAMOBOR, CROATIA

Tournament Participation (Entries) by Club

 KARATE KLUB TRBOVLJE(TRBOVLJE)					
ID	Sex	Family Name	Given Name	Category	
1.722	Male	Hozanović	Arman	KATA BOYS 11 YEARS	
1.723	Male	Hozanović	Arman	KUMITE BOYS 11-12 YEARS -34KG	
1.724	Male	MARKULJEVIĆ	MARKO	Kumite Male U21 -75kg	
1.725	Male	MARKULJEVIĆ	UROŠ	KUMITE MALE SENIORS	
1.726	Male	MARKULJEVIĆ	UROŠ	Kumite Male U21 +84kg	
1.727	Male	Ovnič	Tian	KATA BOYS 13 YEARS	

Entries: 6

31ST KARATE GRAND PRIX CROATIA

CROATIA

2023.01.20 - 2023.01.22

CITY SPORTS HALL SAMOBOR, ANDRIJE HEBRANGA 26A, SAMOBOR, CROATIA

Tournament Participation (Entries) by Club

 KARATE KLUB VELENJE(KK VELENJE)					
ID	Sex	Family Name	Given Name	Category	
1.728	Female	BEKČIĆ	DIANDRA	K21 - FEMALE SENIORS INTELLECTUALLY IMPAIRED	
1.729	Male	JELEN	GAL	KUMITE BOYS 11-12 YEARS -39KG	
1.730	Male	JELEN	GAL	KATA BOYS 12 YEARS	
1.731	Male	MEŠANOVIĆ	BENJAMIN	kata male U21	
1.732	Male	MEŠANOVIĆ	BENJAMIN	KATA MALE JUNIORS	
1.733	Male	PAŠIĆ	ADAM	KATA BOYS 13 YEARS	
1.734	Male	PAŠIĆ	ADAM	KUMITE BOYS 11-12 YEARS -34KG	
1.735	Male	PAŠIĆ	ADAM	KATA BOYS 12 YEARS	
1.736	Male	PAŠIĆ	ISAK	Kumite male juniors -68kg	
1.737	Female	PISNIK	MAJA MARI	KATA GIRLS 13 YEARS	
1.738	Female	PISNIK	MAJA MARI	KATA GIRLS 12 YEARS	
1.739	Female	PISNIK	SARA	KATA GIRLS 9 YEARS	
1.740	Female	RUDOLF	NIKA	KATA GIRLS 13 YEARS	
1.741	Female	RUDOLF	NIKA	KUMITE GIRLS 11-12 YEARS -34KG	
1.742	Female	RUDOLF	NIKA	KATA GIRLS 12 YEARS	
1.743	Male	ŠTEFANIĆ	VAL	KATA BOYS 10 YEARS	
1.744	Male	ŠTEFANIĆ	VAL	KUMITE BOYS 9-10 YEARS -31kg	

Entries: 17

31ST KARATE GRAND PRIX CROATIA

CROATIA

2023.01.20 - 2023.01.22

CITY SPORTS HALL SAMOBOR, ANDRIJE HEBRANGA 26A, SAMOBOR, CROATIA

Tournament Participation (Entries) by Club

 Karate klub Zalec(kk zalec)					
ID	Sex	Family Name	Given Name	Category	
1.745	Male	Joksimovic	Stefan	KUMITE MALE SENIORS	
1.746	Male	Susa	Ziga	Kumite male juniors -76kg	

Entries: 2

31ST KARATE GRAND PRIX CROATIA

CROATIA 2023.01.20 - 2023.01.22
CITY SPORTS HALL SAMOBOR, ANDRIJE HEBRANGA 26A, SAMOBOR, CROATIA

Tournament Participation (Entries) by Club

 Karate sekcija TVD Partizan Ljutomer(Karate Ljutomer)					
ID	Sex	Family Name	Given Name	Category	
1.747	Female	Janžekovič	Nuša	KUMITE GIRLS 13-14 YEARS +64KG	
1.748	Female	Plohl	Taja	KUMITE GIRLS 11-12 YEARS -49KG	
1.749	Female	Rauter	Hannah Vela	KUMITE GIRLS 13-14 YEARS -54KG	

Entries: 3

31ST KARATE GRAND PRIX CROATIA

CROATIA

2023.01.20 - 2023.01.22

CITY SPORTS HALL SAMOBOR, ANDRIJE HEBRANGA 26A, SAMOBOR, CROATIA

Tournament Participation (Entries) by Club

 Klub borilnih veščin FIGHT CLUB SHONY(Klub BVFC SHONY)					
ID	Sex	Family Name	Given Name	Category	
1.750	Male	Debelak	Dejan	Kumite Male U21 -75kg	
1.751	Female	Petan	Ela	Kumite female juniors -53kg	

Entries: 2

31ST KARATE GRAND PRIX CROATIA

CROATIA

2023.01.20 - 2023.01.22

CITY SPORTS HALL SAMOBOR, ANDRIJE HEBRANGA 26A, SAMOBOR, CROATIA

Tournament Participation (Entries) by Club

 lovrenc na pohorju(lovrenc)					
ID	Sex	Family Name	Given Name	Category	
1.752	Male	KRAJNC	MIHA	Kumite Male U21 -84kg	
1.753	Female	PISNIK	GAJA	KATA GIRLS 12 YEARS	
1.754	Female	PISNIK	GAJA	KATA GIRLS 11 YEARS	
1.755	Female	VERČKO	ANA	KATA GIRLS 12 YEARS	

Entries: 4

31ST KARATE GRAND PRIX CROATIA

CROATIA 2023.01.20 - 2023.01.22
CITY SPORTS HALL SAMOBOR, ANDRIJE HEBRANGA 26A, SAMOBOR, CROATIA

Tournament Participation (Entries) by Club

 SHOTOKAN KARATE KLUB OPLOTNICA(SKK OPLOTNICA)					
ID	Sex	Family Name	Given Name	Category	
1.756	Female	Ivančić	Kiara	KUMITE GIRLS 13-14 YEARS -44KG	
1.757	Female	Ivančić	Kiara	KUMITE GIRLS 11-12 YEARS -39KG	
1.758	Male	Jelenko	Benjamin	Kumite male cadets -57kg	
1.759	Female	Jelenko	Nina	KUMITE GIRLS 13-14 YEARS -54KG	
1.760	Female	Jelenko	Nina	KUMITE GIRLS 11-12 YEARS -54KG	
1.761	Female	JEVŠENAK	ALINA	KUMITE GIRLS 11-12 YEARS -39KG	
1.762	Female	JEVŠENAK	ALINA	KUMITE GIRLS 13-14 YEARS -44KG	
1.763	Male	Očko	Gal	KUMITE BOYS 13-14 YEARS +69KG	
1.764	Female	VALENČAK	NELI	Kumite female cadets -47kg	
1.765	Female	VALENČAK	NELI	KUMITE GIRLS 13-14 YEARS -44KG	

Entries: **10**

31ST KARATE GRAND PRIX CROATIA

CROATIA

2023.01.20 - 2023.01.22

CITY SPORTS HALL SAMOBOR, ANDRIJE HEBRANGA 26A, SAMOBOR, CROATIA

Tournament Participation (Entries) by Club

 ŠPORTNO DRUŠTVO GORICA(ŠD GORICA)					
ID	Sex	Family Name	Given Name	Category	
1.766	Male	KOLŠEK	KLEMEN	Kumite male juniors +76kg	
1.767	Male	MAKAROV	ILLYA	Kumite male juniors -61kg	
1.768	Male	RADIČ	LUKA	Kumite Male U21 -84kg	
1.769	Female	ČVOROVIĆ	ALEKSANDRA	kata female U21	

Entries: 4

31ST KARATE GRAND PRIX CROATIA

CROATIA 2023.01.20 - 2023.01.22
CITY SPORTS HALL SAMOBOR, ANDRIJE HEBRANGA 26A, SAMOBOR, CROATIA

Tournament Participation (Entries) by Club

UKRAINE					
Alpha Sport Karate Club(ASC)					
ID	Sex	Family Name	Given Name	Category	
1.770	Female	Herehova	Dariia	KUMITE GIRLS 9-10 YEARS -39kg	
1.771	Female	Herehova	Dariia	KUMITE GIRLS 11-12 YEARS -39KG	
1.772	Female	Orlova	Vladyslava	KUMITE GIRLS 11-12 YEARS -44KG	
1.773	Female	Orlova	Vladyslava	KUMITE GIRLS 11-12 YEARS -39KG	
1.774	UKR02683	Male	Pitsul	Kumite male juniors -68kg	
1.775	UKR02866	Male	Prokopiv	Kumite male juniors -76kg	
1.776	Female	Sokolnikova	Alisa	KUMITE GIRLS 9-10 YEARS -27kg	
1.777	Male	Tenzhala	Ivan	Kumite male cadets -70kg	

Entries: 8

31ST KARATE GRAND PRIX CROATIA

CROATIA
CITY SPORTS HALL SAMOBOR, ANDRIJE HEBRANGA 26A, SAMOBOR, CROATIA

2023.01.20 - 2023.01.22

Tournament Participation (Entries) by Club

Champion Karate Club(Champion Karate Club)					
ID	Sex	Family Name	Given Name	Category	
1.778	Male	BEKESHKO	IVAN	KUMITE BOYS 11-12 YEARS -44KG	
1.779	Male	BYKOV	TIMUR	KUMITE BOYS 9-10 YEARS -35kg	
1.780	Male	CHERNETSKYI	BOHDAN	KUMITE BOYS 13-14 YEARS -54KG	
1.781	Male	CHERNETSKYI	BOHDAN	Kumite male cadets -52kg	
1.782	Female	DATSIUK	MARIIA	KUMITE GIRLS 13-14 YEARS -44KG	
1.783	Female	ILINA	KSENIIA	Kumite Female U21 -50kg	
1.784	Male	KASIANOV	DANIIL	Kumite Male U21 -75kg	
1.785	Male	KASIANOV	DANIIL	Kumite male juniors -76kg	
1.786	Male	KHODAKOVSKIY	YEVSEVII	KUMITE BOYS 11-12 YEARS -34KG	
1.787	Male	KOSTYUKOVSKIY	OLEKSANDR	Kumite male cadets -57kg	
1.788	Male	KOSTYUKOVSKIY	OLEKSANDR	Kumite male juniors -55kg	
1.789	Female	KOTENKO	VIERONIKA	KUMITE GIRLS 13-14 YEARS -44KG	
1.790	Male	LISTRATOV	MATVII	KUMITE BOYS 11-12 YEARS -39KG	
1.791	Male	LISTRATOV	TYMOFII	Kumite male cadets -52kg	
1.792	Male	LYMAR	IVAN	Kumite male juniors -55kg	
1.793	Male	LYMAR	IVAN	Kumite male cadets -57kg	
1.794	Male	LYMAR	YEHOR	Kumite male juniors -68kg	
1.795	Male	PAKHOMOV	ARTUR	KUMITE BOYS 11-12 YEARS -44KG	
1.796	Male	PAKHOMOV	HLIB	Kumite male cadets -63kg	
1.797	Male	Rudenko	Klymentii	KUMITE BOYS 11-12 YEARS -34KG	
1.798	Male	Rudenko	Klymentii	KATA BOYS 12 YEARS	
1.799	Male	RUSANOV	DMYTRO	KUMITE BOYS 11-12 YEARS -34KG	
1.800	Female	SERGAIEVA	VALERIIA	Kumite Female U21 -55kg	
1.801	Female	SERGAIEVA	VALERIIA	Kumite female juniors -53kg	
1.802	Male	SERHEIEV	ILLIA	KUMITE BOYS 13-14 YEARS -44KG	
1.803	Female	STEFANCHUK	SOFIIA	KUMITE GIRLS 13-14 YEARS +64KG	
1.804	Male	TYSHCHENKO	YAROSLAV	Kumite male juniors -61kg	
1.805	Male	VASYLENKO	VLADYSLAV	KUMITE BOYS 11-12 YEARS -34KG	
1.806	Female	VASYLIEVA	YELYZAVETA	Kumite female cadets -54kg	
1.807	Female	VASYLIEVA	YELYZAVETA	KUMITE GIRLS 13-14 YEARS -49KG	
1.808	Female	YATSENIUK	YELYZAVETA	KUMITE GIRLS 13-14 YEARS -44KG	

Entries: 31

31ST KARATE GRAND PRIX CROATIA

CROATIA 2023.01.20 - 2023.01.22
CITY SPORTS HALL SAMOBOR, ANDRIJE HEBRANGA 26A, SAMOBOR, CROATIA

Tournament Participation (Entries) by Club

 KARATE TEAM CONCORDIA(CONCORDIA)					
ID	Sex	Family Name	Given Name	Category	
1.809	Male	Andrusiak	Illia	KUMITE BOYS 11-12 YEARS -49KG	
1.810	Male	Dudka	Nikita	KUMITE BOYS 9-10 YEARS -35kg	
1.811	Male	Khryshchuk	Pavlo	KUMITE BOYS 13-14 YEARS -49KG	
1.812	Male	Kinash	Oleh	Kumite Male U21 -67kg	
1.813	Male	Kinash	Oleh	Kumite male juniors -68kg	
1.814	Male	Kinash	Yaroslav	Kumite male cadets -63kg	
1.815	Male	Kinash	Yaroslav	KUMITE BOYS 13-14 YEARS -64KG	
1.816	Male	Kolesnyk	Makar	KUMITE BOYS 13-14 YEARS -49KG	
1.817	Male	Kolesnyk	Makar	KUMITE BOYS 11-12 YEARS -49KG	
1.818	Male	Kolodieznyi	Danylo	Kumite Male U21 -60kg	
1.819	Male	Kolodieznyi	Danylo	Kumite male juniors -61kg	
1.820	Male	Kostiukov	Tymur	Kumite male cadets -70kg	
1.821	Male	Pavliuk	Nikita	KUMITE BOYS 7-8 YEARS -28kg	
1.822	Female	Reshetnikova	Alisa	KUMITE GIRLS 13-14 YEARS -49KG	
1.823	Male	Rudakov	Nazar	Kumite Male U21 -75kg	
1.824	Male	Rudakov	Nazar	Kumite male juniors -68kg	
1.825	Male	Shchetynskyi	Savelii	KUMITE BOYS 11-12 YEARS -39KG	
1.826	Female	Sheptiy	Polina	KUMITE GIRLS 11-12 YEARS +54KG	
1.827	Female	Yushyna	Liliia	Kumite female juniors -59kg	

Entries: **19**

31ST KARATE GRAND PRIX CROATIA

CROATIA

2023.01.20 - 2023.01.22

CITY SPORTS HALL SAMOBOR, ANDRIJE HEBRANGA 26A, SAMOBOR, CROATIA

Tournament Participation (Entries) by Club

 Katana (Katana)					
ID	Sex	Family Name	Given Name	Category	
1.828	Male	Cheban	Oleksandr	KUMITE BOYS 13-14 YEARS -49KG	
1.829	Female	Elii	Sofia	KATA GIRLS 13 YEARS	
1.830	Female	Elii	Sofia	KUMITE GIRLS 13-14 YEARS -44KG	
1.831	Male	Fedorov	Evgeniy	KUMITE BOYS 13-14 YEARS -54KG	
1.832	Male	Khablo	Danylo	KATA male cadets	
1.833	Male	Khablo	Danylo	KATA male cadets R2-G1	
1.834	Male	Lukov	Zakhar	KATA BOYS 10 YEARS	
1.835	Male	Lukov	Zakhar	KUMITE BOYS 9-10 YEARS -35kg	
1.836	Female	Mandazhy	Nataliia	Kumite Female U21 -55kg	
1.837	Male	Metelenko	Vitaliy	KATA MALE JUNIORS	
1.838	Male	Metelenko	Vitaliy	KATA MALE JUNIORS R2-G2	
1.839	Male	Osadchyi	Dmytro	Kumite male cadets -63kg	
1.840	Male	Pecherskiy	Oleksandr	KUMITE BOYS 13-14 YEARS -49KG	
1.841	Male	Peshkov	Oleksiy	Kumite male cadets -57kg	
1.842	Female	Podkopaieva	Mariia	KATA GIRLS 9 YEARS	
1.843	Female	Podkopaieva	Mariia	KUMITE GIRLS 9-10 YEARS -27kg	
1.844	Female	Ponomarenko	Sofia	Kumite female Cadets -61kg	
1.845	Female	Pushkova	Anastasiia	Kumite female cadets -54kg	
1.846	Female	Pushkova	Mariia	KUMITE GIRLS 9-10 YEARS -39kg	
1.847	Female	Pushkova	Mariia	KATA GIRLS 9 YEARS	
1.848	Male	Rozhkov	Dmytro	KATA male cadets	
1.849	Male	Skakovskiy	Savelii	KATA BOYS 9 YEARS	
1.850	Male	Skakovskiy	Savelii	KUMITE BOYS 9-10 YEARS -31kg	
1.851	Male	Starenchenko	Serhii	Kumite male cadets -63kg	
1.852	Male	Sukhanov	Roman	Kumite male cadets -52kg	
1.853	Male	Tsebrii	Maksym	KATA BOYS 10 YEARS	

Entries: **26**

31ST KARATE GRAND PRIX CROATIA

CROATIA 2023.01.20 - 2023.01.22
CITY SPORTS HALL SAMOBOR, ANDRIJE HEBRANGA 26A, SAMOBOR, CROATIA

Tournament Participation (Entries) by Club

 Leader Team(Leader)					
ID	Sex	Family Name	Given Name	Category	
1.854	Male	Boichuk	Oleksandr	KUMITE BOYS 7-8 YEARS -28kg	
1.855	Male	Hlushku	Nikita	KUMITE BOYS 9-10 YEARS -31kg	
1.856	Female	Hnes	Mariia	Kumite female cadets -47kg	
1.857	Male	Iatsiuk	Ivan	KUMITE BOYS 9-10 YEARS -31kg	
1.858	Male	Ilchuk	Savelii	Kumite male cadets -52kg	
1.859	Male	Kozak	Kostiantyn	Kumite male cadets -63kg	
1.860	Male	Kozak	Kostiantyn	KUMITE BOYS 13-14 YEARS -59KG	
1.861	Male	Lytkin	Artem	KUMITE BOYS 9-10 YEARS -31kg	
1.862	Male	Lytkin	Artem	KUMITE BOYS 7-8 YEARS -36kg	
1.863	Male	Prannychuk	Nazarii	Kumite male cadets -57kg	
1.864	Male	Rusnak	Oleksii	KUMITE BOYS 9-10 YEARS -39kg	
1.865	Male	Ryha	Andriy	KUMITE BOYS 11-12 YEARS -49KG	
1.866	Female	Seliverstova	Daria	Kumite female juniors -53kg	
1.867	Male	Shakhov	Mykola	KUMITE BOYS 13-14 YEARS -69KG	
1.868	Male	Tahiev	Yevhen	KUMITE BOYS 11-12 YEARS -54KG	
1.869	Female	Vasyliv	Tetyana	Kumite female Cadets -61kg	
1.870	Male	Zavorotnyi	Oleksandr	KUMITE BOYS 9-10 YEARS -27KG	

Entries: 17

31ST KARATE GRAND PRIX CROATIA

CROATIA 2023.01.20 - 2023.01.22
CITY SPORTS HALL SAMOBOR, ANDRIJE HEBRANGA 26A, SAMOBOR, CROATIA

Tournament Participation (Entries) by Club

Legion-Odessa(Legion-Odessa)					
ID	Sex	Family Name	Given Name	Category	
1.871	Male	Verbitskiy	Gleb	Kumite male juniors -68kg	

Entries: 1

31ST KARATE GRAND PRIX CROATIA

CROATIA

2023.01.20 - 2023.01.22

CITY SPORTS HALL SAMOBOR, ANDRIJE HEBRANGA 26A, SAMOBOR, CROATIA

Tournament Participation (Entries) by Club

 LEON karate club(LEON karate club)					
ID	Sex	Family Name	Given Name	Category	
1.872	Female	Malivska	Viktoria	Kumite female cadets -47kg	
1.873	Female	Murashkina	Marharyta	KUMITE GIRLS 9-10 YEARS -27kg	
1.874	Female	Murashkina	Varvara	KUMITE GIRLS 11-12 YEARS -44KG	
1.875	Female	Ostapenko	Alisa	KUMITE GIRLS 13-14 YEARS -49KG	
1.876	Female	Ostapenko	Alisa	Kumite female cadets -47kg	

Entries: 5

31ST KARATE GRAND PRIX CROATIA

CROATIA 2023.01.20 - 2023.01.22
CITY SPORTS HALL SAMOBOR, ANDRIJE HEBRANGA 26A, SAMOBOR, CROATIA

Tournament Participation (Entries) by Club

 MOWGLY KARATE CLUB(MOWGLY KC)					
ID	Sex	Family Name	Given Name	Category	
1.877	Female	Golod	Anastasiia	KATA female cadets R2-G2	
1.878	Female	Golod	Anastasiia	KATA FEMALE JUNIORS	
1.879	Female	Golod	Anastasiia	KATA female cadets	
1.880	Male	Shykhali	Yusifov	Kumite male cadets -63kg	
1.881	Female	Studenkova	Daria	KATA female cadets R3-G1	
1.882	Female	Studenkova	Daria	KATA female cadets R2-G1	
1.883	Female	Studenkova	Daria	KATA female cadets	
1.884	Female	Studenkova	Daria	KATA female cadets R4 Bronze Medal Match 2	

Entries: 8

31ST KARATE GRAND PRIX CROATIA

CROATIA

2023.01.20 - 2023.01.22

CITY SPORTS HALL SAMOBOR, ANDRIJE HEBRANGA 26A, SAMOBOR, CROATIA

Tournament Participation (Entries) by Club

 OKINAWA(oki)					
ID	Sex	Family Name	Given Name	Category	
1.885	Female	Aleksandrova	Polina	KATA FEMALE JUNIORS R3-G1	
1.886	Female	Aleksandrova	Polina	KATA female cadets R3-G2	
1.887	Female	Aleksandrova	Polina	KATA FEMALE JUNIORS R2-G1	
1.888	Female	Aleksandrova	Polina	KATA female cadets R2-G2	
1.889	Female	Aleksandrova	Polina	KATA FEMALE JUNIORS	
1.890	Female	Aleksandrova	Polina	KATA female cadets	
1.891	Female	Baranova	Uliana	KATA FEMALE JUNIORS	
1.892	Female	Baranova	Uliana	KATA female cadets R3-G1	
1.893	Female	Baranova	Uliana	KATA female cadets R2-G1	
1.894	Female	Baranova	Uliana	KATA female cadets	
1.895	Female	Baranova	Uliana	Kumite female cadets -54kg	
1.896	Female	Baranova	Yliana	Kumite female juniors -59kg	
1.897	Male	Hlushchenko	Artur	KATA male cadets	
1.898	Male	Hlushchenko	Artur	Kumite male cadets -63kg	
1.899	Male	Hlushchenko	Artur	KATA male cadets R2-G1	
1.900	Female	Malenkova	Yulia	Kumite female Juniors +66kg	
1.901	Female	Malenkova	Yulia	Kumite Female U21 + 68kg	
1.902	Male	Poliakov	Maksym	Kumite Male U21 -84kg	
1.903	Male	Poliakov	Maksym	Kumite male juniors +76kg	

Entries: **19**

31ST KARATE GRAND PRIX CROATIA

CROATIA

2023.01.20 - 2023.01.22

CITY SPORTS HALL SAMOBOR, ANDRIJE HEBRANGA 26A, SAMOBOR, CROATIA

Tournament Participation (Entries) by Club

 Senbin karate club(Senbin)					
ID	Sex	Family Name	Given Name	Category	
1.904	Male	Mezentsev	Zakhar	Kumite male juniors -61kg	
1.905	Male	Semenenko	Nikita	KATA male cadets	
1.906	Male	Semenenko	Nikita	KATA male cadets R2-G2	
1.907	Male	Sereda	Yevgeniy	Kumite male juniors -68kg	

Entries: 4

31ST KARATE GRAND PRIX CROATIA

CROATIA 2023.01.20 - 2023.01.22
CITY SPORTS HALL SAMOBOR, ANDRIJE HEBRANGA 26A, SAMOBOR, CROATIA

Tournament Participation (Entries) by Club

 Shogun Sports Corporation - Kyiv(SFC KYIV)					
ID	Sex	Family Name	Given Name	Category	
1.908		Female	KYRYCHENKO	KATERYNA	Kumite female juniors -53kg
1.909	UKR2216	Female	TARANENKO	SOFIIA	Kata female seniors
1.910	UKR2216	Female	TARANENKO	SOFIIA	KATA FEMALE JUNIORS
1.911	UKR2216	Female	TARANENKO	SOFIIA	KATA FEMALE JUNIORS R2-G2
1.912		Male	ZINKEVYCH	YEHOR	Kumite Male U21 -67kg

Entries: 5

31ST KARATE GRAND PRIX CROATIA

CROATIA

2023.01.20 - 2023.01.22

CITY SPORTS HALL SAMOBOR, ANDRIJE HEBRANGA 26A, SAMOBOR, CROATIA

Tournament Participation (Entries) by Club

 Taikan Ukraine(Taikan Ukraine)					
ID	Sex	Family Name	Given Name	Category	
1.913	Female	Makarenko	Violeta	Kumite female cadets -54kg	

Entries: 1

31ST KARATE GRAND PRIX CROATIA

CROATIA 2023.01.20 - 2023.01.22
CITY SPORTS HALL SAMOBOR, ANDRIJE HEBRANGA 26A, SAMOBOR, CROATIA

Tournament Participation (Entries) by Club

 Tiger Team(Tiger Team)					
ID	Sex	Family Name	Given Name	Category	
1.914	Female	AHAPIIEVA	DARIA	KUMITE GIRLS 13-14 YEARS -59KG	
1.915	Female	AHAPIIEVA	DARIA	Kumite female Cadets -61kg	
1.916	Male	GRYNENKO	ILIUKHA	Kumite male juniors -61kg	
1.917	Male	HAVRILIUUK	MARK	KUMITE BOYS 9-10 YEARS -31kg	
1.918	Male	HAVRILIUUK	MARK	KATA BOYS 10 YEARS	
1.919	Male	HAVRYLIUK	VARLAM	KUMITE BOYS 7-8 YEARS -24kg	
1.920	Male	HAVRYLIUK	VARLAM	KATA BOYS 8 YEARS	
1.921	Male	HERULA	ROMAN	KUMITE BOYS 13-14 YEARS -44KG	
1.922	Female	HLAZUNOVA	KATERYNA	KUMITE GIRLS 11-12 YEARS -39KG	
1.923	Female	HLAZUNOVA	KATERYNA	KATA GIRLS 12 YEARS	
1.924	Male	HRYNENKO	ILLIA	Kumite male cadets -57kg	
1.925	Male	KHRISTOFOROV	DIMA	KUMITE BOYS 9-10 YEARS -31kg	
1.926	Male	KHRISTOFOROV	DIMA	KATA BOYS 9 YEARS	
1.927	Male	KOSHKIDKO	EDUARD	Kumite male cadets -63kg	
1.928	Male	KOVTUN	VASYA	KUMITE BOYS 13-14 YEARS -54KG	
1.929	Male	KOZAK	TYMOFII	Kumite male cadets -63kg	
1.930	Male	KRAVTSOV	MATVII	KUMITE BOYS 9-10 YEARS -27KG	
1.931	Male	KRAVTSOV	MATVII	KATA BOYS 9 YEARS	
1.932	Male	KUBARSKYI	YEHOR	Kumite male cadets +70kg	
1.933	Female	MARCHENKO	POLINA	Kumite Female U21 -50kg	
1.934	Male	NEGATUROV	YEHOR	KATA BOYS 9 YEARS	
1.935	Male	NEGATUROV	YEHOR	KUMITE BOYS 9-10 YEARS -27KG	
1.936	Male	PANCHUK	ARTEM	Kumite Male U21 -60kg	
1.937	Male	PANCHUK	ARTEM	Kumite male juniors -61kg	
1.938	Male	PATSIUK	KIRILL	Kumite male cadets -57kg	
1.939	Female	RUSAN	HANNA	Kumite female Cadets -61kg	
1.940	Female	RUSAN	HANNA	Kumite female Juniors -66kg	
1.941	Female	SEMENIUK	SOFIIA	KUMITE GIRLS 13-14 YEARS -54KG	
1.942	Male	SOKIRKO	ARTEM	KUMITE BOYS 13-14 YEARS -59KG	
1.943	Female	SOTNIKOVA	IVANKA	KUMITE GIRLS 11-12 YEARS -39KG	
1.944	Female	SOTNIKOVA	IVANKA	KATA GIRLS 10 YEARS	
1.945	Female	SOTNIKOVA	IVANKA	KUMITE GIRLS 9-10 YEARS -35kg	
1.946	Male	TADA	KYRYLO	KATA BOYS 12 YEARS	
1.947	Male	TADA	KYRYLO	KUMITE BOYS 11-12 YEARS -49KG	
1.948	Female	TAHIROVA	MARIIA	KUMITE GIRLS 13-14 YEARS -64KG	
1.949	Female	TAHIROVA	MARIIA	Kumite female Cadets +61kg	
1.950	Male	YERIOMIN	DANYLO	Kumite male cadets +70kg	

Entries: 37

31ST KARATE GRAND PRIX CROATIA

CROATIA 2023.01.20 - 2023.01.22
CITY SPORTS HALL SAMOBOR, ANDRIJE HEBRANGA 26A, SAMOBOR, CROATIA

Tournament Participation (Entries) by Club

UNION TEAM(Union team)					
ID	Sex	Family Name	Given Name	Category	
1.951	Male	Demkiv	Vasyl	Kumite male cadets -63kg	
1.952	Male	KRAVCHUK	MAKSYM	Kumite male cadets -57kg	
1.953	Female	KROT	YULIIA	Kumite female Juniors +66kg	
1.954	Male	OZORUBA	NAZARII	Kumite male cadets -63kg	
1.955	Male	Pohuliaiev	Serhii	Kumite male juniors -61kg	
1.956	Male	RESHAVETS	BOHDAN	Kumite male cadets -63kg	
1.957	Male	STETSIV	MAKSYM	Kumite male cadets -52kg	
1.958	Female	Voloshyn	Solomiya	Kumite female Cadets -61kg	

Entries: 8

31ST KARATE GRAND PRIX CROATIA

CROATIA 2023.01.20 - 2023.01.22
CITY SPORTS HALL SAMOBOR, ANDRIJE HEBRANGA 26A, SAMOBOR, CROATIA

Tournament Participation (Entries) by Club

 Zakhyst karate club(Zakhyst)					
ID	Sex	Family Name	Given Name	Category	
1.959	UKR03014	Female	Kholodniak	Daria	KATA female cadets
1.960	UKR03014	Female	Kholodniak	Daria	KATA female cadets R4 Gold Medal Match
1.961	UKR03014	Female	Kholodniak	Daria	KATA female cadets R3-G2
1.962	UKR03014	Female	Kholodniak	Daria	KATA FEMALE JUNIORS R2-G1
1.963	UKR03014	Female	Kholodniak	Daria	KATA female cadets R2-G2
1.964	UKR03014	Female	Kholodniak	Daria	KATA FEMALE JUNIORS
1.965	UKR02919	Male	Sokolov	Hlib	kata male U21
1.966	UKR02919	Male	Sokolov	Hlib	KATA MALE JUNIORS
1.967	UKR02919	Male	Sokolov	Hlib	kata male U21 R2-G2

Entries: 9



31ST KARATE GRAND PRIX CROATIA

CROATIA

2023.01.20 - 2023.01.22

CITY SPORTS HALL SAMOBOR, ANDRIJE HEBRANGA 26A, SAMOBOR, CROATIA

Tournament Participation (Entries) by Club

 UNITED STATES					
 Singleton(Singleton)					
ID	Sex	Family Name	Given Name	Category	
1.968	Female	Singleton	Charlotte	KUMITE GIRLS 13-14 YEARS -54KG	
1.969	Female	Singleton	Charlotte	Kumite female cadets -54kg	
1.970	Female	Singleton	Sophia	Kumite female juniors -48kg	

Entries: 3

31ST KARATE GRAND PRIX CROATIA

CROATIA

2023.01.20 - 2023.01.22

CITY SPORTS HALL SAMOBOR, ANDRIJE HEBRANGA 26A, SAMOBOR, CROATIA

Tournament Participation (Entries) by Club

Total Entries: **1.970**

31ST KARATE GRAND PRIX CROATIA

CROATIA 2023.01.20 - 2023.01.22
CITY SPORTS HALL SAMOBOR, ANDRIJE HEBRANGA 26A, SAMOBOR, CROATIA

Statistics

Participating Countries: 24 Participating Regions: 25 Participating Team/Clubs: 297

	Competitors	Entries
Female	648	763
Male	843	998
Total	1491	1761

Entries per Category	Entries	Teams
K11 - FEMALE SENIORS VISUALLY IMPAIRED	3	-
K11 - MALE SENIORS VISUALLY IMPAIRED	3	-
K12 - MALE CADETS/JUNIORS VISUALLY IMPAIRED	1	-
K12 - MALE SENIORS VISUALLY IMPAIRED	2	-
K21 - FEMALE SENIORS INTELLECTUALLY IMPAIRED	3	-
K21 - MALE SENIORS INTELLECTUALLY IMPAIRED	2	-
K22 - FEMALE SENIORS INTELLECTUALLY IMPAIRED	4	-
K22 - MALE SENIORS INTELLECTUALLY IMPAIRED	3	-
K30 - MALE CADETS/JUNIORS WHEELCHAIR USERS	1	-
K30 - MALE SENIORS WHEELCHAIR USERS	1	-
KATA BOYS 10 YEARS	14	-
KATA BOYS 11 YEARS	14	-
KATA BOYS 12 YEARS	16	-
KATA BOYS 13 YEARS	16	-
KATA BOYS 14 YEARS	16	-
KATA BOYS 7 YEARS	3	-
KATA BOYS 8 YEARS	6	-
KATA BOYS 9 YEARS	10	-
KATA FEMALE JUNIORS	34	-
KATA GIRLS 10 YEARS	5	-
KATA GIRLS 11 YEARS	11	-
KATA GIRLS 12 YEARS	16	-
KATA GIRLS 13 YEARS	18	-
KATA GIRLS 14 YEARS	12	-
KATA GIRLS 8 YEARS	6	-
KATA GIRLS 9 YEARS	8	-
KATA MALE JUNIORS	32	-
KATA female cadets	28	-
KATA male cadets	35	-
KUMITE BOYS 11-12 YEARS +54KG	8	-

31ST KARATE GRAND PRIX CROATIA

CROATIA
CITY SPORTS HALL SAMOBOR, ANDRIJE HEBRANGA 26A, SAMOBOR, CROATIA

2023.01.20 - 2023.01.22

Statistics

KUMITE BOYS 11-12 YEARS -34KG	21	-
KUMITE BOYS 11-12 YEARS -39KG	18	-
KUMITE BOYS 11-12 YEARS -44KG	19	-
KUMITE BOYS 11-12 YEARS -49KG	17	-
KUMITE BOYS 11-12 YEARS -54KG	8	-
KUMITE BOYS 13-14 YEARS +69KG	5	-
KUMITE BOYS 13-14 YEARS -44KG	31	-
KUMITE BOYS 13-14 YEARS -49KG	18	-
KUMITE BOYS 13-14 YEARS -54KG	16	-
KUMITE BOYS 13-14 YEARS -59KG	14	-
KUMITE BOYS 13-14 YEARS -64KG	8	-
KUMITE BOYS 13-14 YEARS -69KG	7	-
KUMITE BOYS 7-8 YEARS -24kg	3	-
KUMITE BOYS 7-8 YEARS -28kg	6	-
KUMITE BOYS 7-8 YEARS -36kg	2	-
KUMITE BOYS 9-10 YEARS +43kg	3	-
KUMITE BOYS 9-10 YEARS -27KG	15	-
KUMITE BOYS 9-10 YEARS -31kg	16	-
KUMITE BOYS 9-10 YEARS -35kg	10	-
KUMITE BOYS 9-10 YEARS -39kg	3	-
KUMITE BOYS 9-10 YEARS -43kg	2	-
KUMITE GIRLS 11-12 YEARS +54KG	10	-
KUMITE GIRLS 11-12 YEARS -34KG	23	-
KUMITE GIRLS 11-12 YEARS -39KG	20	-
KUMITE GIRLS 11-12 YEARS -44KG	11	-
KUMITE GIRLS 11-12 YEARS -49KG	13	-
KUMITE GIRLS 11-12 YEARS -54KG	10	-
KUMITE GIRLS 13-14 YEARS +64KG	11	-
KUMITE GIRLS 13-14 YEARS -44KG	20	-
KUMITE GIRLS 13-14 YEARS -49KG	17	-
KUMITE GIRLS 13-14 YEARS -54KG	18	-
KUMITE GIRLS 13-14 YEARS -59KG	16	-
KUMITE GIRLS 13-14 YEARS -64KG	10	-
KUMITE GIRLS 7-8 YEARS -24kg	1	-
KUMITE GIRLS 9-10 YEARS -27kg	13	-
KUMITE GIRLS 9-10 YEARS -31kg	9	-
KUMITE GIRLS 9-10 YEARS -35kg	6	-
KUMITE GIRLS 9-10 YEARS -39kg	6	-
KUMITE MALE SENIORS	40	-
Kata female seniors	24	-

31ST KARATE GRAND PRIX CROATIA

CROATIA

2023.01.20 - 2023.01.22

CITY SPORTS HALL SAMOBOR, ANDRIJE HEBRANGA 26A, SAMOBOR, CROATIA

Statistics

Kata male seniors	29	-
Kumite Female U21 -55kg	20	-
Kumite Female U21 + 68kg	14	-
Kumite Female U21 - 61kg	15	-
Kumite Female U21 - 68kg	18	-
Kumite Female U21 -50kg	14	-
Kumite Male U21 +84kg	20	-
Kumite Male U21 -60kg	27	-
Kumite Male U21 -67kg	32	-
Kumite Male U21 -75kg	30	-
Kumite Male U21 -84kg	18	-
Kumite female Cadets +61kg	28	-
Kumite female Cadets -61kg	44	-
Kumite female Juniors +66kg	19	-
Kumite female Juniors -66kg	28	-
Kumite female cadets -47kg	34	-
Kumite female cadets -54kg	40	-
Kumite female juniors -48kg	20	-
Kumite female juniors -53kg	30	-
Kumite female juniors -59kg	31	-
Kumite male Seniors Open Final	4	-
Kumite male cadets +70kg	30	-
Kumite male cadets -52kg	38	-
Kumite male cadets -57kg	35	-
Kumite male cadets -63kg	44	-
Kumite male cadets -70kg	31	-
Kumite male juniors +76kg	36	-
Kumite male juniors -55kg	31	-
Kumite male juniors -61kg	32	-
Kumite male juniors -68kg	38	-
Kumite male juniors -76kg	32	-
kata female U21	23	-
kata male U21	25	-
Totals:	1761	0

31ST KARATE GRAND PRIX CROATIA

CROATIA 2023.01.20 - 2023.01.22
CITY SPORTS HALL SAMOBOR, ANDRIJE HEBRANGA 26A, SAMOBOR, CROATIA

Officials Registration

Coach

Karate-Do Weiz(Karate-Do Weiz)					
1	OL/0309/AC RC	AUT	Günter	List	Coach

Entries: 1

LZ KARATE NIEDERÖSTERREICH(LZKNÖ)					
2		AUT	Filis	CELO	Coach

Entries: 1

National Karate Federation(NKF)					
3		AZE	Ranad	Aliyev	Coach
4		AZE	Anar	Allahverdiyev	Coach
5		AZE	Rovshan	Allahverdiyev	Coach
6		AZE	Shahin	Atamov	Coach
7		AZE	Eishan	Khamoyev	Coach
8		AZE	Naghi	Mehdiyev	Coach

Entries: 6

KARATE AKADEMIJA - ARNELA ODŽAKOVIĆ(KARATE AKADEMIJA - ARNELA ODŽAKOVI..)					
9		BIH	Emina	Medic	Coach
10		BIH	Arnella	Odzakovic	Coach

Entries: 2

Karate klub DO Tuzla(KK DO Tuzla)					
11		BIH	Anto	Kresic	Coach
12		BIH	Stefani	Kresic	Coach

Entries: 2

Karate Klub Energija(Energija)					
13		BIH	Branko	Derajić	Coach
14		BIH	Saša	Pejić	Coach

Entries: 2

Karate klub Kumite(KK KUMITE Jajce)					
15		BIH	Ante	Katic	Coach
16		BIH	Tomislav	Katic	Coach

Entries: 2

Karate klub Posušje(KK Posušje)					
17		BIH	Marko	Čamber	Coach

Entries: 1

Karate klub Rašid Buća(K.K Rašid Buća)					
18		BIH	Adin	Balta	Coach
19		BIH	Raif	Buća	Coach

Entries: 2

Karate Klub Regeneracija(KK Regeneracija)					
20		BIH	Mirzet	Beganović	Coach
21		BIH	Adis	Salkić	Coach

Entries: 2

KARATE KLUB RESPECT(KK RESPECT)					
22		BIH	TEODORA	PERIĆ	Coach
23		BIH	NERMIN	POTUR	Coach

31ST KARATE GRAND PRIX CROATIA

CROATIA 2023.01.20 - 2023.01.22
CITY SPORTS HALL SAMOBOR, ANDRIJE HEBRANGA 26A, SAMOBOR, CROATIA

Officials Registration

Entries: 2

Karate klub Sambon - Vogosca(KK Sambon - Vogosca)					
24	bih133	BIH	Kenan	Alikadic	Coach
25		BIH	Amer	Varajic	Coach

Entries: 2

Karate klub Sarajevo(KK Sarajevo)					
26		BIH	Amar	Hrapović	Coach

Entries: 1

Karate klub Slavija(KK Slavija)					
27	BiH 2532	BIH	Dejan	Vukadin	Coach

Entries: 1

Karate klub Sloboda Tuzla(KK Sloboda Tuzla)					
28		BIH	Tarik	Hamidovic	Coach

Entries: 1

Karate klub TEMPO(KK TEMPO)					
29		BIH	Mirza	Ibrahimović	Coach

Entries: 1

Karate klub Travnik GS-TMT(KK Travnim GS-TMT)					
30		BIH	Dina	Arnautović	Coach
31		BIH	Adnan	Arnautović	Coach

Entries: 2

KARATE KLUB TRENER-SENSEI TURIJA(KARATE KLUB SENSEI TURIJA)					
32		BIH	HALILOVIC	MEHMED	Coach

Entries: 1

Karate Klub Vezir(KK Vezir)					
33		BIH	Armin	Kovač	Coach
34	BIH2511	BIH	Arnes	Selman	Coach

Entries: 2

KARATE KLUB WINNER TUZLA(KK WINNER TUZLA)					
35		BIH	Lejla	Ferhatbegović-Dizdarević	Coach
36		BIH	Mirsada	Suljkanović-Selimović	Coach

Entries: 2

Karate klub Zanshin Banja Luka(KK Zanshin BL)					
37		BIH	Nusret	Gračan	Coach

Entries: 1

Karate klub Šampion(Kk Šampion)					
38		BIH	Dragiša	Jovanović	Coach

Entries: 1

KK BOSNJAK KONJIC(KK BOSNJAK KONJIC)					
39	*	BIH	Velija	Halilović	Coach

Entries: 1

KK Master Bugojno(Master)					
40		BIH	Amer	Gasal	Coach

Entries: 1

31ST KARATE GRAND PRIX CROATIA

CROATIA 2023.01.20 - 2023.01.22
CITY SPORTS HALL SAMOBOR, ANDRIJE HEBRANGA 26A, SAMOBOR, CROATIA

Officials Registration

KK Mladost Vitez(KK Mladost)					
41		BIH	Aldin	Adilovic	Coach
Entries: 1					
Klub borilačkih sportova Tuzla(KBS Tuzla)					
42		BIH	Fikret	Selman	Coach
Entries: 1					
Samuraj(KK Samuraj)					
43		BIH	Damir	Bander	Coach
44		BIH	Isat	Skenderović	Coach
Entries: 2					
Univerzitetski karate klub VRBAS Banja Luka(UKK VRBAS Banja Luka BiH)					
45		BIH	Boris	Jelicic	Coach
Entries: 1					
Karate Club Shuriken(SHURIKEN)					
46		BUL	Veselin	Dimitrov	Coach
Entries: 1					
DARIS(Sofia)					
47		BUL	Borislav	Ivanov	Coach
Entries: 1					
k.k. LEVSKI SPARTAK(LEVSKI)					
48	BUL 123	BUL	Angel	Stefanov	Coach
49		BUL	NIKOLAJ-KOLETO	STOQNOV	Coach
50		BUL	VLADISLAVA	STOYANOVA	Coach
Entries: 3					
Karate club Kaloyan(KK Kaloyan)					
51		BUL	Anton	Vasev	Coach
Entries: 1					
Ronin11 Sofia(Ronin11)					
52		BUL	Luchezar	Tsvetkov	Coach
Entries: 1					
SHIELD NOVI ISKAR - CSKA(SHIELD - CSKA)					
53		BUL	Pavel	Stoyanov	Coach
Entries: 1					
Файтърс-НСА(Fighters-NSA)					
54		BUL	Pavlin	Dishev	Coach
Entries: 1					
CBS PULA(CBS PULA)					
55		CRO	DUBRAVKO	KOLEC	Coach
Entries: 1					
ENPI RAB(ENPI rab)					
56		CRO	ZDRAVKO	NALETINA	Coach
57		CRO	ALBERTA	NALETINA	Coach
58		CRO	Dorijan	Naletina	Coach
Entries: 3					

31ST KARATE GRAND PRIX CROATIA

CROATIA 2023.01.20 - 2023.01.22
CITY SPORTS HALL SAMOBOR, ANDRIJE HEBRANGA 26A, SAMOBOR, CROATIA

Officials Registration

 GLOBUS ČAKOVEC(GLOBUS)					
59		CRO	Tomislav	Magdalenić	Coach
60		CRO	Filip	Novak	Coach
61		CRO	Dejan	Slukić	Coach
62		CRO	Mladen	Vizinger	Coach

Entries: 4

 HERCEGOVINA-ZAGREB(KKHZ)					
63		CRO	STJEPAN	BEŠENIĆ	Coach
64		CRO	Marin	Hrkac	Coach
65		CRO	Goran	Hrkać	Coach
66		CRO	Davor	Mrzak	Coach
67		CRO	Danijel	Vučić	Coach
68		CRO	Mario	Vučić	Coach
69		CRO	Robert	Šaravanja	Coach

Entries: 7

 Karate Akademija Osijek KAO(KAO)					
70		CRO	GORAN	MESIĆ	Coach

Entries: 1

 Karate Dojo Brač(Bushi)					
71		CRO	Jovan	Kostadinov	Coach

Entries: 1

 Karate klub 10.DAN(KK 10.DAN)					
72		CRO	Josip	Petković	Coach
73		CRO	Renato	Petrac	Coach

Entries: 2

 KARATE KLUB ALFA(KK ALFA)					
74		CRO	DAMIR	BARIĆ	Coach
75		CRO	MARIJANA	KIUK	Coach

Entries: 2

 Karate klub Champion Rijeka(CHAMPION RIJEKA)					
76		CRO	Ivana	Bebek	Coach
77		CRO	Zoran	Konevski	Coach
78		CRO	Neven	Martić	Coach
79		CRO	Rene	Pernuš	Coach

Entries: 4

 Karate klub CROHERC(CROHERC)					
80		CRO	Zarko	Planinic	Coach
81		CRO	Dalibor	Vučić	Coach

Entries: 2

 Karate klub Hrvatski Dragovoljac(KKHD)					
82		CRO	Žarko	Kraljević	Coach
83		CRO	Ivo	Naletilić	Coach
84		CRO	Ivan	Vukoja	Coach
85		CRO	Željka	Zrnetić_Hršak	Coach
86		CRO	Marko	Čamber	Coach
87		CRO	Ante	Čutura	Coach

Entries: 6

 KARATE KLUB HRVATSKI SOKOL OSIJEK(KK HRVATSKI SOKOL)					
--	--	--	--	--	--

31ST KARATE GRAND PRIX CROATIA

CROATIA 2023.01.20 - 2023.01.22
CITY SPORTS HALL SAMOBOR, ANDRIJE HEBRANGA 26A, SAMOBOR, CROATIA

Officials Registration

88	CRO	Zvonko	Biondić	Coach
----	-----	--------	---------	-------

Entries: 1

 KARATE KLUB IPON ZAGREB (KK IPON ZAGREB)				
89	CRO	Danil	Domdjoni	Coach
90	CRO	Dorotea	Rumenjak	Coach

Entries: 2

 Karate klub Kaptol Zagreb(Kaptol)				
91	CRO	Diana	Hecimovic	Coach

Entries: 1

 Karate klub Kostrena(KK Kostrena)				
92	CRO	Vanessa	Cvjetan Lozo	Coach
93	CRO	Laura	Fučik	Coach

Entries: 2

 KARATE KLUB KTC KRIZEVCI(KTC KRIZEVCI)				
94	CRO	Mario	Ban	Coach
95	CRO	Tomislav	Dvorski	Coach
96	CRO	GORAN	HABJANOVIĆ	Coach

Entries: 3

 Karate klub Metal - Jurdani(kkmetal_jurdani)				
97	CRO	Goran	Lučin	Coach
98	CRO	Fedor	Nalis	Coach

Entries: 2

 Karate klub Međimurje(KK Međimurje)				
99	CRO	Kristijan	Lesjak	Coach

Entries: 1

 Karate klub NEVERA(KK NEVERA)				
100	CRO	Filip	Grgurić	Coach
101	CRO	Ervin	Mohorovičić	Coach
102	CRO	Aja	Vukoja	Coach

Entries: 3

 Karate klub No Kachi(KKK)				
103	CRO	Tea	Ostojić	Coach

Entries: 1

 Karate Klub Novi Zagreb(KK Novi Zagreb)				
104	CRO	Goran	Jajtić	Coach

Entries: 1

 KARATE KLUB OMEGA(KK OMEGA)				
105	CRO	Hrvoje	Cebić	Coach

Entries: 1

 Karate klub Polet Zagreb(Polet Zagreb)				
106	CRO	Igor	Ljubanski	Coach
107	CRO	Marko	Šturlić	Coach

Entries: 2

 Karate klub Sakura Zagreb(SakuraZG)				
108	CRO	Luka	Čelan	Coach

31ST KARATE GRAND PRIX CROATIA

CROATIA
CITY SPORTS HALL SAMOBOR, ANDRIJE HEBRANGA 26A, SAMOBOR, CROATIA

2023.01.20 - 2023.01.22

Officials Registration

Entries: 1

Karate klub Stijena(KK Stijena)					
109		CRO	Goran	Štimac	Coach

Entries: 1

KARATE KLUB TEMPO(KK TEMPO)					
110		CRO	Vladimir	Borojević	Coach
111		CRO	Dora	Cvrtila	Coach
112		CRO	Zora	Vinčić	Coach

Entries: 3

Karate klub Tinjan(Tinjan)					
113		CRO	Goran	Matosevic	Coach

Entries: 1

Karate klub Varaždin(KK Varaždin)					
114		CRO	Esad	Garibović	Coach

Entries: 1

Karate klub Velika Gorica(VG)					
115		CRO	Goran	Živković	Coach

Entries: 1

Karate Klub Zrinski(KKZ)					
116		CRO	Marko	Opančar	Coach

Entries: 1

KK LOTOS ZAGREB(KK LOTOS)					
117		CRO	Radenko	Blagojevic	Coach
118		CRO	Mislav	Šćurić	Coach

Entries: 2

KK OPATIJA(Opatija)					
119		CRO	NEMANJA	DIVLJAN	Coach
120		CRO	DRAGUTIN	GALINA	Coach

Entries: 2

KK VIROVITICA(VIROVITICA)					
121		CRO	Maks	Šenjug	Coach
122		CRO	Josip	Škrablin	Coach
123		CRO	Matija	Škrablin	Coach

Entries: 3

Mladost(Mladost)					
124		CRO	Ivica	Barišec	Coach
125		CRO	Ivan	Brcković	Coach

Entries: 2

Okit Vodice(Okit)					
126		CRO	Dario	Karan	Coach
127		CRO	Dragan	Karan	Coach

Entries: 2

SLAVKO KRIVSKI TERMAL DARUVAR(HKK SKT DARUVAR)					
128		CRO	Vanja	Lončar	Coach

Entries: 1

31ST KARATE GRAND PRIX CROATIA

CROATIA 2023.01.20 - 2023.01.22
CITY SPORTS HALL SAMOBOR, ANDRIJE HEBRANGA 26A, SAMOBOR, CROATIA

Officials Registration

 Slavonski Brod (SB_CRO)					
129		CRO	Nenad	Horvat	Coach
130	CROV0021	CRO	Zdenko	Horvat	Coach

Entries: 2

 Itosu-kai Bosatsu(Bosatsu)					
131		DEN	Michael	Andersen	Coach
132		DEN	Jonas	andersen	Coach

Entries: 2

 Sportskarate.dk(SPD)					
133		DEN	Astamaja	Bath	Coach
134		DEN	Alexander	Bonderup	Coach
135		DEN	Noah	Kristensen	Coach
136		DEN	Trine	Kristensen	Coach

Entries: 4

 TEAM OSCENDA KARATÉ(Team OSCENDA)					
137		FRA	Aymeric	Oscenda	Coach
138		FRA	Laurent	Oscenda	Coach
139		FRA	Shirak	Pogosyan	Coach

Entries: 3

 ΑΣ ΠΑΡΘΕΝΩΝ ΚΟΡΥΔΑΛΛΟΥ(526-ΧΑ08)					
140		GRE	ΚΑΤΕΡΙΝΑ	ΠΡΙΟΒΟΛΟΥ	Coach

Entries: 1

 ΑΣΑ ΣΟΤΟΚΑΝ ΚΑΡΑΤΕ(371-ΦΝ68)					
141		GRE	ΓΕΩΡΓΙΟΣ	ΤΖΑΝΟΣ	Coach

Entries: 1

 BVSC-Zugló(Bvsc)					
142		HUN	Nikola	Bartha	Coach

Entries: 1

 Bátaszék SE(BSE)					
143		HUN	Zoltán	Kovács	Coach
144		HUN	Noémi	Mendi	Coach
145		HUN	Akos	Nagy	Coach

Entries: 3

 DYNAMIC Karate Se(DYNAMIC KSE)					
146		HUN	Nikolett	Miklós	Coach

Entries: 1

 GASTROYAL SE(GASTROYAL SE)					
147		HUN	Zsuzsanna	Klima	Coach

Entries: 1

 Karate Klub Sportingbudo(Sportingbudo)					
148		HUN	Máté	Grécsi	Coach
149		HUN	Ottó	Horvath	Coach

Entries: 2

 MTK Budapest(MTK)					
150		HUN	Miklós	Papp	Coach

31ST KARATE GRAND PRIX CROATIA

CROATIA 2023.01.20 - 2023.01.22
CITY SPORTS HALL SAMOBOR, ANDRIJE HEBRANGA 26A, SAMOBOR, CROATIA

Officials Registration

Entries: 1

 Toriki Sportkarate Club Zalaegerszeg(TORIKI)					
151		HUN	Virag Vivien	Takács	Coach

Entries: 1

 Diamond International Dojo(Diamond International Dojo)					
152		IND	Kimti	Lal	Coach

Entries: 1

 SURINDER SALARIA(SURINDER SALARIA)					
153		IND	Rakesh	Kumar	Coach

Entries: 1

 Azkokai Makabi Bat-yam(Azkokai Makabi Bat-yam)					
154		ISR	vugar	gardashov	Coach
155		ISR	Emanuel	Kimyagarov	Coach

Entries: 2

 israel meitar wcsk(md)					
156		ISR	motti	ashkenazi	Coach

Entries: 1

 JKS ISRAEL(JKSISR)					
157		ISR	Nimrod	Pinkus	Coach
158		ISR	NIR	YAEGER	Coach

Entries: 2

 S.I.K(yoel)					
159		ISR	yoel	benaroché	Coach

Entries: 1

 SHINDOKAN MACCABI ISRAEL (shindokan)					
160		ISR	YONATAN	KUTERMAN	Coach
161		ISR	EFFI	MOSHAYEV	Coach
162		ISR	Albert	Vaideslaver	Coach

Entries: 3

 Club Desert Star Karate(Ikws)					
163	Ward	ISR	Ward	Abo_qwadr	Coach

Entries: 1

 A.s.d Centro Sport(A.s.d Centro Sport)					
164		ITA	Comparin	Loris	Coach

Entries: 1

 A.S.D ELAN KARATE TEAM(A.S.D ELAN)					
165		ITA	Antonio	Marino	Coach

Entries: 1

 A.S.D. ACADEMIA HYDRA(HYDRA KARATE LAB)					
166		ITA	ANTONIO	ANDREETTO	Coach

Entries: 1

 A.S.D. Asi Karate Veneto(Asi Karate Veneto)					
167		ITA	Massimiliano	Cervesato	Coach
168		ITA	Lucrezia	Levorato	Coach

31ST KARATE GRAND PRIX CROATIA

CROATIA 2023.01.20 - 2023.01.22
CITY SPORTS HALL SAMOBOR, ANDRIJE HEBRANGA 26A, SAMOBOR, CROATIA

Officials Registration

169		ITA	Stefano	Nioli	Coach
170		ITA	Alice	Pedron	Coach
171		ITA	Sarah	Sarlo	Coach
172		ITA	Filippo	Scapin	Coach
173		ITA	Alberto	Vardiero	Coach

Entries: 7

 A.S.D. Champion Center (Champion Center)					
174		ITA	Massimo	Portoghese	Coach

Entries: 1

 A.S.D. JISEI BUDO A.M.I.(ASD JISEI BUDO AMI)					
175		ITA	LUIGI	BELLOTTO	Coach
176		ITA	STEFANO	ROSINA	Coach

Entries: 2

 A.S.D. JOHNNYS KARATE BORGIO SISA(JOHNNYS KARATE)					
177	ITA 00229	ITA	MICHELA	NANNI	Coach

Entries: 1

 A.S.D. MABUNI CLUB CIVITAVECCHIA(mabuni)					
178		ITA	ENZO	IACOBELLI	Coach

Entries: 1

 A.S.D. Sen Shin Kai Rovigo(SSKR)					
179		ITA	Mario	Roversi	Coach

Entries: 1

 A.S.D. SHIZOKU KARATE AVELLINO(SHIZOKU KRT AV)					
180		ITA	Francesco	Accomando	Coach
181		ITA	Emilio	Fotino	Coach
182		ITA	Giulia	Silvestro	Coach
183		ITA	Andrea	Todaro	Coach

Entries: 4

 A.S.D. TEAM KARATE ARZACHENA(TEAM KARATE ARZACHENA)					
184		ITA	marco	cuccia	Coach

Entries: 1

 A.S.D. VILLA PIGNA KARATE(A.S.D. VILLA PIGNA KARATE)					
185		ITA	Federico	DAutorio	Coach
186		ITA	Magdalena Anna	DAutorio	Coach

Entries: 2

 ACADEMY PONTE DI PIAVE ASD(ASDK PDP)					
187		ITA	Enrico	Pigat	Coach

Entries: 1

 Accademia Karate Montevarchi A.S.D.(Acc. Karate Montevarchi)					
188		ITA	Edgardo	Artini	Coach
189		ITA	Letizia	Righeschi	Coach

Entries: 2

 ACSD BUDO LACASSIA torino(BudoLacassia)					
190		ITA	Vincenzo	LACASSIA	Coach

Entries: 1

31ST KARATE GRAND PRIX CROATIA

CROATIA
CITY SPORTS HALL SAMOBOR, ANDRIJE HEBRANGA 26A, SAMOBOR, CROATIA

2023.01.20 - 2023.01.22

Officials Registration

🇮🇹 Akashido(Akashido Palermo)						
191		ITA	Sascia	Pezzino	Coach	
						Entries: 1
🇮🇹 ASCD ATLANTIDE(ATLANTIDE TROINA)						
192		ITA	Franco	Pacino	Coach	
						Entries: 1
🇮🇹 ASD CENTRO STUDI KARATE NEGRAR(ASD CSK NEGRAR)						
193	2598	ITA	Marijan	Pecirep	Coach	
						Entries: 1
🇮🇹 ASD CLUB FUNAKOSHI(FUNAKOSHI)						
194		ITA	DOMENICO	AVERSA	Coach	
						Entries: 1
🇮🇹 ASD ESERCITO - 187° FOLGORE(ASD ESERCITO - 187 FOLGORE)						
195	2776/ACRC	ITA	ANTONIO	CITI	Coach	
196		ITA	Graziano	Ligas	Coach	
197		ITA	RICO	SIMONETTI	Coach	
						Entries: 3
🇮🇹 ASD EVER GREEN BOSCOREALE(ASD EVER GREEN BOSCOREALE)						
198		ITA	Luigi	Vitulano	Coach	
						Entries: 1
🇮🇹 ASD FC MOREVILLA(Asd Morevilla)						
199	435455	ITA	PAOLO	SIMONE	Coach	
						Entries: 1
🇮🇹 ASD Fitness Club Nuova Florida(12RM1604)						
200		ITA	Michele	Damato	Coach	
						Entries: 1
🇮🇹 ASD IPPON 2(I 2 K)						
201		ITA	Maurizio	Feggi	Coach	
						Entries: 1
🇮🇹 asd judo karate club(asd jk club)						
202		ITA	massimiliano	ferrarini	Coach	
						Entries: 1
🇮🇹 ASD KARATE 2001(K 01)						
203		ITA	Stefano	Rosina	Coach	
						Entries: 1
🇮🇹 ASD Karate club kanazawa(Kanazawa Cimadolmo)						
204		ITA	Lucia	Moras	Coach	
						Entries: 1
🇮🇹 ASD KARATE CLUB VALDOBBIADENE CROCETTA(ASD KARATE VALDO)						
205	ITA03165	ITA	PAOLO	MAZZALOVO	Coach	
206		ITA	SIMONE	REGINATO	Coach	
						Entries: 2
🇮🇹 ASD KARATE SACILE(KARATE SACILE)						

31ST KARATE GRAND PRIX CROATIA

CROATIA 2023.01.20 - 2023.01.22
CITY SPORTS HALL SAMOBOR, ANDRIJE HEBRANGA 26A, SAMOBOR, CROATIA

Officials Registration

207		ITA	ALESSANDRO	PAGOS	Coach
208		ITA	DANIELE	RAIMONDI	Coach

Entries: 2

asd KARATE TEAM 1999(KARATE TEAM 1999)

209		ITA	ALEX	DAEDER	Coach
210		ITA	linda	fumasoli	Coach

Entries: 2

ASD KEN KO PIOBESI(ASD KEN KO PIOBESI)

211		ITA	ROBERTO	MATTIS	Coach
-----	--	-----	---------	--------	-------

Entries: 1

ASD OKINAWA FIGHT(OKINAWA FIGHT ASD)

212		ITA	ALFONSO	CAROTENUTO	Coach
-----	--	-----	---------	------------	-------

Entries: 1

ASD REMBUKAN KARATE VILLASMUNDO(REMBUKAN VILLASMUNDO)

213		ITA	MARCELLO	DI_MARE	Coach
-----	--	-----	----------	---------	-------

Entries: 1

ASD SHOTOKAN ACIREALE(ACIREALE)

214		ITA	Giuseppe	Fichera	Coach
215		ITA	Federica	Saitta	Coach
216		ITA	Antonio	Torrisi	Coach

Entries: 3

ASD Shotokan Karate Pozzuolo del Friuli(SKZP)

217		ITA	GIOVANNI	CARRARIA	Coach
218		ITA	ALBERTO	PAVAN	Coach
219		ITA	PAOLO	ZAINA	Coach

Entries: 3

ASD TALARICO KARATE TEAM APS(TKT)

220		ITA	MASSIMILIANO	CALDERAZZO	Coach
221		ITA	MATTEO	PUPPO	Coach
222	ITAV0031	ITA	GENNARO	TALARICO	Coach

Entries: 3

ASD TEAM KARATE LADISPOLI(ASD TEAM KARATE LADISPOLI)

223		ITA	VINCENZO	RICCARDI	Coach
-----	--	-----	----------	----------	-------

Entries: 1

Asd team karate Scata(Tks)

224		ITA	Luigi	Scata	Coach
-----	--	-----	-------	-------	-------

Entries: 1

Asd_Dinamo_Karate_2015(Dinamo Karate 2015)

225		ITA	paolo	lovisa	Coach
226		ITA	valentina	scillia	Coach

Entries: 2

ass.naz.carab. capasso1(ass.naz.carab. capasso1)

227		ITA	nicola	capasso	Coach
-----	--	-----	--------	---------	-------

Entries: 1

BERRETTONI FEDERICO(ROMA 12)

31ST KARATE GRAND PRIX CROATIA

CROATIA 2023.01.20 - 2023.01.22
CITY SPORTS HALL SAMOBOR, ANDRIJE HEBRANGA 26A, SAMOBOR, CROATIA

Officials Registration

228	ITA	FEDERICO	BERRETTONI	Coach	Entries: 1	
Bodymind Karate(Bodymind Karate)						
229	ITA	RICCARDO	MONTINI	Coach	Entries: 1	
Bushido Karate Perugia(BKP)						
230	ITA	Giovanni	Maurizi	Coach	Entries: 1	
CENTRO KARATE RIMINI(CKR)						
231	ITA	Livio	Montuori	Coach	Entries: 1	
CLUB ARTI ORIENTALI CANTU asd(CAO CANTU)						
232	ITA	DAVIDE	COLOMBO	Coach	Entries: 1	
CRS AKIYAMA Settimo(CRS AKIYAMA Settimo)						
233	ITA	Alfonso	Valente	Coach	Entries: 1	
Evolution Team Karate(ETK)						
234	ITA	Alessandro	Presotto	Coach	Entries: 1	
FORZA E COSTANZA - BRESCIA(F & C)						
235	ITA	Mirco	Giuliani	Coach		
236	ITA	ANNA	GUERINI	Coach		
237	ITA	FILIPPO	LA NOCE	Coach	Entries: 3	
G.S.FF.OO. POLIZIA DI STATO(FF.OO. POLIZIA DI STATO)						
238	ITA	PAOLO	CARRACCILO	Coach	Entries: 1	
Karate Alto Vicentino (K. A. V.)						
239	ITA	Simone	Spinella	Coach		
240	ITA	Sofia_Abigail	Zaccaria	Coach	Entries: 2	
KARATE CLUB SAVONA (KCS - LIGURIA KARATE)						
241	ITA	CORRADO	BUSCAGLIA	Coach	Entries: 1	
KARATE DO TRIESTE(KARATE DO TRIESTE)						
242	ITA04538	ITA	ANNA	DEVIVI	Coach	Entries: 1
Karate Nakayama(Karate Nakayama)						
243	ITA	MICHELE	CORNOLO	Coach		
244	ITA	ALESSANDRA	HASANI	Coach	Entries: 2	
KARATE POZZUOLO(KARATE POZZUOLO)						
245	ITA	MARCO	CIVIDINI	Coach		

31ST KARATE GRAND PRIX CROATIA

CROATIA 2023.01.20 - 2023.01.22
CITY SPORTS HALL SAMOBOR, ANDRIJE HEBRANGA 26A, SAMOBOR, CROATIA

Officials Registration

Entries: 1

Karate Team Dolomiti(KTDolomiti)					
246		ITA	Vittorio	Moreno	Coach

Entries: 1

karate trento asd(ktn)					
247		ITA	Stefano	Capitanio	Coach

Entries: 1

MASTER RAPID SKF CBL(MASTER RAPID SKF CBL)					
248		ITA	Benedetto	Arnone	Coach
249		ITA	FRANCESCO	LANDI	Coach
250		ITA	FRANCESCO	MAFFOLINI	Coach
251		ITA	Andrea	PELAMATTI	Coach
252		ITA	CARLO	SANGALLI	Coach
253		ITA	Ferdinando	SARTIRANI	Coach
254		ITA	DARIO	ZANOTTI	Coach

Entries: 7

PRO-TEAM ASD(PRO-TEAM ASD)					
255		ITA	NICOLA	CIARLONI	Coach
256		ITA	PASQUALE	DI BARI	Coach

Entries: 2

RARI NANTES ALBANO(RARI NANTES B.)					
257		ITA	Fabio	Dambrosio	Coach
258		ITA	Christian	Losito	Coach
259		ITA	Francesco	Pietrini	Coach

Entries: 3

RENZI(RENZI)					
260		ITA	FRANCESCO	ALESSANDRONI	Coach

Entries: 1

RYUGIN CODROIPO(RYUGIN)					
261		ITA	ADRIANO	MARCOLEONI	Coach

Entries: 1

skorpion karate asd(skorpion karate asd)					
262		ITA	massimiliano	dominici	Coach

Entries: 1

Spazio Sport Forte dei Marmi(Spazio Sport)					
263		ITA	ELENA	LORENZONI	Coach
264	ITAV0300	ITA	GIANLUIGI	VENDRAMINI	Coach

Entries: 2

sport center messina(sc messina)					
265		ITA	ALDO	CAPRITTI	Coach

Entries: 1

SPORT TARGET (SPORT TARGET)					
266		ITA	Leonardo	Alberton	Coach
267		ITA	Paride	Bressan	Coach
268	ITAV0264	ITA	NIKI	MARDEGAN	Coach
269		ITA	FEDERICO	ZANON	Coach

31ST KARATE GRAND PRIX CROATIA

CROATIA
CITY SPORTS HALL SAMOBOR, ANDRIJE HEBRANGA 26A, SAMOBOR, CROATIA

2023.01.20 - 2023.01.22

Officials Registration

Entries: 4

SSD Polisportiva Ternana(karateterni)					
270		ITA	Giancarlo	Piccioni	Coach

Entries: 1

SSD Polisportiva Terraglio(Polisportiva Terraglio)					
271		ITA	Erica	Gatti	Coach

Entries: 1

team bartolo(bkt)					
272		ITA	Giuseppe	Bartolo	Coach
273		ITA	Giuseppe	Bartolo	Coach

Entries: 2

Team Karate Puleo Firenze(TKP)					
274		ITA	Francesco	Puleo	Coach
275		ITA	Rossano	Rubicondi	Coach

Entries: 2

TSKS BELLUNO(TSKS)					
276		ITA	Marco	Bacchilega	Coach

Entries: 1

UNIVERSAL CENTER(UC)					
277		ITA	Ciro	De francesco	Coach
278		ITA	Salvatore	Serino	Coach

Entries: 2

waves m13(waves)					
279		ITA	VINCENZO	SACCO	Coach

Entries: 1

World wellness karate Sorso(Wwkr Sorso)					
280		ITA	Fabio	Idini	Coach

Entries: 1

KOSOVA KARATE FEDERATION(KKF)					
281		KOS	HALIL	MAHALLA	Coach
282		KOS	QENDRIM	SHAQIRI	Coach

Entries: 2

BARS BALTI WKF(BARS BALTI)					
283		MDA	Victor	Capmoale	Coach

Entries: 1

Bottoni(BOTTONI)					
284		MKD	Dimitar	Ilievski	Coach

Entries: 1

KUSHTRIMI(K.K. Kushtrimi)					
285		MKD	Irfan	Alija	Coach

Entries: 1













RINIA MATEÇ(K.K. RINIA)					
286		MKD	Seful	Osmani	Coach

Entries: 1

31ST KARATE GRAND PRIX CROATIA

CROATIA 2023.01.20 - 2023.01.22
CITY SPORTS HALL SAMOBOR, ANDRIJE HEBRANGA 26A, SAMOBOR, CROATIA

Officials Registration

 Кизаме(Кизаме)					
287	Karate Klub Kizame	MKD	Dejan	Risteski	Coach
Entries: 1					
 Олимпик Спорт 2007 - Скопје(Олимпик Спорт 2007 - Скопје)					
288		MKD	Aleksandar	Kuzmanovski	Coach
289		MKD	Кристијан	Младеновски	Coach
Entries: 2					
 Спорт 94 - Прилеп(Спорт 94 - Прилеп)					
290		MKD	Petar	Belistojanoski	Coach
Entries: 1					
 Цветан Димов - Скопје(Цветан Димов - Скопје)					
291		MKD	Jovan	Lazarev	Coach
Entries: 1					
 k.k. Omladinac(k.k. Omladinac)					
292		MNE	Žarko	Raković	Coach
293		MNE	Tomislav	Skataric	Coach
Entries: 2					
 Karate klub ISKRA(KK ISKRA)					
294		MNE	Goran	Madic	Coach
295		MNE	Jelena	Simonovic	Coach
296		MNE	Vuk	Žarić	Coach
Entries: 3					
 KARATE KLUB PANTER(KK PANTER)					
297		MNE	Milka	Djuretic	Coach
298		MNE	Irena	Ilincic	Coach
Entries: 2					
 kkPotoci(Potoci)					
299	MNEV0020	MNE	Slavka	Maksimovic	Coach
300	MNEV0021	MNE	Ružica	Maksimovic	Coach
Entries: 2					
 Montenegro(Montenegro)					
301		MNE	ZARKO	RAKOVIC	Coach
Entries: 1					
 Budhanilkantha(Budhanilkantha)					
302		NEP	Jwari_lal	Khatri	Coach
Entries: 1					
 Nepal Gurkha Khukuri Martial Arts Association(Sports)					
303	A082	NEP	RAN_BAHADUR	BOGATI	Coach
Entries: 1					
 Crișul sport club Oradeaa(C. S. Crișul)					
304		ROU	Tünde_Mária	Mezei	Coach
305		ROU	Marius	Roșu	Coach
Entries: 2					

31ST KARATE GRAND PRIX CROATIA

CROATIA 2023.01.20 - 2023.01.22
CITY SPORTS HALL SAMOBOR, ANDRIJE HEBRANGA 26A, SAMOBOR, CROATIA

Officials Registration

KARATE KLUB BREŽICE(KARATE KLUB BREŽICE)					
306		SLO	DARKO	CICVARIĆ	Coach

Entries: 1

KARATE KLUB BUSHIDO, ROGASKA SLATINA(KK BUSHIDO)					
307		SLO	Irena	Horvat	Coach
308		SLO	Igor	Jordan	Coach
309		SLO	Tilen	Jordan	Coach

Entries: 3

Karate Klub Cerknica(KK Cerknica)					
310		SLO	Nataša	Mihelič	Coach

Entries: 1

Karate Klub Kolektor Idrija(KKK Idrija)					
311		SLO	Erin	Coralic	Coach
312		SLO	Petra	Zajc	Coach

Entries: 2

Karate Klub Kovinar Maribor(KK Kovinar Maribor)					
313		SLO	Darko	Zaric	Coach
314		SLO	Mateja	Zarič Bukovnik	Coach

Entries: 2

Karate klub Lev(kk Lev)					
315		SLO	Jan	Merc	Coach

Entries: 1

KARATE KLUB LJUBLJANA(KK LJUBLJANA)					
316		SLO	Matija	Matijević	Coach

Entries: 1

Karate klub Mawashi Postojna(KK Mawashi)					
317		SLO	Nejc	Bertoncelj	Coach
318		SLO	Tjaša	Bertoncelj	Coach

Entries: 2

Karate klub Polzela(KK Polzela)					
319		SLO	Luka	Deberšek	Coach

Entries: 1

KARATE KLUB POSTOJNA(KK POSTOJNA)					
320		SLO	DALIBOR	SUBOTIĆ	Coach

Entries: 1

Karate klub SEKI(KK Seki)					
321		SLO	ŠTEFKA ŠEKI	GOLAČ	Coach
322		SLO	ANTON	MAVSAR	Coach
323		SLO	GORAZD	TOMAŽIČ	Coach

Entries: 3

KARATE KLUB TRBOVLJE(TRBOVLJE)					
324		SLO	Blaž	Hribovšek	Coach
325		SLO	Miha	Kovačič	Coach
326		SLO	Jernej	Simerl	Coach

Entries: 3

31ST KARATE GRAND PRIX CROATIA

CROATIA 2023.01.20 - 2023.01.22
CITY SPORTS HALL SAMOBOR, ANDRIJE HEBRANGA 26A, SAMOBOR, CROATIA

Officials Registration

🇸🇮 KARATE KLUB VELENJE(KK VELENJE)					
327		SLO	ANINA	CESAR	Coach
328		SLO	NATALIJA ANASTAZIJA	KENDA	Coach
329		SLO	MAŠA	KENDA	Coach
330		SLO	DENIS	PAŠIĆ	Coach
331		SLO	CESAR	PIA	Coach

Entries: 5

🇸🇮 Karate sekcija TVD Partizan Ljutomer(Karate Ljutomer)					
332		SLO	Sašo	Rauter	Coach
333		SLO	Nina	Rauter	Coach

Entries: 2

🇸🇮 Klub borilnih veščin FIGHT CLUB SHONY(Klub BVFC SHONY)					
334		SLO	Sašo	Vaš	Coach
335		SLO	Mirna	Vaš	Coach

Entries: 2

🇸🇮 lovrenc na pohorju(lovrenc)					
336		SLO	ARNOLD	SKUHALA	Coach

Entries: 1

🇸🇮 SHOTOKAN KARATE KLUB OPLOTNICA(SKK OPLOTNICA)					
337		SLO	Jernej	Blatnik	Coach

Entries: 1

🇸🇮 ŠPORTNO DRUŠTVO GORICA(ŠD GORICA)					
338		SLO	RAJKO	MALINOVIĆ	Coach

Entries: 1

🇷🇸 Karate Academy Bushido(KA Bushido)					
339		SRB	Ivan	Kunevski	Coach

Entries: 1

🇷🇸 Karate klub Borac 021(KK Borac 021)					
340		SRB	Saša	Savić	Coach

Entries: 1

🇷🇸 Karate klub Poletarac(KKPoletarac)					
341	BKS-T00126	SRB	Dragana	Mladenović	Coach

Entries: 1

🇷🇸 Karate klub Zadrugar(Lazarevo)					
342		SRB	MILOŠ	ERIĆ	Coach

Entries: 1

🇷🇸 Karate klub Zandarmerija(KK Zandarmerija)					
343		SRB	KRSTIN	IGOR	Coach
344		SRB	Ognjen	Maric	Coach

Entries: 2

🇷🇸 Klub kontaktnih sportova Borac - Čačak(KKS Borac - Čačak)					
345		SRB	Milan	Laković	Coach
346		SRB	Božidar	Purić	Coach
347		SRB	Novica	Srećković	Coach

Entries: 3

31ST KARATE GRAND PRIX CROATIA

CROATIA
CITY SPORTS HALL SAMOBOR, ANDRIJE HEBRANGA 26A, SAMOBOR, CROATIA

2023.01.20 - 2023.01.22

Officials Registration

Skipper(Beograd)					
348		SRB	Bojana	Markovic	Coach
Entries: 1					
Studentski grad(Stg)					
349	SRBV0006	SRB	Goran	Scepanovic	Coach
Entries: 1					
karate klub Detva(kk.Detva)					
350		SVK	Dušan	Sloboda	Coach
Entries: 1					
Karate klub Dolný Kubín (KKDK)					
351		SVK	Peter	Dobák	Coach
Entries: 1					
Karate Klub Junior Prešov(KK-Junior Prešov)					
352		SVK	Marek	Jalowiczor	Coach
Entries: 1					
KARATE KLUB SHIHAN POPRAD(SHIHAN POPRAD)					
353		SVK	Ján	Glatz	Coach
354		SVK	Andrea	Glatzová	Coach
355		SVK	Peter	Husár	Coach
356		SVK	Tomáš	Hyben	Coach
Entries: 4					
MŠK Žiar nad Hronom(KK Žiar)					
357		SVK	Vojtech	Hudec	Coach
Entries: 1					
Tornado Karate team(KKTORNR)					
358		SVK	Daniel	Kvasnica	Coach
359		SVK	Erika	Kvasnicová	Coach
Entries: 2					
ŠK KARATE KACHI Nitra(KACHI)					
360		SVK	Martin	Elias	Coach
Entries: 1					
Alpha Sport Karate Club(ASC)					
361		UKR	Heorhii	Pitsul	Coach
362		UKR	Oleksandr	Serhieiev	Coach
Entries: 2					
Champion Karate Club(Champion Karate Club)					
363		UKR	HNAT	PAK	Coach
364	UKR 252	UKR	SERGII	PINCHUK	Coach
Entries: 2					
KARATE TEAM CONCORDIA(CONCORDIA)					
365		UKR	Oleh	Kinash	Coach
366		UKR	Danylo	KOLODIEZNYI	Coach
367		UKR	Savelii	Lobanov	Coach
368		UKR	Nazar	Rudakov	Coach
Entries: 4					

31ST KARATE GRAND PRIX CROATIA

CROATIA 2023.01.20 - 2023.01.22
CITY SPORTS HALL SAMOBOR, ANDRIJE HEBRANGA 26A, SAMOBOR, CROATIA

Officials Registration

Katana (Katana)					
369		UKR	OLEKSANDR	TONKOSHKUR	Coach

Entries: 1

Leader Team(Leader)					
370		UKR	Andrii	Lazorenko	Coach
371		UKR	Yevhenii	Pylypiuk	Coach

Entries: 2

Legion-Odessa(Legion-Odessa)					
372		UKR	Denis	Krylovskiy	Coach

Entries: 1

OKINAWA(oki)					
373		UKR	Vladimir	Holoveshko	Coach
374		UKR	Oleksii	Konovalov	Coach

Entries: 2

Tiger Team(Tiger Team)					
375		UKR	Dmytro	Negaturov	Coach
376		UKR	Igor	Negaturov	Coach
377		UKR	ANASTASIIA	STEPASHKO	Coach

Entries: 3

UNION TEAM(Union team)					
378		UKR	DENYS	KOPYTKO	Coach
379		UKR	ILLYA	NIKULIN	Coach

Entries: 2

Zakhyst karate club(Zakhyst)					
380		UKR	Kristina	Vienik	Coach

Entries: 1

31ST KARATE GRAND PRIX CROATIA

CROATIA 2023.01.20 - 2023.01.22
CITY SPORTS HALL SAMOBOR, ANDRIJE HEBRANGA 26A, SAMOBOR, CROATIA

Officials Registration

Officials

Officials					
National Karate Federation(NKF)					
381		AZE	Murtuzaliyev	Jamal	Officials
382		AZE	Telman	Karimov	Officials
Entries: 2					
GASTROYAL SE(GASTROYAL SE)					
383		HUN	István	Dr. Béres	Officials
Entries: 1					
A.S.D. ACADEMIA HYDRA(HYDRA KARATE LAB)					
384		ITA	Stefano	Beretta	Officials
Entries: 1					
ASD FC MOREVILLA(Asd Morevilla)					
385		ITA	SALVATORE	NARDACCIO	Officials
Entries: 1					
Кизаме(Кизаме)					
386		MKD	Aleksandar	Filipovski	Officials
Entries: 1					
Karateschool Fightin Nabil(KSFN, NED)					
387		NED	Melissa	Valk	Officials
Entries: 1					
Nepal Gurkha Khukuri Martial Arts Association(Sports)					
388	NP213480	NEP	Bipana	Sharma	Officials
Entries: 1					
KARATE KLUB VELENJE(KK VELENJE)					
389		SLO	Damjana	Rednak_Bekčič	Officials
Entries: 1					
Karate klub Poletarac(KKPoletarac)					
390		SRB	Goran	Arsić	Officials
Entries: 1					
Alpha Sport Karate Club(ASC)					
391		UKR	Volodymyr	Herehov	Officials
Entries: 1					

31ST KARATE GRAND PRIX CROATIA

CROATIA

2023.01.20 - 2023.01.22

CITY SPORTS HALL SAMOBOR, ANDRIJE HEBRANGA 26A, SAMOBOR, CROATIA

Officials Registration

Total Entries:**391**

KATA BOYS 10 YEARS

31ST KARATE GRAND PRIX CROATIA, CITY SPORTS HALL SAMOBOR, ANDRIJE HEBRANGA 26A, SAMOBOR, CROATIA, CRO

2023-01-22

Tatami
2 08:30

Pool
1/1

LUKOV ZAKHAR (KATANA)

ŠTEFANIČ VAL (KK VELENJE)

ŠTEFANIČ VAL (KK VELENJE) 027 Heian Sandan 4

025 Heian Shodan

TEKAVC ŽIGA (KK CERKNICA)

028 Heian Yondan 5

HAVRILIUK MARK (TIGER TEAM)

025 Heian Shodan 0

FAZLIĆ KAAAN (KK RESPECT)

026 Heian Nidan 2

MAVSAR TADEJ (KK SEKI)

027 Heian Sandan 3

CESAR JAN (KAPTOL)

028 Heian Yondan 1

CUPARA JAKOV (POTOCI)

027 Heian Sandan 1

NIKIFOROS MICHAIL (GR_482)

NIKIFOROS MICHAIL (GR_482) 027 Heian Sandan 0

026 Heian Nidan 4

ELIAS WASIM (J.S.S.K)

028 Heian Yondan 0

BERBIĆ IBRAHIM-DŽAN (KK VEZIR)

026 Heian Nidan 5

PAJAZETOVIĆ DANIS (KK REGENERACIJA)

026 Heian Nidan 1

PALKA PATRIK (SSK BA)

070 Pinan Shodan 4

TSEBRIL MAKSYM (KATANA)

0

ŠTEFANIČ VAL (KK VELENJE)

029 Heian Godan 0

Final

MAVSAR TADEJ (KK SEKI)

029 Heian Godan 5

MAVSAR TADEJ (KK SEKI)

029 Heian Godan 5

MAVSAR TADEJ (KK SEKI)

BERBIĆ IBRAHIM-DŽAN (KK VEZIR)

027 Heian Sandan 3

BERBIĆ IBRAHIM-DŽAN (KK VEZIR)

029 Heian Godan 0

PALKA PATRIK (SSK BA)

074 Pinan Godan 2



- | |
|-----------------------------------|
| 1. MAVSAR TADEJ (KK SEKI) |
| 2. BERBIĆ IBRAHIM-DŽAN (KK VEZIR) |
| 3. ŠTEFANIČ VAL (KK VELENJE) |
| 3. NIKIFOROS MICHAIL (GR_482) |
| 5. CESAR JAN (KAPTOL) |
| 5. PALKA PATRIK (SSK BA) |
| 7. FAZLIĆ KAAAN (KK RESPECT) |
| 7. ELIAS WASIM (J.S.S.K) |

Referees:			

KATA BOYS 11 YEARS

31ST KARATE GRAND PRIX CROATIA, CITY SPORTS HALL SAMOBOR, ANDRIJE HEBRANGA 26A, SAMOBOR, CROATIA, CRO

2023-01-22

Tatami
6 09:55

Pool
1/1

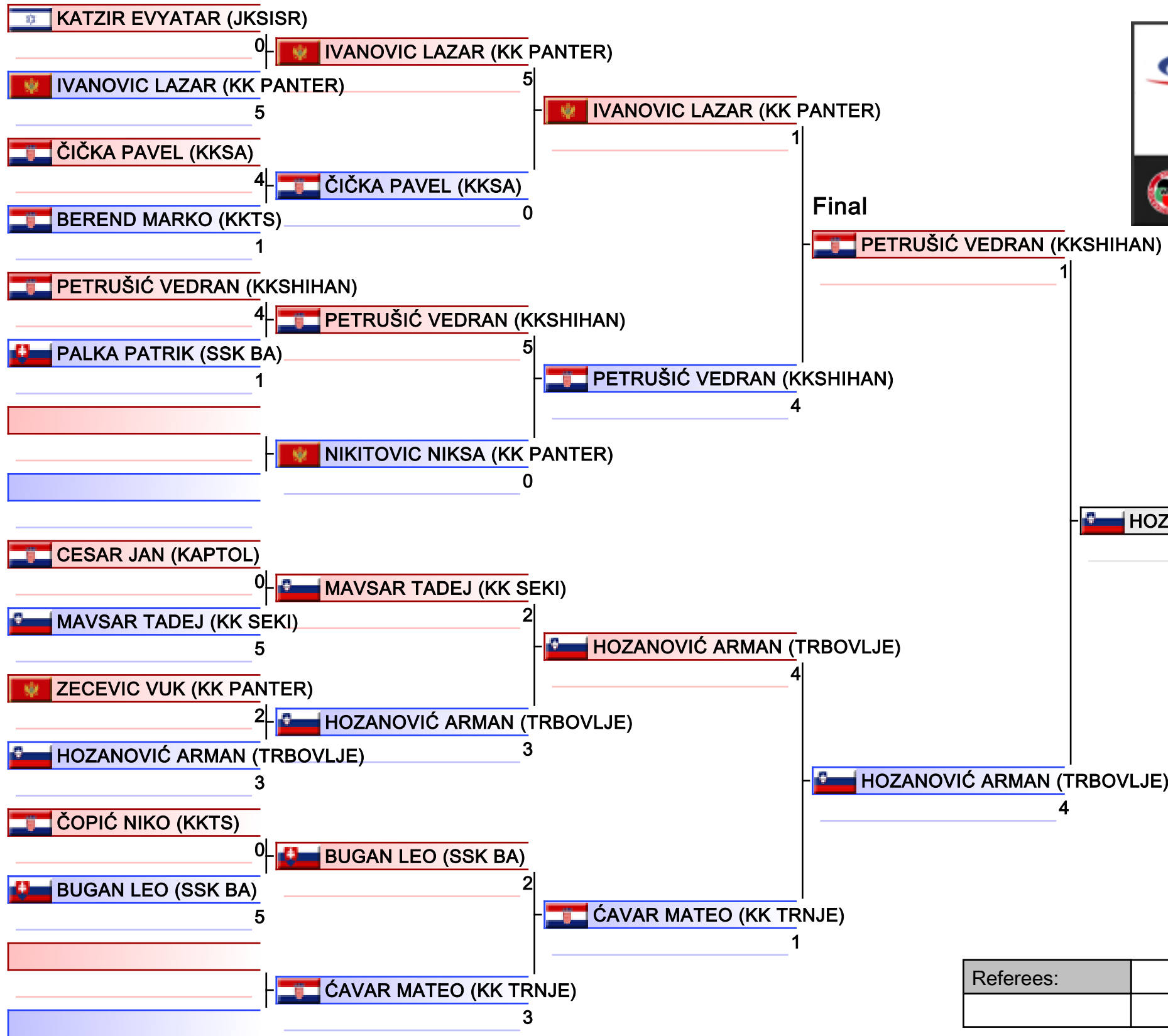

1. HOZANOVIĆ ARMAN (TRBOVLJE)
2. PETRUŠIĆ VEDRAN (KKSHIHAN)
3. IVANOVIC LAZAR (KK PANTER)
3. MAVSAR TADEJ (KK SEKI)
5. PALKA PATRIK (SSK BA)
5. ČAVAR MATEO (KK TRNJE)
7. NIKITOVIC NIKSA (KK PANTER)
7. ZECEVIC VUK (KK PANTER)

Referees:			

KATA BOYS 12 YEARS

31ST KARATE GRAND PRIX CROATIA, CITY SPORTS HALL SAMOBOR, ANDRIJE HEBRANGA 26A, SAMOBOR, CROATIA, CRO

2023-01-22

Tatami
4 08:30

Pool
1/1

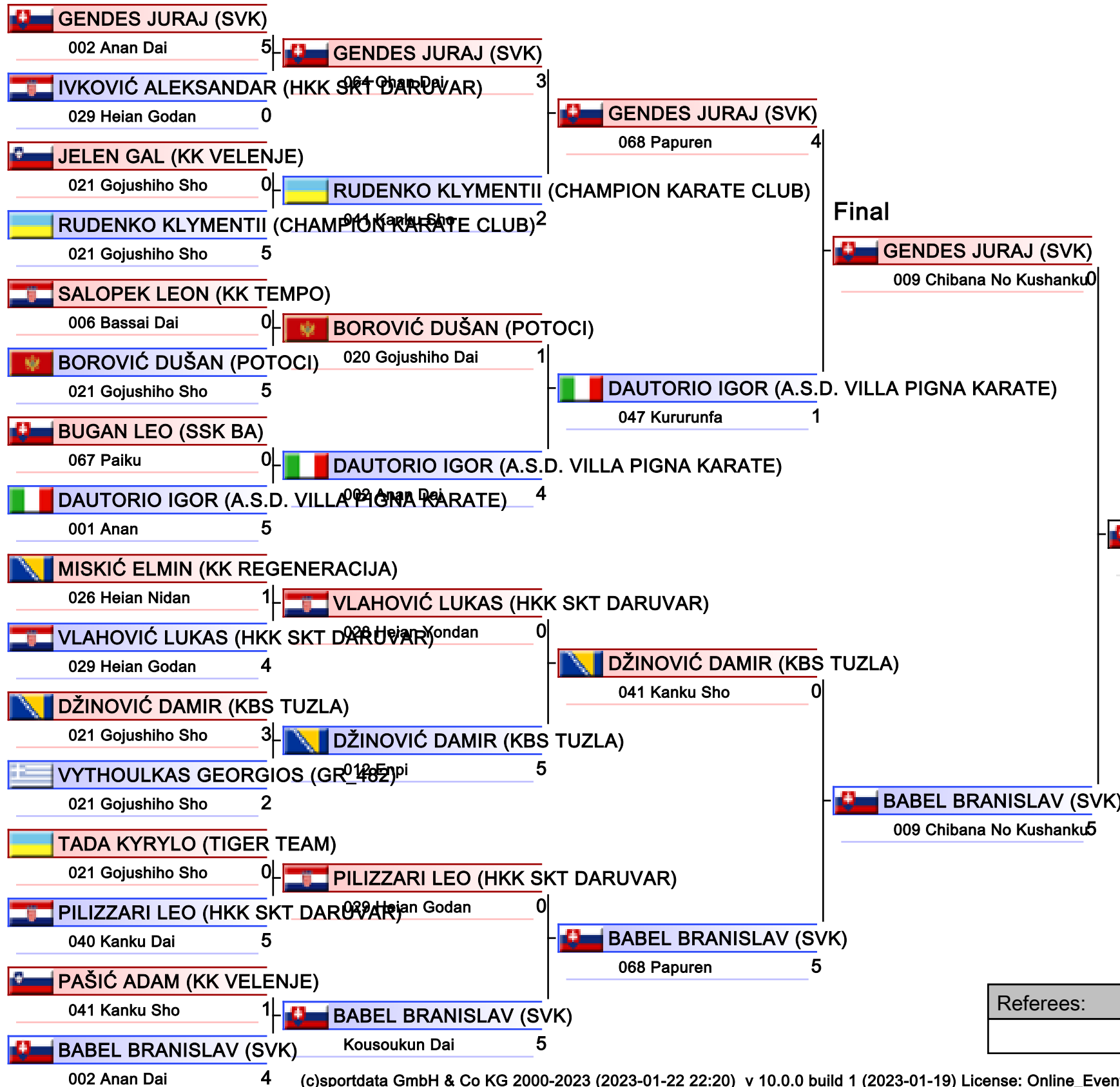

- | |
|--|
| 1. BABEL BRANISLAV (SVK) |
| 2. GENDES JURAJ (SVK) |
| 3. RUDENKO KLYMENTII (CHAMPION KARATE CLUB) |
| 3. DŽINOVIĆ DAMIR (KBS TUZLA) |
| 5. DAUTORIO IGOR (A.S.D. VILLA PIGNA KARATE) |
| 5. PAŠIĆ ADAM (KK VELENJE) |
| 7. IVKOVIĆ ALEKSANDAR (HKK SKT DARUVAR) |
| 7. PILIZZARI LEO (HKK SKT DARUVAR) |

Referees:			

KATA BOYS 13 YEARS

31ST KARATE GRAND PRIX CROATIA, CITY SPORTS HALL SAMOBOR, ANDRIJE HEBRANGA 26A, SAMOBOR, CROATIA, CRO

2023-01-22

Tatami
4 09:55

Pool
1/1

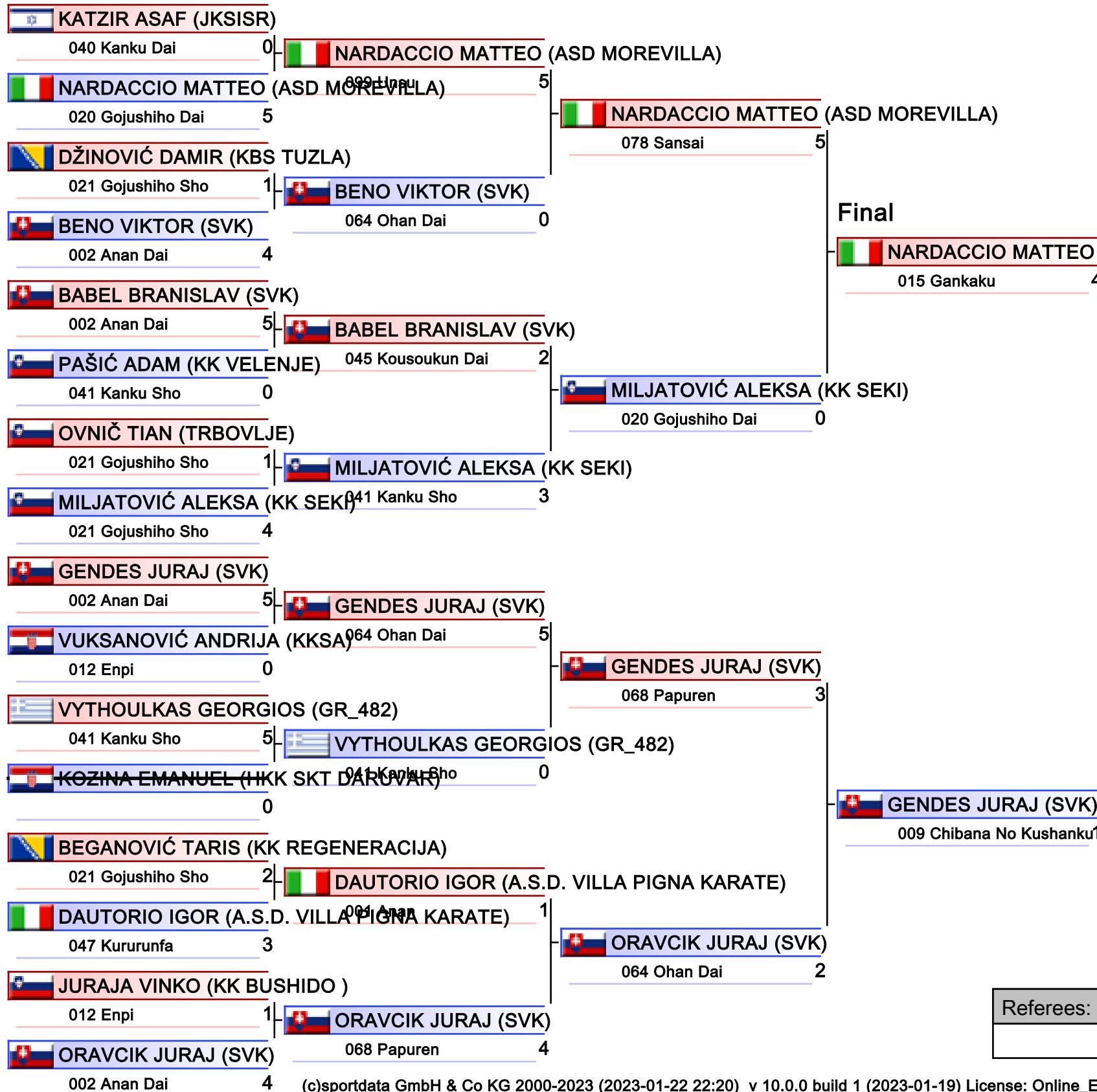

NARDACCIO MATTEO (ASD MOREVILLA)

1. NARDACCIO MATTEO (ASD MOREVILLA)
2. GENDES JURAJ (SVK)
3. MILJATOVIĆ ALEKSA (KK SEKI)
3. ORAVCIK JURAJ (SVK)
5. BENO VIKTOR (SVK)
5. VYTHOULKAS GEORGIOS (GR_482)
7. KATZIR ASAF (JKSISR)
7. VUKSANOVIĆ ANDRIJA (KKSA)

Referees:			

KATA BOYS 14 YEARS

31ST KARATE GRAND PRIX CROATIA, CITY SPORTS HALL SAMOBOR, ANDRIJE HEBRANGA 26A, SAMOBOR, CROATIA, CRO

2023-01-22

Tatami
6 08:30

Pool
1/1

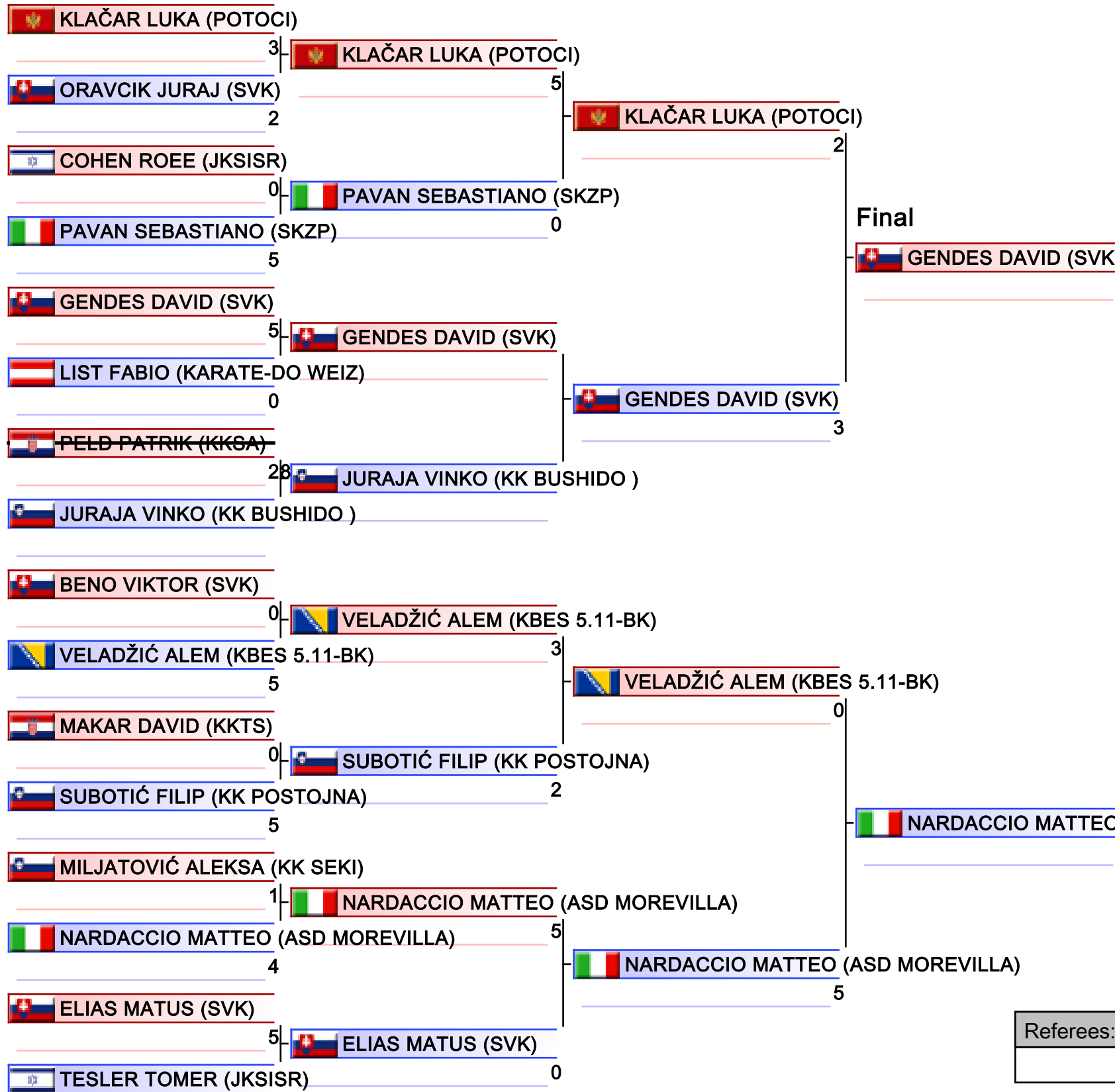

1. NARDACCIO MATTEO (ASD MOREVILLA)
2. GENDES DAVID (SVK)
3. KLAČAR LUKA (POTOCI)
3. VELADŽIĆ ALEM (KBES 5.11-BK)
5. JURAJA VINKO (KK BUSHIDO)
5. ELIAS MATUS (SVK)
7. LIST FABIO (KARATE-DO WEIZ)
7. MILJATOVIĆ ALEKSA (KK SEKI)

Referees:			

KATA BOYS 7 YEARS

31ST KARATE GRAND PRIX CROATIA, CITY SPORTS HALL SAMOBOR, ANDRIJE HEBRANGA 26A, SAMOBOR, CROATIA, CRO

2023-01-22

Tatami
1 09:30

Pool
1/1

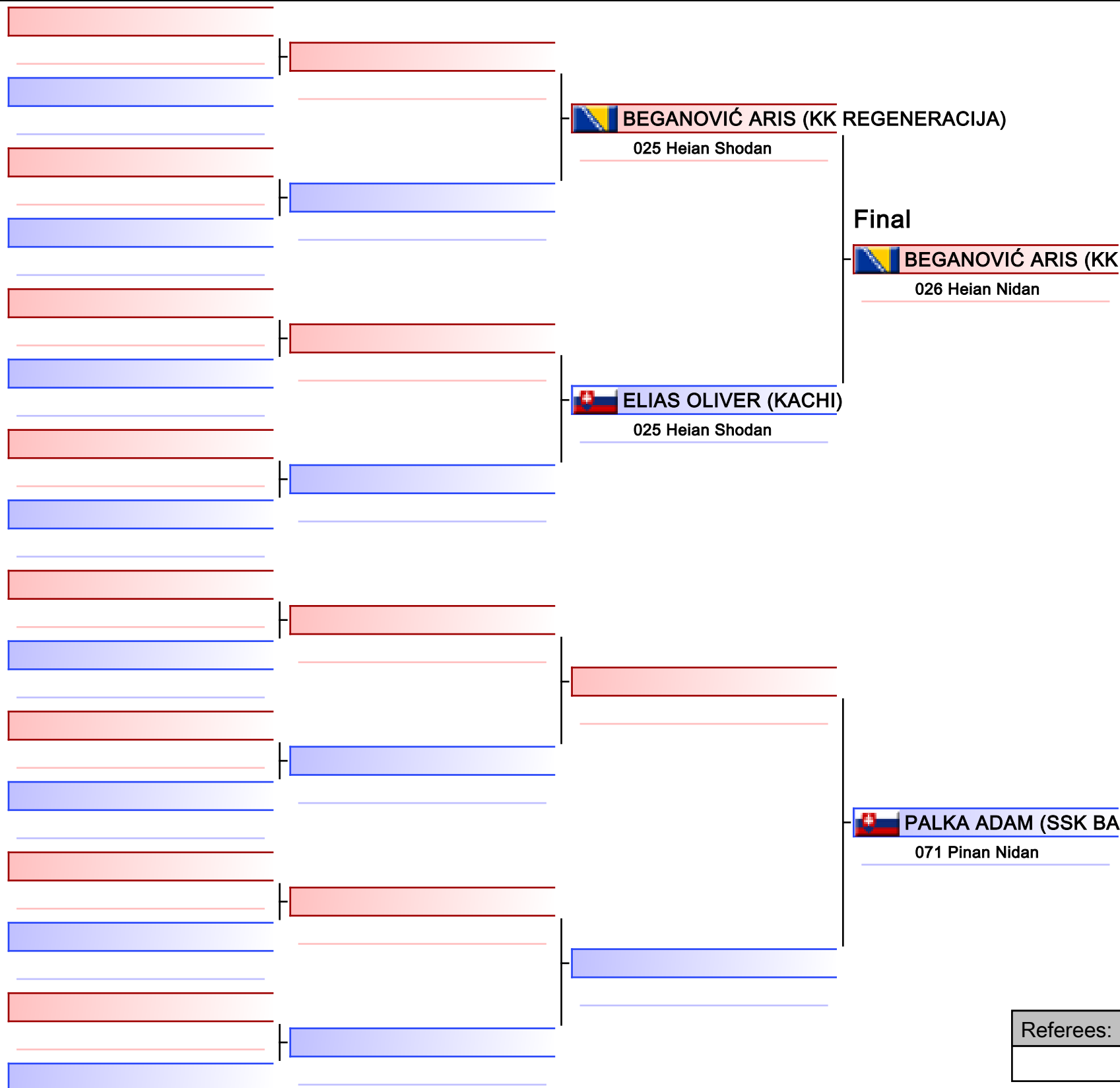

BEGANOVIĆ ARIS (KK REGENERACIJA)

1. BEGANOVIĆ ARIS (KK REGENERACIJA)
2. PALKA ADAM (SSK BA)
3. ELIAS OLIVER (KACHI)

Referees:			

KATA BOYS 8 YEARS

31ST KARATE GRAND PRIX CROATIA, CITY SPORTS HALL SAMOBOR, ANDRIJE HEBRANGA 26A, SAMOBOR, CROATIA, CRO

2023-01-22

Tatami
1 09:40

Pool
1/1

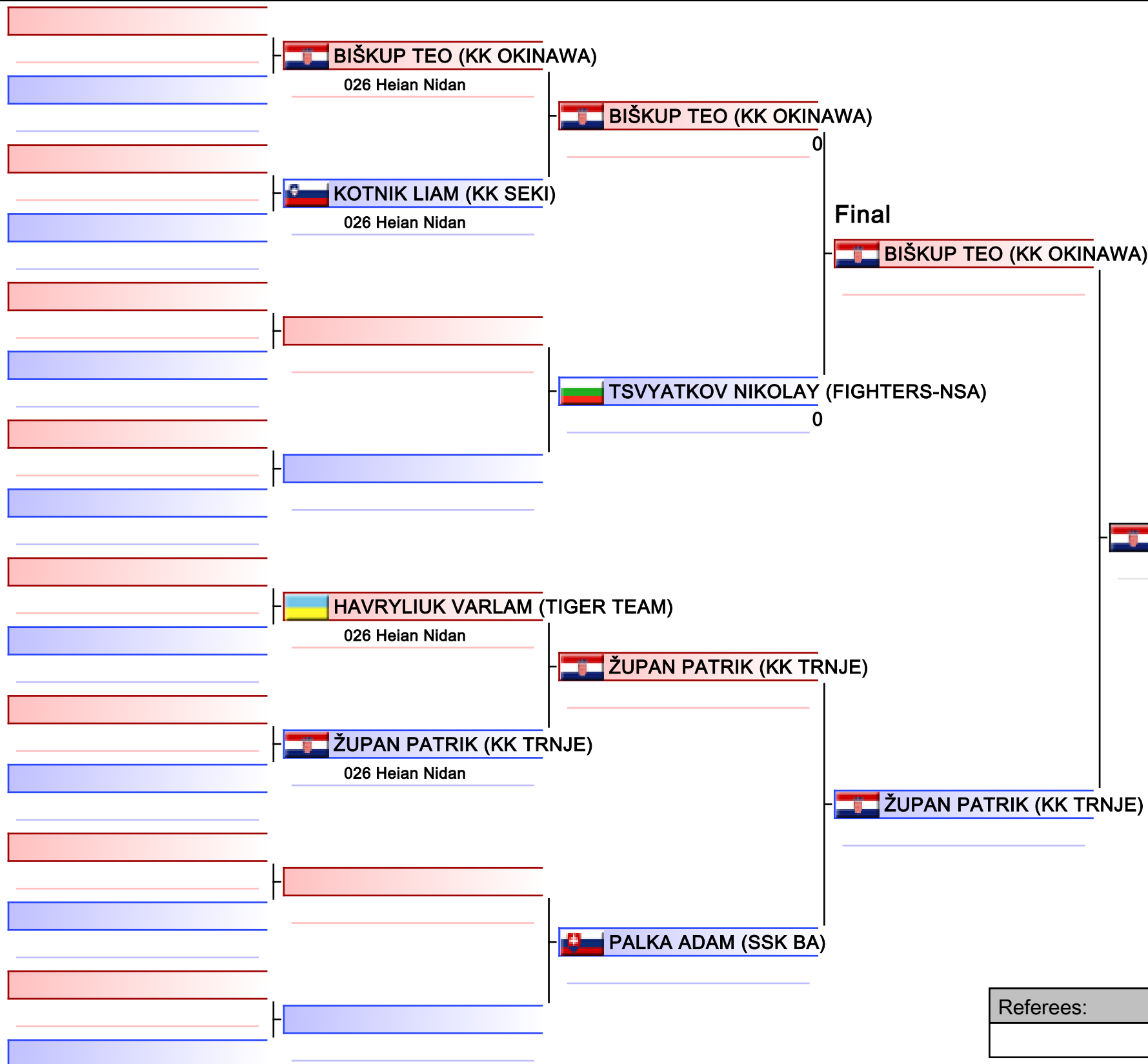

1. BIŠKUP TEO (KK OKINAWA)
2. ŽUPAN PATRIK (KK TRNJE)
3. KOTNIK LIAM (KK SEKI)
3. PALKA ADAM (SSK BA)
5. TSVYATKOV NIKOLAY (FIGHTERS-NSA)
5. HAVRYLIUK VARLAM (TIGER TEAM)

Referees:			

KATA BOYS 9 YEARS

31ST KARATE GRAND PRIX CROATIA, CITY SPORTS HALL SAMOBOR, ANDRIJE HEBRANGA 26A, SAMOBOR, CROATIA, CRO

2023-01-22

Tatami
2 10:05

Pool
1/1

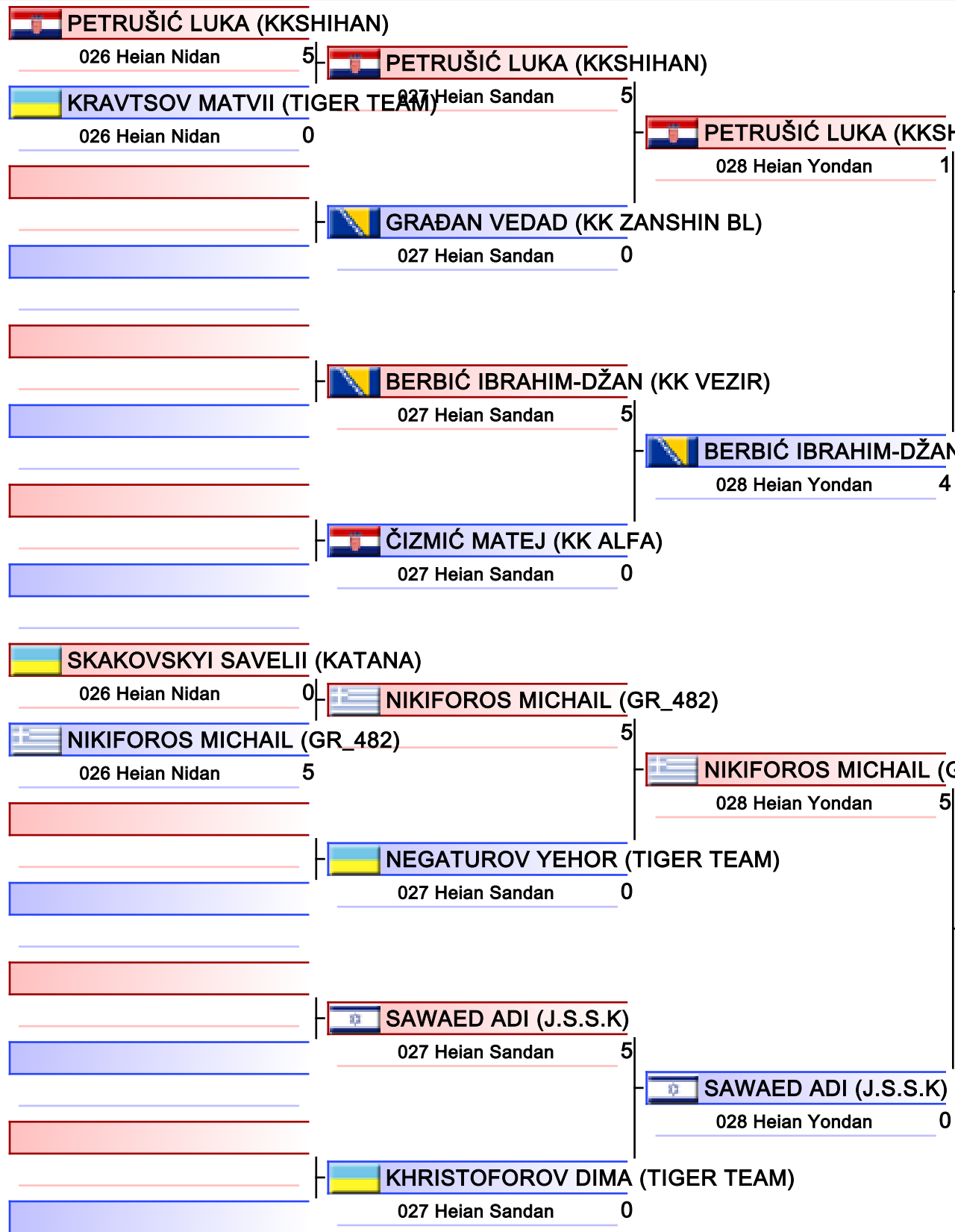

BERBIĆ IBRAHIM-DŽAN (KK VEZIR)

1. BERBIĆ IBRAHIM-DŽAN (KK VEZIR)
2. NIKIFOROS MICHAIL (GR_482)
3. SKAKOVSKYI SAVELII (KATANA)
3. PETRUŠIĆ LUKA (KKSHIHAN)
5. SAWAED ADI (J.S.S.K)
5. ČIZMIĆ MATEJ (KK ALFA)
7. NEGATUROV YEHOR (TIGER TEAM)

Referees:			

KATA GIRLS 10 YEARS

31ST KARATE GRAND PRIX CROATIA, CITY SPORTS HALL SAMOBOR, ANDRIJE HEBRANGA 26A, SAMOBOR, CROATIA, CRO

2023-01-22

Tatami
2 09:40

Pool
1/1

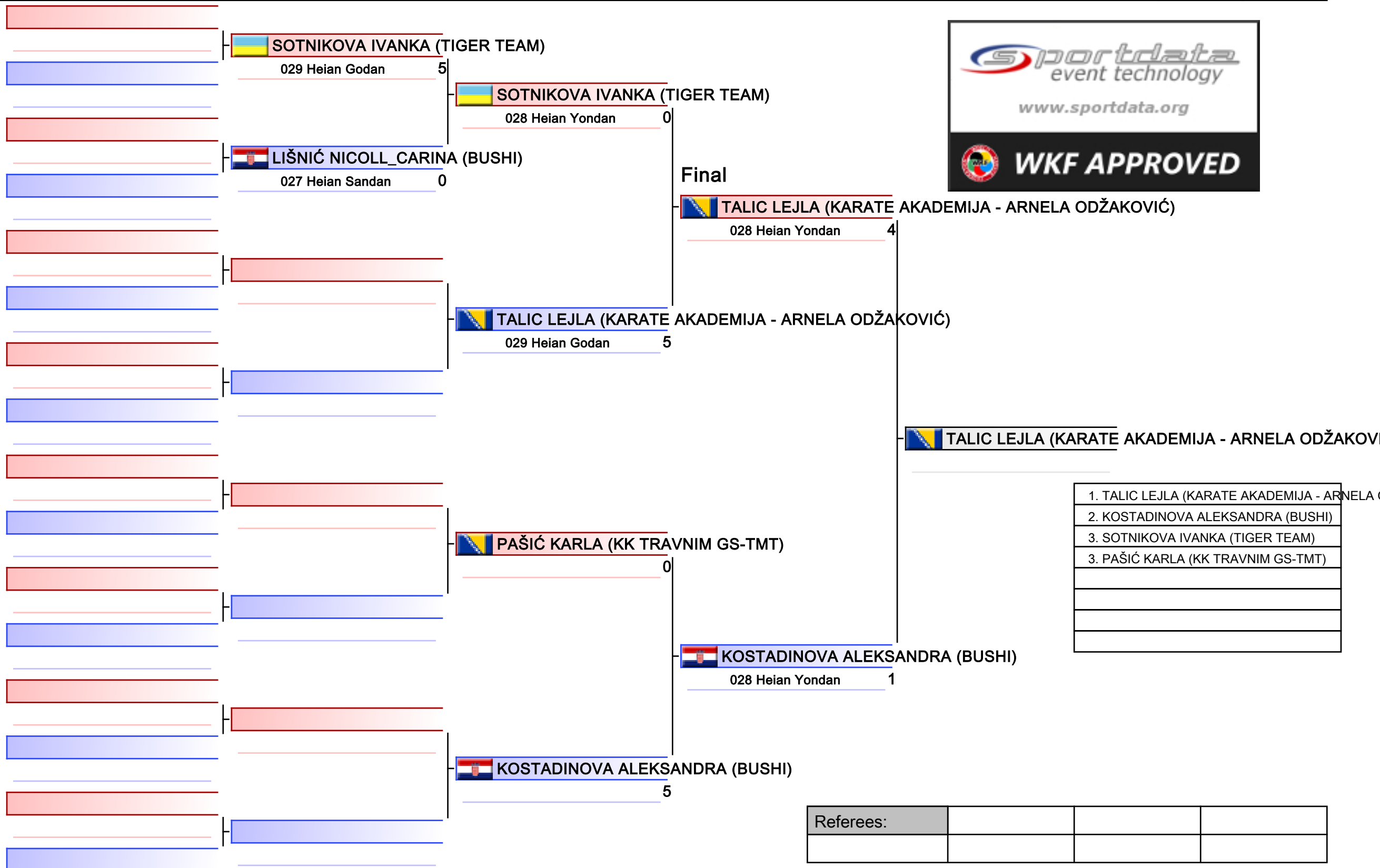

1. TALIC LEJLA (KARATE AKADEMIJA - ARNELA ODŽAKOVIĆ)
2. KOSTADINOVA ALEKSANDRA (BUSHI)
3. SOTNIKOVA IVANKA (TIGER TEAM)
3. PAŠIĆ KARLA (KK TRAVNIM GS-TMT)

Referees:			

KATA GIRLS 11 YEARS

31ST KARATE GRAND PRIX CROATIA, CITY SPORTS HALL SAMOBOR, ANDRIJE HEBRANGA 26A, SAMOBOR, CROATIA, CRO

2023-01-22

Tatami
5 10:10

Pool
1/1

 **HADZIC AZRA (KARATE AKADEMIJA - ARNELA ODŽAKOVIĆ)**
028 Heian Yondan 4

 **MESAREK ANJA (KK TRNJE)**
028 Heian Yondan 1

 **HADZIC AZRA (KARATE AKADEMIJA - ARNELA ODŽAKOVIĆ)**
029 Heian Godan 5

 **HADZIC AZRA (KARATE AKADEMIJA - ARNELA ODŽAKOVIĆ)**
012 Enpi 4

 **PISNIK GAJA (LOVRENC)**
029 Heian Godan 0

Final

 **HADZIC AZRA (KARATE AKADEMIJA - ARNELA ODŽAKOVIĆ)**
020 Gojushiho Dai 5

 **POŽGAJ VITA (KKSA)**
028 Heian Yondan 0

 **PRELEVIĆ LANA (KK ISKRA)**
012 Enpi 1

 **PRELEVIĆ LANA (KK ISKRA)**
026 Heian Nidan 5

 **HADZIC AZRA (KARATE AKADEMIJA - ARNELA ODŽAKOVIĆ)**

 **PHILIP SHIRA (JKSISR)**
028 Heian Yondan 0

 **ŠTURLIĆ MAŠA (POLET ZAGREB)**
029 Heian Godan 3

 **ŠTURLIĆ MAŠA (POLET ZAGREB)**
028 Heian Yondan 5

 **ŠTURLIĆ MAŠA (POLET ZAGREB)**
021 Gojushiho Sho 5

 **KRISTIĆ KAROLINA (KK SEKI)**
028 Heian Yondan 2

 **ŠTURLIĆ MAŠA (POLET ZAGREB)**
099 Unsu 0

 **BENKŐ NÓRA (MTK)**
026 Heian Nidan 5

 **BENKŐ NÓRA (MTK)**
075 Rohai 0

 **DETTORI SABRINA (TEAM KARATE ARZACHENA)**
029 Heian Godan 0



- | |
|--|
| 1. HADZIC AZRA (KARATE AKADEMIJA - ARNELA ODŽAKOVIĆ) |
| 2. ŠTURLIĆ MAŠA (POLET ZAGREB) |
| 3. MESAREK ANJA (KK TRNJE) |
| 3. KRISTIĆ KAROLINA (KK SEKI) |
| 5. PRELEVIĆ LANA (KK ISKRA) |
| 5. BENKŐ NÓRA (MTK) |
| 7. PISNIK GAJA (LOVRENC) |
| 7. PHILIP SHIRA (JKSISR) |

Referees:			

KATA GIRLS 12 YEARS

31ST KARATE GRAND PRIX CROATIA, CITY SPORTS HALL SAMOBOR, ANDRIJE HEBRANGA 26A, SAMOBOR, CROATIA, CRO

2023-01-22

Tatami
3 08:30

Pool
1/1

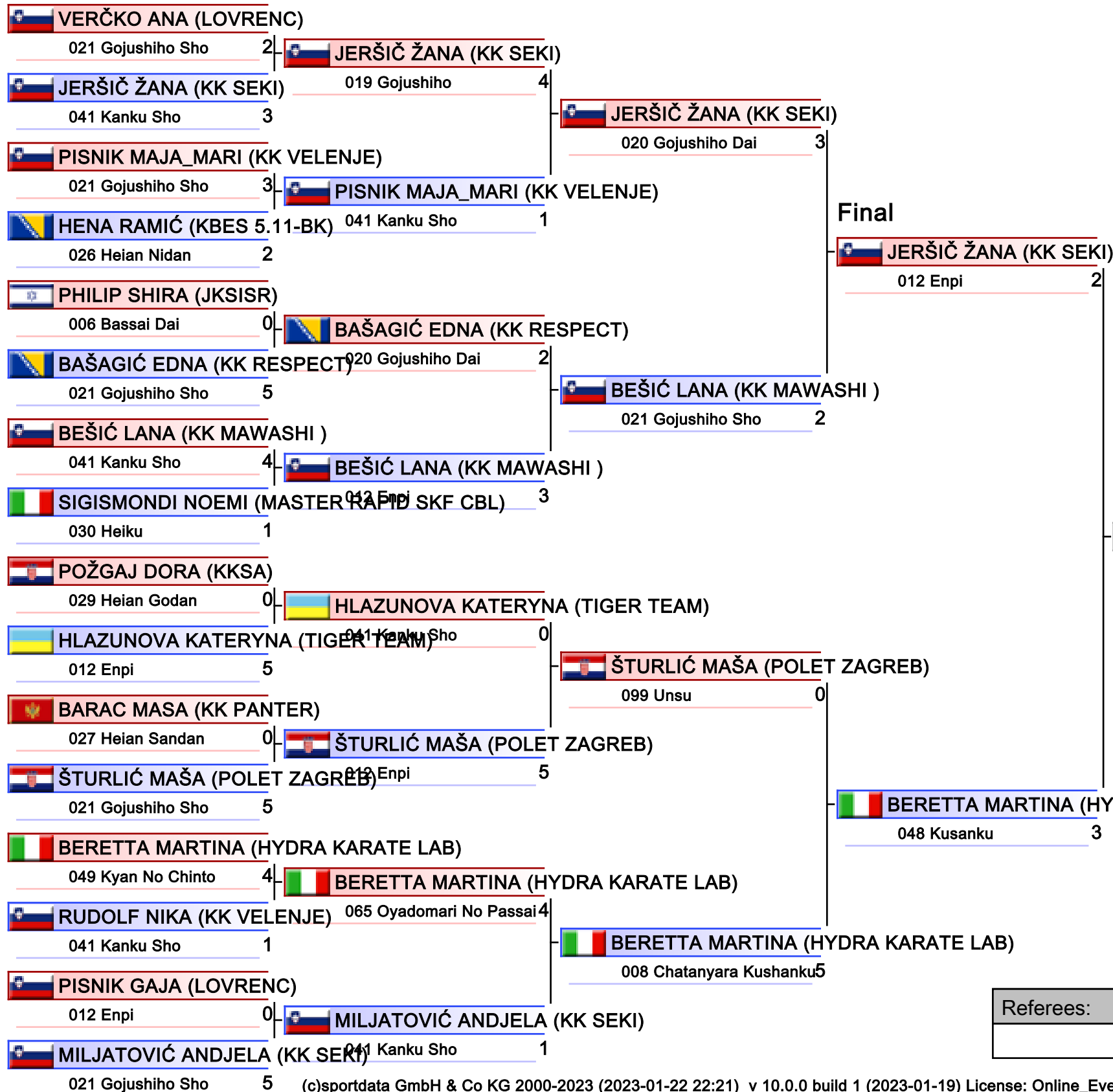

BERETTA MARTINA (HYDRA KARATE LAB)

- | |
|---------------------------------------|
| 1. BERETTA MARTINA (HYDRA KARATE LAB) |
| 2. JERŠIČ ŽANA (KK SEKI) |
| 3. PISNIK MAJA_MARI (KK VELENJE) |
| 3. MILJATOVIĆ ANDJELA (KK SEKI) |
| 5. BEŠIĆ LANA (KK MAWASHI) |
| 5. ŠTURLIĆ MAŠA (POLET ZAGREB) |
| 7. VERČKO ANA (LOVRENC) |
| 7. RUDOLF NIKA (KK VELENJE) |

Referees:			

KATA GIRLS 13 YEARS

31ST KARATE GRAND PRIX CROATIA, CITY SPORTS HALL SAMOBOR, ANDRIJE HEBRANGA 26A, SAMOBOR, CROATIA, CRO

2023-01-22

Tatami
3 09:55

Pool
1/1

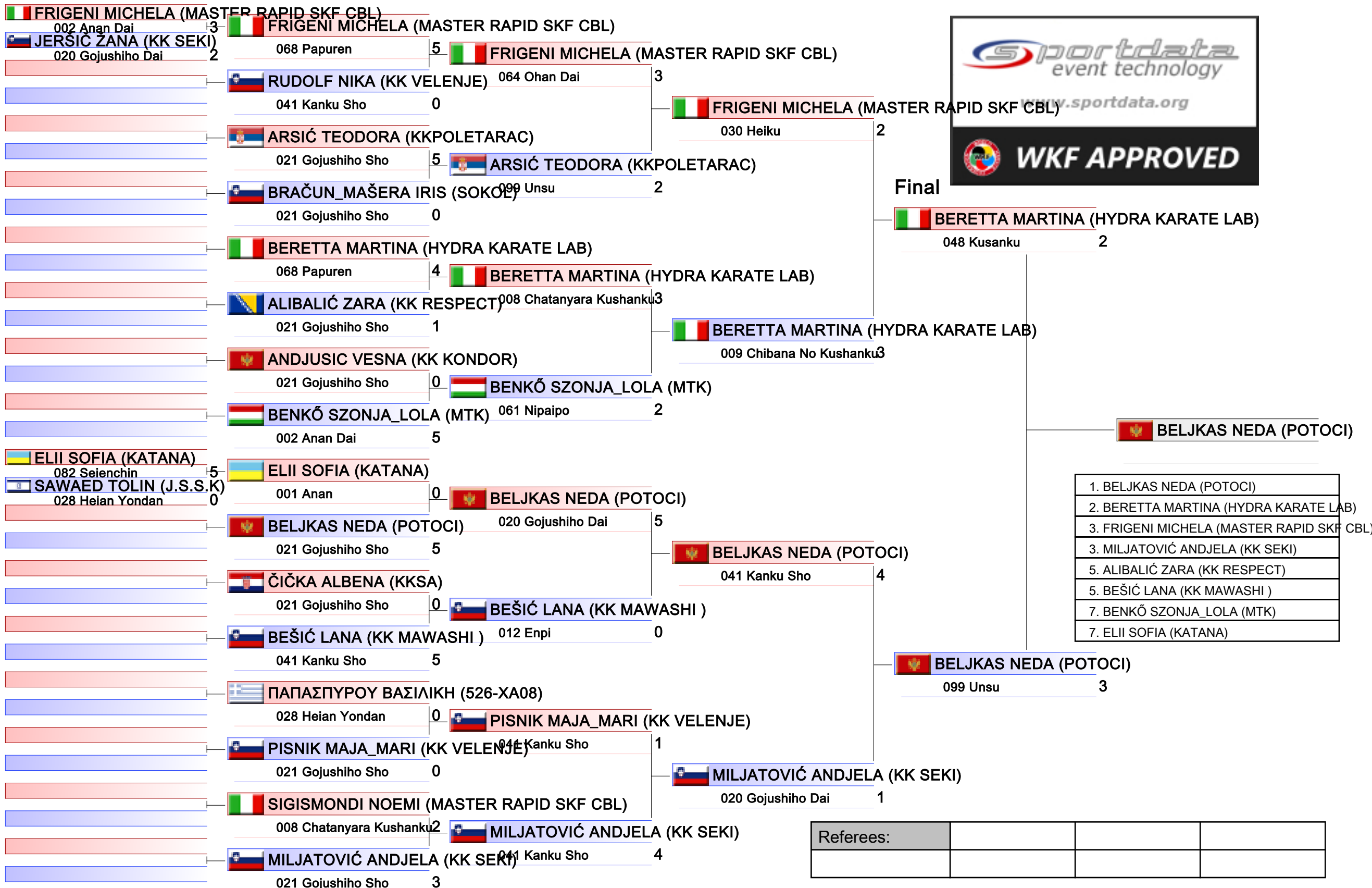

KATA GIRLS 14 YEARS

31ST KARATE GRAND PRIX CROATIA, CITY SPORTS HALL SAMOBOR, ANDRIJE HEBRANGA 26A, SAMOBOR, CROATIA, CRO

2023-01-22

Tatami
5 08:30

Pool
1/1

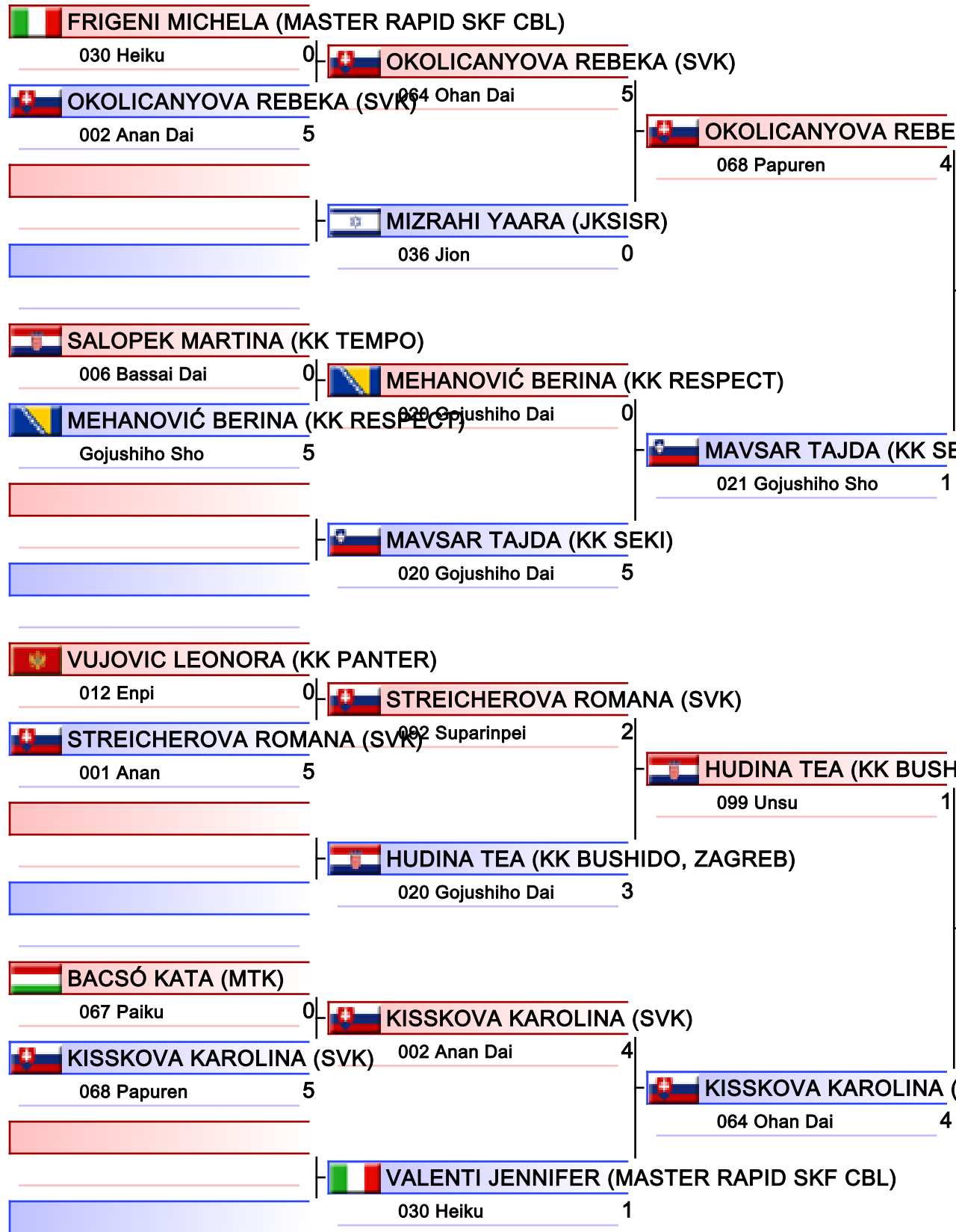

- | |
|--|
| 1. KISSKOVA KAROLINA (SVK) |
| 2. OKOLICANYOVA REBEKA (SVK) |
| 3. FRIGENI MICHELA (MASTER RAPID SKF CBL) |
| 3. HUDINA TEA (KK BUSHIDO, ZAGREB) |
| 5. MAVSAR TAJDA (KK SEKI) |
| 5. VALENTI JENNIFER (MASTER RAPID SKF CBL) |
| 7. MIZRAHI YAARA (JKSISR) |
| 7. BACSÓ KATA (MTK) |

Referees:			

KATA GIRLS 8 YEARS

31ST KARATE GRAND PRIX CROATIA, CITY SPORTS HALL SAMOBOR, ANDRIJE HEBRANGA 26A, SAMOBOR, CROATIA, CRO

2023-01-22

Tatami
5 09:40

Pool
1/1

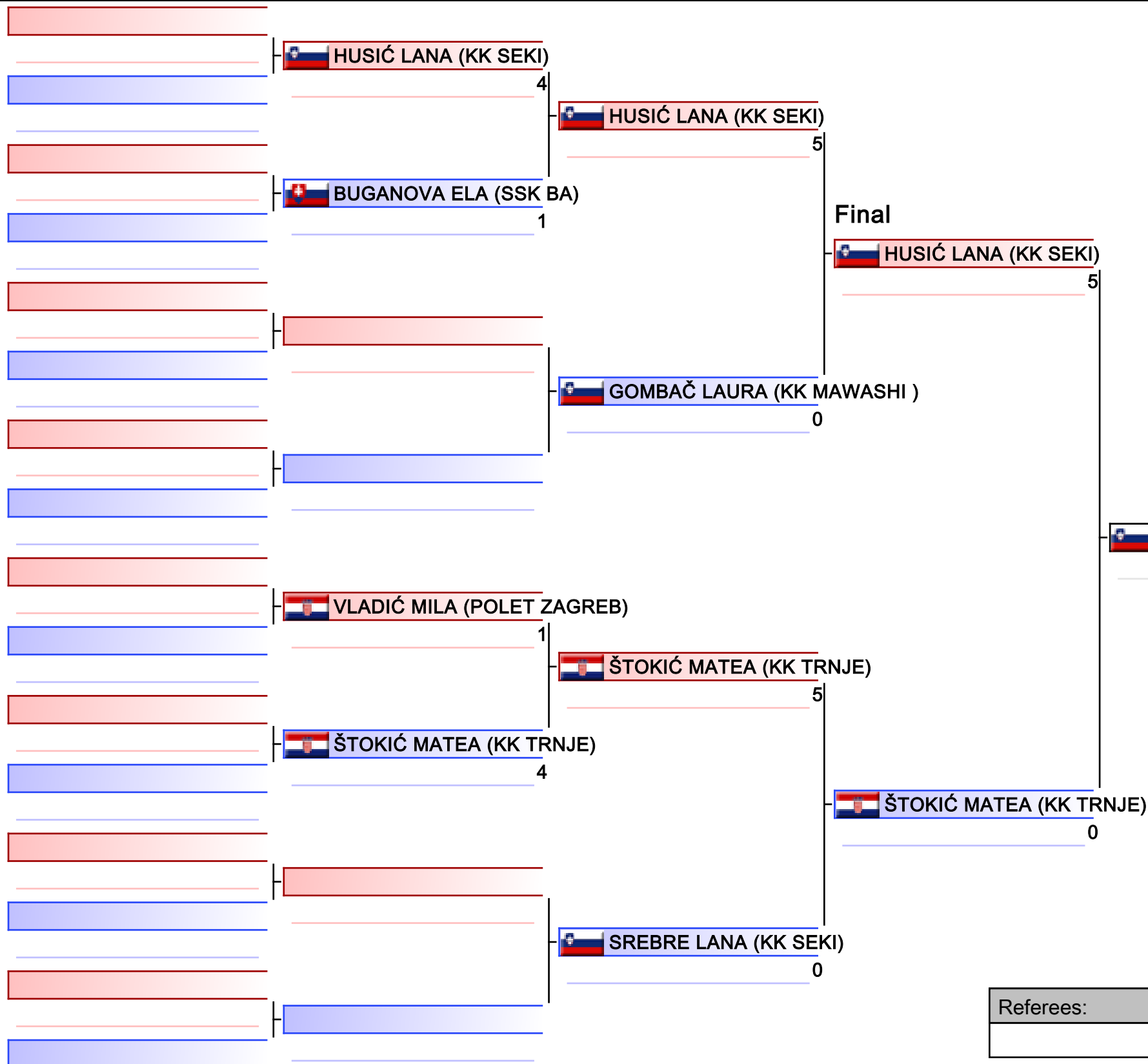

1. HUSIĆ LANA (KK SEKI)
2. ŠTOKIĆ MATEA (KK TRNJE)
3. VLADIĆ MILA (POLET ZAGREB)
3. BUGANOVA ELA (SSK BA)
5. SREBRE LANA (KK SEKI)
5. GOMBAČ LAURA (KK MAWASHI)

Referees:			

KATA GIRLS 9 YEARS

31ST KARATE GRAND PRIX CROATIA, CITY SPORTS HALL SAMOBOR, ANDRIJE HEBRANGA 26A, SAMOBOR, CROATIA, CRO

2023-01-22

Tatami
1 10:10

Pool
1/1

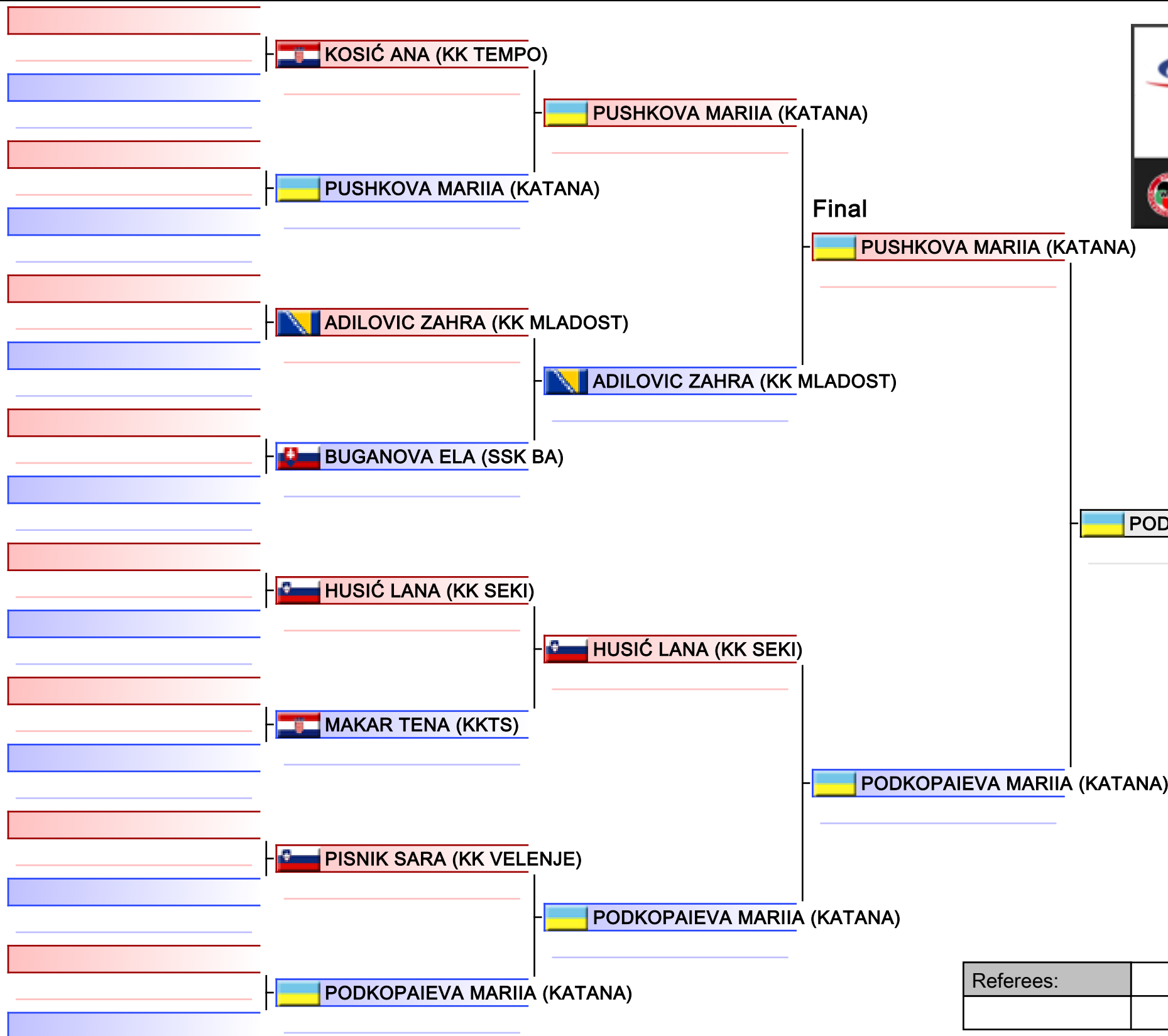

1. PODKOPAIEVA MARIIA (KATANA)
2. PUSHKOVA MARIIA (KATANA)
3. ADILOVIC ZAHRA (KK MLADOST)
3. HUSIĆ LANA (KK SEKI)
5. KOSIĆ ANA (KK TEMPO)
5. PISNIK SARA (KK VELENJE)

Referees:			

KUMITE BOYS 11-12 YEARS +54KG

31ST KARATE GRAND PRIX CROATIA, CITY SPORTS HALL SAMOBOR, ANDRIJE HEBRANGA 26A, SAMOBOR, CROATIA, CRO

2023-01-22

Tatami
1 16:50

Pool
1/1

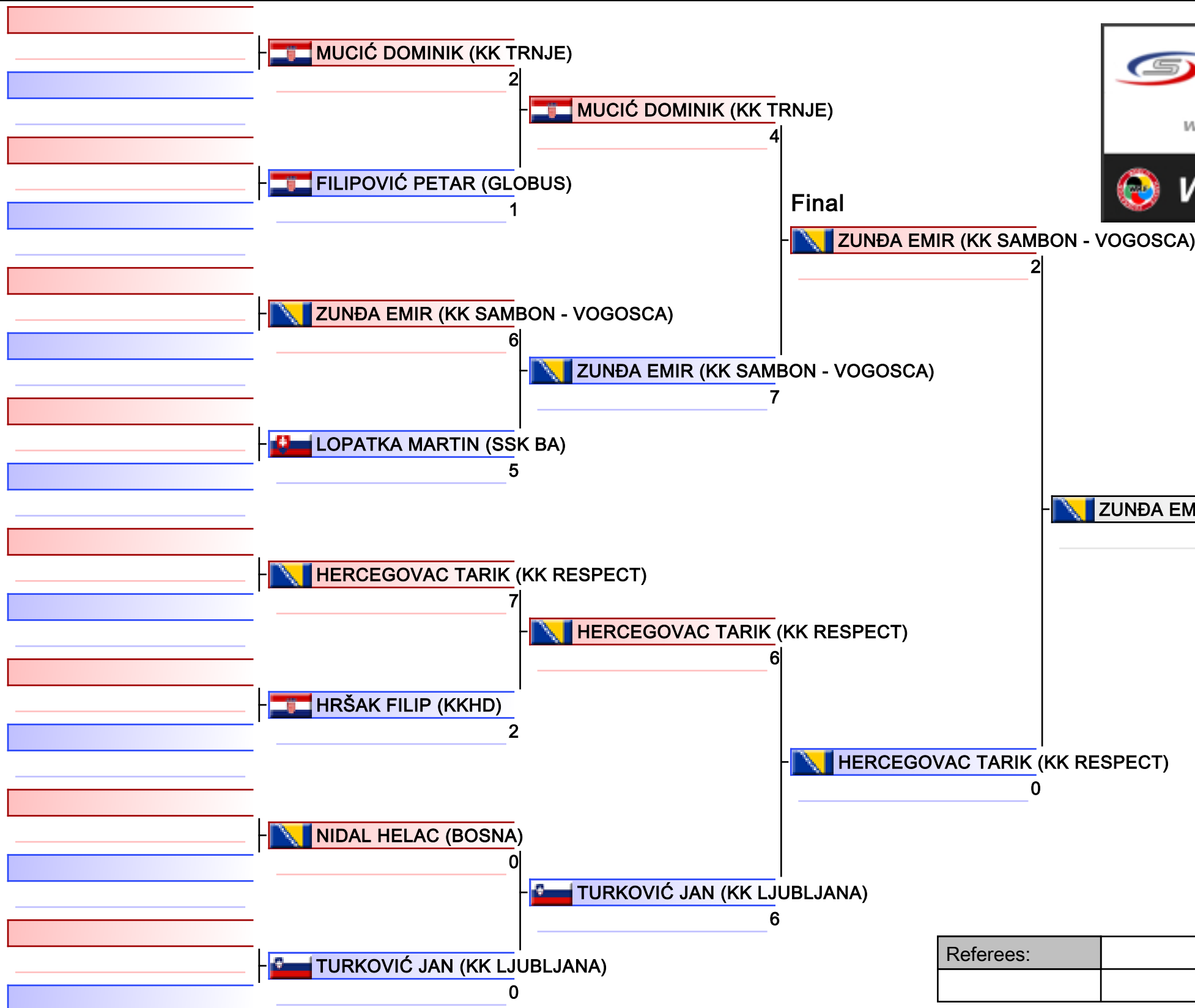

1. ZUNĐA EMIR (KK SAMBON - VOGOSCA)
2. HERCEGOVAC TARIK (KK RESPECT)
3. MUCIĆ DOMINIK (KK TRNJE)
3. TURKOVIĆ JAN (KK LJUBLJANA)
5. LOPATKA MARTIN (SSK BA)
5. HRŠAK FILIP (KKHD)

Referees:			

KUMITE BOYS 11-12 YEARS -34KG

31ST KARATE GRAND PRIX CROATIA, CITY SPORTS HALL SAMOBOR, ANDRIJE HEBRANGA 26A, SAMOBOR, CROATIA, CRO

2023-01-22

Tatami 5 17:15

Pool 1/1

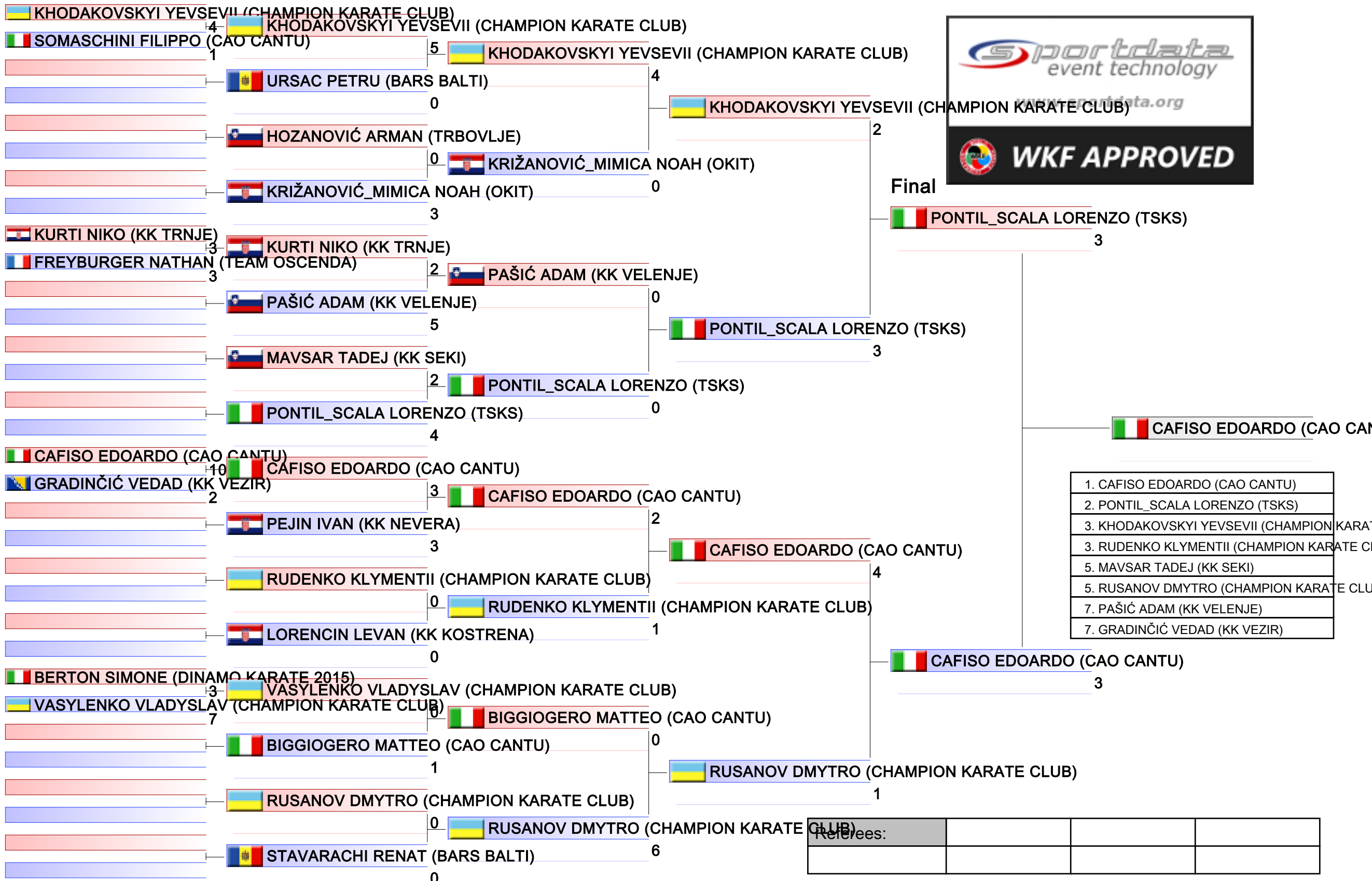

KUMITE BOYS 11-12 YEARS -39KG

31ST KARATE GRAND PRIX CROATIA, CITY SPORTS HALL SAMOBOR, ANDRIJE HEBRANGA 26A, SAMOBOR, CROATIA, CRO

2023-01-22

Tatami
2 16:25

Pool
1/1

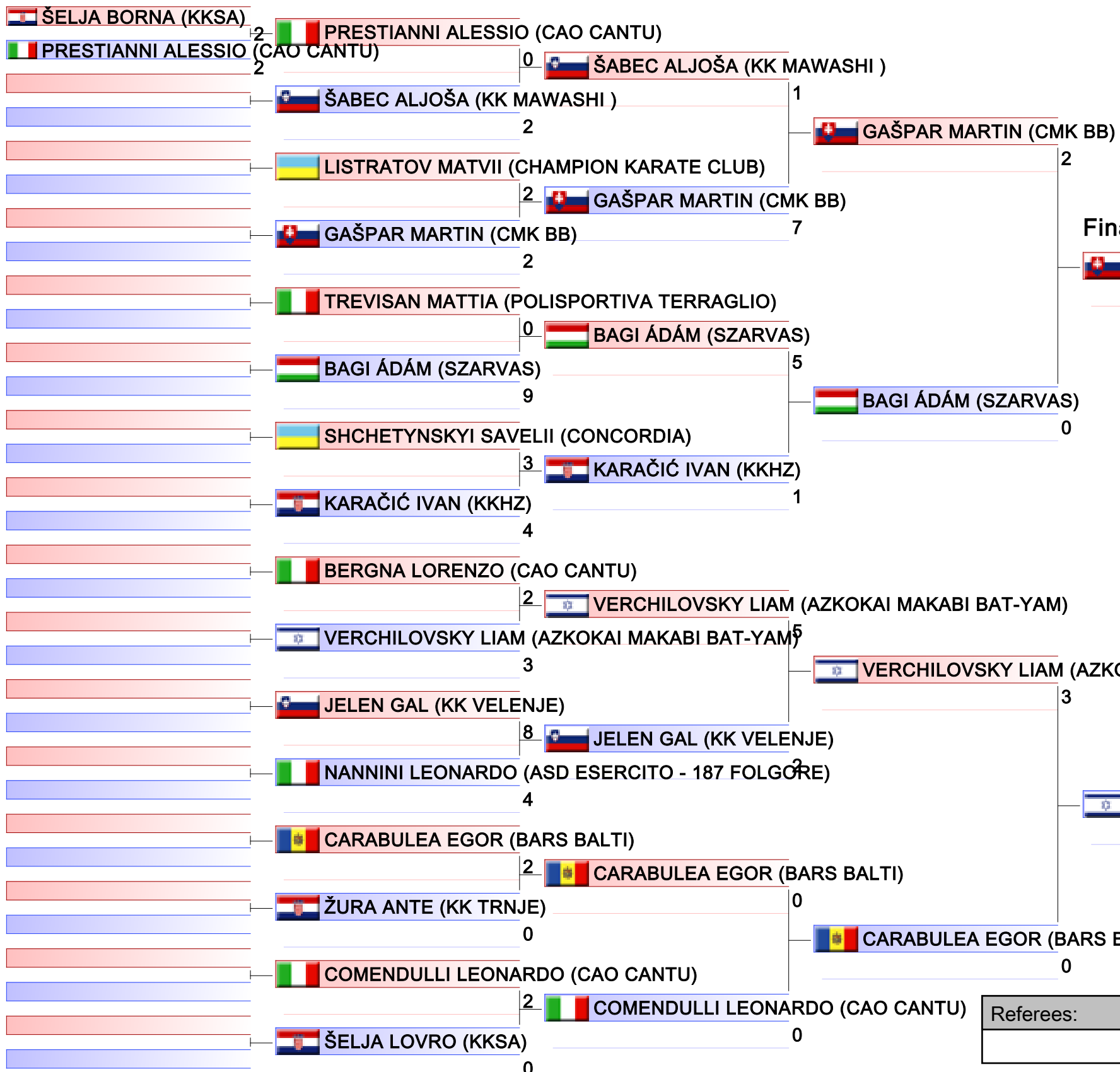

Final

- | |
|---|
| 1. GAŠPAR MARTIN (CMK BB) |
| 2. VERCHILOVSKY LIAM (AZKOKAI MAKABI BAT-YAM) |
| 3. BAGI ÁDÁM (SZARVAS) |
| 4. CARABULEA EGOR (BARS BALTI) |
| 5. LISTRATOV MATVII (CHAMPION KARATE CLUB) |
| 5. BERGNA LORENZO (CAO CANTU) |
| 7. ŠABEC ALJOŠA (KK MAWASHI) |
| 7. JELEN GAL (KK VELENJE) |

Referees:			

KUMITE BOYS 11-12 YEARS -44KG

31ST KARATE GRAND PRIX CROATIA, CITY SPORTS HALL SAMOBOR, ANDRIJE HEBRANGA 26A, SAMOBOR, CROATIA, CRO

2023-01-22

Tatami
3 17:15

Pool
1/1

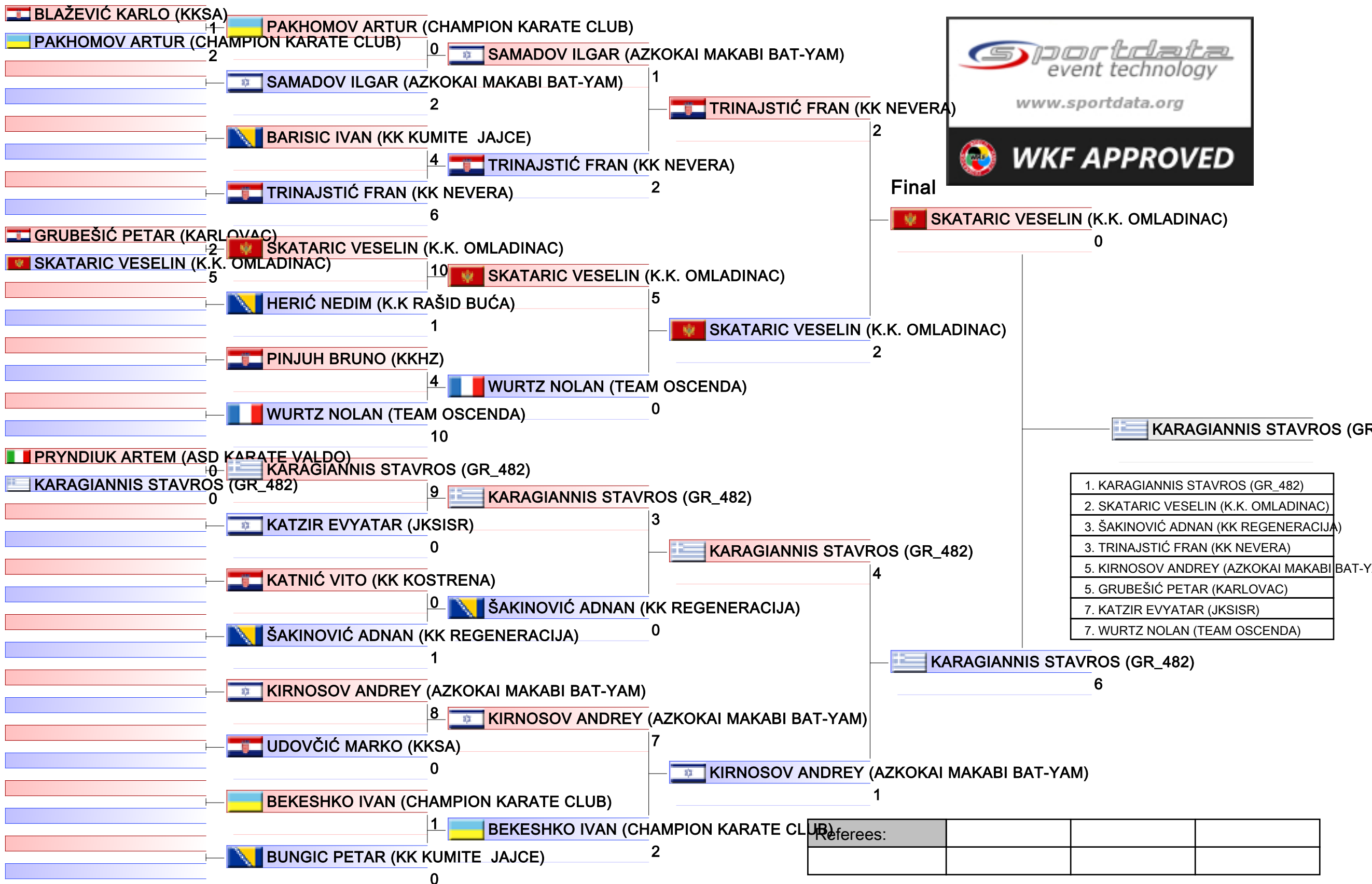

- | |
|---|
| 1. KARAGIANNIS STAVROS (GR_482) |
| 2. SKATARIC VESELIN (K.K. OMLADINAC) |
| 3. ŠAKINOVIĆ ADNAN (KK REGENERACIJA) |
| 3. TRINAJSTIĆ FRAN (KK NEVERA) |
| 5. KIRNOSOV ANDREY (AZKOKAI MAKABI BAT-YAM) |
| 5. GRUBEŠIĆ PETAR (KARLOVAC) |
| 7. KATZIR EVYATAR (JKSISR) |
| 7. WURTZ NOLAN (TEAM OSCENDA) |

KUMITE BOYS 11-12 YEARS -49KG

31ST KARATE GRAND PRIX CROATIA, CITY SPORTS HALL SAMOBOR, ANDRIJE HEBRANGA 26A, SAMOBOR, CROATIA, CRO

2023-01-22

Tatami
4 17:40

Pool
1/1

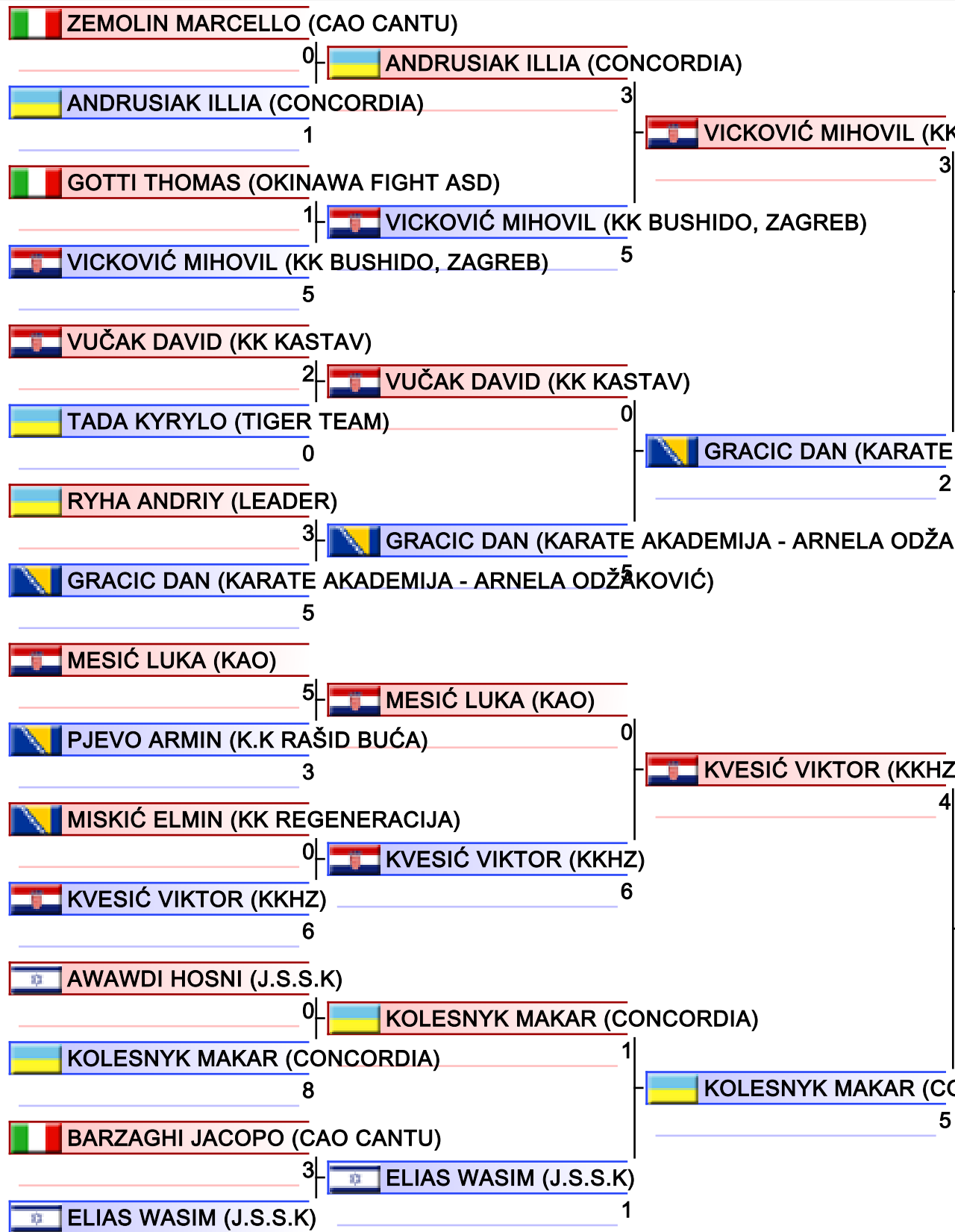

- | |
|---|
| 1. KOLESNYK MAKAR (CONCORDIA) |
| 2. VICKOVIĆ MIHOVIL (KK BUSHIDO, ZAGREB) |
| 3. GRACIC DAN (KARATE AKADEMIJA - ARNELA ODŽAKOVIĆ) |
| 3. KVESIĆ VIKTOR (KKHZ) |
| 5. ANDRUSIAK ILLIA (CONCORDIA) |
| 5. ELIAS WASIM (J.S.S.K) |
| 7. GOTTI THOMAS (OKINAWA FIGHT ASD) |
| 7. AWAWDI HOSNI (J.S.S.K) |

Referees:			

KUMITE BOYS 11-12 YEARS -54KG

31ST KARATE GRAND PRIX CROATIA, CITY SPORTS HALL SAMOBOR, ANDRIJE HEBRANGA 26A, SAMOBOR, CROATIA, CRO

2023-01-22

Tatami
6 17:45

Pool
1/1

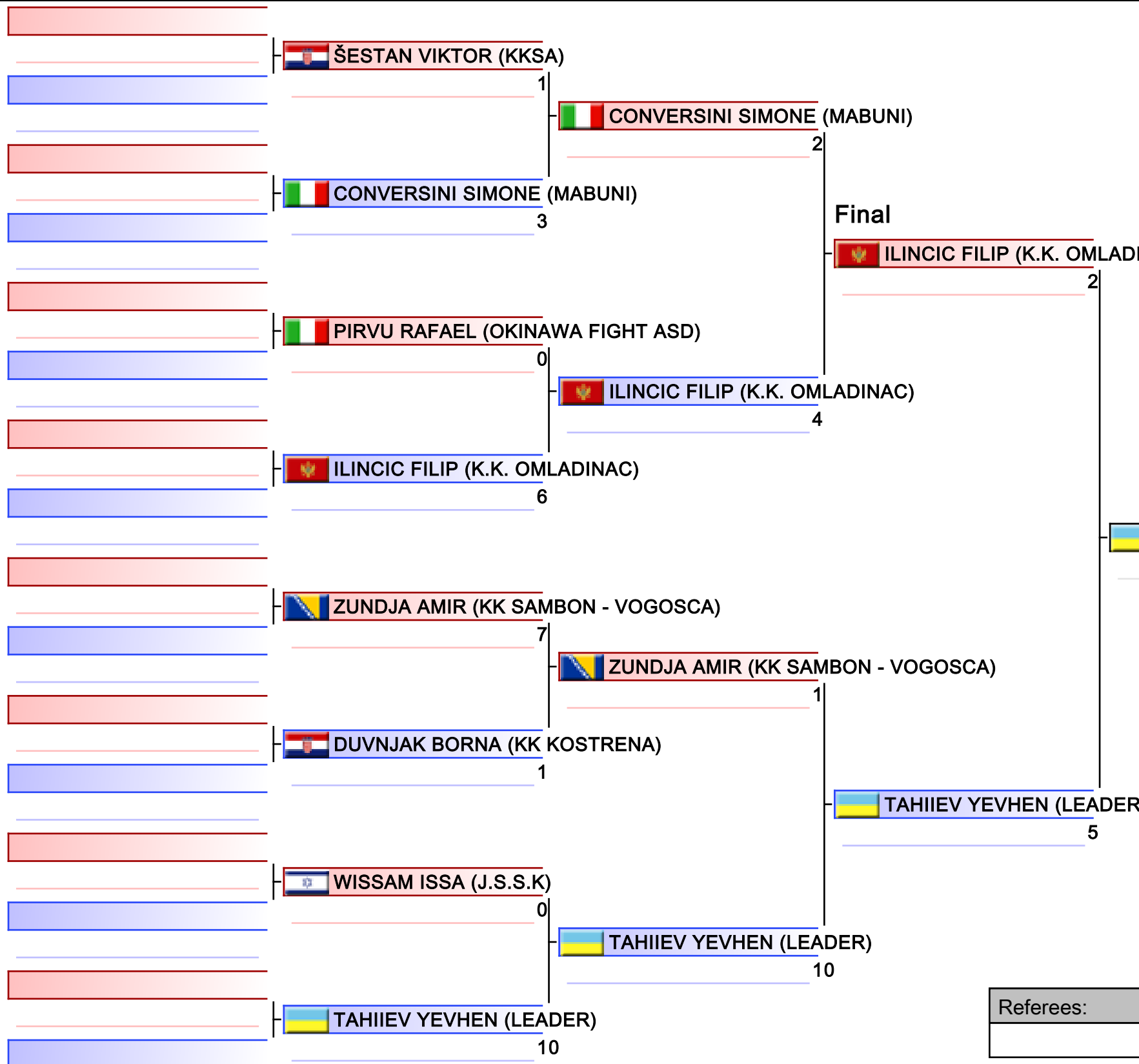

1. TAHIIEV YEVHEN (LEADER)
2. ILINCIC FILIP (K.K. OMLADINAC)
3. CONVERSINI SIMONE (MABUNI)
3. ZUNDJA AMIR (KK SAMBON - VOGOSCA)
5. PIRVU RAFAEL (OKINAWA FIGHT ASD)
5. WISSAM ISSA (J.S.S.K)

Referees:			

KUMITE BOYS 13-14 YEARS +69KG

31ST KARATE GRAND PRIX CROATIA, CITY SPORTS HALL SAMOBOR, ANDRIJE HEBRANGA 26A, SAMOBOR, CROATIA, CRO

2023-01-22

Tatami
6 18:15

Pool
1/1

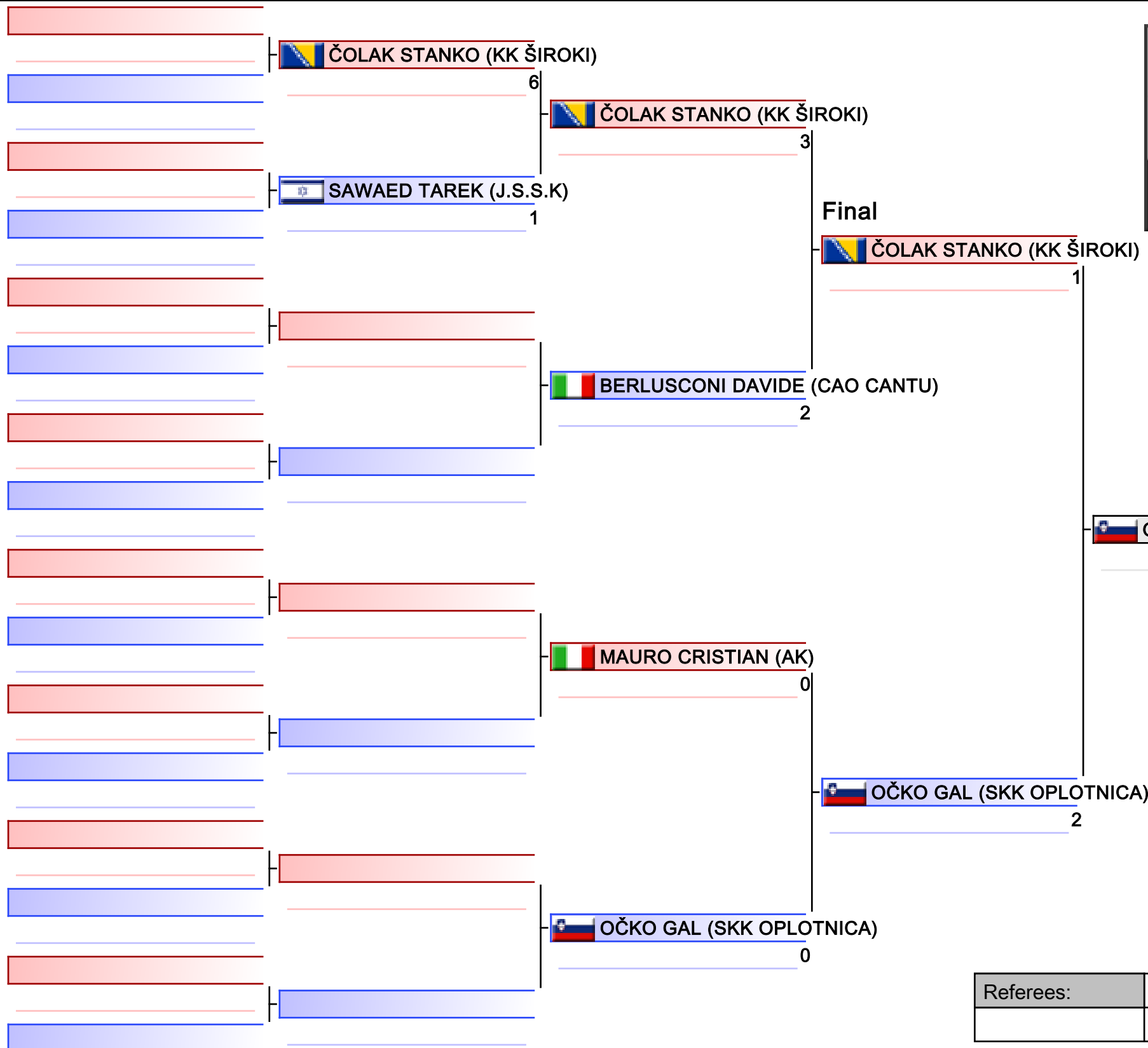

1. OČKO GAL (SKK OPLOTNICA)
2. ČOLAK STANKO (KK ŠIROKI)
3. MAURO CRISTIAN (AK)
3. BERLUSCONI DAVIDE (CAO CANTU)
5. SAWAED TAREK (J.S.S.K)

Referees:			

KUMITE BOYS 13-14 YEARS -44KG

31ST KARATE GRAND PRIX CROATIA, CITY SPORTS HALL SAMOBOR, ANDRIJE HEBRANGA 26A, SAMOBOR, CROATIA, CRO

2023-01-22

Tatami
1 18:40

Pool
1/1

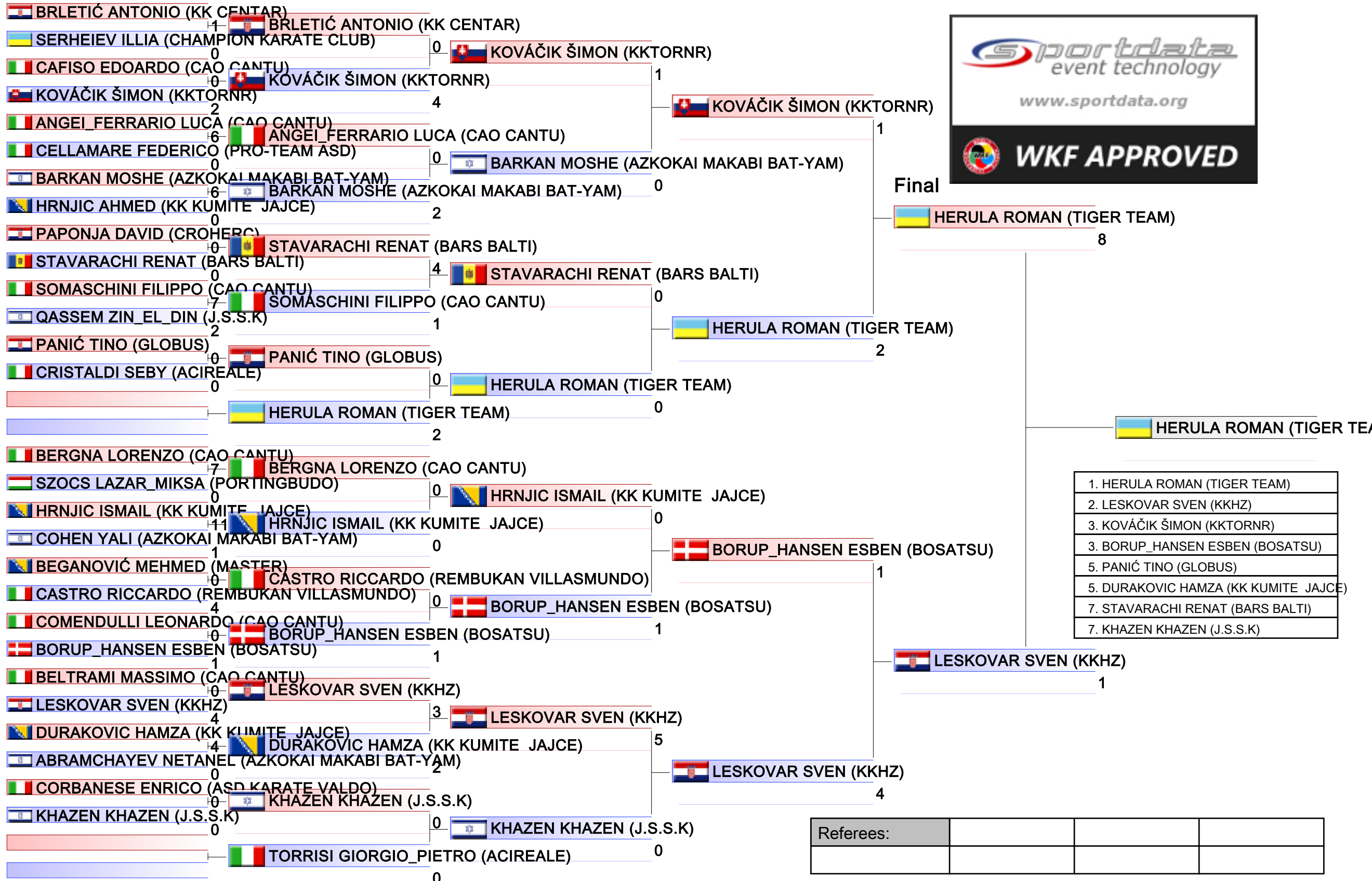

- | |
|--------------------------------------|
| 1. HERULA ROMAN (TIGER TEAM) |
| 2. LESKOVAR SVEN (KKHZ) |
| 3. KOVÁČIK ŠIMON (KKTORNR) |
| 3. BORUP_HANSEN ESSEN (BOSATSU) |
| 5. PANIĆ TINO (GLOBUS) |
| 5. DURAKOVIC HAMZA (KK KUMITE JAJCE) |
| 7. STAVARACHI RENAT (BARS BALTI) |
| 7. KHAZEN KHAZEN (J.S.S.K) |

KUMITE BOYS 13-14 YEARS -49KG

31ST KARATE GRAND PRIX CROATIA, CITY SPORTS HALL SAMOBOR, ANDRIJE HEBRANGA 26A, SAMOBOR, CROATIA, CRO

2023-01-22

Tatami
2 18:40

Pool
1/1

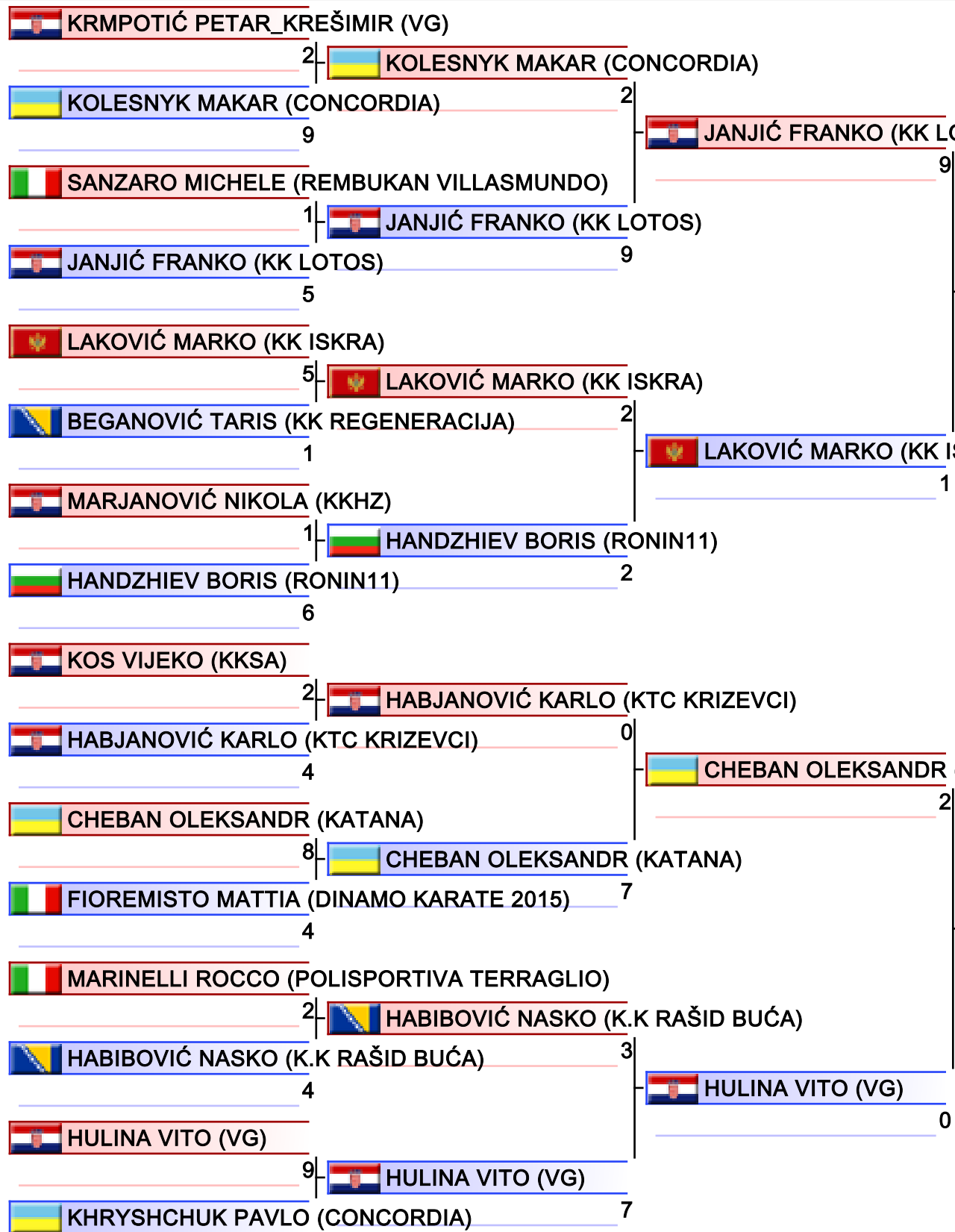

Final

JANJIĆ FRANKO (KK LOTOS) [1]

CHEBAN OLEKSANDR (KATANA)

1. CHEBAN OLEKSANDR (KATANA)
2. JANJIĆ FRANKO (KK LOTOS)
3. HULINA VITO (VG)
3. SANZARO MICHELE (REMBUKAN VILLASMUNDO)
5. FIOREMISTO MATTIA (DINAMO KARATE 2015)
5. LAKOVIĆ MARKO (KK ISKRA)
7. HABJANOVIĆ KARLO (KTC KRIZEVCI)
7. KOLESNYK MAKAR (CONCORDIA)

Referees:			

KUMITE BOYS 13-14 YEARS -54KG

31ST KARATE GRAND PRIX CROATIA, CITY SPORTS HALL SAMOBOR, ANDRIJE HEBRANGA 26A, SAMOBOR, CROATIA, CRO

2023-01-22

Tatami
5 18:35

Pool
1/1

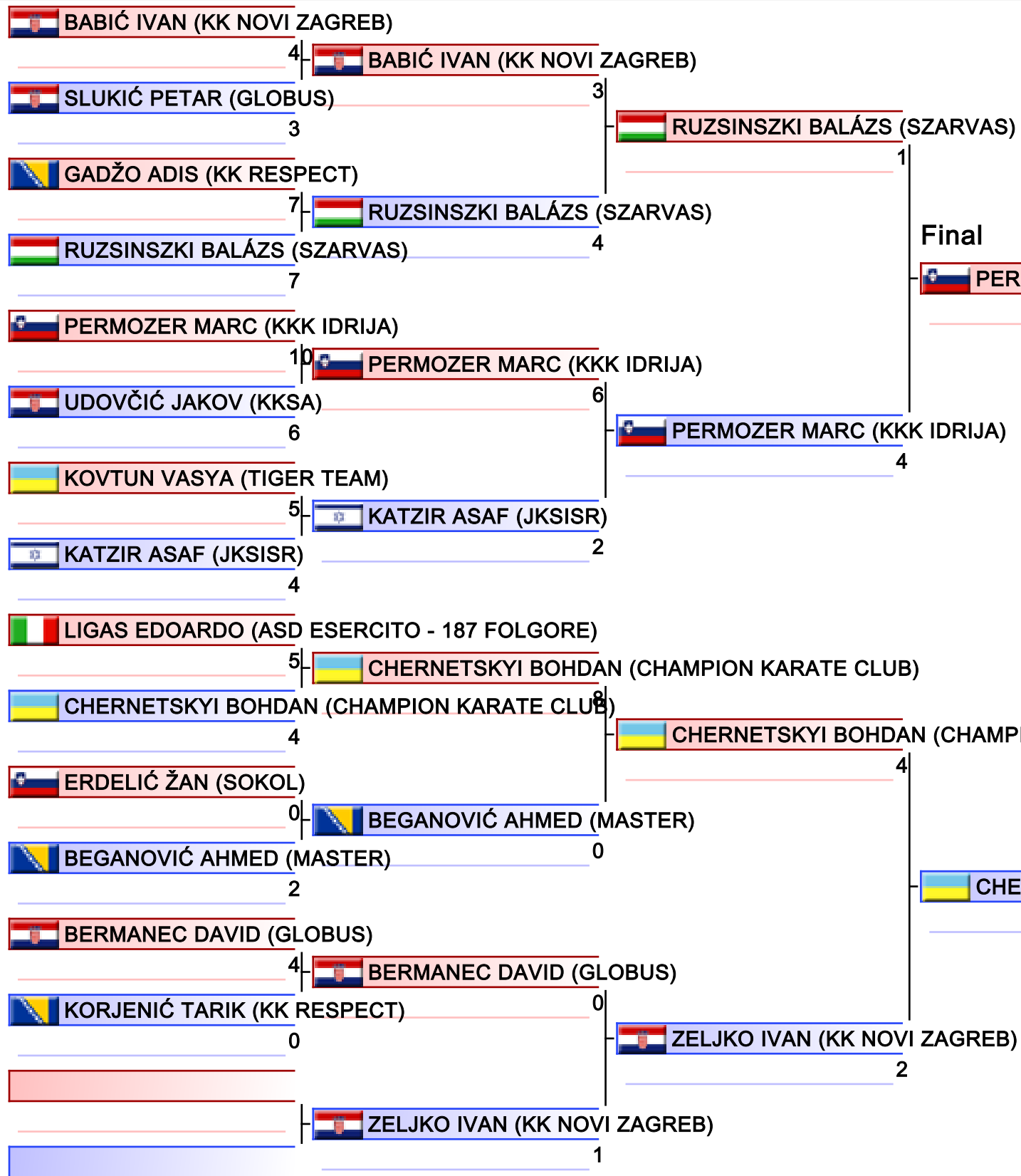

1. CHERNETSKYI BOHDAN (CHAMPION KARATE CLUB)
2. PERMOZER MARC (KKK IDRIJA)
3. RUZSINSZKI BALÁZS (SZARVAS)
3. ZELJKO IVAN (KK NOVI ZAGREB)
5. UDOVČIĆ JAKOV (KKSA)
5. LIGAS EDOARDO (ASD ESERCITO - 187 FOLGORE)
7. KATZIR ASAF (JKSISR)
7. BEGANOVIĆ AHMED (MASTER)

Referees:			

KUMITE BOYS 13-14 YEARS -59KG

31ST KARATE GRAND PRIX CROATIA, CITY SPORTS HALL SAMOBOR, ANDRIJE HEBRANGA 26A, SAMOBOR, CROATIA, CRO

2023-01-22

Tatami
6 18:35

Pool
1/1

NAŇO TOMÁŠ (SVK)

MATIJEVIC ANTE (KK KASTAV) 0

MATIJEVIC ANTE (KK KASTAV) 3

BABIĆ BORNA (KK KOSTRENA) 0

BUSNOV AHMED (BOSNA)

RAHMANOVIĆ IMRAN (KK RESPECT) 0

RAHMANOVIĆ IMRAN (KK RESPECT) 0

MIHOV MARTIN (RONIN11) 9

SOKIRKO ARTEM (TIGER TEAM)

DANDRIA COSIMO (PRO-TEAM ASD) 0

DANDRIA COSIMO (PRO-TEAM ASD) 0

KOZAK KOSTIANTYN (LEADER) 5

PETROV VENISLAV (LEVSKI) 0

OBAJDIN FILIP (KK KASTAV) 0

MATIJEVIC ANTE (KK KASTAV) 3

Final

MATIJEVIC ANTE (KK KASTAV) 7

MIHOV MARTIN (RONIN11) 2

MATIJEVIC ANTE (KK KASTAV)

KOZAK KOSTIANTYN (LEADER) 10

KOZAK KOSTIANTYN (LEADER) 2

OBAJDIN FILIP (KK KASTAV) 1



- | |
|----------------------------------|
| 1. MATIJEVIC ANTE (KK KASTAV) |
| 2. KOZAK KOSTIANTYN (LEADER) |
| 3. OBAJDIN FILIP (KK KASTAV) |
| 3. MIHOV MARTIN (RONIN11) |
| 5. DANDRIA COSIMO (PRO-TEAM ASD) |
| 5. BABIĆ BORNA (KK KOSTRENA) |
| 7. NAŇO TOMÁŠ (SVK) |

Referees:			

KUMITE BOYS 13-14 YEARS -64KG

31ST KARATE GRAND PRIX CROATIA, CITY SPORTS HALL SAMOBOR, ANDRIJE HEBRANGA 26A, SAMOBOR, CROATIA, CRO

2023-01-22

Tatami
2 20:05

Pool
1/1

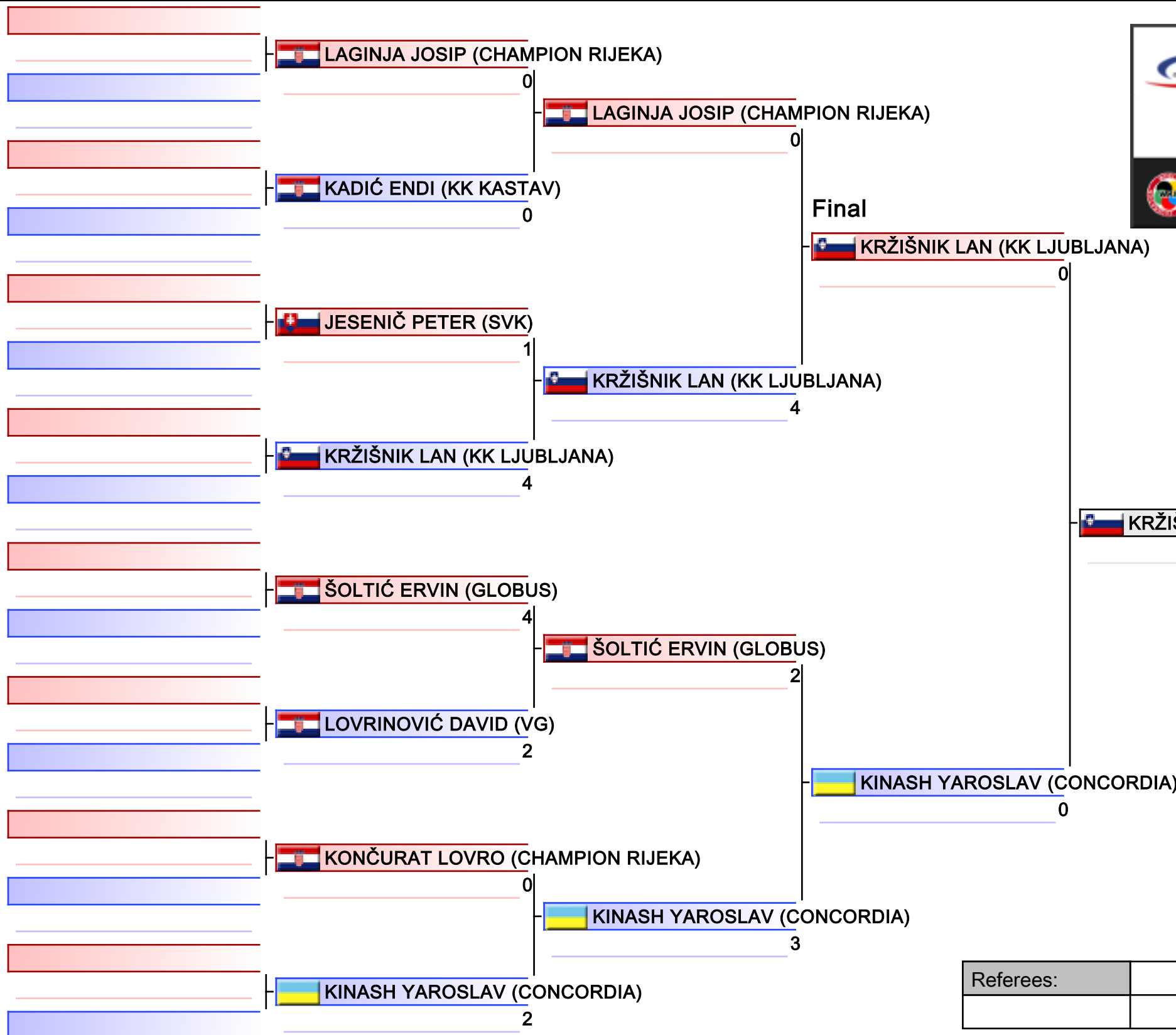

1. KRŽIŠNIK LAN (KK LJUBLJANA)
2. KINASH YAROSLAV (CONCORDIA)
3. ŠOLTIĆ ERVIN (GLOBUS)
3. JESENIČ PETER (SVK)
5. KONČURAT LOVRO (CHAMPION RIJEKA)
5. LAGINJA JOSIP (CHAMPION RIJEKA)

Referees:			

KUMITE BOYS 13-14 YEARS -69KG

31ST KARATE GRAND PRIX CROATIA, CITY SPORTS HALL SAMOBOR, ANDRIJE HEBRANGA 26A, SAMOBOR, CROATIA, CRO

2023-01-22

Tatami
3 18:15

Pool
1/1

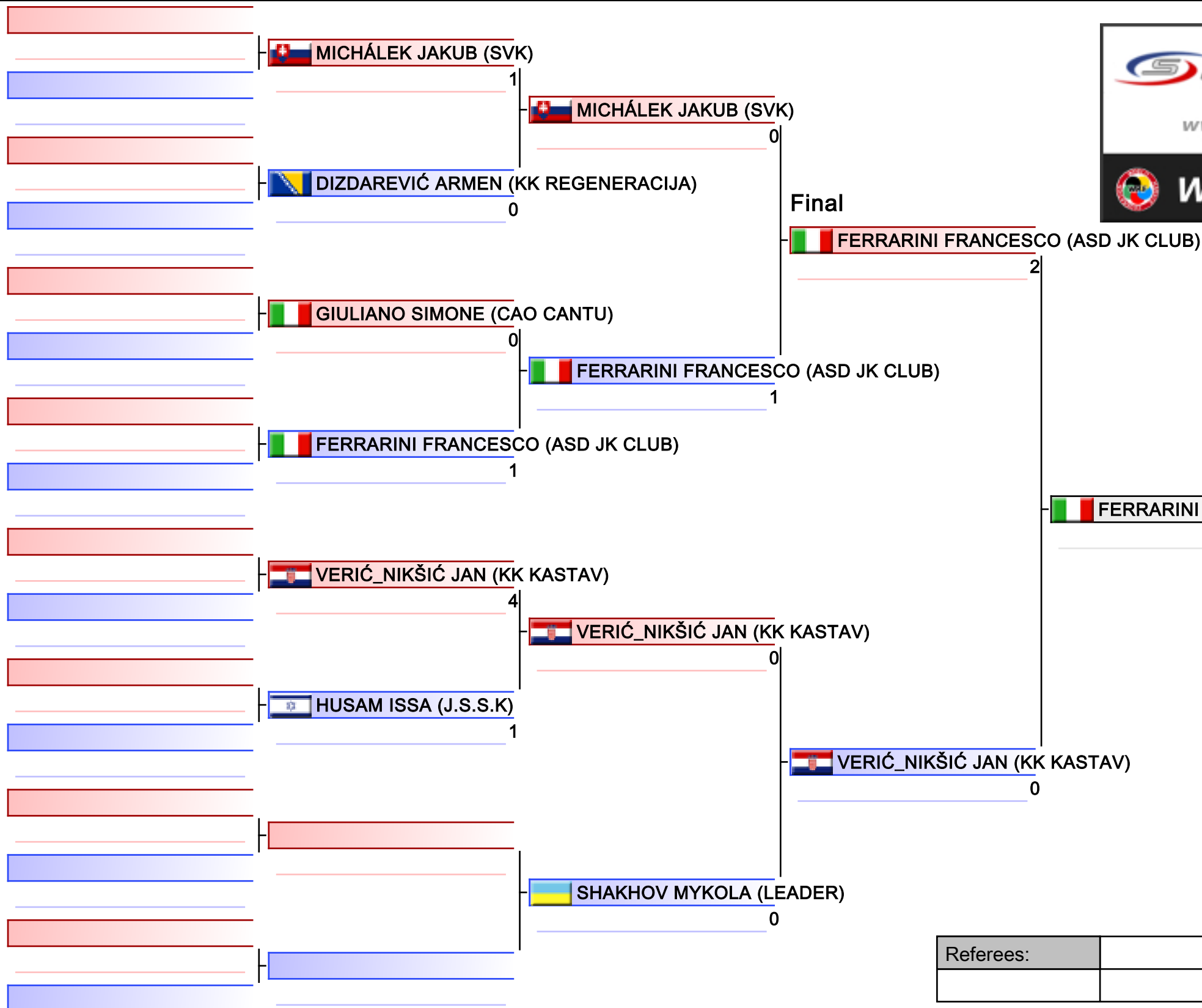

1. FERRARINI FRANCESCO (ASD JK CLUB)
2. VERIĆ_NIKŠIĆ JAN (KK KASTAV)
3. GIULIANO SIMONE (CAO CANTU)
3. SHAKHOV MYKOLA (LEADER)
5. MICHÁLEK JAKUB (SVK)
5. HUSAM ISSA (J.S.S.K)

Referees:			

KUMITE BOYS 7-8 YEARS -24kg

31ST KARATE GRAND PRIX CROATIA, CITY SPORTS HALL SAMOBOR, ANDRIJE HEBRANGA 26A, SAMOBOR, CROATIA, CRO

2023-01-22

Tatami
1 15:00

Pool
1/1

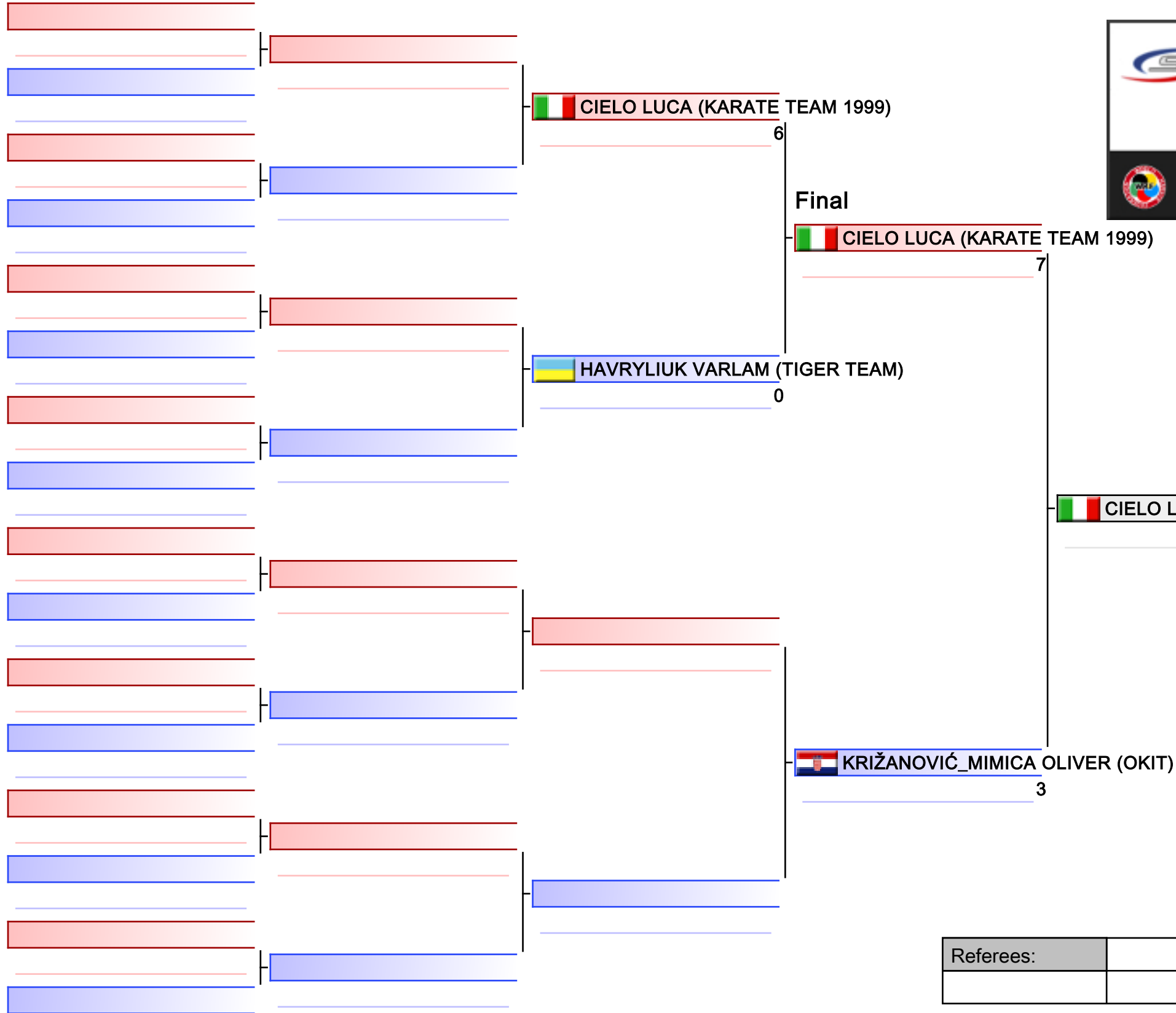

1. CIELO LUCA (KARATE TEAM 1999)
2. KRIŽANOVIĆ_MIMICA OLIVER (OKIT)
3. HAVRYLIUK VARLAM (TIGER TEAM)

Referees:			

KUMITE BOYS 7-8 YEARS -28kg

31ST KARATE GRAND PRIX CROATIA, CITY SPORTS HALL SAMOBOR, ANDRIJE HEBRANGA 26A, SAMOBOR, CROATIA, CRO

2023-01-22

Tatami
1 15:05

Pool
1/1

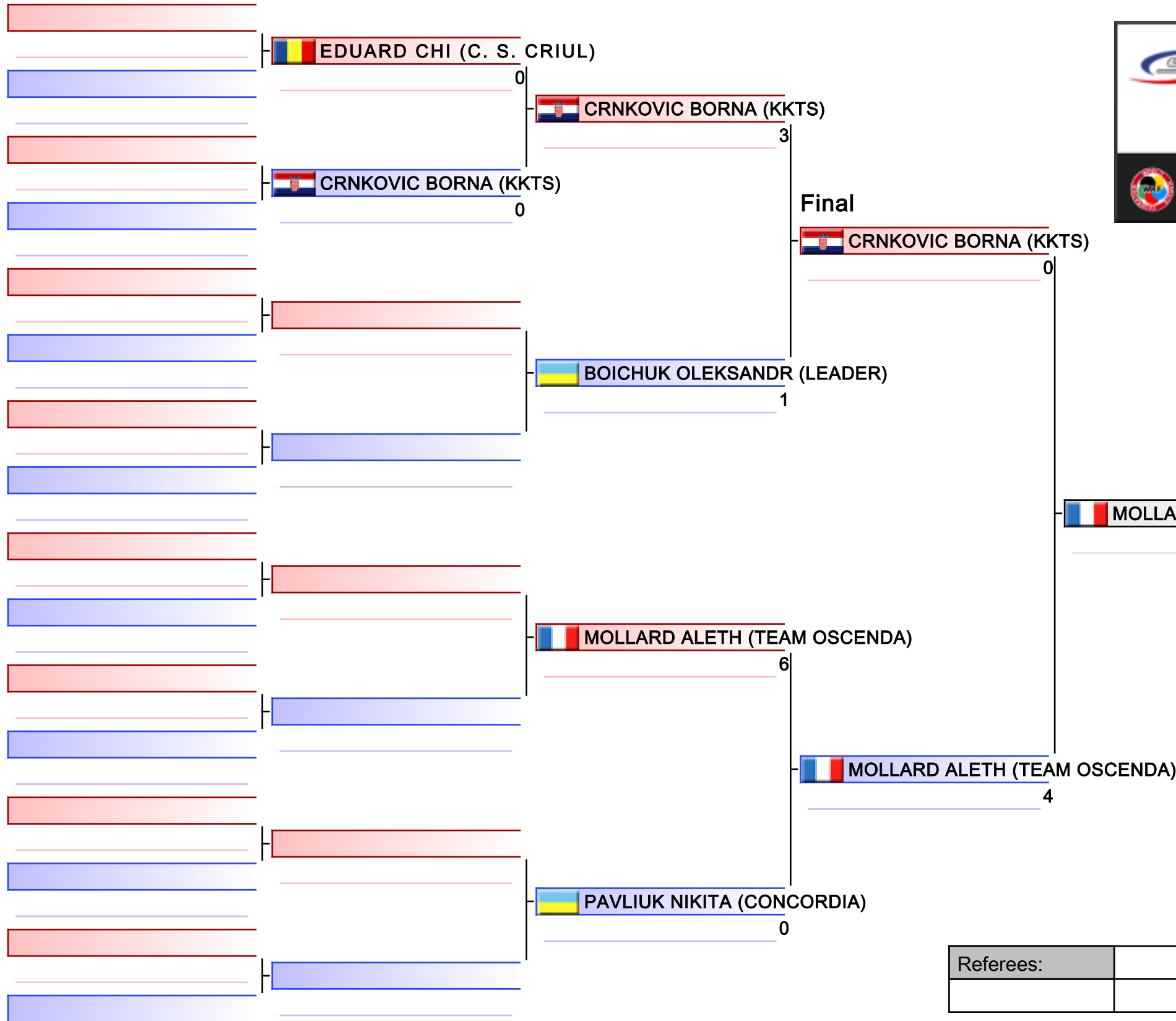

1. MOLLARD ALETH (TEAM OSCENDA)
2. CRNKOVIC BORNA (KKTS)
3. PAVLIUK NIKITA (CONCORDIA)
3. BOICHUK OLEKSANDR (LEADER)
5. EDUARD CHI (C. S. CRIUL)

Referees:			

KUMITE BOYS 7-8 YEARS -36kg

31ST KARATE GRAND PRIX CROATIA, CITY SPORTS HALL SAMOBOR, ANDRIJE HEBRANGA 26A, SAMOBOR, CROATIA, CRO

Tatami

Pool
1/1

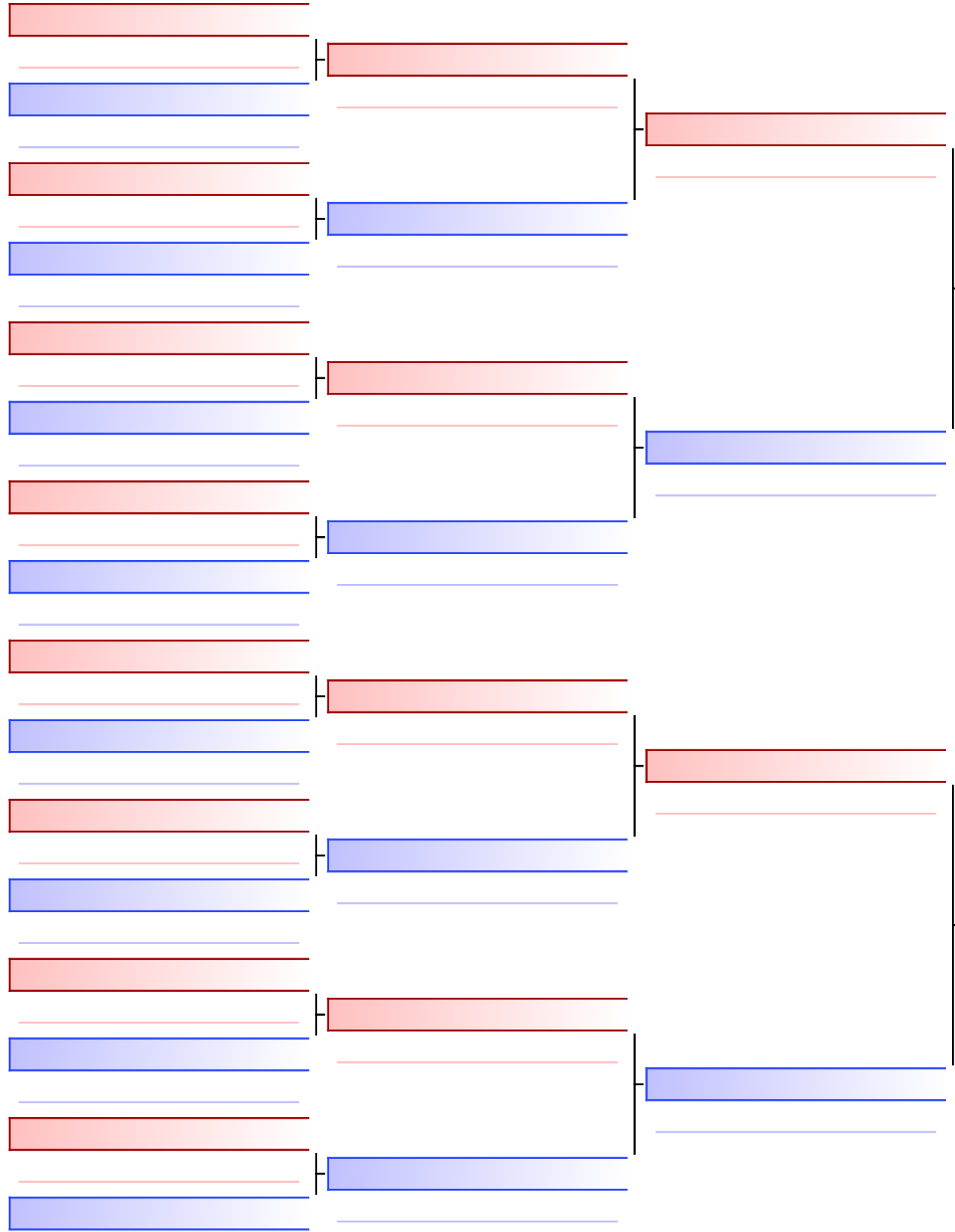

Final

PERKOVIĆ NOA_ADRIAN (OKIT)

4

PERKOVIĆ NOA_ADRIAN (OKIT)

LYTKIN ARTEM (LEADER)

0

1. PERKOVIĆ NOA_ADRIAN (OKIT)
2. LYTKIN ARTEM (LEADER)

Referees:			

KUMITE BOYS 9-10 YEARS +43kg

31ST KARATE GRAND PRIX CROATIA, CITY SPORTS HALL SAMOBOR, ANDRIJE HEBRANGA 26A, SAMOBOR, CROATIA, CRO

2023-01-22

Tatami
4 16:10

Pool
1/1

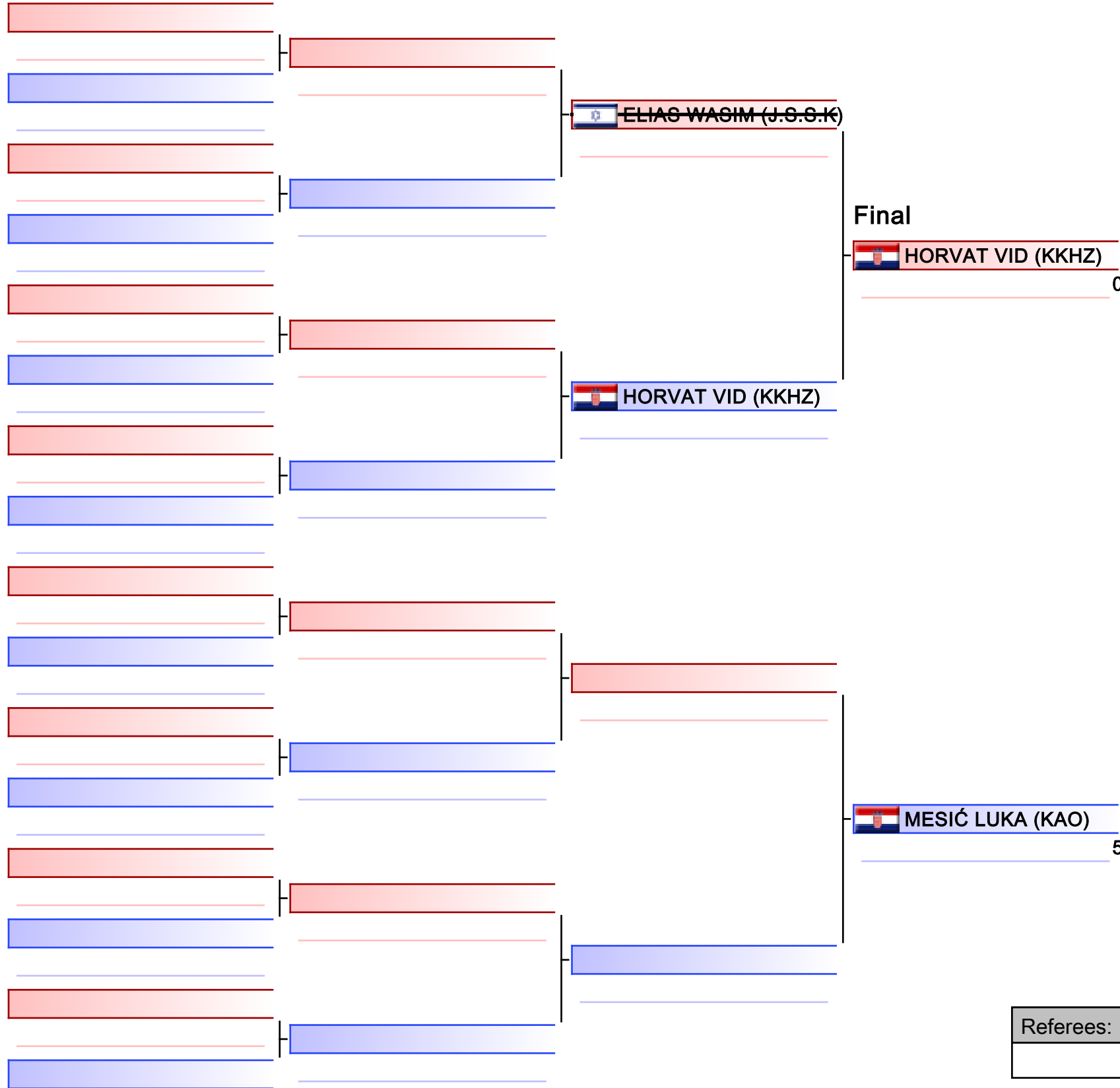

MESIĆ LUKA (KAO)

1. MESIĆ LUKA (KAO)
2. HORVAT VID (KKHZ)

Referees:			

KUMITE BOYS 9-10 YEARS -27KG

31ST KARATE GRAND PRIX CROATIA, CITY SPORTS HALL SAMOBOR, ANDRIJE HEBRANGA 26A, SAMOBOR, CROATIA, CRO

2023-01-22

Tatami
3 16:15

Pool
1/1

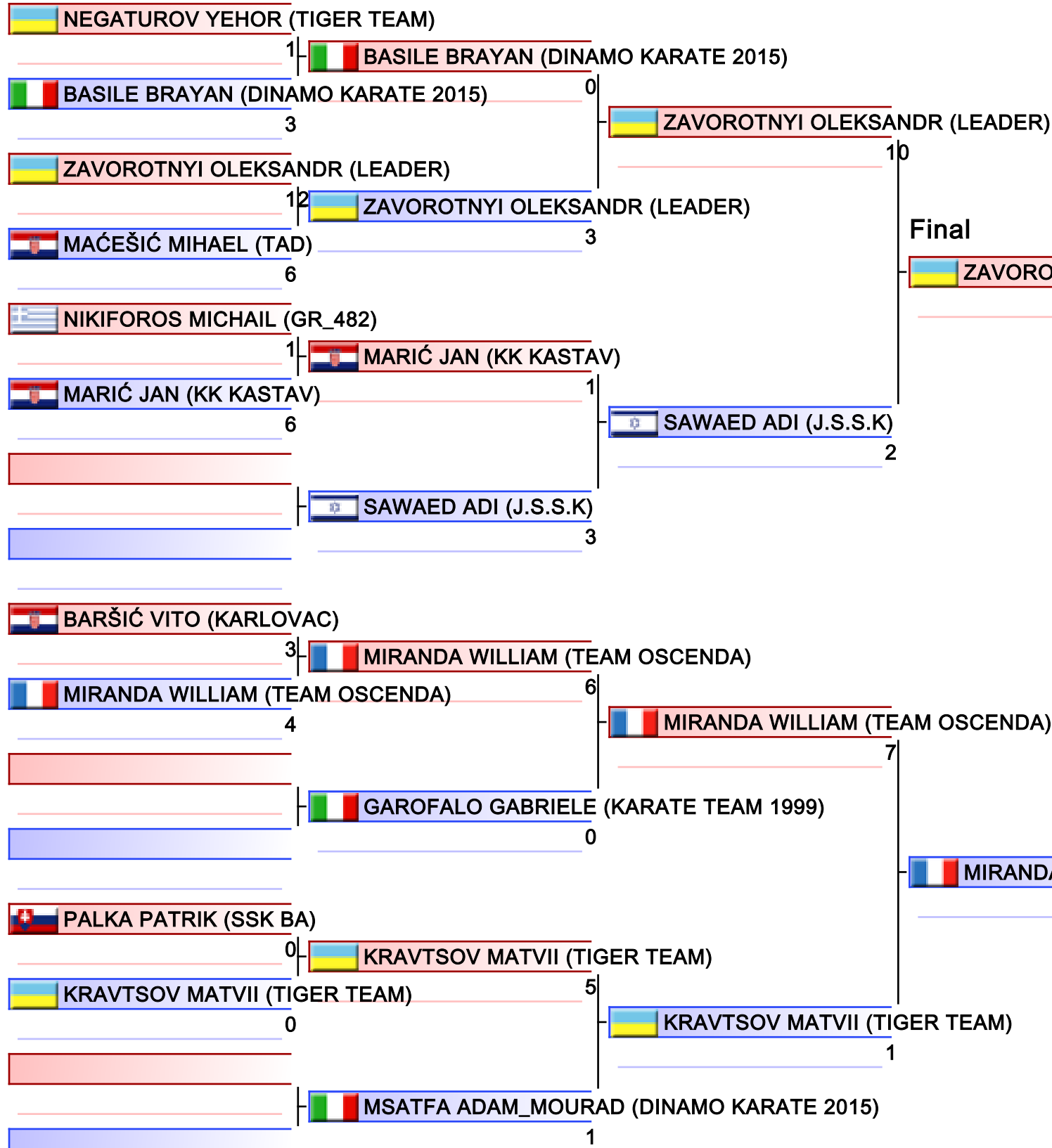

- | |
|---|
| 1. ZAVOROTNYI OLEKSANDR (LEADER) |
| 2. MIRANDA WILLIAM (TEAM OSCENDA) |
| 3. SAWAED ADI (J.S.S.K) |
| 3. BARŠIĆ VITO (KARLOVAC) |
| 5. MAĆEŠIĆ MIHAEL (TAD) |
| 5. KRAVTSOV MATVII (TIGER TEAM) |
| 7. BASILE BRAYAN (DINAMO KARATE 2015) |
| 7. GAROFALO GABRIELE (KARATE TEAM 1999) |

Referees:			

KUMITE BOYS 9-10 YEARS -31kg

31ST KARATE GRAND PRIX CROATIA, CITY SPORTS HALL SAMOBOR, ANDRIJE HEBRANGA 26A, SAMOBOR, CROATIA, CRO

2023-01-22

Tatami
5 16:15

Pool
1/1

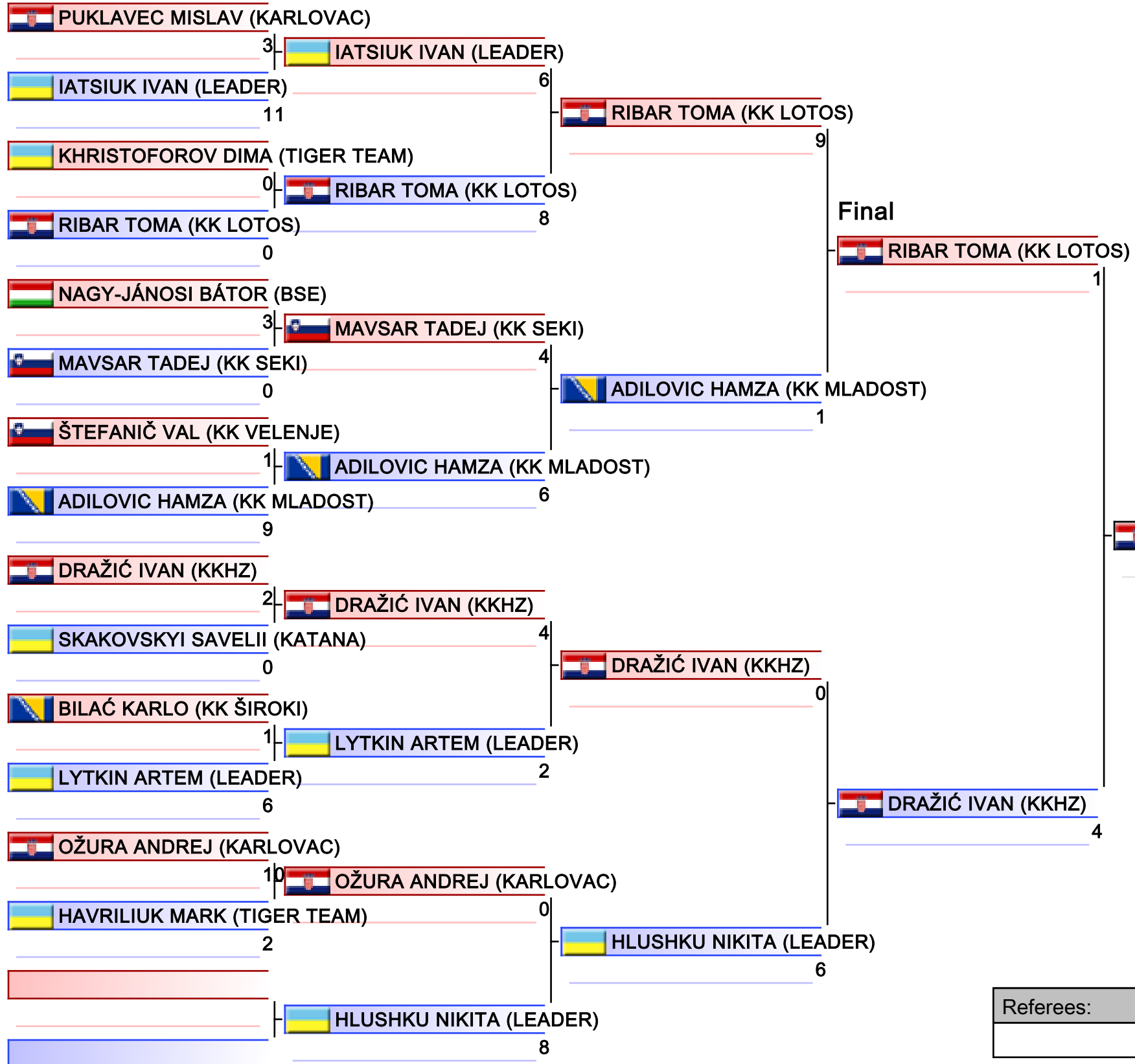

1. DRAŽIĆ IVAN (KKHZ)
2. RIBAR TOMA (KK LOTOS)
3. IATSIUK IVAN (LEADER)
3. HLUSHKU NIKITA (LEADER)
5. ADILOVIC HAMZA (KK MLADOST)
5. LYTKIN ARTEM (LEADER)
7. KHRISTOFOROV DIMA (TIGER TEAM)
7. SKAKOVSKYI SAVELII (KATANA)

Referees:			

KUMITE BOYS 9-10 YEARS -35kg

31ST KARATE GRAND PRIX CROATIA, CITY SPORTS HALL SAMOBOR, ANDRIJE HEBRANGA 26A, SAMOBOR, CROATIA, CRO

2023-01-22

Tatami
1 15:20

Pool
1/1

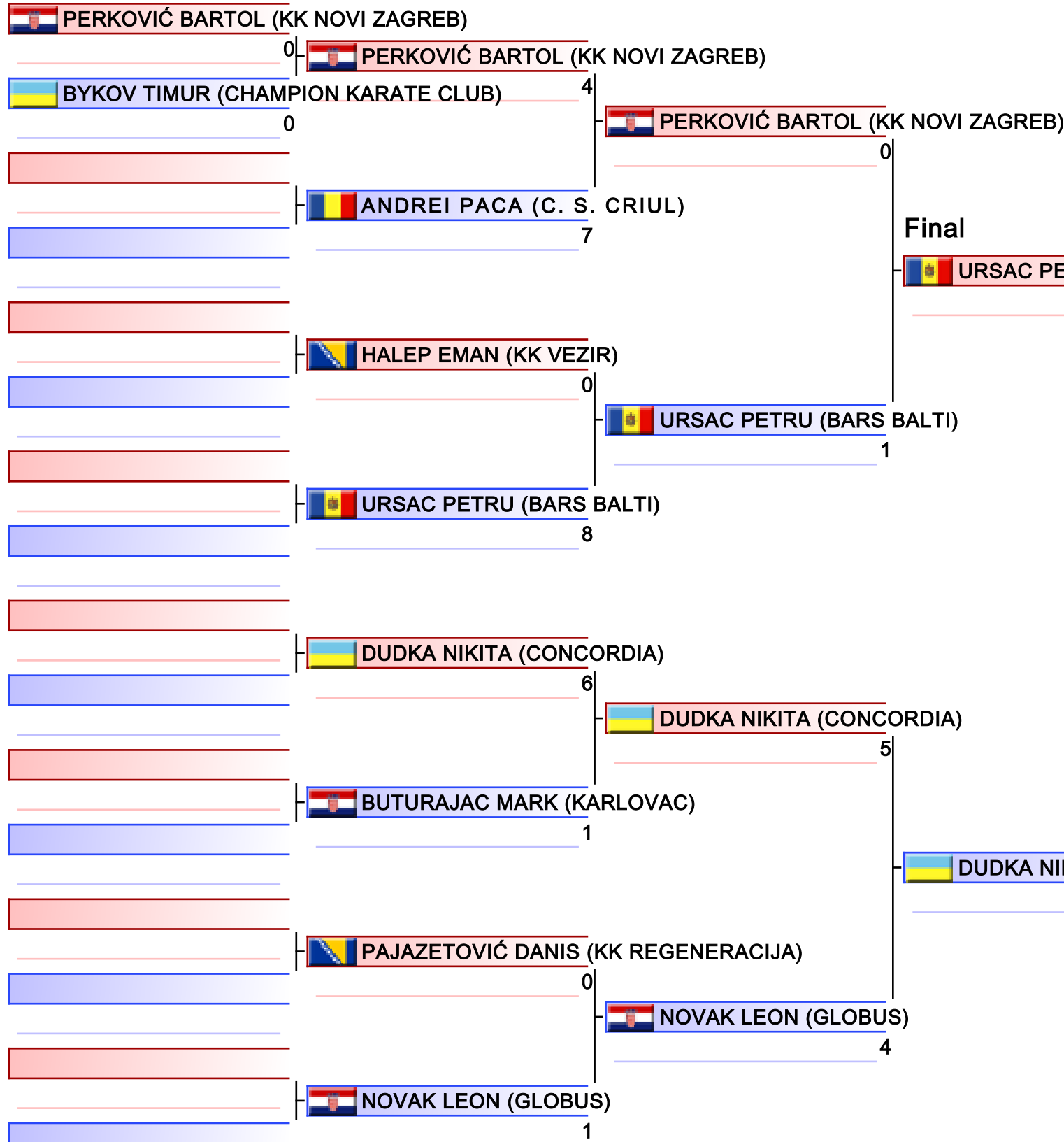

1. URSAC PETRU (BARS BALTI)
2. DUDKA NIKITA (CONCORDIA)
3. BUTURAJAC MARK (KARLOVAC)
3. PERKOVIĆ BARTOL (KK NOVI ZAGREB)
5. NOVAK LEON (GLOBUS)
5. HALEP EMAN (KK VEZIR)

Referees:			

KUMITE BOYS 9-10 YEARS -39kg

31ST KARATE GRAND PRIX CROATIA, CITY SPORTS HALL SAMOBOR, ANDRIJE HEBRANGA 26A, SAMOBOR, CROATIA, CRO

2023-01-22

Tatami
6 16:05

Pool
1/1

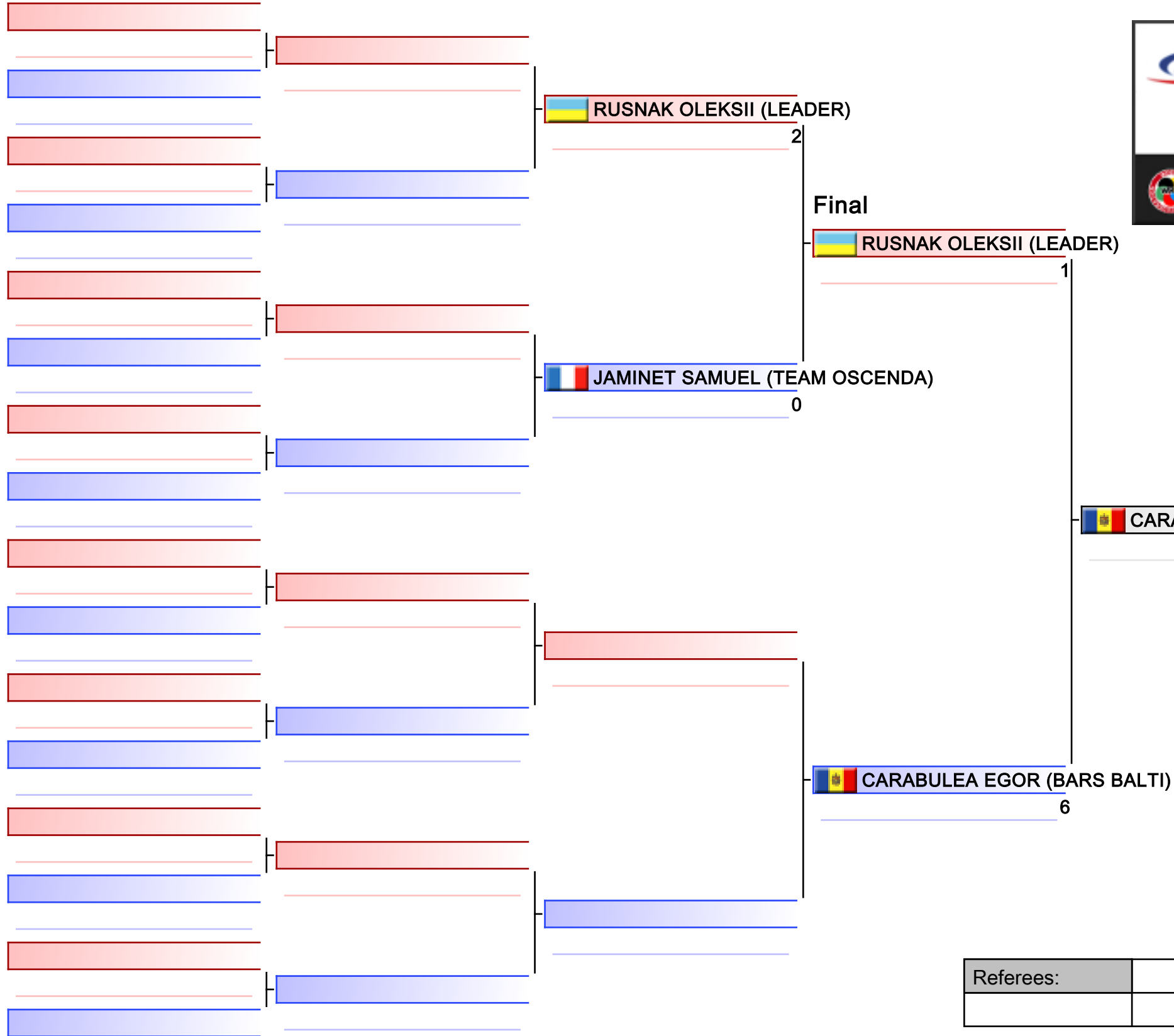

1. CARABULEA EGOR (BARS BALTI)
2. RUSNAK OLEKSII (LEADER)
3. JAMINET SAMUEL (TEAM OSCENDA)

Referees:			

KUMITE BOYS 9-10 YEARS -43kg

31ST KARATE GRAND PRIX CROATIA, CITY SPORTS HALL SAMOBOR, ANDRIJE HEBRANGA 26A, SAMOBOR, CROATIA, CRO

2023-01-22

Tatami
6 16:10

Pool
1/1

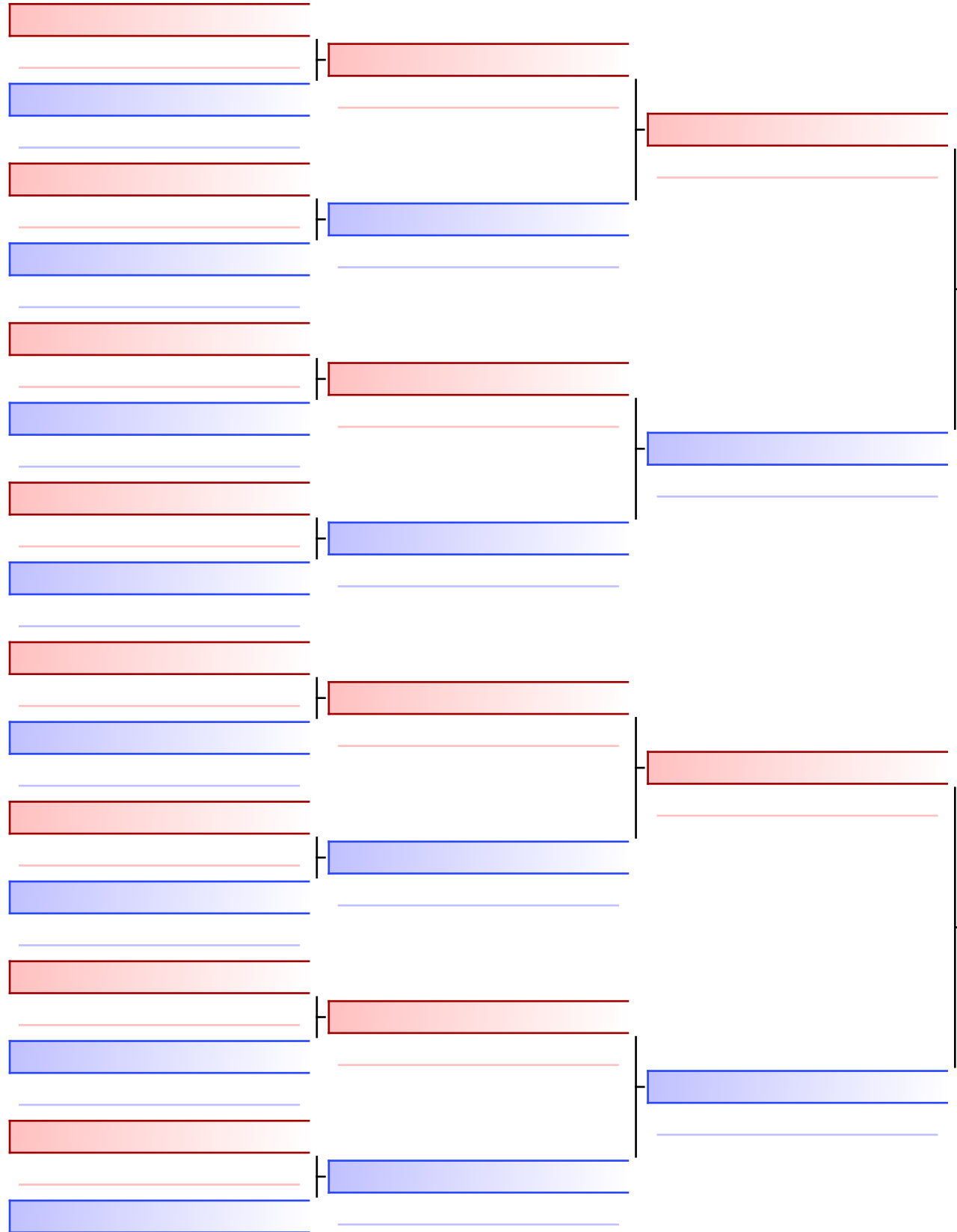

Final

HAMDAN NASSER (J.S.S.K)

0

BELLUZZI MATTEO (KARATE TEAM 1999)

BELLUZZI MATTEO (KARATE TEAM 1999)

8

1. BELLUZZI MATTEO (KARATE TEAM 1999)

2. HAMDAN NASSER (J.S.S.K)

Referees:			

KUMITE GIRLS 11-12 YEARS -49KG

31ST KARATE GRAND PRIX CROATIA, CITY SPORTS HALL SAMOBOR, ANDRIJE HEBRANGA 26A, SAMOBOR, CROATIA, CRO

2023-01-22

Tatami
6 16:15

Pool
1/1

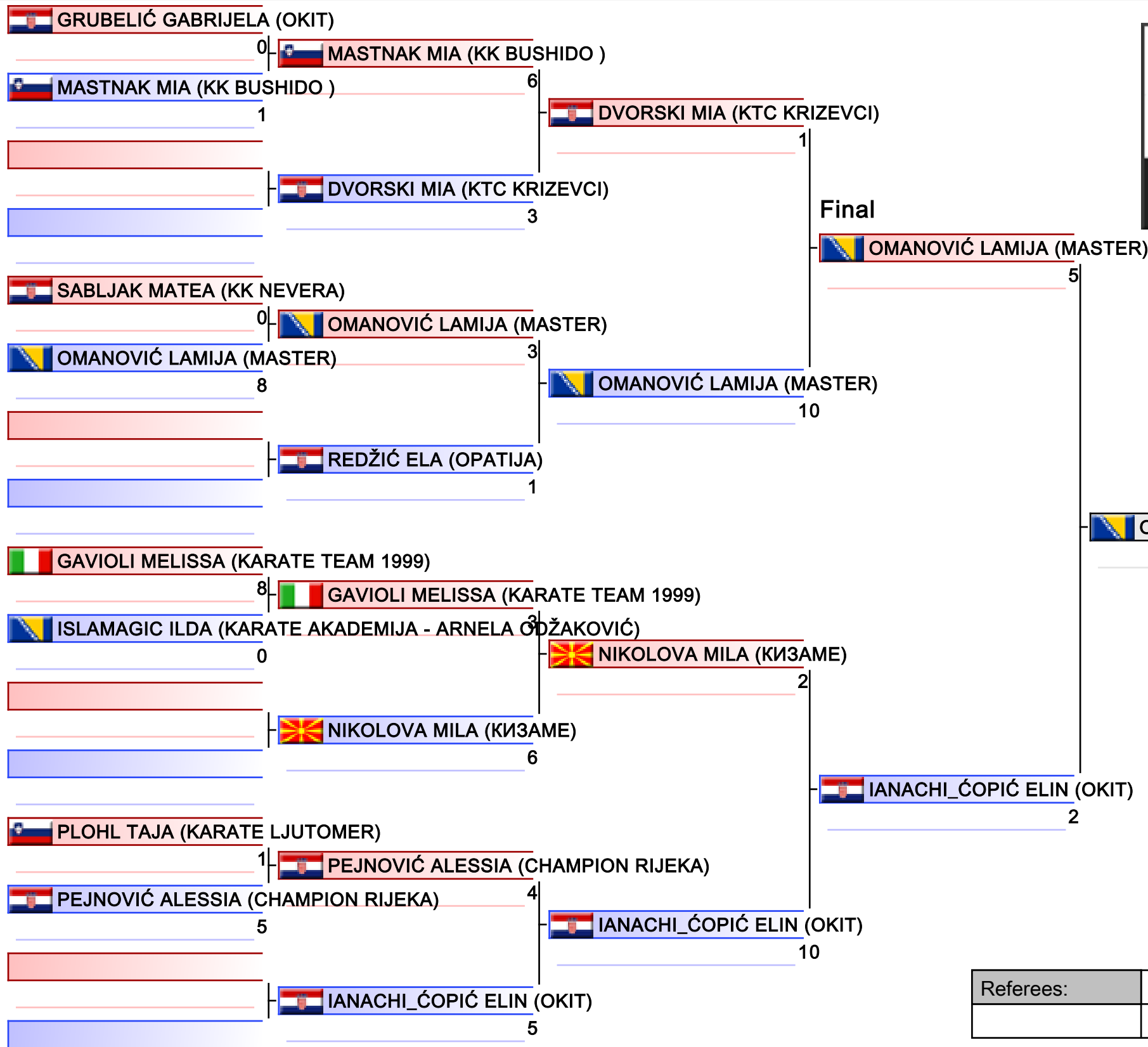

1. OMANOVIĆ LAMIJA (MASTER)
2. IANACHI_ĆOPIĆ ELIN (OKIT)
3. NIKOLOVA MILA (KIZAME)
3. DVORSKI MIA (KTC KRIZEVCI)
5. PEJNOVIĆ ALESSIA (CHAMPION RIJEKA)
5. REDŽIĆ ELA (OPATIJA)
7. SABLJAK MATEA (KK NEVERA)

Referees:			

KUMITE GIRLS 11-12 YEARS -54KG

31ST KARATE GRAND PRIX CROATIA, CITY SPORTS HALL SAMOBOR, ANDRIJE HEBRANGA 26A, SAMOBOR, CROATIA, CRO

2023-01-22

Tatami
4 17:00

Pool
1/1

 MEMIĆ SARA (RI)

 PERGALIA ANASTASIA_EIRINI (GR_482)

 PERGALIA ANASTASIA_EIRINI (GR_482)

8

 PERGALIA ANASTASIA_EIRINI (GR_482)

5

 KIŠ LANA (KKTS)

0

Final

 PERGALIA ANASTASIA_EIRINI (GR_482)

6

 KOCKAREVIĆ IVA (KK MAX)

1

 JELENKO NINA (SKK OPLOTNICA)

4

 JELENKO NINA (SKK OPLOTNICA)

4

 VIŠNJIĆ EMA (KKCROATIA)

3

 VURUŠIĆ TENA (GLOBUS)

3

 VURUŠIĆ TENA (GLOBUS)

4

 VURUŠIĆ TENA (GLOBUS)

0

 GARIBOVIĆ AJNA (KK TEMPO)

0

 PERGALIA AGATHI_AGAPI (GR_482)

11

 HADŽIĆ AZRA (KK KUMITE JAJCE)

4

 PERGALIA AGATHI_AGAPI (GR_482)

1

 PERGALIA AGATHI_AGAPI (GR_482)

8



1. PERGALIA AGATHI_AGAPI (GR_482)
2. PERGALIA ANASTASIA_EIRINI (GR_482)
3. JELENKO NINA (SKK OPLOTNICA)
3. HADŽIĆ AZRA (KK KUMITE JAJCE)
5. KIŠ LANA (KKTS)
5. VURUŠIĆ TENA (GLOBUS)

Referees:			

KUMITE GIRLS 13-14 YEARS +64KG

31ST KARATE GRAND PRIX CROATIA, CITY SPORTS HALL SAMOBOR, ANDRIJE HEBRANGA 26A, SAMOBOR, CROATIA, CRO

2023-01-22

Tatami
3 20:00

Pool
1/1

JANŽEKOVIČ NUŠA (KARATE LJUTOMER)

0 | **JANŽEKOVIČ NUŠA (KARATE LJUTOMER)**

LEDIĆ IRMA (KKHZ)

0 | **JANŽEKOVIČ NUŠA (KARATE LJUTOMER)**

0 | **JANŽEKOVIČ NUŠA (KARATE LJUTOMER)**

VOLPATO NICOL (POLISPORTIVA TERRAGLIO)

0 | **JANŽEKOVIČ NUŠA (KARATE LJUTOMER)**

HODZIC ISMIHANA (BOSNA)

0 | **SOFTIĆ AJNA (K.K RAŠID BUĆA)**

SOFTIĆ AJNA (K.K RAŠID BUĆA)

5 | **SOFTIĆ AJNA (K.K RAŠID BUĆA)**

0 | **SOFTIĆ AJNA (K.K RAŠID BUĆA)**

KRIZMAN LENA (CHAMPION RIJEKA)

4 | **SOFTIĆ AJNA (K.K RAŠID BUĆA)**

BANOVIĆ JANJA (K.K. OMLADINAC)

3 | **BANOVIĆ JANJA (K.K. OMLADINAC)**

STEFANCHUK SOFIIA (CHAMPION KARATE CLUB)

8 | **BANOVIĆ JANJA (K.K. OMLADINAC)**

0 | **BANOVIĆ JANJA (K.K. OMLADINAC)**

FEROLA GIORGIA (PRO-TEAM ASD)

0 | **BANOVIĆ JANJA (K.K. OMLADINAC)**

BARUKČIĆ ANA_MARIE (KKTS)

4 | **BANOVIĆ JANJA (K.K. OMLADINAC)**

0 | **BARUKČIĆ ANA_MARIE (KKTS)**

LOVRIĆ KLARA (KKHZ)

0 | **BARUKČIĆ ANA_MARIE (KKTS)**

0 | **BARUKČIĆ ANA_MARIE (KKTS)**

Final

JANŽEKOVIČ NUŠA (KARATE LJUTOMER)

0 | **BANOVIĆ JANJA (K.K. OMLADINAC)**

0 | **BANOVIĆ JANJA (K.K. OMLADINAC)**

0 | **BANOVIĆ JANJA (K.K. OMLADINAC)**

0 | **BANOVIĆ JANJA (K.K. OMLADINAC)**

0 | **BANOVIĆ JANJA (K.K. OMLADINAC)**

0 | **BANOVIĆ JANJA (K.K. OMLADINAC)**

0 | **BANOVIĆ JANJA (K.K. OMLADINAC)**

0 | **BANOVIĆ JANJA (K.K. OMLADINAC)**

0 | **BANOVIĆ JANJA (K.K. OMLADINAC)**

0 | **BANOVIĆ JANJA (K.K. OMLADINAC)**

0 | **BANOVIĆ JANJA (K.K. OMLADINAC)**

0 | **BANOVIĆ JANJA (K.K. OMLADINAC)**

0 | **BANOVIĆ JANJA (K.K. OMLADINAC)**

0 | **BANOVIĆ JANJA (K.K. OMLADINAC)**

0 | **BANOVIĆ JANJA (K.K. OMLADINAC)**

0 | **BANOVIĆ JANJA (K.K. OMLADINAC)**

0 | **BANOVIĆ JANJA (K.K. OMLADINAC)**

0 | **BANOVIĆ JANJA (K.K. OMLADINAC)**

0 | **BANOVIĆ JANJA (K.K. OMLADINAC)**

0 | **BANOVIĆ JANJA (K.K. OMLADINAC)**

0 | **BANOVIĆ JANJA (K.K. OMLADINAC)**

0 | **BANOVIĆ JANJA (K.K. OMLADINAC)**

0 | **BANOVIĆ JANJA (K.K. OMLADINAC)**

0 | **BANOVIĆ JANJA (K.K. OMLADINAC)**

0 | **BANOVIĆ JANJA (K.K. OMLADINAC)**

0 | **BANOVIĆ JANJA (K.K. OMLADINAC)**

0 | **BANOVIĆ JANJA (K.K. OMLADINAC)**



- | |
|---|
| 1. BANOVIĆ JANJA (K.K. OMLADINAC) |
| 2. JANŽEKOVIČ NUŠA (KARATE LJUTOMER) |
| 3. SOFTIĆ AJNA (K.K RAŠID BUĆA) |
| 3. BARUKČIĆ ANA_MARIE (KKTS) |
| 5. LEDIĆ IRMA (KKHZ) |
| 5. STEFANCHUK SOFIIA (CHAMPION KARATE CLUB) |
| 7. VOLPATO NICOL (POLISPORTIVA TERRAGLIO) |
| 7. FEROLA GIORGIA (PRO-TEAM ASD) |

Referees:			

KUMITE GIRLS 13-14 YEARS -44KG

31ST KARATE GRAND PRIX CROATIA, CITY SPORTS HALL SAMOBOR, ANDRIJE HEBRANGA 26A, SAMOBOR, CROATIA, CRO

2023-01-22

Tatami 3 18:40

Pool 1/1

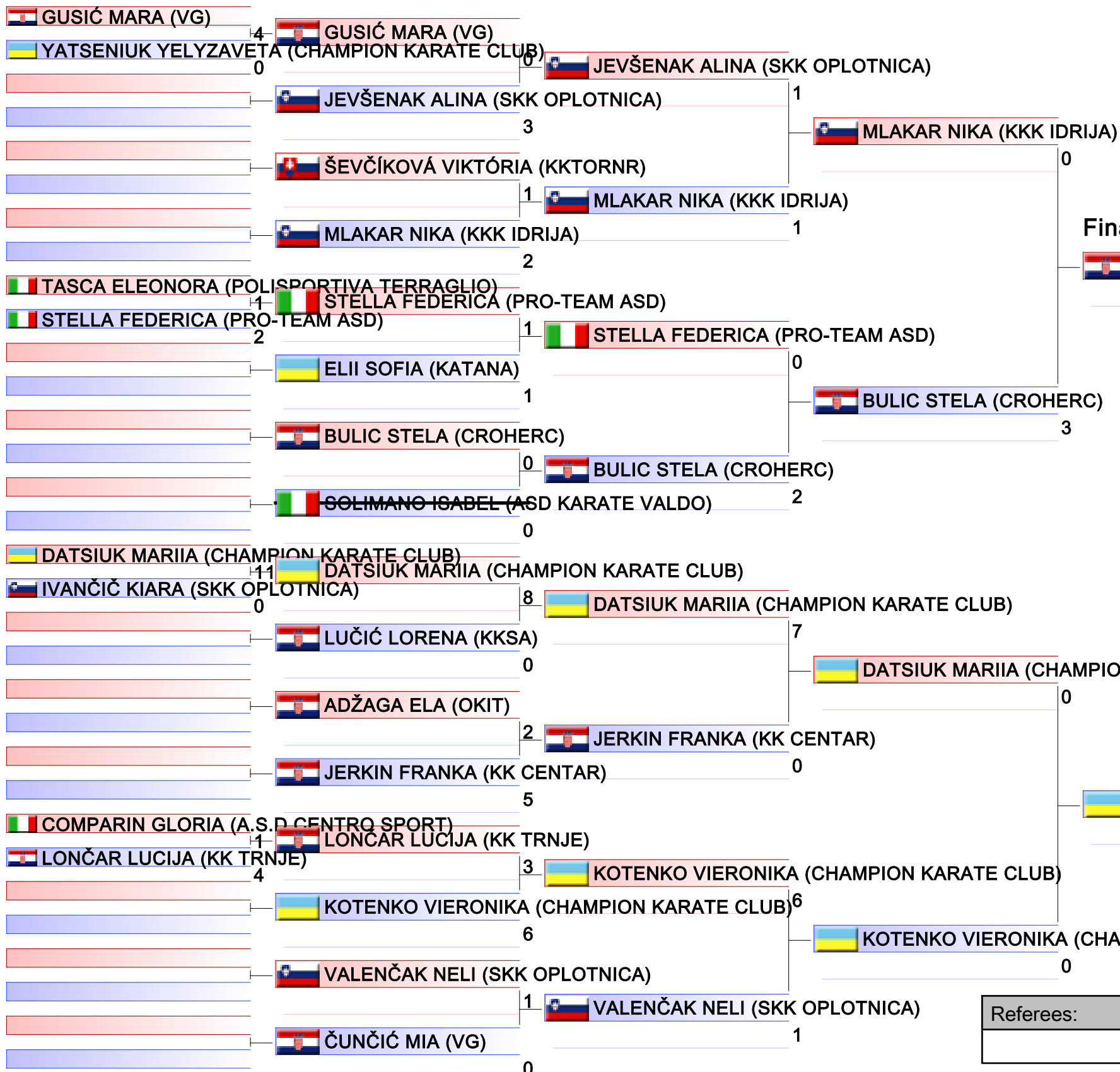

1. BULIC STELA (CROHERC)
2. DATSIUK MARIIA (CHAMPION KARATE CLUB)
3. STELLA FEDERICA (PRO-TEAM ASD)
3. KOTENKO VIERONIKA (CHAMPION KARATE CLUB)
5. MLAKAR NIKA (KKK IDRIJA)
5. IVANČIČ KIARA (SKK OPLOTNICA)
7. JERKIN FRANKA (KK CENTAR)

Referees:			

KUMITE GIRLS 13-14 YEARS -49KG

31ST KARATE GRAND PRIX CROATIA, CITY SPORTS HALL SAMOBOR, ANDRIJE HEBRANGA 26A, SAMOBOR, CROATIA, CRO

2023-01-22

Tatami
4 18:35

Pool
1/1

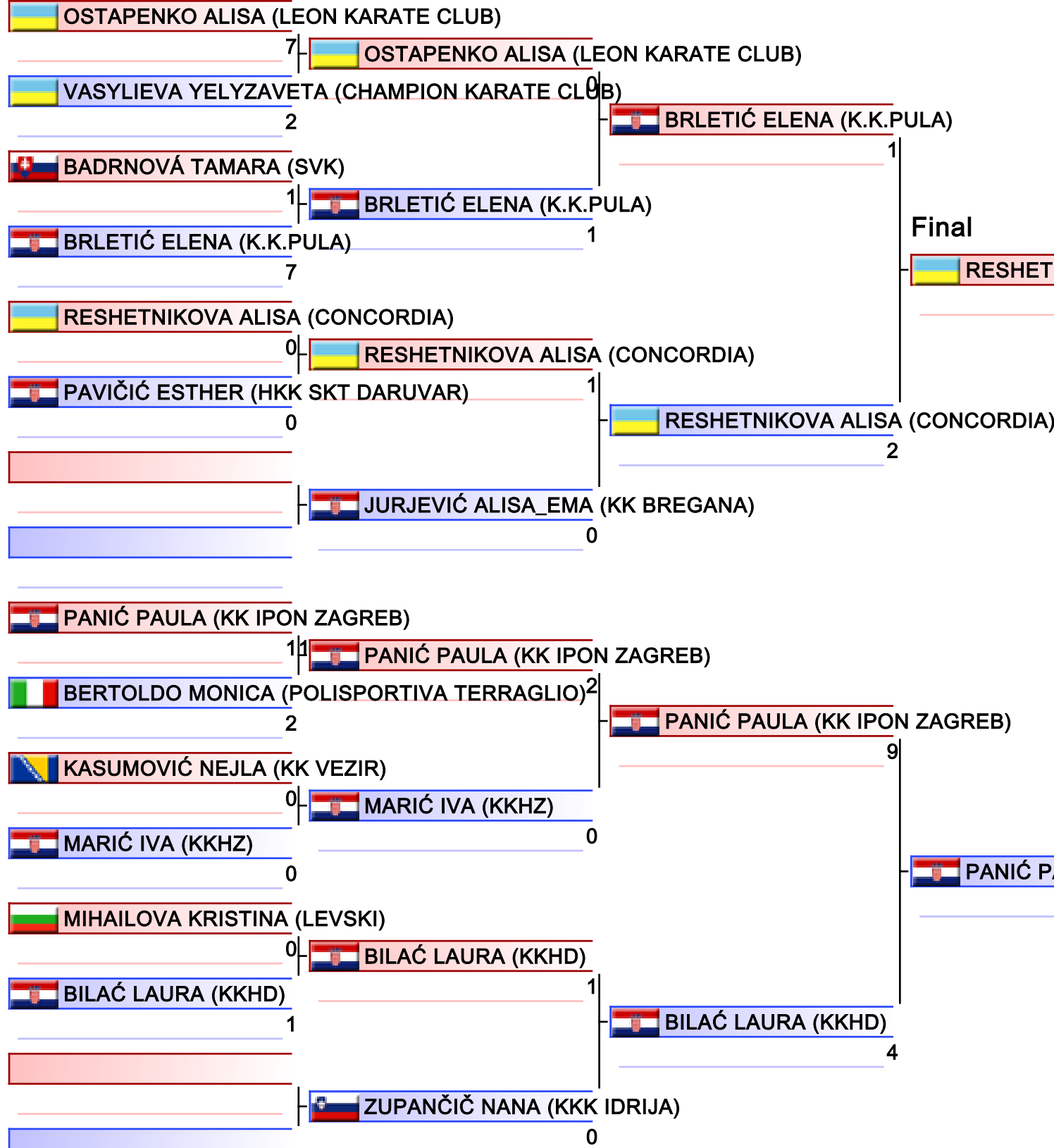

1. PANIĆ PAULA (KK IPON ZAGREB)
2. RESHETNIKOVA ALISA (CONCORDIA)
3. BRLETIĆ ELENA (K.K.PULA)
3. MARIĆ IVA (KKHZ)
5. JURJEVIĆ ALISA_EMA (KK BREGANA)
5. BILAĆ LAURA (KKHD)
7. PAVIČIĆ ESTHER (HKK SKT DARUVAR)
7. BERTOLDO MONICA (POLISPORTIVA TERRAGLIO)

Referees:			

KUMITE GIRLS 13-14 YEARS -54KG

31ST KARATE GRAND PRIX CROATIA, CITY SPORTS HALL SAMOBOR, ANDRIJE HEBRANGA 26A, SAMOBOR, CROATIA, CRO

2023-01-22

Tatami
6 19:30

Pool
1/1

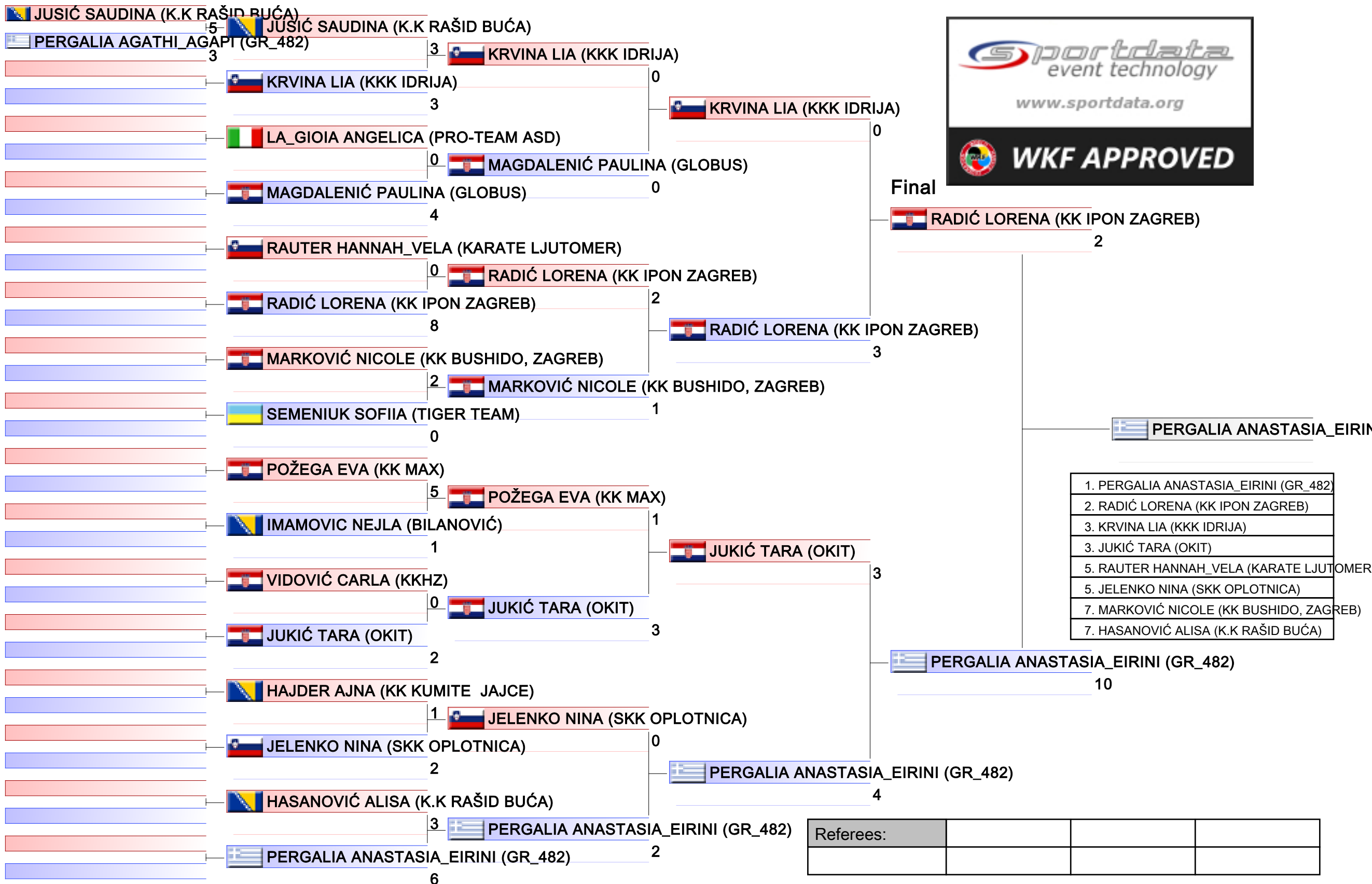

Referees:			

KUMITE GIRLS 13-14 YEARS -59KG

31ST KARATE GRAND PRIX CROATIA, CITY SPORTS HALL SAMOBOR, ANDRIJE HEBRANGA 26A, SAMOBOR, CROATIA, CRO

2023-01-22

Tatami
5 19:35

Pool
1/1

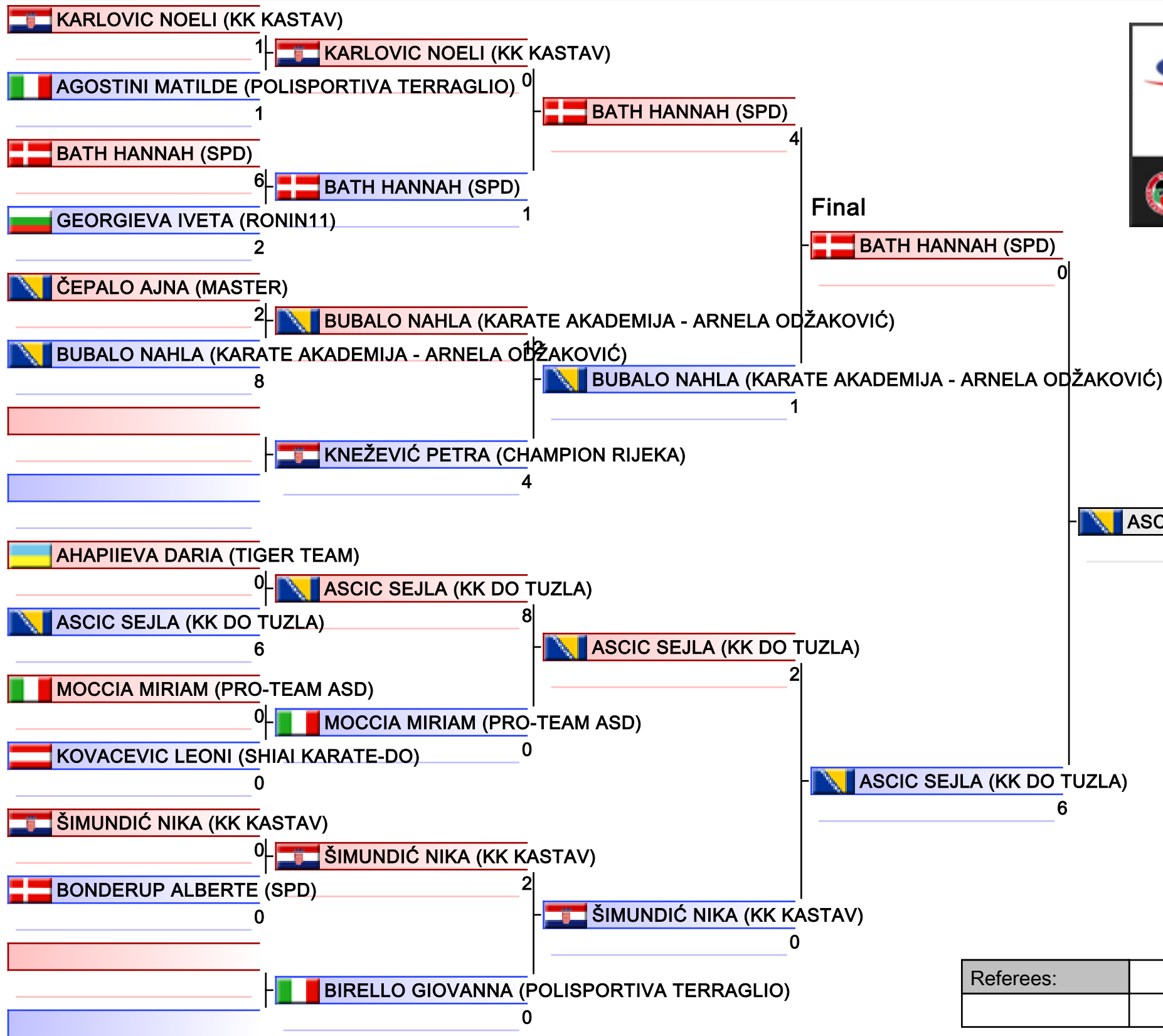

1. ASCIC SEJLA (KK DO TUZLA)
2. BATH HANNAH (SPD)
3. KARLOVIC NOELI (KK KASTAV)
3. ŠIMUNDIĆ NIKA (KK KASTAV)
5. BUBALO NAHLA (KARATE AKADEMIJA - ARNELA ODŽAKOVIĆ)
5. AHAPIIEVA DARIA (TIGER TEAM)
7. GEORGIEVA IVETA (RONIN11)
7. MOCCIA MIRIAM (PRO-TEAM ASD)

Referees:			

KUMITE GIRLS 13-14 YEARS -64KG

31ST KARATE GRAND PRIX CROATIA, CITY SPORTS HALL SAMOBOR, ANDRIJE HEBRANGA 26A, SAMOBOR, CROATIA, CRO

2023-01-22

Tatami
4 19:50

Pool
1/1

 BRAČUN_MAŠERA IRIS (SOKOL)

 FILIPOVIĆ MARTA (KKHZ)

 FILIPOVIĆ MARTA (KKHZ)

0

 FILIPOVIĆ MARTA (KKHZ)

5

 SAHINOVIC MEDINA (BILANOVIĆ)

0

Final

 FILIPOVIĆ MARTA (KKHZ)

3

 RONCAGLIA MARIA (K. A. V.)

1

 MIZRAHI YAARA (JKSISR)

0

 MIZRAHI YAARA (JKSISR)

0

 ĐUĐUKOVIĆ NINA (RI)

 CORREDDU NICOLE (WWKRT SORSO)

4

 CORREDDU NICOLE (WWKRT SORSO)

 CORREDDU NICOLE (WWKRT SORSO)

1

 TAHIROVA MARIIA (TIGER TEAM)

3

 TAHIROVA MARIIA (TIGER TEAM)

0

 BAGOSI MARIANNA (SZARVAS)

0

 FILIPOVIĆ MARTA (KKHZ)



- | |
|----------------------------------|
| 1. FILIPOVIĆ MARTA (KKHZ) |
| 2. CORREDDU NICOLE (WWKRT SORSO) |
| 3. TAHIROVA MARIIA (TIGER TEAM) |
| 3. SAHINOVIC MEDINA (BILANOVIĆ) |
| 5. MIZRAHI YAARA (JKSISR) |
| 7. BRAČUN_MAŠERA IRIS (SOKOL) |
| |
| |

Referees:			

KUMITE GIRLS 9-10 YEARS -27kg

31ST KARATE GRAND PRIX CROATIA, CITY SPORTS HALL SAMOBOR, ANDRIJE HEBRANGA 26A, SAMOBOR, CROATIA, CRO

2023-01-22

Tatami
1 16:00

Pool
1/1

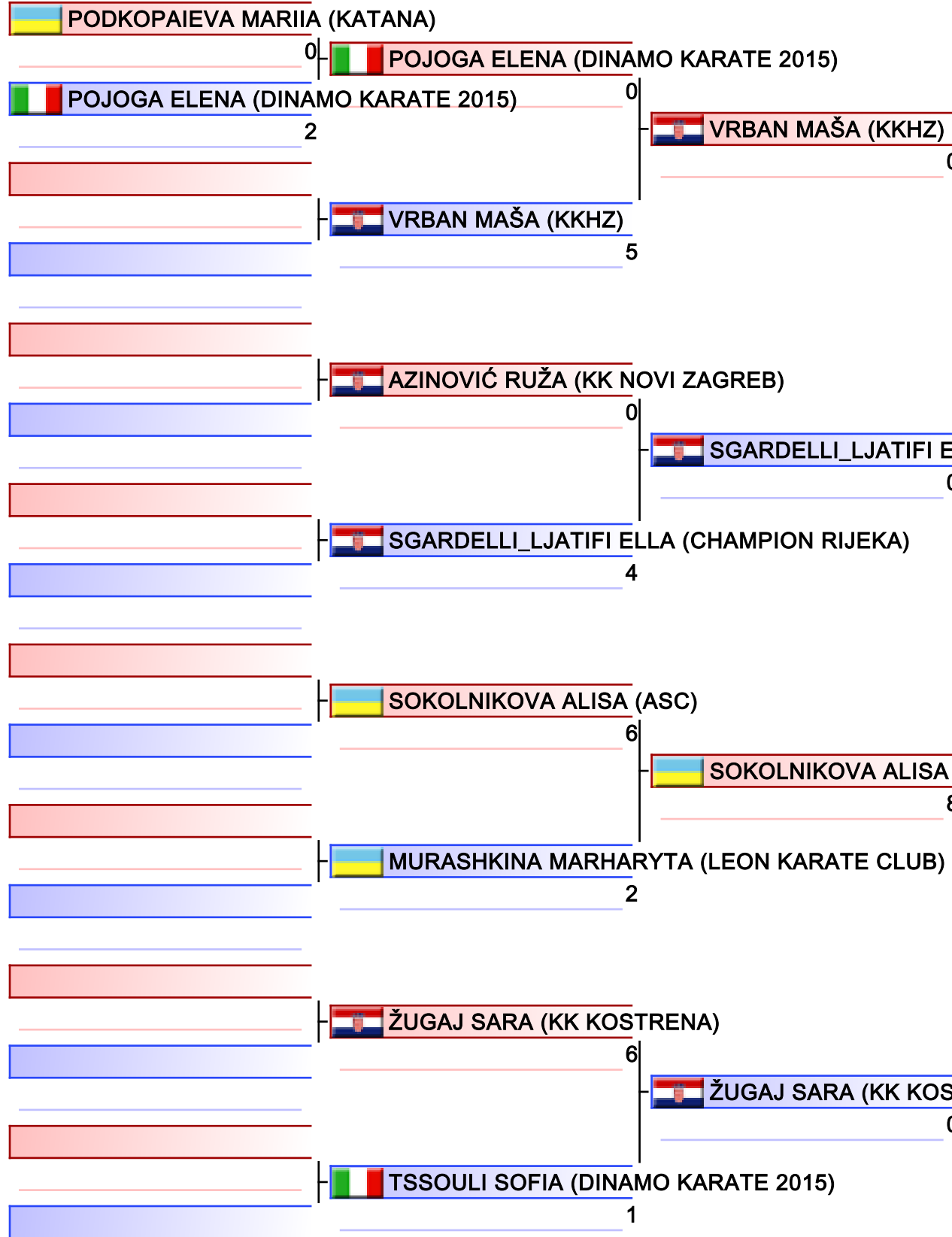

Final

SGARDELLI_LJATIFI ELLA (CHAMPION RIJEKA) (7)

SGARDELLI_LJATIFI ELLA (CHAMPION RIJEKA)

- | |
|---|
| 1. SGARDELLI_LJATIFI ELLA (CHAMPION RIJEKA) |
| 2. SOKOLNIKOVA ALISA (ASC) |
| 3. VRBAN MAŠA (KKHZ) |
| 3. MURASHKINA MARHARYTA (LEON KARATE CLUB) |
| 5. AZINOVIĆ RUŽA (KK NOVI ZAGREB) |
| 5. ŽUGAJ SARA (KK KOSTRENA) |
| |
| |



Referees:			

KUMITE GIRLS 9-10 YEARS -31kg

31ST KARATE GRAND PRIX CROATIA, CITY SPORTS HALL SAMOBOR, ANDRIJE HEBRANGA 26A, SAMOBOR, CROATIA, CRO

2023-01-22

Tatami
2 15:05

Pool
1/1

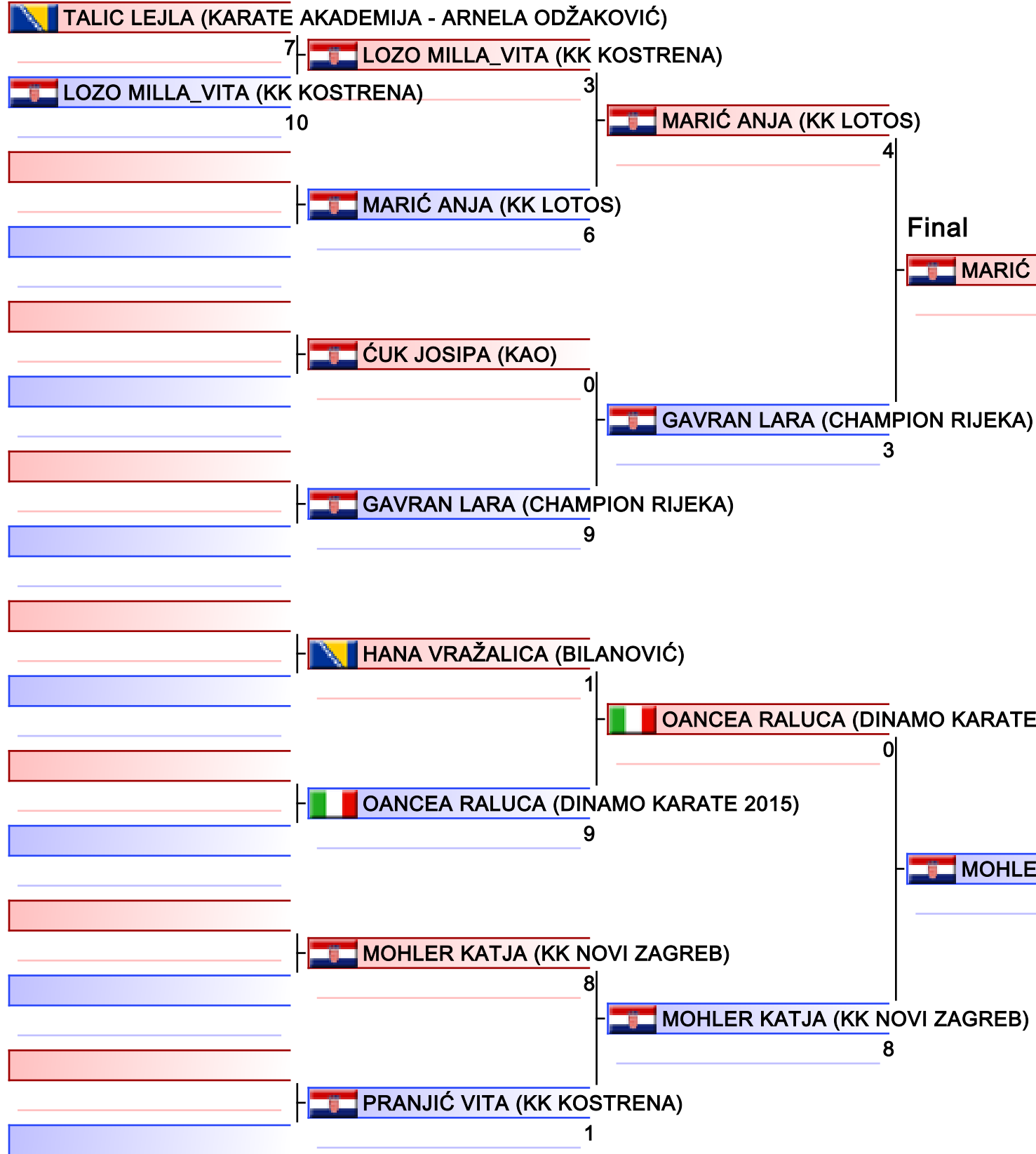

1. MARIĆ ANJA (KK LOTOS)
2. MOHLER KATJA (KK NOVI ZAGREB)
3. LOZO MILLA_VITA (KK KOSTRENA)
3. PRANJIĆ VITA (KK KOSTRENA)
5. GAVRAN LARA (CHAMPION RIJEKA)
5. OANCEA RALUCA (DINAMO KARATE 2015)

Referees:			

KUMITE GIRLS 9-10 YEARS -35kg

31ST KARATE GRAND PRIX CROATIA, CITY SPORTS HALL SAMOBOR, ANDRIJE HEBRANGA 26A, SAMOBOR, CROATIA, CRO

2023-01-22

Tatami
2 15:45

Pool
1/1

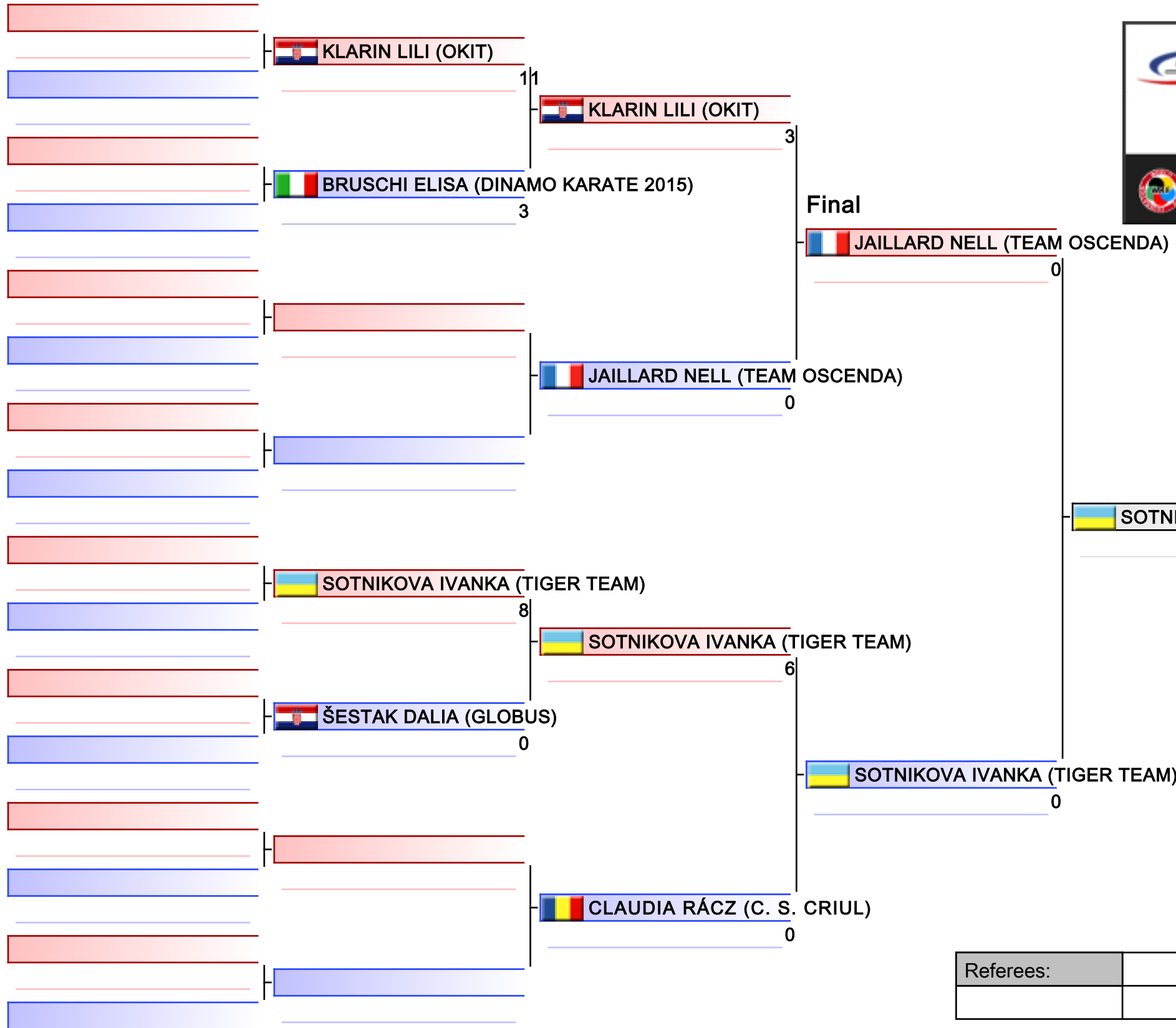

1. SOTNIKOVA IVANKA (TIGER TEAM)
2. JAILLARD NELL (TEAM OSCENDA)
3. KLARIN LILI (OKIT)
3. ŠESTAK DALIA (GLOBUS)
5. CLAUDIA RÁCZ (C. S. CRIUL)

Referees:			

KUMITE GIRLS 9-10 YEARS -39kg

31ST KARATE GRAND PRIX CROATIA, CITY SPORTS HALL SAMOBOR, ANDRIJE HEBRANGA 26A, SAMOBOR, CROATIA, CRO

2023-01-22

Tatami
2 16:05

Pool
1/1

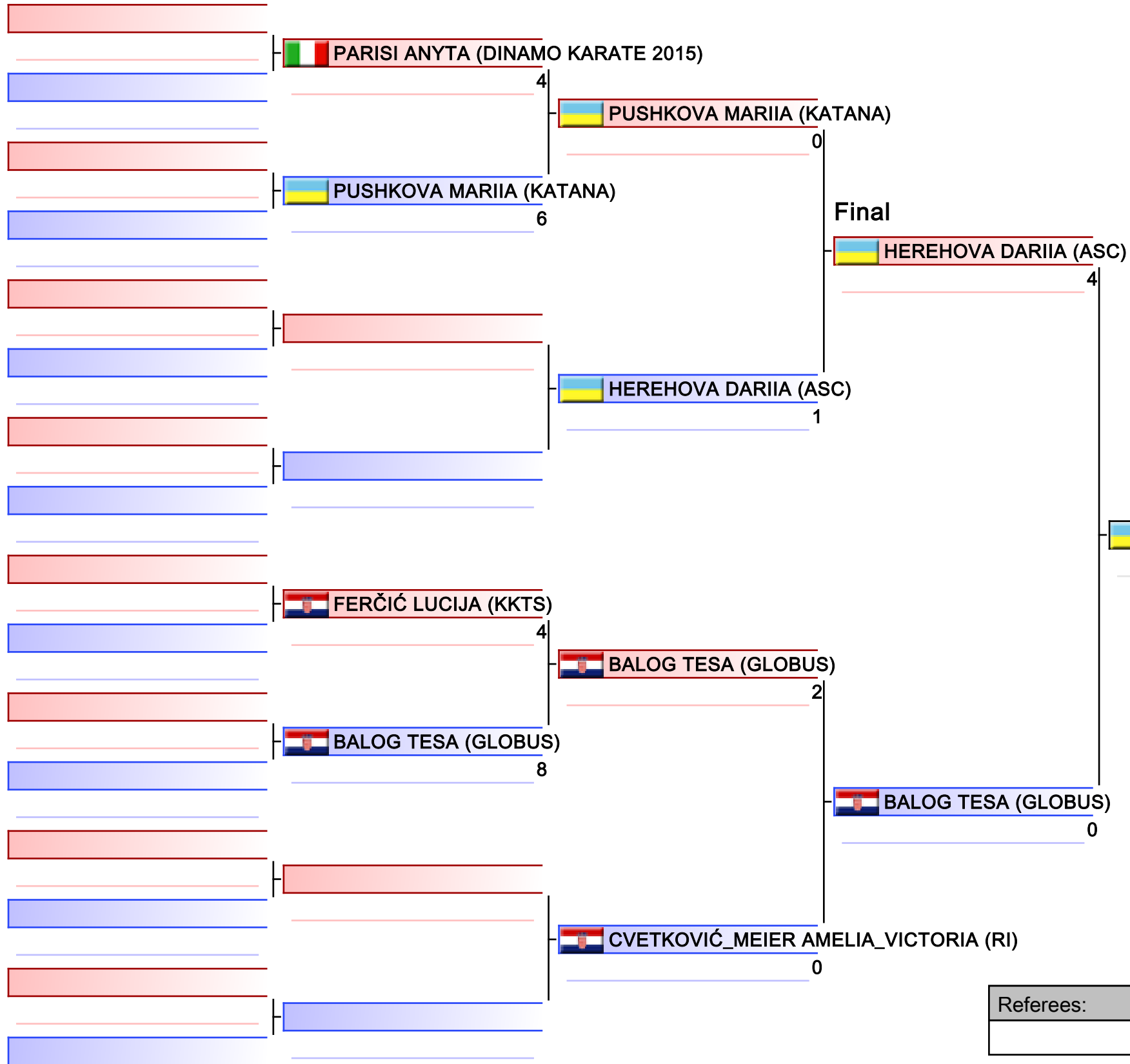

1. HEREHOVA DARIIA (ASC)
2. BALOG TESA (GLOBUS)
3. PUSHKOVA MARIIA (KATANA)
3. FERČIĆ LUCIJA (KKTS)
5. CVETKOVIĆ_MEIER AMELIA_VICTORIA (RI)

Referees:			

KUMITE MALE SENIORS

31ST KARATE GRAND PRIX CROATIA, CITY SPORTS HALL SAMOBOR, ANDRIJE HEBRANGA 26A, SAMOBOR, CROATIA, CRO

2023-01-21

Tatami
1 18:00

Pool
1/4

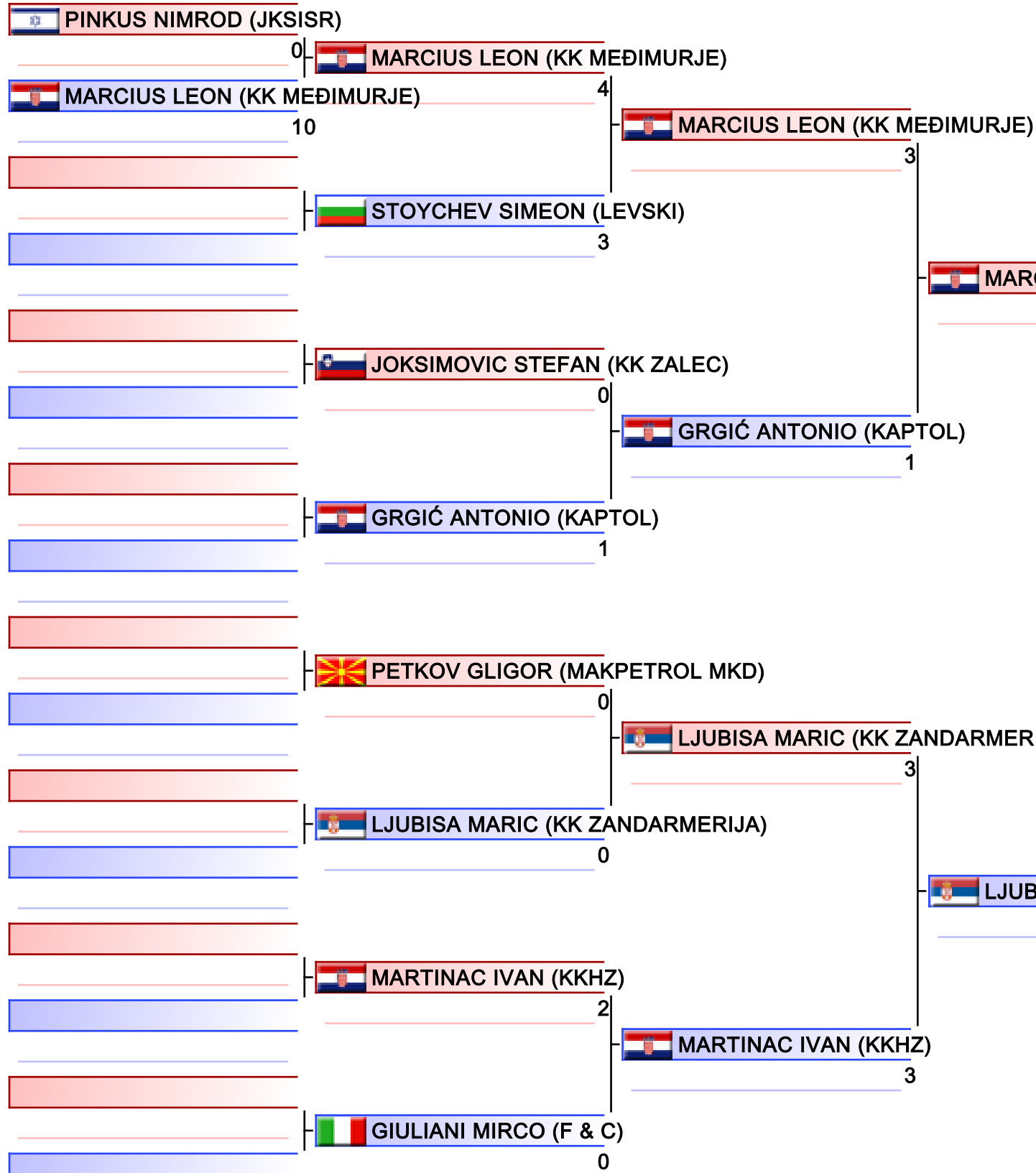

Referees:			

KUMITE MALE SENIORS

31ST KARATE GRAND PRIX CROATIA, CITY SPORTS HALL SAMOBOR, ANDRIJE HEBRANGA 26A, SAMOBOR, CROATIA, CRO

2023-01-21

Tatami
2 18:00

Pool
2/4

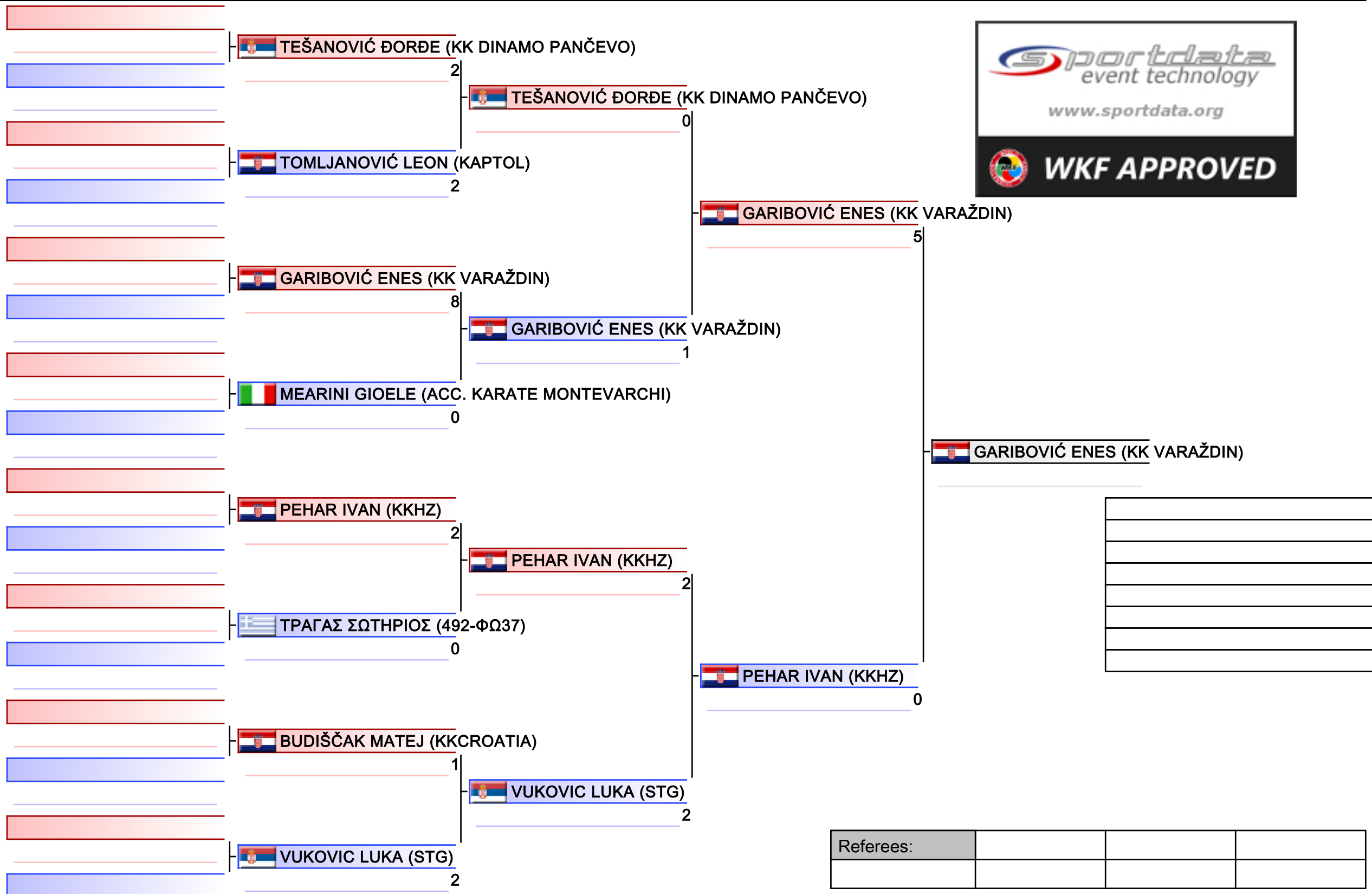

Referees:			

KUMITE MALE SENIORS

31ST KARATE GRAND PRIX CROATIA, CITY SPORTS HALL SAMOBOR, ANDRIJE HEBRANGA 26A, SAMOBOR, CROATIA, CRO

2023-01-21

Tatami
3 17:25

Pool
3/4

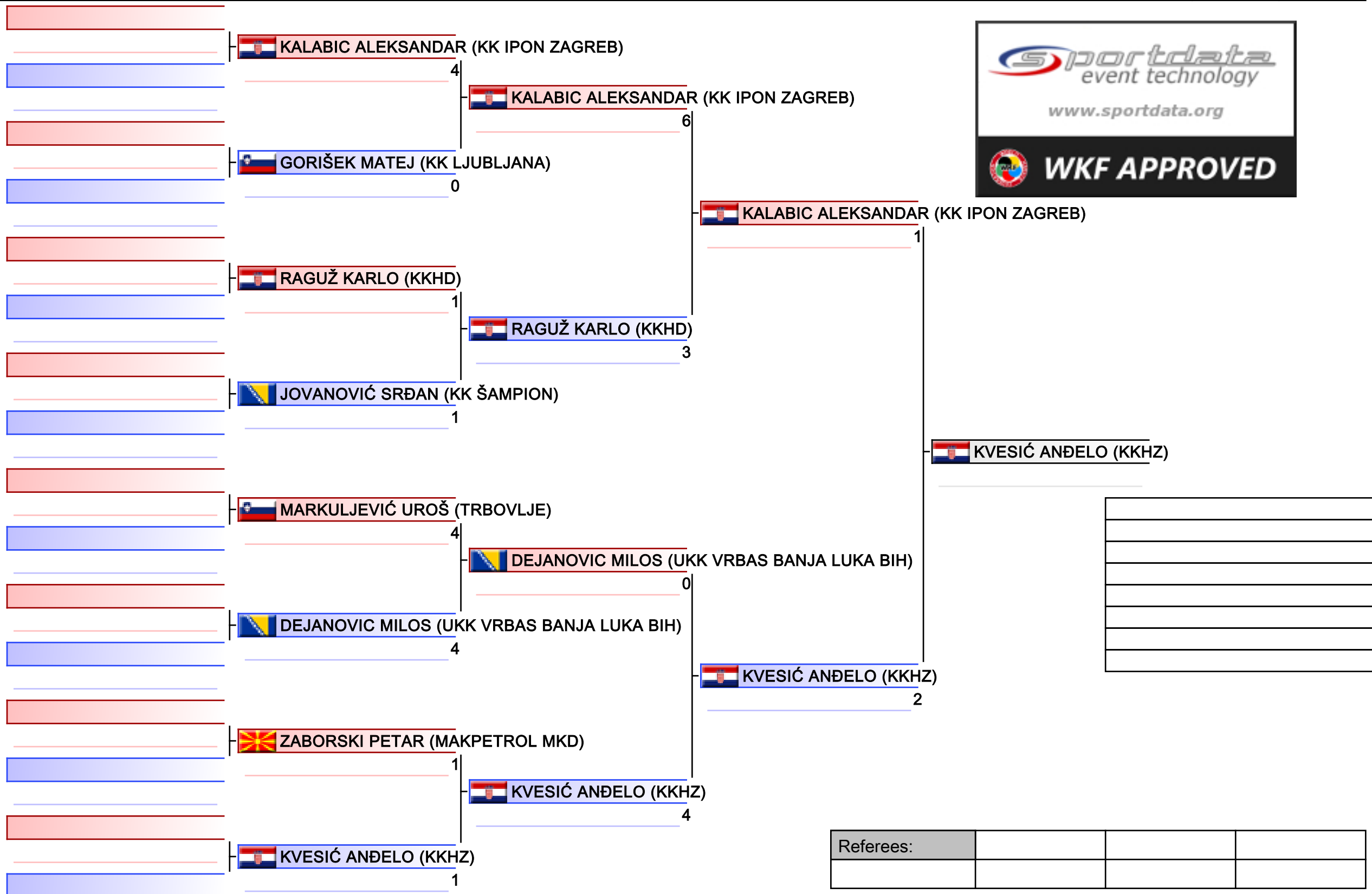

Referees:			

KUMITE MALE SENIORS

31ST KARATE GRAND PRIX CROATIA, CITY SPORTS HALL SAMOBOR, ANDRIJE HEBRANGA 26A, SAMOBOR, CROATIA, CRO

2023-01-21

Tatami
4 17:25

Pool
4/4

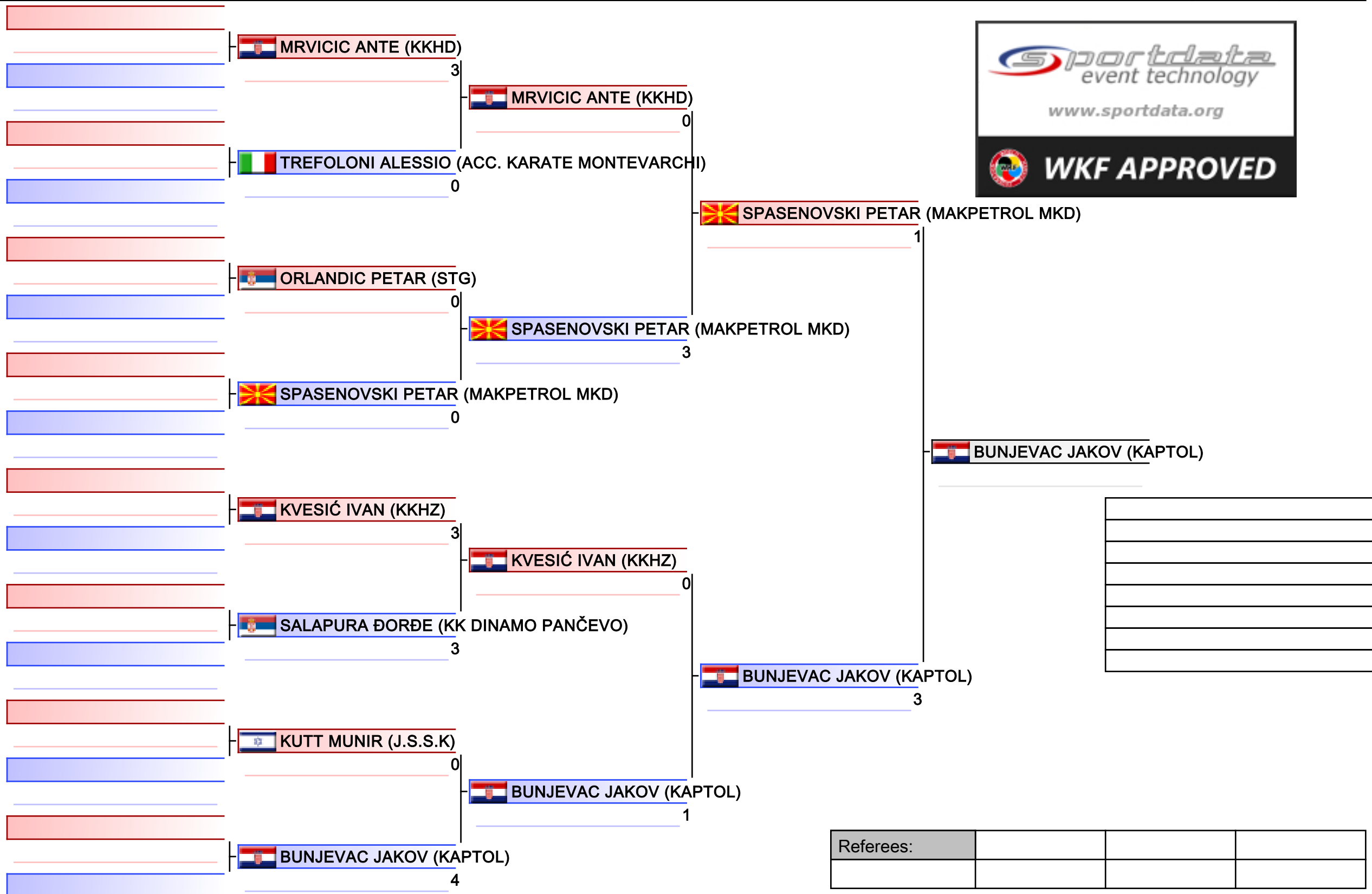

Kumite Female U21 -55kg

31ST KARATE GRAND PRIX CROATIA, CITY SPORTS HALL SAMOBOR, ANDRIJE HEBRANGA 26A, SAMOBOR, CROATIA, CRO

2023-01-21

Tatami
2 10:00

Pool
1/2

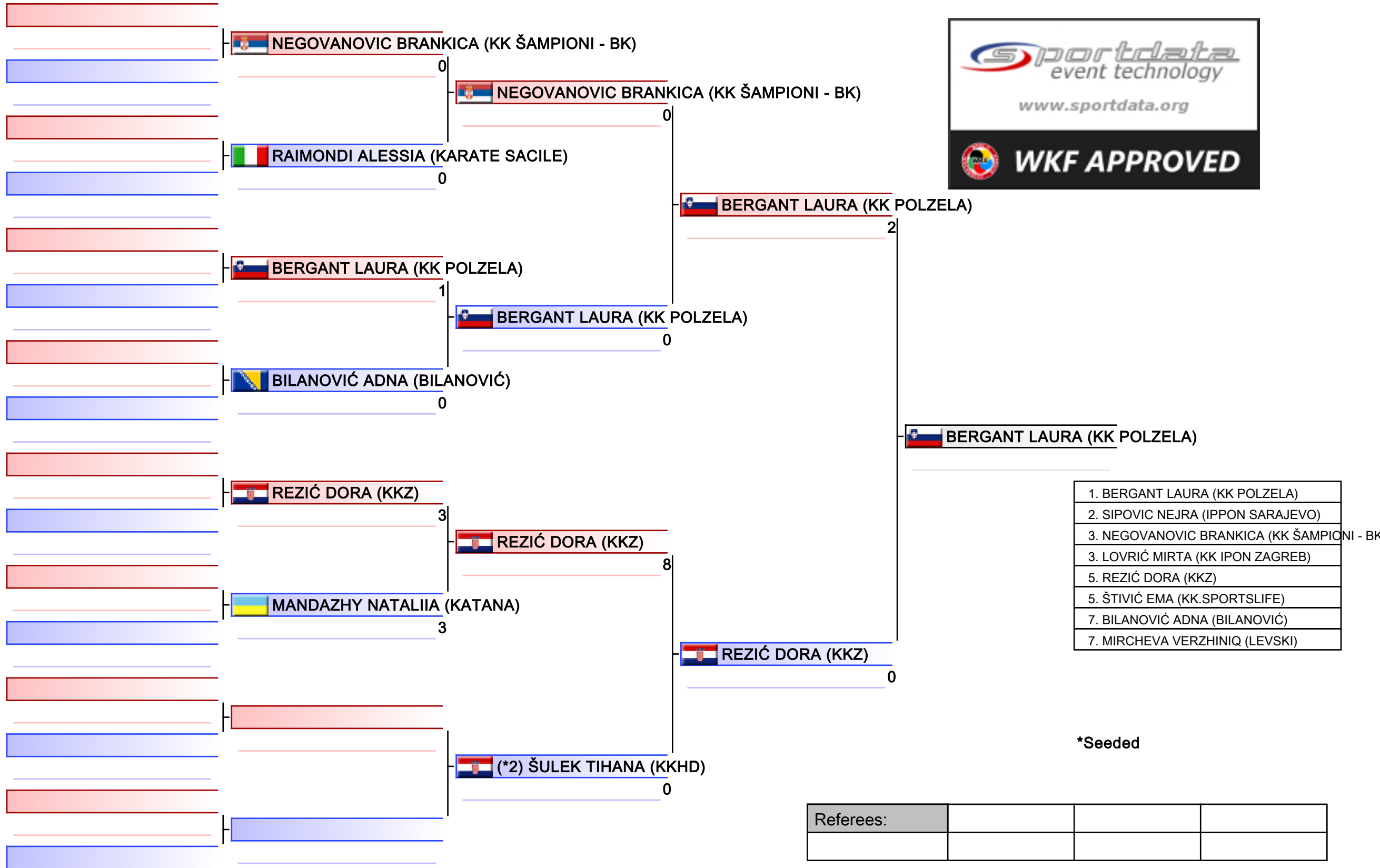

1. BERGANT LAURA (KK POLZELA)
2. SIPOVIC NEJRA (IPPON SARAJEVO)
3. NEGOVANOVIC BRANKICA (KK ŠAMPIONI - BK)
3. LOVRIĆ MIRTA (KK IPON ZAGREB)
5. REZIĆ DORA (KKZ)
5. ŠTIVIĆ EMA (KK.SPORTSLIFE)
7. BILANOVIĆ ADNA (BILANOVIĆ)
7. MIRCHEVA VERZHINIQ (LEVSKI)

*Seeded

Referees:			

Kumite Female U21 -55kg

31ST KARATE GRAND PRIX CROATIA, CITY SPORTS HALL SAMOBOR, ANDRIJE HEBRANGA 26A, SAMOBOR, CROATIA, CRO

2023-01-21

Tatami
1 10:05

Pool
2/2

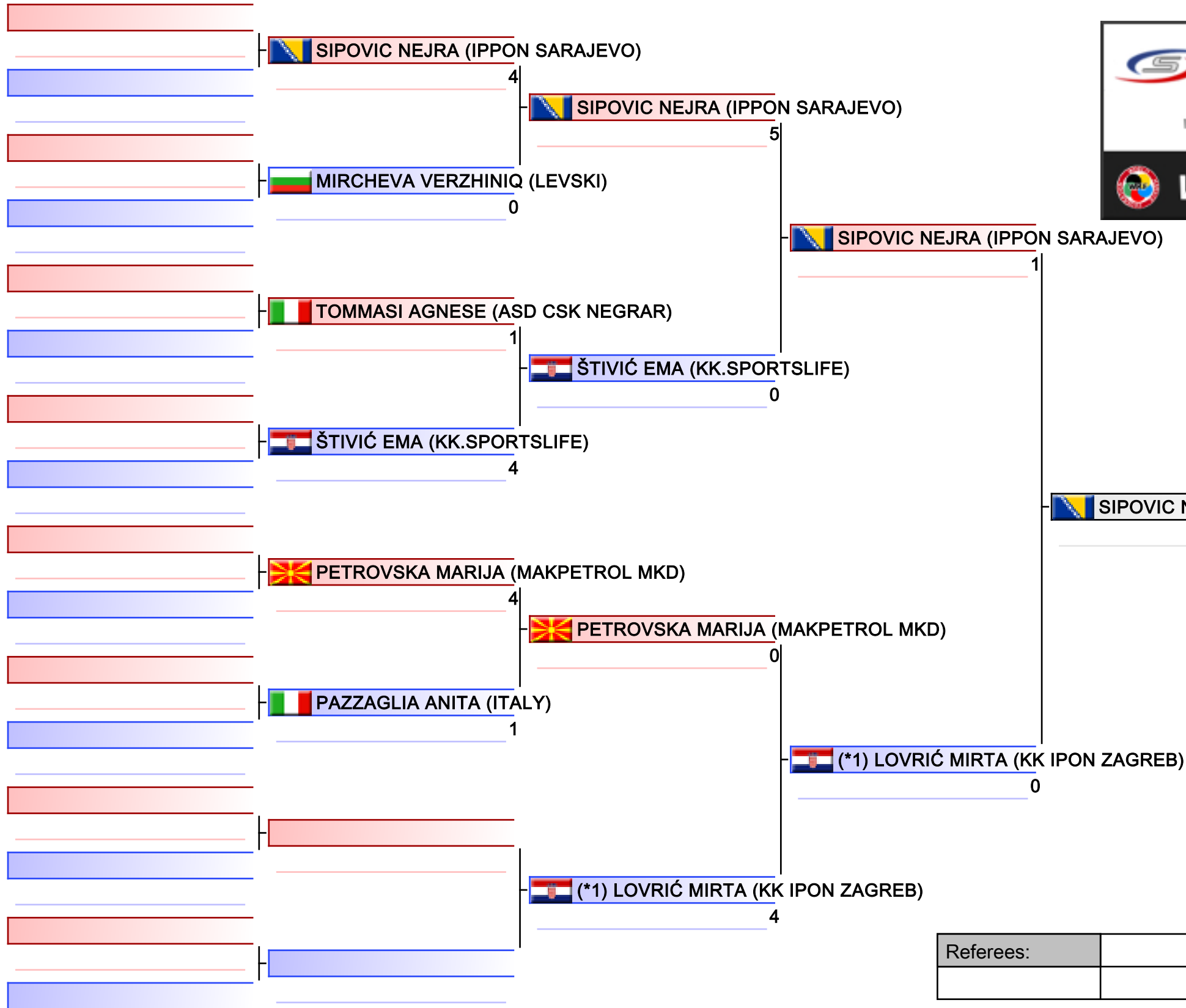

1. BERGANT LAURA (KK POLZELA)
2. SIPOVIC NEJRA (IPPON SARAJEVO)
3. NEGOVANOVIĆ BRANKICA (KK ŠAMPIONI - BK)
3. LOVRIĆ MIRTA (KK IPON ZAGREB)
5. REZIĆ DORA (KKZ)
5. ŠTIVIĆ EMA (KK.SPORTSLIFE)
7. BILANOVIĆ ADNA (BILANOVIĆ)
7. MIRCHEVA VERZHINIQ (LEVSKI)

*Seeded

Referees:			

31ST KARATE GRAND PRIX CROATIA - 2023-01-20

KATA FEMALE JUNIORS

R1 G1/4 (8) Tatami 3 15:15(2023-01-20)

Competitors	Kata	1	2	3	4	5	6	7	TOTAL	Extra Total Rank
1 BRKAN LUKRECIJA (KK ALFA)										
2 CAPPELLATO MARIA (SSKR)	001 ANAN	(7.6)	(7.0)	7.4	7.4	7.5			22.3	22.3 5
3 VIELMI ELISA (MASTER RAPID SKF CBL)	030 HEIKU	(7.9)	7.4	(7.0)	7.1	7.4			21.9	21.9 7
4 KONTREC ALJA (KK MAWASHI)	020 GOJUSHIHO DAI	(7.7)	7.5	(6.6)	7.0	7.6			22.1	22.1 6
5 IPPOLITI IRENE (SKZP)	068 PAPUREN	(7.8)	7.7	(7.2)	7.3	7.3			22.3	22.3 4
6 FODOR AMIRA (KSI)	065 OYADOMARI NO PASSAI	(7.0)	(7.9)	7.8	7.2	7.8			22.8	22.8 3
7 ALEKSANDROVA POLINA (OKI)	092 SUPARINPEI	(6.9)	(8.0)	8.0	7.6	7.7			23.3	23.3 2
8 STANGHERLIN SOFIA (SPORT TARGET)	068 PAPUREN	(8.5)	8.1	(7.7)	7.7	8.0			23.8	23.8 1

R1 G2/4 (7) Tatami 3 15:55(2023-01-20)

Competitors	Kata	1	2	3	4	5	6	7	TOTAL	Extra Total Rank
1 VERDONE MELISSA (MASTER RAPID SKF CBL)	002 ANAN DAI	(7.3)	7.6	(7.8)	7.4	7.6			22.6	22.6 3
2 ZORI ANNA (KARATE DO TRIESTE)	020 GOJUSHIHO DAI	(7.0)	7.4	7.0	7.0	(7.7)			21.4	21.4 6
3 KHOLODNIK DARIA (ZAKHYST)	002 ANAN DAI	(7.1)	(7.5)	7.4	7.5	7.5			22.4	22.4 4
4 CELO SIMA (LZKNÓ)	030 HEIKU	(8.6)	7.8	8.2	(7.7)	7.9			23.9	23.9 1
5 NIKOLIC MINA (BEOGRAD)	020 GOJUSHIHO DAI	(8.2)	8.0	8.0	(7.6)	7.8			23.8	23.8 2
6 NOAM YUVAL (JKSISR)	012 ENPI	6.6	6.4	6.4	(5.8)	(6.9)			19.4	19.4 7
7 BULJAN TEA (KKSHIHAN) (*2)	078 SANSAI	(8.8)	7.7	(7.3)	7.3	7.3			22.3	22.3 5

R1 G3/4 (8) Tatami 4 15:05(2023-01-20)

Competitors	Kata	1	2	3	4	5	6	7	TOTAL	Extra Total Rank
1 BARANOVA ULIANA (OKI)	068 PAPUREN	7.2	7.4	(6.8)	(7.7)	6.8			21.4	21.4 5
2 PARIBELLI CAROLINA (MASTER RAPID SKF CBL)	030 HEIKU	6.9	(7.0)	6.6	(6.3)	6.6			20.1	20.1 8
3 DOMINIJANNI ELISA (ROMA 12)	068 PAPUREN	7.5	7.8	(8.0)	(7.4)	7.6			22.9	22.9 4
4 MATTUGINI ESTER (SPAZIO SPORT)	082 SEIENCHIN	(7.3)	7.2	(6.4)	6.5	7.0			20.7	20.7 7
5 BRAMBILLA CHIARA (MASTER RAPID SKF CBL)	068 PAPUREN	7.1	7.1	(7.4)	6.9	(6.7)			21.1	21.1 6
6 GRUPPIONI ASIA (ITALY)	064 OHAN DAI	7.9	8.0	(8.2)	8.1	(7.8)			24.0	24.0 2
7 MRAZOVA REBECA (SVK)	001 ANAN	8.4	8.2	(8.6)	(8.0)	8.2			24.8	24.8 1
8 TARANENKO SOFIIA (SFC KYIV)	021 GOJUSHIHO SHO	(8.2)	7.6	7.8	(7.5)	7.9			23.3	23.3 3

R1 G4/4 (7) Tatami 4 15:45(2023-01-20)

Competitors	Kata	1	2	3	4	5	6	7	TOTAL	Extra Total Rank
1 KRSNIK NIKA (KK ALFA)	020 GOJUSHIHO DAI	6.8	6.6	6.6	(6.5)	(6.9)			20.0	20.0 7
2 GOLOD ANASTASIIA (MOWGLY KC)	064 OHAN DAI	(7.2)	7.1	7.0	(6.8)	7.1			21.2	21.2 5
3 NORIS GIADA (MASTER RAPID SKF CBL)	064 OHAN DAI	7.4	(7.5)	7.4	7.2	(7.0)			22.0	22.0 4
4 MESAGLIO MARTINA (SKZP)	068 PAPUREN	7.5	(7.8)	7.6	7.6	(7.4)			22.7	22.7 3
5 MAESTRI ERIKA (MASTER RAPID SKF CBL)	030 HEIKU	(7.8)	7.6	6.8	(6.4)	6.6			21.0	21.0 6
6 KOBAL_PAHOR LEA (KK MAWASHI)	021 GOJUSHIHO SHO	(7.3)	(8.2)	8.2	7.7	7.5			23.4	23.4 2
7 LUJIC ANA (SB_CRO) (*1)	041 KANKU SHO	(8.0)	(8.4)	8.0	8.3	8.0			24.3	24.3 1

R2-G1

Competitors	Kata	1	2	3	4	5	6	7	TOTAL	Extra Total Rank
1 KHOLODNIK DARIA (ZAKHYST)	001 ANAN	(7.3)	7.2	7.2	7.2	(6.9)			21.6	21.6 8
2 STANGHERLIN SOFIA (SPORT TARGET)	008 CHATANYARA KUSHANKU	(7.6)	(7.4)	7.6	7.5	7.6			22.7	22.7 6
3 VERDONE MELISSA (MASTER RAPID SKF CBL)	030 HEIKU	(8.0)	(7.5)	8.0	7.6	7.5			23.1	23.1 5
4 ALEKSANDROVA POLINA (OKI)	068 PAPUREN	(8.4)	7.7	7.8	(7.5)	7.8			23.3	23.3 4
5 CELO SIMA (LZKNÓ)	067 PAIKU	(8.8)	8.2	8.4	7.8	(7.7)			24.4	24.4 1
6 IPPOLITI IRENE (SKZP)	064 OHAN DAI	(7.7)	7.3	7.5	7.5	(6.9)			22.3	22.3 7
7 FODOR AMIRA (KSI)	043 KISHIMOTO NO KUSHANKU	(8.6)	7.7	7.9	8.0	(7.5)			23.6	23.6 3
8 NIKOLIC MINA (BEOGRAD)	021 GOJUSHIHO SHO	(8.7)	8.0	8.1	(7.7)	8.2			24.3	24.3 2

R2-G2

Competitors	Kata	1	2	3	4	5	6	7	TOTAL	Extra Total Rank
1 TARANENKO SOFIIA (SFC KYIV)	041 KANKU SHO	(8.2)	7.4	7.9	7.8	(7.2)			23.1	23.1 8
2 KOBAL_PAHOR LEA (KK MAWASHI)	020 GOJUSHIHO DAI	8.6	(7.8)	(8.7)	8.4	8.2			25.2	25.2 3

31ST KARATE GRAND PRIX CROATIA - 2023-01-20

KATA FEMALE JUNIORS

3	MRAZOVA REBECA (SVK)	002 ANAN DAI	(9.0)	8.4	8.3	8.0	(7.8)						24.7		24.7	4
4	MESAGLIO MARTINA (SKZP)	064 OHAN DAI	(7.4)	8.1	8.0	(8.3)	7.4						23.5		23.5	7
5	GRUPPIONI ASIA (ITALY)	002 ANAN DAI	(8.8)	8.5	8.5	8.6	(8.4)						25.6		25.6	1
6	LUJIĆ ANA (SB_CRO)	015 GANKAKU	(7.8)	(8.3)	8.3	8.3	7.9						24.5		24.5	5
7	DOMINIJANNI ELISA (ROMA 12)	064 OHAN DAI	8.4	8.6	(8.8)	8.5	(8.1)						25.5		25.5	2
8	NORIS GIADA (MASTER RAPID SKF CBL)	068 PAPUREN	(7.6)	7.7	(8.4)	8.0	8.0						23.7		23.7	6

R3-G1

Competitors	Kata	1	2	3	4	5	6	7	TOTAL	Extra Total Rank
1 NIKOLIC MINA (BEOGRAD)	041 KANKU SHO	(7.7)	8.0	7.8	(8.2)	8.2			24.0	24.0 3
2 ALEKSANDROVA POLINA (OKI)	064 OHAN DAI	(7.3)	8.0	7.5	(8.4)	7.7			23.2	23.2 4
3 FODOR AMIRA (KSI)	068 PAPUREN	7.5	8.3	(7.4)	(8.5)	8.4			24.2	24.2 2
4 CELO SIMA (LZKNÖ)	064 OHAN DAI	8.3	(7.9)	8.0	(8.6)	8.0			24.3	24.3 1

R3-G2

Competitors	Kata	1	2	3	4	5	6	7	TOTAL	Extra Total Rank
1 GRUPPIONI ASIA (ITALY)	068 PAPUREN	8.4	8.3	8.7	(8.9)	(8.1)			25.4	25.4 1
2 KOBAL_PAHOR LEA (KK MAWASHI)	092 SUPARINPEI	(8.0)	8.0	8.0	8.0	(7.8)			24.0	24.0 4
3 MRAZOVA REBECA (SVK)	068 PAPUREN	(8.6)	8.5	8.3	(8.2)	8.4			25.2	25.2 2
4 DOMINIJANNI ELISA (ROMA 12)	002 ANAN DAI	8.5	7.8	8.9	(9.0)	(7.6)			25.2	25.2 3

R4 Bronze Medal Match 1

Competitors	Kata	1	2	3	4	5	6	7	TOTAL	Extra Total Rank
1 DOMINIJANNI ELISA (ROMA 12)	009 CHIBANA NO KUSHANKU	8.2	8.3	(8.0)	8.4	(8.5)			24.9	24.9 1
2 FODOR AMIRA (KSI)	052 MATSUMURA BASSAI	8.1	8.1	(7.8)	(8.3)	8.3			24.5	24.5 2

R4 Bronze Medal Match 2

Competitors	Kata	1	2	3	4	5	6	7	TOTAL	Extra Total Rank
1 NIKOLIC MINA (BEOGRAD)	099 UNSU	8.0	8.5	(8.7)	8.0	(7.9)			24.5	24.5 2
2 MRAZOVA REBECA (SVK)	008 CHATANYARA KUSHANKU	8.4	8.7	(8.9)	(8.3)	8.4			25.5	25.5 1

R4 Gold Medal Match

Competitors	Kata	1	2	3	4	5	6	7	TOTAL	Extra Total Rank
1 CELO SIMA (LZKNÖ)	092 SUPARINPEI	8.5	(8.7)	8.5	8.6	(8.4)			25.6	25.6 2
2 GRUPPIONI ASIA (ITALY)	009 CHIBANA NO KUSHANKU	(8.7)	8.5	8.7	(8.3)	8.6			25.8	25.8 1

Results

1	GRUPPIONI ASIA	ITALIAN NATIONAL TEAM		ITALY
2	CELO SIMA	LZ KARATE NIEDERÖSTERREICH		AUSTRIA
3	DOMINIJANNI ELISA	BERRETTONI FEDERICO		ITALY
3	MRAZOVA REBECA	SLOVAK NATIONAL TEAM		SLOVAKIA
5	FODOR AMIRA	KSI HUNGARY		HUNGARY
5	NIKOLIC MINA	SKIPPER		SERBIA
7	ALEKSANDROVA POLINA	OKINAWA		UKRAINE
7	KOBAL PAHOR LEA	KARATE KLUB MAWASHI POSTOJNA		SLOVENIA
9	VERDONE MELISSA	MASTER RAPID SKF CBL		ITALY
9	LUJIĆ ANA	SLAVONSKI BROD		CROATIA
11	STANGHERLIN SOFIA	SPORT TARGET		ITALY
11	NORIS GIADA	MASTER RAPID SKF CBL		ITALY
13	IPPOLITI IRENE	ASD SHOTOKAN KARATE POZZUOLO DEL FRIULI		ITALY
13	MESAGLIO MARTINA	ASD SHOTOKAN KARATE POZZUOLO DEL FRIULI		ITALY
15	KHOLODNIAK DARIA	ZAKHYST KARATE CLUB		UKRAINE
15	TARANENKO SOFIIA	SHOGUN SPORTS CORPORATION - KYIV		UKRAINE
17	CAPPELLATO MARIA	A.S.D. SEN SHIN KAI ROVIGO		ITALY
17	BULJAN TEA	KARATE KLUB SHIHAN - ZAGREB		CROATIA
17	BARANOVA ULIANA	OKINAWA		UKRAINE

31ST KARATE GRAND PRIX CROATIA - 2023-01-20
KATA FEMALE JUNIORS

17	GOLOD ANASTASIIA	MOWGLY KARATE CLUB		UKRAINE
21	KONTREC ALJA	KARATE KLUB MAWASHI POSTOJNA		SLOVENIA
21	ZORI ANNA	KARATE DO TRIESTE		ITALY
21	BRAMBILLA CHIARA	MASTER RAPID SKF CBL		ITALY
21	MAESTRI ERIKA	MASTER RAPID SKF CBL		ITALY
25	VIELMI ELISA	MASTER RAPID SKF CBL		ITALY
25	NOAM YUVAL	JKS ISRAEL		ISRAEL
25	MATTUGINI ESTER	SPAZIO SPORT FORTE DEI MARMI		ITALY
25	KRSNIK NIKA	KARATE KLUB ALFA		CROATIA
29	PARIMBELLI CAROLINA	MASTER RAPID SKF CBL		ITALY

Kumite Female U21 + 68kg

31ST KARATE GRAND PRIX CROATIA, CITY SPORTS HALL SAMOBOR, ANDRIJE HEBRANGA 26A, SAMOBOR, CROATIA, CRO

2023-01-21

Tatami
4 09:00

Pool
2/2

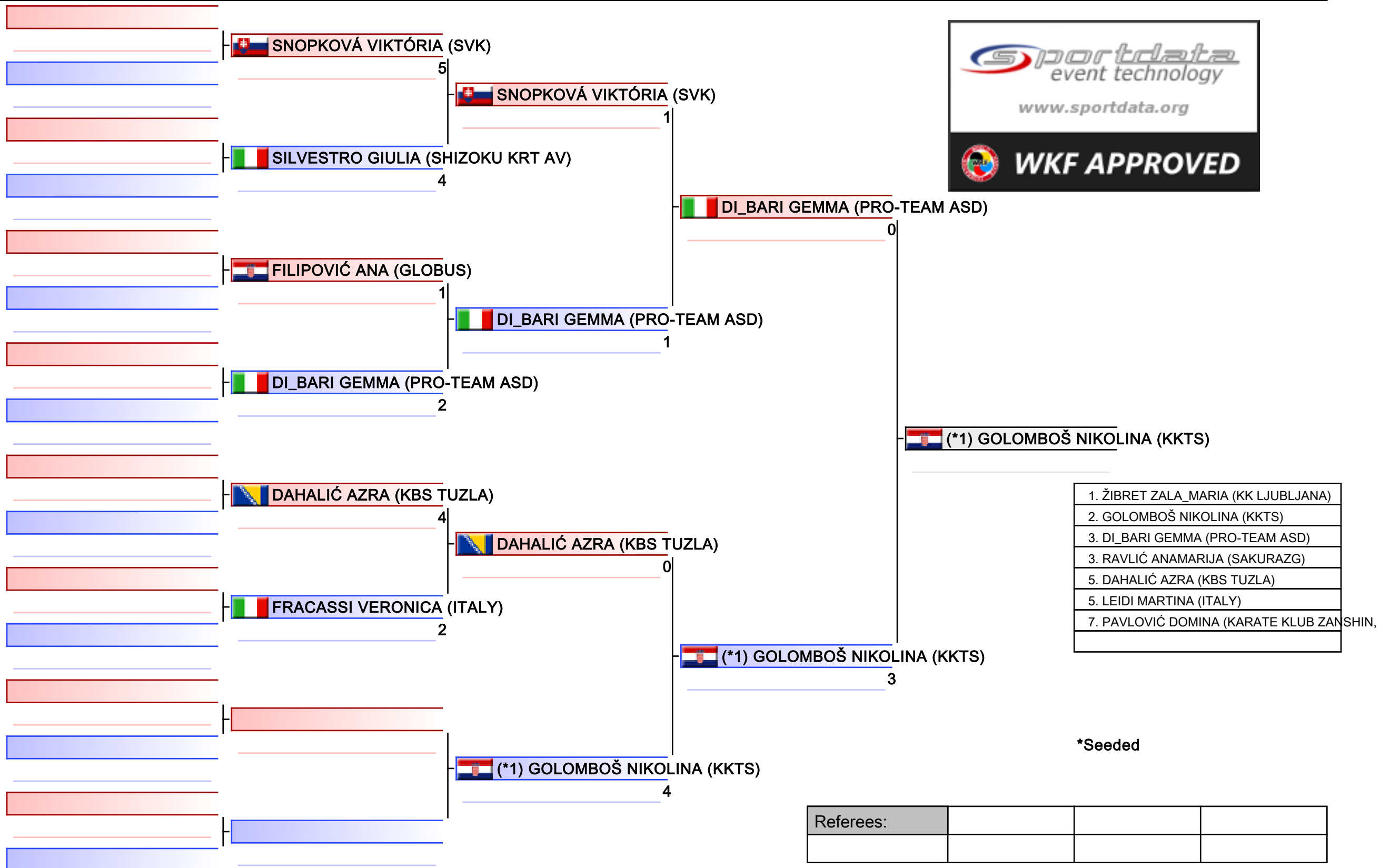

31ST KARATE GRAND PRIX CROATIA - 2023-01-20

Kata female seniors

R1 G1/2 (10) Tatami 5 17:25(2023-01-20)

Competitors	Kata	1	2	3	4	5	6	7	TOTAL	Extra Total Rank
1 VANUSANIKOVA JANA (SVK)	002 ANAN DAI	(8.2)	(7.6)	7.7	7.8	7.7			23.2	23.2 5
2 MARCHETTI GIULIA (SPORT TARGET)	068 PAPUREN	8.0	8.0	7.9	(7.4)	(8.3)			23.9	23.9 4
3 TARANENKO SOFIIA (SFC KYIV)	015 GANKAKU	7.4	(7.8)	7.3	7.6	(6.9)			22.3	22.3 6
4 LORENZA MEL (POLISPORTIVA TERRAGLIO)	021 GOJUSHIHO SHO	(5.8)	5.9	(6.8)	6.0	5.8			17.7	17.7 10
5 MLADEŽIĆ BOJANA (KA BUSHIDO)	021 GOJUSHIHO SHO	8.4	7.8	(7.5)	8.0	(8.5)			24.2	24.2 3
6 NADIŽAR LANA_TISA (KK KRANJ SLO)	068 PAPUREN	8.3	(8.4)	8.0	(7.7)	8.0			24.3	24.3 2
7 CELO FUNDA (LZKNŌ)	068 PAPUREN	(8.5)	8.5	8.5	(8.1)	8.4			25.4	25.4 1
8 DI LELIO ELENA (ASD ESERCITO - 187 FOLGORE)	068 PAPUREN	(7.6)	7.5	(7.0)	7.3	7.4			22.2	22.2 7
9 HOLLWEGER ANJA (KARA)	020 GOJUSHIHO DAI	7.0	(7.2)	6.9	6.7	(6.6)			20.6	20.6 8
10 SHOR SIMONA (JKSISR)	041 KANKU SHO	(5.8)	(6.3)	6.1	6.2	6.0			18.3	18.3 9

R1 G2/2 (10) Tatami 6 17:20(2023-01-20)

Competitors	Kata	1	2	3	4	5	6	7	TOTAL	Extra Total Rank
1 TAKACOVA TEREZA (SVK)	002 ANAN DAI	(7.5)	(8.0)	7.5	7.8	7.5			22.8	22.8 7
2 MALČEC SARA (VIROVITICA)	002 ANAN DAI	(6.9)	7.8	7.4	(7.9)	7.9			23.1	23.1 5
3 CRESCENZI ELISA (FF.OO. POLIZIA DI STATO)	068 PAPUREN	7.7	7.6	7.6	(7.4)	(8.2)			22.9	22.9 6
4 MEŠIĆ MINA (RODA BEOGRAD)	020 GOJUSHIHO DAI	(7.6)	7.9	7.7	(8.2)	7.6			23.2	23.2 4
5 NORIS GIADA (MASTER RAPID SKF CBL)	002 ANAN DAI	8.0	8.2	(7.0)	8.0	(8.6)			24.2	24.2 1
6 LORENZONI ELENA (SPAZIO SPORT)	092 SUPARINPEI	7.0	(7.4)	6.7	7.3	(6.6)			21.0	21.0 10
7 JELEN NIKA (KKSA)	041 KANKU SHO	7.5	(8.3)	(7.0)	7.4	7.8			22.7	22.7 9
8 CAPPELLATO MARIA (SSKR)	001 ANAN	7.6	(7.7)	(7.2)	7.6	7.6			22.8	22.8 8
9 BRUNANSKA KRISTINA (SVK)	068 PAPUREN	(7.8)	8.1	7.8	(8.3)	8.2			24.1	24.1 2
10 PERUZZI GIADA (SPORT TARGET)	064 OHAN DAI	7.9	(8.4)	7.9	7.7	(7.6)			23.5	23.5 3

R2-G1

Competitors	Kata	1	2	3	4	5	6	7	TOTAL	Extra Total Rank
1 NADIŽAR LANA_TISA (KK KRANJ SLO)	009 CHIBANA NO KUSHANKU	(7.8)	7.8	7.9	(8.1)	8.1			23.8	23.8 4
2 CELO FUNDA (LZKNŌ)	002 ANAN DAI	(7.4)	8.4	8.5	(8.8)	8.4			25.3	25.3 2
3 MARCHETTI GIULIA (SPORT TARGET)	008 CHATANYARA KUSHANKU	(8.1)	8.1	8.2	(9.1)	8.2			24.5	24.5 3
4 MLADEŽIĆ BOJANA (KA BUSHIDO)	092 SUPARINPEI	8.5	8.6	(8.3)	(9.4)	8.3			25.4	25.4 1

R2-G2

Competitors	Kata	1	2	3	4	5	6	7	TOTAL	Extra Total Rank
1 PERUZZI GIADA (SPORT TARGET)	002 ANAN DAI	7.9	(8.2)	7.9	(7.6)	7.8			23.6	23.6 3
2 BRUNANSKA KRISTINA (SVK)	002 ANAN DAI	7.8	7.8	(8.1)	7.8	(7.4)			23.4	23.4 4
3 MEŠIĆ MINA (RODA BEOGRAD)	021 GOJUSHIHO SHO	8.0	(8.3)	8.3	8.0	(7.6)			24.3	24.3 2
4 NORIS GIADA (MASTER RAPID SKF CBL)	068 PAPUREN	8.1	8.0	8.2	(8.5)	(7.9)			24.3	24.3 1

R3 Bronze Medal Match 1

Competitors	Kata	1	2	3	4	5	6	7	TOTAL	Extra Total Rank
1 PERUZZI GIADA (SPORT TARGET)	030 HEIKU	7.9	7.7	(7.6)	(8.2)	8.0			23.6	23.6 2
2 CELO FUNDA (LZKNŌ)	008 CHATANYARA KUSHANKU	(8.1)	8.5	8.4	(8.8)	8.8			25.7	25.7 1



R3 Bronze Medal Match 2

Competitors	Kata	1	2	3	4	5	6	7	TOTAL	Extra Total Rank
1 MARCHETTI GIULIA (SPORT TARGET)	009 CHIBANA NO KUSHANKU	(8.5)	(8.0)	8.5	8.1	8.3			24.9	24.9 1
2 MEŠIĆ MINA (RODA BEOGRAD)	015 GANKAKU	(8.8)	8.4	8.4	(7.9)	8.0			24.8	24.8 2

R3 Gold Medal Match

Competitors	Kata	1	2	3	4	5	6	7	TOTAL	Extra Total Rank
1 NORIS GIADA (MASTER RAPID SKF CBL)	030 HEIKU	(8.0)	8.0	8.1	8.3	(8.4)			24.4	24.4 2
2 MLADEŽIĆ BOJANA (KA BUSHIDO)	099 UNSU	8.2	(8.1)	(8.4)	8.1	8.2			24.5	24.5 1

Results

1	MLADEŽIĆ BOJANA	KARATE ACADEMY BUSHIDO		SERBIA
2	NORIS GIADA	MASTER RAPID SKF CBL		ITALY

31ST KARATE GRAND PRIX CROATIA - 2023-01-20

Kata female seniors

3	CELO FUNDA	LZ KARATE NIEDERÖSTERREICH		AUSTRIA
3	MARCHETTI GIULIA	SPORT TARGET		ITALY
5	PERUZZI GIADA	SPORT TARGET		ITALY
5	MESIĆ MINA	KARATE KLUB ČUKARIČKI RODA BEOGRAD		SERBIA
7	NADIŽAR LANA TISA	KARATE KLUB KRANJ		SLOVENIA
7	BRUNANSKA KRISTINA	SLOVAK NATIONAL TEAM		SLOVAKIA
9	VANUSANIKOVA JANA	SLOVAK NATIONAL TEAM		SLOVAKIA
9	MALČEC SARA	KK VIROVITICA		CROATIA
11	TARANENKO SOFIIA	SHOGUN SPORTS CORPORATION - KYIV		UKRAINE
11	CRESCENZI ELISA	G.S.FF.OO. POLIZIA DI STATO		ITALY
13	DI LELIO ELENA	ASD ESERCITO - 187° FOLGORE		ITALY
13	TAKACOVA TEREZA	SLOVAK NATIONAL TEAM		SLOVAKIA
15	HOLLWEGER ANJA	ASKÖ KARATE KARA		AUSTRIA
15	CAPPELLATO MARIA	A.S.D. SEN SHIN KAI ROVIGO		ITALY
17	SHOR SIMONA	JKS ISRAEL		ISRAEL
17	JELEN NIKA	KK SAMOBOR		CROATIA
19	LORENZA MEL	SSD POLISPORTIVA TERRAGLIO		ITALY
19	LORENZONI ELENA	SPAZIO SPORT FORTE DEI MARMI		ITALY

Kumite Female U21 - 61kg

31ST KARATE GRAND PRIX CROATIA, CITY SPORTS HALL SAMOBOR, ANDRIJE HEBRANGA 26A, SAMOBOR, CROATIA, CRO

2023-01-21

Tatami
6 09:00

Pool
2/2

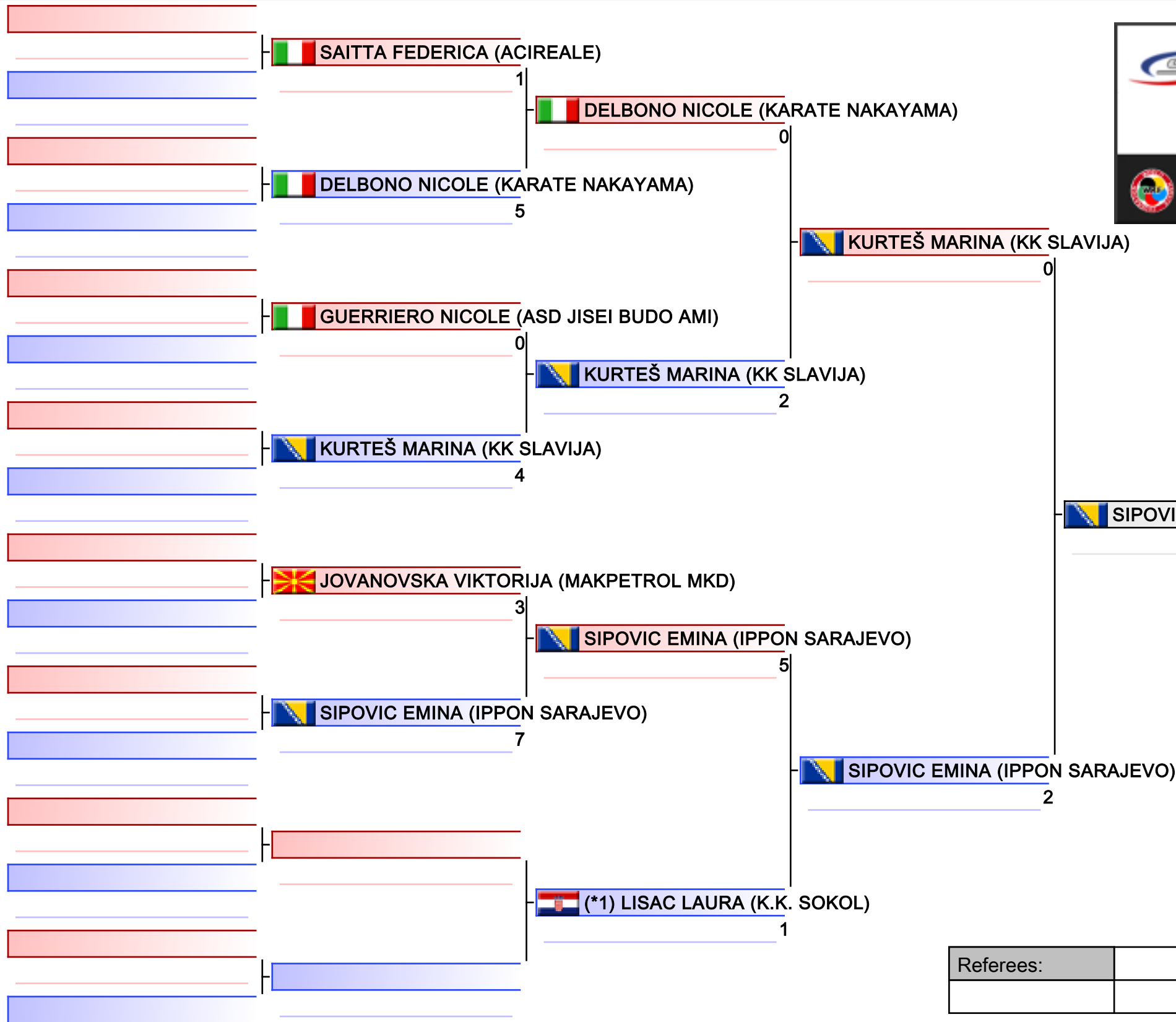

1. DEBELJAK HANA (KK LJUBLJANA)
2. SIPOVIC EMINA (IPPON SARAJEVO)
3. JOVANOVSKA VIKTORIJA (MAKPETROL MKD)
3. АЛИУ РУДИНА (ЦВЕТАН ДИМОВ - СКОПЈЕ)
5. KURTEŠ MARINA (KK SLAVIJA)
5. DESTI FEDERICA (K 01)
7. LISAC LAURA (K.K. SOKOL)
7. CECERE MARIKA (A.T. KARATE CLUB ROMA)

*Seeded

Referees:			

31ST KARATE GRAND PRIX CROATIA - 2023-01-20

KATA male cadets

R1 G1/4 (8) Tatami 1 14:25(2023-01-20)

Competitors	Kata	1	2	3	4	5	6	7	TOTAL	Extra Total Rank
1 KHABLO DANYLO (KATANA)	001 ANAN	7.3	(7.2)	7.5	7.3	(7.7)			22.1	22.1 3
2 MULLER JURAJ (SVK)	002 ANAN DAI	7.7	(8.3)	(7.0)	8.2	8.1			24.0	24.0 1
3 CALABRESE FILIPPO (MASTER RAPID SKF CBL)	021 GOJUSHIHO SHO	(7.0)	8.0	7.2	7.8	(8.3)			23.0	23.0 2
4 KUKIĆ IVAN (KK ALFA)	020 GOJUSHIHO DAI	(6.7)	(7.3)	7.2	7.1	7.3			21.6	21.6 4
5 PANFILE DAVID (SPAZIO SPORT)	012 ENPI	6.5	6.3	(6.2)	6.3	(6.8)			19.1	19.1 7
6 APRILOV DENIS (SHURIKEN)	068 PAPUREN	6.8	7.0	(6.6)	(7.5)	7.4			21.2	21.2 6
7 GIUSTINIANO ALESSIO (ROMA 12)	064 OHAN DAI	6.3	6.1	(6.0)	(6.8)	6.6			19.0	19.0 8
8 MUSIC ADIN (KK FENIKS)	021 GOJUSHIHO SHO	(6.9)	7.1	(7.3)	7.0	7.2			21.3	21.3 5

R1 G2/4 (7) Tatami 1 15:05(2023-01-20)

Competitors	Kata	1	2	3	4	5	6	7	TOTAL	Extra Total Rank
1 JAKOVLJEVIĆ VASILIJ (SU SPARTANCI 026 - S.PALANKA)	021 GOJUSHIHO SHO	(7.4)	7.5	7.5	7.6	(8.2)			22.6	22.6 5
2 NEDOROŠČIK DANIEL (SHIHAN POPRAD)	002 ANAN DAI	8.2	8.0	(7.8)	8.0	(8.5)			24.2	24.2 1
3 JOVIČIĆ JOVIĆ DORIAN (RODA BEOGRAD)	021 GOJUSHIHO SHO	7.2	(7.1)	(8.0)	7.2	8.0			22.4	22.4 7
4 CİCVARIĆ LUKA (KARATE KLUB BREŽICE)	002 ANAN DAI	7.8	(7.3)	(8.4)	7.8	7.7			23.3	23.3 4
5 HLUSHCHENKO ARTUR (OKI)	002 ANAN DAI	(7.5)	7.7	7.6	8.2	(8.7)			23.5	23.5 3
6 PAUNOVIĆ ĐORĐE (KKS BORAC - ČAČAK)	021 GOJUSHIHO SHO	7.1	(6.6)	7.9	7.5	(8.3)			22.5	22.5 6
7 ŽEINSKI IVAN (KK ALFA) (*2)	021 GOJUSHIHO SHO	(7.3)	7.6	8.1	8.1	(8.6)			23.8	23.8 2

R1 G3/4 (7) Tatami 2 14:30(2023-01-20)

Competitors	Kata	1	2	3	4	5	6	7	TOTAL	Extra Total Rank
1 GYULAFFY PÉTER (SVK)	002 ANAN DAI	(6.7)	7.4	7.1	(7.5)	7.4			21.9	21.9 5
2 KRŠNIK VITO (KK ALFA)	021 GOJUSHIHO SHO	6.9	6.8	(6.5)	6.5	(7.1)			20.2	20.2 7
3 SEMENENKO NIKITA (SENBIN)	021 GOJUSHIHO SHO	7.3	(7.0)	7.5	(7.9)	7.2			22.0	22.0 4
4 BICOS NIKITA (SSKR)	001 ANAN	(6.8)	7.6	7.7	(8.2)	7.1			22.4	22.4 3
5 DI RUBBA LUIGI (ITALY)	021 GOJUSHIHO SHO	(7.8)	7.9	8.0	(8.7)	8.1			24.0	24.0 1
6 GULYAS GERGELY (UTE)	008 CHATANYARA KUSHANKU	(7.0)	7.3	7.6	7.6	(8.0)			22.5	22.5 2
7 RAMIĆ FARIS (KBES 5.11-BK)	021 GOJUSHIHO SHO	(6.3)	(7.5)	6.8	7.3	6.9			21.0	21.0 6

R1 G4/4 (7) Tatami 2 15:05(2023-01-20)

Competitors	Kata	1	2	3	4	5	6	7	TOTAL	Extra Total Rank
1 TOMIČIĆ IVANO (ENPI RAB)	021 GOJUSHIHO SHO	(6.0)	6.3	6.5	(7.2)	6.6			19.4	19.4 7
2 CAPONERA EMANUELE (A.S.D. KARATE ROMA)	068 PAPUREN	(7.7)	7.6	7.7	7.3	(6.9)			22.6	22.6 3
3 GENDES DAVID (SVK)	002 ANAN DAI	7.5	(8.0)	8.0	7.1	(7.0)			22.6	22.6 2
4 MORETTI OSCAR (MASTER RAPID SKF CBL)	020 GOJUSHIHO DAI	(8.1)	7.5	7.8	7.2	(7.1)			22.5	22.5 4
5 KISIĆ FRAN (KK IPON ZAGREB)	020 GOJUSHIHO DAI	(7.4)	7.3	(6.8)	7.2	6.9			21.4	21.4 6
6 ROZHKOV DMYTRO (KATANA)	047 KURURUNFA	(7.2)	7.7	(8.2)	7.3	7.3			22.3	22.3 5
7 FILEŠ MARK (KK ALFA) (*1)	021 GOJUSHIHO SHO	7.6	7.9	(8.1)	7.5	(7.2)			23.0	23.0 1

R2-G1

Competitors	Kata	1	2	3	4	5	6	7	TOTAL	Extra Total Rank
1 MULLER JURAJ (SVK)	001 ANAN	(7.7)	(8.4)	8.0	8.2	8.3			24.5	24.5 1
2 HLUSHCHENKO ARTUR (OKI)	066 PACHU	(8.3)	8.0	7.7	(7.5)	7.6			23.3	23.3 6
3 CİCVARIĆ LUKA (KARATE KLUB BREŽICE)	064 OHAN DAI	(7.9)	7.8	7.3	(7.2)	7.4			22.5	22.5 8
4 CALABRESE FILIPPO (MASTER RAPID SKF CBL)	078 SANSAN	8.1	(7.7)	(8.2)	7.7	8.2			24.0	24.0 2
5 KUKIĆ IVAN (KK ALFA)	015 GANKAKU	(8.2)	7.6	7.5	(7.4)	7.6			22.7	22.7 7
6 NEDOROŠČIK DANIEL (SHIHAN POPRAD)	008 CHATANYARA KUSHANKU	(8.0)	7.9	(7.8)	7.9	8.0			23.8	23.8 4
7 ŽEINSKI IVAN (KK ALFA)	099 UNSU	(8.5)	8.1	7.9	(7.6)	7.9			23.9	23.9 3
8 KHABLO DANYLO (KATANA)	068 PAPUREN	7.8	(8.2)	7.6	(7.0)	8.1			23.5	23.5 5

R2-G2

Competitors	Kata	1	2	3	4	5	6	7	TOTAL	Extra Total Rank
-------------	------	---	---	---	---	---	---	---	-------	------------------

31ST KARATE GRAND PRIX CROATIA - 2023-01-20

KATA male cadets

1	MORETTI OSCAR (MASTER RAPID SKF CBL)	099 UNSU	7.6	7.8	(7.2)	(8.2)	7.4						22.8		22.8	5
2	DI_RUBBA LUIGI (ITALY)	020 GOJUSHIHO DAI	(6.5)	7.2	7.1	(7.8)	7.0						21.3		21.3	8
3	BICOS NIKITA (SSKR)	002 ANAN DAI	8.0	(8.2)	(6.9)	7.6	7.9						23.5		23.5	4
4	GENDES DAVID (SVK)	068 PAPUREN	(8.2)	8.0	(7.3)	8.0	7.6						23.6		23.6	2
5	CAPONERA EMANUELE (A.S.D. KARATE ROMA)	064 OHAN DAI	8.3	(8.4)	(7.4)	8.1	8.2						24.6		24.6	1
6	FILEŠ MARK (KK ALFA)	078 SANSAI	8.1	(8.6)	(7.3)	7.7	7.7						23.5		23.5	3
7	SEMENENKO NIKITA (SENBIN)	015 GANKAKU	(7.5)	7.5	7.5	7.5	(7.3)						22.5		22.5	7
8	GULYAS GERGELY (UTE)	092 SUPARINPEI	(7.9)	7.7	7.4	(7.3)	7.5						22.6		22.6	6

R3-G1

Competitors	Kata	1	2	3	4	5	6	7	TOTAL	Extra Total Rank	
1	ŽEINSKI IVAN (KK ALFA)	015 GANKAKU	(7.8)	7.9	(8.1)	7.8	7.8		23.5	23.5	4
2	NEDOROŠČIK DANIEL (SHIHAN POPRAD)	064 OHAN DAI	8.1	(7.7)	(8.6)	8.0	8.1		24.2	24.2	3
3	MULLER JURAJ (SVK)	008 CHATANYARA KUSHANKU	8.8	(8.1)	(9.0)	8.4	8.3		25.5	25.5	1
4	CALABRESE FILIPPO (MASTER RAPID SKF CBL)	015 GANKAKU	8.4	8.3	(8.8)	(8.2)	8.2		24.9	24.9	2

R3-G2

Competitors	Kata	1	2	3	4	5	6	7	TOTAL	Extra Total Rank	
1	FILEŠ MARK (KK ALFA)	099 UNSU	7.8	7.9	(7.7)	(8.0)	7.8		23.5	23.5	3
2	GENDES DAVID (SVK)	009 CHIBANA NO KUSHANKU	7.6	7.6	(7.5)	(8.2)	7.6		22.8	22.8	4
3	CAPONERA EMANUELE (A.S.D. KARATE ROMA)	002 ANAN DAI	8.2	8.2	8.2	(8.3)	(8.0)		24.6	24.6	1
4	BICOS NIKITA (SSKR)	064 OHAN DAI	8.0	(7.1)	8.4	(8.6)	7.9		24.3	24.3	2

R4 Bronze Medal Match 1

Competitors	Kata	1	2	3	4	5	6	7	TOTAL	Extra Total Rank	
1	CALABRESE FILIPPO (MASTER RAPID SKF CBL)	099 UNSU	7.8	(7.6)	7.8	7.8	(8.3)		23.4	23.4	2
2	FILEŠ MARK (KK ALFA)	015 GANKAKU	(8.3)	(8.2)	8.2	8.2	8.2		24.6	24.6	1

R4 Bronze Medal Match 2

Competitors	Kata	1	2	3	4	5	6	7	TOTAL	Extra Total Rank
1	NEDOROŠČIK DANIEL (SHIHAN POPRAD)	068 PAPUREN								
2	BICOS NIKITA (SSKR)	008 CHATANYARA KUSHANKU								

R4 Gold Medal Match

Competitors	Kata	1	2	3	4	5	6	7	TOTAL	Extra Total Rank
1	MULLER JURAJ (SVK)	068 PAPUREN								
2	CAPONERA EMANUELE (A.S.D. KARATE ROMA)	009 CHIBANA NO KUSHANKU								

Results

1	MULLER JURAJ	SLOVAK NATIONAL TEAM		SLOVAKIA
2	CAPONERA EMANUELE	A.S.D. KARATE ROMA		ITALY
3	FILEŠ MARK	KARATE KLUB ALFA		CROATIA
3	NEDOROŠČIK DANIEL	KARATE KLUB SHIHAN POPRAD		SLOVAKIA
5	CALABRESE FILIPPO	MASTER RAPID SKF CBL		ITALY
5	BICOS NIKITA	A.S.D. SEN SHIN KAI ROVIGO		ITALY
7	ŽEINSKI IVAN	KARATE KLUB ALFA		CROATIA
7	GENDES DAVID	SLOVAK NATIONAL TEAM		SLOVAKIA
9	KHABLO DANYLO	KATANA		UKRAINE
9	MORETTI OSCAR	MASTER RAPID SKF CBL		ITALY
11	HLUSHCHENKO ARTUR	OKINAWA		UKRAINE
11	GULYAS GERGELY	UTE HUNGARY		HUNGARY
13	KUKIČ IVAN	KARATE KLUB ALFA		CROATIA
13	SEMENENKO NIKITA	SENBIN KARATE CLUB		UKRAINE
15	CICVARIČ LUKA	KARATE KLUB BREŽICE		SLOVENIA

31ST KARATE GRAND PRIX CROATIA - 2023-01-20

KATA male cadets

15	DI RUBBA LUIGI	ITALIAN NATIONAL TEAM		ITALY
17	MUSIC ADIN	KARATE KLUB FENIKS		BOSNIA AND HERZEGOVINA
17	JAKOVLJEVIĆ VASILJE	SPORTSKO UDRUŽENJE SPARTANCI 026 - S. PALANKA		SERBIA
17	GYULAFFY PETER	SLOVAK NATIONAL TEAM		SLOVAKIA
17	ROZHKOVA DMYTRO	KATANA		UKRAINE
21	APRILOV DENIS	KARATE CLUB SHURIKEN		BULGARIA
21	PAUNOVIĆ ĐORĐE	KLUB KONTAKTNIH SPORTOVA BORAC - ČAČAK		SERBIA
21	RAMIĆ FARIS	KBES 5.11-BK BOSANSKA KRUPA		BOSNIA AND HERZEGOVINA
21	KISIĆ FRAN	KARATE KLUB IPON ZAGREB		CROATIA
25	PANFILE DAVID	SPAZIO SPORT FORTE DEI MARMI		ITALY
25	JOVIĆIĆ JOVIĆ DORIAN	KARATE KLUB ČUKARIČKI RODA BEOGRAD		SERBIA
25	KRSNIK VITO	KARATE KLUB ALFA		CROATIA
25	TOMIČIĆ IVANO	ENPI RAB		CROATIA
29	GIUSTINIANO ALESSIO	BERRETTONI FEDERICO		ITALY

Kumite Female U21 - 68kg

31ST KARATE GRAND PRIX CROATIA, CITY SPORTS HALL SAMOBOR, ANDRIJE HEBRANGA 26A, SAMOBOR, CROATIA, CRO

2023-01-21

Tatami
4 10:00

Pool
2/2

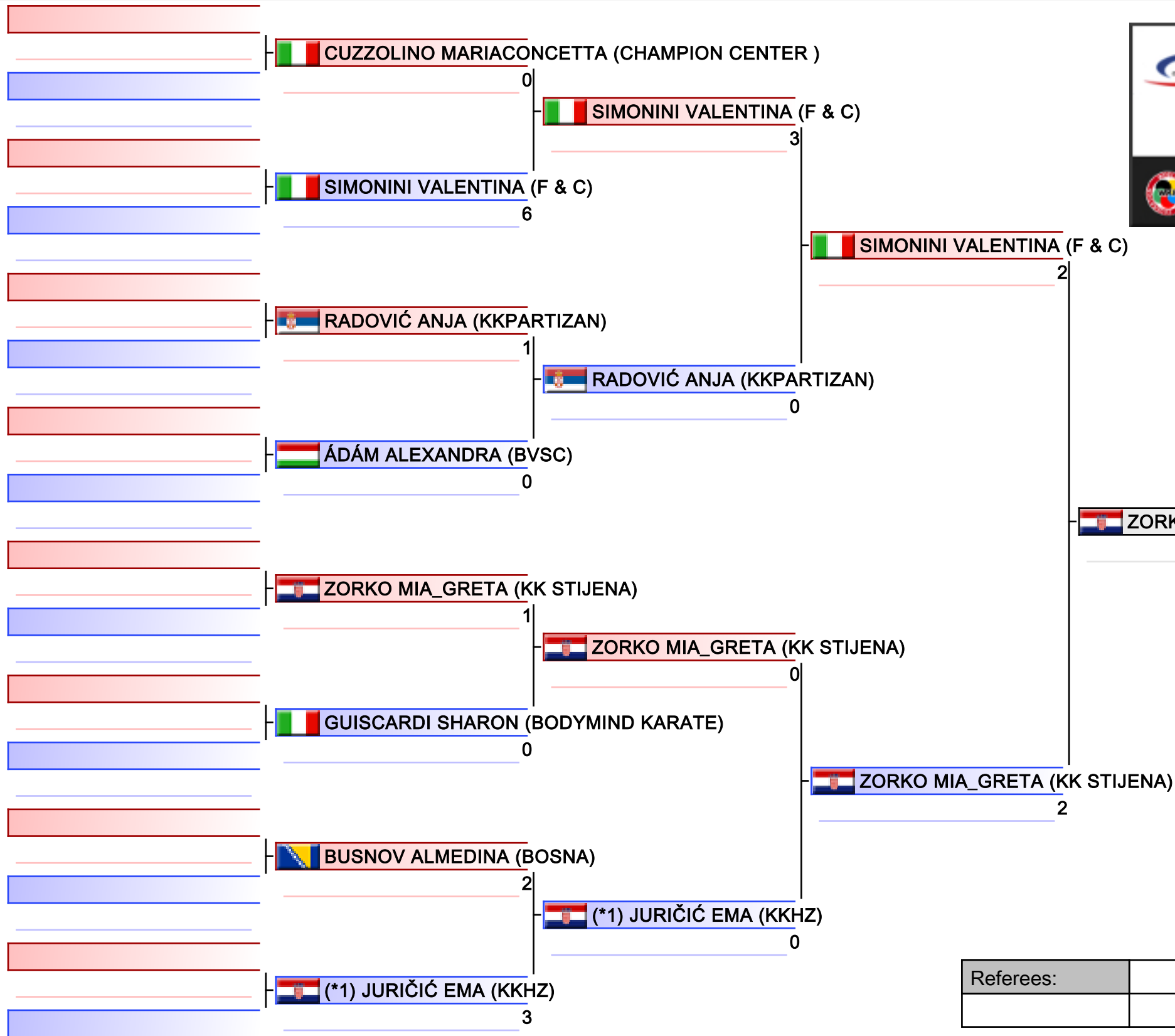

1. ZORKO MIA_GRETA (KK STIJENA)
2. MOLNAR ELIZABETA (KK LJUBLJANA)
3. KRIVDOVÁ SÁRA (SVK)
3. JURIČIĆ EMA (KKHZ)
5. ROSS ADRIANA (K.K. SOKOL)
5. SIMONINI VALENTINA (F & C)
7. GUŠO DŽEJLAN (KK ZANSHIN)
7. GUISCARDI SHARON (BODYMIND KARATE)

*Seeded

Referees:			

31ST KARATE GRAND PRIX CROATIA - 2023-01-20

kata male U21

R1 G1/4 (7) Tatami 3 13:00(2023-01-20)

Competitors	Kata	1	2	3	4	5	6	7	TOTAL	Extra Total Rank
1 FAFANDEL DORIAN (ENPI RAB)	021 GOJUSHIHO SHO	(7.0)	7.0	(7.1)	7.0	7.1			21.1	21.1 7
2 BARLETTA LEONARDO (MASTER RAPID SKF CBL)	064 OHAN DAI	(7.6)	7.6	7.3	7.6	(7.1)			22.5	22.5 5
3 BEKE BALINT (KSI)	001 ANAN	(8.2)	7.9	7.9	8.2	(7.7)			24.0	24.0 4
4 POLSINELLI GUIDO (FF.OO. POLIZIA DI STATO)	020 GOJUSHIHO DAI	8.5	7.7	(7.6)	(8.6)	8.0			24.2	24.2 3
5 BINOTTO PIETRO (SPORT TARGET)	020 GOJUSHIHO DAI	8.0	(7.7)	8.3	(8.4)	8.3			24.6	24.6 1
6 MASSAGLIA MARCO (SPAZIO SPORT)	012 ENPI	7.3	7.2	(7.1)	7.2	(7.4)			21.7	21.7 6
7 MATUSKI GEORGI (SHURIKEN)	002 ANAN DAI	(7.5)	8.1	8.2	8.3	(8.6)			24.6	24.6 2

R1 G2/4 (6) Tatami 3 13:30(2023-01-20)

Competitors	Kata	1	2	3	4	5	6	7	TOTAL	Extra Total Rank
1 BOROJEVIĆ MARIO (KK TEMPO)	041 KANKU SHO	6.8	6.8	(6.7)	6.8	(7.2)			20.4	20.4 6
2 VALDESI FRANCESCO (POLO VERDE-PALERMO)	012 ENPI	8.0	7.8	(8.2)	(7.4)	7.8			23.6	23.6 4
3 VELADŽIĆ SENAID (KBES 5.11-BK)	020 GOJUSHIHO DAI	7.6	8.3	(8.4)	7.8	(7.5)			23.7	23.7 3
4 CALABRESE LUCA (SSKR)	064 OHAN DAI	7.8	7.7	7.4	(8.2)	(7.3)			22.9	22.9 5
5 HRCKA ROMAN (SVK)	002 ANAN DAI	8.3	(8.0)	8.4	(8.6)	8.6			25.3	25.3 1
6 RELIĆ MATIJA (VIROVITICA)	064 OHAN DAI	(7.9)	8.1	8.3	(8.4)	8.4			24.8	24.8 2

R1 G3/4 (6) Tatami 4 13:00(2023-01-20)

Competitors	Kata	1	2	3	4	5	6	7	TOTAL	Extra Total Rank
1 EDERAR KARIM (MASTER RAPID SKF CBL)	064 OHAN DAI	7.6	6.9	(6.8)	(8.1)	7.6			22.1	22.1 5
2 STERNIŠA NEJC (KK MAWASHI)	020 GOJUSHIHO DAI	(8.2)	(7.5)	7.6	7.9	8.0			23.5	23.5 1
3 PICCIONI EDOARDO (KARATETERNI)	002 ANAN DAI	(7.9)	7.3	(7.0)	7.8	7.5			22.6	22.6 3
4 MEŠANOVIĆ BENJAMIN (KK VELENJE)	041 KANKU SHO	7.0	6.7	(6.6)	(7.4)	7.4			21.1	21.1 6
5 BARDOS ÁDÁM (SPORTINGBUDO)	064 OHAN DAI	(8.5)	7.5	(7.4)	7.9	7.9			23.3	23.3 2
6 TKALČEC TOMISLAV (KK OKINAWA)	002 ANAN DAI	7.3	7.3	(6.4)	7.6	(7.7)			22.2	22.2 4

R1 G4/4 (6) Tatami 4 13:30(2023-01-20)

Competitors	Kata	1	2	3	4	5	6	7	TOTAL	Extra Total Rank
1 BOMBARDI LEONARDO (MASTER RAPID SKF CBL)	021 GOJUSHIHO SHO	7.1	(6.8)	7.2	7.4	(7.6)			21.7	21.7 2
2 MADONIA FILIPPO_MARIA (REAL SOCIETÀ)	021 GOJUSHIHO SHO	6.9	(6.6)	7.0	(7.6)	7.2			21.1	21.1 5
3 SOKOLOV HLIB (ZAKHYST)	041 KANKU SHO	7.4	(6.9)	6.9	(8.2)	7.3			21.6	21.6 3
4 SLUGA JURE (KK SEKI)	099 UNSU	7.9	(7.3)	7.3	(8.4)	7.5			22.7	22.7 1
5 PEDRUZZI THOMAS (MASTER RAPID SKF CBL)	020 GOJUSHIHO DAI	7.0	6.9	(6.6)	(7.5)	7.5			21.4	21.4 4
6 MATUŠAN ANTONIO (ENPI RAB)	099 UNSU	(7.2)	6.5	(6.4)	7.1	7.2			20.8	20.8 6

R2-G1

Competitors	Kata	1	2	3	4	5	6	7	TOTAL	Extra Total Rank
1 BEKE BALINT (KSI)	002 ANAN DAI	7.6	(7.7)	7.4	(7.2)	7.4			22.4	22.4 8
2 MATUSKI GEORGI (SHURIKEN)	092 SUPARINPEI	(7.2)	7.6	7.9	(8.2)	8.0			23.5	23.5 5
3 BINOTTO PIETRO (SPORT TARGET)	041 KANKU SHO	8.4	8.3	(8.8)	8.6	(8.2)			25.3	25.3 2
4 VALDESI FRANCESCO (POLO VERDE-PALERMO)	078 SANSAI	(6.8)	7.6	(8.6)	7.0	8.0			22.6	22.6 7
5 VELADŽIĆ SENAID (KBES 5.11-BK)	099 UNSU	7.9	(7.5)	(8.7)	7.6	7.8			23.3	23.3 6
6 HRCKA ROMAN (SVK)	068 PAPUREN	(8.2)	8.2	(8.8)	8.8	8.6			25.6	25.6 1
7 POLSINELLI GUIDO (FF.OO. POLIZIA DI STATO)	099 UNSU	(8.0)	8.0	8.0	8.0	(8.1)			24.0	24.0 4
8 RELIĆ MATIJA (VIROVITICA)	002 ANAN DAI	(7.7)	8.1	8.1	(8.3)	8.3			24.5	24.5 3

R2-G2

Competitors	Kata	1	2	3	4	5	6	7	TOTAL	Extra Total Rank
1 SLUGA JURE (KK SEKI)	078 SANSAI	8.0	8.0	(8.4)	8.2	(7.3)			24.2	24.2 3
2 SOKOLOV HLIB (ZAKHYST)	099 UNSU	6.9	7.6	(8.0)	7.6	(6.5)			22.1	22.1 7
3 TKALČEC TOMISLAV (KK OKINAWA)	001 ANAN	(6.7)	7.8	7.8	(8.0)	7.5			23.1	23.1 5
4 BOMBARDI LEONARDO (MASTER RAPID SKF CBL)	099 UNSU	7.5	(8.1)	(7.4)	7.5	7.4			22.4	22.4 6
5 PEDRUZZI THOMAS (MASTER RAPID SKF CBL)	099 UNSU	7.4	7.2	7.3	(7.7)	(7.0)			21.9	21.9 8
6 STERNIŠA NEJC (KK MAWASHI)	099 UNSU	8.1	(8.4)	8.1	(8.0)	8.0			24.2	24.2 2
7 BARDOS ÁDÁM (SPORTINGBUDO)	092 SUPARINPEI	(8.5)	8.3	(7.7)	8.5	8.3			25.1	25.1 1
8 PICCIONI EDOARDO (KARATETERNI)	045 KOUSOUKUN DAI	(8.2)	8.1	(7.0)	8.0	7.9			24.0	24.0 4

R3-G1

31ST KARATE GRAND PRIX CROATIA - 2023-01-20

kata male U21

	Competitors	Kata	1	2	3	4	5	6	7	TOTAL	Extra Total Rank
1	BINOTTO PIETRO (SPORT TARGET)	099 UNSU	(7.8)	(8.3)	8.0	7.8	8.0			23.8	23.8 3
2	POLSINELLI GUIDO (FF.OO. POLIZIA DI STATO)	078 SANSAI	8.2	(8.5)	8.4	(7.3)	8.1			24.7	24.7 1
3	RELIC MATIJA (VIROVITICA)	047 KURURUNFA	(8.1)	8.0	7.7	(7.4)	7.5			23.2	23.2 4
4	HRCKA ROMAN (SVK)	008 CHATANYARA KUSHANKU	8.3	8.4	(7.8)	7.8	(8.5)			24.5	24.5 2

R3-G2

	Competitors	Kata	1	2	3	4	5	6	7	TOTAL	Extra Total Rank
1	SLUGA JURE (KK SEKI)	021 GOJUSHIHO SHO	8.4	(8.9)	(7.4)	7.5	8.2			24.1	24.1 2
2	PICCIONI EDOARDO (KARATETERNI)	064 OHAN DAI	(8.2)	7.9	8.0	8.1	(7.8)			24.0	24.0 3
3	BARDOS ADAM (SPORTINGBUDO)	008 CHATANYARA KUSHANKU	8.5	8.6	(8.8)	8.6	(7.6)			25.7	25.7 1
4	STERNISA NEJC (KK MAWASHI)	041 KANKU SHO	8.3	(9.3)	(7.0)	7.0	8.0			23.3	23.3 4

R4 Bronze Medal Match 1

	Competitors	Kata	1	2	3	4	5	6	7	TOTAL	Extra Total Rank
1	HRCKA ROMAN (SVK)	064 OHAN DAI	7.8	(8.3)	(7.7)	7.8	8.0			23.6	23.6 2
2	PICCIONI EDOARDO (KARATETERNI)	066 PACHU	7.7	8.1	(7.3)	8.0	(8.3)			23.8	23.8 1

R4 Bronze Medal Match 2

	Competitors	Kata	1	2	3	4	5	6	7	TOTAL	Extra Total Rank
1	BINOTTO PIETRO (SPORT TARGET)	078 SANSAI	(8.4)	8.5	8.5	(9.4)	8.4			25.4	25.4 1
2	SLUGA JURE (KK SEKI)	015 GANKAKU	8.2	8.2	8.7	(9.0)	(7.9)			25.1	25.1 2

R4 Gold Medal Match

	Competitors	Kata	1	2	3	4	5	6	7	TOTAL	Extra Total Rank
1	POLSINELLI GUIDO (FF.OO. POLIZIA DI STATO)	021 GOJUSHIHO SHO	8.3	(8.4)	(7.9)	7.9	8.2			24.4	24.4 1
2	BARDOS ADAM (SPORTINGBUDO)	009 CHIBANA NO KUSHANKU	7.9	8.2	(7.3)	7.5	(8.5)			23.6	23.6 2

Results

1	POLSINELLI GUIDO	G.S.FF.OO. POLIZIA DI STATO		ITALY
2	BARDOS ADAM	KARATE KLUB SPORTINGBUDO		HUNGARY
3	PICCIONI EDOARDO	SSD POLISPORTIVA TERNANA		ITALY
3	BINOTTO PIETRO	SPORT TARGET		ITALY
5	HRCKA ROMAN	SLOVAK NATIONAL TEAM		SLOVAKIA
5	SLUGA JURE	KARATE KLUB SEKI		SLOVENIA
7	RELIC MATIJA	KK VIROVITICA		CROATIA
7	STERNISA NEJC	KARATE KLUB MAWASHI POSTOJNA		SLOVENIA
9	MATUSKI GEORGI	KARATE CLUB SHURIKEN		BULGARIA
9	TKALČEC TOMISLAV	KK OKINAWA MALI BUKOVEC		CROATIA
11	VELADŽIĆ SENAIĐ	KBES 5.11-BK BOSANSKA KRUPA		BOSNIA AND HERZEGOVINA
11	BOMBARDI LEONARDO	MASTER RAPID SKF CBL		ITALY
13	VALDESI FRANCESCO	A.S.D. POL. POLO VERDE		ITALY
13	SOKOLOV HLIB	ZAKHYST KARATE CLUB		UKRAINE
15	BEKE BALINT	KSI HUNGARY		HUNGARY
15	PEDRUZZI THOMAS	MASTER RAPID SKF CBL		ITALY
17	BARLETTA LEONARDO	MASTER RAPID SKF CBL		ITALY
17	CALABRESE LUCA	A.S.D. SEN SHIN KAI ROVIGO		ITALY
17	EDERAR KARIM	MASTER RAPID SKF CBL		ITALY
17	MADONIA FILIPPO MARIA	A.S.D. REAL SOCIETÀ MONREALE		ITALY
21	MASSAGLIA MARCO	SPAZIO SPORT FORTE DEI MARMÌ		ITALY
21	BOROJEVIĆ MARIO	KARATE KLUB TEMPO		CROATIA
21	MEŠANOVIĆ BENJAMIN	KARATE KLUB VELENJE		SLOVENIA
21	MATUŠAN ANTONIO	ENPI RAB		CROATIA
25	FAFANDEL DORIAN	ENPI RAB		CROATIA

Kumite Female U21 -50kg

31ST KARATE GRAND PRIX CROATIA, CITY SPORTS HALL SAMOBOR, ANDRIJE HEBRANGA 26A, SAMOBOR, CROATIA, CRO

2023-01-21

Tatami
2 09:00

Pool
2/2

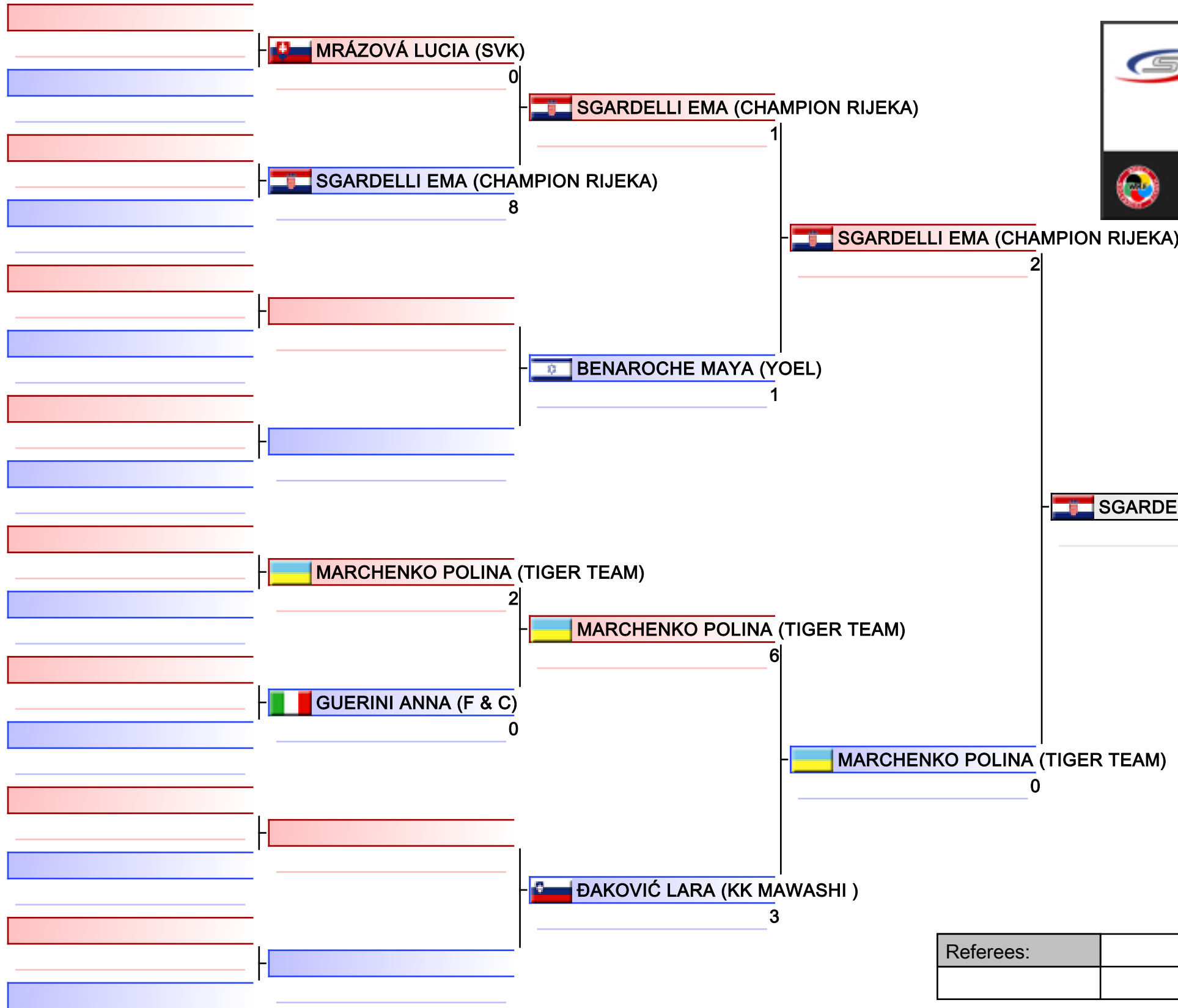

1. SGARDELLI EMA (CHAMPION RIJEKA)
2. VITALI VERONICA (F & C)
3. ILINA KSENIIA (CHAMPION KARATE CLUB)
3. MRÁZOVÁ LUCIA (SVK)
5. MAGAJNA MAŠA (KK MAWASHI)
5. MARCHENKO POLINA (TIGER TEAM)
7. WEISMANN LARA (KK BREGANA)
7. BENAROCHE MAYA (YOEL)

Referees:			

Kumite Male U21 +84kg

31ST KARATE GRAND PRIX CROATIA, CITY SPORTS HALL SAMOBOR, ANDRIJE HEBRANGA 26A, SAMOBOR, CROATIA, CRO

2023-01-21

Tatami
5 10:00

Pool
1/2

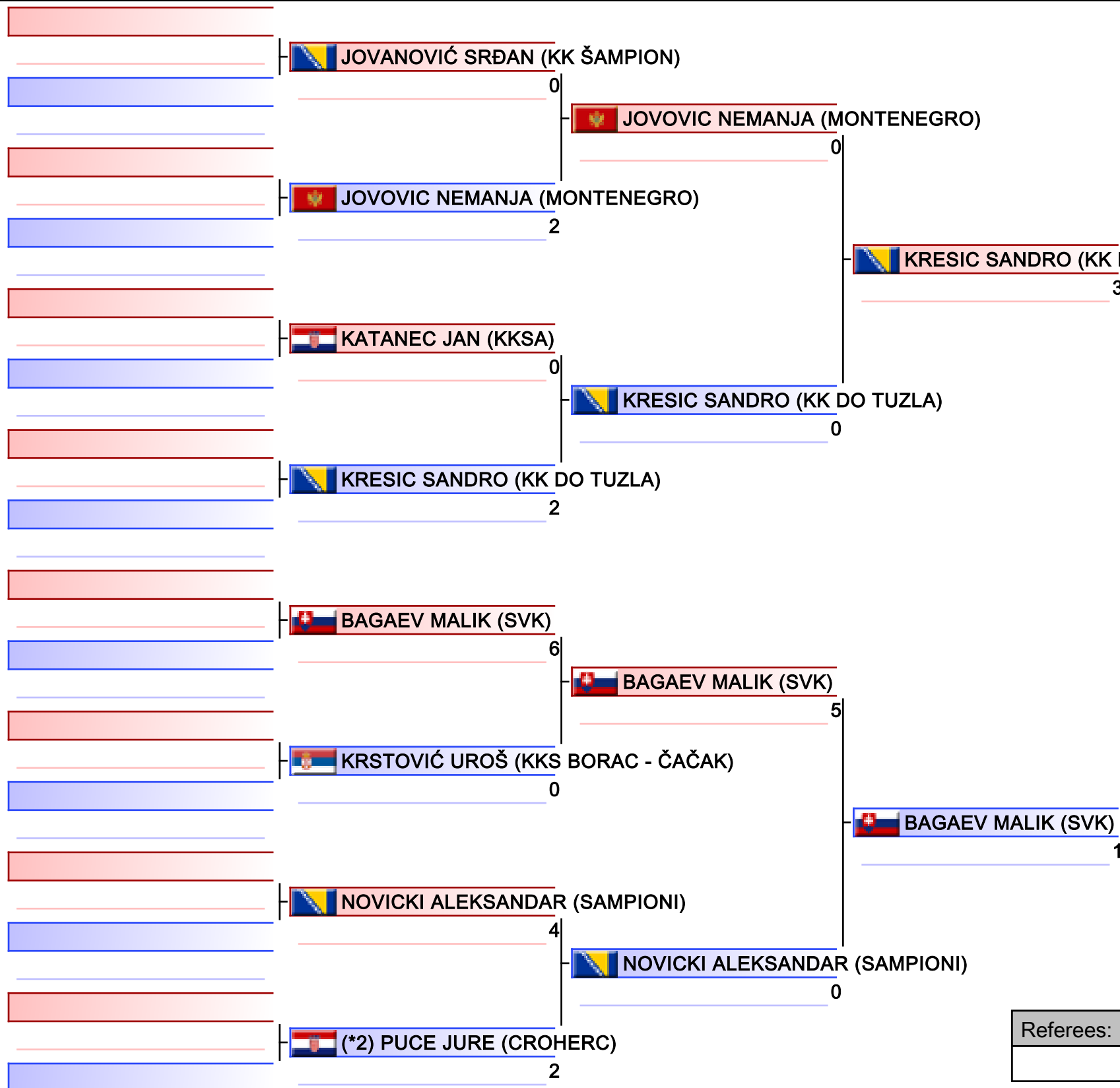

KRESIC SANDRO (KK DO TUZLA)

1. KRESIC SANDRO (KK DO TUZLA)
2. STOJANOVIC STEFAN (MAKPETROL MKD)
3. JOVOVIC NEMANJA (MONTENEGRO)
3. MARKULJEVIĆ UROŠ (TRBOVLJE)
5. BAGAEV MALIK (SVK)
5. GLUHINIĆ DARIO (KK STIJENA)
7. KATANEC JAN (KKSA)
7. KVESIĆ LUKA (KKHZ)

*Seeded

Referees:			

Kumite Male U21 +84kg

31ST KARATE GRAND PRIX CROATIA, CITY SPORTS HALL SAMOBOR, ANDRIJE HEBRANGA 26A, SAMOBOR, CROATIA, CRO

2023-01-21

Tatami
6 10:00

Pool
2/2

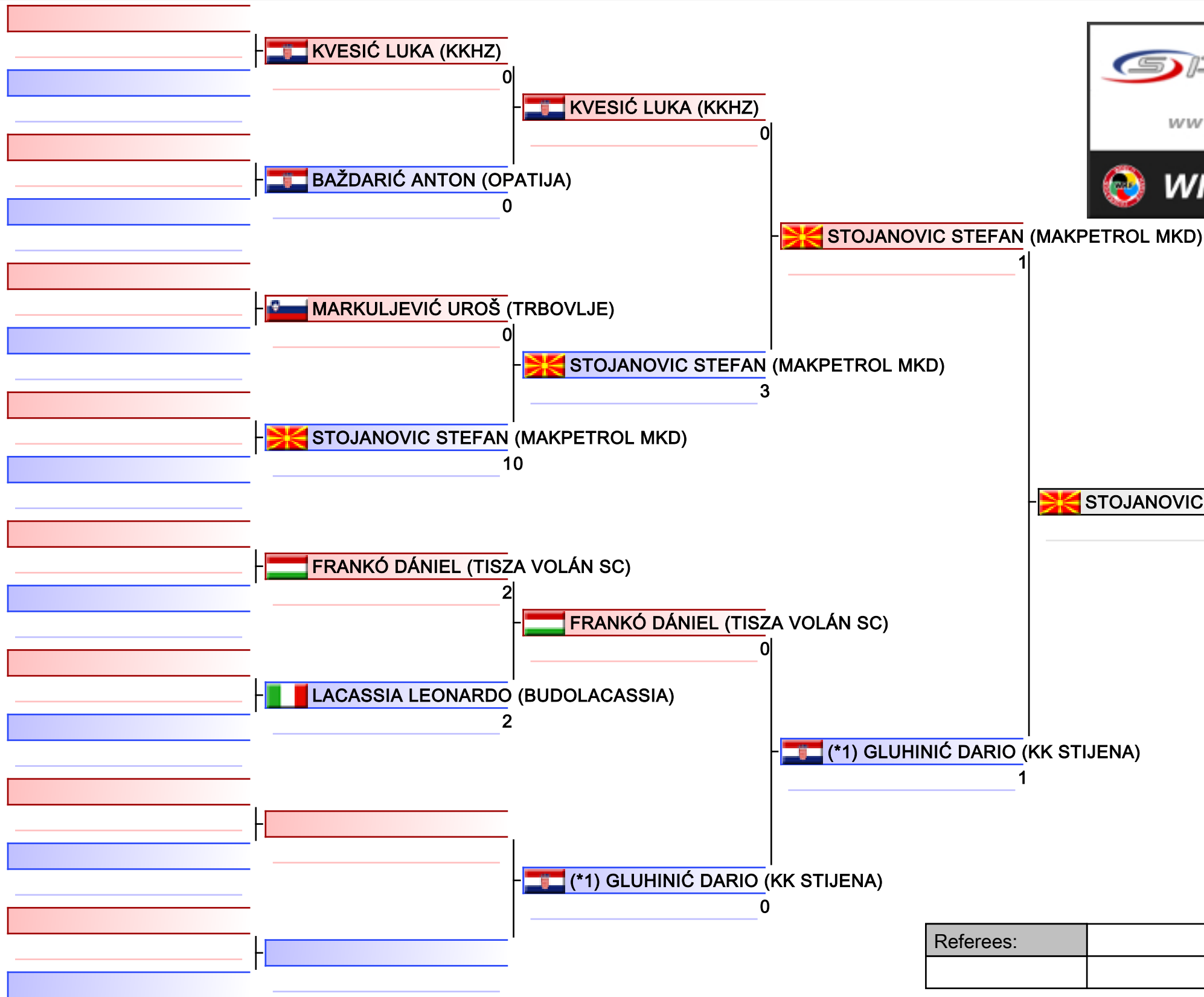

1. KRESIC SANDRO (KK DO TUZLA)
2. STOJANOVIC STEFAN (MAKPETROL MKD)
3. JOVOVIC NEMANJA (MONTENEGRO)
3. MARKULJEVIĆ UROŠ (TRBOVLJE)
5. BAGAEV MALIK (SVK)
5. GLUHINIĆ DARIO (KK STIJENA)
7. KATANEC JAN (KKSA)
7. KVESIĆ LUKA (KKHZ)

*Seeded

Referees:			

Kumite Male U21 -60kg

31ST KARATE GRAND PRIX CROATIA, CITY SPORTS HALL SAMOBOR, ANDRIJE HEBRANGA 26A, SAMOBOR, CROATIA, CRO

2023-01-21

Tatami
3 12:55

Pool
1/2

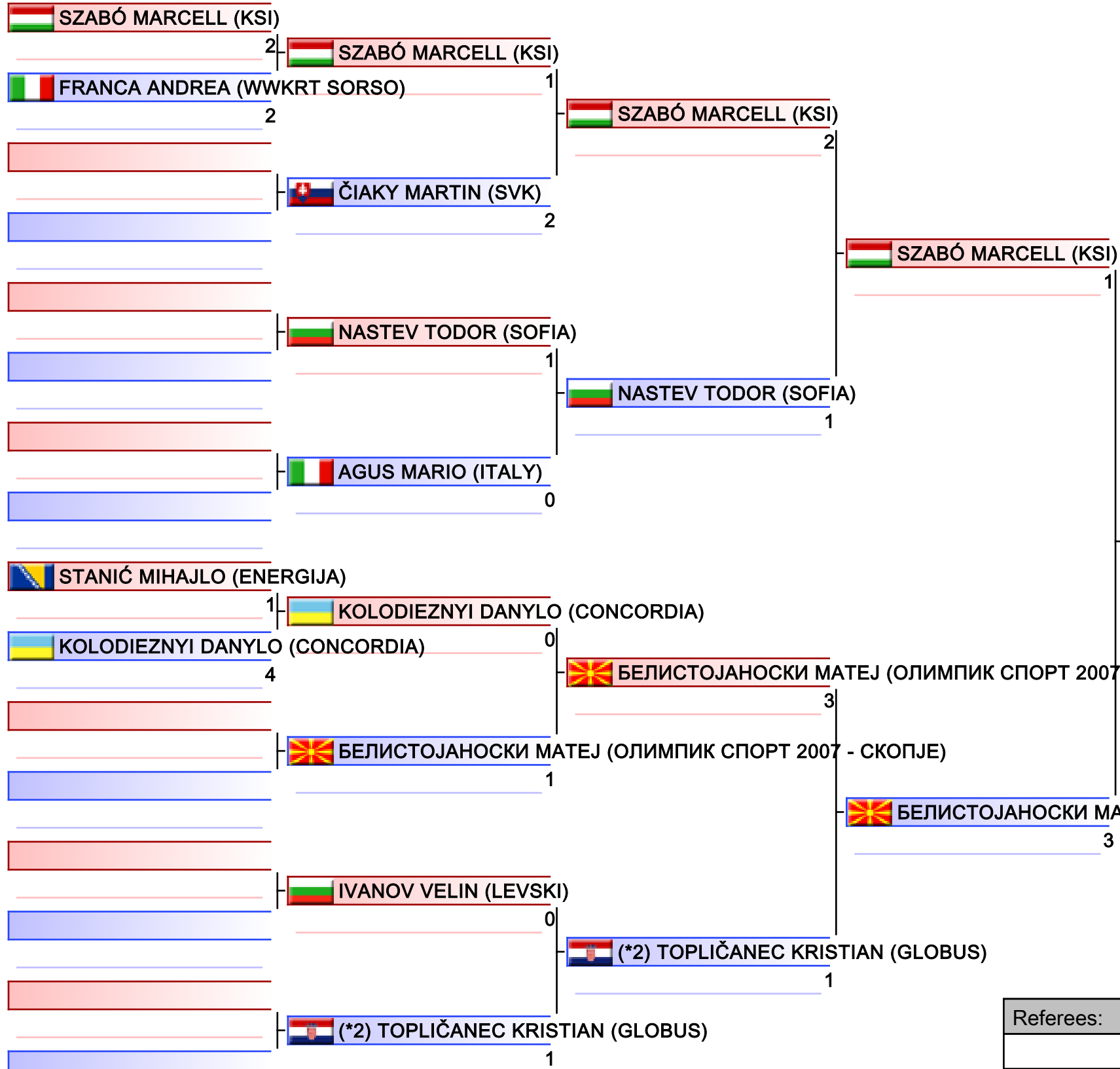

- | |
|---|
| 1. DUJAKOVIĆ PAVLE (ENERGIJA) |
| 2. БЕЛИСТОЈАНОСКИ МАТЕЈ (ОЛИМПИСКИ СПОРТ 2007 - СКОПЈЕ) |
| 3. KOLODIEZNYI DANYLO (CONCORDIA) |
| 3. КОСТОВ БОЈАН (ОЛИМПИСКИ СПОРТ 2007 - СКОПЈЕ) |
| 5. SZABÓ MARCELL (KSI) |
| 5. RUMENJAK NOA (KK IPON ZAGREB) |
| 7. TOPLIČANEC KRISTIAN (GLOBUS) |
| 7. SPAMPINATO MARCO_GAETANO (REMBUKAN) |

*Seeded

Referees:			

Kumite Male U21 -60kg

31ST KARATE GRAND PRIX CROATIA, CITY SPORTS HALL SAMOBOR, ANDRIJE HEBRANGA 26A, SAMOBOR, CROATIA, CRO

2023-01-21

Tatami
4 12:55

Pool
2/2

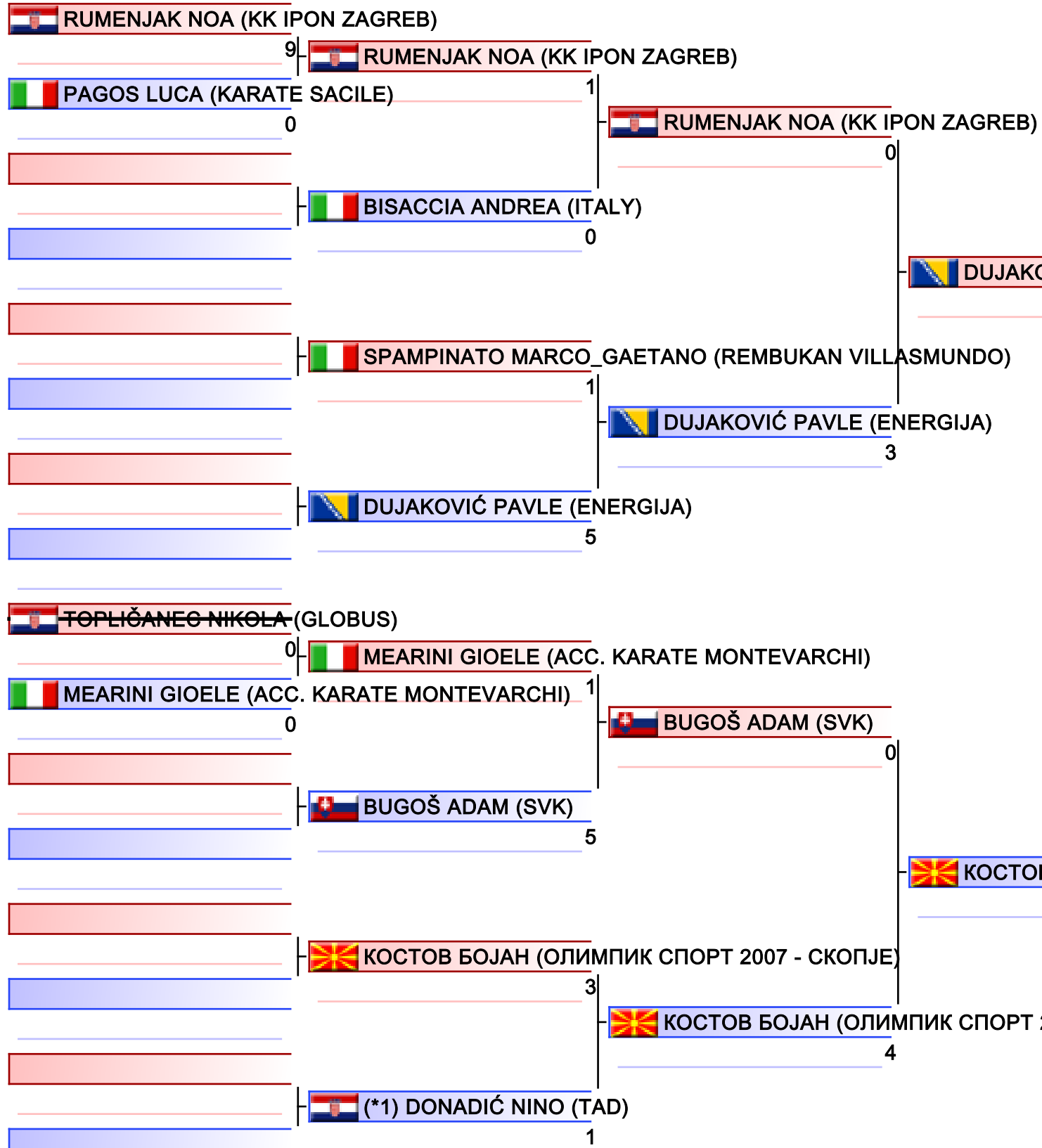

- | |
|---|
| 1. DUJAKOVIĆ PAVLE (ENERGIJA) |
| 2. БЕЛИСТОЈАНОСКИ МАТЕЈ (ОЛИМПИК СПОРТ 2007 - СКОПЈЕ) |
| 3. KOLODIEZNYI DANYLO (CONCORDIA) |
| 3. КОСТОВ БОЈАН (ОЛИМПИК СПОРТ 2007 - СКОПЈЕ) |
| 5. SZABÓ MARCELL (KSI) |
| 5. RUMENJAK NOA (KK IPON ZAGREB) |
| 7. TOPLIČANEC KRISTIAN (GLOBUS) |
| 7. SPAMPINATO MARCO_GAETANO (REMBUKAN VILLASMUNDO) |

*Seeded

Referees:			

Kumite Male U21 -67kg

31ST KARATE GRAND PRIX CROATIA, CITY SPORTS HALL SAMOBOR, ANDRIJE HEBRANGA 26A, SAMOBOR, CROATIA, CRO

2023-01-21

Tatami
5 11:15

Pool
1/2

ΤΡΑΓΑΣ ΝΙΚΟΛΑΟΣ (492-ΦΩ37)

RAMOS MATT (ITALY) 0

RAMOS MATT (ITALY) 2

2

TVRDOŇ ANDREJ (SVK) 3

TVRDOŇ ANDREJ (SVK) 3

3

ĆUKOVIĆ LUKA (KK SLAVIJA)

LORENZETTI TOMMASO (TKT) 0

LORENZETTI TOMMASO (TKT) 5

4

KELEMEN KERTI (SZARVAS) 0

KELEMEN KERTI (SZARVAS) 0

0

MARKOVIC LAZAR (SAMPIONI)

MARKOVIC LAZAR (SAMPIONI) 4

ACCOMANDO FRANCESCO (SHIZOKU KRT AV) 0

KOŠMRLJ ERIK_TEO (KK LJUBLJANA) 2

1

KOŠMRLJ ERIK_TEO (KK LJUBLJANA) 1

1

PETRESKI STEFAN (ČOLE - OHRID)

PETRESKI STEFAN (ČOLE - OHRID) 2

RADAN UROŠ (KKS BORAC - ČAČAK) 0

(*2) TOMLJANOVIĆ LUKA (KKHZ) 1

0

(*2) TOMLJANOVIĆ LUKA (KKHZ) 8

8



TVRDOŇ ANDREJ (SVK) 1

1

LORENZETTI TOMMASO (TKT) 2

2

TVRDOŇ ANDREJ (SVK) 3

3

TVRDOŇ ANDREJ (SVK) 3

3

TVRDOŇ ANDREJ (SVK) 3

3

TVRDOŇ ANDREJ (SVK) 3

3

TVRDOŇ ANDREJ (SVK) 3

3

TVRDOŇ ANDREJ (SVK) 3

3

TVRDOŇ ANDREJ (SVK) 3

3

TVRDOŇ ANDREJ (SVK) 3

3

TVRDOŇ ANDREJ (SVK) 3

3

TVRDOŇ ANDREJ (SVK) 3

3

TVRDOŇ ANDREJ (SVK) 3

3

TVRDOŇ ANDREJ (SVK) 3

3

1. TVRDOŇ ANDREJ (SVK)
2. STOJMIROV STEFAN (BOTTONI)
3. RAMOS MATT (ITALY)
3. MEMIŠEVIĆ KENAN (KARATE AKADEMIJA - AR)
5. KOŠMRLJ ERIK_TEO (KK LJUBLJANA)
5. ZRNIĆ MIHAJLO (ENERGIJA)
7. LORENZETTI TOMMASO (TKT)
7. DUMBOVIĆ ROKO (KKTS)

*Seeded

Referees:			

Kumite Male U21 -67kg

31ST KARATE GRAND PRIX CROATIA, CITY SPORTS HALL SAMOBOR, ANDRIJE HEBRANGA 26A, SAMOBOR, CROATIA, CRO

2023-01-21

Tatami
6 11:15

Pool
2/2

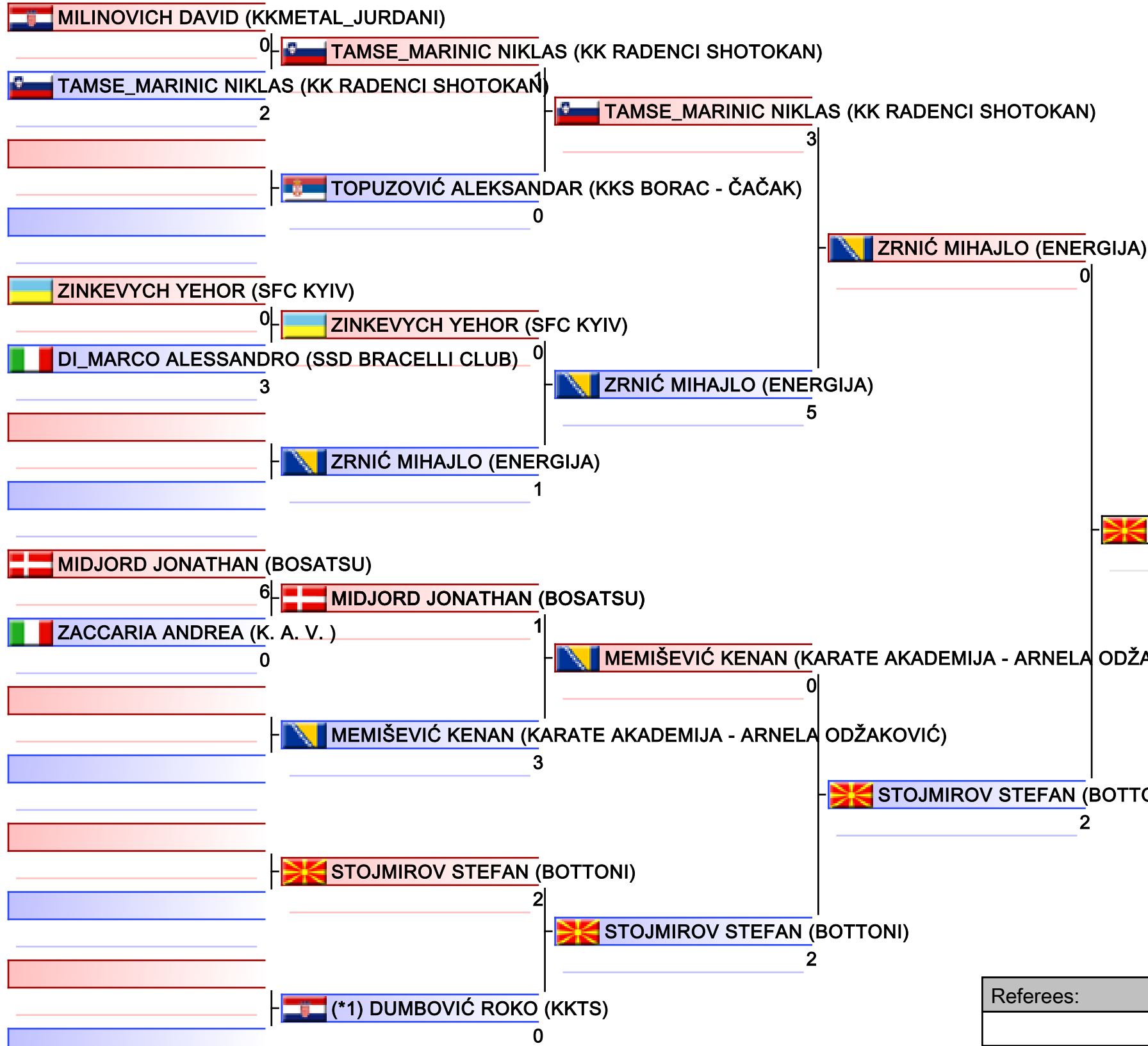

1. TVRDOŇ ANDREJ (SVK)
2. STOJMIROV STEFAN (BOTTONI)
3. RAMOS MATT (ITALY)
3. MEMIŠEVIĆ KENAN (KARATE AKADEMIJA - ARNELA ODŽAKOVIĆ)
5. KOŠMRLJ ERIK_TEO (KK LJUBLJANA)
5. ZRNIC MIHAJLO (ENERGIJA)
7. LORENZETTI TOMMASO (TKT)
7. DUMBOVIĆ ROKO (KKTS)

*Seeded

Referees:			

Kumite Male U21 -75kg

31ST KARATE GRAND PRIX CROATIA, CITY SPORTS HALL SAMOBOR, ANDRIJE HEBRANGA 26A, SAMOBOR, CROATIA, CRO

2023-01-21

Tatami
3 11:05

Pool
1/2

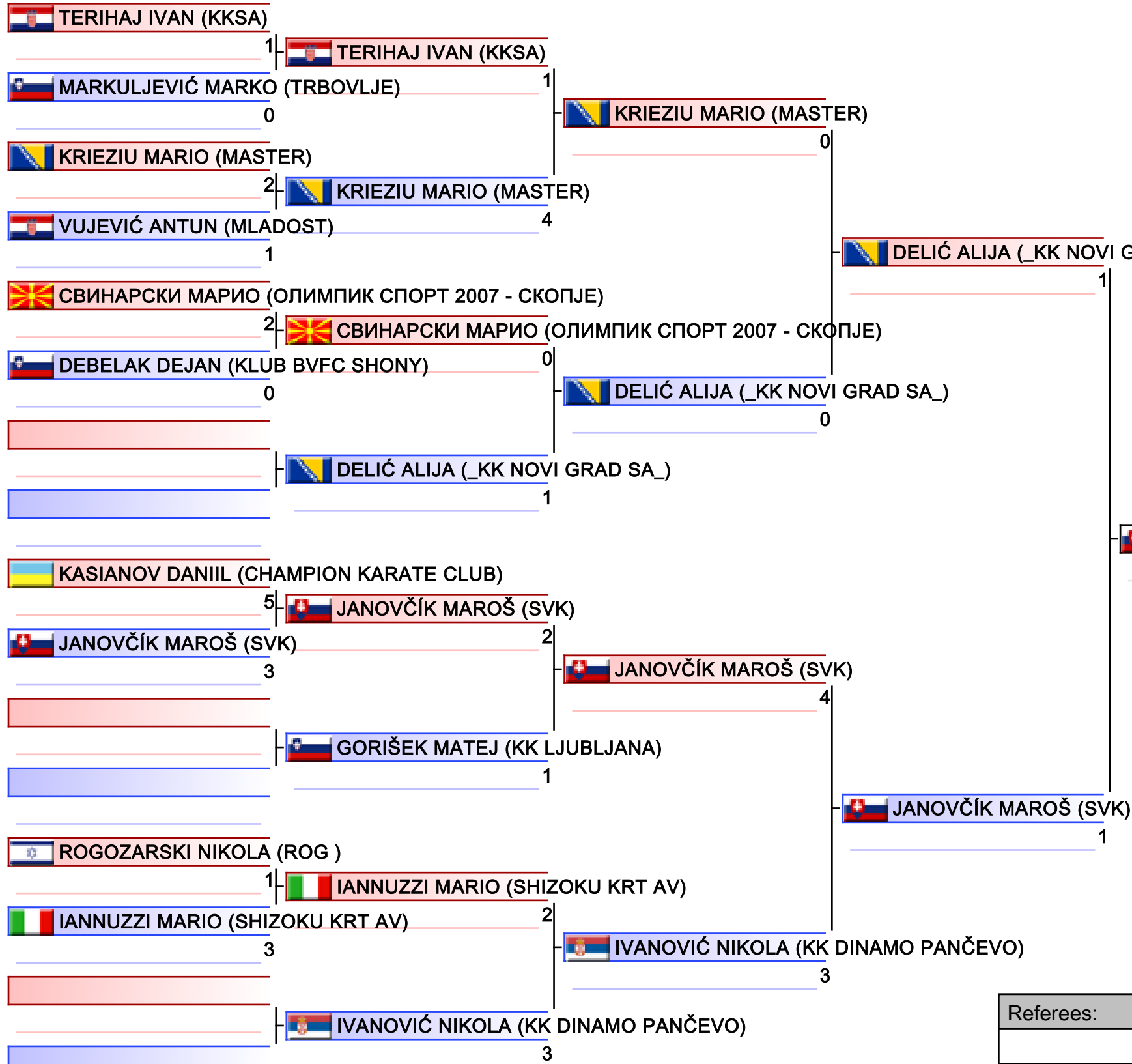

1. JANOVČÍK MAROŠ (SVK)
2. JOVOVIĆ LAZAR (MONTENEGRO)
3. KASIANOV DANIIL (CHAMPION KARATE CLUB)
3. ORLANDIC PETAR (STG)
5. DELIĆ ALIJA (_KK NOVI GRAD SA_)
5. KNIRSCH PATRIK (MTK)
7. IVANOVIĆ NIKOLA (KK DINAMO PANČEVO)
7. BARLOV ADIN (KK ZANSHIN)

Referees:			

Kumite Male U21 -75kg

31ST KARATE GRAND PRIX CROATIA, CITY SPORTS HALL SAMOBOR, ANDRIJE HEBRANGA 26A, SAMOBOR, CROATIA, CRO

2023-01-21

Tatami
4 11:00

Pool
2/2

JOVOVIĆ LAZAR (MONTENEGRO)

4 | **JOVOVIĆ LAZAR (MONTENEGRO)**

1 | **STANIC BORNA (KK BREGANA)**

1

0

0

0

0

0

0

0

0

0

0

0

0

0

0

0

0

0

0

0

0

0

0

0

0

0

0

0

0

0

4 | **JOVOVIĆ LAZAR (MONTENEGRO)**

3 | **STANIC BORNA (KK BREGANA)**

1

0

0

0

0

0

0

0

0

0

0

0

0

0

0

0

0

0

0

0

0

0

0

0

0

0

0

0

0

0

1 | **JOVOVIĆ LAZAR (MONTENEGRO)**

1

0

0

0

0

0

0

0

0

0

0

0

0

0

0

0

0

0

0

0

0

0

0

0

0

0

0

0

0

1 | **JOVOVIĆ LAZAR (MONTENEGRO)**

1

0

0

0

0

0

0

0

0

0

0

0

0

0

0

0

0

0

0

0

0

0

0

0

0

0

0

0

0



JOVOVIĆ LAZAR (MONTENEGRO)

1. JANOVČÍK MAROŠ (SVK)
2. JOVOVIĆ LAZAR (MONTENEGRO)
3. KASIANOV DANIIL (CHAMPION KARATE CLUB)
3. ORLANDIC PETAR (STG)
5. DELIĆ ALIJA (_KK NOVI GRAD SA_)
5. KNIRSCH PATRIK (MTK)
7. IVANOVIĆ NIKOLA (KK DINAMO PANČEVO)
7. BARLOV ADIN (KK ZANSHIN)

Referees:			

Kumite Male U21 -84kg

31ST KARATE GRAND PRIX CROATIA, CITY SPORTS HALL SAMOBOR, ANDRIJE HEBRANGA 26A, SAMOBOR, CROATIA, CRO

2023-01-21

Tatami
1 11:15

Pool
1/2

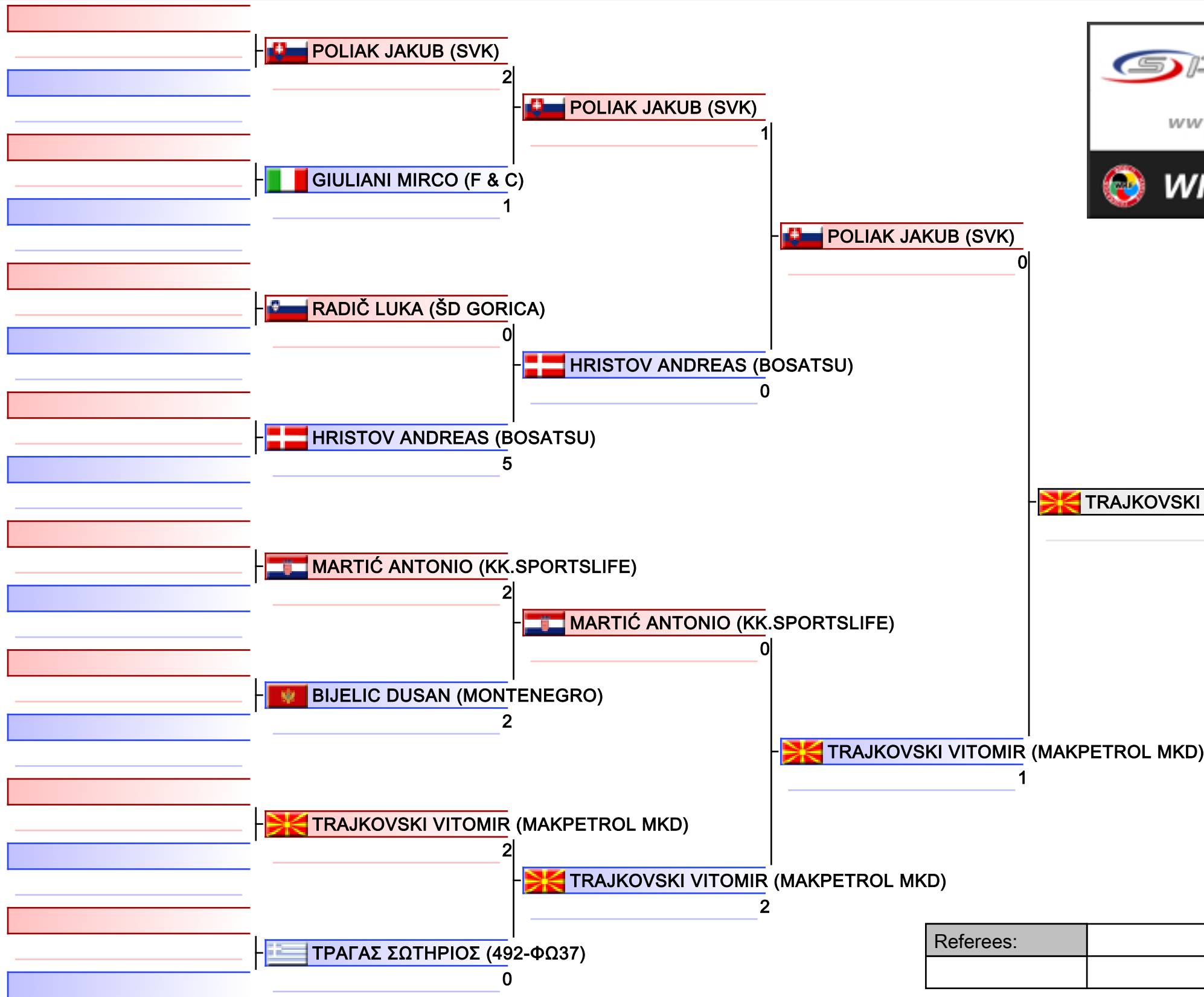

1. TRAJKOVSKI VITOMIR (MAKPETROL MKD)
2. ΑΝΓΕΛΟΒΣΚΙ ΑΝΔΡΕЈ (ΟΛΙΜΠΙΚ ΣΠΟΡΤ 200)
3. POLIAK JAKUB (SVK)
3. KEŠEĽAK DOMINIK (SVK)
5. MARTIĆ ANTONIO (KK.SPORTSLIFE)
5. JORDAN TIMOTEJ (KK BUSHIDO)
7. ΤΡΑΓΓΑΣ ΣΩΤΗΡΙΟΣ (492-ΦΩ37)
7. POLIAKOV MAKSYM (OKI)

Referees:			

Kumite Male U21 -84kg

31ST KARATE GRAND PRIX CROATIA, CITY SPORTS HALL SAMOBOR, ANDRIJE HEBRANGA 26A, SAMOBOR, CROATIA, CRO

2023-01-21

Tatami
2 11:20

Pool
2/2

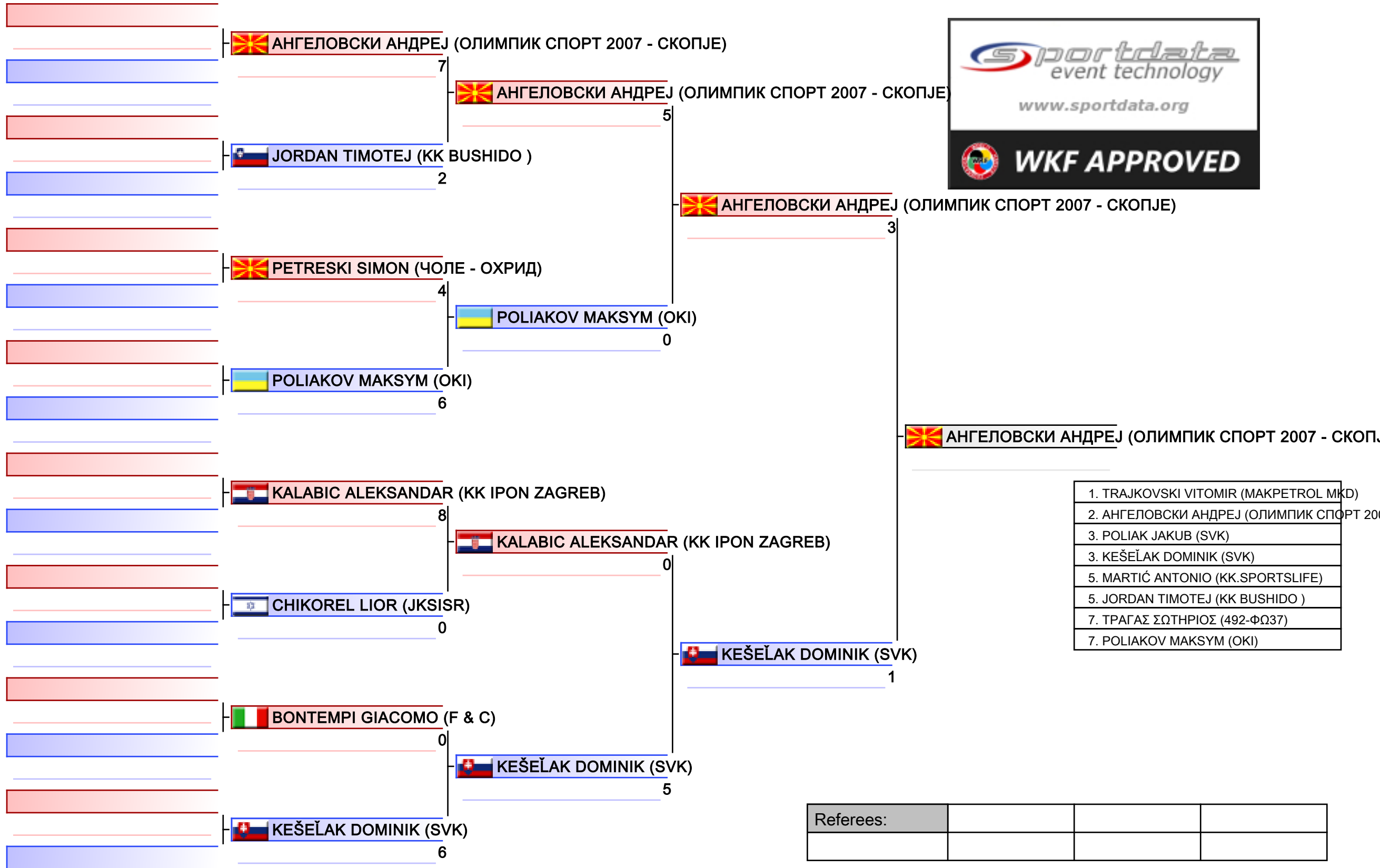

Referees:			

Kumite female Cadets +61kg

31ST KARATE GRAND PRIX CROATIA, CITY SPORTS HALL SAMOBOR, ANDRIJE HEBRANGA 26A, SAMOBOR, CROATIA, CRO

2023-01-22

Tatami
1 12:25

Pool
1/2

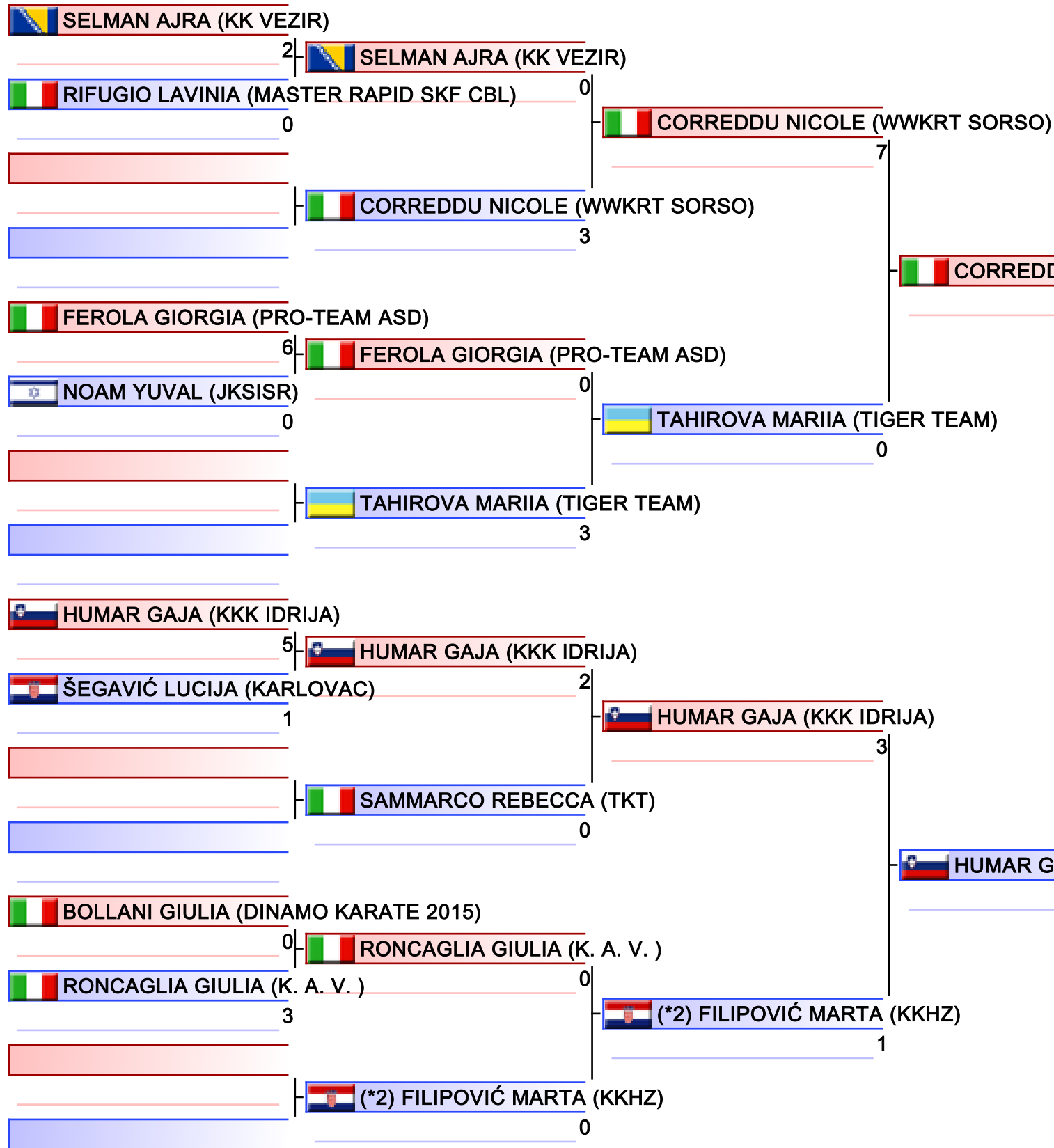

1. TOMIĆ SARA (KKHZ)
2. CORREDDU NICOLE (WWKRT SORSO)
3. HUMAR GAJA (KKK IDRIJA)
3. KULIKOVÁ VIRA (CMK BB)
5. SELMAN AJRA (KK VEZIR)
5. CHRASTINOVÁ PETRA (SVK)
7. TAHIROVA MARIIA (TIGER TEAM)
7. BORICIC NADJA (MONTENEGRO)

*Seeded

Referees:			

Kumite female Cadets +61kg

31ST KARATE GRAND PRIX CROATIA, CITY SPORTS HALL SAMOBOR, ANDRIJE HEBRANGA 26A, SAMOBOR, CROATIA, CRO

2023-01-22

Tatami
2 12:30

Pool
2/2

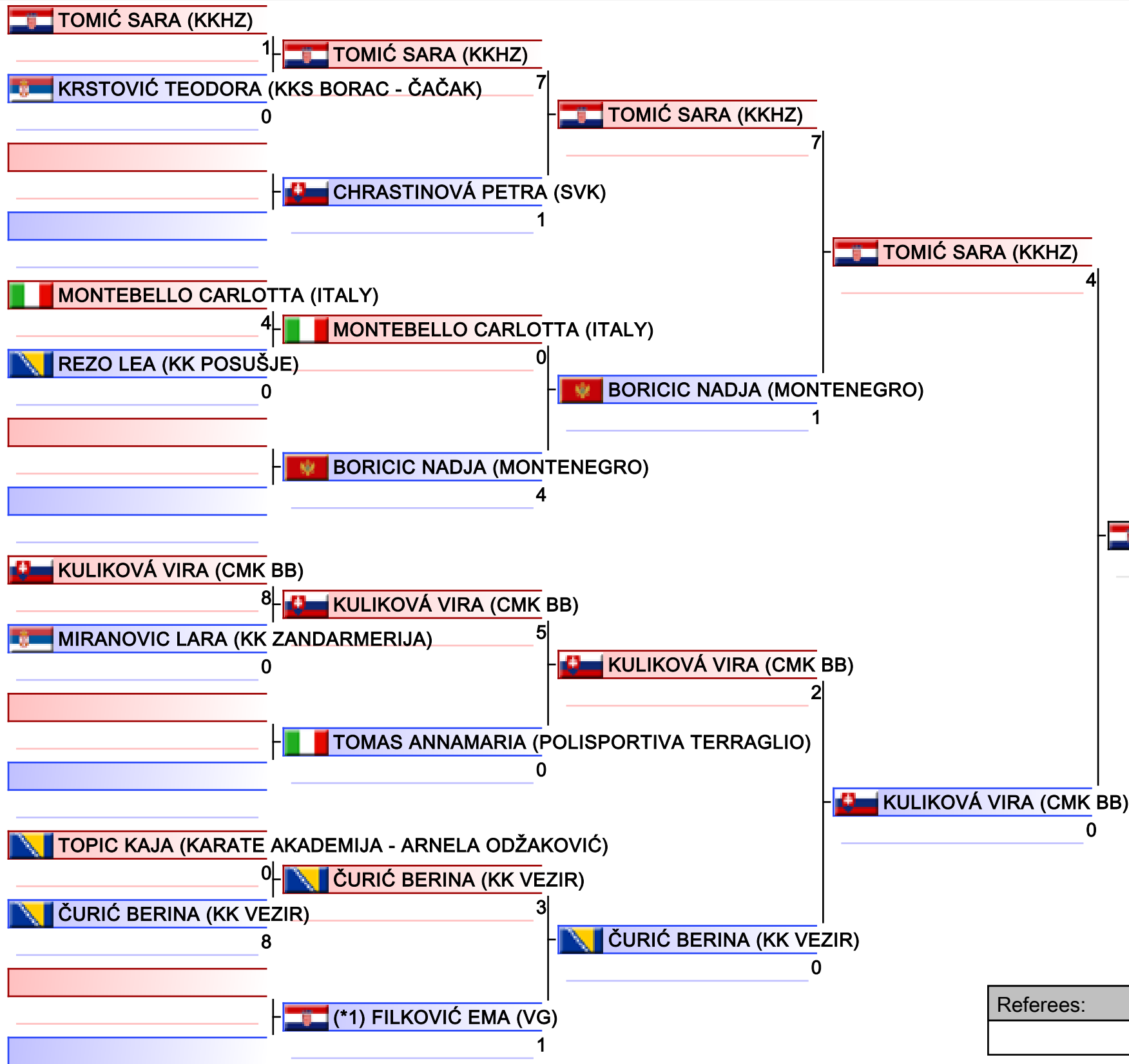

- | |
|----------------------------------|
| 1. TOMIĆ SARA (KKHZ) |
| 2. CORREDDU NICOLE (WWKRT SORSO) |
| 3. HUMAR GAJA (KKK IDRIJA) |
| 3. KULIKOVÁ VIRA (CMK BB) |
| 5. SELMAN AJRA (KK VEZIR) |
| 5. CHRASTINOVÁ PETRA (SVK) |
| 7. TAHIROVA MARIIA (TIGER TEAM) |
| 7. BORICIC NADJA (MONTENEGRO) |

*Seeded

Referees:			

Kumite female Cadets -61kg

31ST KARATE GRAND PRIX CROATIA, CITY SPORTS HALL SAMOBOR, ANDRIJE HEBRANGA 26A, SAMOBOR, CROATIA, CRO

2023-01-22

Tatami
5 11:15

Pool
1/2

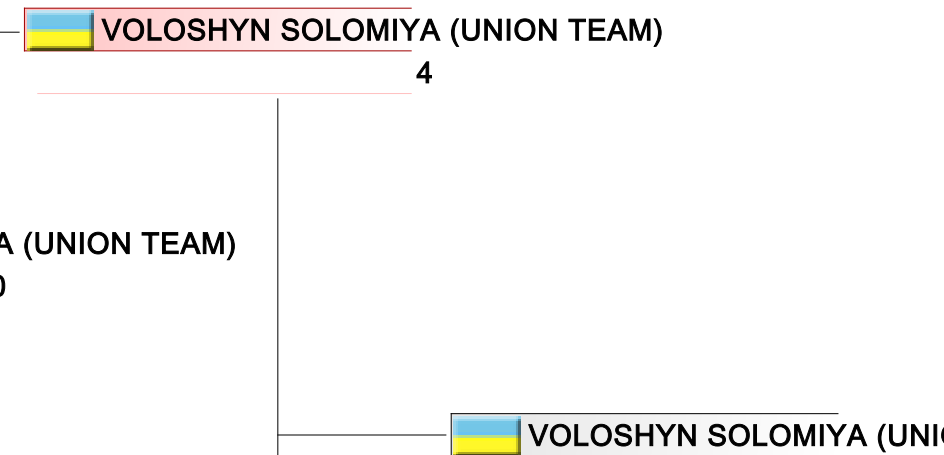
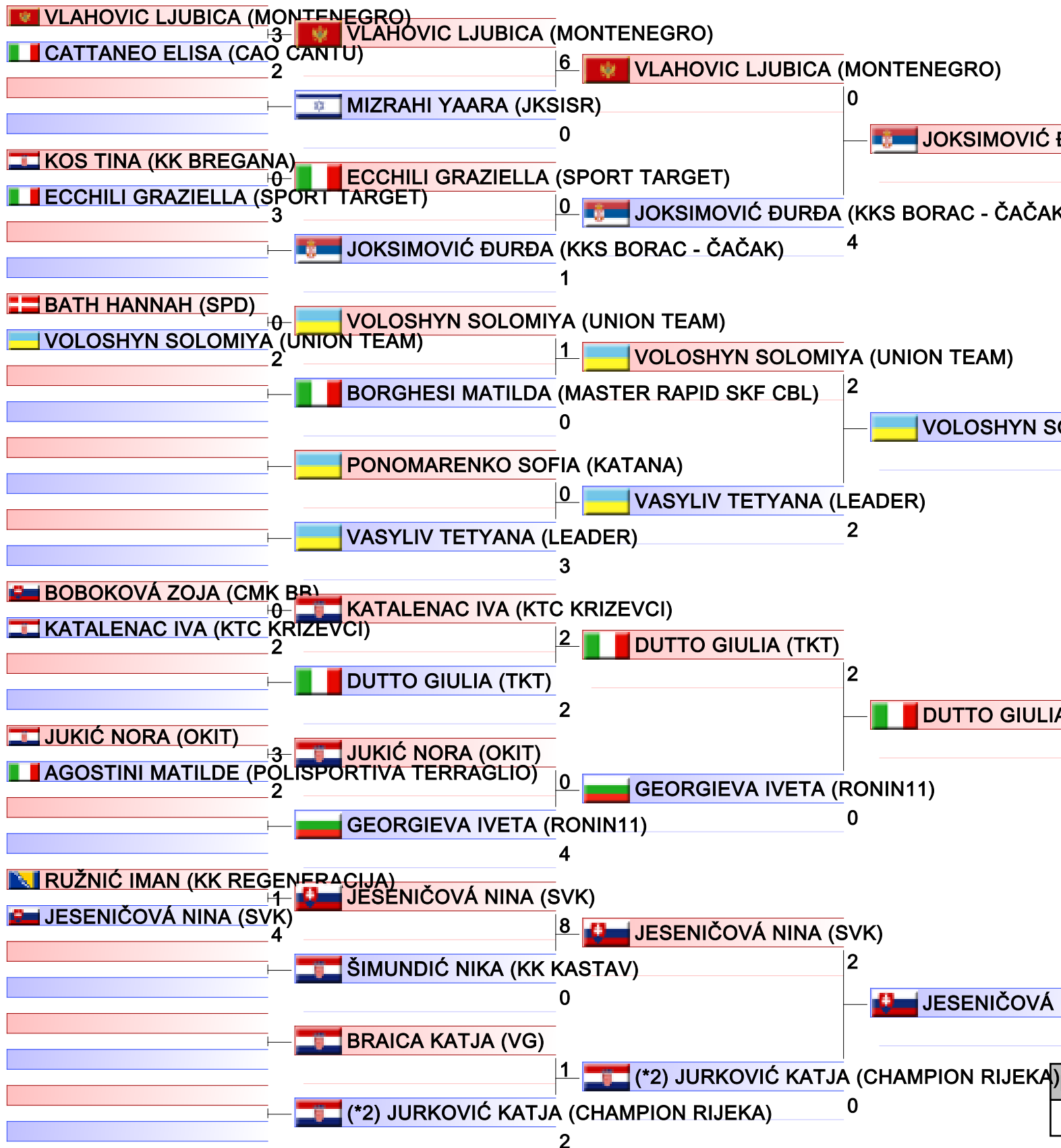

1. DAMJANOVIC JOVANA (MONTENEGRO)
2. VOLOSHYN SOLOMIYA (UNION TEAM)
3. STRAHIIJA LAURA (GLOBUS)
3. JESENIČOVÁ NINA (SVK)
5. REDŽIĆ JANA (OPATIJA)
5. JOKSIMOVIĆ ĐURĐA (KKS BORAC - ČAČAK)
7. GANDOLA VIOLA (CAO CANTU)
7. BATH HANNAH (SPD)

*Seeded

Referees:			

Kumite female Cadets -61kg

31ST KARATE GRAND PRIX CROATIA, CITY SPORTS HALL SAMOBOR, ANDRIJE HEBRANGA 26A, SAMOBOR, CROATIA, CRO

2023-01-22

Tatami
6 11:05

Pool
2/2

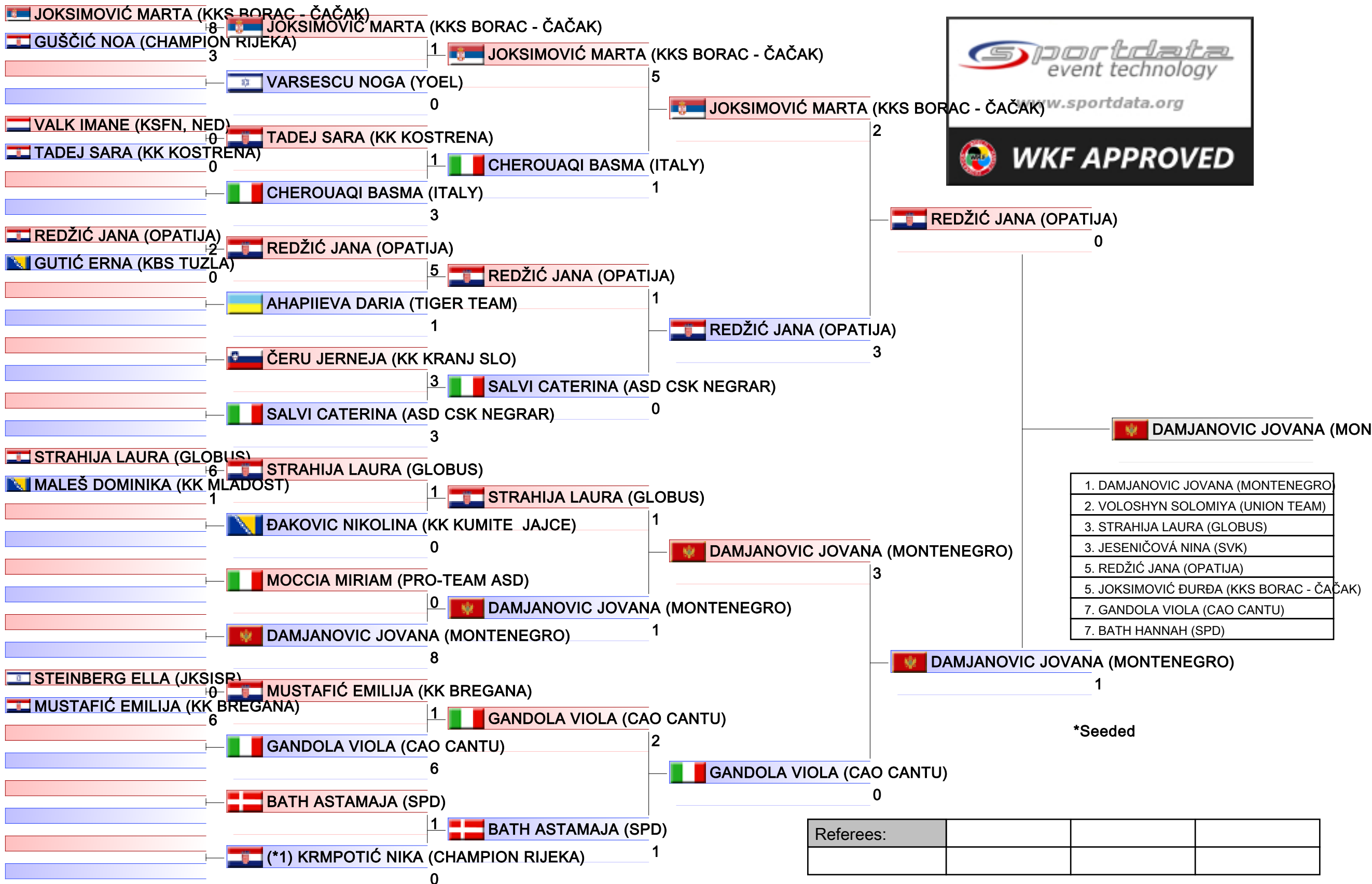

Kumite female Juniors +66kg

31ST KARATE GRAND PRIX CROATIA, CITY SPORTS HALL SAMOBOR, ANDRIJE HEBRANGA 26A, SAMOBOR, CROATIA, CRO

2023-01-21

Tatami
1 12:30

Pool
1/2

 PERGOLESASI ASIA (ITALY)

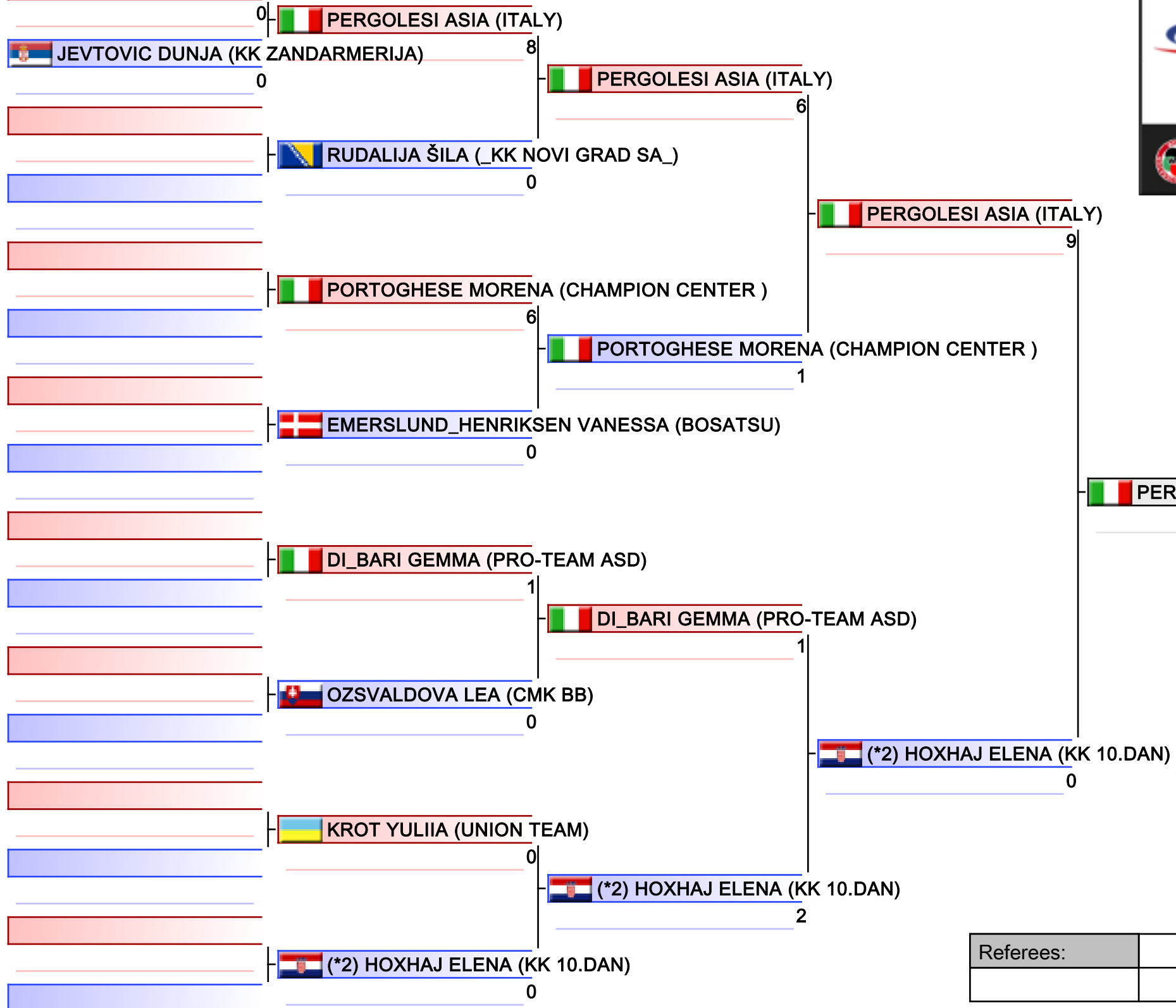

1. PERGOLESASI ASIA (ITALY)
2. LUKENDA NINA (KKHZ)
3. RAJIĆ DUNJA (LAZAREVO)
3. PORTOGHESE MORENA (CHAMPION CENTER)
5. MALENKOVA YULIA (OKI)
5. HOXHAJ ELENA (KK 10.DAN)
7. RONCAGLIA GIULIA (K. A. V.)
7. JEVTOMIC DUNJA (KK ZANDARMERIJA)

*Seeded

Referees:			

Kumite female Juniors +66kg

31ST KARATE GRAND PRIX CROATIA, CITY SPORTS HALL SAMOBOR, ANDRIJE HEBRANGA 26A, SAMOBOR, CROATIA, CRO

2023-01-21

Tatami
2 12:30

Pool
2/2

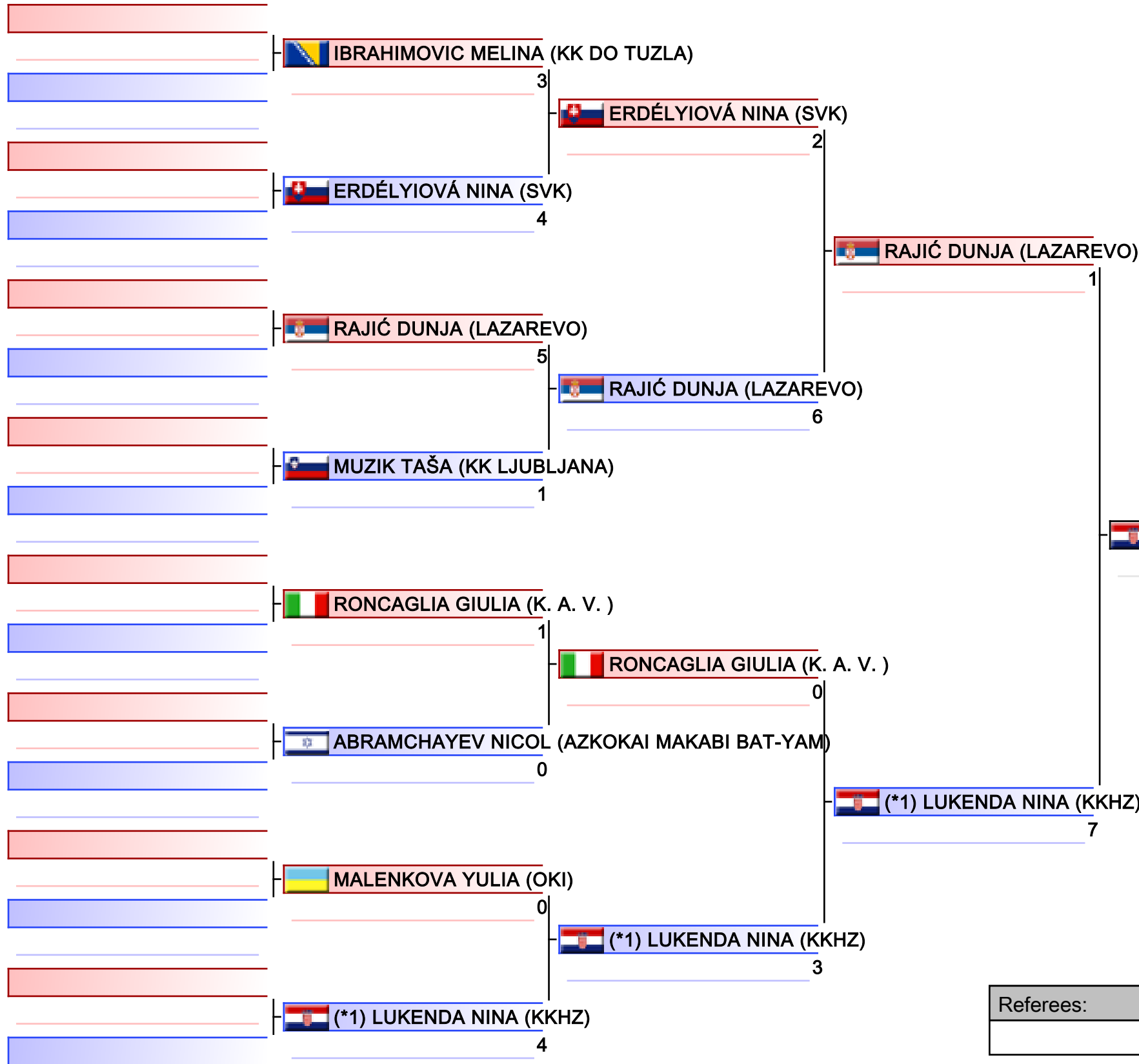

1. PERGOLESI ASIA (ITALY)
2. LUKENDA NINA (KKHZ)
3. RAJIĆ DUNJA (LAZAREVO)
3. PORTOGHESE MORENA (CHAMPION CENTER)
5. MALENKOVA YULIA (OKI)
5. HOXHAJ ELENA (KK 10.DAN)
7. RONCAGLIA GIULIA (K. A. V.)
7. JEVTOVIC DUNJA (KK ZANDARMERIJA)

*Seeded

Referees:			

Kumite female Juniors -66kg

31ST KARATE GRAND PRIX CROATIA, CITY SPORTS HALL SAMOBOR, ANDRIJE HEBRANGA 26A, SAMOBOR, CROATIA, CRO

2023-01-21

Tatami
5 13:25

Pool
1/2

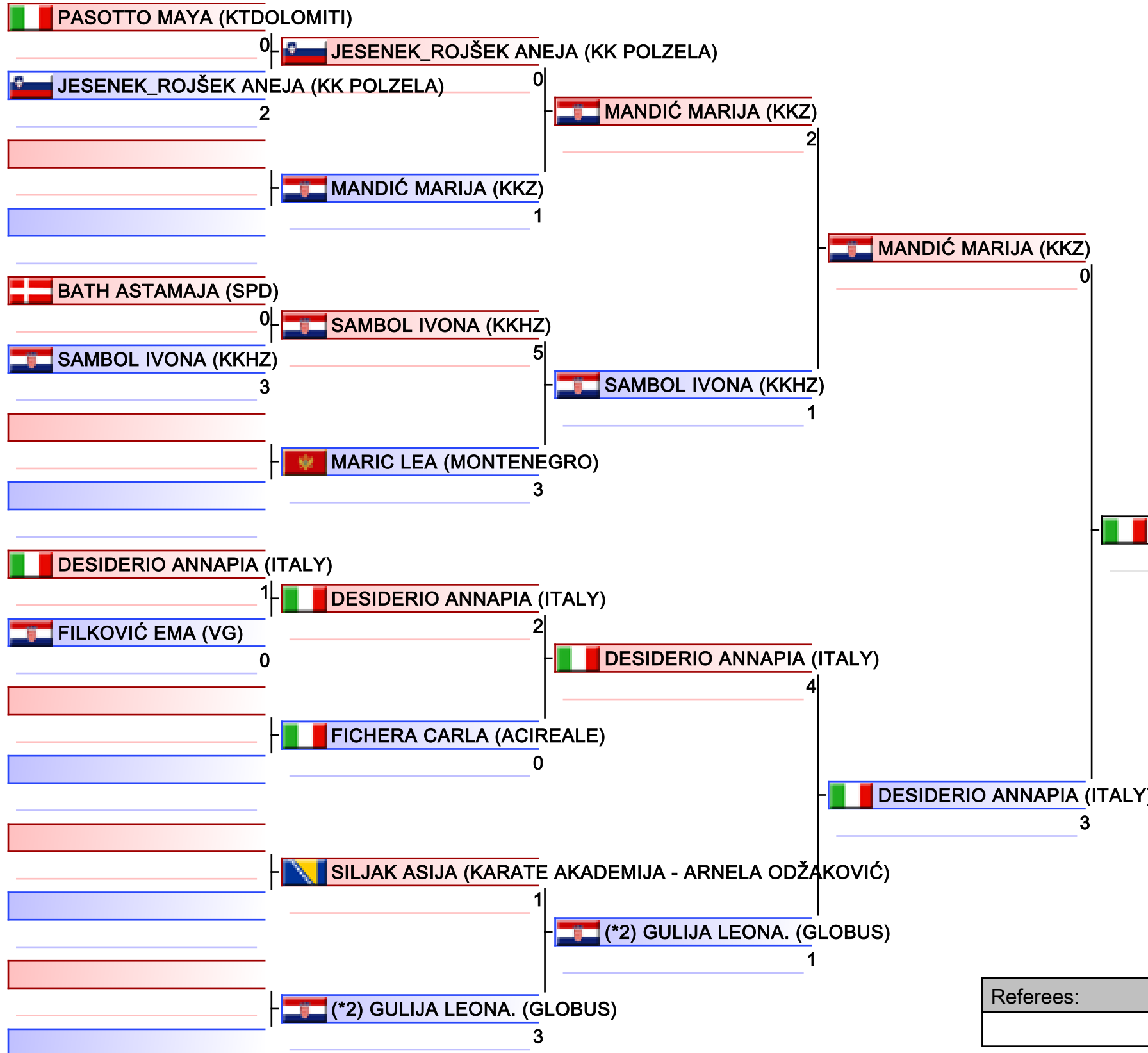

1. VÁCZY ANNA (SVK)
2. DESIDERIO ANNAPIA (ITALY)
3. CACKO MIA (KK 10.DAN)
3. MANDIĆ MARIJA (KKZ)
5. DALLE_FUSINE MARIA_CARLOTTA (A.S.D CEN...
5. GULIJA LEONA. (GLOBUS)
7. SIPOVIC AJLA (IPPON SARAJEVO)
7. FILKOVIĆ EMA (VG)

*Seeded

Referees:			

Kumite female Juniors -66kg

31ST KARATE GRAND PRIX CROATIA, CITY SPORTS HALL SAMOBOR, ANDRIJE HEBRANGA 26A, SAMOBOR, CROATIA, CRO

2023-01-21

Tatami
6 13:20

Pool
2/2

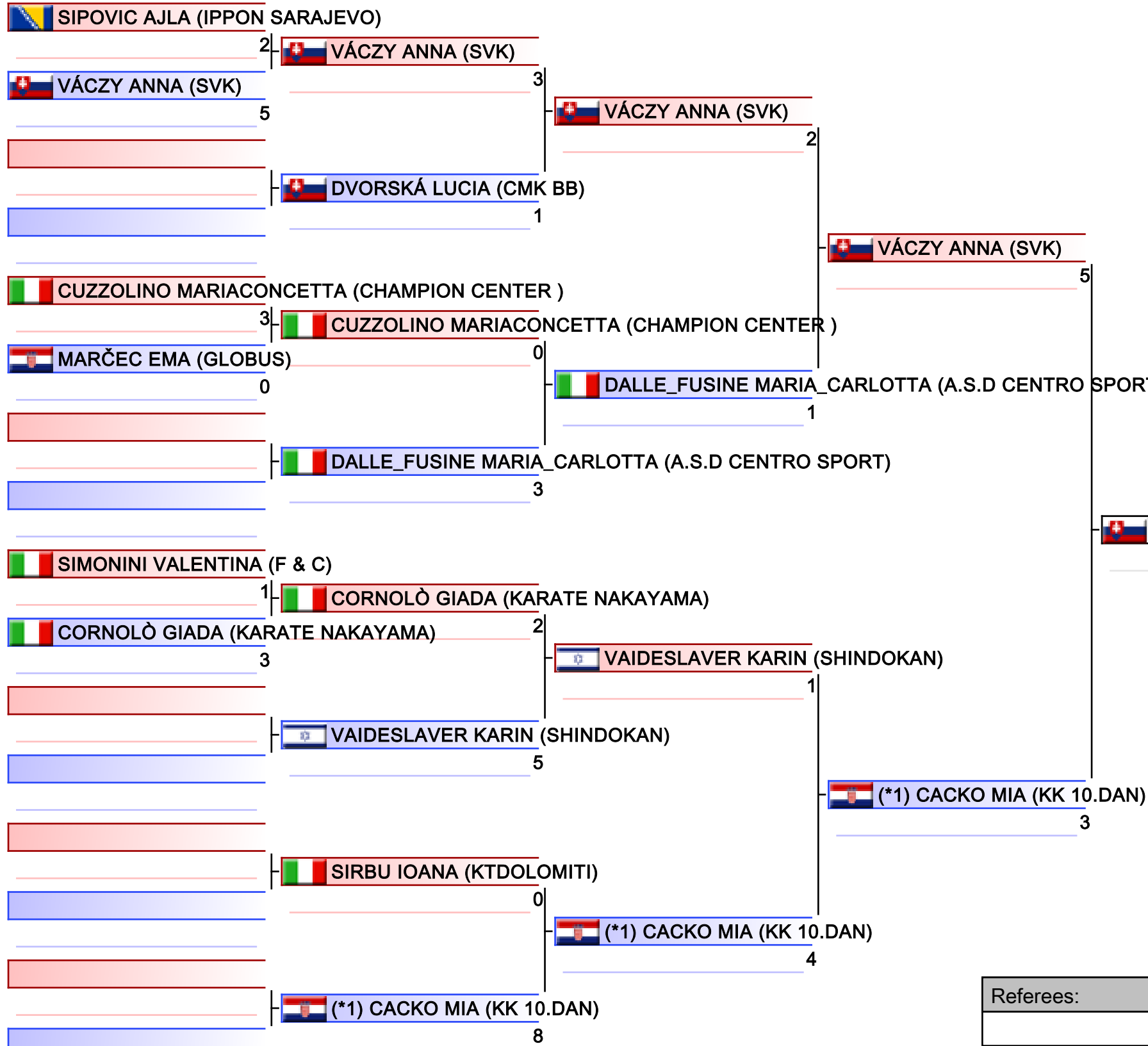

1. VÁCZY ANNA (SVK)
2. DESIDERIO ANNAPIA (ITALY)
3. CACKO MIA (KK 10.DAN)
3. MANDIĆ MARIJA (KKZ)
5. DALLE_FUSINE MARIA_CARLOTTA (A.S.D CENTRO SPORT)
5. GULIJA LEONA. (GLOBUS)
7. SIPOVIC AJLA (IPPON SARAJEVO)
7. FILKOVIĆ EMA (VG)

*Seeded

Referees:			

Kumite female cadets -47kg

31ST KARATE GRAND PRIX CROATIA, CITY SPORTS HALL SAMOBOR, ANDRIJE HEBRANGA 26A, SAMOBOR, CROATIA, CRO

2023-01-22

Tatami
1 10:45

Pool
1/2

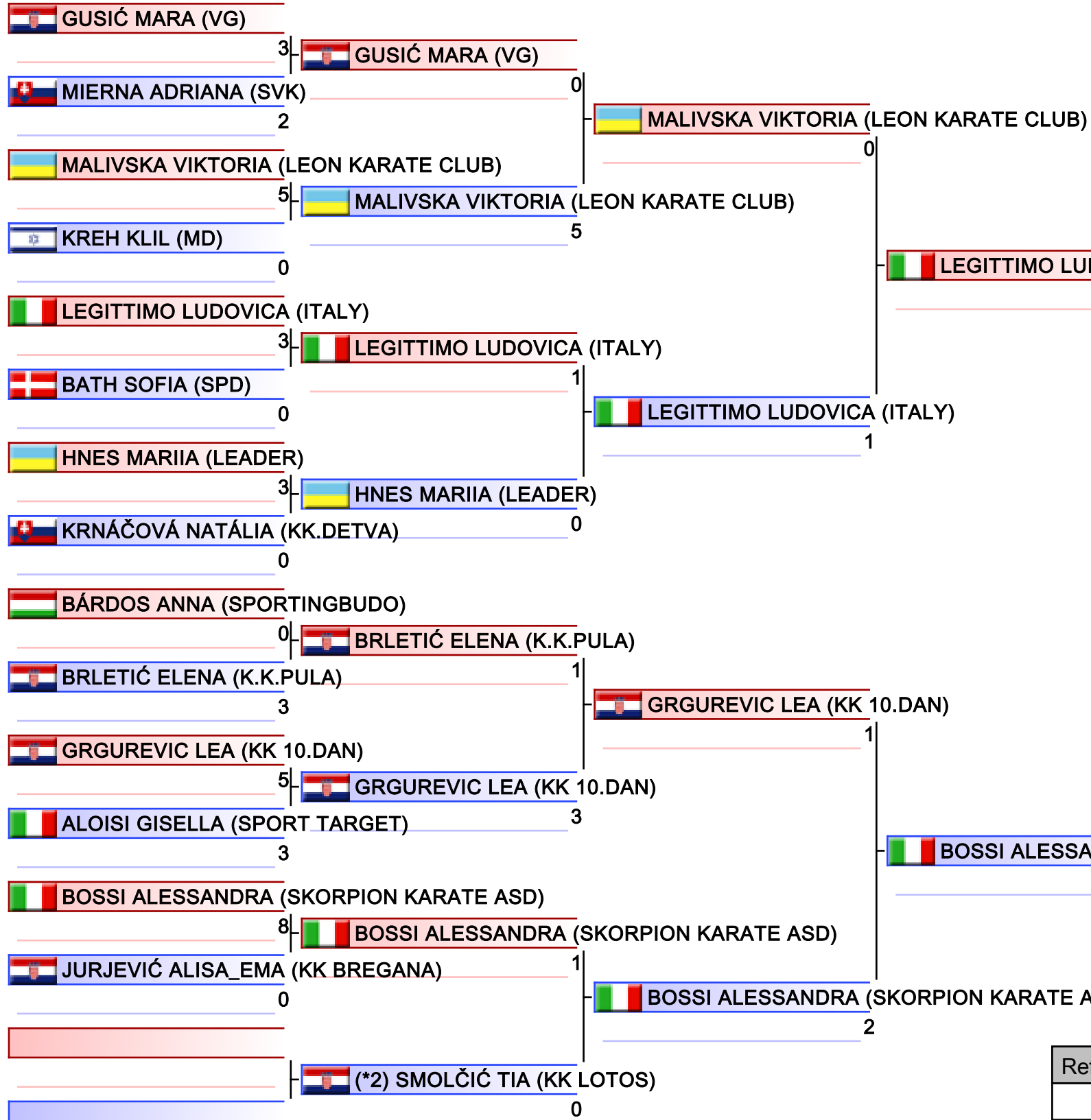

1. BOSSI ALESSANDRA (SKORPION KARATE ASD)
2. TRSTENJAK AIDA (GLOBUS)
3. OSTAPENKO ALISA (LEON KARATE CLUB)
3. LEGITTIMO LUDOVICA (ITALY)
5. JURISIC PATRICIJA (KK KUMITE JAJCE)
5. GRGUREVIC LEA (KK 10.DAN)
7. OSTOJIĆ TIJANA (KKS BORAC - ČAČAK)
7. JURJEVIĆ ALISA_EMA (KK BREGANA)

*Seeded

Referees:			

Kumite female cadets -47kg

31ST KARATE GRAND PRIX CROATIA, CITY SPORTS HALL SAMOBOR, ANDRIJE HEBRANGA 26A, SAMOBOR, CROATIA, CRO

2023-01-22

Tatami
2 11:00

Pool
2/2

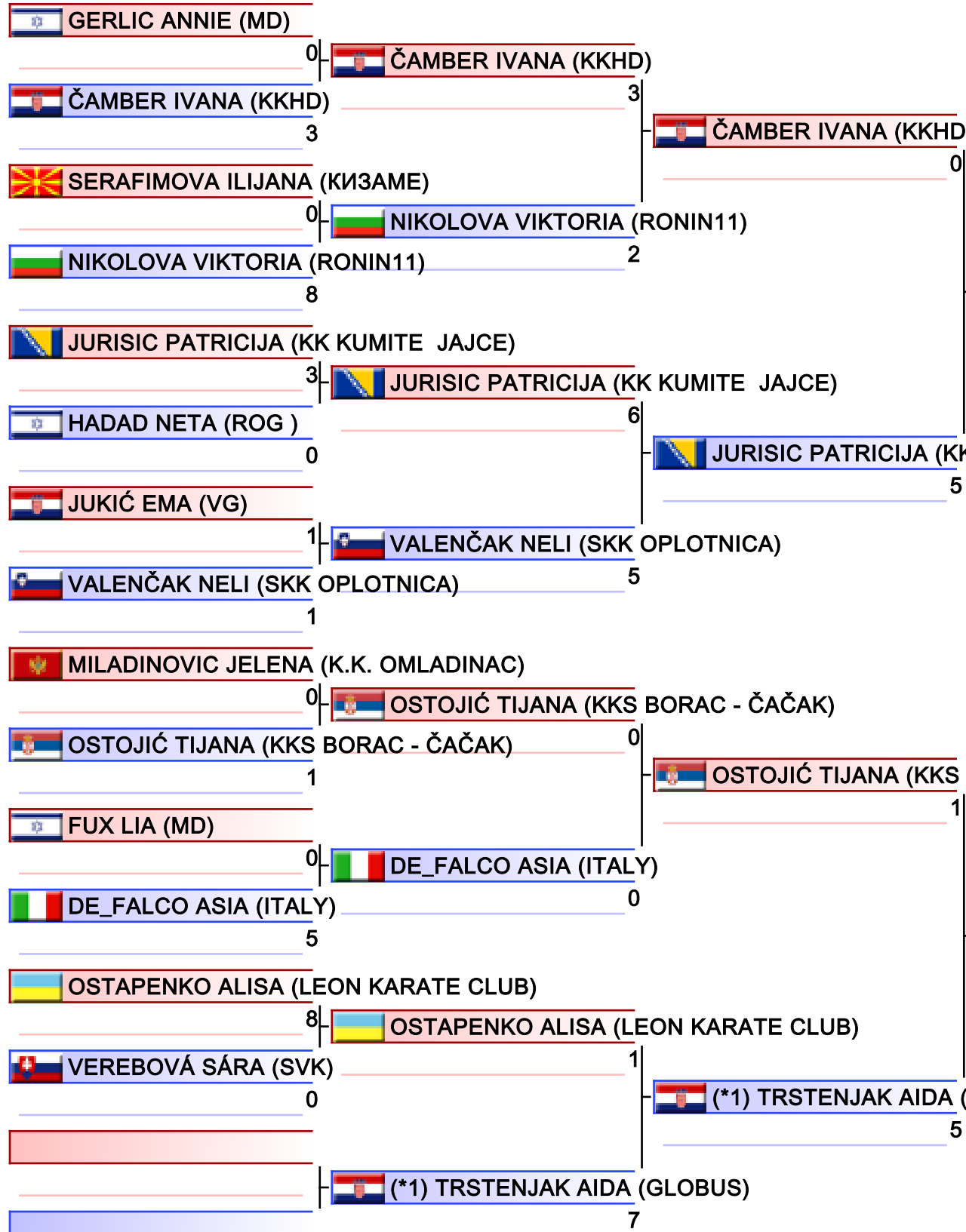

1. BOSSI ALESSANDRA (SKORPION KARATE ASD)
2. TRSTENJAK AIDA (GLOBUS)
3. OSTAPENKO ALISA (LEON KARATE CLUB)
3. LEGITTIMO LUDOVICA (ITALY)
5. JURISIC PATRICIJA (KK KUMITE JAJCE)
5. GRGUREVIC LEA (KK 10.DAN)
7. OSTOJIĆ TIJANA (KKS BORAC - ČAČAK)
7. JURJEVIĆ ALISA_EMA (KK BREGANA)

*Seeded

Referees:			

Kumite female cadets -54kg

31ST KARATE GRAND PRIX CROATIA, CITY SPORTS HALL SAMOBOR, ANDRIJE HEBRANGA 26A, SAMOBOR, CROATIA, CRO

2023-01-22

Tatami
3 11:40

Pool
1/2

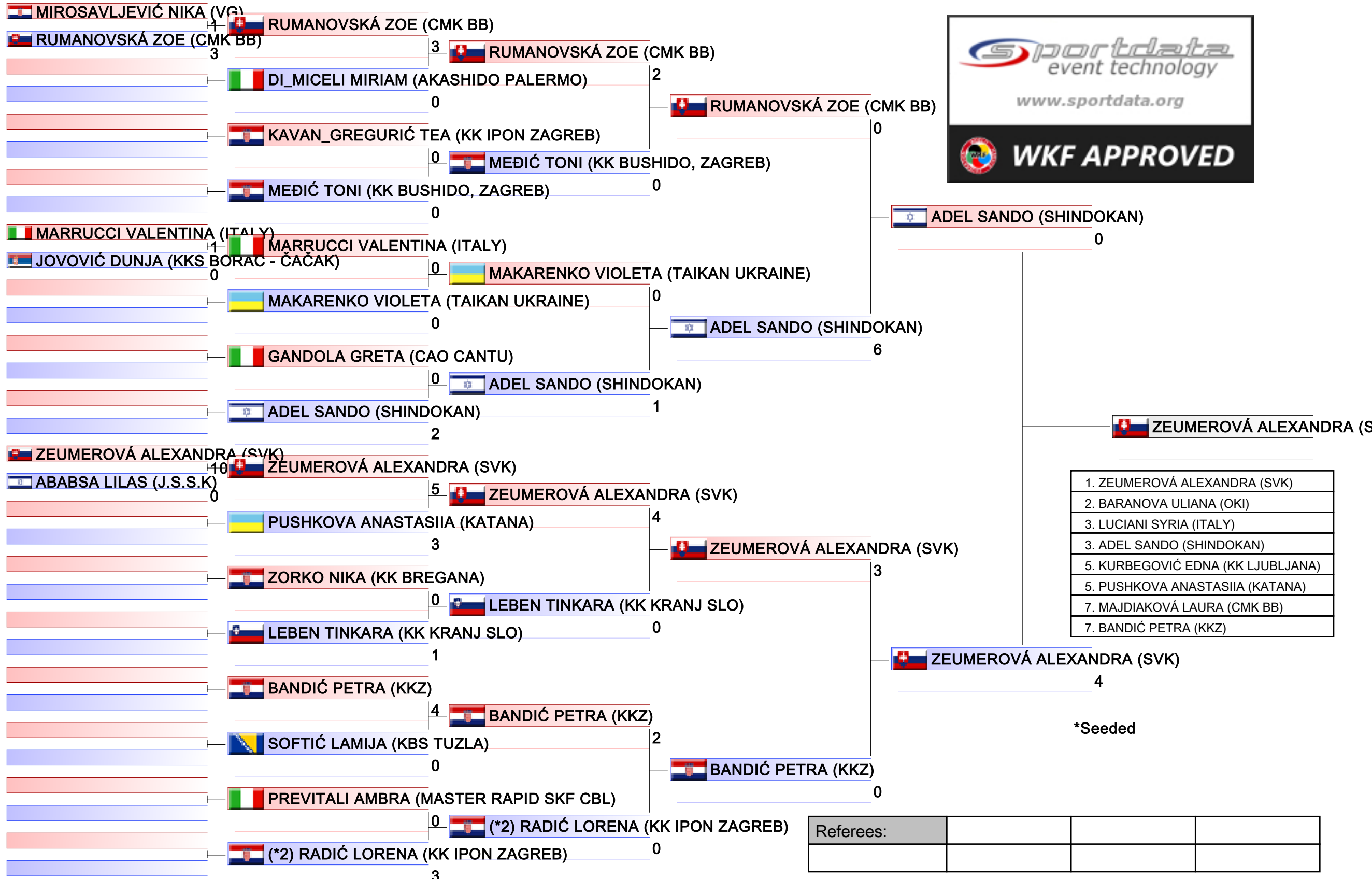

Kumite female cadets -54kg

31ST KARATE GRAND PRIX CROATIA, CITY SPORTS HALL SAMOBOR, ANDRIJE HEBRANGA 26A, SAMOBOR, CROATIA, CRO

2023-01-22

Tatami
4 11:20

Pool
2/2

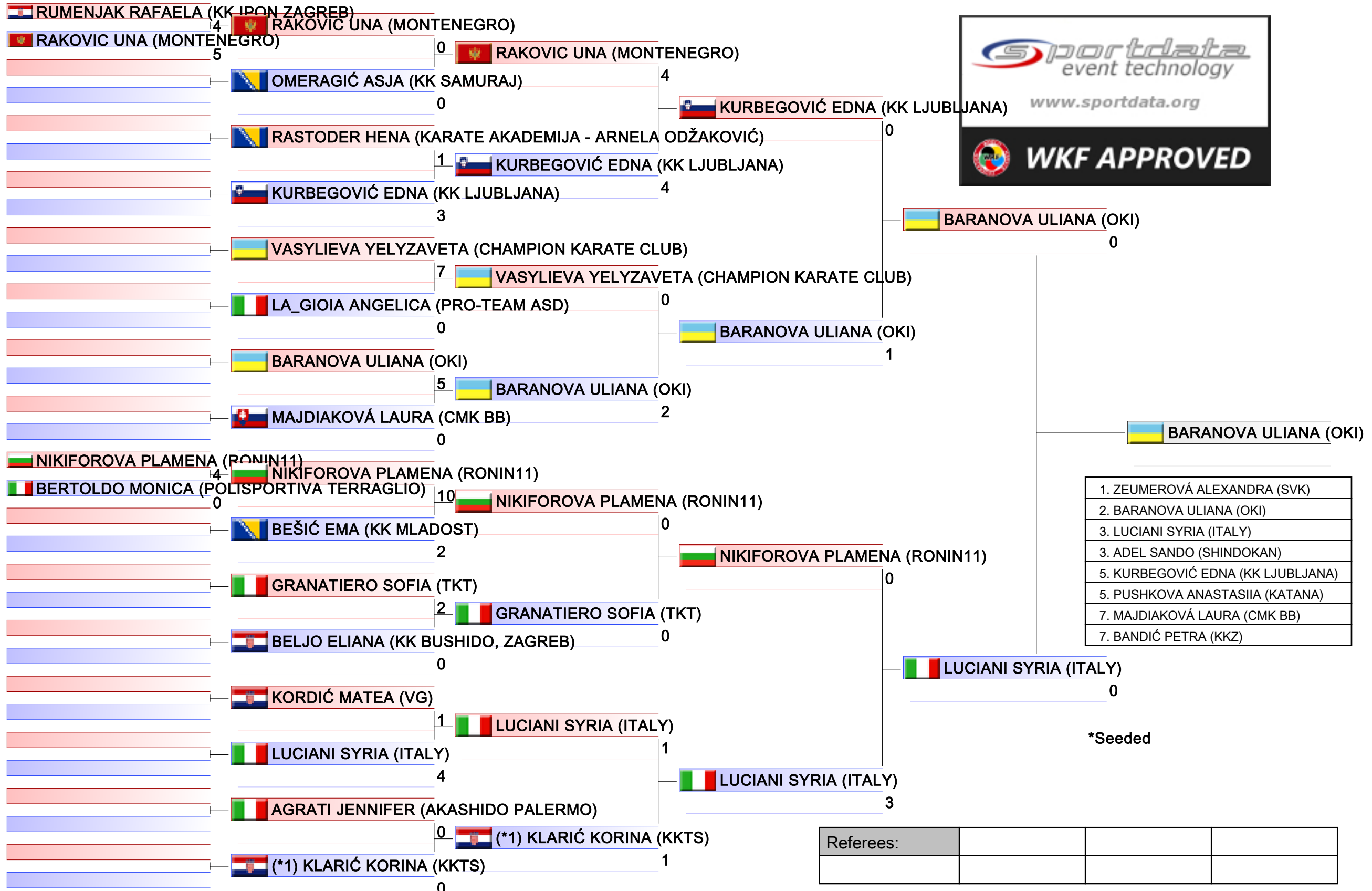

Kumite female juniors -48kg

31ST KARATE GRAND PRIX CROATIA, CITY SPORTS HALL SAMOBOR, ANDRIJE HEBRANGA 26A, SAMOBOR, CROATIA, CRO

2023-01-21

Tatami
5 14:45

Pool
1/2

 MUJANOVIĆ IRNA (KBS TUZLA)

4  MUJANOVIĆ IRNA (KBS TUZLA)

 ANDREOTTOLA LAURA (SHIZOKU KRT AV)

1 2  ANDREOTTOLA LAURA (SHIZOKU KRT AV)

 BOSSI ALESSANDRA (SKORPION KARATE ASD)

0  BOSSI ALESSANDRA (SKORPION KARATE ASD)

 BOSSI ALESSANDRA (SKORPION KARATE ASD)

7  BOSSI ALESSANDRA (SKORPION KARATE ASD)

 BACKOVIC HELENA (MONTENEGRO)

4  BACKOVIC HELENA (MONTENEGRO)

 BACKOVIC HELENA (MONTENEGRO)

2  BACKOVIC HELENA (MONTENEGRO)

 DAMATO ALICE (12RM1604)

1  DAMATO ALICE (12RM1604)

 MASOCH MARIACHIARA (KTDOLOMITI)

1  MASOCH MARIACHIARA (KTDOLOMITI)

 PETRESKA MARTINA (ЧОЛЕ - ОХРИД)

6  PETRESKA MARTINA (ЧОЛЕ - ОХРИД)

 PETRESKA MARTINA (ЧОЛЕ - ОХРИД)

2  PETRESKA MARTINA (ЧОЛЕ - ОХРИД)

 PETRESKA MARTINA (ЧОЛЕ - ОХРИД)

0  PETRESKA MARTINA (ЧОЛЕ - ОХРИД)

 GÁSPÁR LAURA (MTK)

3  GÁSPÁR LAURA (MTK)

 (*2) BERIŠA TONKA (KK JADRAN)

3  (*2) BERIŠA TONKA (KK JADRAN)

 (*2) BERIŠA TONKA (KK JADRAN)

4  (*2) BERIŠA TONKA (KK JADRAN)



 BACKOVIC HELENA (MONTENEGRO)

1. BACKOVIC HELENA (MONTENEGRO)
2. KOCKAREVIC LANA (KK IPON ZAGREB)
3. VITALI VERONICA (F & C)
3. BOSSI ALESSANDRA (SKORPION KARATE ASD)
5. BATH SOFIA (SPD)
5. PETRESKA MARTINA (ЧОЛЕ - ОХРИД)
7. PERINA CAMILLA (MASTER RAPID SKF CBL)
7. DAMATO ALICE (12RM1604)

*Seeded

Referees:			

Kumite female juniors -48kg

31ST KARATE GRAND PRIX CROATIA, CITY SPORTS HALL SAMOBOR, ANDRIJE HEBRANGA 26A, SAMOBOR, CROATIA, CRO

2023-01-21

Tatami
6 14:40

Pool
2/2

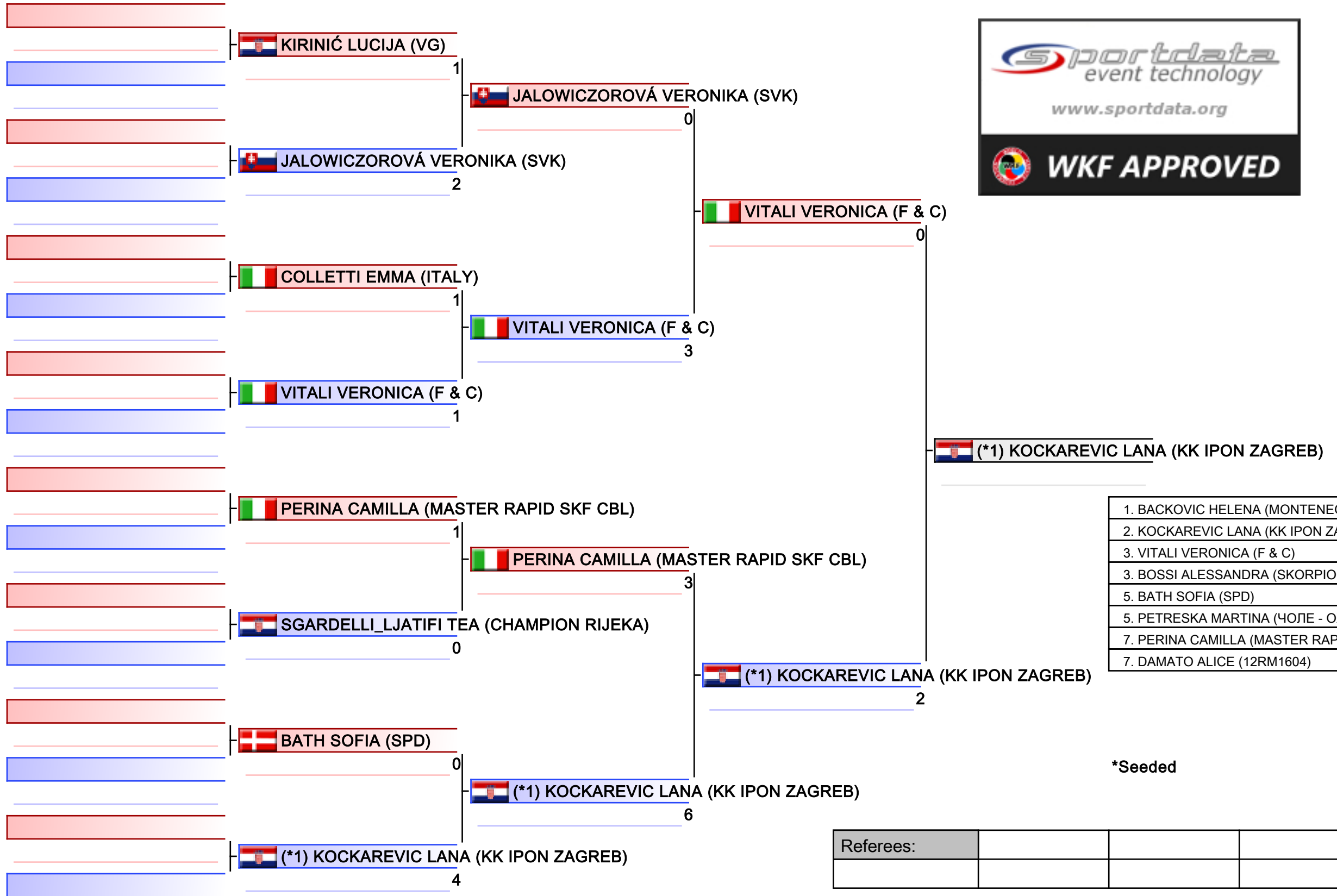

Kumite female juniors -53kg

31ST KARATE GRAND PRIX CROATIA, CITY SPORTS HALL SAMOBOR, ANDRIJE HEBRANGA 26A, SAMOBOR, CROATIA, CRO

2023-01-21

Tatami
1 13:25

Pool
1/2

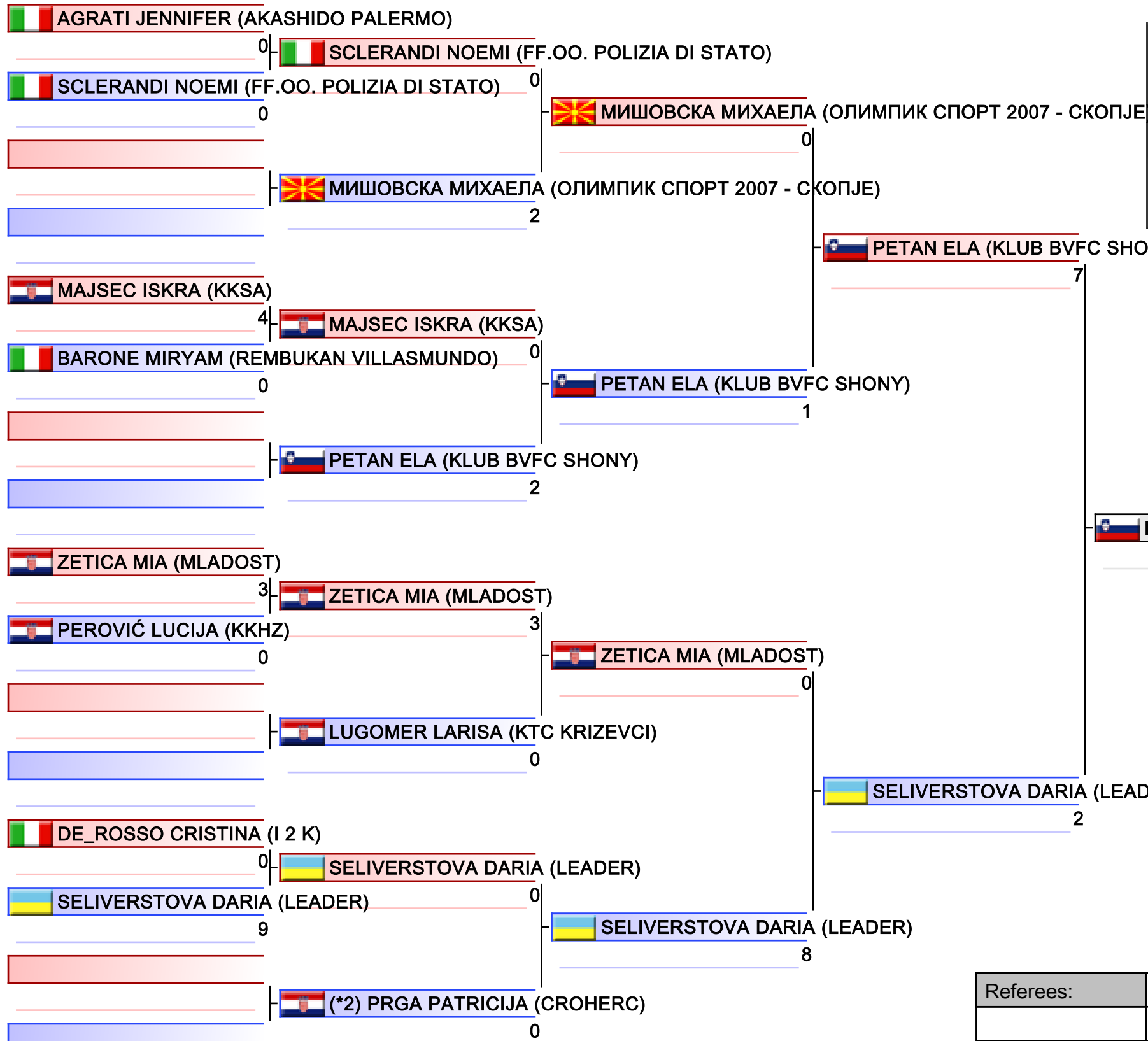

- | |
|---|
| 1. PETAN ELA (KLUB BVFC SHONY) |
| 2. TSANEVA TEODORA (KC TSANEV) |
| 3. MAJSEC ISKRA (KKSA) |
| 3. VAJDA MAGDALENA (KK IPON ZAGREB) |
| 5. SELIVERSTOVA DARIA (LEADER) |
| 5. KYRYCHENKO KATERYNA (SFC KYIV) |
| 7. МИШОВСКА МИХАЕЛА (ОЛИМПИК СПОРТ 2007 - СКОПЈЕ) |
| 7. BIFULCO ASIA (CHAMPION CENTER) |

*Seeded

Referees:			

Kumite female juniors -53kg

31ST KARATE GRAND PRIX CROATIA, CITY SPORTS HALL SAMOBOR, ANDRIJE HEBRANGA 26A, SAMOBOR, CROATIA, CRO

2023-01-21

Tatami
2 13:30

Pool
2/2

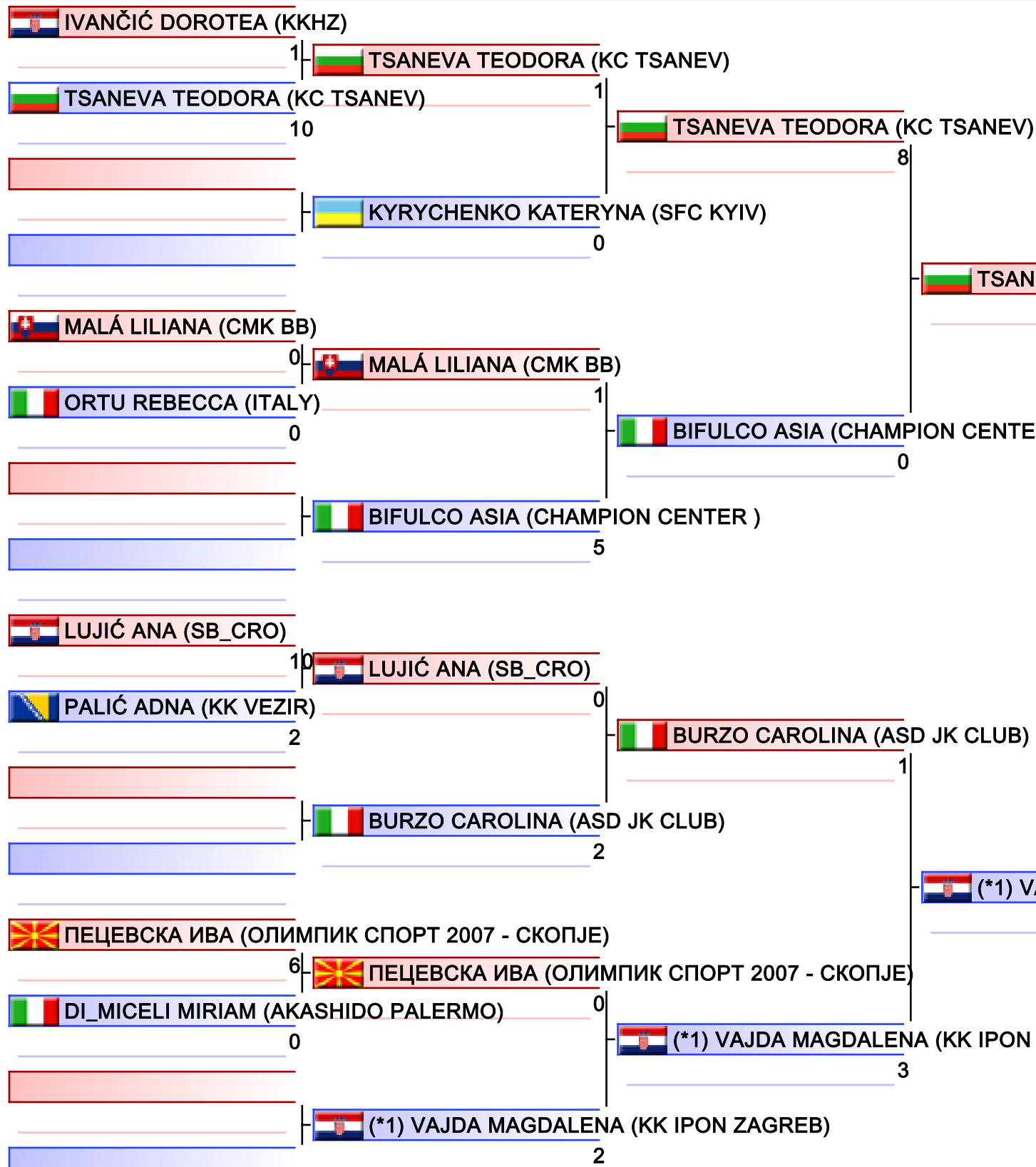

- | |
|---|
| 1. PETAN ELA (KLUB BVFC SHONY) |
| 2. TSANEVA TEODORA (KC TSANEV) |
| 3. MAJSEC ISKRA (KKSA) |
| 3. VAJDA MAGDALENA (KK IPON ZAGREB) |
| 5. SELIVERSTOVA DARIA (LEADER) |
| 5. KYRYCHENKO KATERYNA (SFC KYIV) |
| 7. МИШОВСКА МИХАЕЛА (ОЛИМПИК СПОРТ 2007 - СКОПЈЕ) |
| 7. BIFULCO ASIA (CHAMPION CENTER) |

*Seeded

Referees:			

Kumite female juniors -59kg

31ST KARATE GRAND PRIX CROATIA, CITY SPORTS HALL SAMOBOR, ANDRIJE HEBRANGA 26A, SAMOBOR, CROATIA, CRO

2023-01-21

Tatami
3 14:45

Pool
1/2

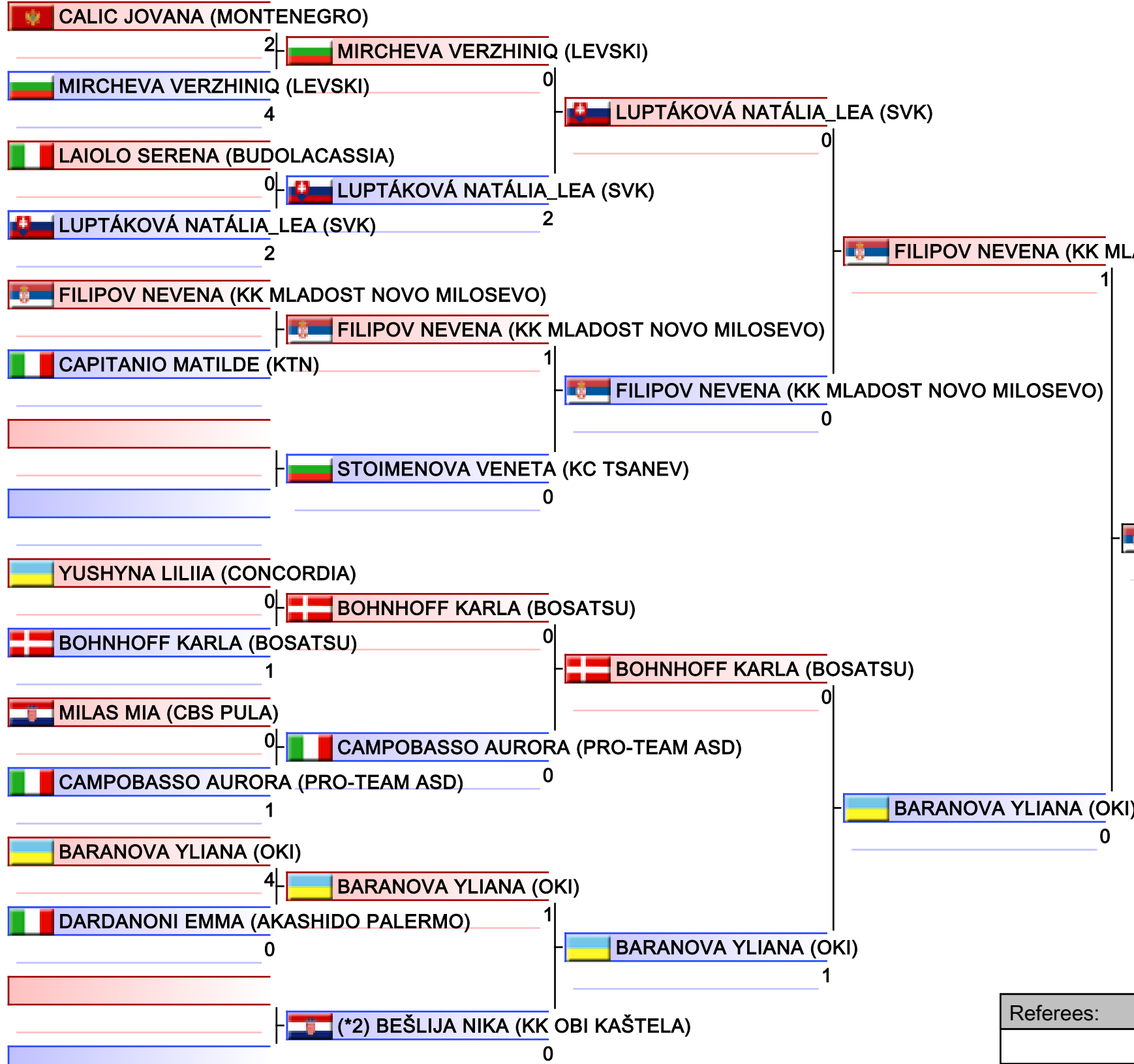

1. MICOVSKA JOVANA (MAKPETROL MKD)
2. FILIPOV NEVENA (KK MLADOST NOVO MILOSEVO)
3. ŠNAJDER DARJA (K.K. SOKOL)
3. BARANOVA YLIANA (OKI)
5. MARTURANO IRENE (ITALY)
5. STOIMENOVA VENETA (KC TSANEV)
7. KOCKAREVIĆ EMANUELA (KK MAX)
7. LUPTÁKOVÁ NATÁLIA_LEA (SVK)

*Seeded

Referees:			

Kumite female juniors -59kg

31ST KARATE GRAND PRIX CROATIA, CITY SPORTS HALL SAMOBOR, ANDRIJE HEBRANGA 26A, SAMOBOR, CROATIA, CRO

2023-01-21

Tatami 4 14:40

Pool 2/2

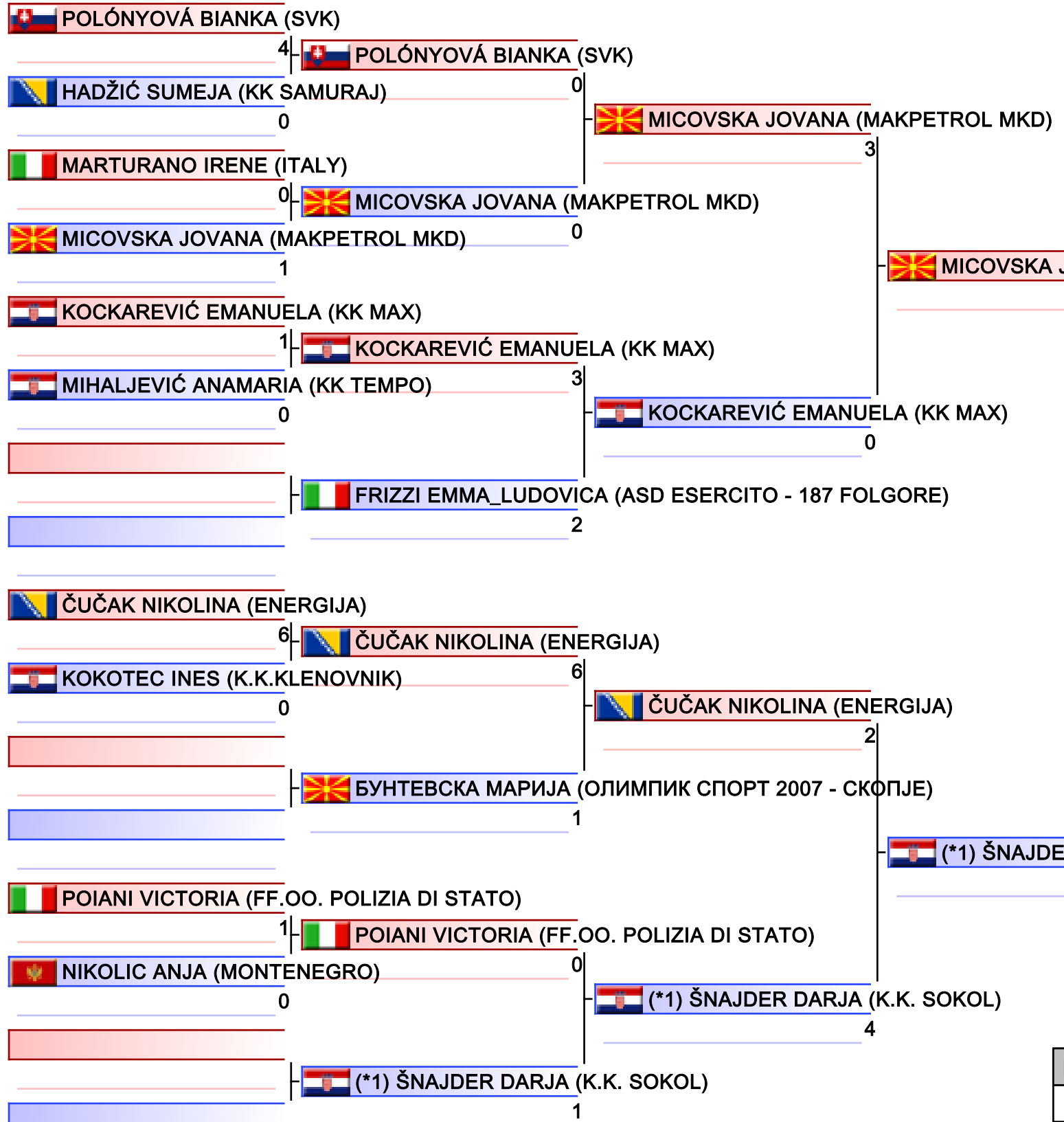

- | |
|---|
| 1. MICOVSKA JOVANA (MAKPETROL MKD) |
| 2. FILIPOV NEVENA (KK MLADOST NOVO MILOSEVCI) |
| 3. ŠNAJDER DARJA (K.K. SOKOL) |
| 3. BARANOVA YLIANA (OKI) |
| 5. MARTURANO IRENE (ITALY) |
| 5. STOIMENOVA VENETA (KC TSANEV) |
| 7. KOCKAREVIĆ EMANUELA (KK MAX) |
| 7. LUPTÁKOVÁ NATÁLIA_LEA (SVK) |

*Seeded

Referees:			

1	 KVESIĆ ANĐELO (KKHZ)	0	
2	 GARIBOVIĆ ENES (KK VARAŽDIN)	0	
3	 BUNJEVAC JAKOV (KAPTOL)	1	 BUNJEVAC JAKOV (KAPTOL)
4	 LJUBISA MARIC (KK ZANDARMERIJA)	0	
5	 KVESIĆ ANĐELO (KKHZ)	3	 KVESIĆ ANĐELO (KKHZ)
6	 BUNJEVAC JAKOV (KAPTOL)	1	
7	 LJUBISA MARIC (KK ZANDARMERIJA)	3	 LJUBISA MARIC (KK ZANDARMERIJA)
8	 GARIBOVIĆ ENES (KK VARAŽDIN)	3	
9	 KVESIĆ ANĐELO (KKHZ)	0	
10	 LJUBISA MARIC (KK ZANDARMERIJA)	0	
11	 GARIBOVIĆ ENES (KK VARAŽDIN)	2	 GARIBOVIĆ ENES (KK VARAŽDIN)
12	 BUNJEVAC JAKOV (KAPTOL)	0	



1. KVESIĆ ANĐELO (KKHZ)
2. GARIBOVIĆ ENES (KK VARAŽDIN)
3. LJUBISA MARIC (KK ZANDARMERIJA)
4. BUNJEVAC JAKOV (KAPTOL)

Referees:			

Kumite male cadets +70kg

31ST KARATE GRAND PRIX CROATIA, CITY SPORTS HALL SAMOBOR, ANDRIJE HEBRANGA 26A, SAMOBOR, CROATIA, CRO

2023-01-22

Tatami
2 13:40

Pool
2/2

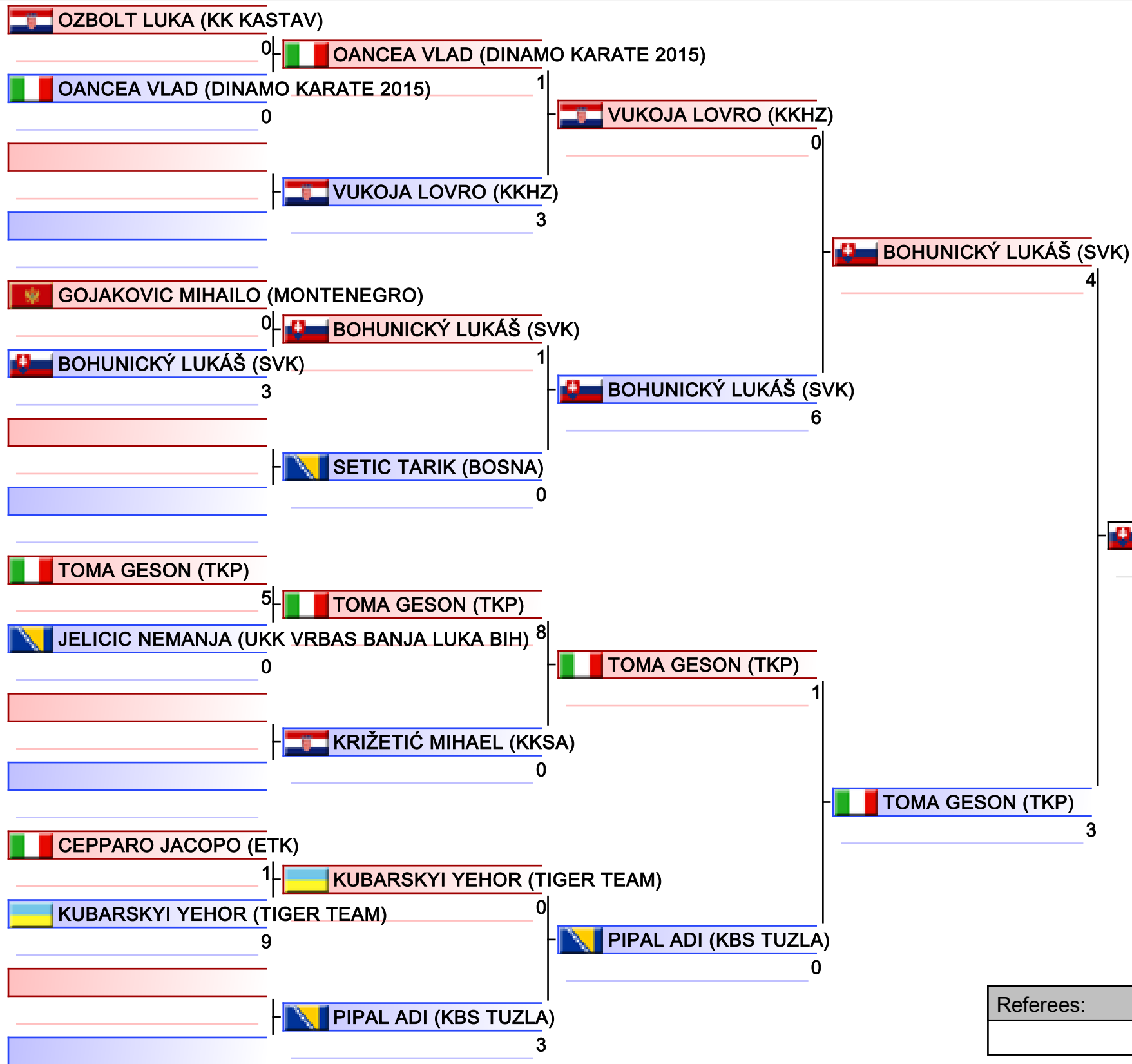

1. BOHUNICKÝ LUKÁŠ (SVK)
2. VRANKOVIĆ MARIO (CHAMPION RIJEKA)
3. BURROSI SAMUELE (ITALY)
3. GOJAKOVIC MIHAILO (MONTENEGRO)
5. NONIS MATTEO (ETK)
5. TOMA GESON (TKP)
7. GIBANICA ERMIN (KK ZANSHIN)
7. VUKOJA LOVRO (KKHZ)

Referees:			

Kumite male cadets -52kg

31ST KARATE GRAND PRIX CROATIA, CITY SPORTS HALL SAMOBOR, ANDRIJE HEBRANGA 26A, SAMOBOR, CROATIA, CRO

2023-01-22

Tatami
6 12:50

Pool
2/2

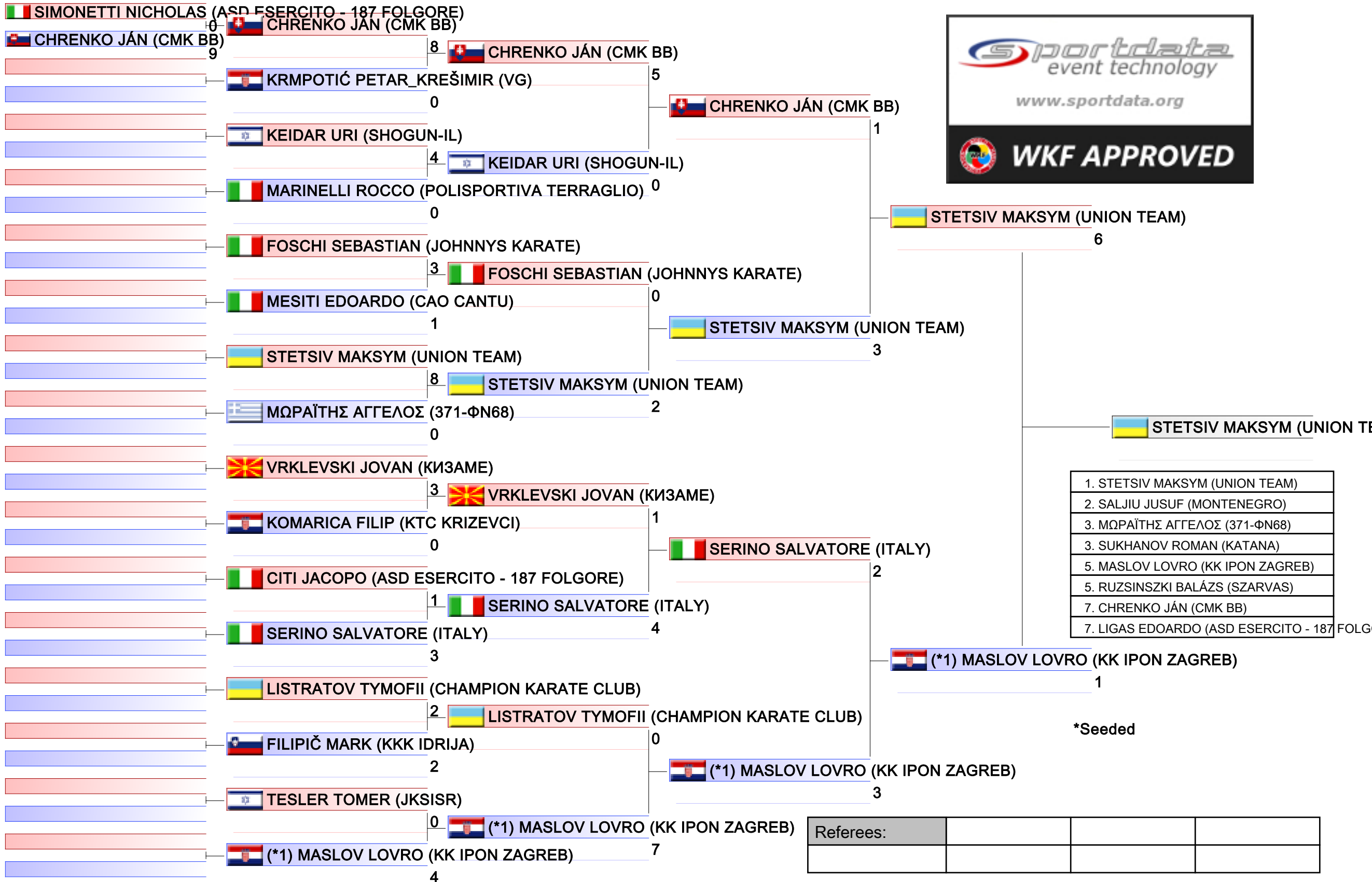

Kumite male cadets -57kg

31ST KARATE GRAND PRIX CROATIA, CITY SPORTS HALL SAMOBOR, ANDRIJE HEBRANGA 26A, SAMOBOR, CROATIA, CRO

2023-01-22

Tatami
4 14:30

Pool
2/2

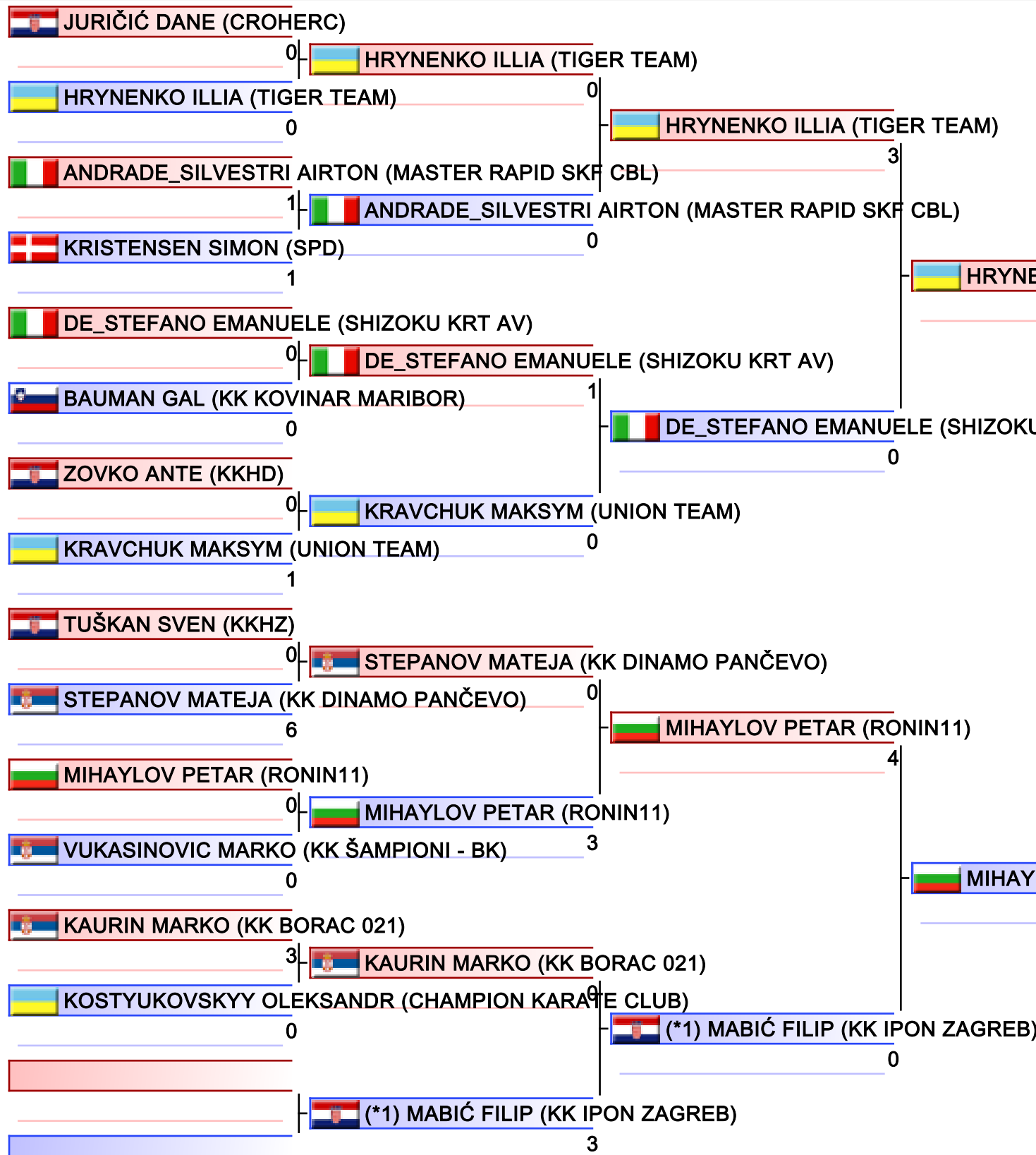

- | |
|---|
| 1. PRANNYCHUK NAZARII (LEADER) |
| 2. HRYNENKO ILLIA (TIGER TEAM) |
| 3. MIHAYLOV PETAR (RONIN11) |
| 3. STOJCHEVSKI ANDREJ (KI3AME) |
| 5. JURIČIĆ DANE (CROHERC) |
| 5. PERVAN ZELJKO (CROHERC) |
| 7. DE_STEFANO EMANUELE (SHIZOKU KRT AV) |
| 7. ŠOŠKIĆ FILIP (MONTENEGRO) |

*Seeded

Referees:			

Kumite male cadets -63kg

31ST KARATE GRAND PRIX CROATIA, CITY SPORTS HALL SAMOBOR, ANDRIJE HEBRANGA 26A, SAMOBOR, CROATIA, CRO

2023-01-22

Tatami 6 14:25

Pool 2/2

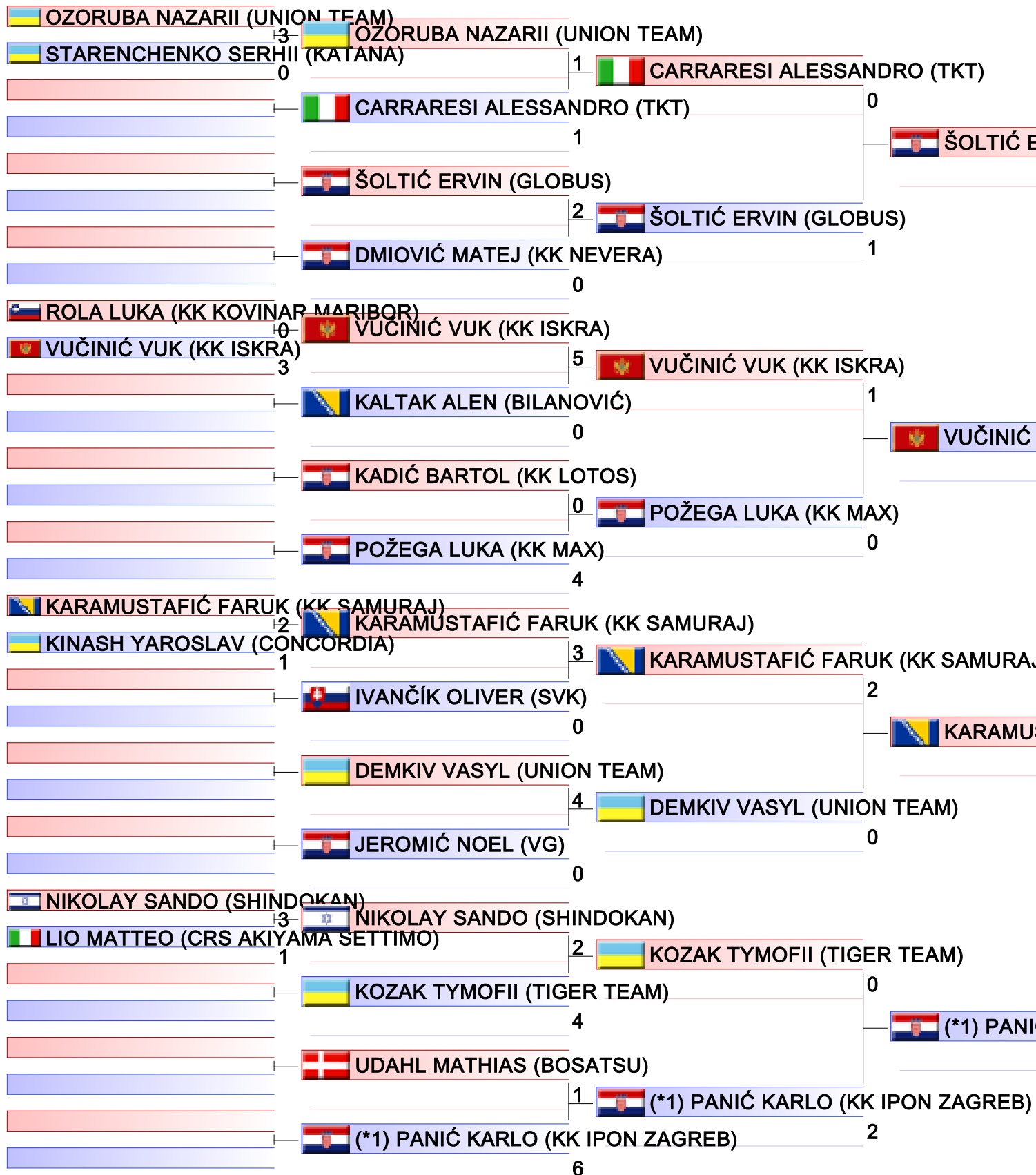

1. DJURICIC NENAD (MONTENEGRO)
2. VUČINIĆ VUK (KK ISKRA)
3. POŽEGA LUKA (KK MAX)
3. PANICO VALENTINO (ITALY)
5. KARAMUSTAFIĆ FARUK (KK SAMURAJ)
5. KOSHKIDKO EDUARD (TIGER TEAM)
7. ŠOLTIĆ ERVIN (GLOBUS)
7. SHYKHALI YUSIFOV (MOWGLY KC)

*Seeded

Referees:			

Kumite male cadets -70kg

31ST KARATE GRAND PRIX CROATIA, CITY SPORTS HALL SAMOBOR, ANDRIJE HEBRANGA 26A, SAMOBOR, CROATIA, CRO

2023-01-22

Tatami
4 13:05

Pool
2/2

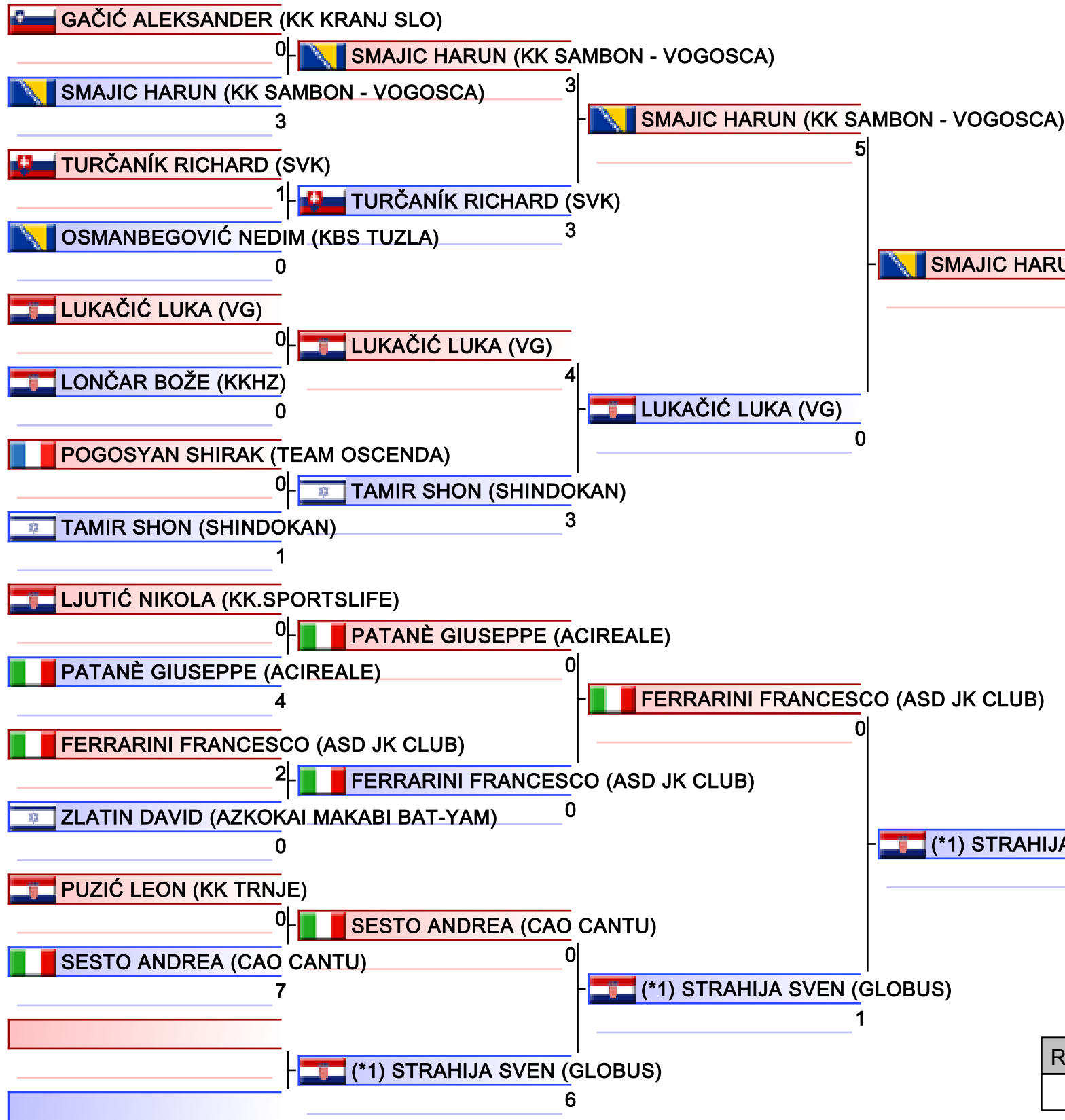

1. TONIOLO ALVISE (ITALY)
2. STRAHIJA SVEN (GLOBUS)
3. SMAJIC HARUN (KK SAMBON - VOGOSCA)
3. ARIFAJ ANES (MONTENEGRO)
5. SESTO ANDREA (CAO CANTU)
5. TENZHALA IVAN (ASC)
7. FERRARINI FRANCESCO (ASD JK CLUB)
7. MLAKAR LUKA (KKK IDRIJA)

*Seeded

Referees:			

Kumite male juniors +76kg

31ST KARATE GRAND PRIX CROATIA, CITY SPORTS HALL SAMOBOR, ANDRIJE HEBRANGA 26A, SAMOBOR, CROATIA, CRO

2023-01-21

Tatami
1 14:50

Pool
1/2

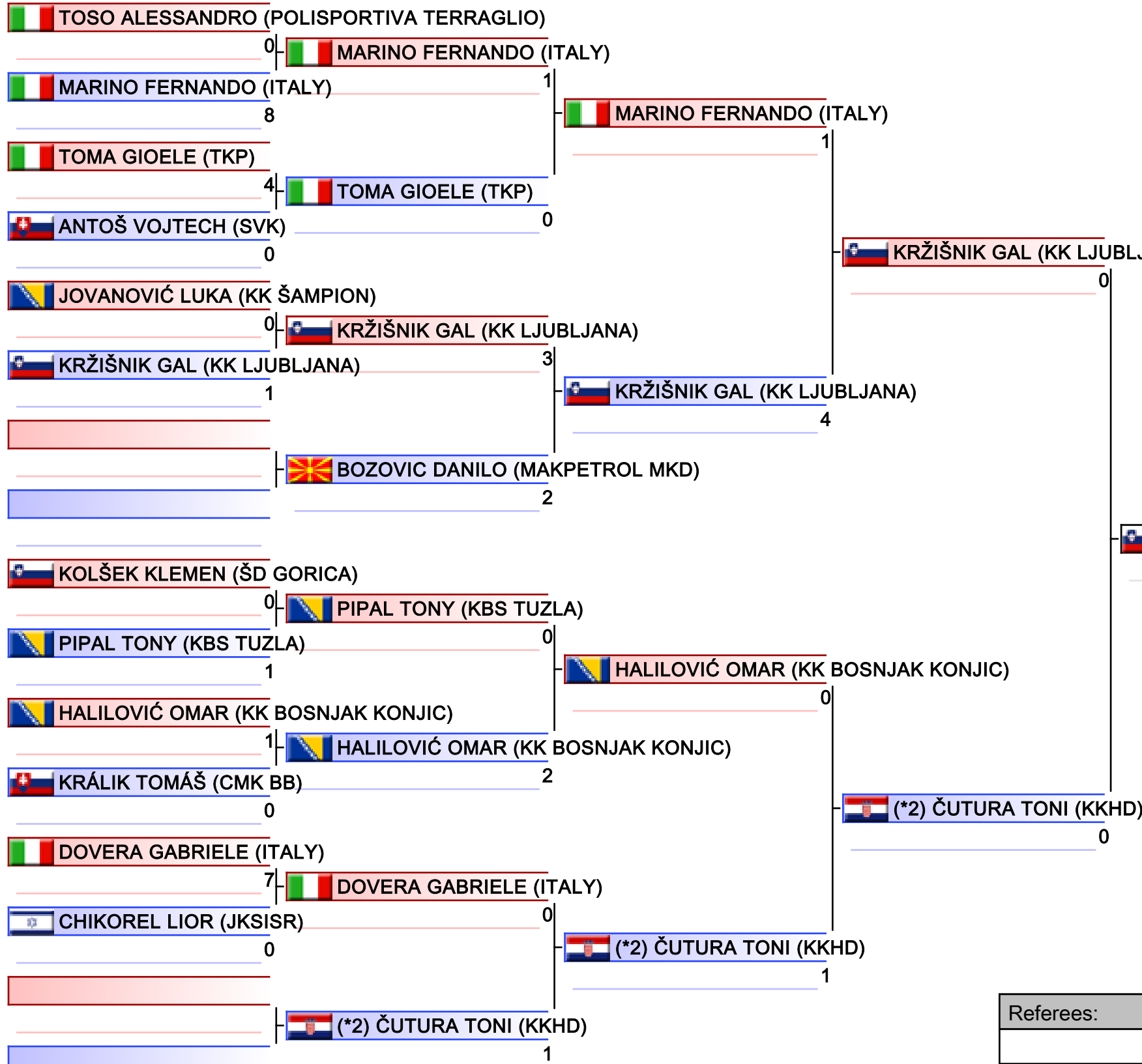

1. FAJERBACH MAX (KKHZ)
2. KRŽIŠNIK GAL (KK LJUBLJANA)
3. ΜΩΠΑΪΤΗΣ ΝΙΚΟΛΑΟΣ (371-ΦN68)
3. ČUTURA TONI (KKHD)
5. GONDI NIKOLA (VIROVITICA)
5. JOVANOVIĆ LUKA (KK ŠAMPION)
7. SUPINO FEDERICO (SSD BRACELLI CLUB)
7. MARINO FERNANDO (ITALY)

*Seeded

Referees:			

Kumite male juniors +76kg

31ST KARATE GRAND PRIX CROATIA, CITY SPORTS HALL SAMOBOR, ANDRIJE HEBRANGA 26A, SAMOBOR, CROATIA, CRO

2023-01-21

Tatami
2 14:50

Pool
2/2

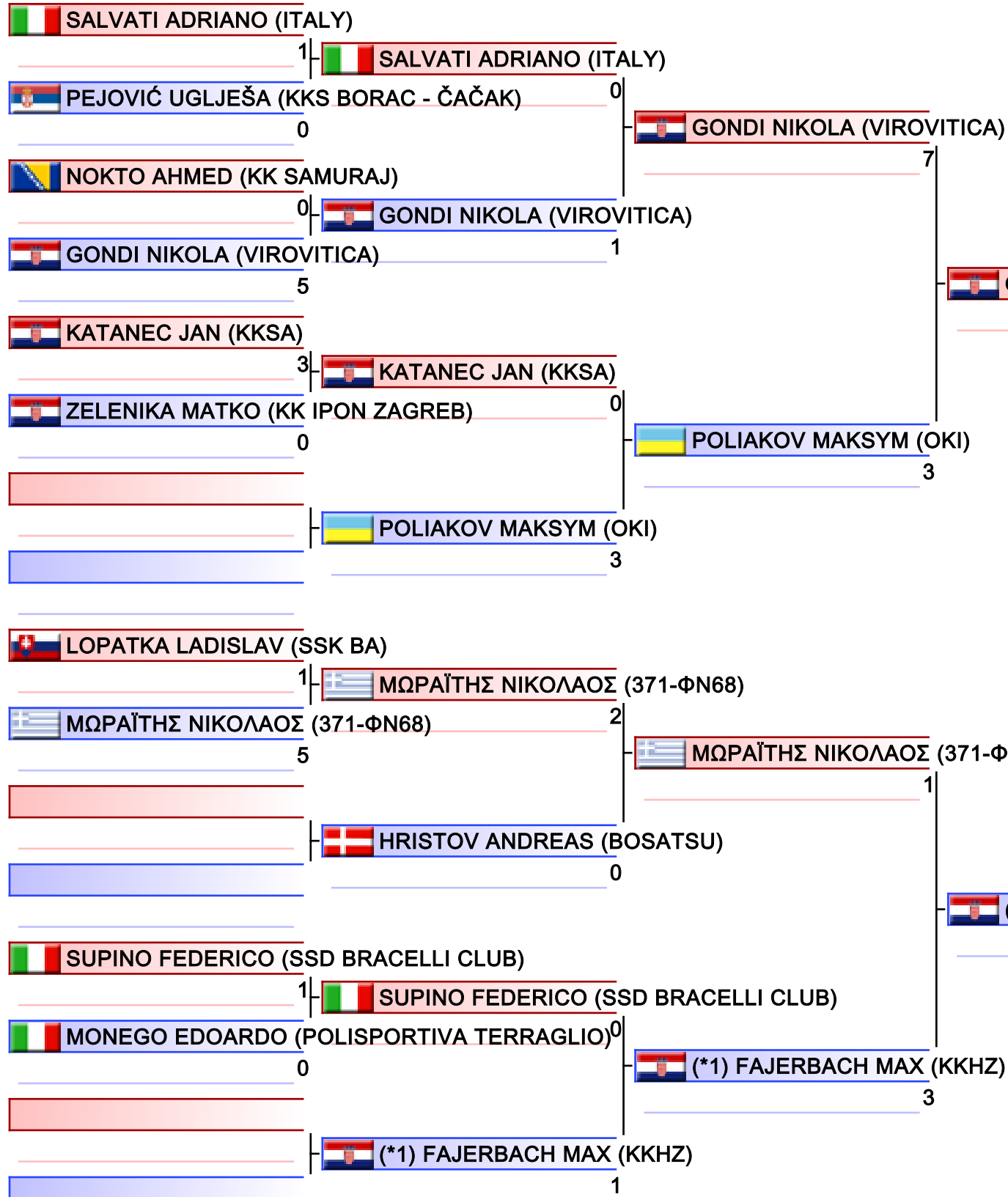

1. FAJERBACH MAX (KKHZ)
2. KRŽIŠNIK GAL (KK LJUBLJANA)
3. ΜΩΡΑΪΤΗΣ ΝΙΚΟΛΑΟΣ (371-ΦΝ68)
3. ČUTURA TONI (KKHD)
5. GONDI NIKOLA (VIROVITICA)
5. JOVANOVIĆ LUKA (KK ŠAMPION)
7. SUPINO FEDERICO (SSD BRACELLI CLUB)
7. MARINO FERNANDO (ITALY)

*Seeded

Referees:			

Kumite male juniors -55kg

31ST KARATE GRAND PRIX CROATIA, CITY SPORTS HALL SAMOBOR, ANDRIJE HEBRANGA 26A, SAMOBOR, CROATIA, CRO

2023-01-21



Tatami
3 16:05



Pool
1/2

 KADRIC FARUK (KARATE AKADEMIJA - ARNELA ODŽAKOVIĆ) 0 |  KADRIC FARUK (KARATE AKADEMIJA - ARNELA ODŽAKOVIĆ) 0

 SORCI FILIPPO (ASDK PDP) 0 |  GRINBERG DAVID (AZKOKAI MAKABI BAT-YAM) 2

 GRINBERG DAVID (AZKOKAI MAKABI BAT-YAM) 2 |  GRINBERG DAVID (AZKOKAI MAKABI BAT-YAM) 2

 POULSEN ALVIN (BOSATSU) 0 |  VOJINOVIC BALSJA (MONTENEGRO) 4

 PIEMONTE GABRIEL (KARATE NAKAYAMA) 0 |  VOJINOVIC BALSJA (MONTENEGRO) 0

 VOJINOVIC BALSJA (MONTENEGRO) 2 |  VOJINOVIC BALSJA (MONTENEGRO) 6

 VOJINOVIC BALSJA (MONTENEGRO) 2 |  VOJINOVIC BALSJA (MONTENEGRO) 6

 IVANOV VELIN (LEVSKI) 0

 VOJINOVIC BALSJA (MONTENEGRO) 4

 KOSTYUKOVSKYY OLEKSANDR (CHAMPION KARATE CLUB) 1 |  DOLNICKÝ ADAM (SVK) 0

 DOLNICKÝ ADAM (SVK) 2 |  DI_LEMME ALESSANDRO (KARATE TEAM ISERNIA) 0

 DI_LEMME ALESSANDRO (KARATE TEAM ISERNIA) 3

 DJURDJIC MARKO (KK BORAC 021) 3

 DJURDJIC MARKO (KK BORAC 021) 3 |  DJURDJIC MARKO (KK BORAC 021) 2

 KRISTENSEN SIMON (SPD) 0 |  DJURDJIC MARKO (KK BORAC 021) 8

 (*2) TOPLIČANEC NIKOLA (GLOBUS) 1



1. VOJINOVIC BALSJA (MONTENEGRO)
2. CAPMOALE ALEXANDR (BARS BALTI)
3. DJURDJIC MARKO (KK BORAC 021)
3. SQUILLANTE GIUDO (ITALY)
5. GRINBERG DAVID (AZKOKAI MAKABI BAT-YAM)
5. DRAŽENOVIĆ DAMIAN (KK IPON ZAGREB)
7. IVANOV VELIN (LEVSKI)
7. DE_STEFANO EMANUELE (SHIZOKU KRT AV)

*Seeded

Referees:			

Kumite male juniors -55kg

31ST KARATE GRAND PRIX CROATIA, CITY SPORTS HALL SAMOBOR, ANDRIJE HEBRANGA 26A, SAMOBOR, CROATIA, CRO

2023-01-21

Tatami
4 16:05

Pool
2/2

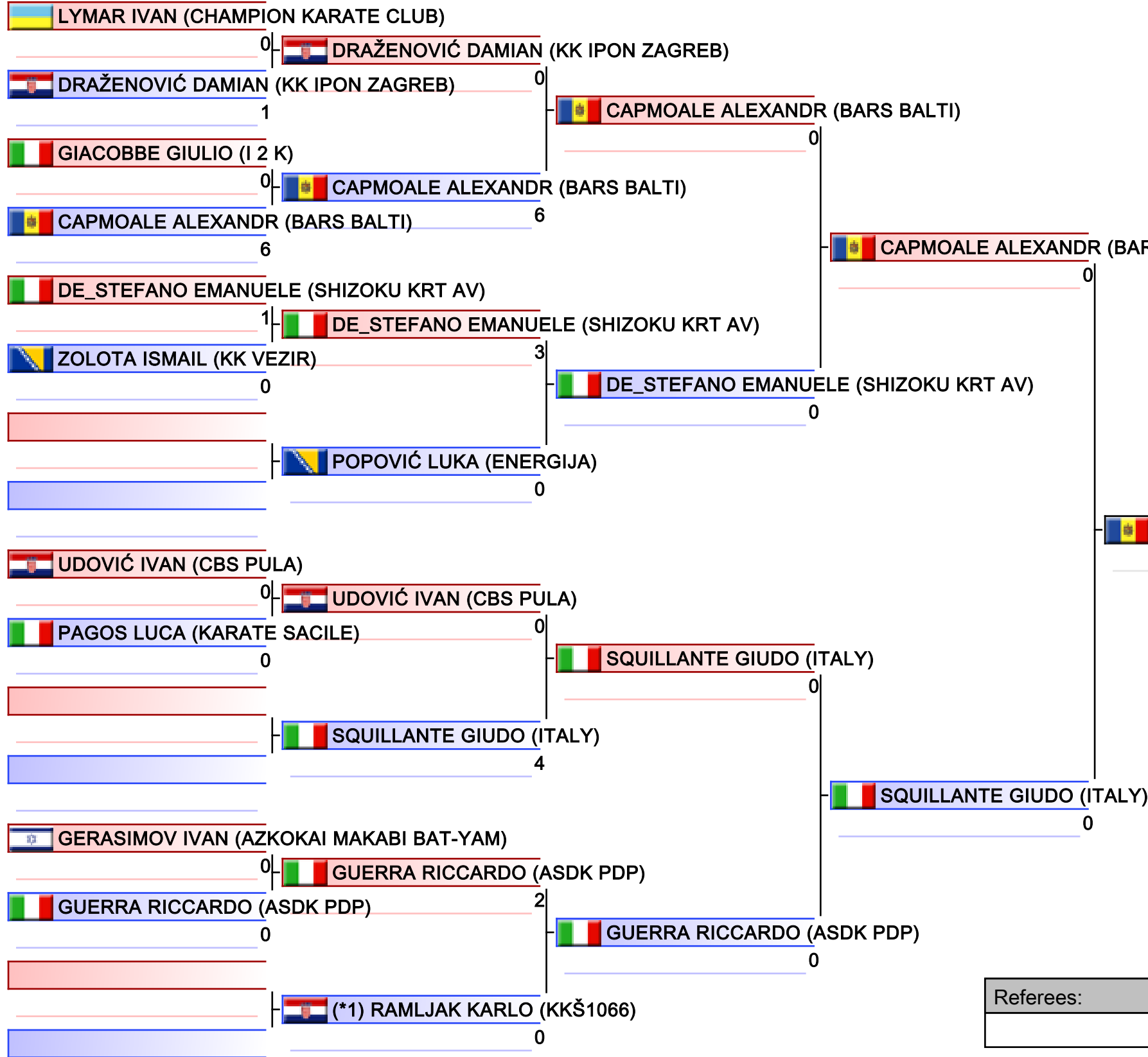

- | |
|--|
| 1. VOJINOVIC Balsa (MONTENEGRO) |
| 2. CAPMOALE ALEXANDR (BARS BALTI) |
| 3. DJURDJIC MARKO (KK BORAC 021) |
| 3. SQUILLANTE GIUDO (ITALY) |
| 5. GRINBERG DAVID (AZKOKAI MAKABI BAT-YAM) |
| 5. DRAŽENVIĆ DAMIAN (KK IPON ZAGREB) |
| 7. IVANOV VELIN (LEVSKI) |
| 7. DE_STEFANO EMANUELE (SHIZOKU KRT AV) |

*Seeded

Referees:			

Kumite male juniors -61kg

31ST KARATE GRAND PRIX CROATIA, CITY SPORTS HALL SAMOBOR, ANDRIJE HEBRANGA 26A, SAMOBOR, CROATIA, CRO

2023-01-21

Tatami
5 15:40

Pool
1/2

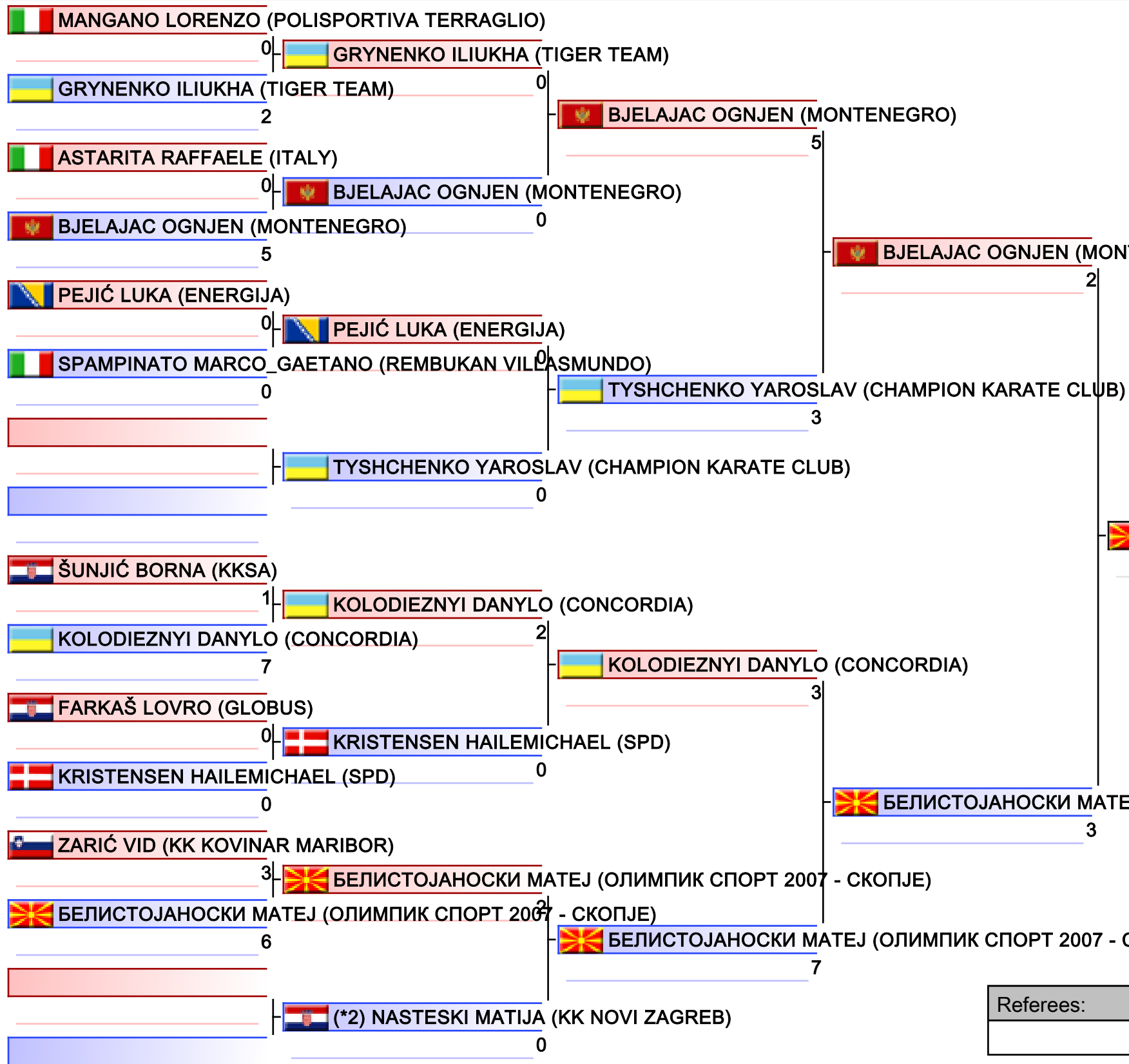

- | |
|--|
| 1. БЕЛИСТОЈАНОСКИ МАТЕЈ (ОЛИМПИЈСКИ СПОРТ 2007 - СКОПЈЕ) |
| 2. PANCHUK ARTEM (TIGER TEAM) |
| 3. NASTESKI MATIJA (KK NOVI ZAGREB) |
| 3. BUKOVIĆ NORBERT (SVK) |
| 5. BJELAJAC OGNJEN (MONTENEGRO) |
| 5. RUFINI SAMUELE (TKP) |
| 7. KOLODIEZNYI DANYLO (CONCORDIA) |
| 7. GIORDANO FABRIZIO (ITALY) |

*Seeded

Referees:			

Kumite male juniors -61kg

31ST KARATE GRAND PRIX CROATIA, CITY SPORTS HALL SAMOBOR, ANDRIJE HEBRANGA 26A, SAMOBOR, CROATIA, CRO

2023-01-21

Tatami 6 15:40

Pool 2/2

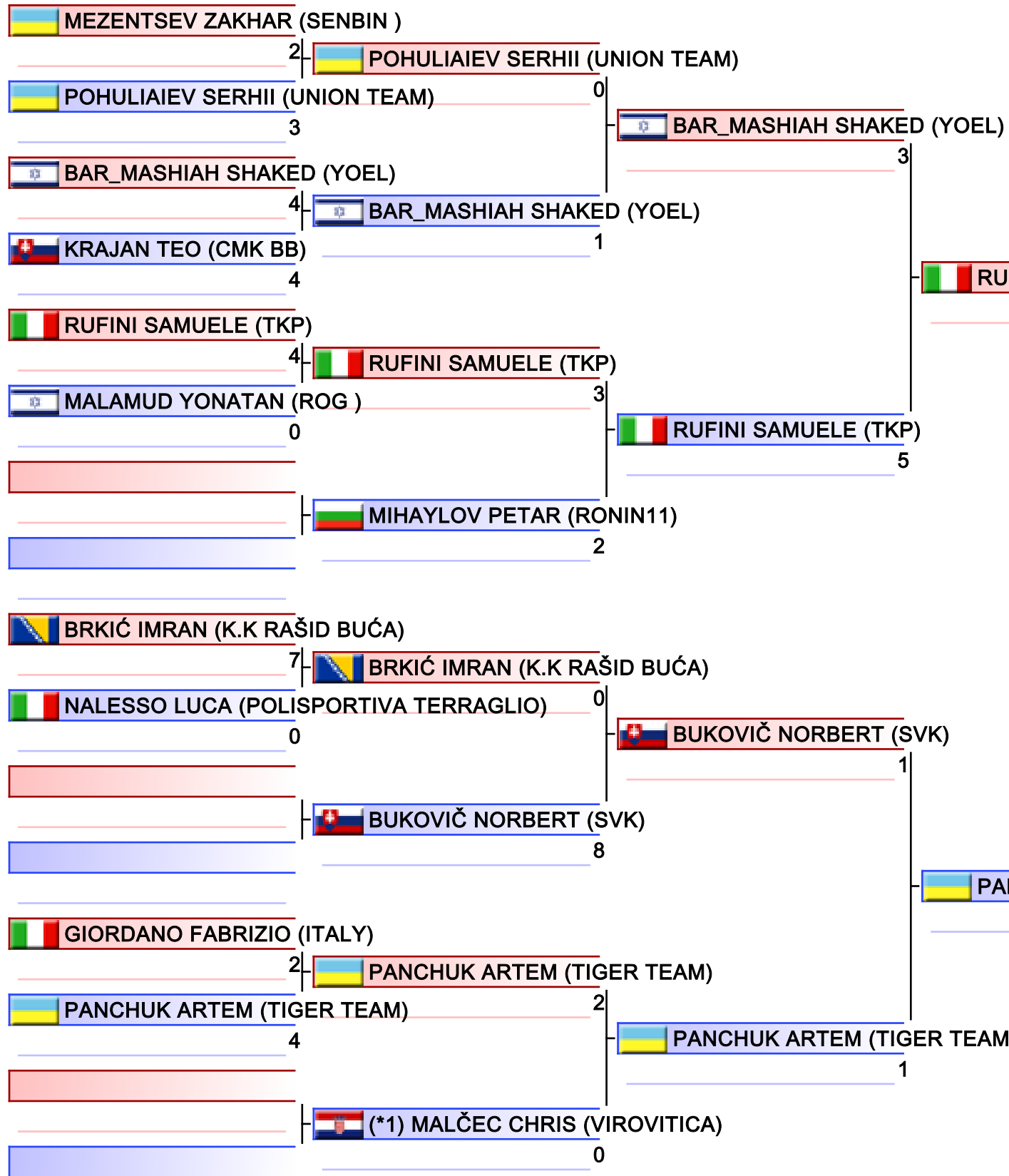

1. БЕЛИСТОЈАНОСКИ МАТЕЈ (ОЛИМПИКС СПОРТ)
2. PANCHUK ARTEM (TIGER TEAM)
3. NASTESKI MATIJA (KK NOVI ZAGREB)
3. BUKOVIČ NORBERT (SVK)
5. BJELAJAC OGNJEN (MONTENEGRO)
5. RUFINI SAMUELE (TKP)
7. KOLODIEZNYI DANYLO (CONCORDIA)
7. GIORDANO FABRIZIO (ITALY)

*Seeded

Referees:			

Kumite male juniors -68kg

31ST KARATE GRAND PRIX CROATIA, CITY SPORTS HALL SAMOBOR, ANDRIJE HEBRANGA 26A, SAMOBOR, CROATIA, CRO

2023-01-21

Tatami
1 16:20

Pool
1/2

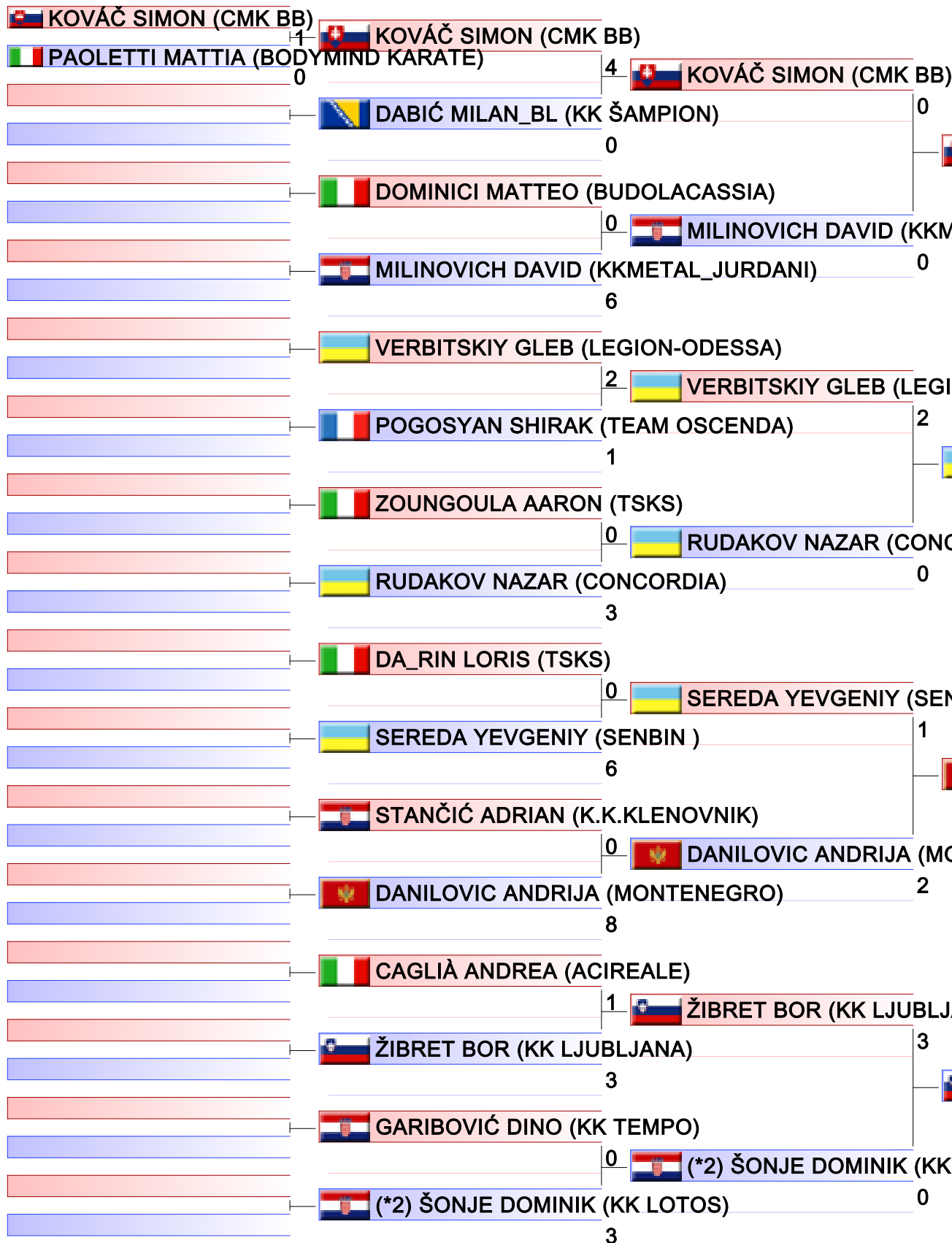

1. DANILOVIC ANDRIJA (MONTENEGRO)
2. PITSUL HEORHII (ASC)
3. CALIFANO PIETRO_PIO (ITALY)
3. ŽIBRET BOR (KK LJUBLJANA)
5. PALJEVAC SINAN (SAMPIONI)
5. KOVÁČ SIMON (CMK BB)
7. ZRNIĆ MIHAJLO (ENERGIJA)
7. SEREDA YEVGENIY (SENBIN)

*Seeded

Referees:			

Kumite male juniors -68kg

31ST KARATE GRAND PRIX CROATIA, CITY SPORTS HALL SAMOBOR, ANDRIJE HEBRANGA 26A, SAMOBOR, CROATIA, CRO

2023-01-21

Tatami
2 16:25

Pool
2/2

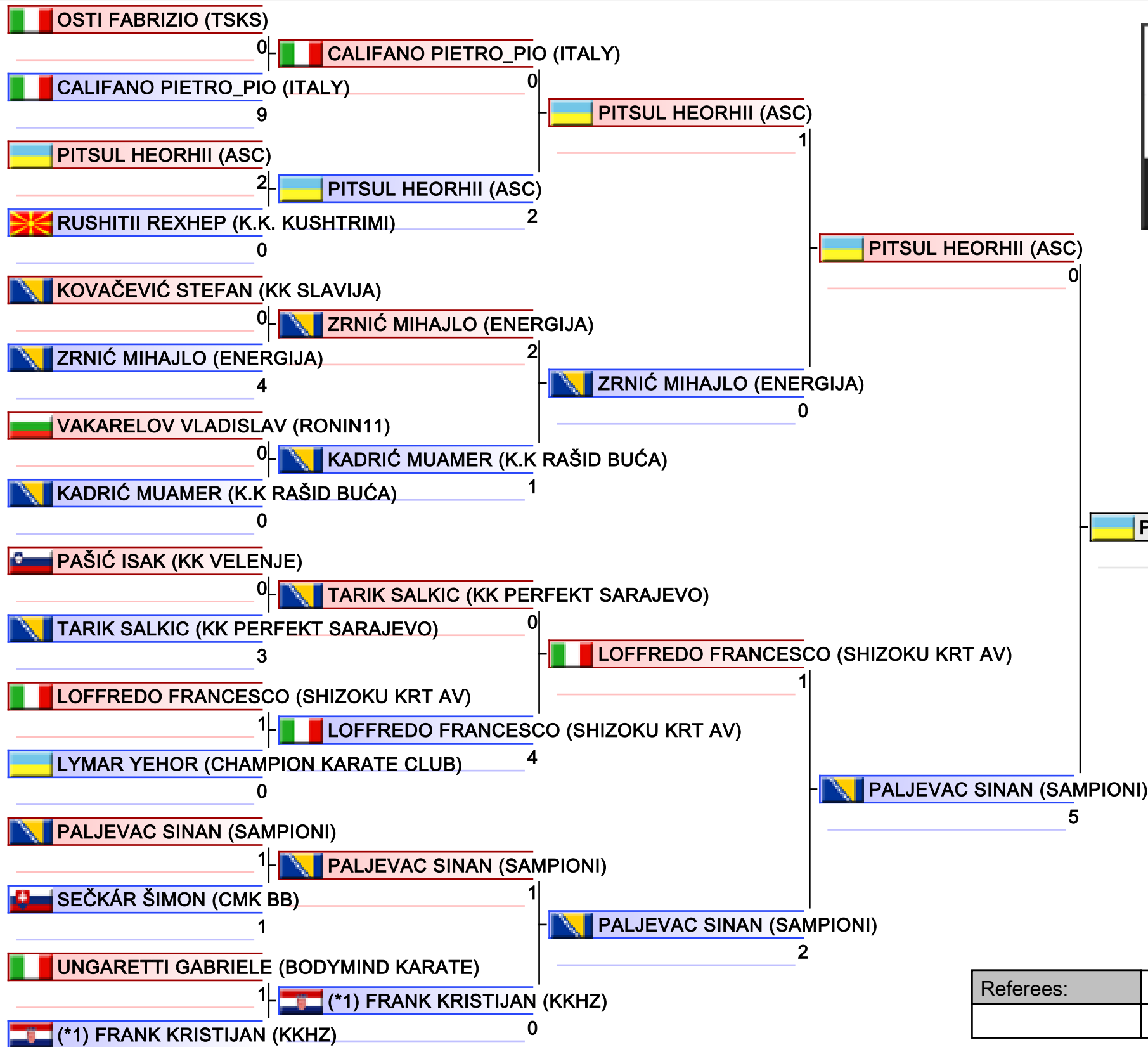

- | |
|-----------------------------------|
| 1. DANILOVIC ANDRIJA (MONTENEGRO) |
| 2. PITSUL HEORHII (ASC) |
| 3. CALIFANO PIETRO_PIO (ITALY) |
| 3. ŽIBRET BOR (KK LJUBLJANA) |
| 5. PALJEVAC SINAN (SAMPIONI) |
| 5. KOVÁČ SIMON (CMK BB) |
| 7. ZRNIĆ MIHAJLO (ENERGIJA) |
| 7. SEREDA YEVGENIY (SENBIN) |

*Seeded

Referees:			

Kumite male juniors -76kg

31ST KARATE GRAND PRIX CROATIA, CITY SPORTS HALL SAMOBOR, ANDRIJE HEBRANGA 26A, SAMOBOR, CROATIA, CRO

2023-01-21

Tatami
5 17:00

Pool
1/2

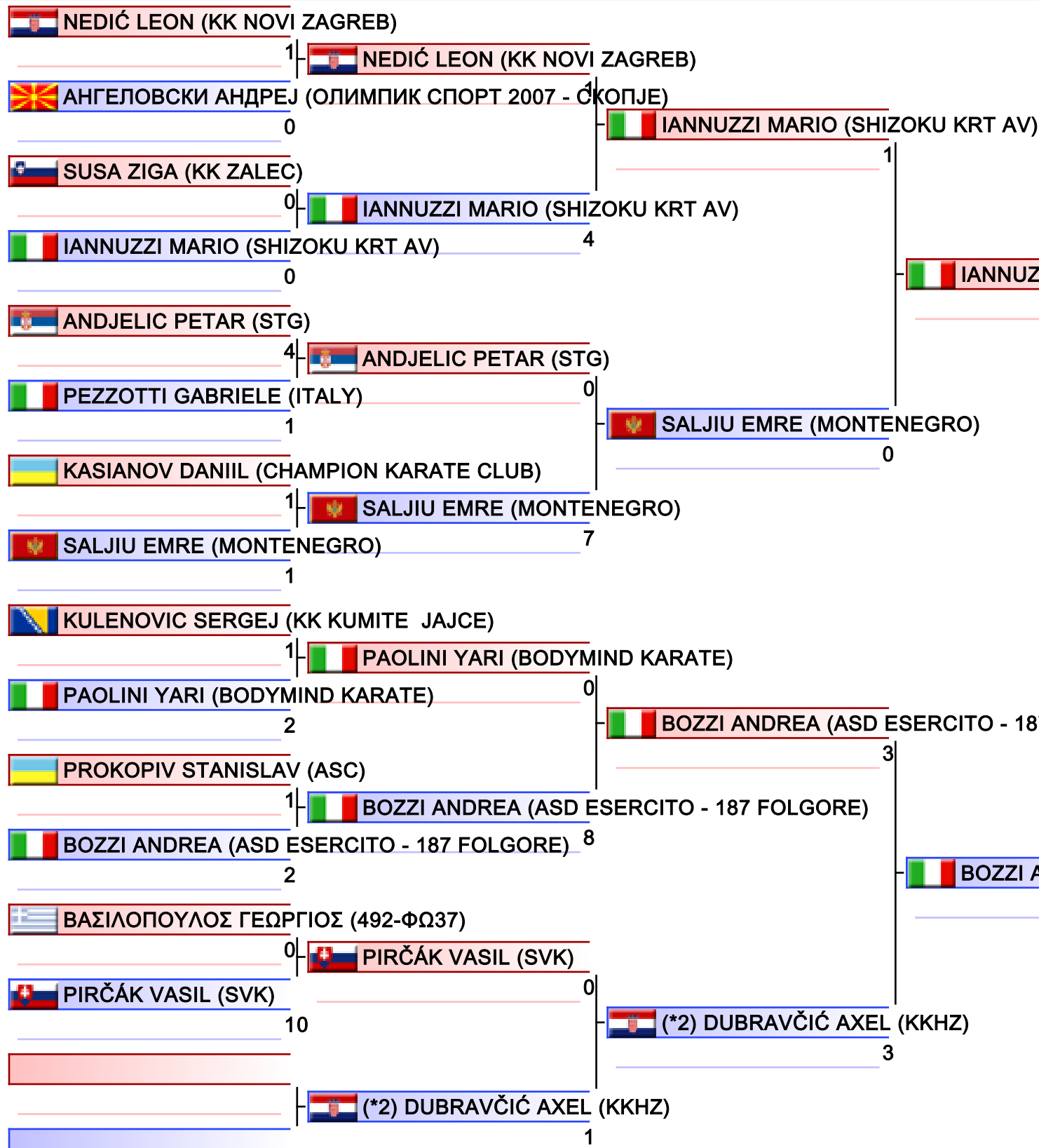

1. IANNUZZI MARIO (SHIZOKU KRT AV)
2. LOZANOVSKI DIMITAR (MAKPETROL MKD)
3. MILETA TOMA (KKŠ1066)
3. SALJIU EMRE (MONTENEGRO)
5. SINANOVIĆ FARIS (KBS TUZLA)
5. BOZZI ANDREA (ASD ESERCITO - 187 FOLGORE)
7. BOŽIČ CENE (KKK IDRIJA)
7. SUSA ZIGA (KK ZALEC)

*Seeded

Referees:			

Kumite male juniors -76kg

31ST KARATE GRAND PRIX CROATIA, CITY SPORTS HALL SAMOBOR, ANDRIJE HEBRANGA 26A, SAMOBOR, CROATIA, CRO

2023-01-21

Tatami
6 17:00

Pool
2/2

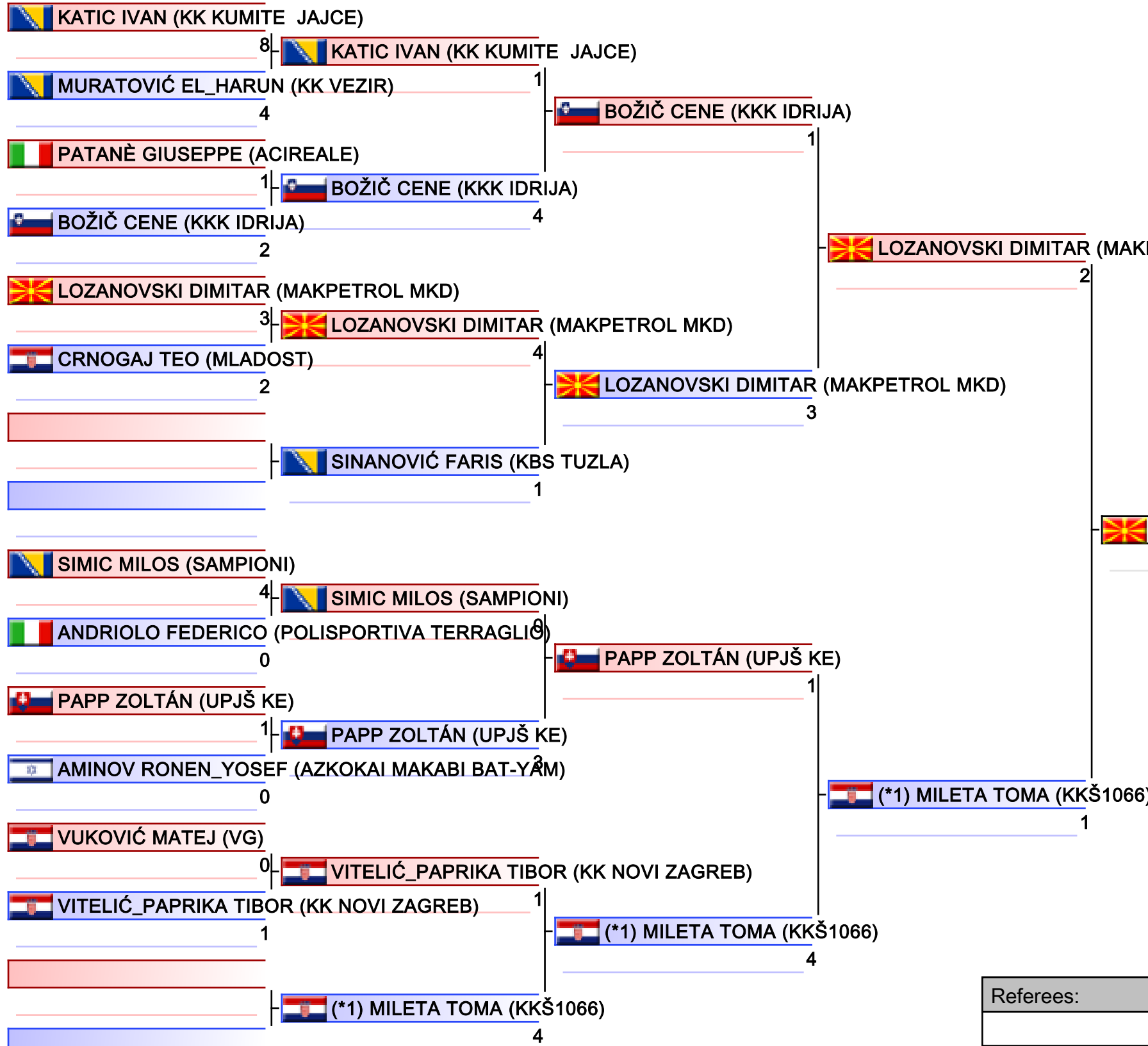

1. IANNUZZI MARIO (SHIZOKU KRT AV)
2. LOZANOVSKI DIMITAR (MAKPETROL MKD)
3. MILETA TOMA (KKŠ1066)
3. SALJIU EMRE (MONTENEGRO)
5. SINANOVIĆ FARIS (KBS TUZLA)
5. BOZZI ANDREA (ASD ESERCITO - 187 FOLGORIO)
7. BOŽIČ CENE (KKK IDRIJA)
7. SUSA ZIGA (KK ZALEC)

*Seeded

Referees:			

Pool winner-Kumite Female U21 -55kg

31ST KARATE GRAND PRIX CROATIA, CITY SPORTS HALL SAMOBOR, ANDRIJE HEBRANGA 26A, SAMOBOR, CROATIA, CRO

Tatami

Pool
1/1

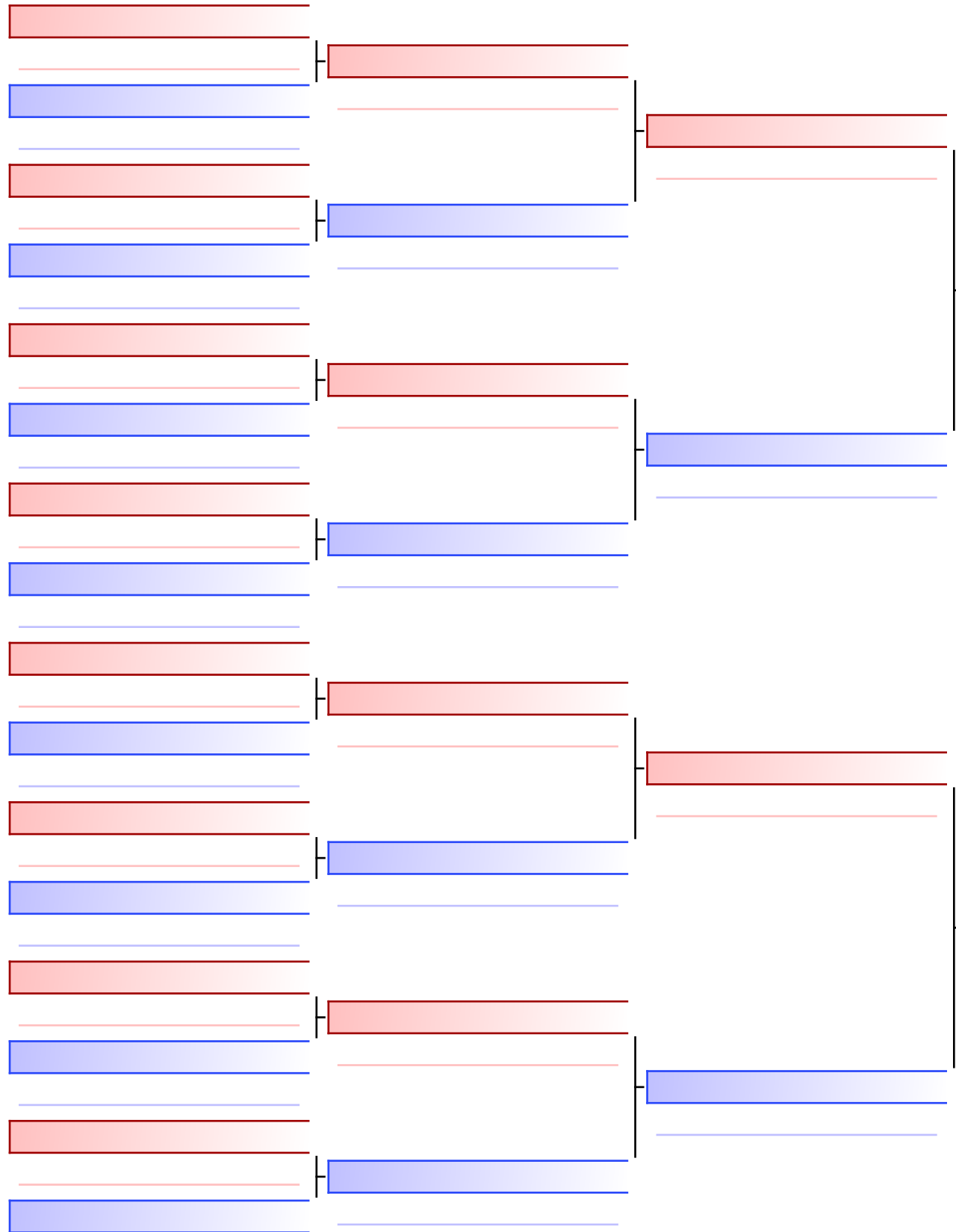

Final

BERGANT LAURA (KK POLZELA)

3

BERGANT LAURA (KK POLZELA)

SIPOVIC NEJRA (IPPON SARAJEVO)

1

1. BERGANT LAURA (KK POLZELA)
2. SIPOVIC NEJRA (IPPON SARAJEVO)
3. NEGOVANOVIC BRANKICA (KK ŠAMPIONI - BK)
3. LOVRIĆ MIRTA (KK IPON ZAGREB)
5. REZIĆ DORA (KKZ)
5. ŠTIVIĆ EMA (KK.SPORTSLIFE)
7. BILANOVIĆ ADNA (BILANOVIĆ)
7. MIRCHEVA VERZHINIQ (LEVSKI)

***Seeded**

Referees:			

KUMITE BOYS 13-14 YEARS -69KG

31ST KARATE GRAND PRIX CROATIA

2023-01-22

Tatami
3 18:15

Pool
1

(c)sportdata GmbH & Co KG 2000-2023 (2023-01-22 22:22) v 10.0.0 build 1 (2023-01-19) License: Online_Event_ID-6798_31STKARATEGRANDPRIXCROATIA (expire 2023-02-05)

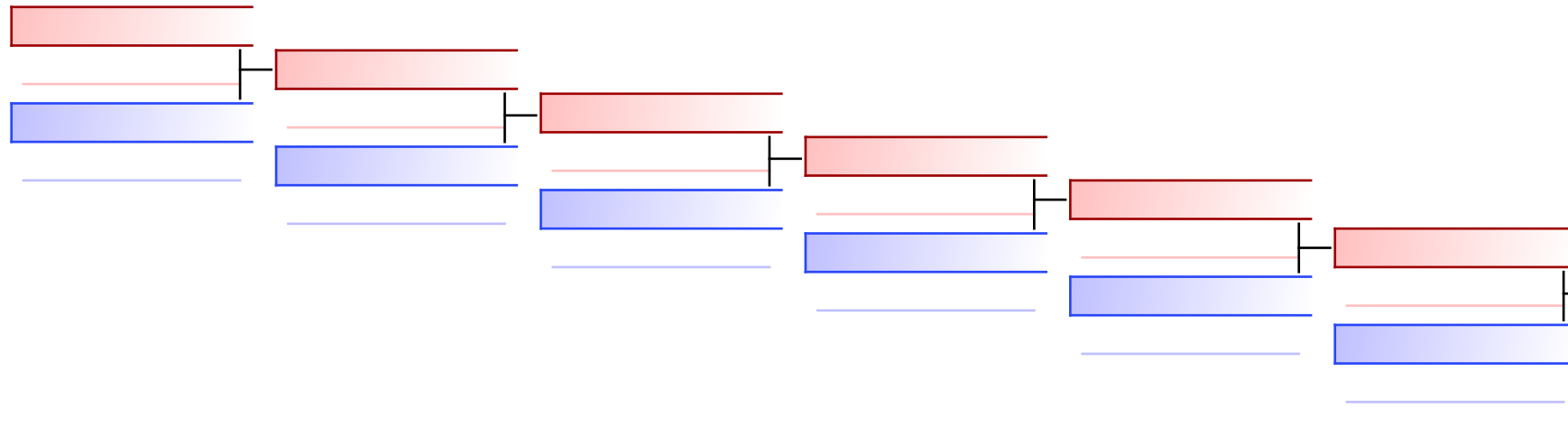

GIULIANO SIMONE (CAO CANTU)
3
 MICHÁLEK JAKUB (SVK)
0

REPECHAGE: (1)

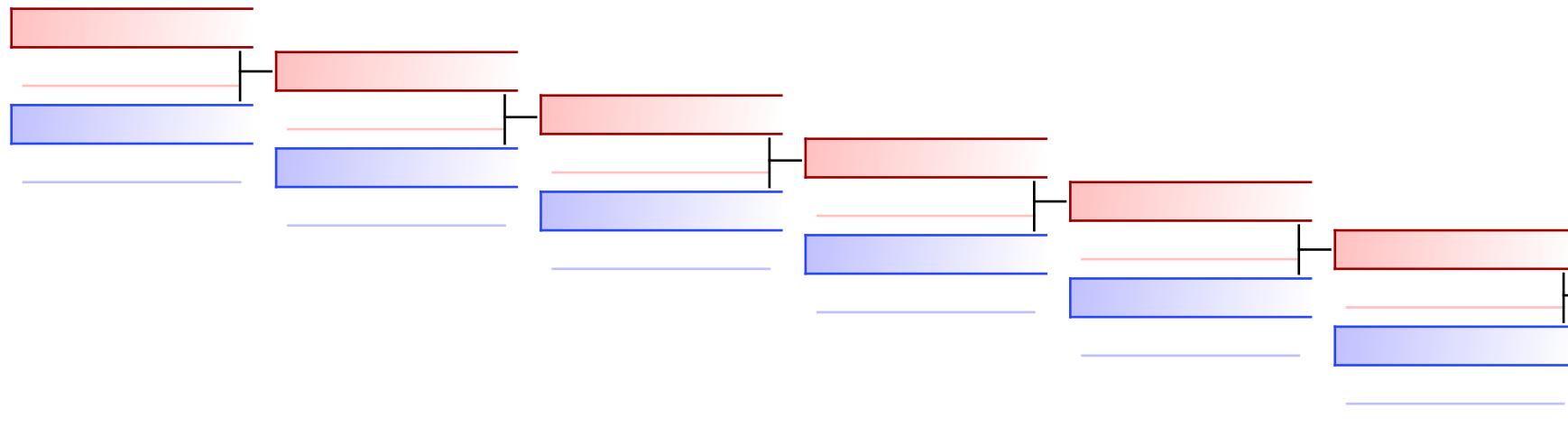

HUSAM ISSA (J.S.S.K)
0
 SHAKHOV MYKOLA (LEADER)
5

Referees:							
-----------	--	--	--	--	--	--	--

KUMITE BOYS 7-8 YEARS -28kg

31ST KARATE GRAND PRIX CROATIA



2023-01-22

Tatami
1 15:05

Pool
1

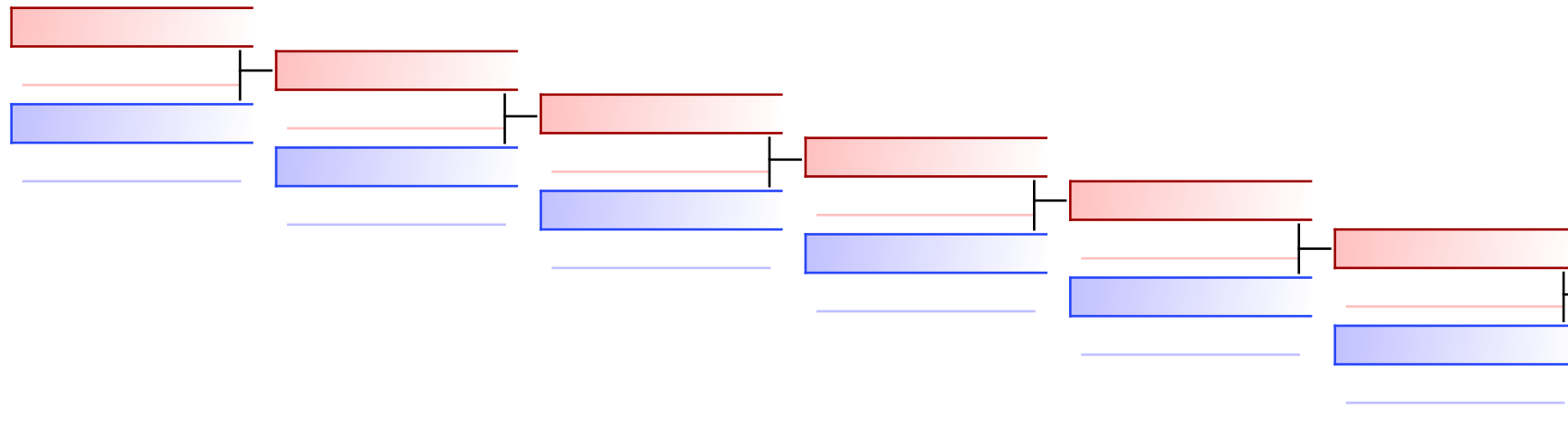
(c)sportdata GmbH & Co KG 2000-2023 (2023-01-22 22:22) v 10.0.0 build 1 (2023-01-19) License: Online_Event_ID-6798_31STKARATEGRANDPRIXCROATIA (expire 2023-02-05)



 **EDUARD CHI (C. S. CRIUL)**
0
 **BOICHUK OLEKSANDR (LEADER)**
9

REPECHAGE: (1)

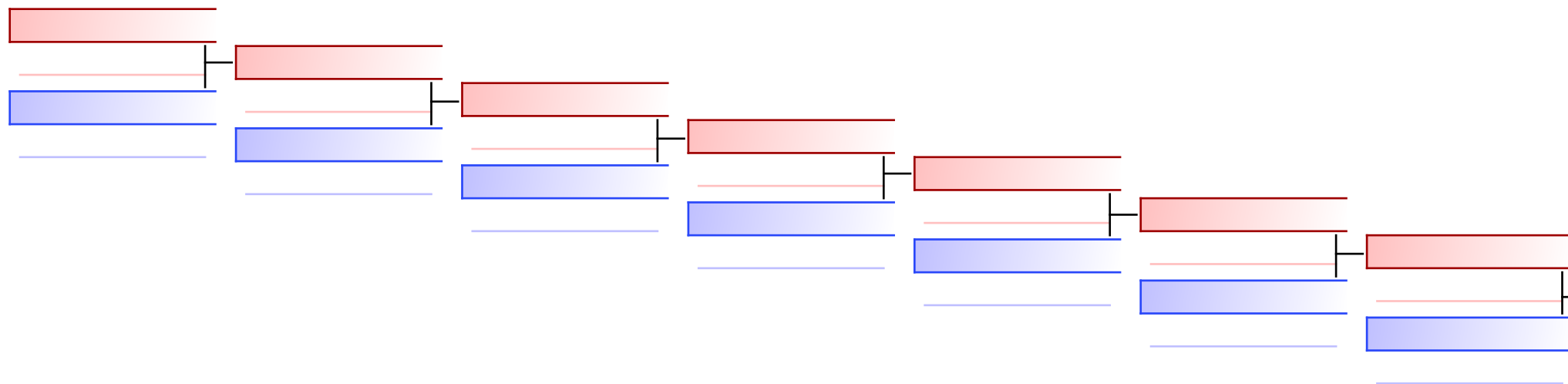

 **PAVLIUK NIKITA (CONCORDIA)**

Referees:							
-----------	--	--	--	--	--	--	--

KUMITE BOYS 9-10 YEARS -27KG

31ST KARATE GRAND PRIX CROATIA

2023-01-22

Tatami
3 16:15

Pool
1

(c)sportdata GmbH & Co KG 2000-2023 (2023-01-22 22:22) v 10.0.0 build 1 (2023-01-19) License: Online_Event_ID-6798_31STKARATEGRANDPRIXCROATIA (expire 2023-02-05)

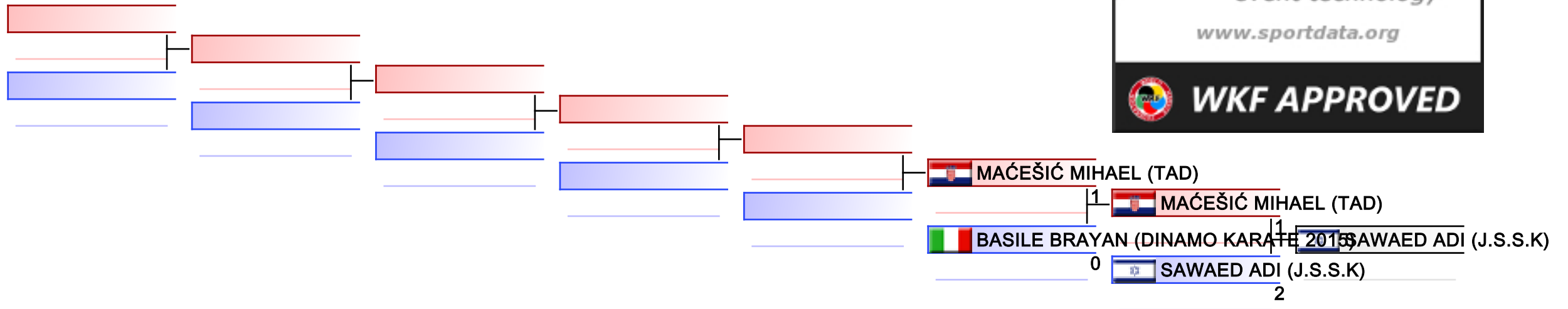

REPECHAGE: (1)

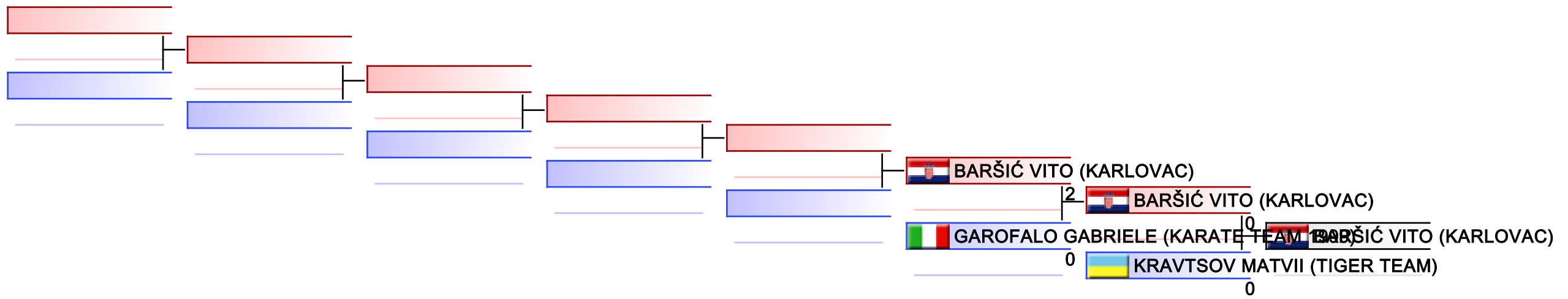

Referees:							
-----------	--	--	--	--	--	--	--

Pool winner-Kumite Male U21 +84kg

31ST KARATE GRAND PRIX CROATIA, CITY SPORTS HALL SAMOBOR, ANDRIJE HEBRANGA 26A, SAMOBOR, CROATIA, CRO

Tatami

Pool
1/1

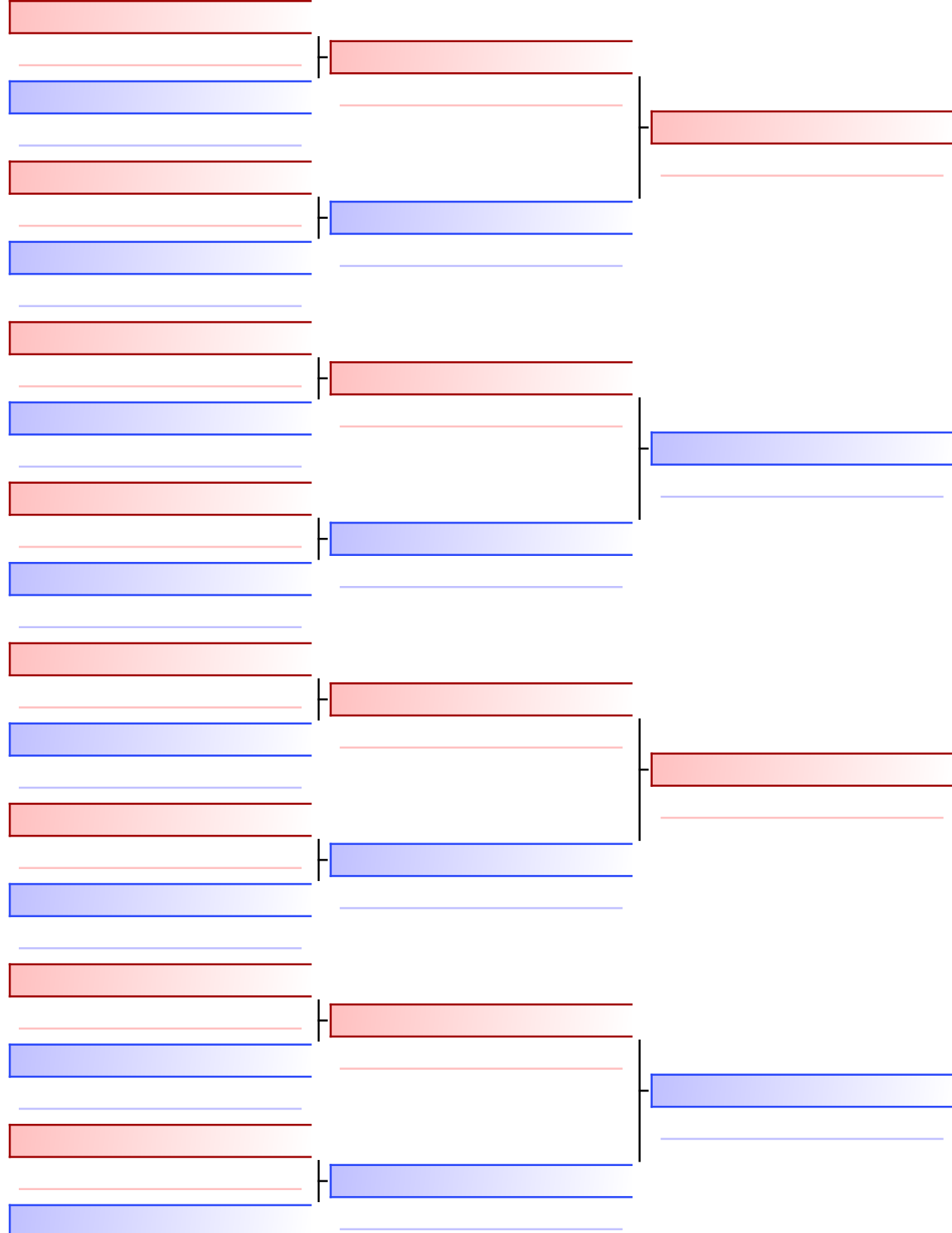

Final

KRESIC SANDRO (KK DO TUZLA)

4

KRESIC SANDRO (KK DO TUZLA)

STOJANOVIC STEFAN (MAKPETROL MKD)

0

1. KRESIC SANDRO (KK DO TUZLA)
2. STOJANOVIC STEFAN (MAKPETROL MKD)
3. JOVOVIC NEMANJA (MONTENEGRO)
3. MARKULJEVIĆ UROŠ (TRBOVLJE)
5. BAGAEV MALIK (SVK)
5. GLUHINIĆ DARIO (KK STIJENA)
7. KATANEC JAN (KKSA)
7. KVESIĆ LUKA (KKHZ)

*Seeded

Referees:			

Pool winner-Kumite Male U21 -60kg

31ST KARATE GRAND PRIX CROATIA, CITY SPORTS HALL SAMOBOR, ANDRIJE HEBRANGA 26A, SAMOBOR, CROATIA, CRO

Tatami

Pool
1/1

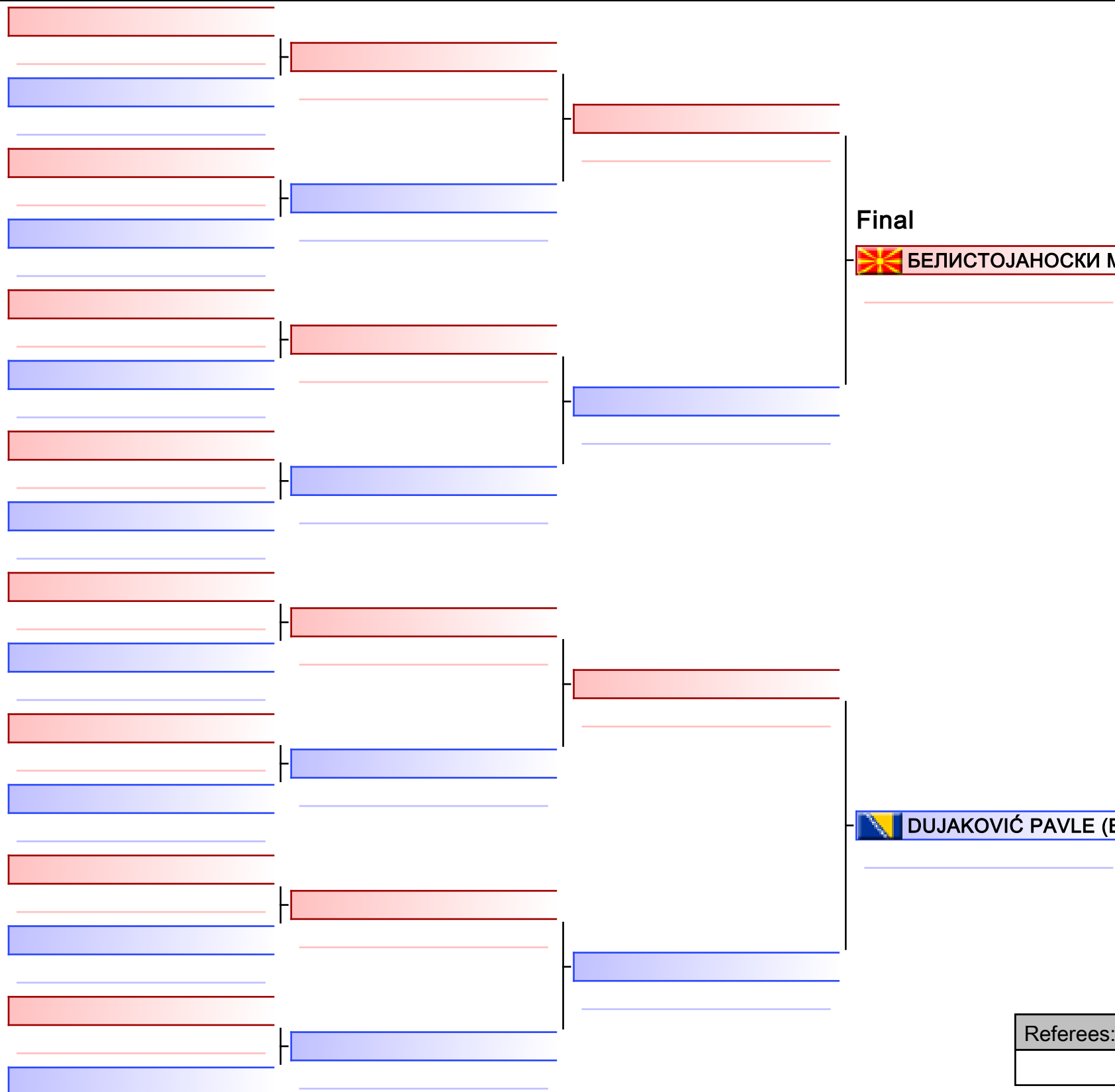

Final

БЕЛИСТОЈАНОСКИ МАТЕЈ (ОЛИМПИК СПОРТ 2007 - СКОПЈЕ)

3

DUJAKOVIĆ PAVLE (ENERGIJA)

DUJAKOVIĆ PAVLE (ENERGIJA)

4

1. DUJAKOVIĆ PAVLE (ENERGIJA)
2. БЕЛИСТОЈАНОСКИ МАТЕЈ (ОЛИМПИК СПОРТ 2007 - СКОПЈЕ)
3. KOLODIEZNYI DANYLO (CONCORDIA)
3. КОСТОВ БОЈАН (ОЛИМПИК СПОРТ 2007 - СКОПЈЕ)
5. SZABÓ MARCELL (KSI)
5. RUMENJAK NOA (KK IPON ZAGREB)
7. TOPLIČANEC KRISTIAN (GLOBUS)
7. SPAMPINATO MARCO_GAETANO (REMBUKAN)

*Seeded

Referees:			

Pool winner-Kumite Male U21 -67kg

31ST KARATE GRAND PRIX CROATIA, CITY SPORTS HALL SAMOBOR, ANDRIJE HEBRANGA 26A, SAMOBOR, CROATIA, CRO

Tatami

Pool
1/1

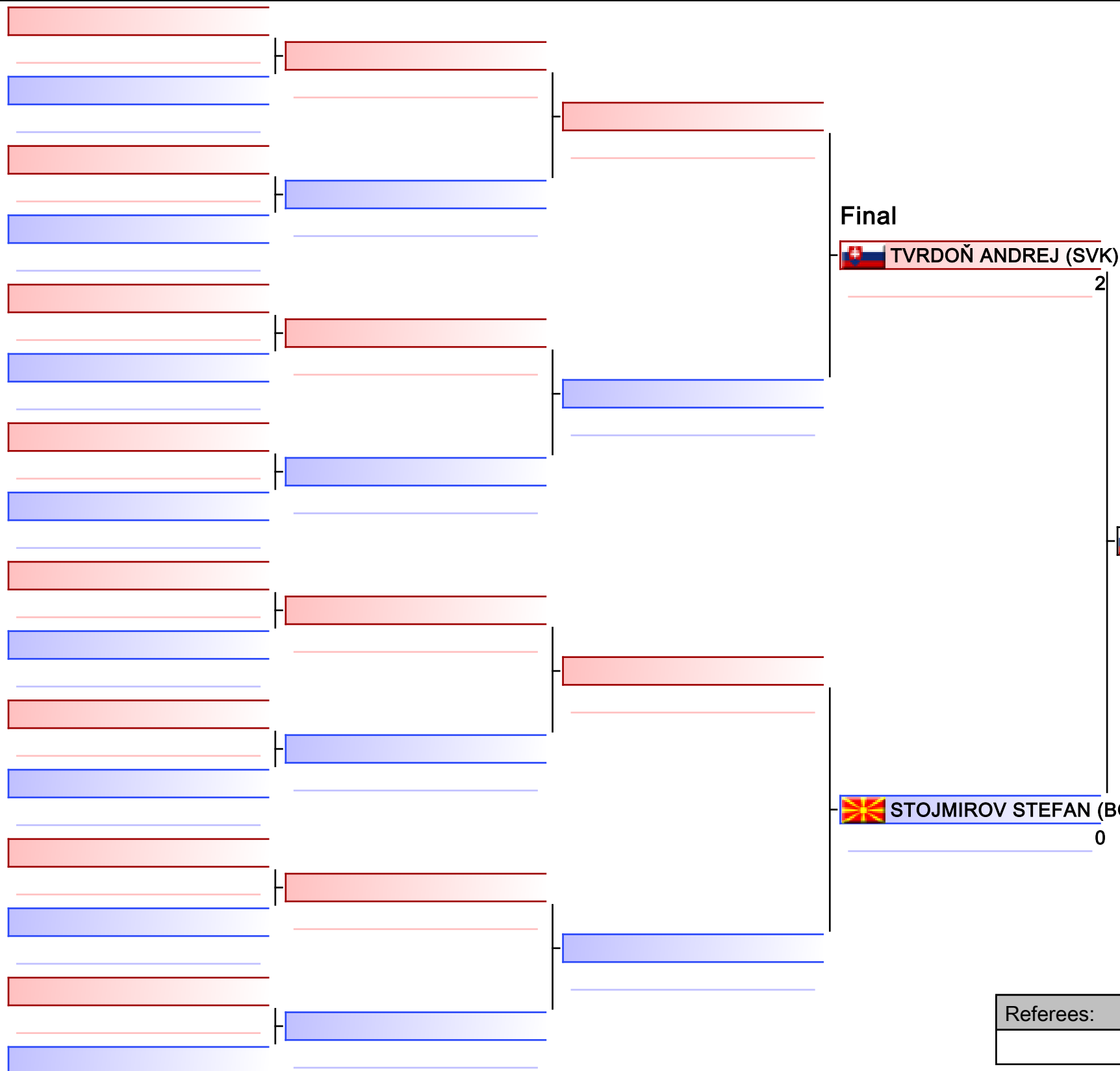

1. TVRDOŇ ANDREJ (SVK)
2. STOJMIROV STEFAN (BOTTONI)
3. RAMOS MATT (ITALY)
3. MEMIŠEVIĆ KENAN (KARATE AKADEMIJA - AR)
5. KOŠMRLJ ERIK_TEO (KK LJUBLJANA)
5. ZRNIĆ MIHAJLO (ENERGIJA)
7. LORENZETTI TOMMASO (TKT)
7. DUMBOVIĆ ROKO (KKTS)

*Seeded

Referees:			

Pool winner-Kumite Male U21 -75kg

31ST KARATE GRAND PRIX CROATIA, CITY SPORTS HALL SAMOBOR, ANDRIJE HEBRANGA 26A, SAMOBOR, CROATIA, CRO

Tatami

Pool
1/1

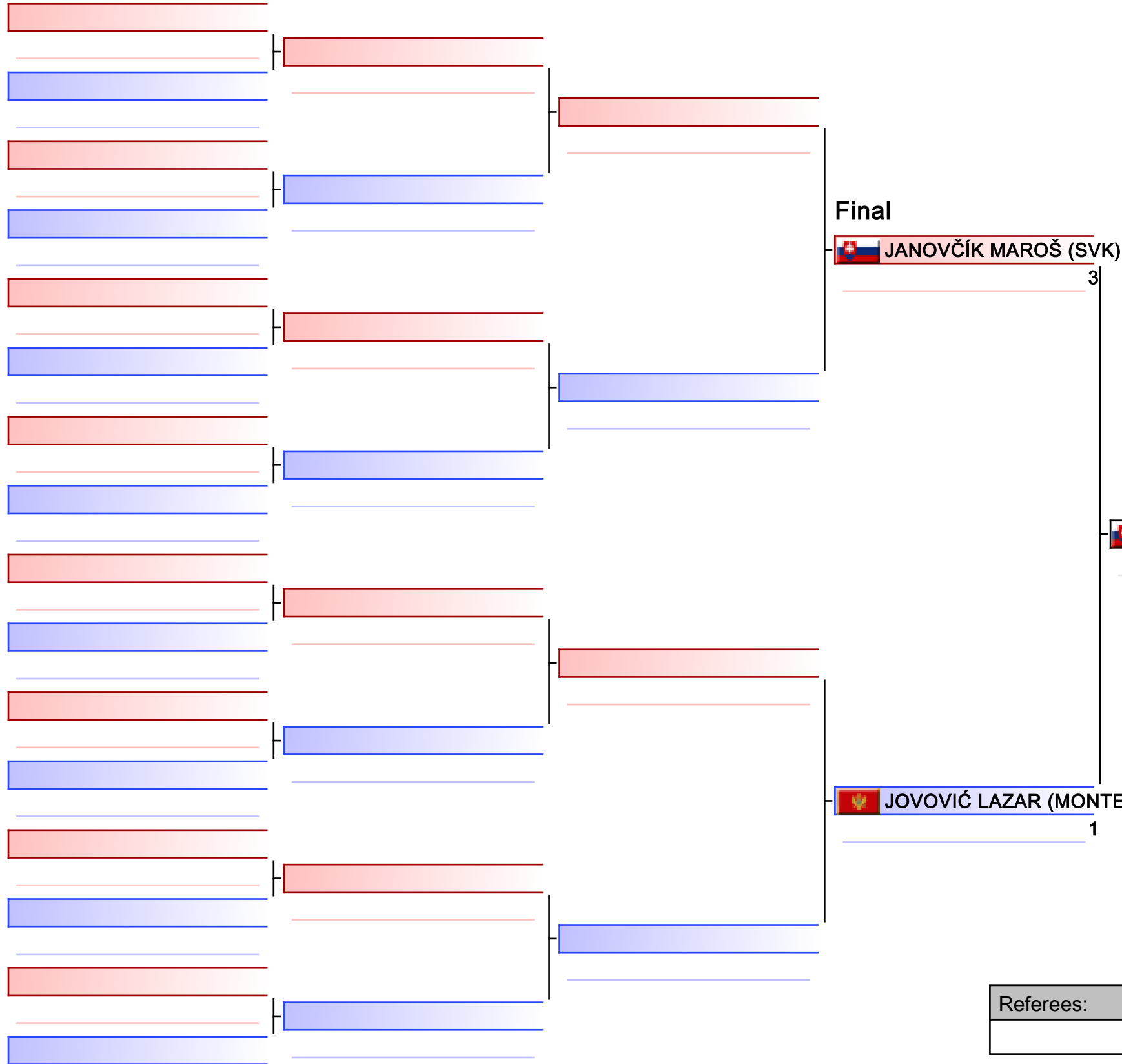

JANOVČÍK MAROŠ (SVK)

- | |
|--|
| 1. JANOVČÍK MAROŠ (SVK) |
| 2. JOVOVIĆ LAZAR (MONTENEGRO) |
| 3. KASIANOV DANIL (CHAMPION KARATE CLUB) |
| 3. ORLANDIC PETAR (STG) |
| 5. DELIĆ ALIJA (_KK NOVI GRAD SA_) |
| 5. KNIRSCH PATRIK (MTK) |
| 7. IVANOVIĆ NIKOLA (KK DINAMO PANČEVO) |
| 7. BARLOV ADIN (KK ZANSHIN) |

Referees:			

Pool winner-Kumite Male U21 -84kg

31ST KARATE GRAND PRIX CROATIA, CITY SPORTS HALL SAMOBOR, ANDRIJE HEBRANGA 26A, SAMOBOR, CROATIA, CRO

Tatami

Pool
1/1

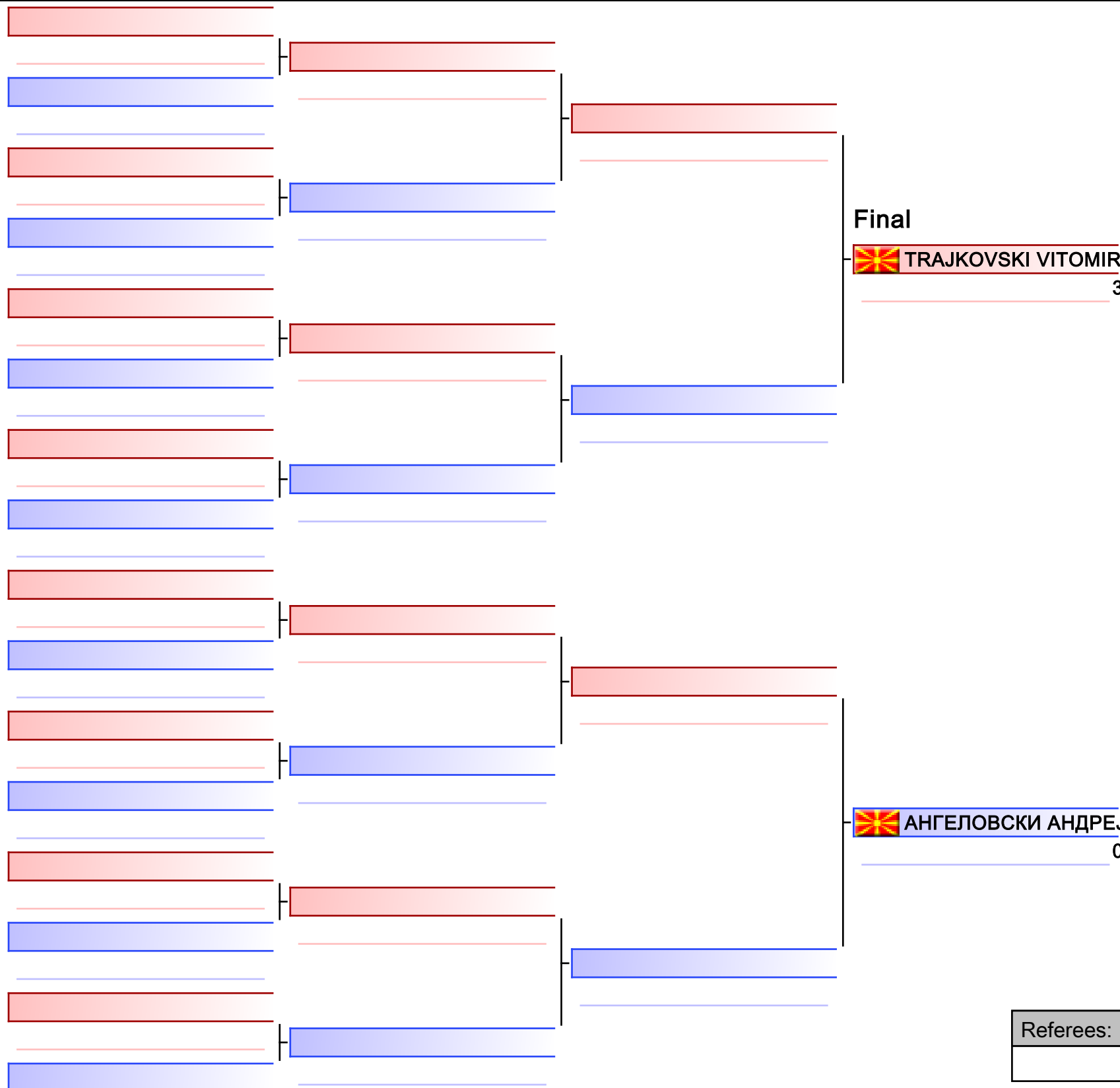

Final

TRAJKOVSKI VITOMIR (МАКРЕТОЛ МКД)

3

TRAJKOVSKI VITOMIR (МАКРЕТОЛ МКД)

АНГЕЛОВСКИ АНДРЕЈ (ОЛИМПИК СПОРТ 2007 - СКОПЈЕ)

0

1. TRAJKOVSKI VITOMIR (МАКРЕТОЛ МКД)
2. АНГЕЛОВСКИ АНДРЕЈ (ОЛИМПИК СПОРТ 2007 - СКОПЈЕ)
3. POLIAK JAKUB (SVK)
3. KEŠEĽAK DOMINIK (SVK)
5. MARTIĆ ANTONIO (KK.SPORTSLIFE)
5. JORDAN TIMOTEJ (KK BUSHIDO)
7. ΤΡΑΓΑΣ ΣΩΤΗΡΙΟΣ (492-ΦΩ37)
7. POLIAKOV MAKSYM (OKI)

Referees:			

Pool winner-Kumite female Cadets +61kg

31ST KARATE GRAND PRIX CROATIA, CITY SPORTS HALL SAMOBOR, ANDRIJE HEBRANGA 26A, SAMOBOR, CROATIA, CRO

Tatami

Pool
1/1

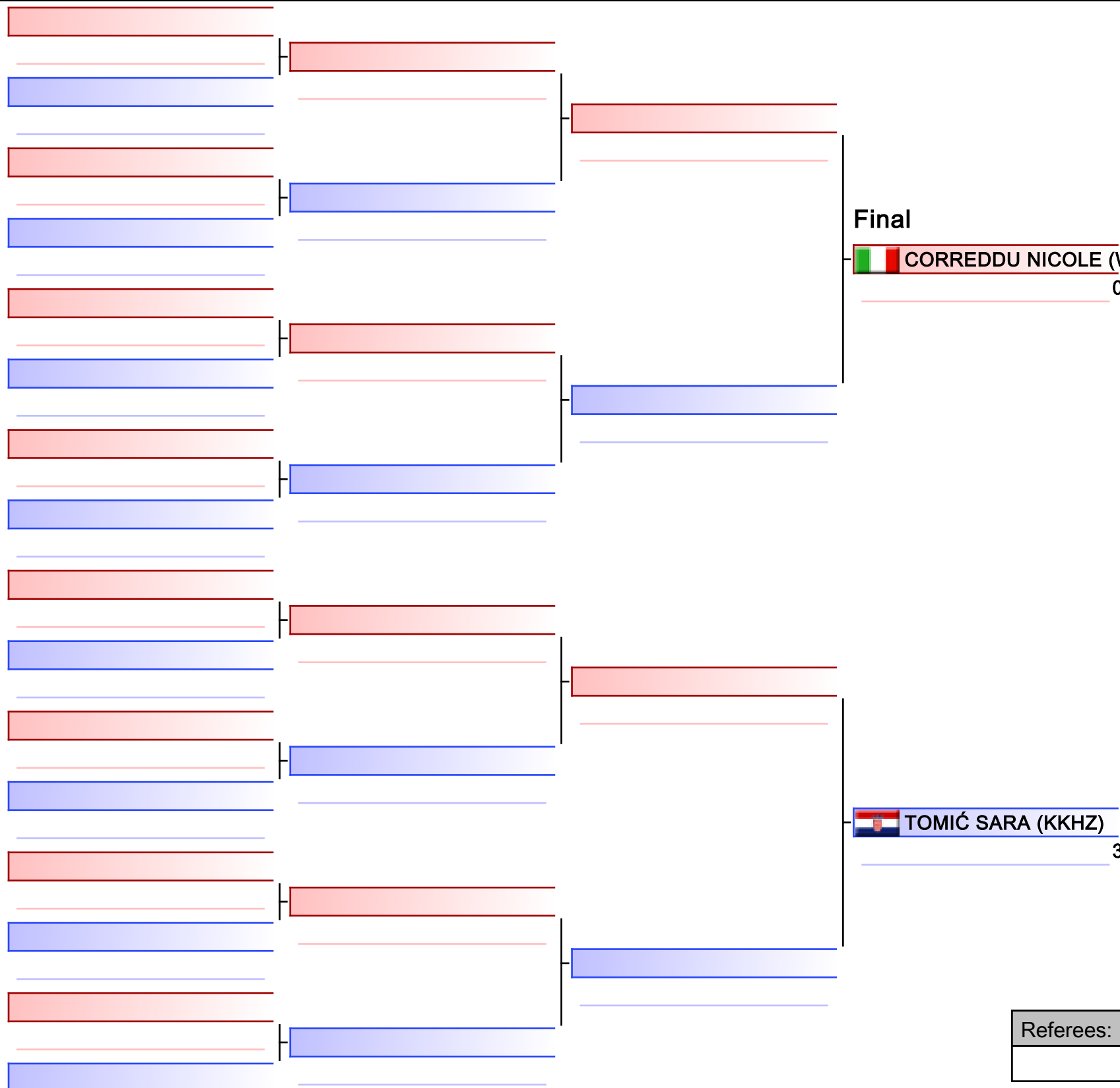

Final

CORREDDU NICOLE (WWKRT SORSO)

0

TOMIĆ SARA (KKHZ)

TOMIĆ SARA (KKHZ)

3

1. TOMIĆ SARA (KKHZ)
2. CORREDDU NICOLE (WWKRT SORSO)
3. HUMAR GAJA (KKK IDRIJA)
3. KULIKOVÁ VIRA (CMK BB)
5. SELMAN AJRA (KK VEZIR)
5. CHRASTINOVÁ PETRA (SVK)
7. TAHIROVA MARIIA (TIGER TEAM)
7. BORICIC NADJA (MONTENEGRO)

***Seeded**

Referees:			

Pool winner-Kumite female Cadets -61kg

31ST KARATE GRAND PRIX CROATIA, CITY SPORTS HALL SAMOBOR, ANDRIJE HEBRANGA 26A, SAMOBOR, CROATIA, CRO

Tatami

Pool
1/1

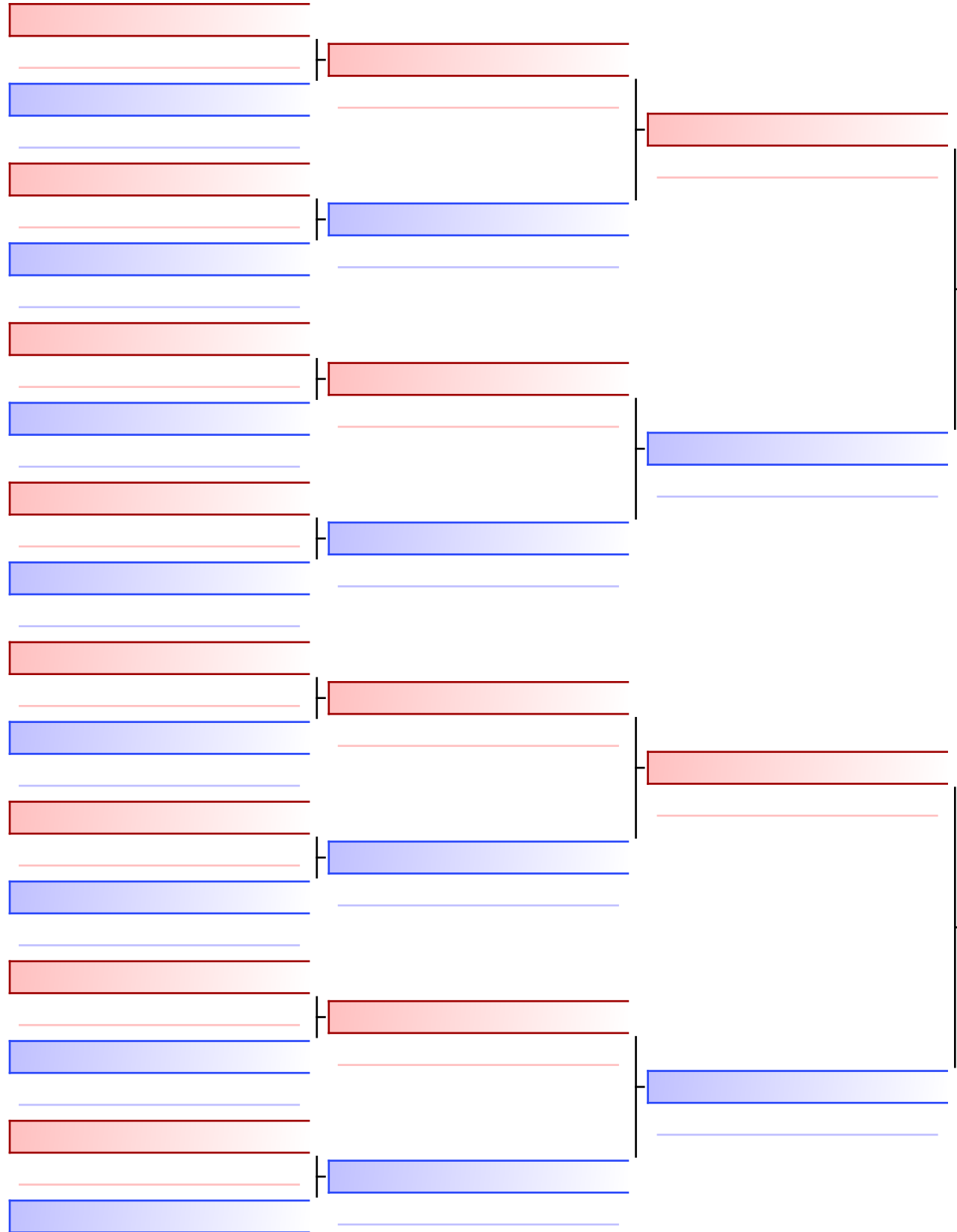

Final

 **VOLOSHYN SOLOMIYA (UNION TEAM)**

0

 **DAMJANOVIC JOVANA (MONTENEGRO)**

 **DAMJANOVIC JOVANA (MONTENEGRO)**

2

1. DAMJANOVIC JOVANA (MONTENEGRO)
2. VOLOSHYN SOLOMIYA (UNION TEAM)
3. STRAHIIJA LAURA (GLOBUS)
3. JESENIČOVÁ NINA (SVK)
5. REDŽIĆ JANA (OPATIJA)
5. JOKSIMOVIĆ ĐURĐA (KKS BORAC - ČAČAK)
7. GANDOLA VIOLA (CAO CANTU)
7. BATH HANNAH (SPD)

***Seeded**

Referees:			

Pool winner-Kumite female Juniors +66kg

31ST KARATE GRAND PRIX CROATIA, CITY SPORTS HALL SAMOBOR, ANDRIJE HEBRANGA 26A, SAMOBOR, CROATIA, CRO

Tatami

Pool
1/1

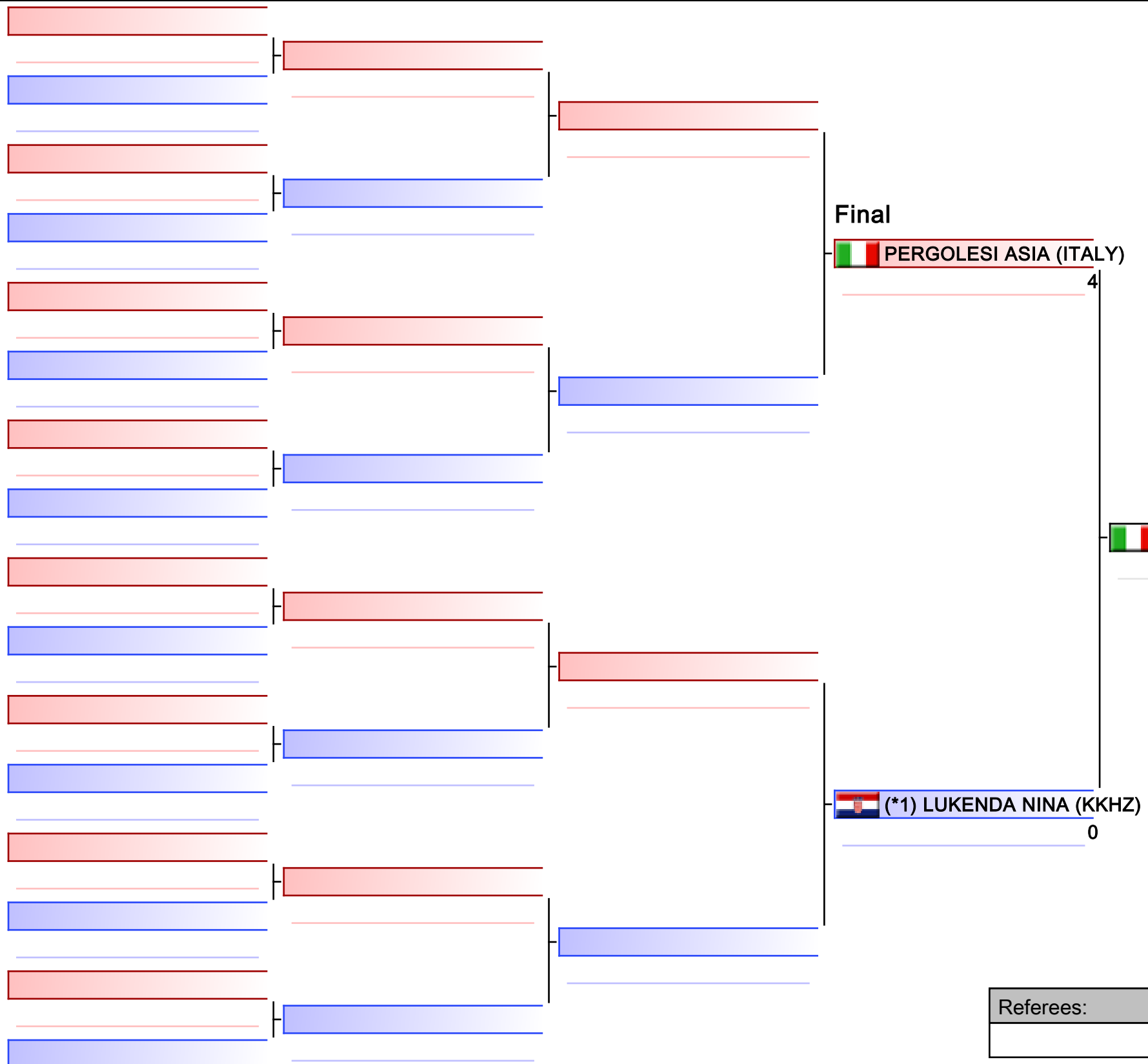

PERGOLESASI ASIA (ITALY)

1. PERGOLESASI ASIA (ITALY)
2. LUKENDA NINA (KKHZ)
3. RAJIĆ DUNJA (LAZAREVO)
3. PORTOGHESE MORENA (CHAMPION CENTER)
5. MALENKOVA YULIA (OKI)
5. HOXHAJ ELENA (KK 10.DAN)
7. RONCAGLIA GIULIA (K. A. V.)
7. JEVTOVIC DUNJA (KK ZANDARMERIJA)

*Seeded

Referees:			

Pool winner-Kumite female Juniors -66kg

31ST KARATE GRAND PRIX CROATIA, CITY SPORTS HALL SAMOBOR, ANDRIJE HEBRANGA 26A, SAMOBOR, CROATIA, CRO

Tatami

Pool
1/1

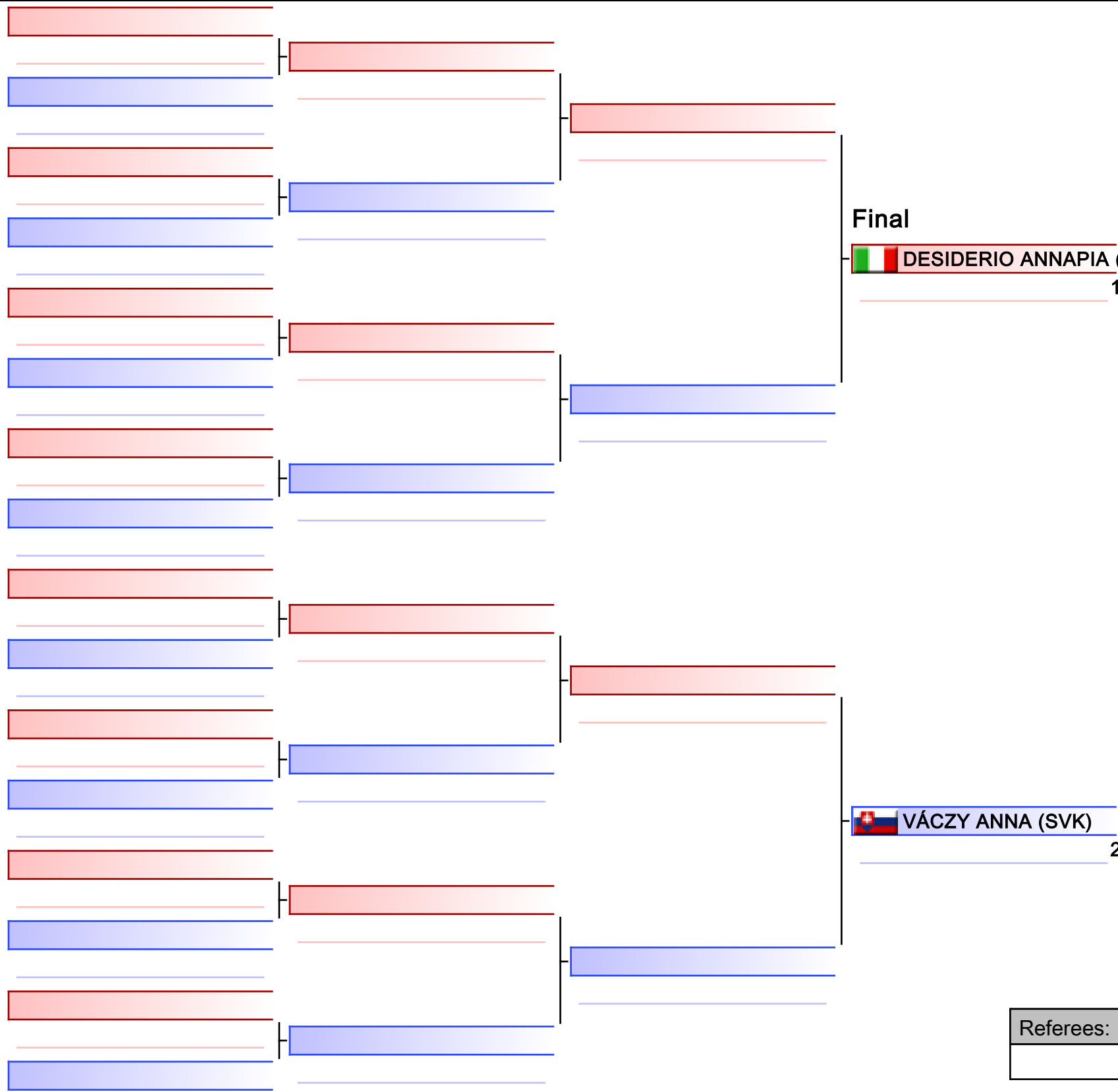

Final

DESIDERIO ANNAPIA (ITALY)

1

VÁCZY ANNA (SVK)

2

1. VÁCZY ANNA (SVK)
2. DESIDERIO ANNAPIA (ITALY)
3. CACKO MIA (KK 10.DAN)
3. MANDIĆ MARIJA (KKZ)
5. DALLE_FUSINE MARIA_CARLOTTA (A.SID CEN)
5. GULIJA LEONA. (GLOBUS)
7. SIPOVIC AJLA (IPPON SARAJEVO)
7. FILKOVIĆ EMA (VG)

***Seeded**

Referees:			

Pool winner-Kumite female cadets -47kg

31ST KARATE GRAND PRIX CROATIA, CITY SPORTS HALL SAMOBOR, ANDRIJE HEBRANGA 26A, SAMOBOR, CROATIA, CRO

Tatami

Pool
1/1

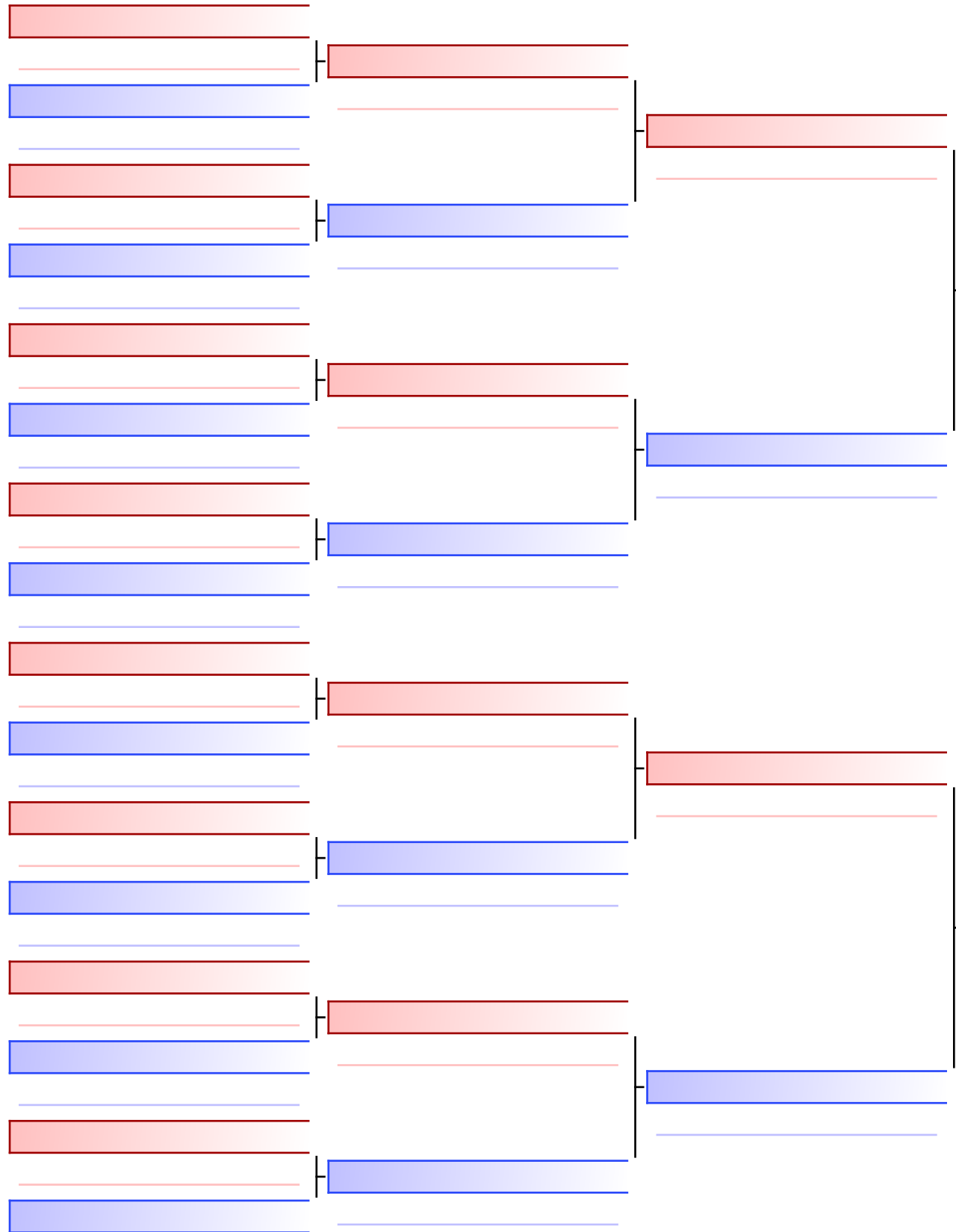

Final

BOSSI ALESSANDRA (SKORPION KARATE ASD)

5

BOSSI ALESSANDRA (SKORPION KARATE ASD)

(*1) TRSTENJAK AIDA (GLOBUS)

2

- | |
|---|
| 1. BOSSI ALESSANDRA (SKORPION KARATE ASD) |
| 2. TRSTENJAK AIDA (GLOBUS) |
| 3. OSTAPENKO ALISA (LEON KARATE CLUB) |
| 3. LEGITTIMO LUDOVICA (ITALY) |
| 5. JURISIC PATRICIJA (KK KUMITE JAJCE) |
| 5. GRGUREVIC LEA (KK 10.DAN) |
| 7. OSTOJIĆ TIJANA (KKS BORAC - ČAČAK) |
| 7. JURJEVIĆ ALISA_EMA (KK BREGANA) |

***Seeded**

Referees:			

Pool winner-Kumite female cadets -54kg

31ST KARATE GRAND PRIX CROATIA, CITY SPORTS HALL SAMOBOR, ANDRIJE HEBRANGA 26A, SAMOBOR, CROATIA, CRO

Tatami

Pool
1/1

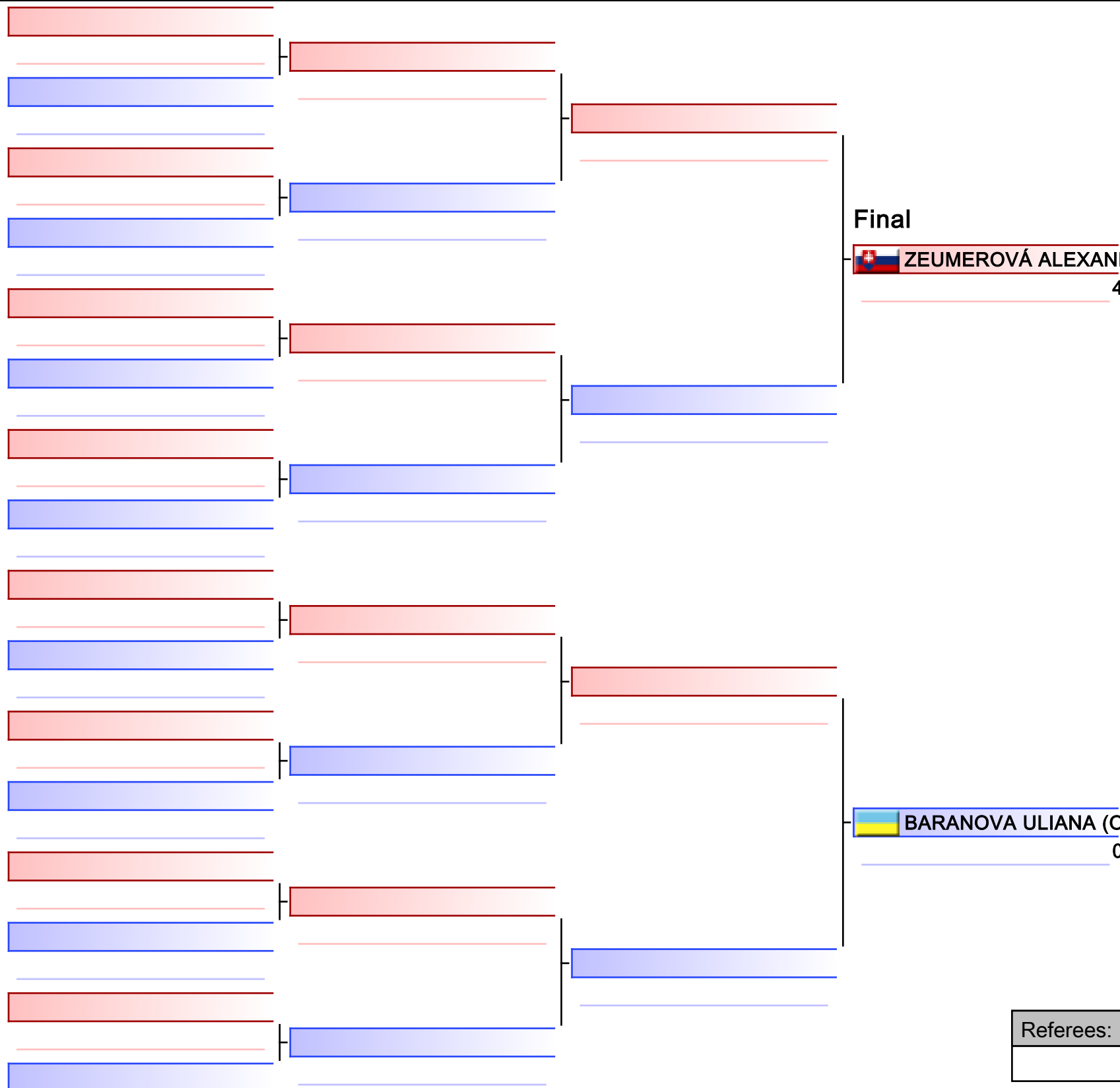

Final

ZEUMEROVÁ ALEXANDRA (SVK)

4

ZEUMEROVÁ ALEXANDRA (SVK)

BARANOVA ULIANA (OKI)

0

1. ZEUMEROVÁ ALEXANDRA (SVK)
2. BARANOVA ULIANA (OKI)
3. LUCIANI SYRIA (ITALY)
3. ADEL SANDO (SHINDOKAN)
5. KURBEGOVIĆ EDNA (KK LJUBLJANA)
5. PUSHKOVA ANASTASIIA (KATANA)
7. MAJDIAKOVÁ LAURA (CMK BB)
7. BANDIĆ PETRA (KKZ)

*Seeded

Referees:			

Pool winner-Kumite female juniors -48kg

31ST KARATE GRAND PRIX CROATIA, CITY SPORTS HALL SAMOBOR, ANDRIJE HEBRANGA 26A, SAMOBOR, CROATIA, CRO

Tatami

Pool
1/1

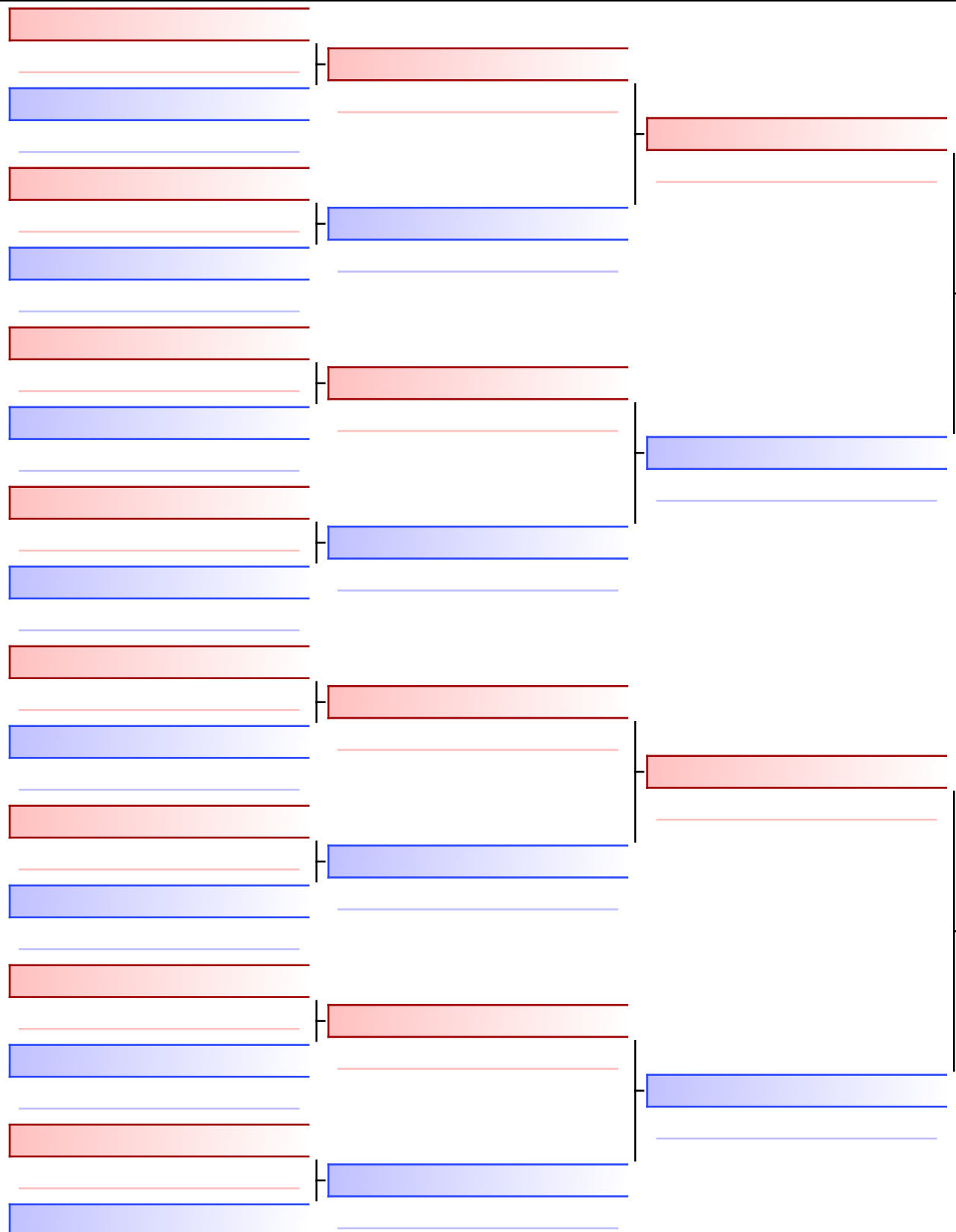

Final

BACKOVIC HELENA (MONTENEGRO)

1

BACKOVIC HELENA (MONTENEGRO)

(*1) KOCKAREVIC LANA (KK IPON ZAGREB)

0

1. BACKOVIC HELENA (MONTENEGRO)
2. KOCKAREVIC LANA (KK IPON ZAGREB)
3. VITALI VERONICA (F & C)
3. BOSSI ALESSANDRA (SKORPION KARATE ASD)
5. BATH SOFIA (SPD)
5. PETRESKA MARTINA (ЧОЛЕ - ОХРИД)
7. PERINA CAMILLA (MASTER RAPID SKF CBL)
7. DAMATO ALICE (12RM1604)

***Seeded**

Referees:			

Pool winner-Kumite female juniors -53kg

31ST KARATE GRAND PRIX CROATIA, CITY SPORTS HALL SAMOBOR, ANDRIJE HEBRANGA 26A, SAMOBOR, CROATIA, CRO

Tatami

Pool
1/1

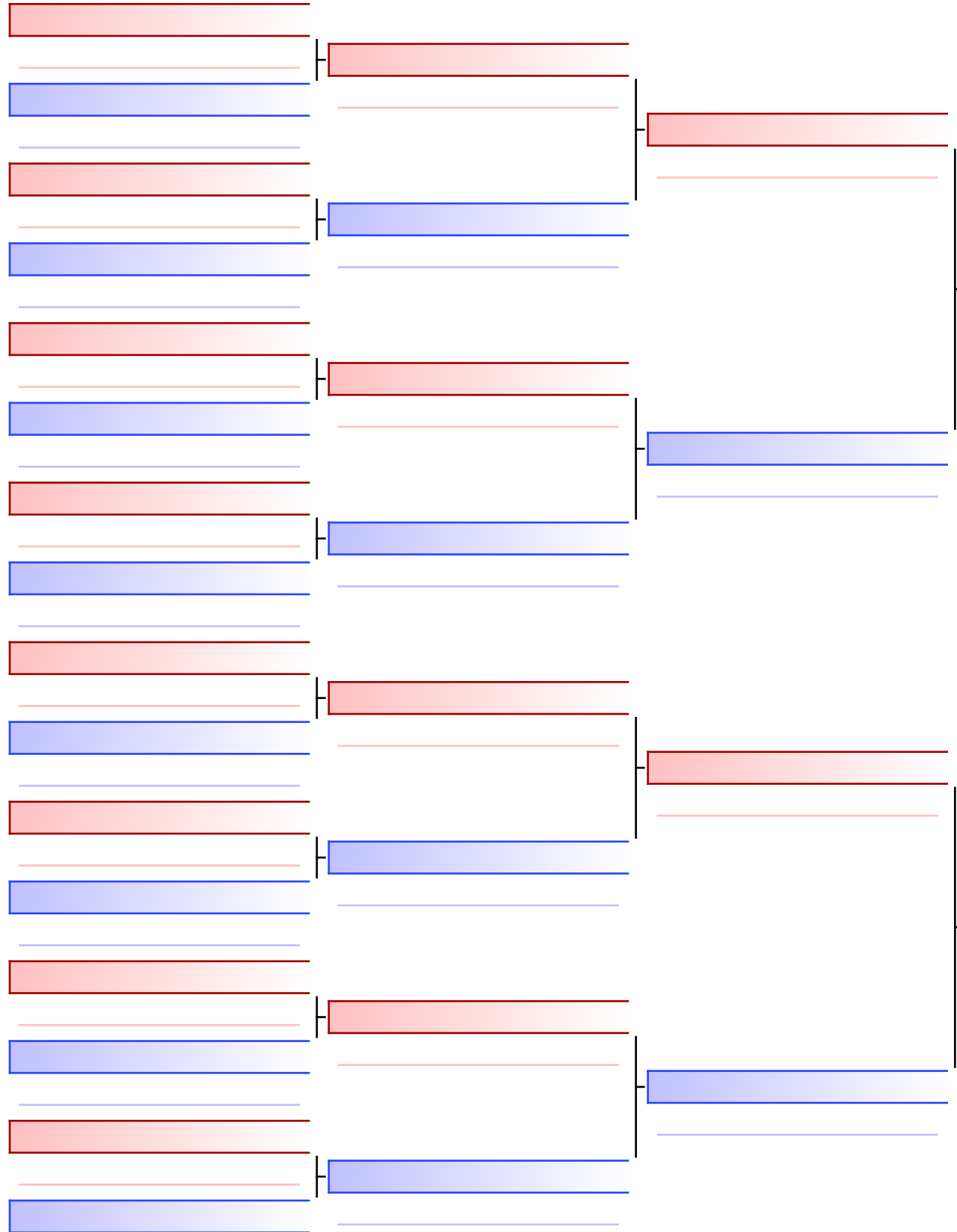

Final

PETAN ELA (KLUB BVFC SHONY)

1

PETAN ELA (KLUB BVFC SHONY)

TSANEVA TEODORA (KC TSANEV)

1

1. PETAN ELA (KLUB BVFC SHONY)
2. TSANEVA TEODORA (KC TSANEV)
3. MAJSEC ISKRA (KKSA)
3. VAJDA MAGDALENA (KK IPON ZAGREB)
5. SELIVERSTOVA DARIA (LEADER)
5. KYRYCHENKO KATERYNA (SFC KYIV)
7. МИШОВСКА МИХАЕЛА (ОЛИМПИК СПОРТ 2000)
7. BIFULCO ASIA (CHAMPION CENTER)

***Seeded**

Referees:			

Pool winner-Kumite female juniors -59kg

31ST KARATE GRAND PRIX CROATIA, CITY SPORTS HALL SAMOBOR, ANDRIJE HEBRANGA 26A, SAMOBOR, CROATIA, CRO

Tatami

Pool
1/1

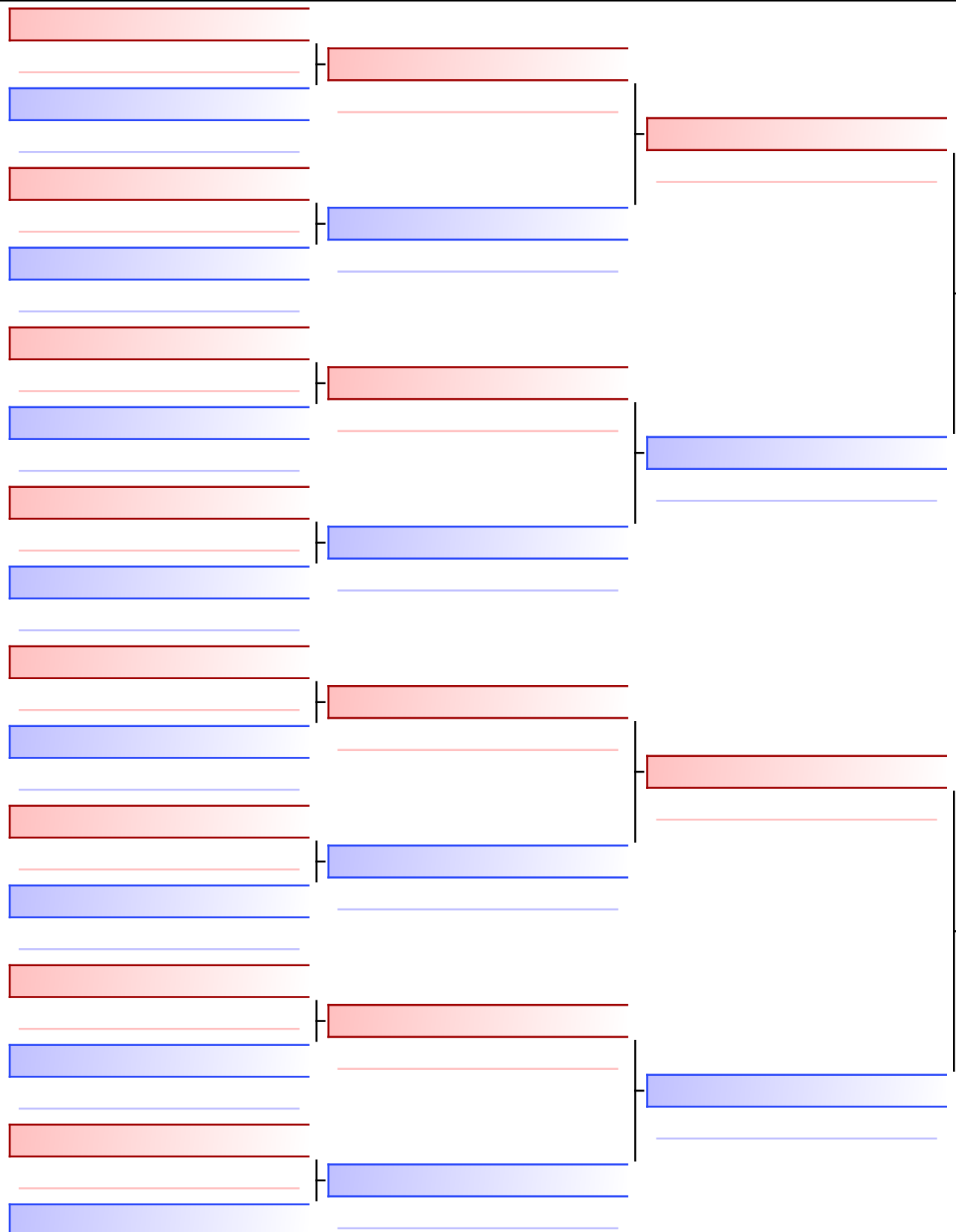

Final

FILIPOV NEVENA (KK MLADOST NOVO MILOSEVO)

1

MICOVSKA JOVANA (MAKPETROL MKD)

MICOVSKA JOVANA (MAKPETROL MKD)

1

1. MICOVSKA JOVANA (MAKPETROL MKD)
2. FILIPOV NEVENA (KK MLADOST NOVO MILOSEVO)
3. ŠNAJDER DARJA (K.K. SOKOL)
3. BARANOVA YLIANA (OKI)
5. MARTURANO IRENE (ITALY)
5. STOIMENOVA VENETA (KC TSANEV)
7. KOCKAREVIĆ EMANUELA (KK MAX)
7. LUPTÁKOVÁ NATÁLIA_LEA (SVK)

***Seeded**

Referees:			

KUMITE BOYS 9-10 YEARS -31kg

31ST KARATE GRAND PRIX CROATIA

2023-01-22

Tatami
5 16:15

Pool
1

(c)sportdata GmbH & Co KG 2000-2023 (2023-01-22 22:22) v 10.0.0 build 1 (2023-01-19) License: Online_Event_ID-6798_31STKARATEGRANDPRIXCROATIA (expire 2023-02-05)

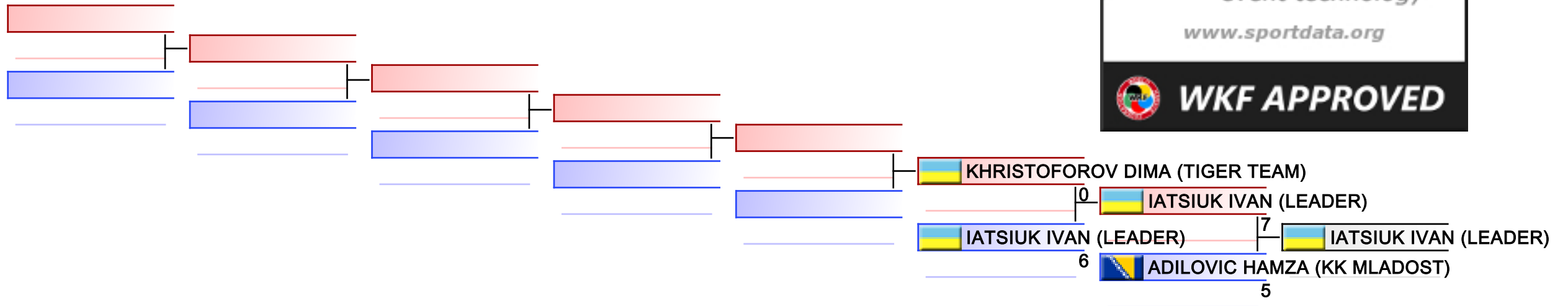

REPECHAGE: (1)

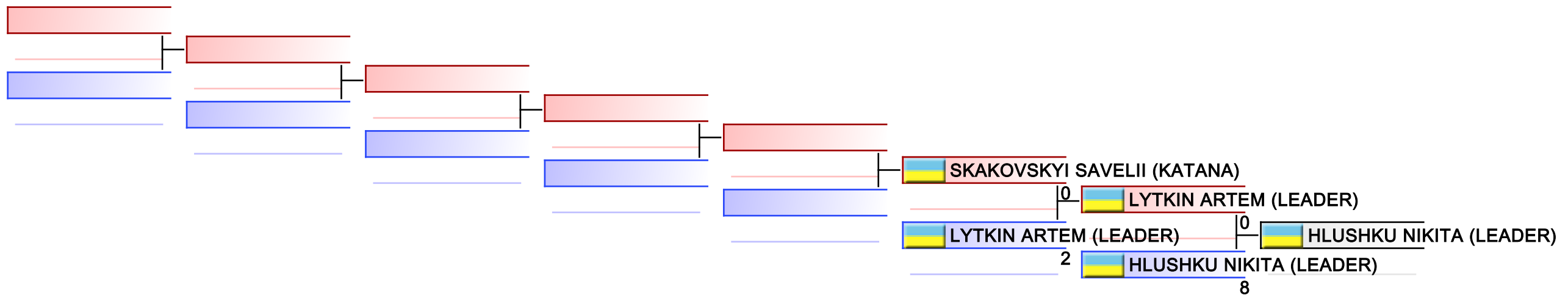

Referees:							
-----------	--	--	--	--	--	--	--

KUMITE BOYS 9-10 YEARS -35kg

31ST KARATE GRAND PRIX CROATIA

2023-01-22

Tatami
1 15:20

Pool
1

(c)sportdata GmbH & Co KG 2000-2023 (2023-01-22 22:22) v 10.0.0 build 1 (2023-01-19) License: Online_Event_ID-6798_31STKARATEGRANDPRIXCROATIA (expire 2023-02-05)

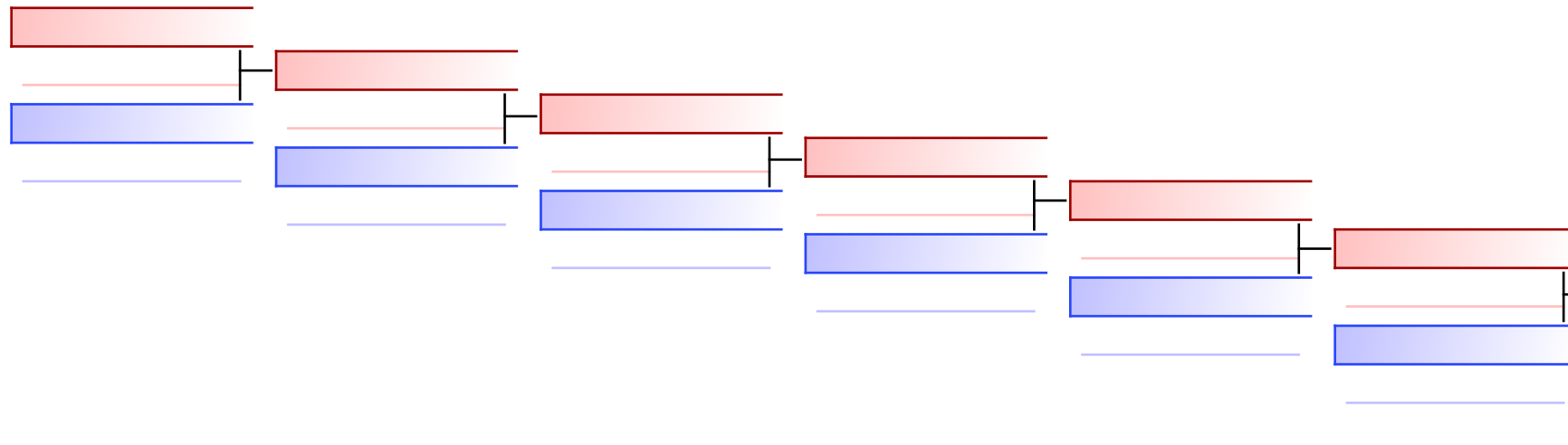

HALEP EMAN (KK VEZIR)
3
 PERKOVIĆ BARTOL (KK NOVI ZAGREB)
4
 PERKOVIĆ BARTOL (KK NOVI ZAGREB)

REPECHAGE: (1)

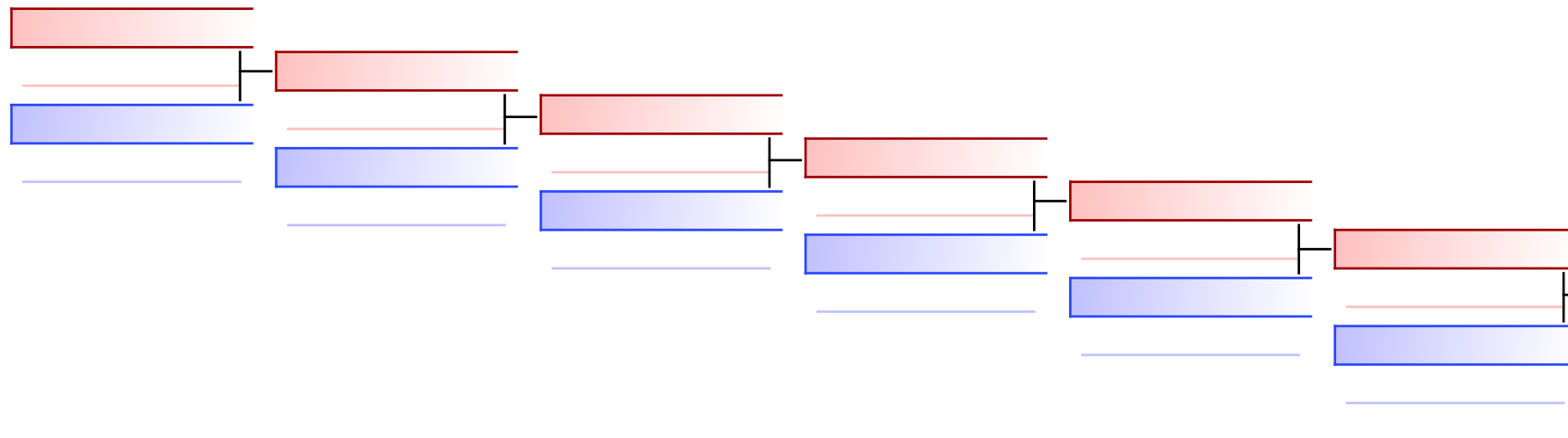

BUTURAJAC MARK (KARLOVAC)
2
 BUTURAJAC MARK (KARLOVAC)
0
 NOVAK LEON (GLOBUS)

Referees:							
-----------	--	--	--	--	--	--	--

KUMITE BOYS 9-10 YEARS -39kg

31ST KARATE GRAND PRIX CROATIA

2023-01-22

Tatami
6 16:05

Pool
1

(c)sportdata GmbH & Co KG 2000-2023 (2023-01-22 22:22) v 10.0.0 build 1 (2023-01-19) License: Online_Event_ID-6798_31STKARATEGRANDPRIXCROATIA (expire 2023-02-05)

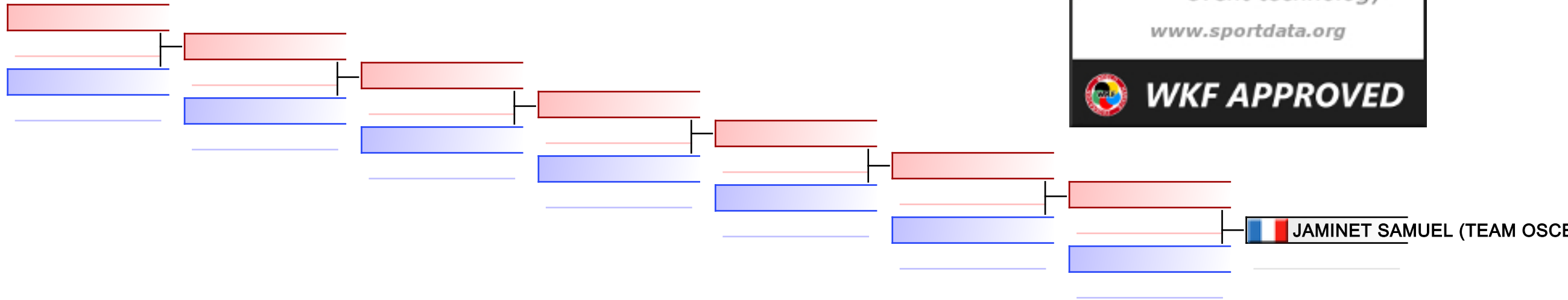

REPECHAGE: (1)

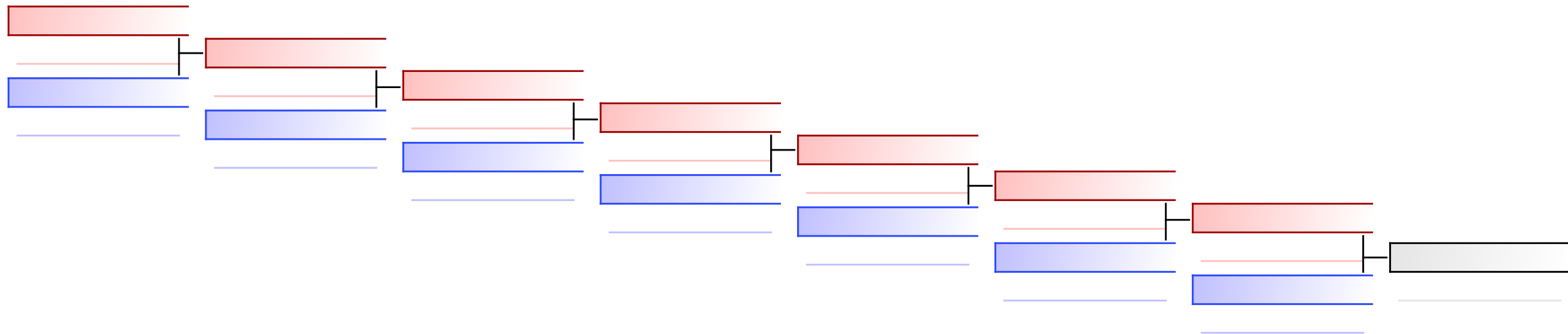

Referees:							
-----------	--	--	--	--	--	--	--

Kumite female Cadets +61kg

31ST KARATE GRAND PRIX CROATIA

2023-01-22

Tatami
1 13:20

Pool
1

(c)sportdata GmbH & Co KG 2000-2023 (2023-01-22 22:22) v 10.0.0 build 1 (2023-01-19) License: Online_Event_ID-6798_31STKARATEGRANDPRIXCROATIA (expire 2023-02-05)

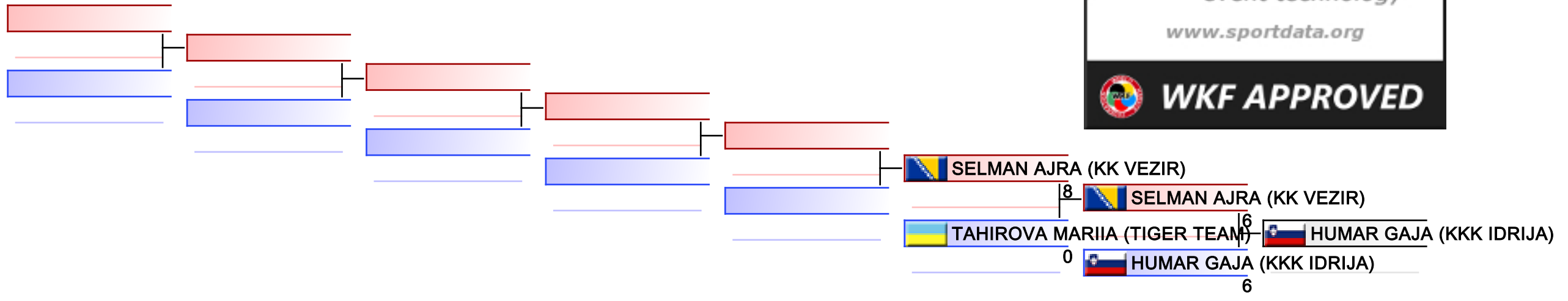

REPECHAGE: (1)

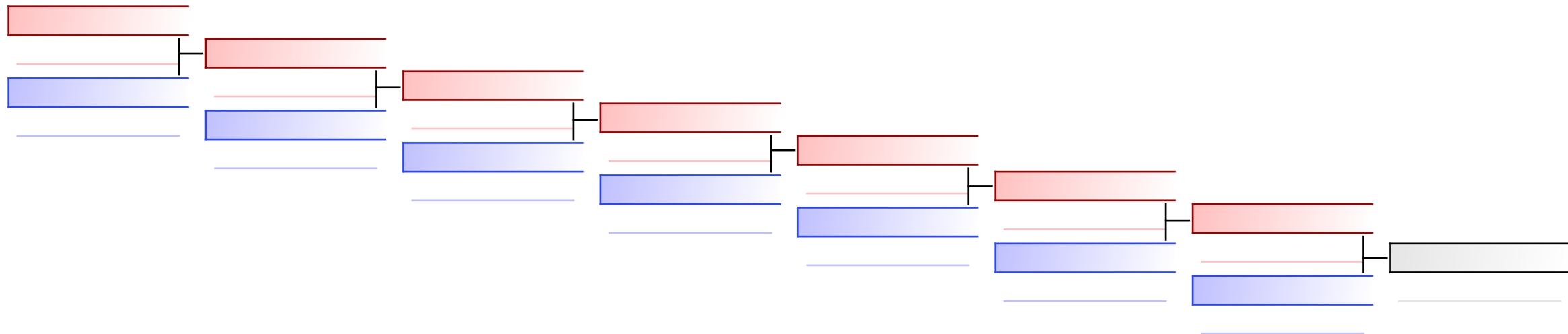

Referees:							
-----------	--	--	--	--	--	--	--

Pool winner-Kumite male juniors +76kg

31ST KARATE GRAND PRIX CROATIA, CITY SPORTS HALL SAMOBOR, ANDRIJE HEBRANGA 26A, SAMOBOR, CROATIA, CRO

Tatami

Pool
1/1

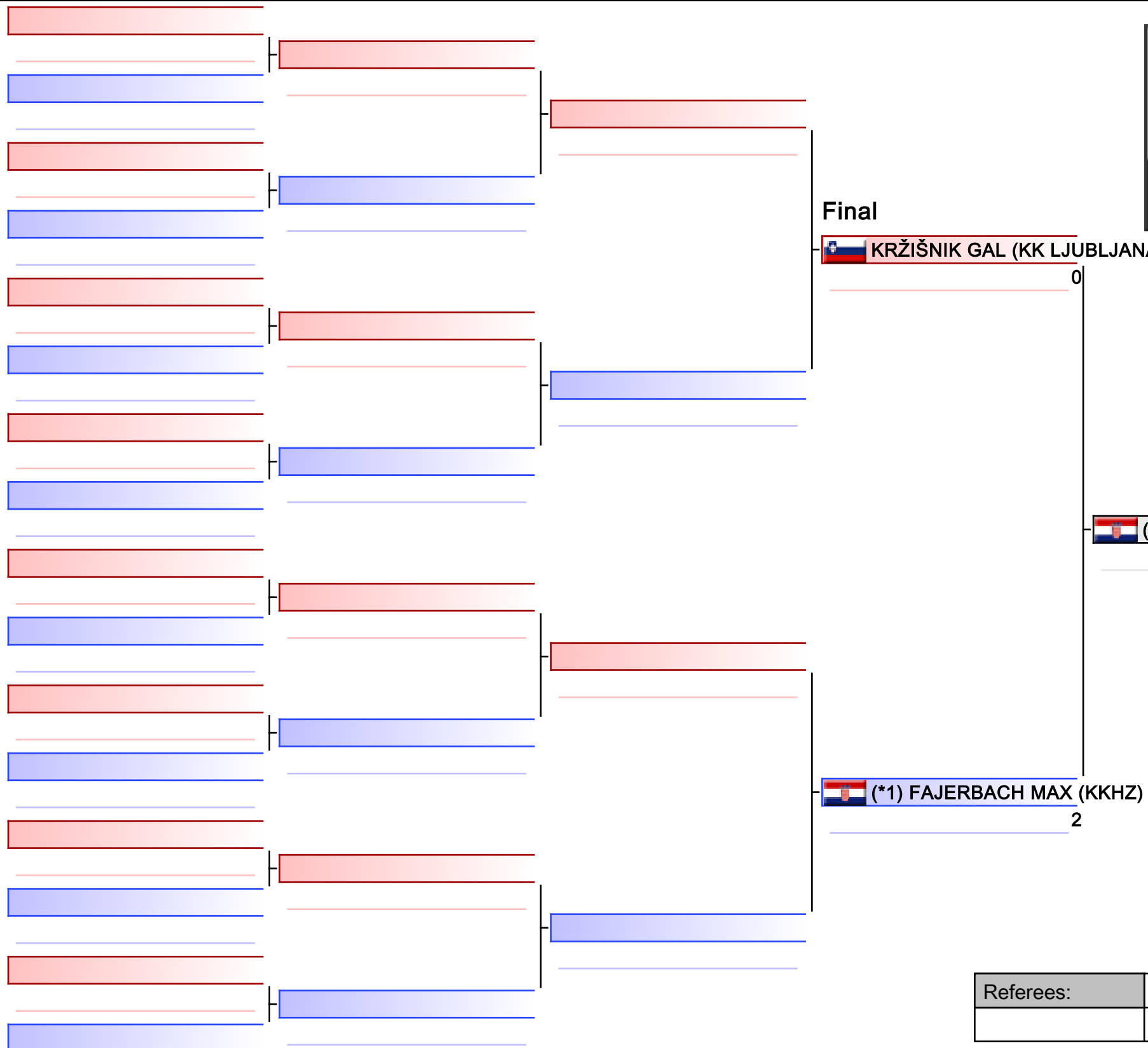

1. FAJERBACH MAX (KKHZ)
2. KRŽIŠNIK GAL (KK LJUBLJANA)
3. ΜΩΠΑΪΤΗΣ ΝΙΚΟΛΑΟΣ (371-ΦΝ68)
3. ČUTURA TONI (KKHD)
5. GONDI NIKOLA (VIROVITICA)
5. JOVANOVIĆ LUKA (KK ŠAMPION)
7. SUPINO FEDERICO (SSD BRACELLI CLUB)
7. MARINO FERNANDO (ITALY)

*Seeded

Referees:			

Pool winner-Kumite male juniors -55kg

31ST KARATE GRAND PRIX CROATIA, CITY SPORTS HALL SAMOBOR, ANDRIJE HEBRANGA 26A, SAMOBOR, CROATIA, CRO

Tatami

Pool
1/1

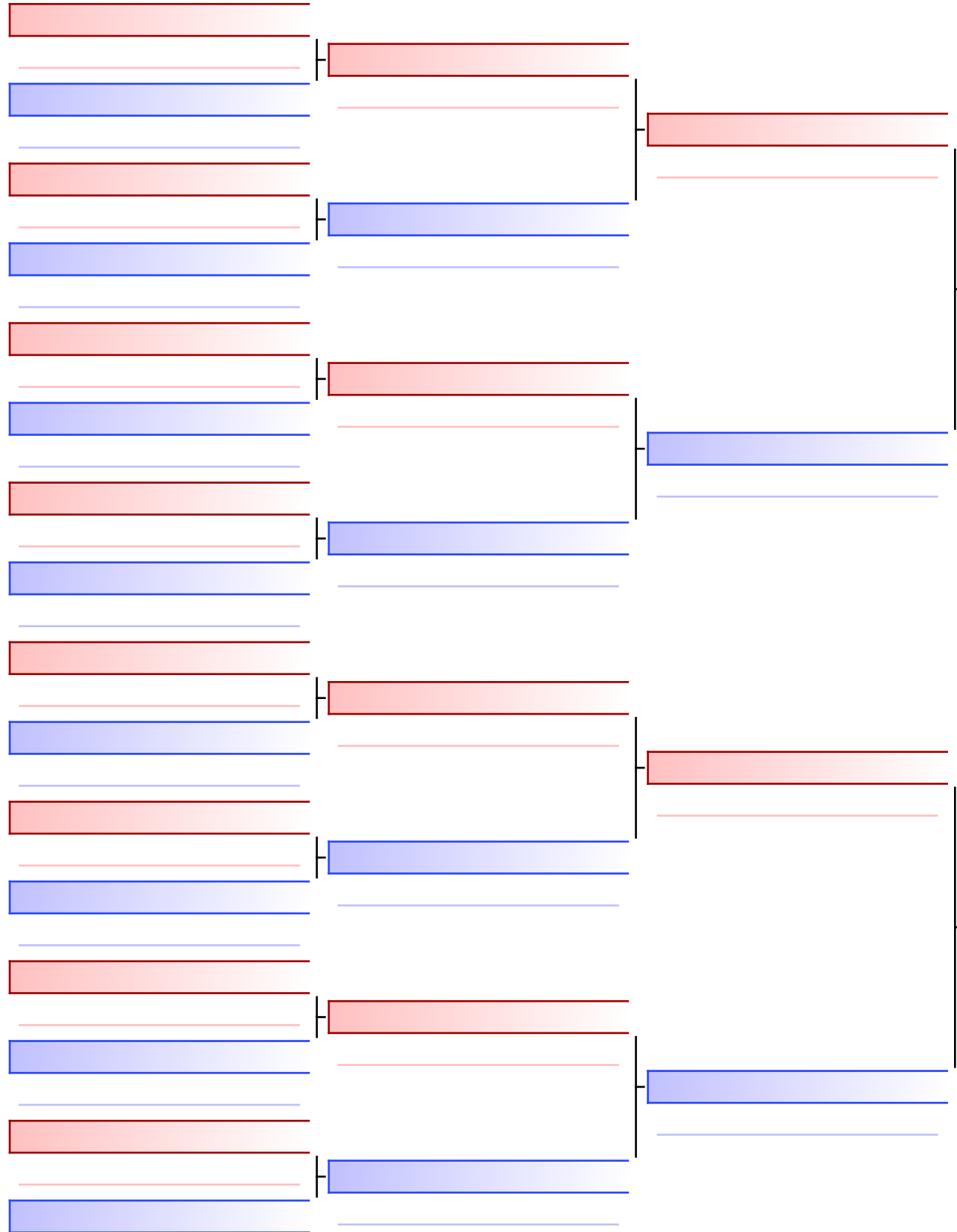

Final

VOJINOVIC BALSJA (MONTENEGRO)

1

VOJINOVIC BALSJA (MONTENEGRO)

CAPMOALE ALEXANDR (BARS BALTI)

0

- | |
|--|
| 1. VOJINOVIC BALSJA (MONTENEGRO) |
| 2. CAPMOALE ALEXANDR (BARS BALTI) |
| 3. DJURDJIC MARKO (KK BORAC 021) |
| 3. SQUILLANTE GIUDO (ITALY) |
| 5. GRINBERG DAVID (AZKOKAI MAKABI BAT-YAM) |
| 5. DRAŽENVIĆ DAMIAN (KK IPON ZAGREB) |
| 7. IVANOV VELIN (LEVSKI) |
| 7. DE_STEFANO EMANUELE (SHIZOKU KRT AV) |

*Seeded

Referees:			

Pool winner-Kumite male juniors -61kg

31ST KARATE GRAND PRIX CROATIA, CITY SPORTS HALL SAMOBOR, ANDRIJE HEBRANGA 26A, SAMOBOR, CROATIA, CRO

Tatami

Pool
1/1

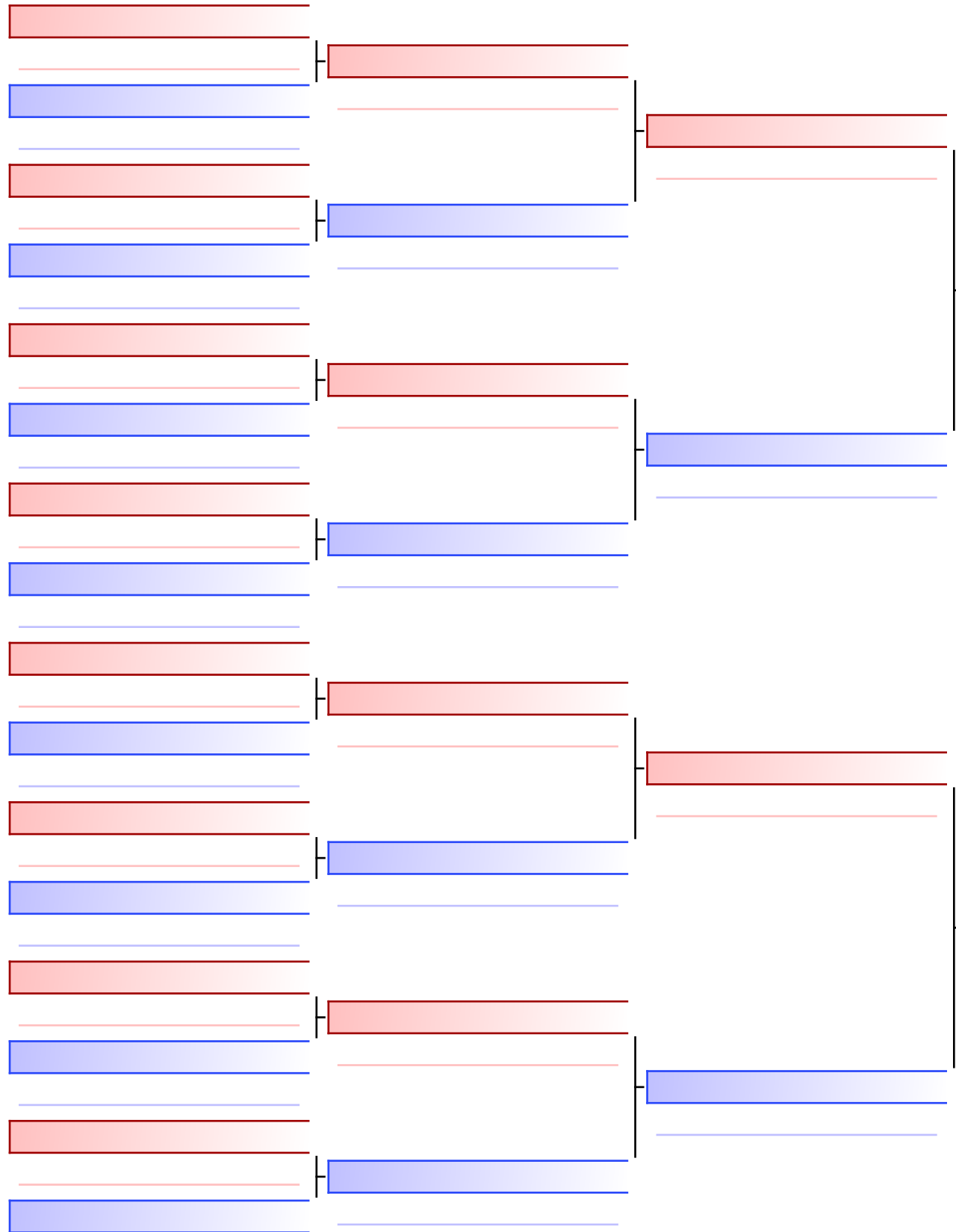

Final

БЕЛИСТОЈАНОСКИ МАТЕЈ (ОЛИМПИК СПОРТ 2007 - СКОПЈЕ)

3

БЕЛИСТОЈАНОСКИ МАТЕЈ (ОЛИМПИК СПОРТ 2007 - СКОПЈЕ)

ПАНЧУК АРТЕМ (ТИГЕР ТЕАМ)

0

1. БЕЛИСТОЈАНОСКИ МАТЕЈ (ОЛИМПИК СПОРТ 2007 - СКОПЈЕ)
2. ПАНЧУК АРТЕМ (ТИГЕР ТЕАМ)
3. НАТЕСКИ МАТИЈА (КК НОВИ ЗАГРЕБ)
3. БУКОВИЋ НОРБЕРТ (СВК)
5. БЈЕЛАЈАК ОГНЈЕН (МОНТЕНЕГРО)
5. РУФИНИ САМУЕЛЕ (ТКР)
7. КОЛОДИЕЗНИЈ ДАНЫЛО (САНДИЈА)
7. ГИОРДАНО ФАБРИЗИО (ИТАЛИЈА)

***Seeded**

Referees:			

Pool winner-Kumite male juniors -68kg

31ST KARATE GRAND PRIX CROATIA, CITY SPORTS HALL SAMOBOR, ANDRIJE HEBRANGA 26A, SAMOBOR, CROATIA, CRO

Tatami

Pool
1/1

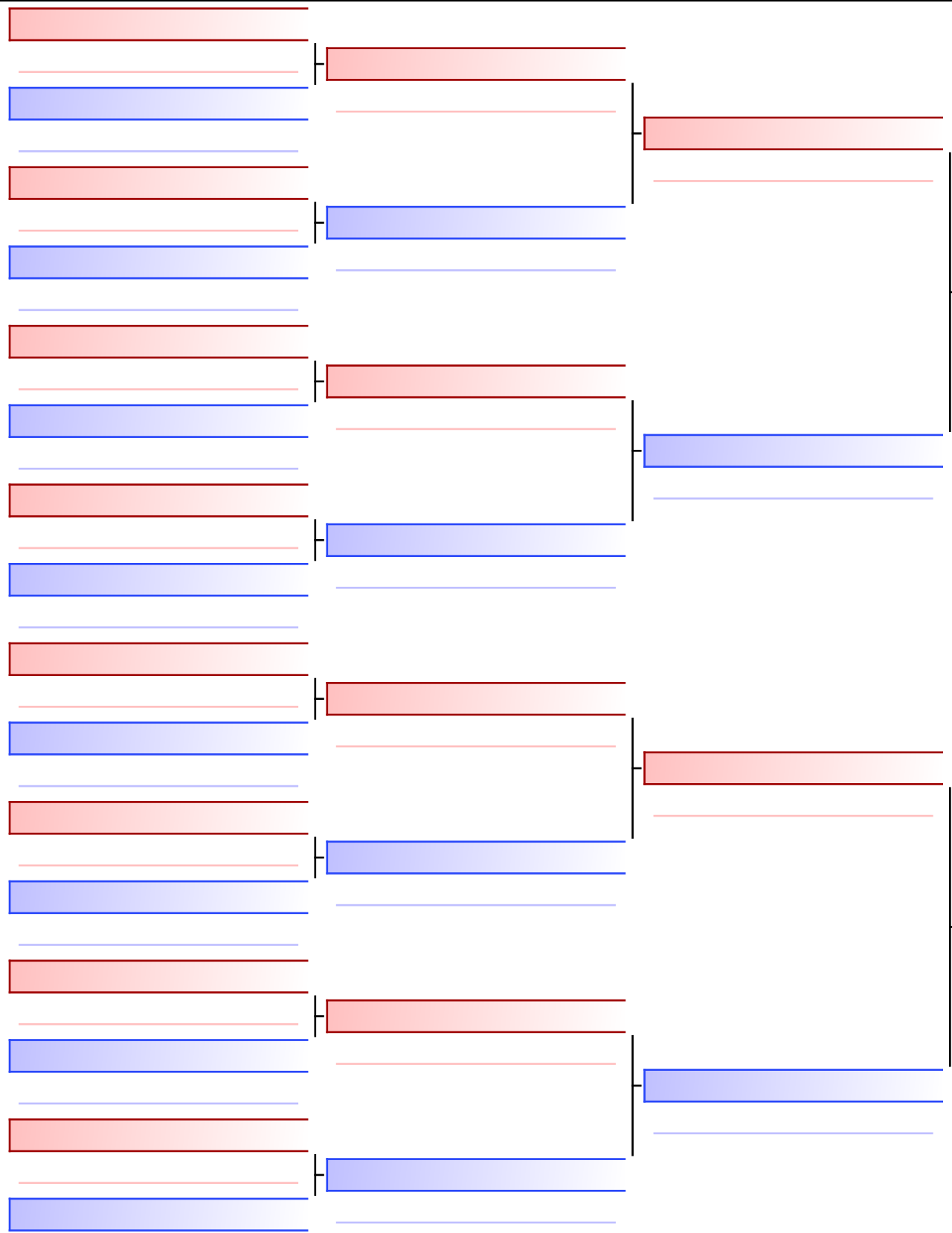

Final

DANILOVIC ANDRIJA (MONTENEGRO)

0

DANILOVIC ANDRIJA (MONTENEGRO)

PITSUL HEORHII (ASC)

0

1. DANILOVIC ANDRIJA (MONTENEGRO)
2. PITSUL HEORHII (ASC)
3. CALIFANO PIETRO_PIO (ITALY)
3. ŽIBRET BOR (KK LJUBLJANA)
5. PALJEVAC SINAN (SAMPIONI)
5. KOVÁČ SIMON (CMK BB)
7. ZRNIĆ MIHAJLO (ENERGIJA)
7. SEREDA YEVGENIY (SENBIN)

*Seeded

Referees:			

Pool winner-Kumite male juniors -76kg

31ST KARATE GRAND PRIX CROATIA, CITY SPORTS HALL SAMOBOR, ANDRIJE HEBRANGA 26A, SAMOBOR, CROATIA, CRO

Tatami

Pool
1/1

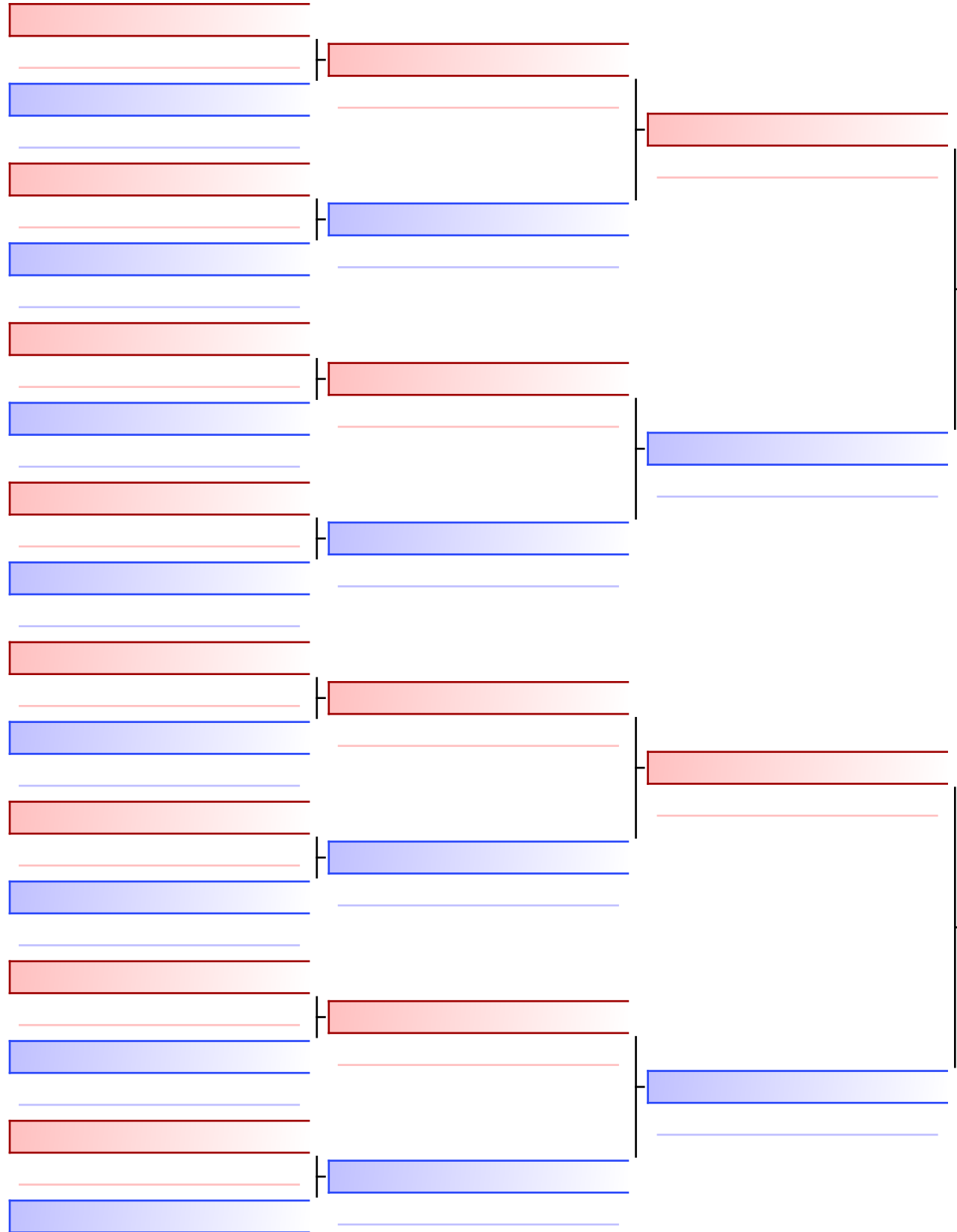

Final

IANNUZZI MARIO (SHIZOKU KRT AV)

5

IANNUZZI MARIO (SHIZOKU KRT AV)

LOZANOVSKI DIMITAR (MAKPETROL MKD)

1

1. IANNUZZI MARIO (SHIZOKU KRT AV)
2. LOZANOVSKI DIMITAR (MAKPETROL MKD)
3. MILETA TOMA (KKŠ1066)
3. SALJIU EMRE (MONTENEGRO)
5. SINANOVIĆ FARIS (KBS TUZLA)
5. BOZZI ANDREA (ASD ESERCITO - 187 FOLGOR)
7. BOŽIČ CENE (KKK IDRİJA)
7. SUSA ZIGA (KK ZALEC)

***Seeded**

Referees:			

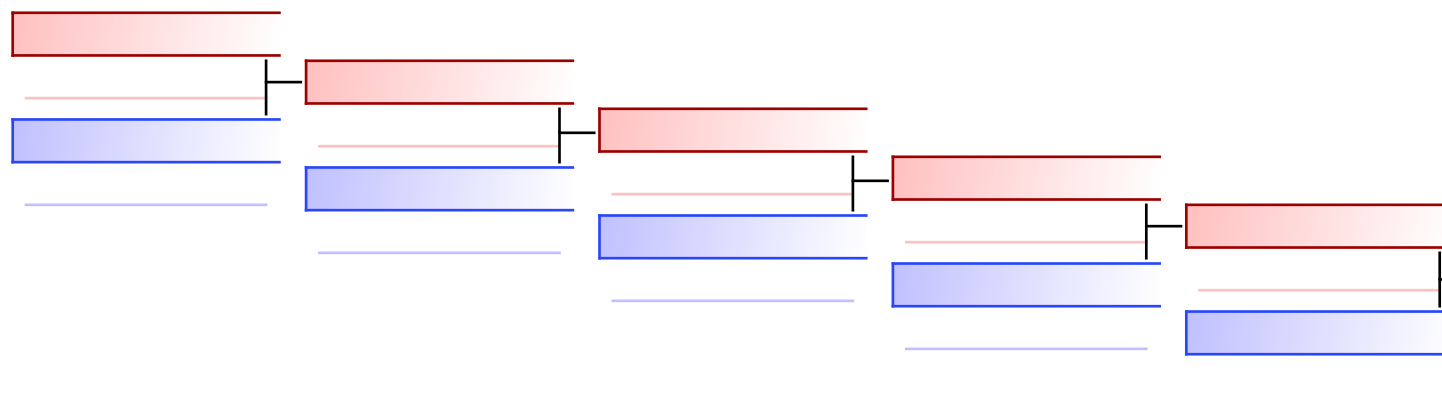

FAZLIĆ KAAN (KK RESPECT)
 027 Heian San. 1

CESAR JAN (KAPTOL)
 028 Heian Yon. 0

CESAR JAN (KAPTOL)
 029 Heian God. 4

ŠTEFANIČ VAL (KK VELENJE)
 029 Heian God. 5

REPECHAGE: (1)

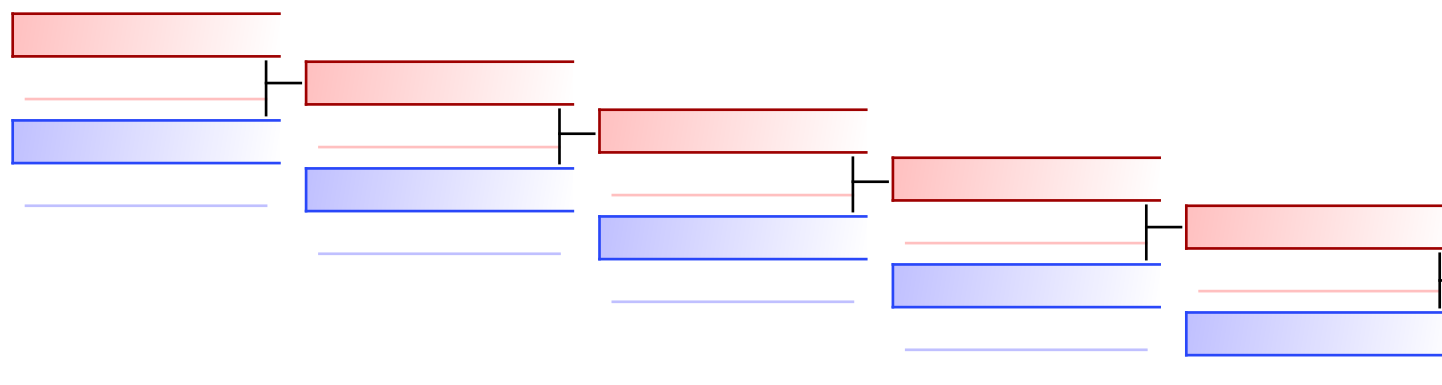

ELIAS WASIM (J.S.S.K)
 029 Heian God. 0

NIKIFOROS MICHAIL (GR_482)
 029 Heian God. 4

NIKIFOROS MICHAIL (GR_482)
 026 Heian Nid. 5

PALKA PATRIK (SSK BA)
 074 Pinan God. 1

Referees:							
-----------	--	--	--	--	--	--	--

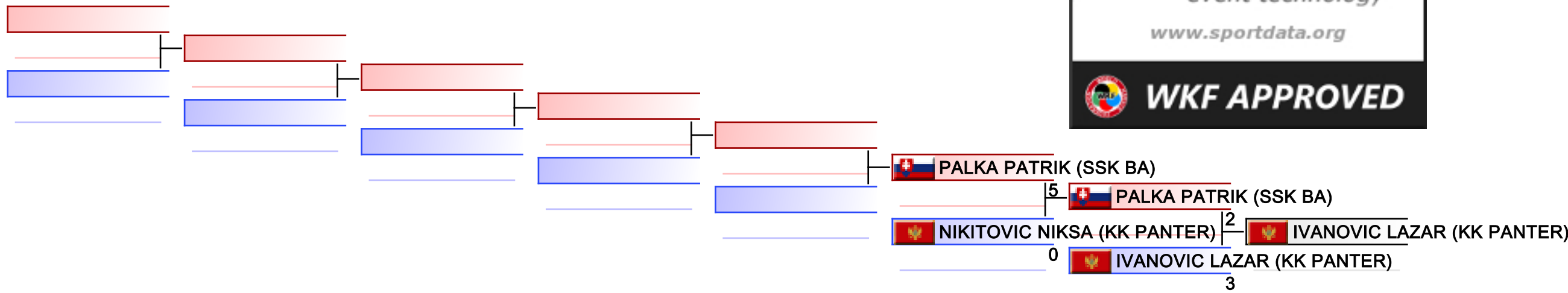

REPECHAGE: (1)

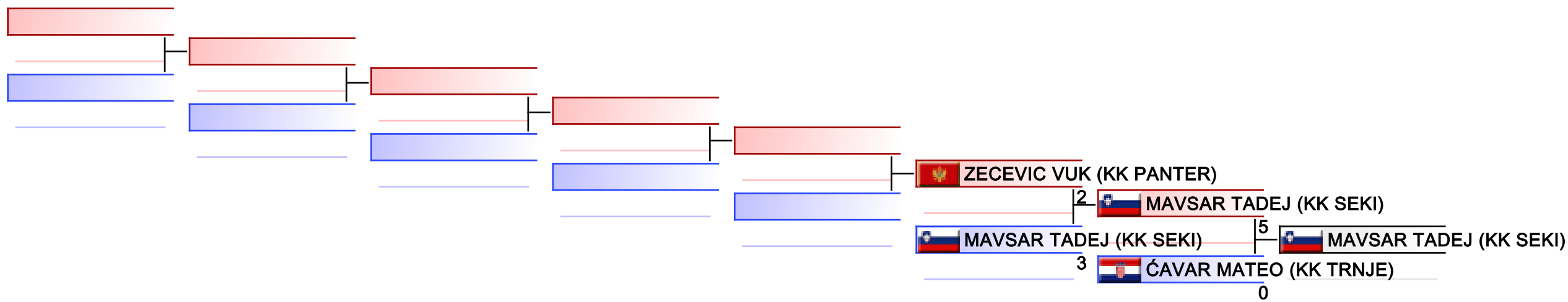

Referees:							
-----------	--	--	--	--	--	--	--

KATA BOYS 12 YEARS
31ST KARATE GRAND PRIX CROATIA

2023-01-22

Tatami
4 08:30

Pool
1

(c)sportdata GmbH & Co KG 2000-2023 (2023-01-22 22:22) v 10.0.0 build 1 (2023-01-19) License: Online_Event_ID-6798_31STKARATEGRANDPRIXCROATIA (expire 2023-02-05)

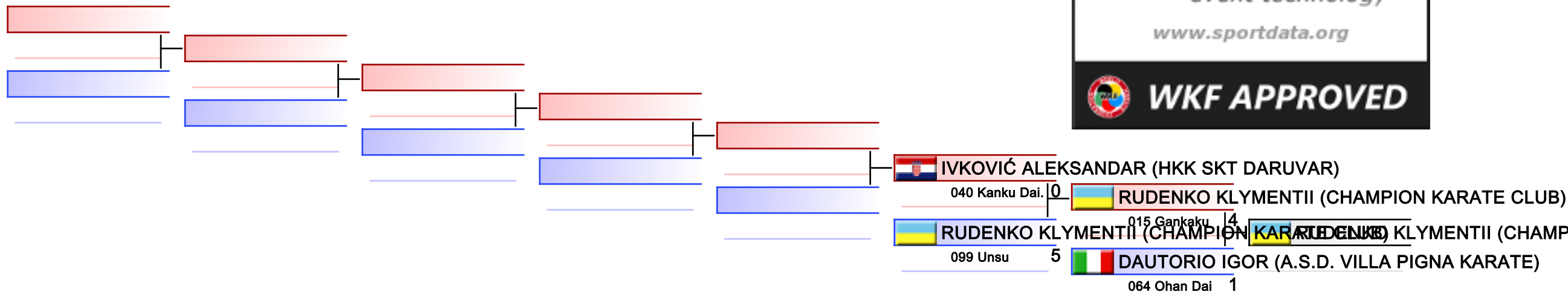

REPECHAGE: (1)

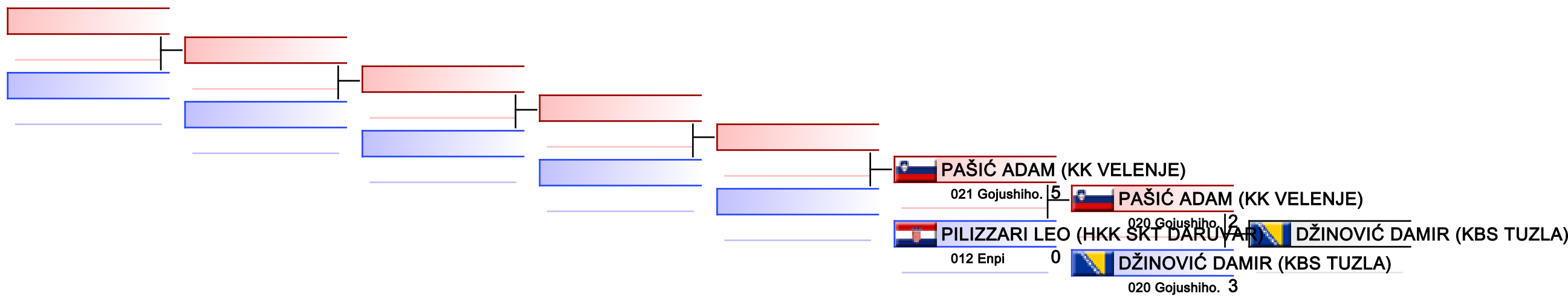

Referees:							
-----------	--	--	--	--	--	--	--

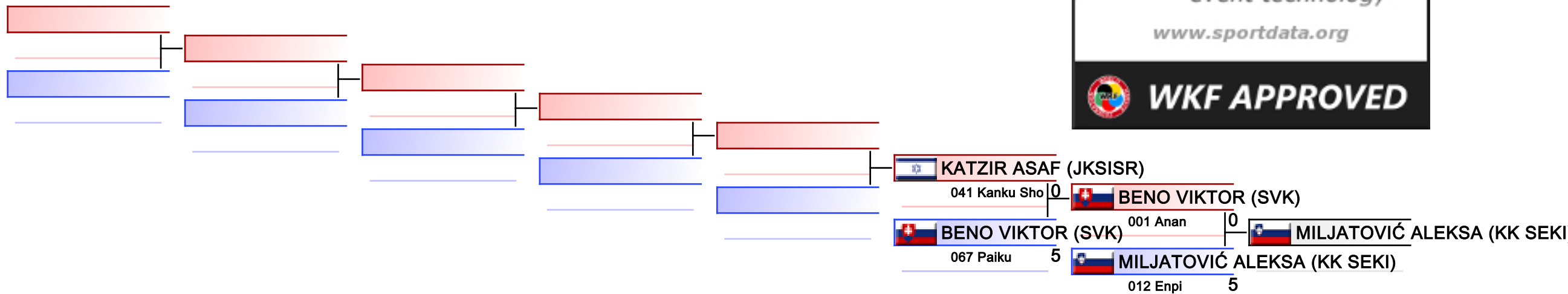

REPECHAGE: (1)

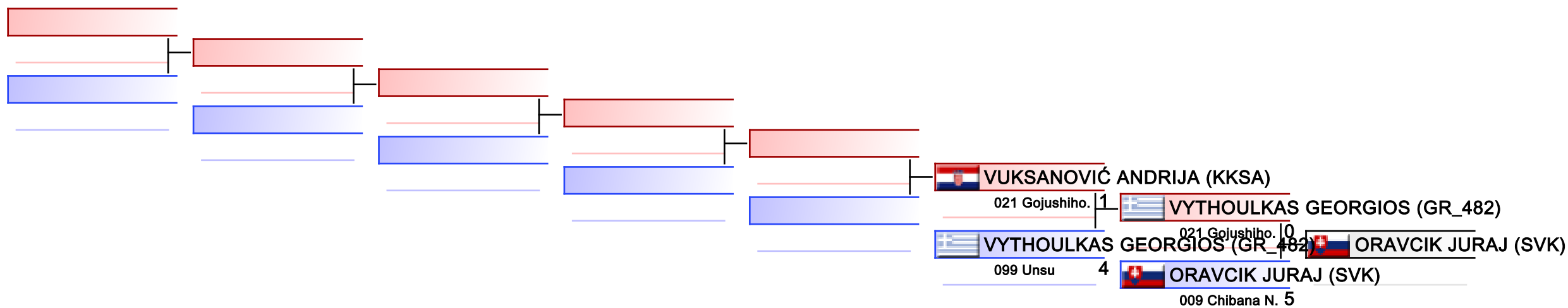

Referees:							
-----------	--	--	--	--	--	--	--

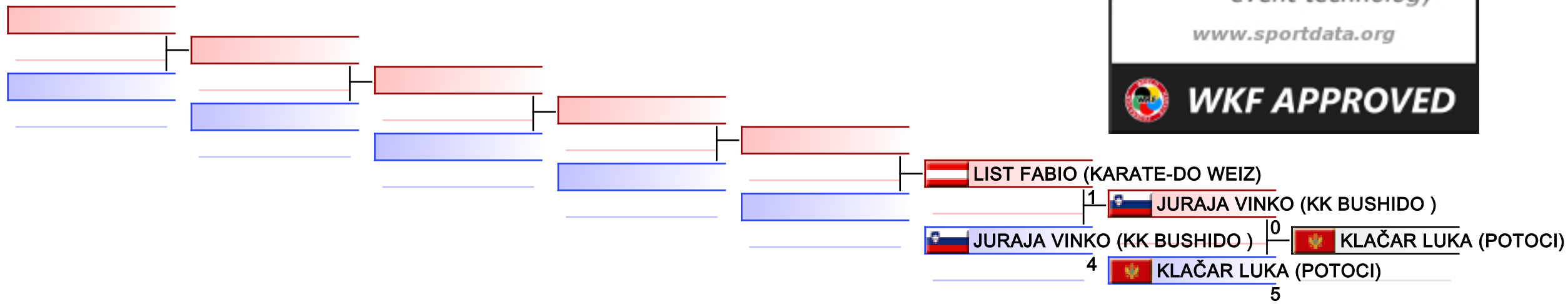

REPECHAGE: (1)

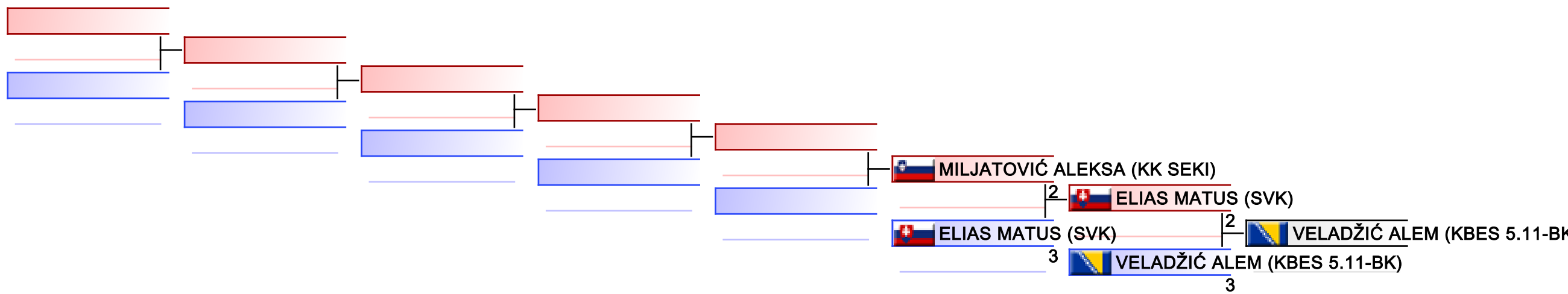

Referees:							
-----------	--	--	--	--	--	--	--

Kumite female Cadets +61kg

31ST KARATE GRAND PRIX CROATIA

2023-01-22

Tatami
2 13:25

Pool
2

(c)sportdata GmbH & Co KG 2000-2023 (2023-01-22 22:22) v 10.0.0 build 1 (2023-01-19) License: Online_Event_ID-6798_31STKARATEGRANDPRIXCROATIA (expire 2023-02-05)

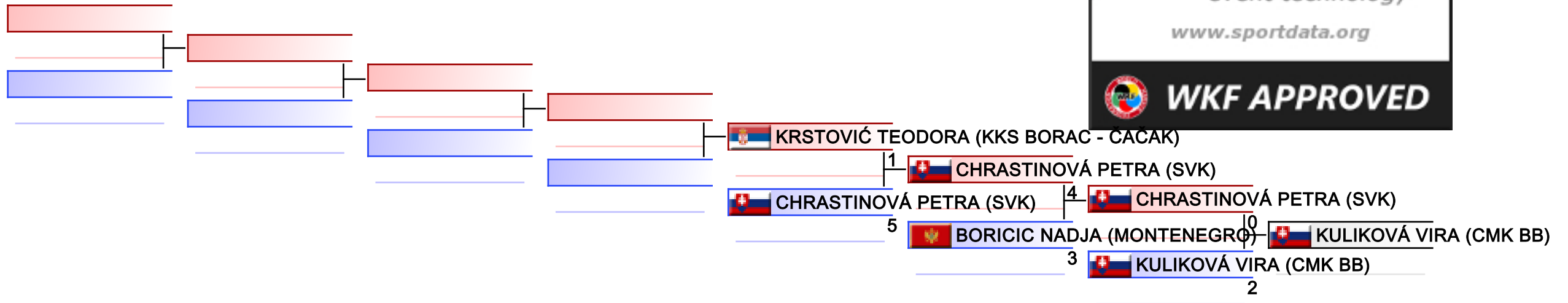

REPECHAGE: (2)

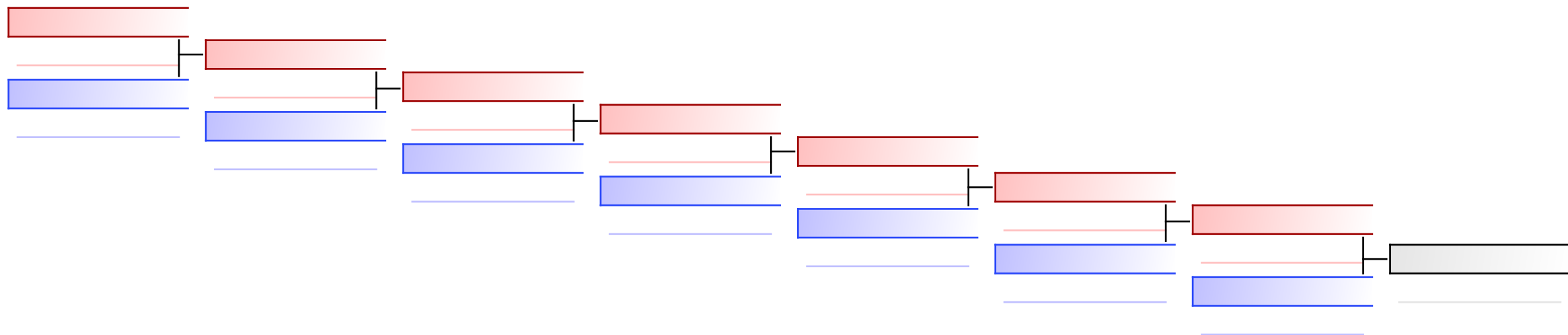

Referees:							
-----------	--	--	--	--	--	--	--

Kumite female cadets -47kg
31ST KARATE GRAND PRIX CROATIA

2023-01-22

Tatami
2 12:10

Pool
2

(c)sportdata GmbH & Co KG 2000-2023 (2023-01-22 22:22) v 10.0.0 build 1 (2023-01-19) License: Online_Event_ID-6798_31STKARATEGRANDPRIXCROATIA (expire 2023-02-05)

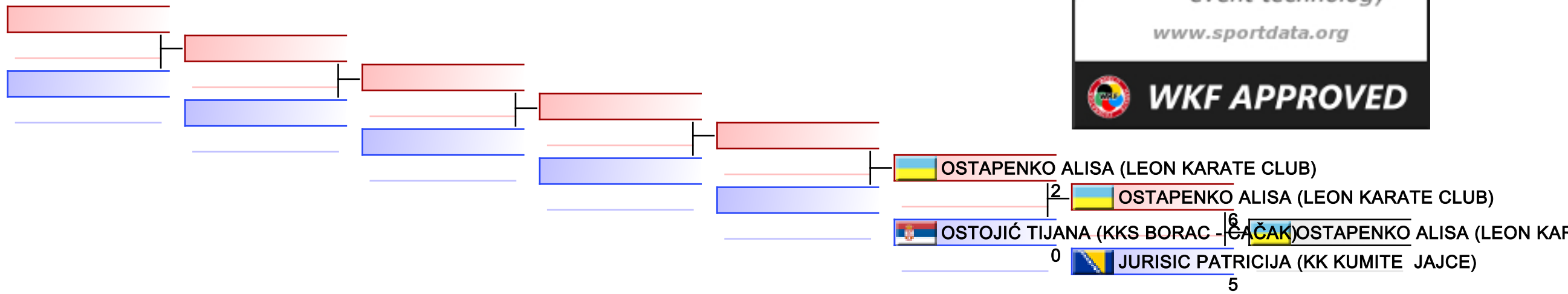

REPECHAGE: (2)

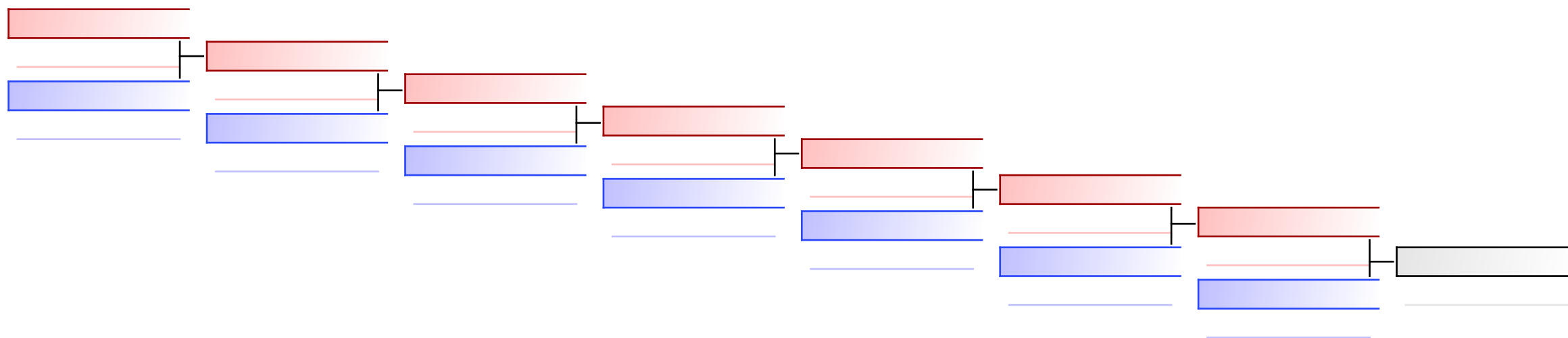

Referees:							
-----------	--	--	--	--	--	--	--

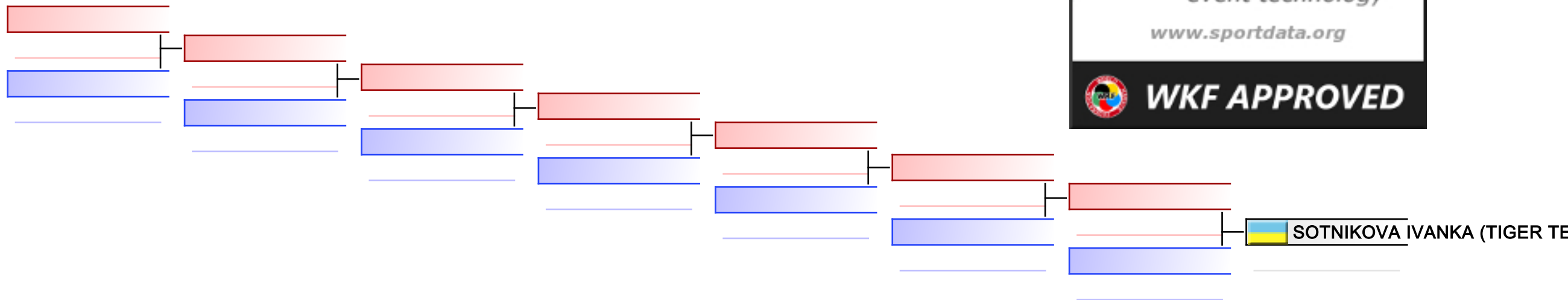

REPECHAGE: (1)

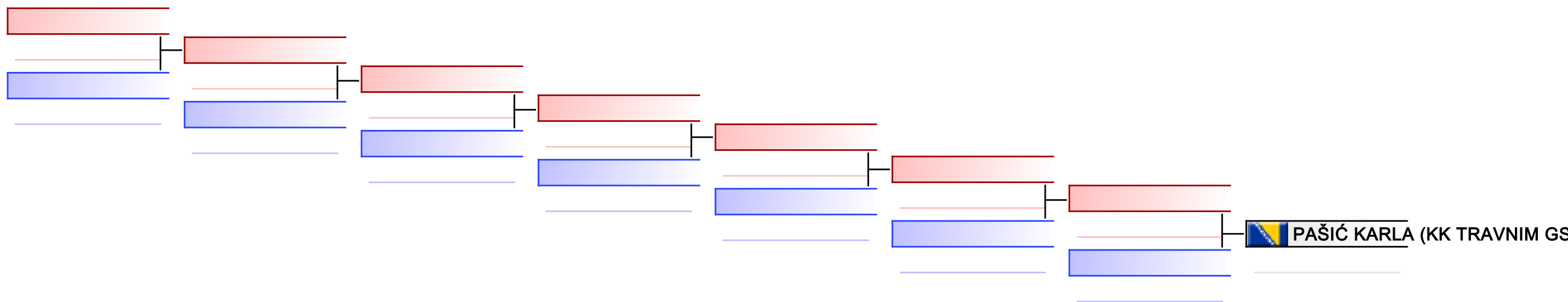

Referees:							
-----------	--	--	--	--	--	--	--

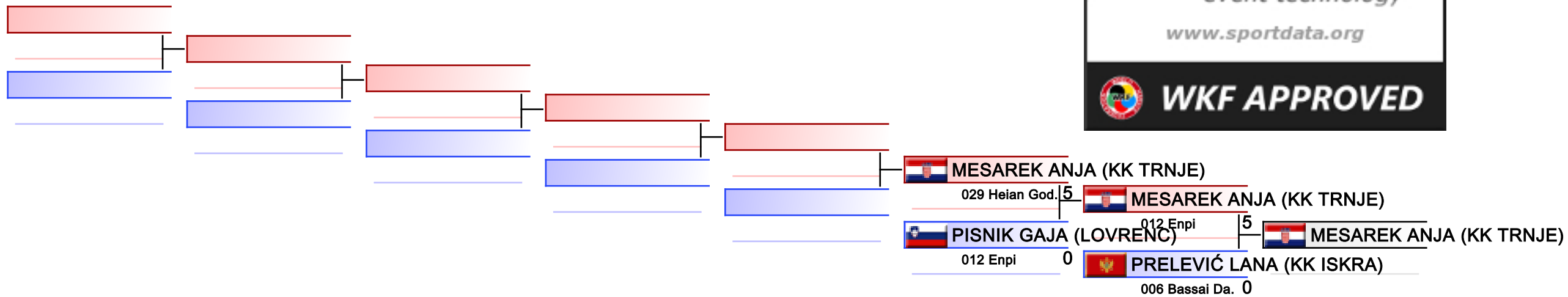

REPECHAGE: (1)

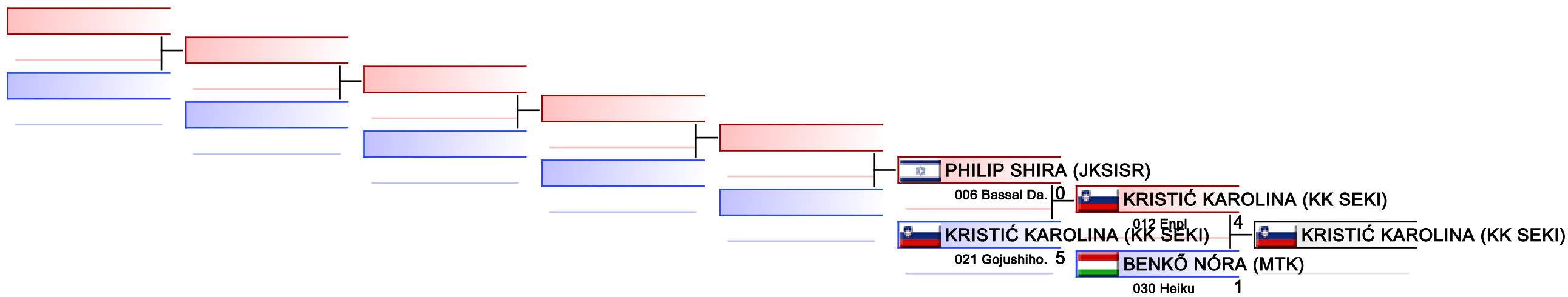

Referees:							
-----------	--	--	--	--	--	--	--

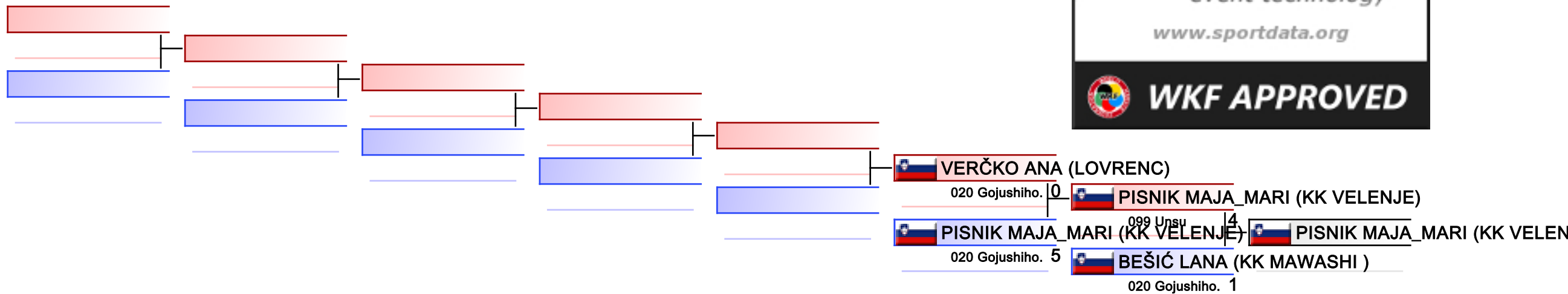

REPECHAGE: (1)

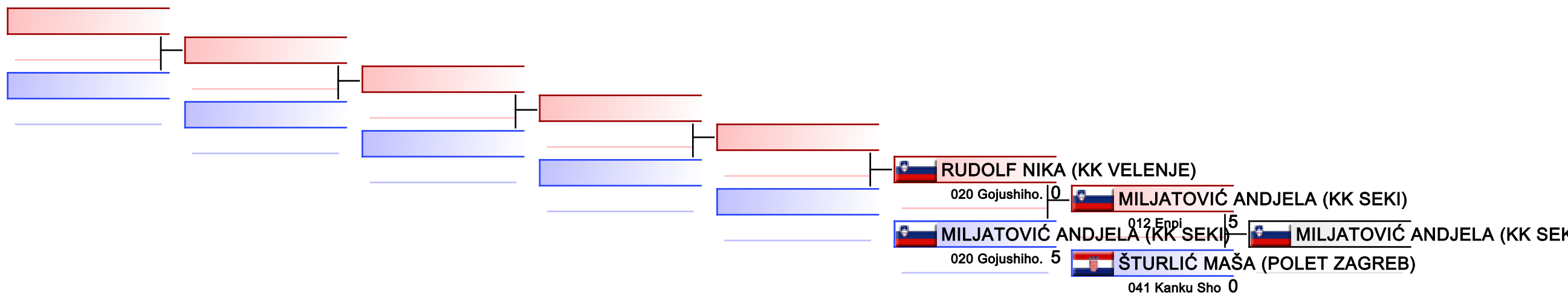

Referees:							
-----------	--	--	--	--	--	--	--

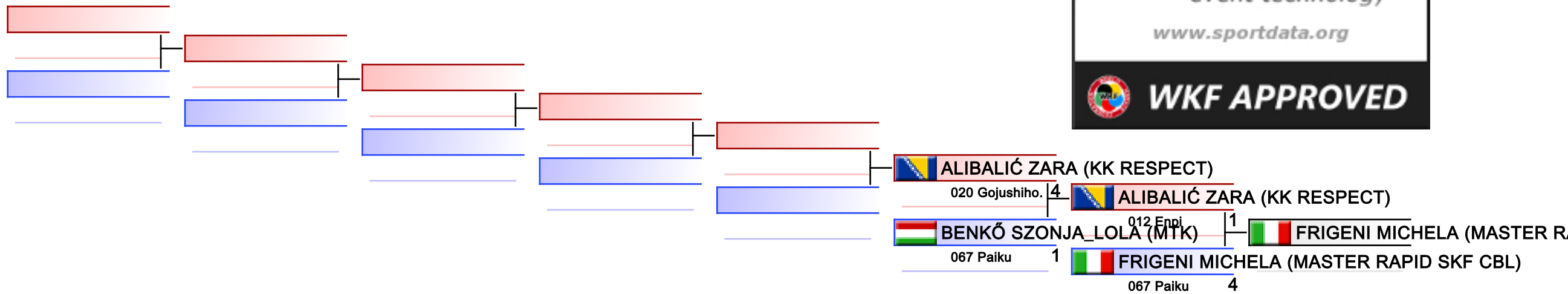

REPECHAGE: (1)

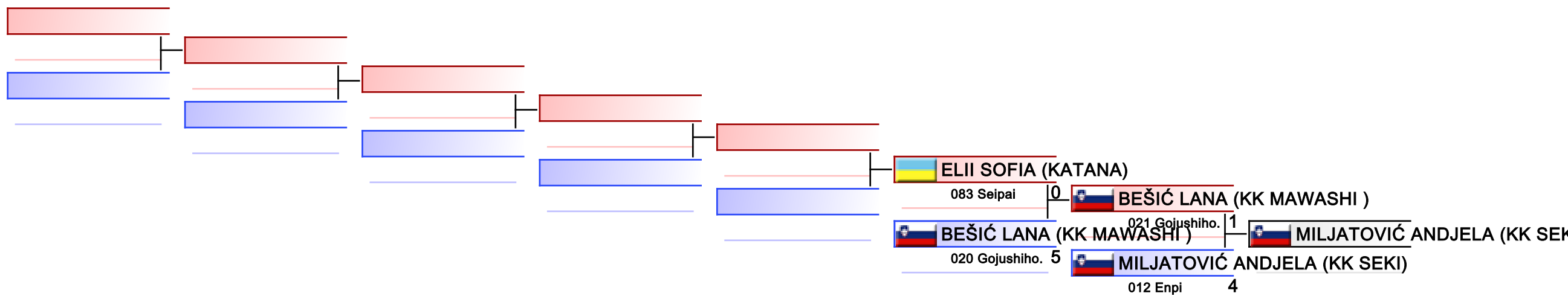

Referees:							
-----------	--	--	--	--	--	--	--

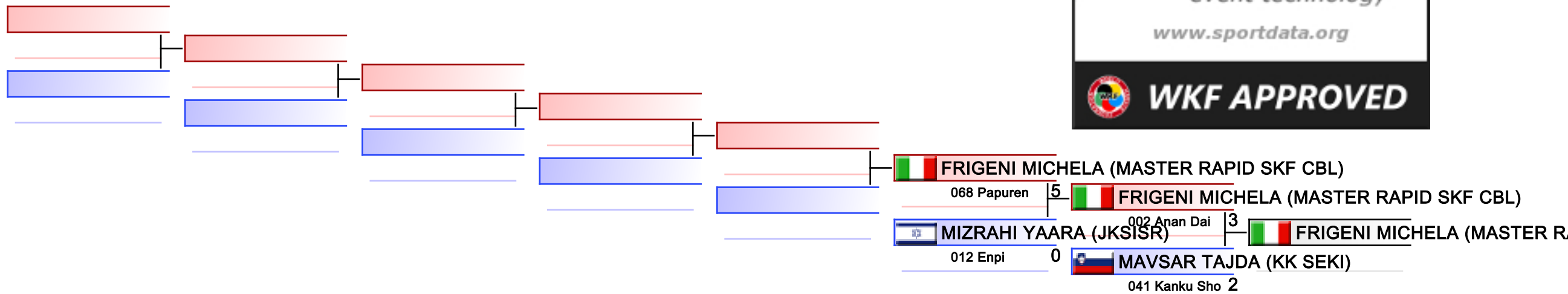

REPECHAGE: (1)

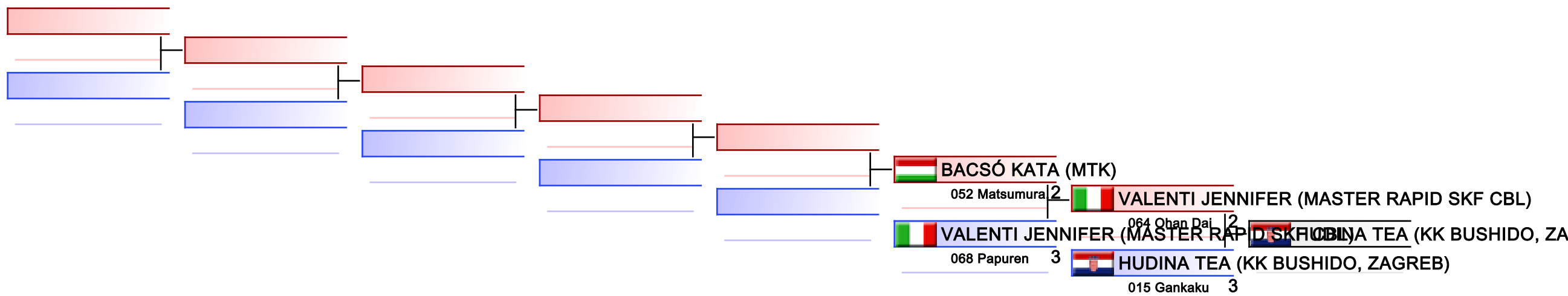

Referees:							
-----------	--	--	--	--	--	--	--

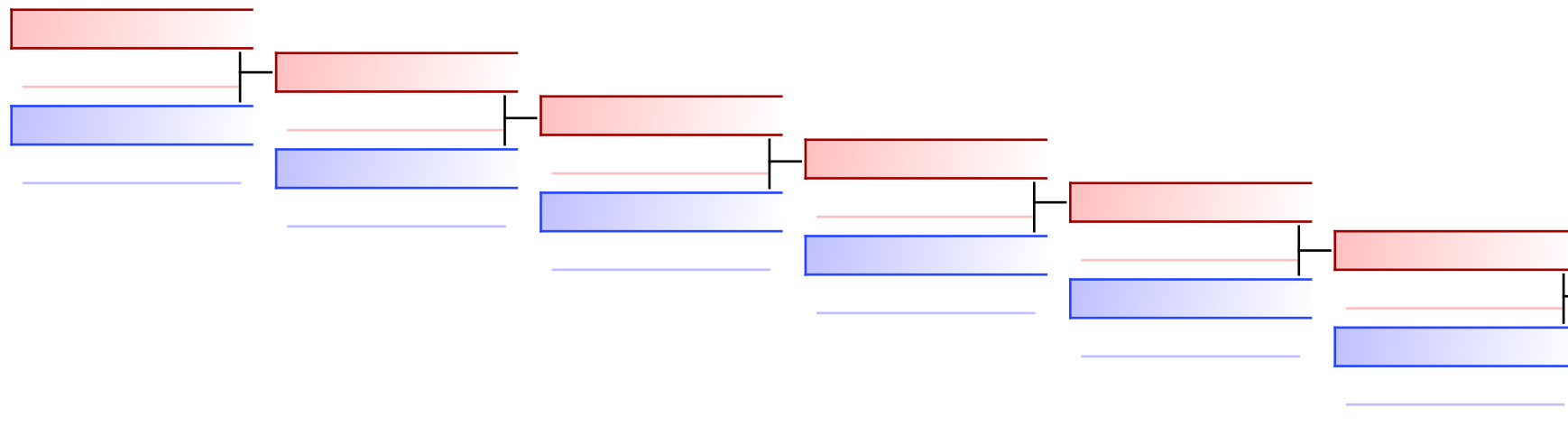

 **BUGANOVA ELA (SSK BA)**
 5
 **BUGANOVA ELA (SSK BA)**
 **GOMBAČ LAURA (KK MAWASHI)**
 0

REPECHAGE: (1)

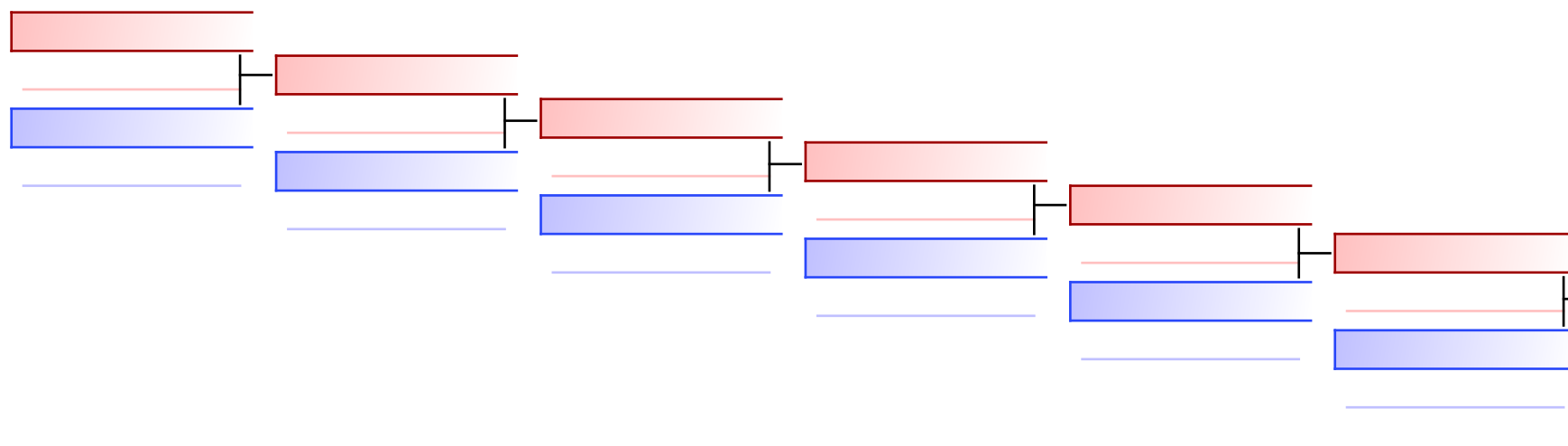

 **VLADIĆ MILA (POLET ZAGREB)**
 3
 **VLADIĆ MILA (POLET ZAGREB)**
 **SREBRE LANA (KK SEKI)**
 2

Referees:							
-----------	--	--	--	--	--	--	--

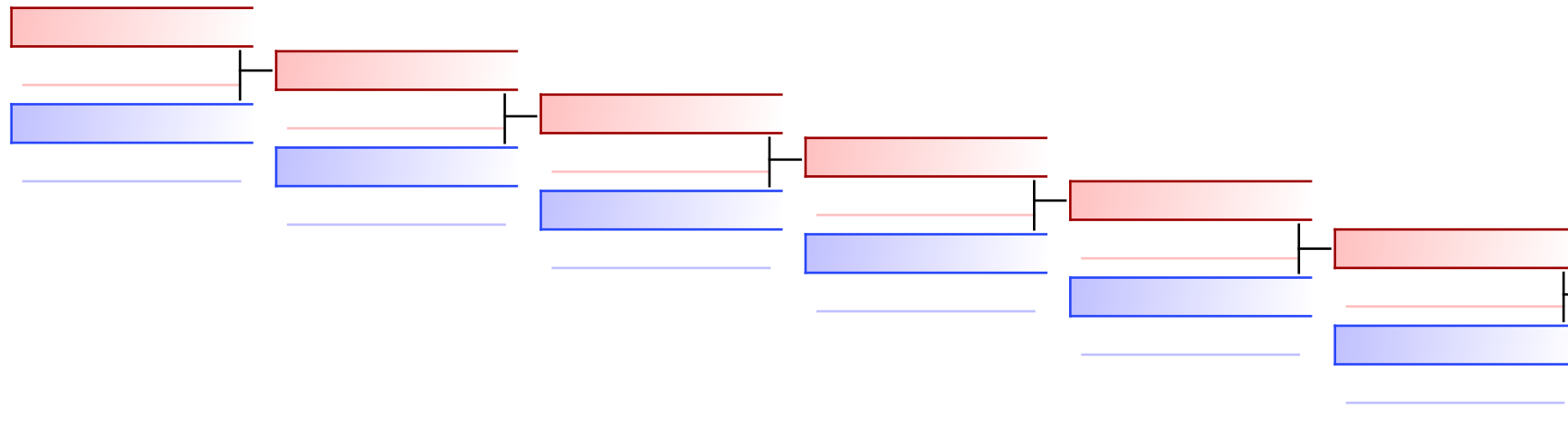

KOSIĆ ANA (KK TEMPO)
ADILOVIC ZAHRA (KK MLADOS)
ADILOVIC ZAHRA (KK MLADOST)

REPECHAGE: (1)

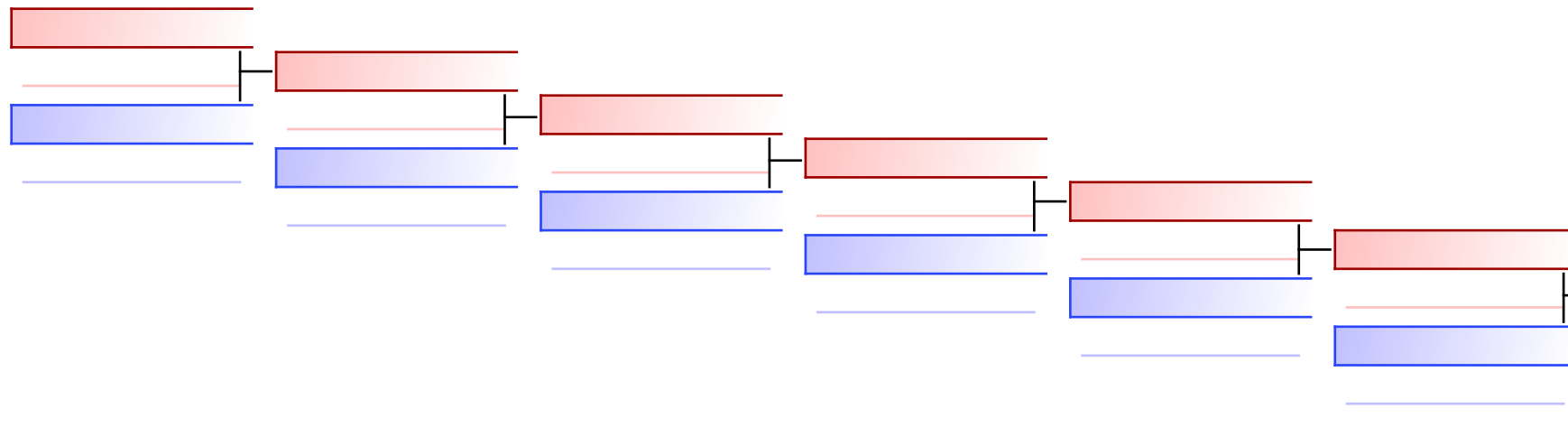

PISNIK SARA (KK VELENJE)
HUSIĆ LANA (KK SEKI)
HUSIĆ LANA (KK SEKI)

Referees:							
-----------	--	--	--	--	--	--	--

Kumite female cadets -47kg
31ST KARATE GRAND PRIX CROATIA

2023-01-22

Tatami
1 12:00

Pool
1

(c)sportdata GmbH & Co KG 2000-2023 (2023-01-22 22:22) v 10.0.0 build 1 (2023-01-19) License: Online_Event_ID-6798_31STKARATEGRANDPRIXCROATIA (expire 2023-02-05)

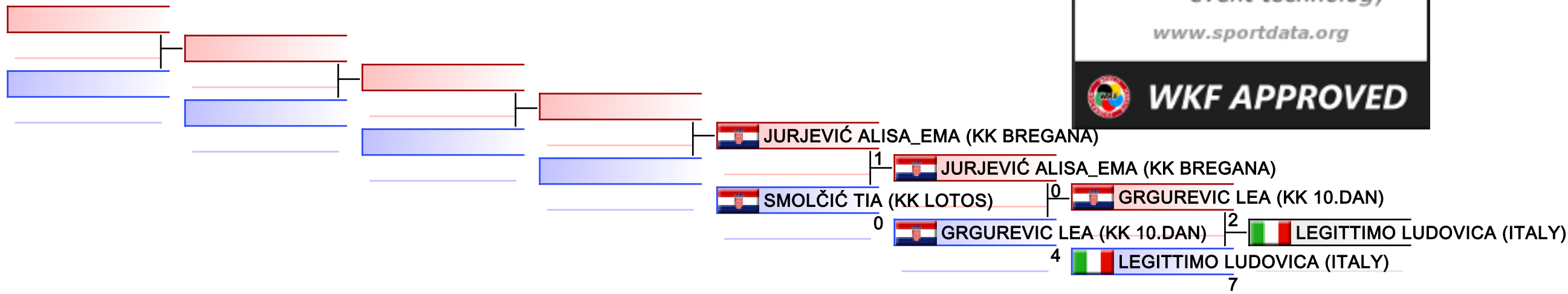

REPECHAGE: (1)

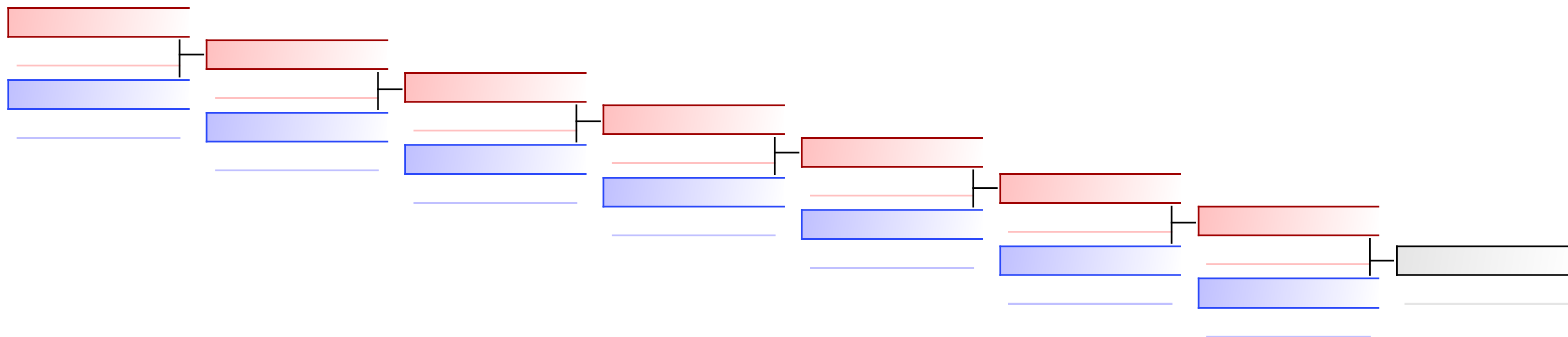

Referees:							
-----------	--	--	--	--	--	--	--

Kumite female cadets -54kg

31ST KARATE GRAND PRIX CROATIA

2023-01-22

Tatami 4 12:40

Pool 2

(c)sportdata GmbH & Co KG 2000-2023 (2023-01-22 22:22) v 10.0.0 build 1 (2023-01-19) License: Online_Event_ID-6798_31STKARATEGRANDPRIXCROATIA (expire 2023-02-05)

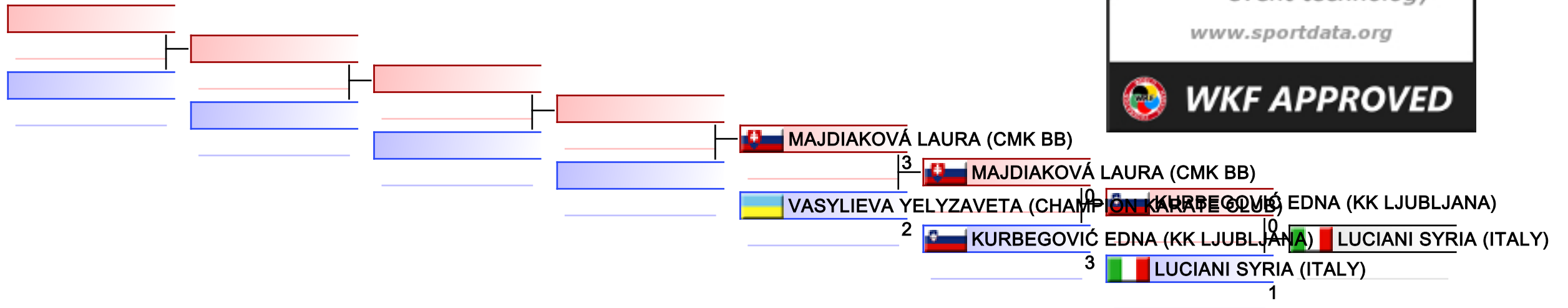

REPECHAGE: (2)

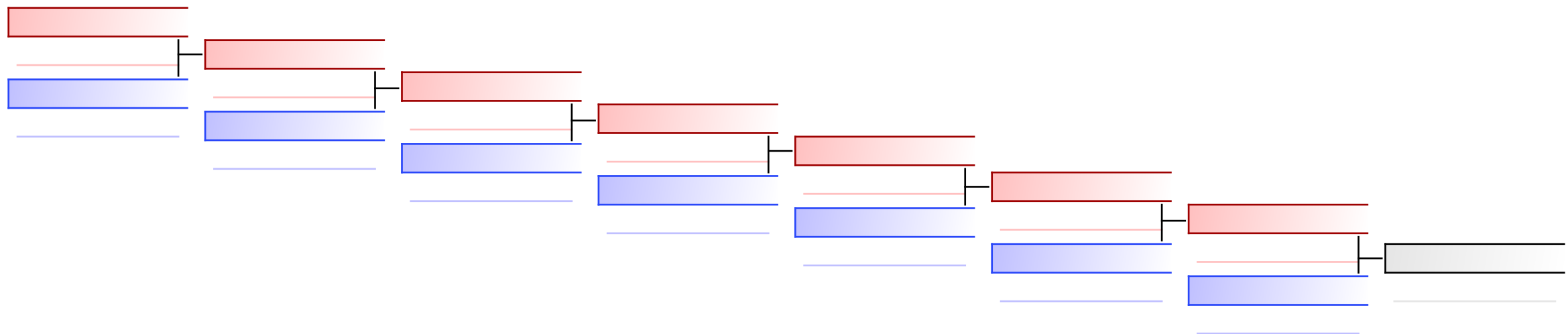

Referees:							
-----------	--	--	--	--	--	--	--

Kumite female cadets -54kg

31ST KARATE GRAND PRIX CROATIA

2023-01-22

Tatami
3 13:00

Pool
1

(c)sportdata GmbH & Co KG 2000-2023 (2023-01-22 22:22) v 10.0.0 build 1 (2023-01-19) License: Online_Event_ID-6798_31STKARATEGRANDPRIXCROATIA (expire 2023-02-05)

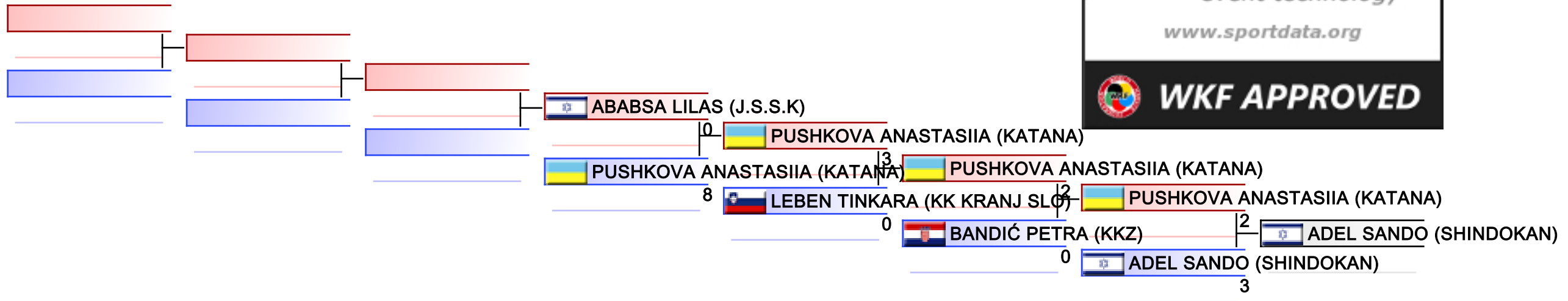

REPECHAGE: (1)

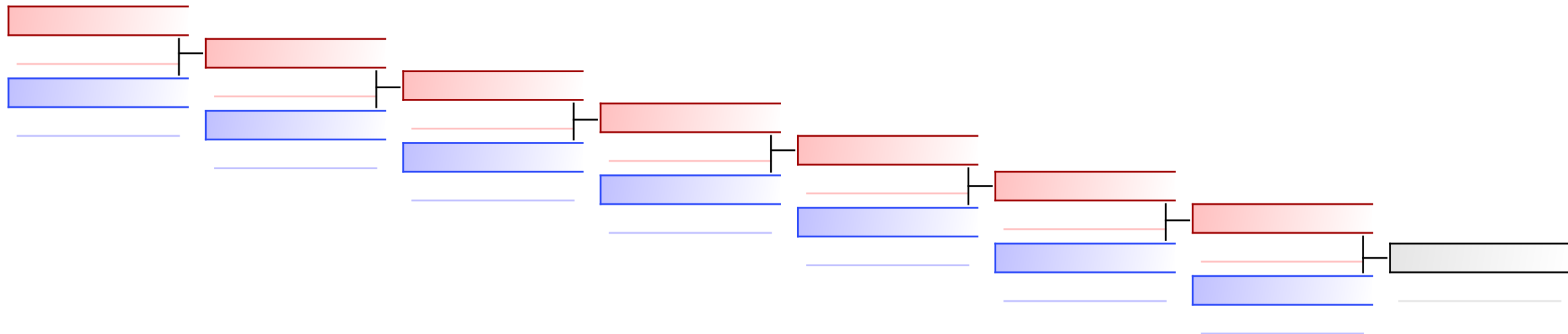

Referees:							
-----------	--	--	--	--	--	--	--

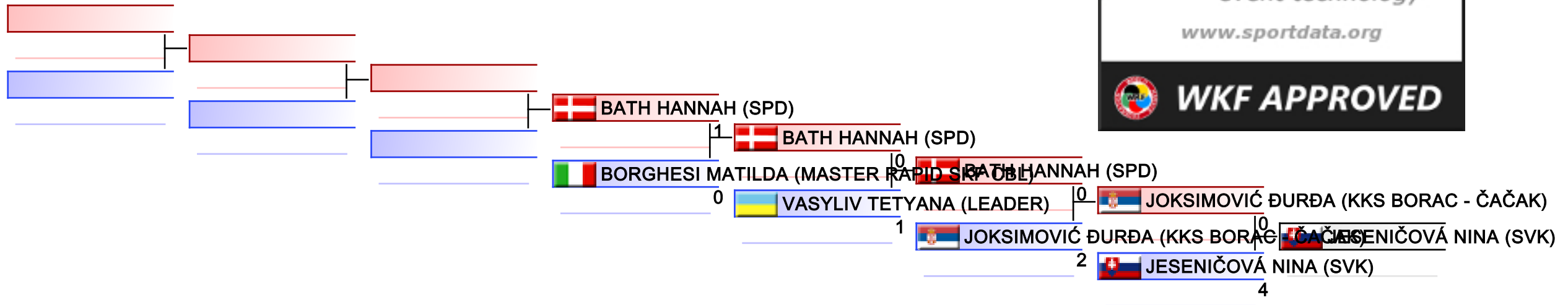

REPECHAGE: (1)

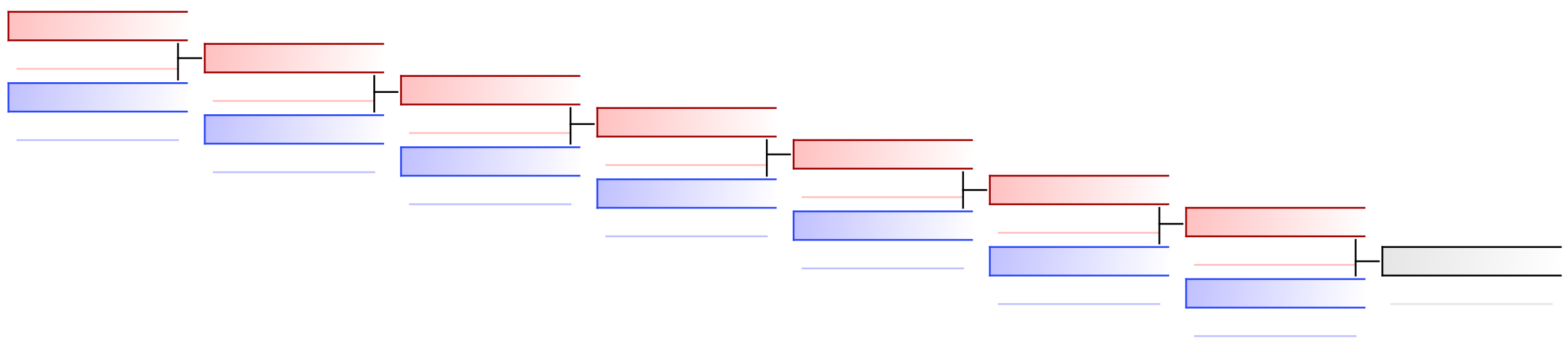

Referees:							
-----------	--	--	--	--	--	--	--

Kumite female Cadets -61kg

31ST KARATE GRAND PRIX CROATIA

2023-01-22

Tatami
6 12:25

Pool
2

(c)sportdata GmbH & Co KG 2000-2023 (2023-01-22 22:22) v 10.0.0 build 1 (2023-01-19) License: Online_Event_ID-6798_31STKARATEGRANDPRIXCROATIA (expire 2023-02-05)

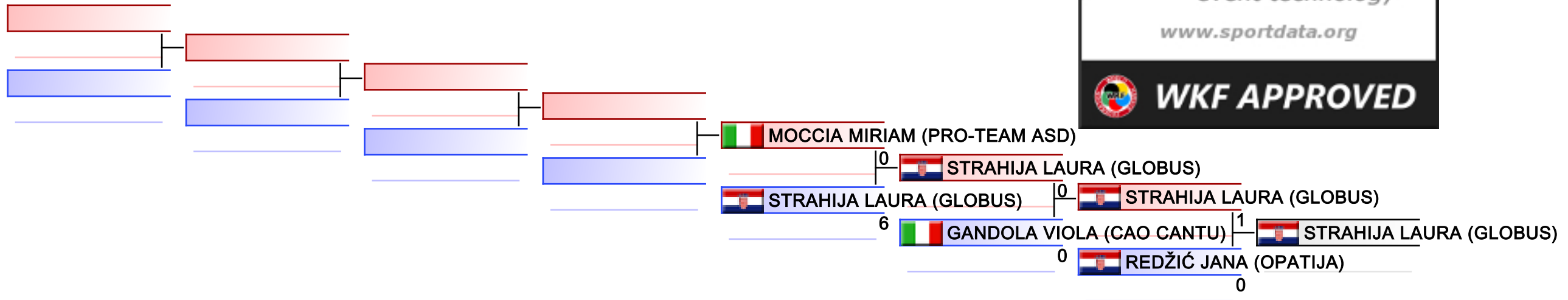

REPECHAGE: (2)

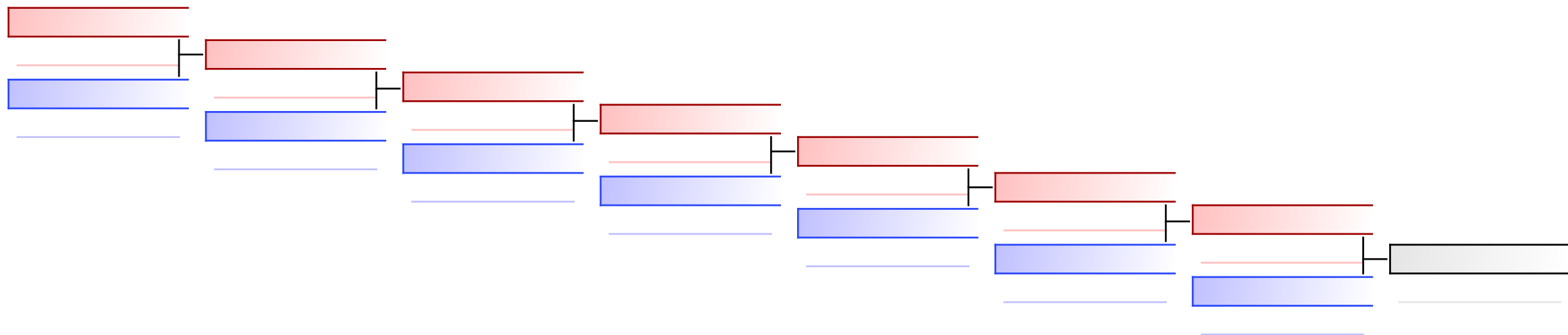

Referees:							
-----------	--	--	--	--	--	--	--

Kumite female Juniors +66kg

31ST KARATE GRAND PRIX CROATIA

2023-01-21

Tatami
2 13:10

Pool
2

(c)sportdata GmbH & Co KG 2000-2023 (2023-01-22 22:22) v 10.0.0 build 1 (2023-01-19) License: Online_Event_ID-6798_31STKARATEGRANDPRIXCROATIA (expire 2023-02-05)

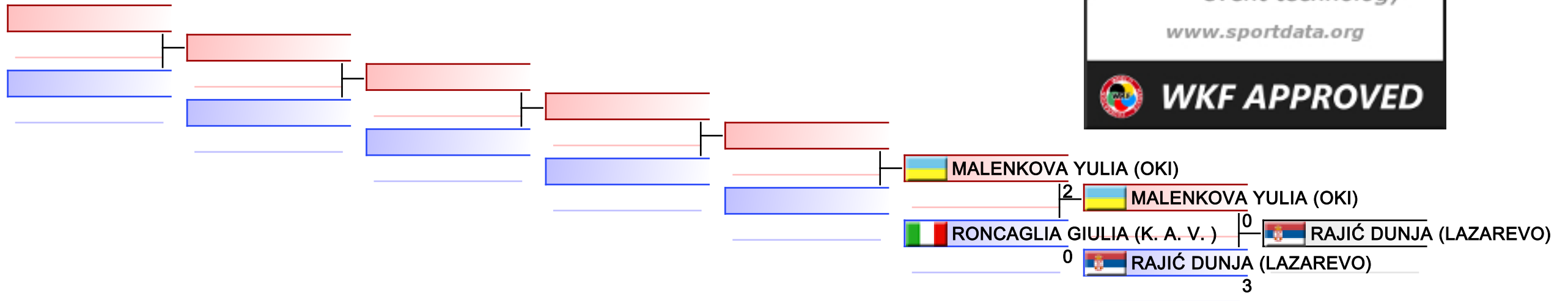

REPECHAGE: (2)

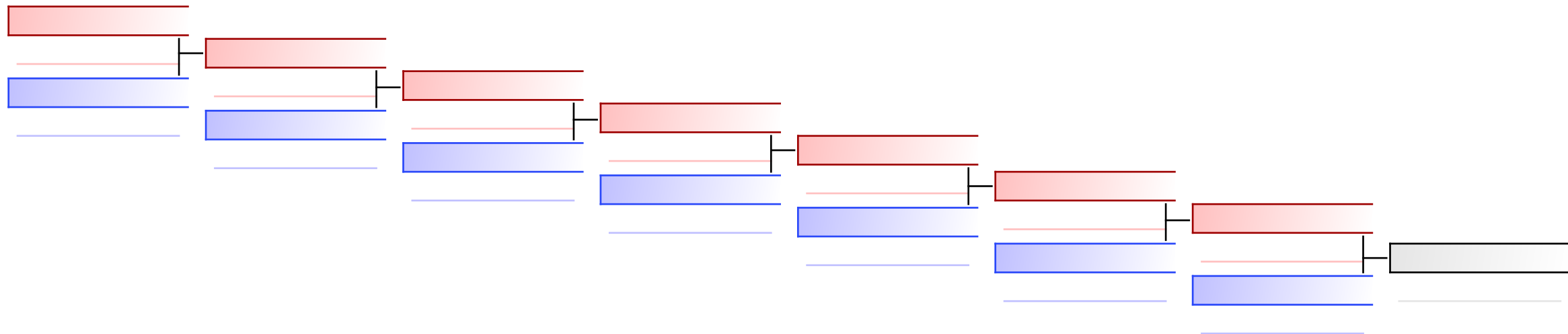

Referees:							
-----------	--	--	--	--	--	--	--

Kumite female Juniors +66kg

31ST KARATE GRAND PRIX CROATIA

2023-01-21

Tatami
1 13:10

Pool
1

(c)sportdata GmbH & Co KG 2000-2023 (2023-01-22 22:22) v 10.0.0 build 1 (2023-01-19) License: Online_Event_ID-6798_31STKARATEGRANDPRIXCROATIA (expire 2023-02-05)

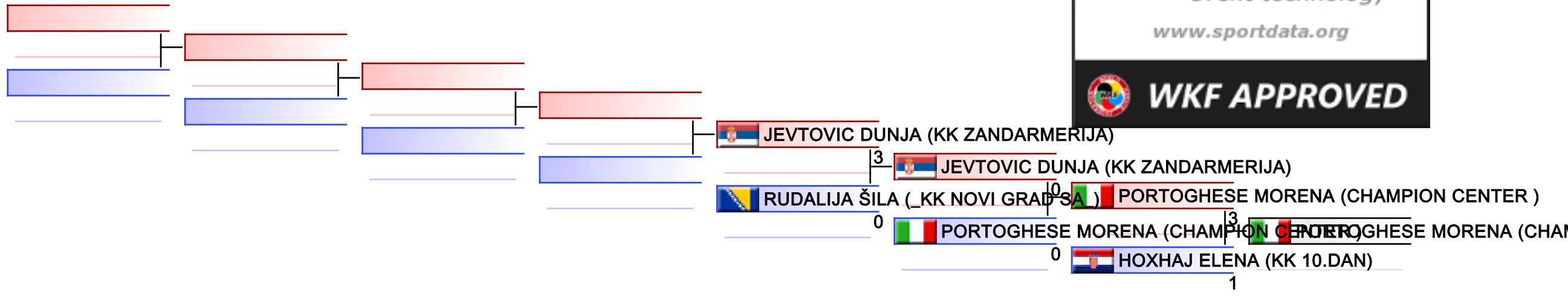

REPECHAGE: (1)

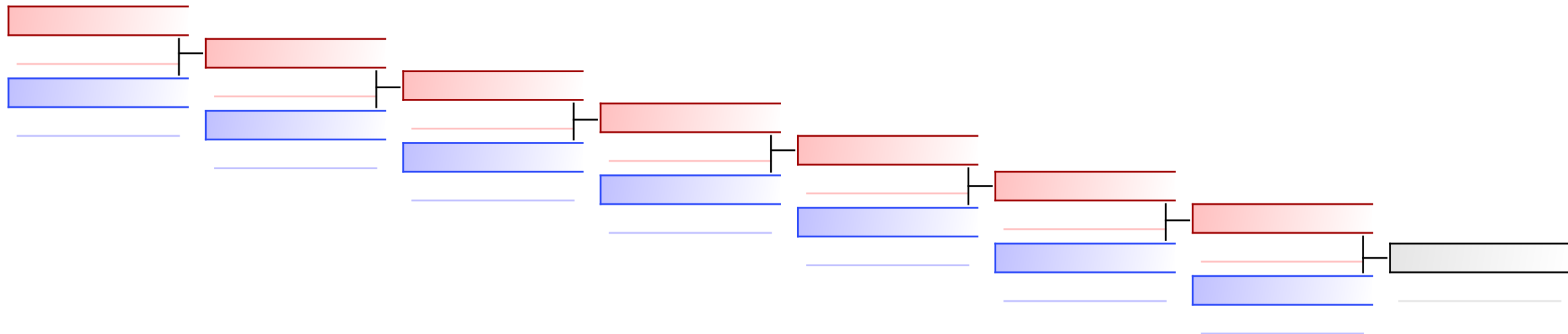

Referees:							
-----------	--	--	--	--	--	--	--

Kumite female juniors -48kg
31ST KARATE GRAND PRIX CROATIA

2023-01-21

Tatami
6 15:20

Pool
2

(c)sportdata GmbH & Co KG 2000-2023 (2023-01-22 22:22) v 10.0.0 build 1 (2023-01-19) License: Online_Event_ID-6798_31STKARATEGRANDPRIXCROATIA (expire 2023-02-05)

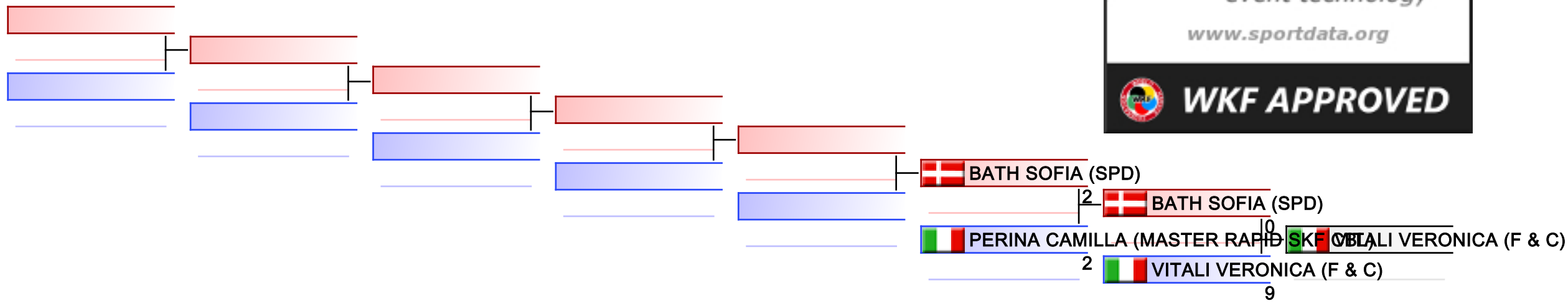

REPECHAGE: (2)

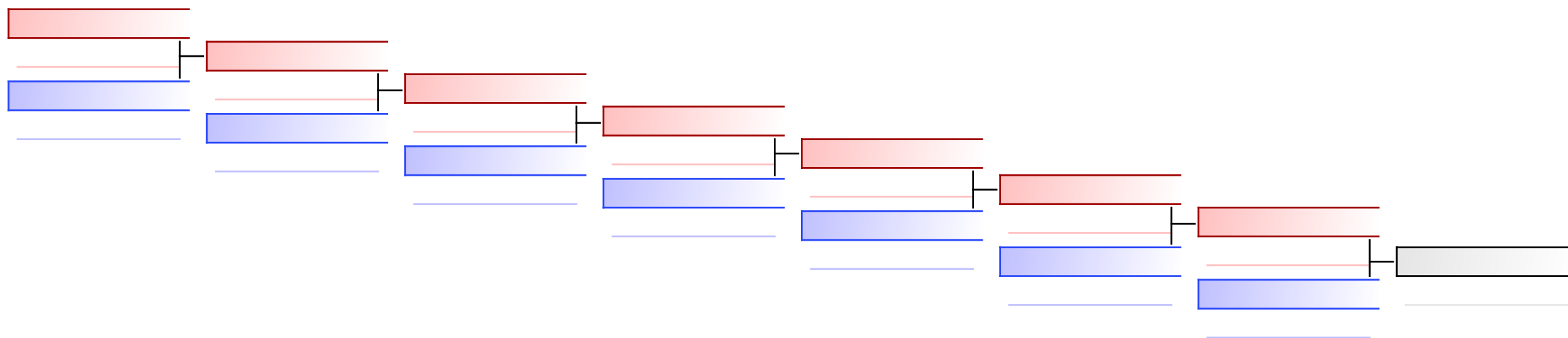

Referees:							
-----------	--	--	--	--	--	--	--

Kumite female juniors -48kg
31ST KARATE GRAND PRIX CROATIA

2023-01-21

Tatami
5 15:25

Pool
1

(c)sportdata GmbH & Co KG 2000-2023 (2023-01-22 22:22) v 10.0.0 build 1 (2023-01-19) License: Online_Event_ID-6798_31STKARATEGRANDPRIXCROATIA (expire 2023-02-05)

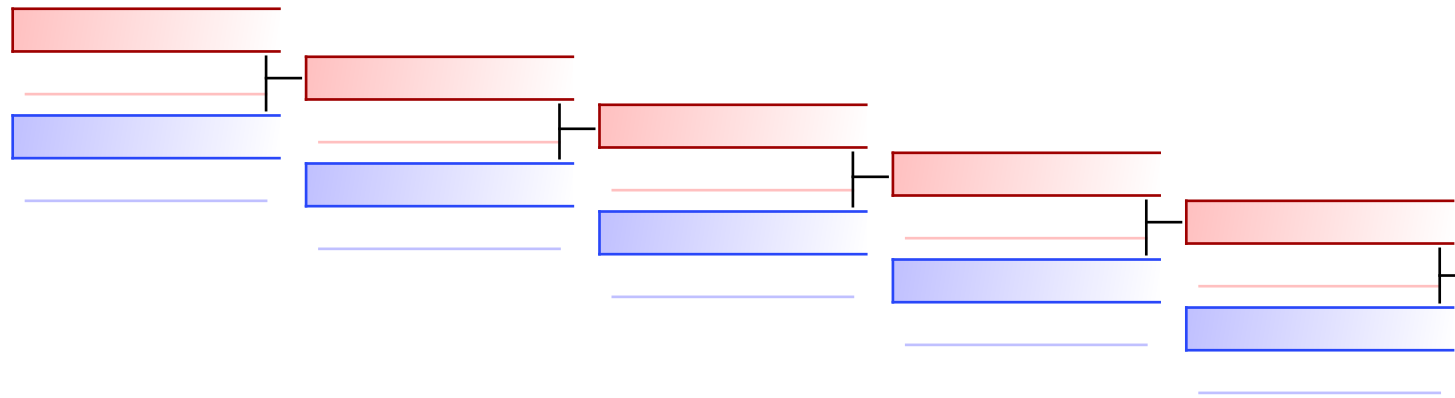

- DAMATO ALICE (12RM1604) | 0
- BOSSI ALESSANDRA (SKORPION KARATE ASD) | 8
- BOSSI ALESSANDRA (SKORPION KARATE ASD) | 1
- PETRESKA MARTINA (ЧОЛЕ - ОХРИД) | 2

REPECHAGE: (1)

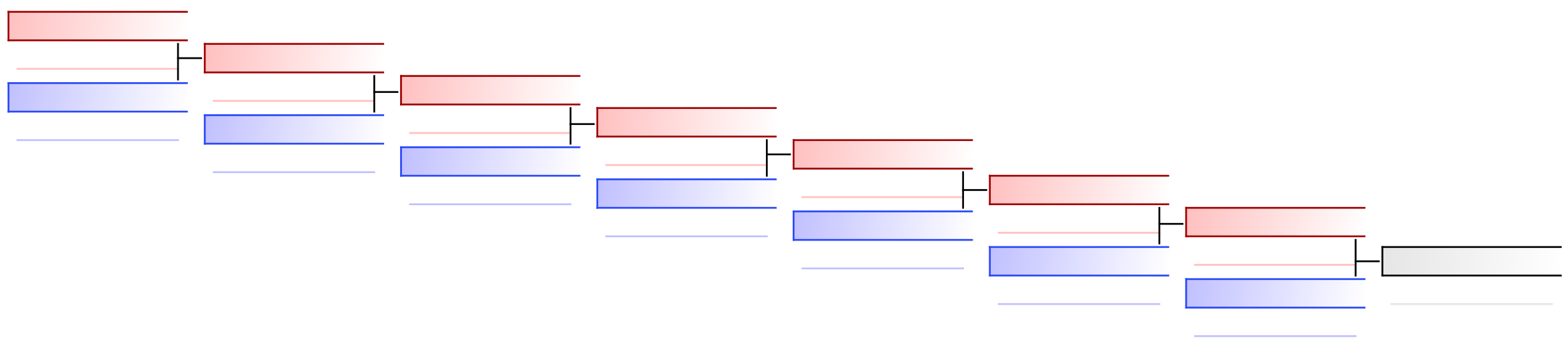

Referees:							
-----------	--	--	--	--	--	--	--

Kumite female juniors -53kg
31ST KARATE GRAND PRIX CROATIA

2023-01-21

Tatami
1 14:30

Pool
1

(c)sportdata GmbH & Co KG 2000-2023 (2023-01-22 22:22) v 10.0.0 build 1 (2023-01-19) License: Online_Event_ID-6798_31STKARATEGRANDPRIXCROATIA (expire 2023-02-05)

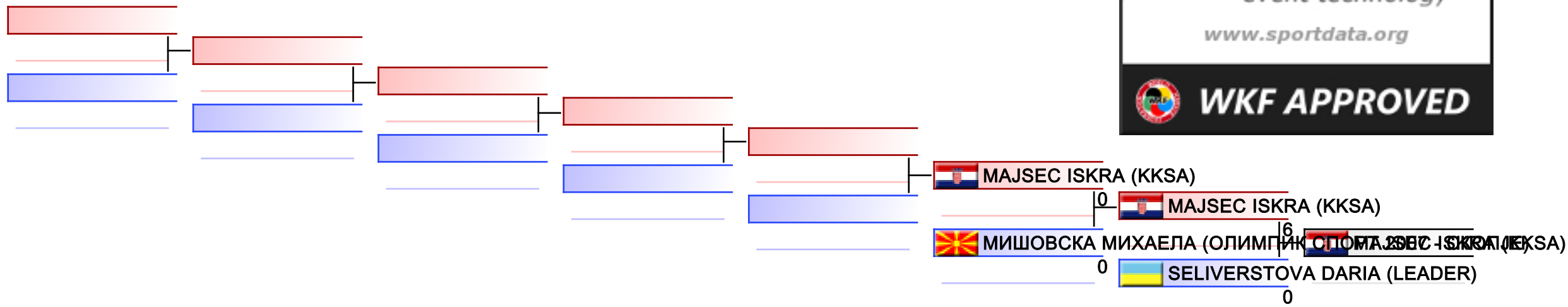

REPECHAGE: (1)

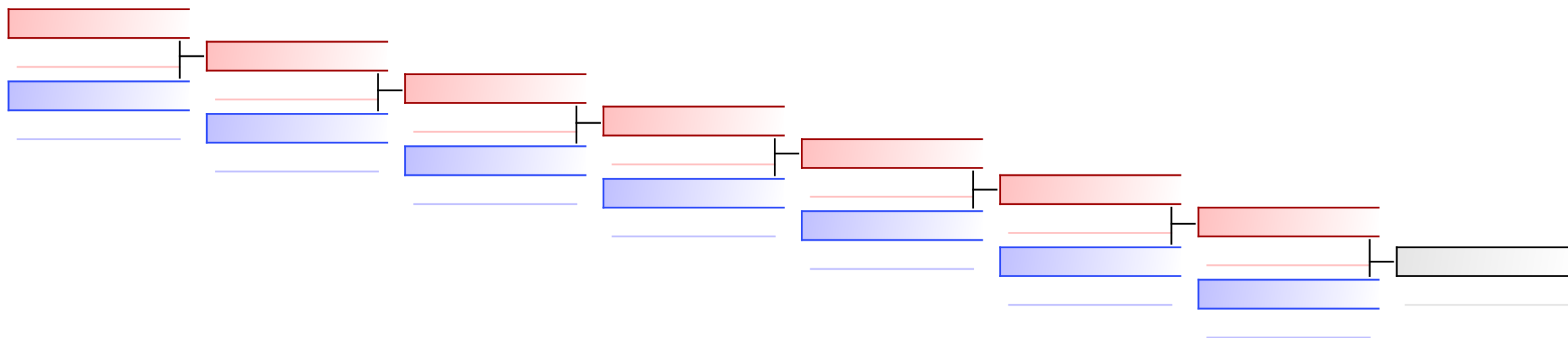

Referees:							
-----------	--	--	--	--	--	--	--

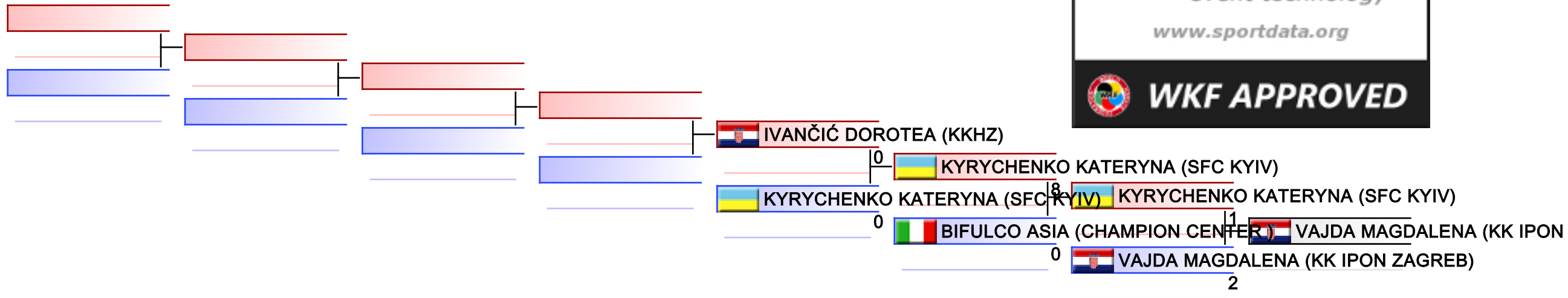

REPECHAGE: (2)

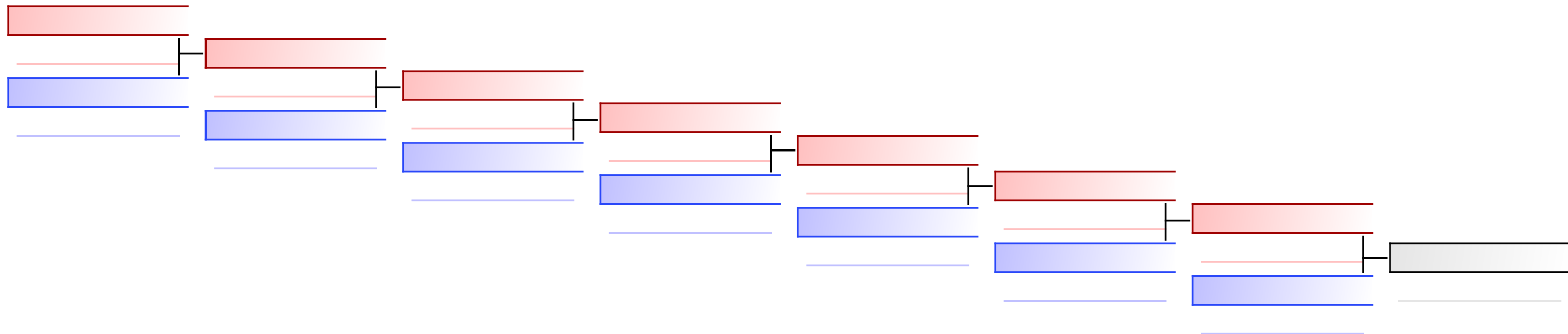

Referees:							
-----------	--	--	--	--	--	--	--

Kumite female juniors -59kg
31ST KARATE GRAND PRIX CROATIA

2023-01-21

Tatami
4 15:45

Pool
2

(c)sportdata GmbH & Co KG 2000-2023 (2023-01-22 22:22) v 10.0.0 build 1 (2023-01-19) License: Online_Event_ID-6798_31STKARATEGRANDPRIXCROATIA (expire 2023-02-05)

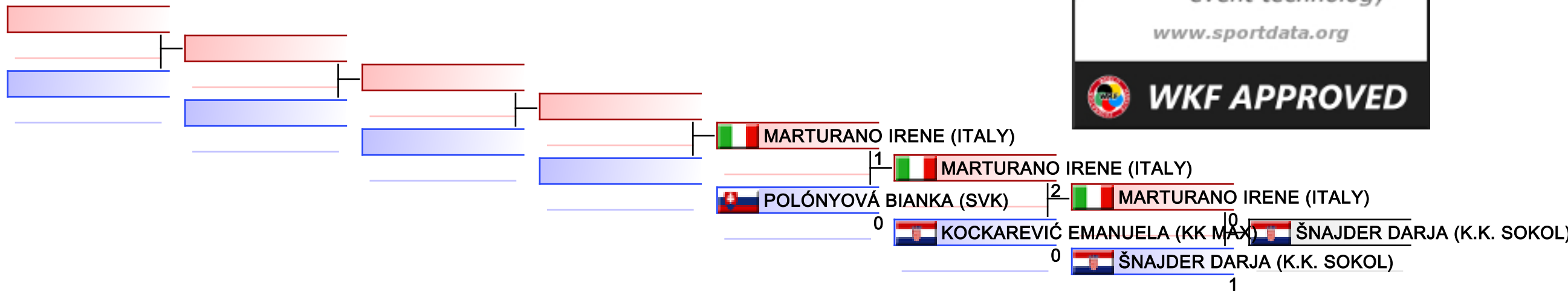

REPECHAGE: (2)

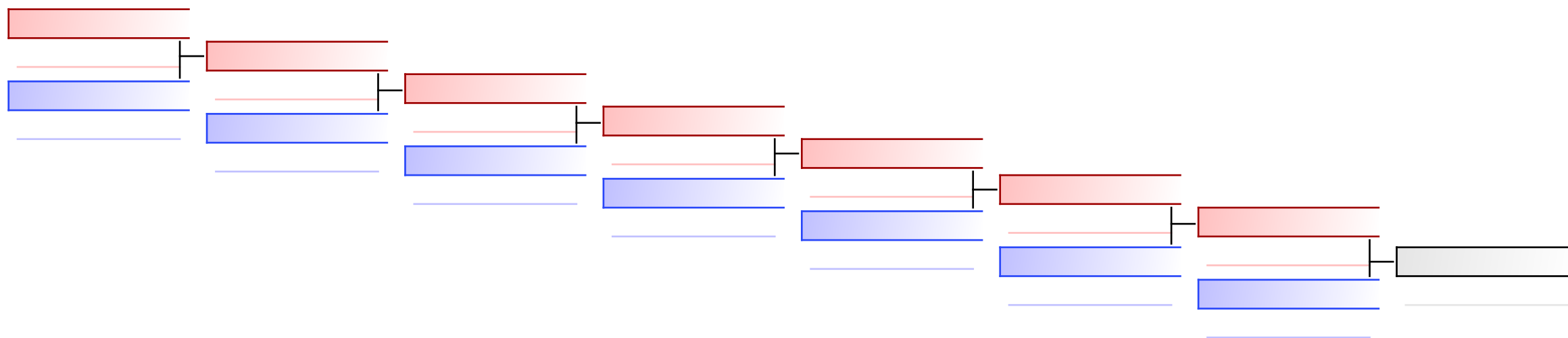

Referees:							
-----------	--	--	--	--	--	--	--

Kumite female juniors -59kg
31ST KARATE GRAND PRIX CROATIA

2023-01-21

Tatami
3 15:50

Pool
1

(c)sportdata GmbH & Co KG 2000-2023 (2023-01-22 22:22) v 10.0.0 build 1 (2023-01-19) License: Online_Event_ID-6798_31STKARATEGRANDPRIXCROATIA (expire 2023-02-05)

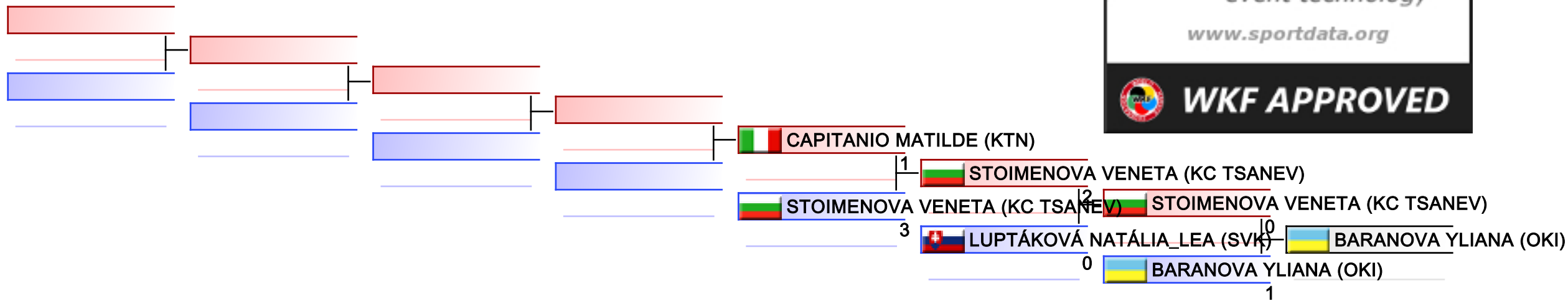

REPECHAGE: (1)

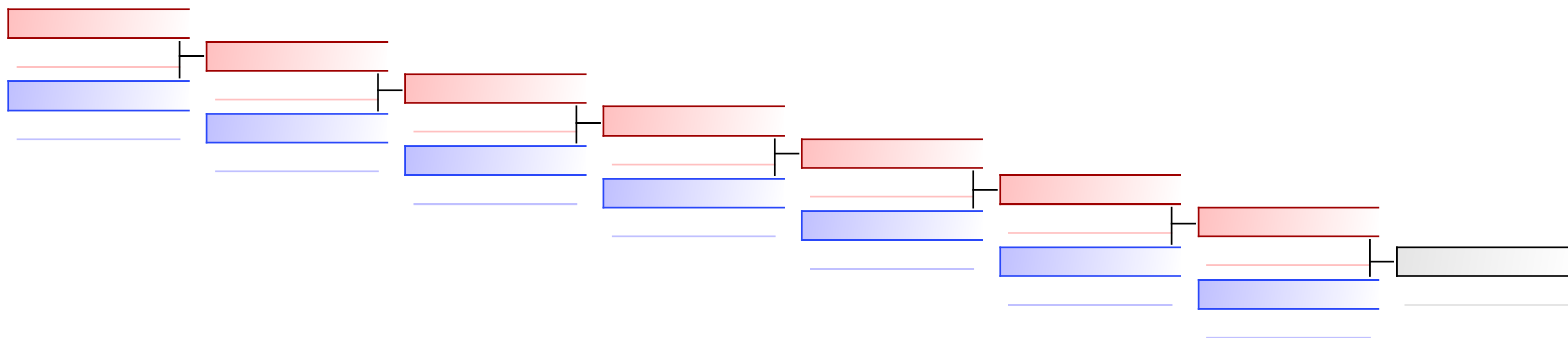

Referees:							
-----------	--	--	--	--	--	--	--

Kumite female Juniors -66kg

31ST KARATE GRAND PRIX CROATIA

2023-01-21

Tatami
6 14:20

Pool
2

(c)sportdata GmbH & Co KG 2000-2023 (2023-01-22 22:22) v 10.0.0 build 1 (2023-01-19) License: Online_Event_ID-6798_31STKARATEGRANDPRIXCROATIA (expire 2023-02-05)

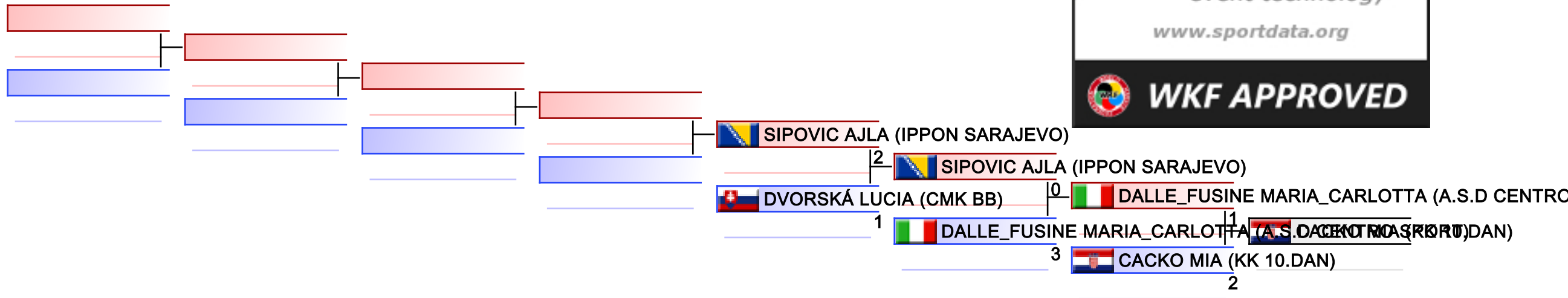

REPECHAGE: (2)

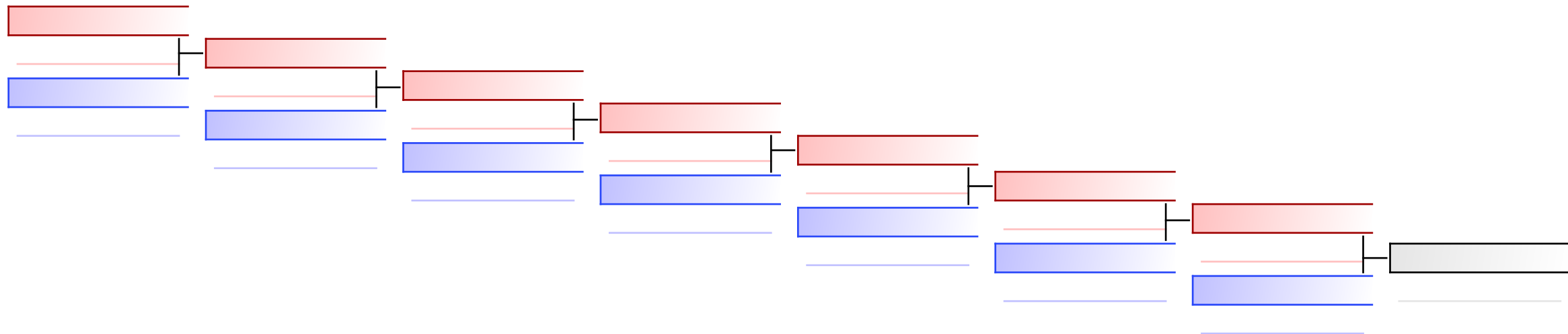

Referees:							
-----------	--	--	--	--	--	--	--

Kumite female Juniors -66kg

31ST KARATE GRAND PRIX CROATIA

2023-01-21

Tatami
5 14:30

Pool
1

(c)sportdata GmbH & Co KG 2000-2023 (2023-01-22 22:22) v 10.0.0 build 1 (2023-01-19) License: Online_Event_ID-6798_31STKARATEGRANDPRIXCROATIA (expire 2023-02-05)

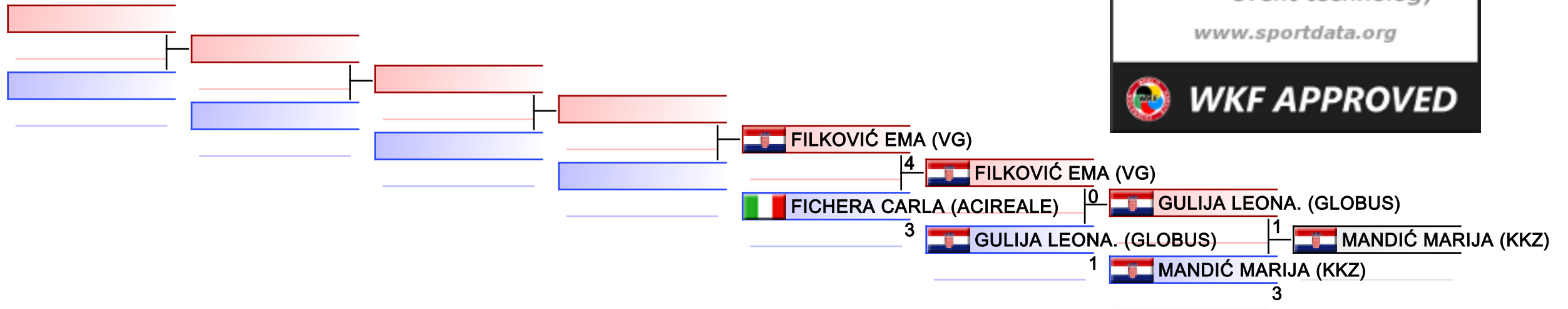

REPECHAGE: (1)

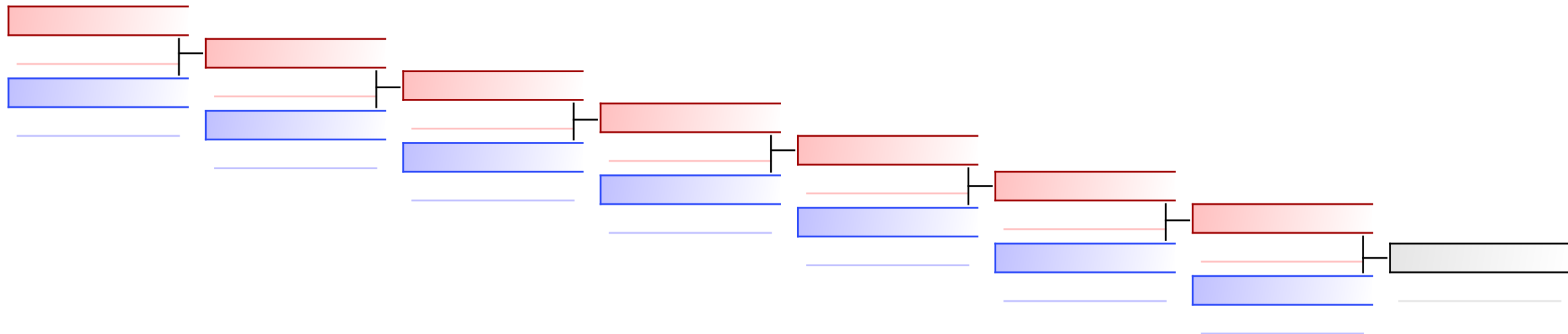

Referees:							
-----------	--	--	--	--	--	--	--

Kumite Female U21 + 68kg

31ST KARATE GRAND PRIX CROATIA

2023-01-21

Tatami
3 09:45

Pool
1,2

(c)sportdata GmbH & Co KG 2000-2023 (2023-01-22 22:22) v 10.0.0 build 1 (2023-01-19) License: Online_Event_ID-6798_31STKARATEGRANDPRIXCROATIA (expire 2023-02-05)

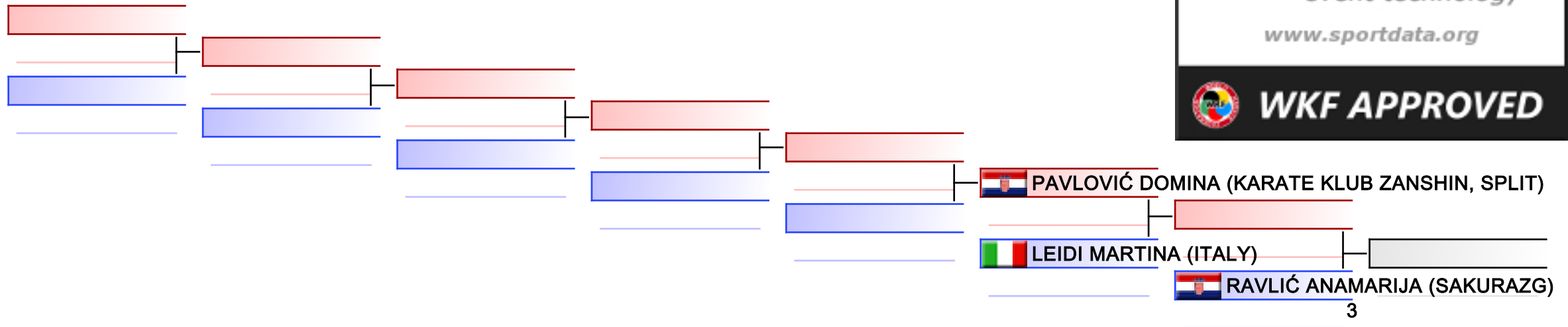

REPECHAGE: (1,2)

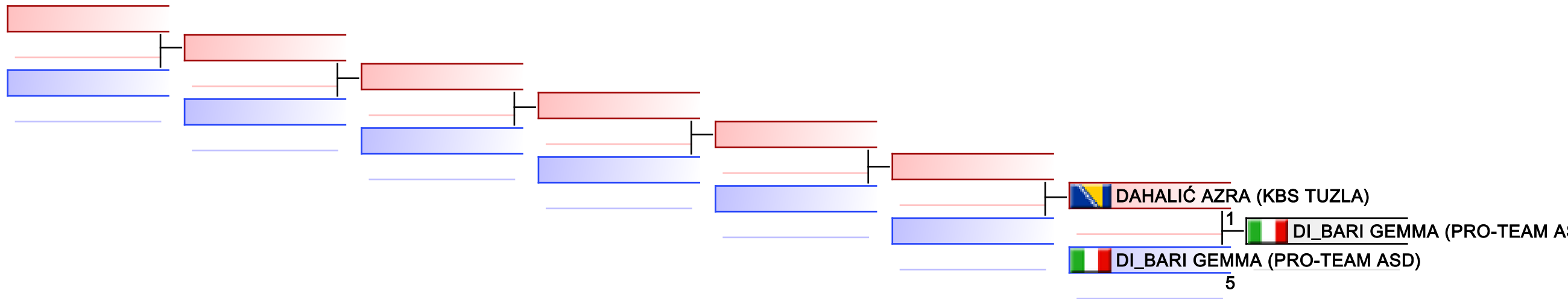

Referees:							
-----------	--	--	--	--	--	--	--

KUMITE GIRLS 11-12 YEARS +54KG

31ST KARATE GRAND PRIX CROATIA

2023-01-22

Tatami
6 17:05

Pool
1

(c)sportdata GmbH & Co KG 2000-2023 (2023-01-22 22:23) v 10.0.0 build 1 (2023-01-19) License: Online_Event_ID-6798_31STKARATEGRANDPRIXCROATIA (expire 2023-02-05)

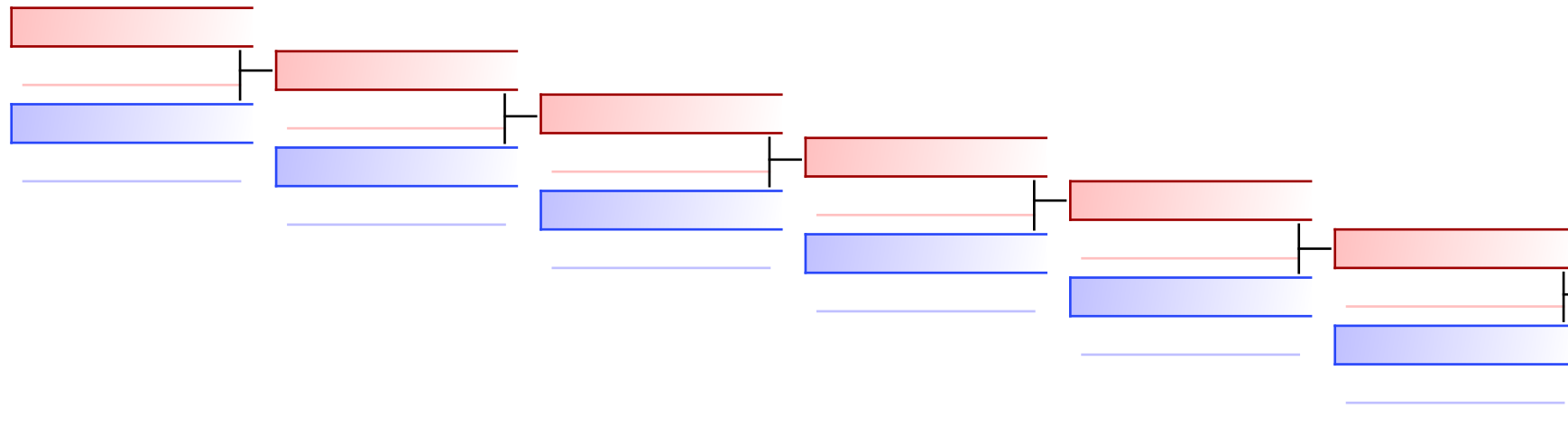

DUJMOVIĆ KLARA (KK NEVERA) 0
 BALLARIN GINEVRA (POLISPORTIVA TERRAGLIO) 2

REPECHAGE: (1)

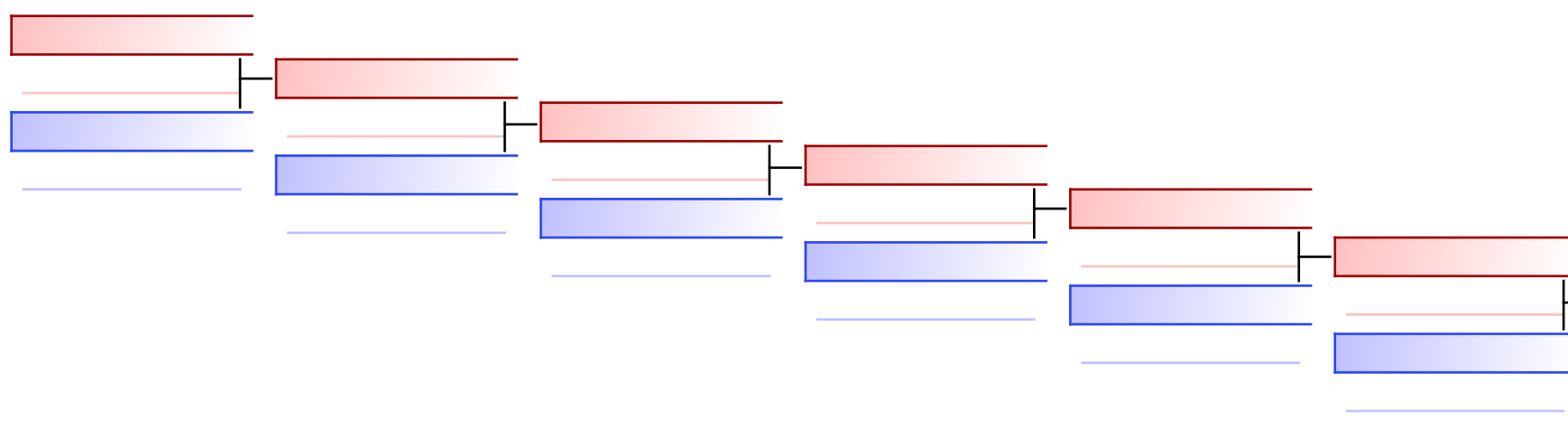

BALIĆ BERINA (KK RESPECT) 1
 SHEPTIY POLINA (CONCORDIA) 0

Referees:							
-----------	--	--	--	--	--	--	--

KUMITE GIRLS 11-12 YEARS -34KG

31ST KARATE GRAND PRIX CROATIA

2023-01-22

Tatami
1 17:20

Pool
1

(c)sportdata GmbH & Co KG 2000-2023 (2023-01-22 22:23) v 10.0.0 build 1 (2023-01-19) License: Online_Event_ID-6798_31STKARATEGRANDPRIXCROATIA (expire 2023-02-05)

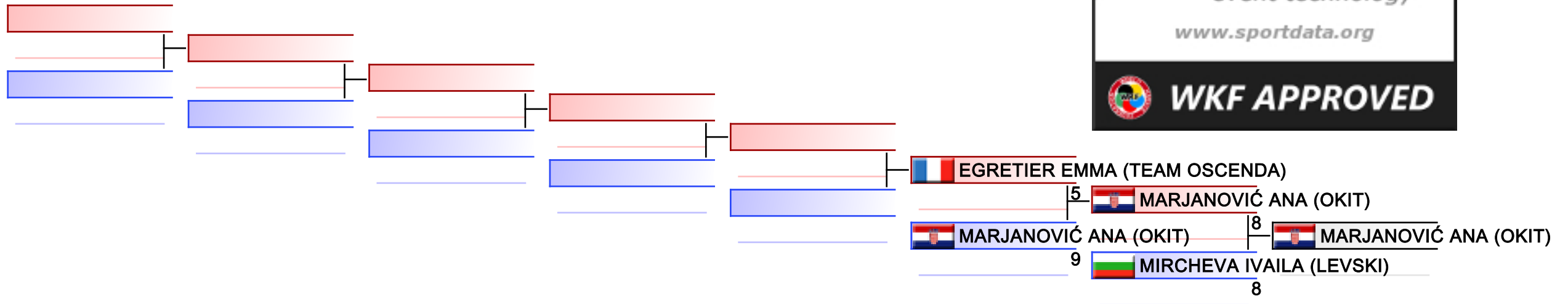

REPECHAGE: (1)

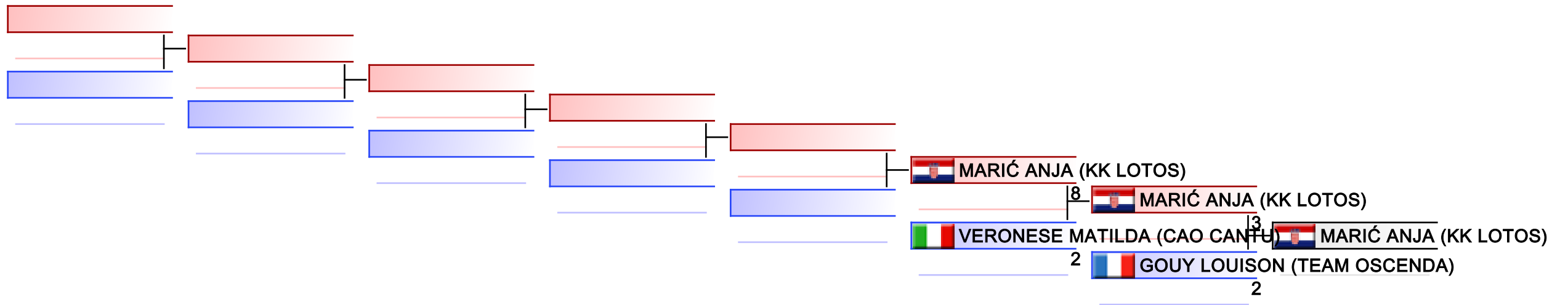

Referees:							
-----------	--	--	--	--	--	--	--

KUMITE GIRLS 11-12 YEARS -39KG

31ST KARATE GRAND PRIX CROATIA

2023-01-22

Tatami
2 17:40

Pool
1

(c)sportdata GmbH & Co KG 2000-2023 (2023-01-22 22:23) v 10.0.0 build 1 (2023-01-19) License: Online_Event_ID-6798_31STKARATEGRANDPRIXCROATIA (expire 2023-02-05)

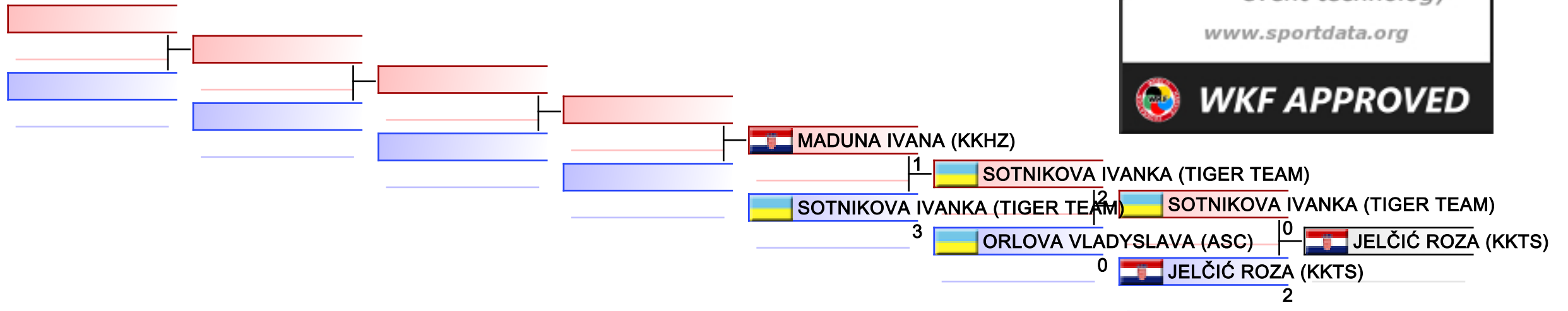

REPECHAGE: (1)

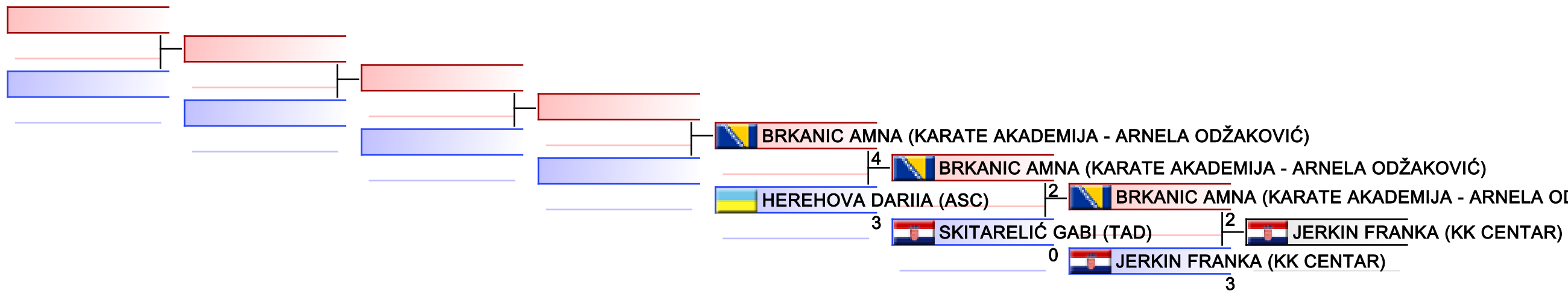

Referees:							
-----------	--	--	--	--	--	--	--

KUMITE GIRLS 11-12 YEARS -44KG

31ST KARATE GRAND PRIX CROATIA

2023-01-22

Tatami
4 16:15

Pool
1

(c)sportdata GmbH & Co KG 2000-2023 (2023-01-22 22:23) v 10.0.0 build 1 (2023-01-19) License: Online_Event_ID-6798_31STKARATEGRANDPRIXCROATIA (expire 2023-02-05)

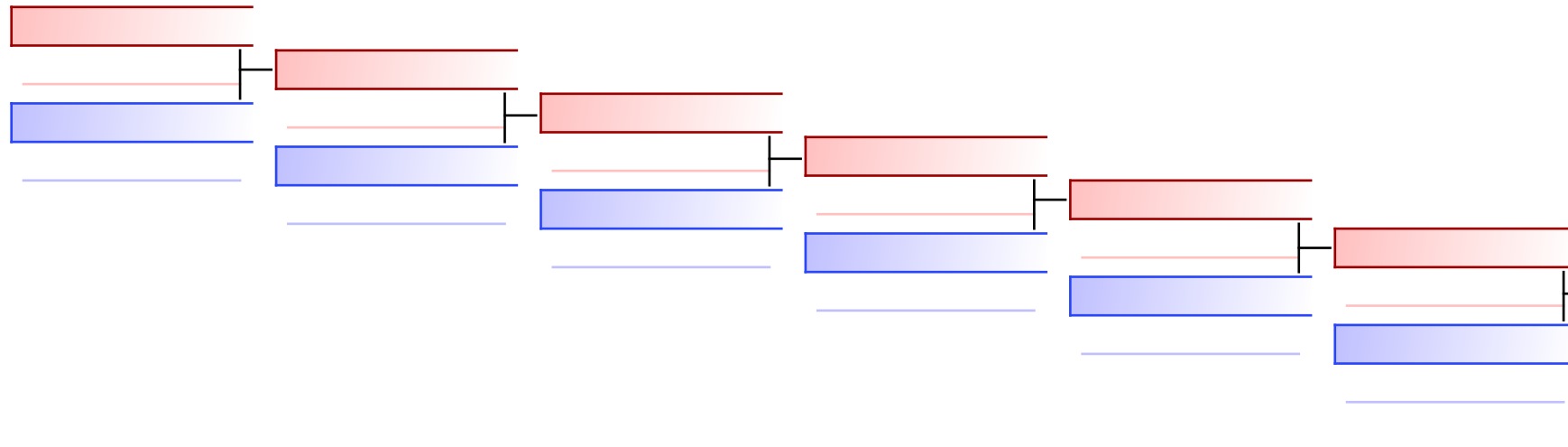

KADIĆ NOLA (KK LOTOS) | 0
 ORLOVA VLADYSLAVA (ASC) | 0

REPECHAGE: (1)

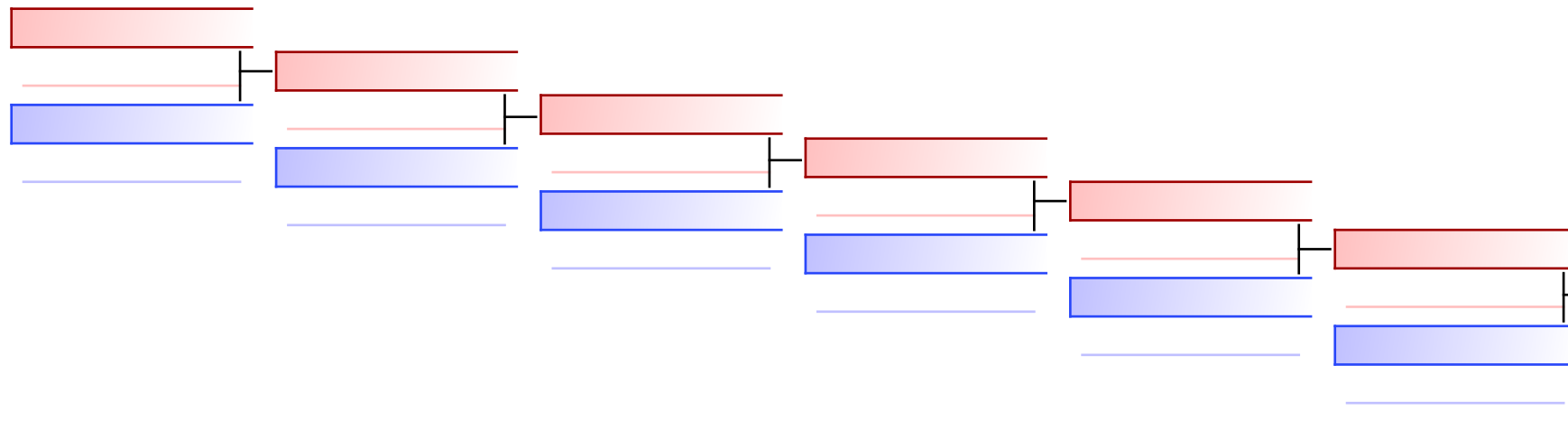

ZAMBERLAN EMMA (KARATE TEAM 1999) | 5
 MURASHKINA VARVARA (LEON KARATE CLUB) | 3

Referees:							
-----------	--	--	--	--	--	--	--

KUMITE GIRLS 11-12 YEARS -49KG

31ST KARATE GRAND PRIX CROATIA

2023-01-22

Tatami
6 16:15

Pool
1

(c)sportdata GmbH & Co KG 2000-2023 (2023-01-22 22:23) v 10.0.0 build 1 (2023-01-19) License: Online_Event_ID-6798_31STKARATEGRANDPRIXCROATIA (expire 2023-02-05)

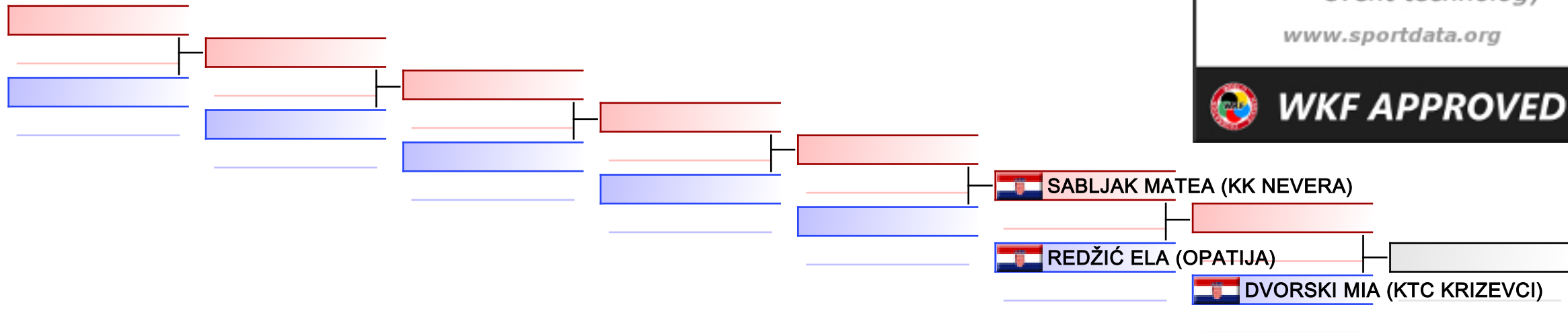

REPECHAGE: (1)

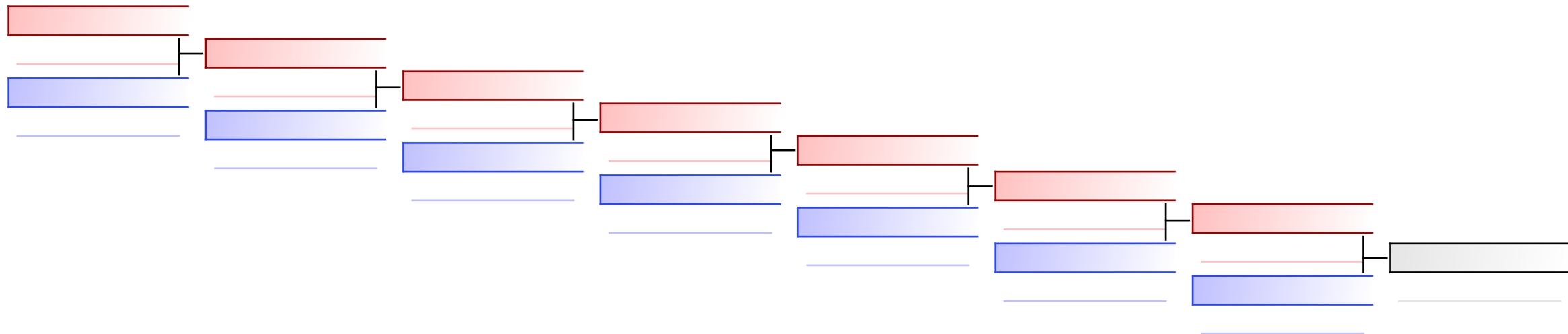

Referees:							
-----------	--	--	--	--	--	--	--

KUMITE GIRLS 11-12 YEARS -54KG

31ST KARATE GRAND PRIX CROATIA

2023-01-22

Tatami
4 17:00

Pool
1

(c)sportdata GmbH & Co KG 2000-2023 (2023-01-22 22:23) v 10.0.0 build 1 (2023-01-19) License: Online_Event_ID-6798_31STKARATEGRANDPRIXCROATIA (expire 2023-02-05)

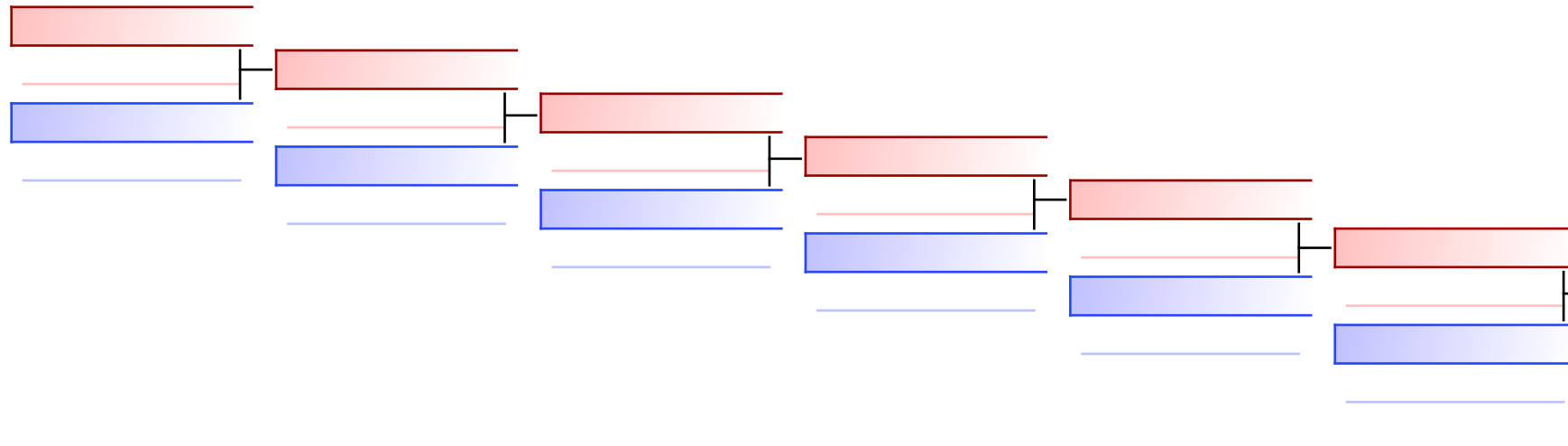

KIŠ LANA (KKTS)

0

JELENKO NINA (SKK OPLOTNICA)

JELENKO NINA (SKK OPLOTNICA)

4

REPECHAGE: (1)

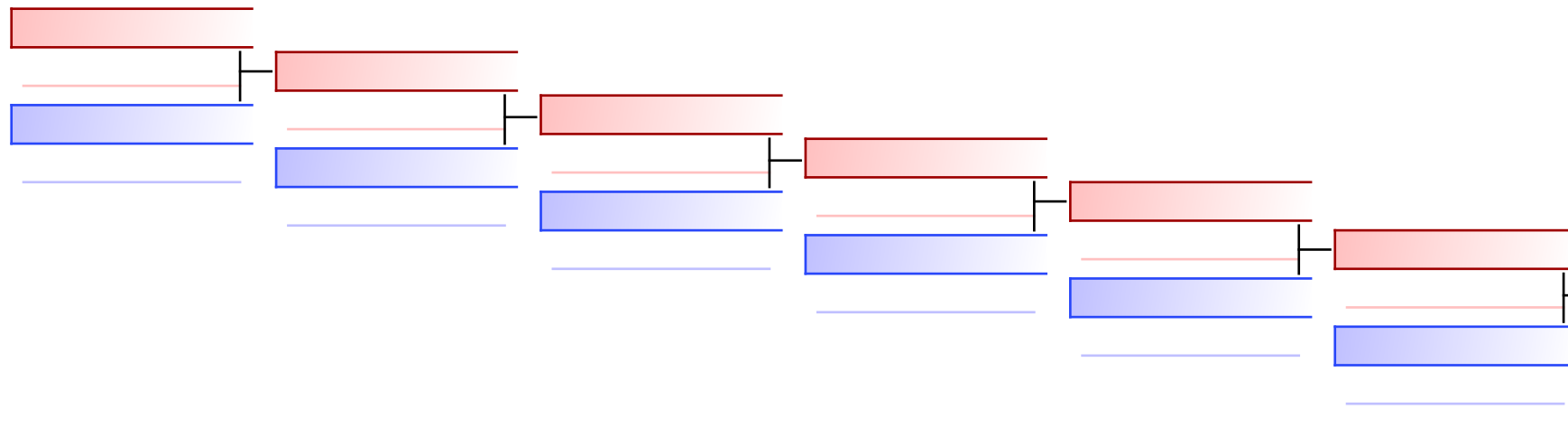

HADŽIĆ AZRA (KK KUMITE JAJCE)

7

HADŽIĆ AZRA (KK KUMITE JAJCE)

VURUŠIĆ TENA (GLOBUS)

4

Referees:							
-----------	--	--	--	--	--	--	--

KUMITE GIRLS 13-14 YEARS +64KG

31ST KARATE GRAND PRIX CROATIA

2023-01-22

Tatami
3 20:00

Pool
1

(c)sportdata GmbH & Co KG 2000-2023 (2023-01-22 22:23) v 10.0.0 build 1 (2023-01-19) License: Online_Event_ID-6798_31STKARATEGRANDPRIXCROATIA (expire 2023-02-05)

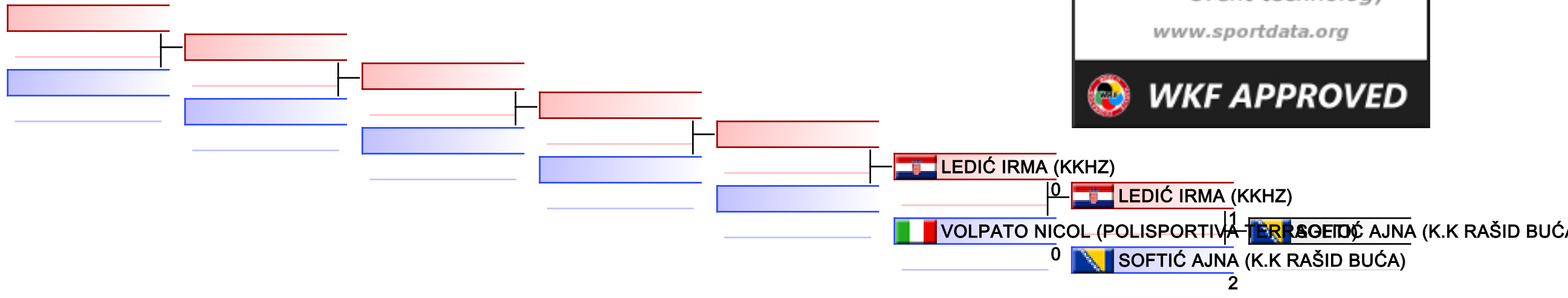

REPECHAGE: (1)

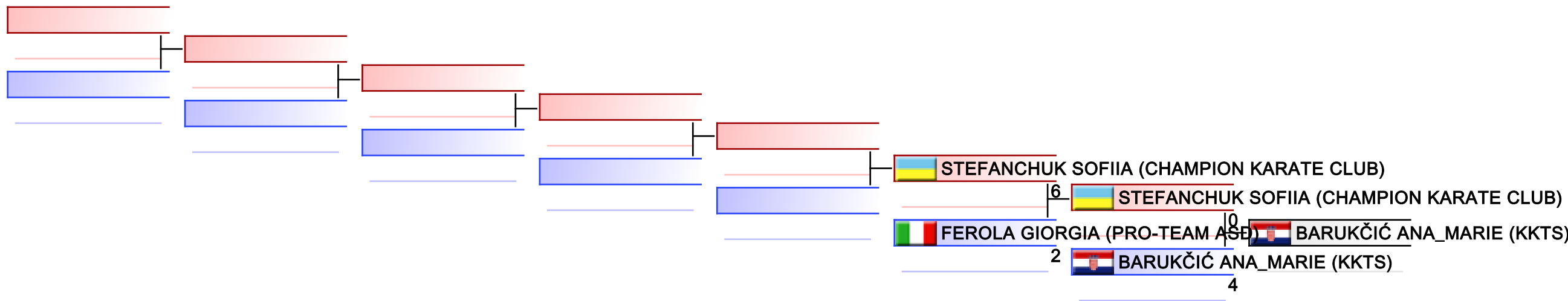

Referees:							
-----------	--	--	--	--	--	--	--

KUMITE GIRLS 13-14 YEARS -44KG

31ST KARATE GRAND PRIX CROATIA

2023-01-22

Tatami
3 18:40

Pool
1

(c)sportdata GmbH & Co KG 2000-2023 (2023-01-22 22:23) v 10.0.0 build 1 (2023-01-19) License: Online_Event_ID-6798_31STKARATEGRANDPRIXCROATIA (expire 2023-02-05)

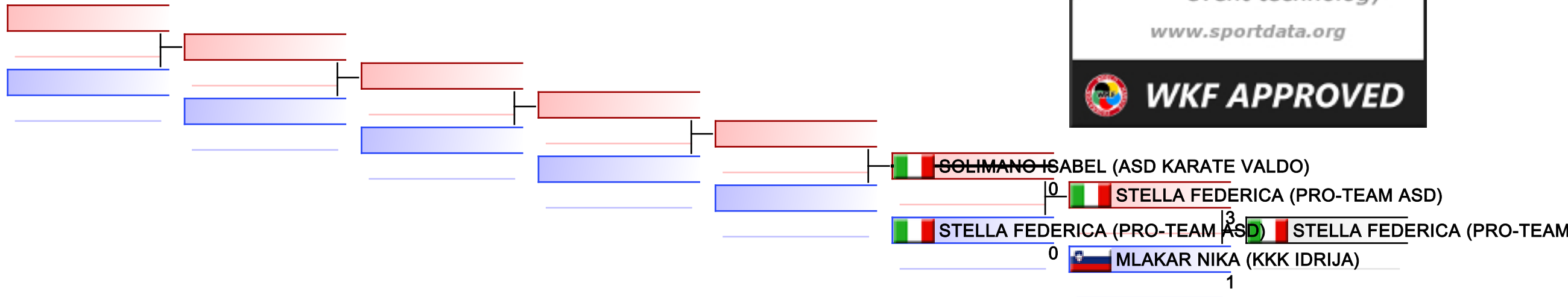

REPECHAGE: (1)

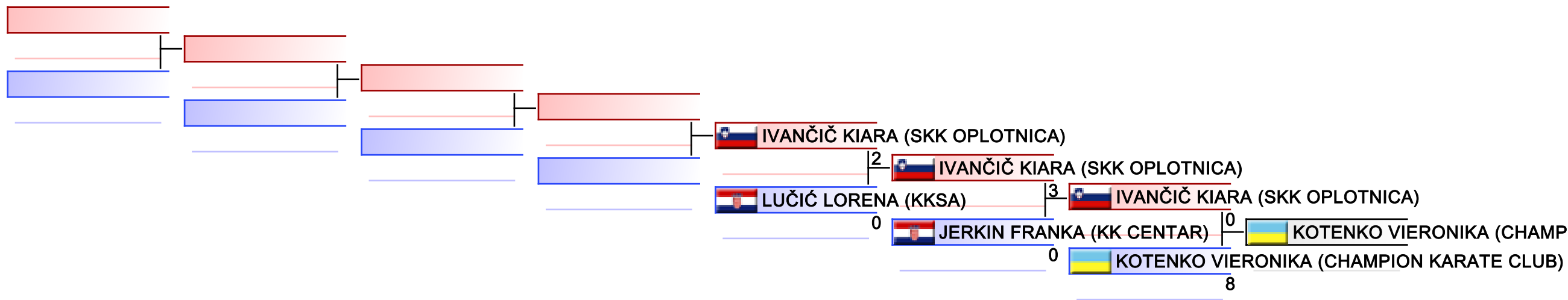

Referees:							
-----------	--	--	--	--	--	--	--

KUMITE GIRLS 13-14 YEARS -49KG

31ST KARATE GRAND PRIX CROATIA

2023-01-22

Tatami
4 18:35

Pool
1

(c)sportdata GmbH & Co KG 2000-2023 (2023-01-22 22:23) v 10.0.0 build 1 (2023-01-19) License: Online_Event_ID-6798_31STKARATEGRANDPRIXCROATIA (expire 2023-02-05)

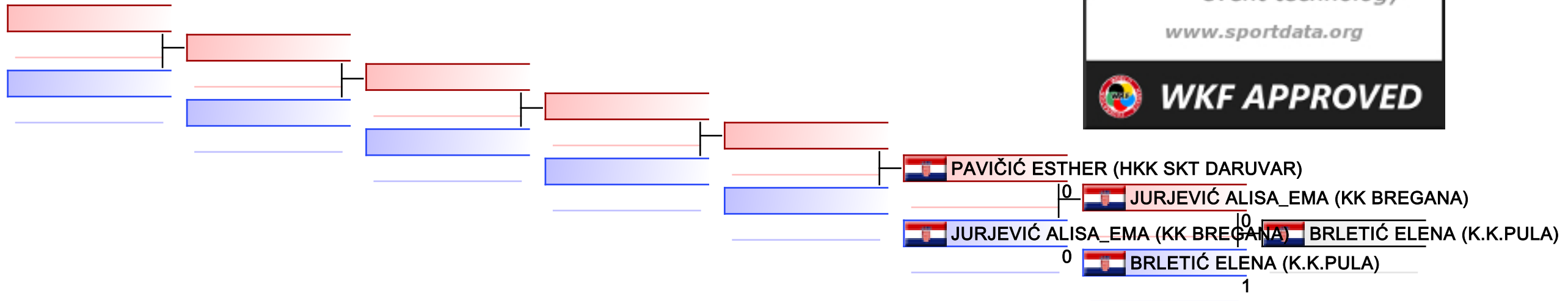

REPECHAGE: (1)

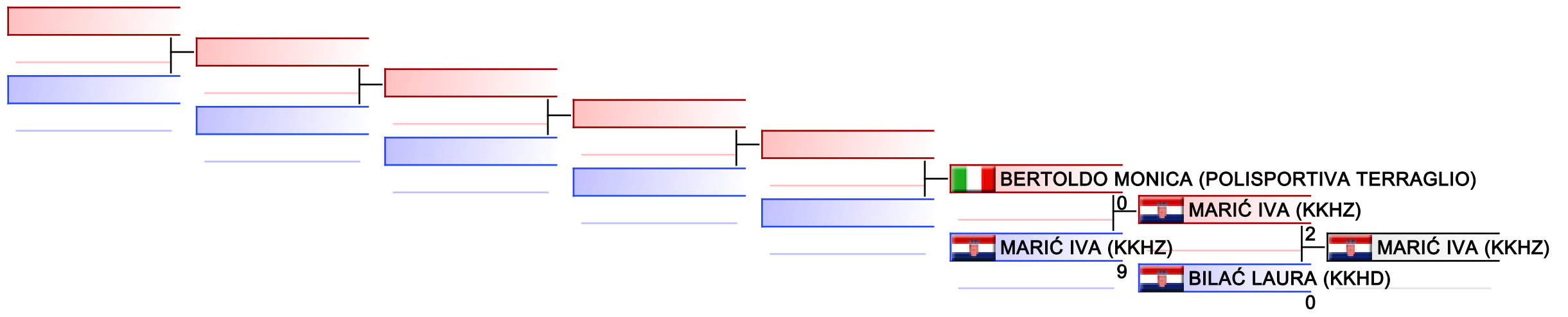

Referees:							
-----------	--	--	--	--	--	--	--

KUMITE GIRLS 13-14 YEARS -54KG

31ST KARATE GRAND PRIX CROATIA

2023-01-22

Tatami
6 19:30

Pool
1

(c)sportdata GmbH & Co KG 2000-2023 (2023-01-22 22:23) v 10.0.0 build 1 (2023-01-19) License: Online_Event_ID-6798_31STKARATEGRANDPRIXCROATIA (expire 2023-02-05)

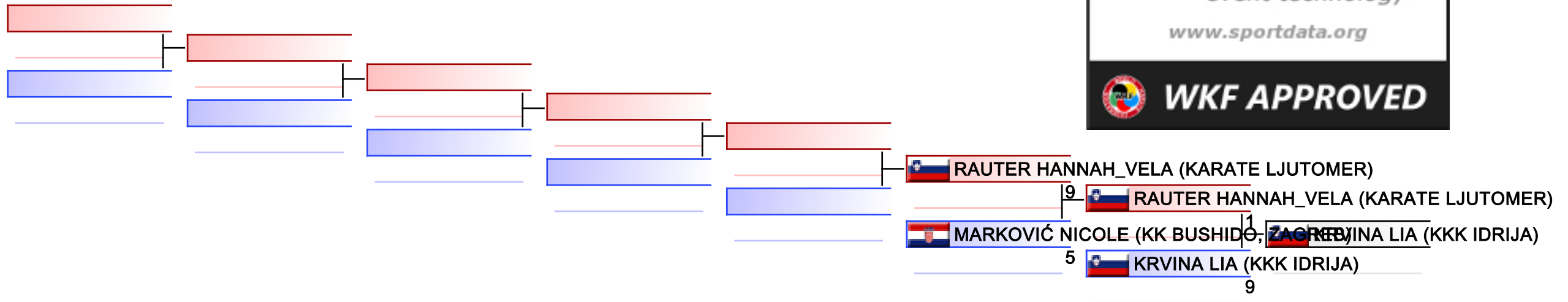

REPECHAGE: (1)

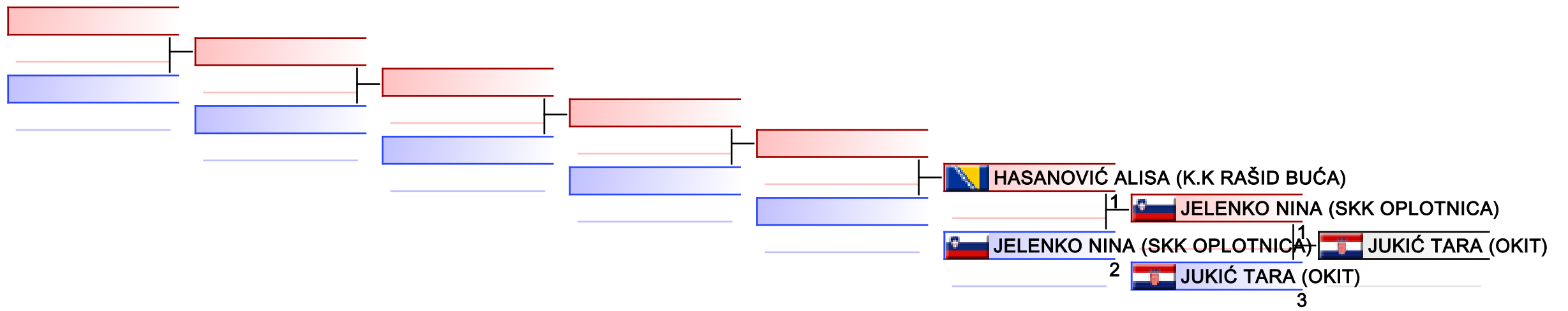

Referees:							
-----------	--	--	--	--	--	--	--

KUMITE GIRLS 13-14 YEARS -59KG

31ST KARATE GRAND PRIX CROATIA

2023-01-22

Tatami
5 19:35

Pool
1

(c)sportdata GmbH & Co KG 2000-2023 (2023-01-22 22:23) v 10.0.0 build 1 (2023-01-19) License: Online_Event_ID-6798_31STKARATEGRANDPRIXCROATIA (expire 2023-02-05)

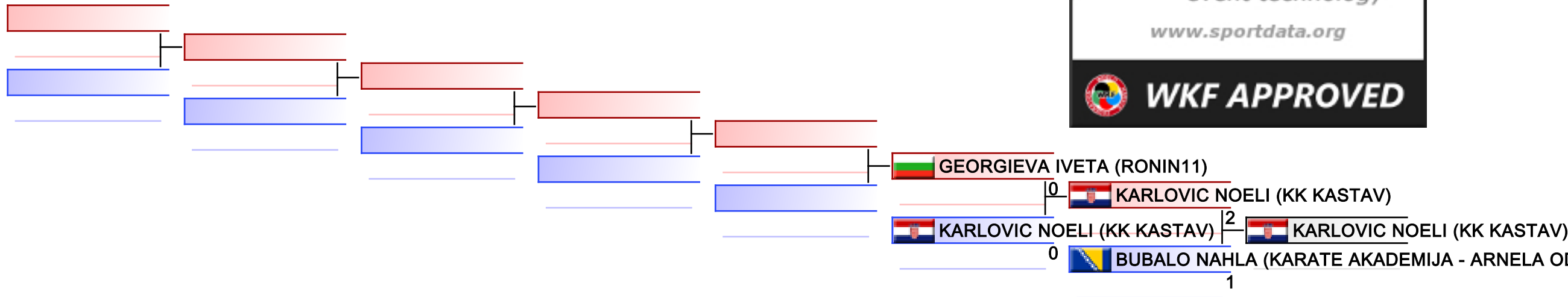

REPECHAGE: (1)

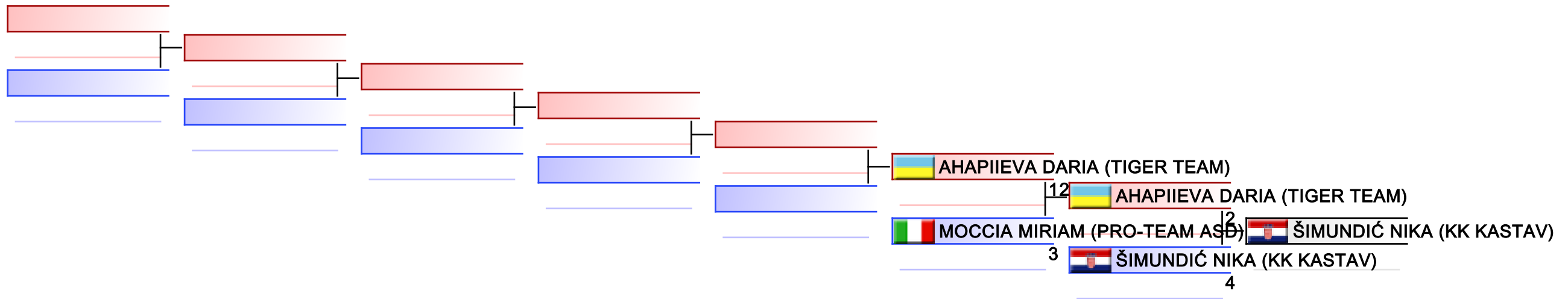

Referees:							
-----------	--	--	--	--	--	--	--

KUMITE GIRLS 13-14 YEARS -64KG

31ST KARATE GRAND PRIX CROATIA

2023-01-22

Tatami
4 19:50

Pool
1

(c)sportdata GmbH & Co KG 2000-2023 (2023-01-22 22:23) v 10.0.0 build 1 (2023-01-19) License: Online_Event_ID-6798_31STKARATEGRANDPRIXCROATIA (expire 2023-02-05)

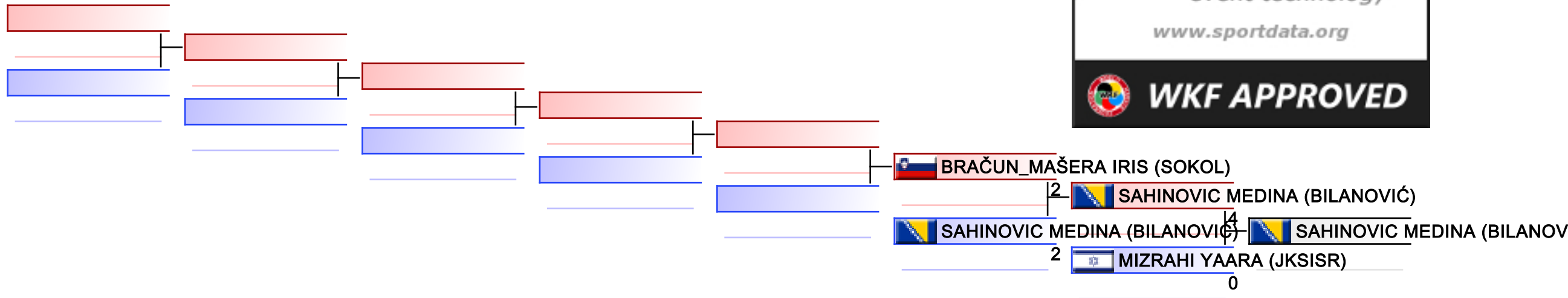

REPECHAGE: (1)

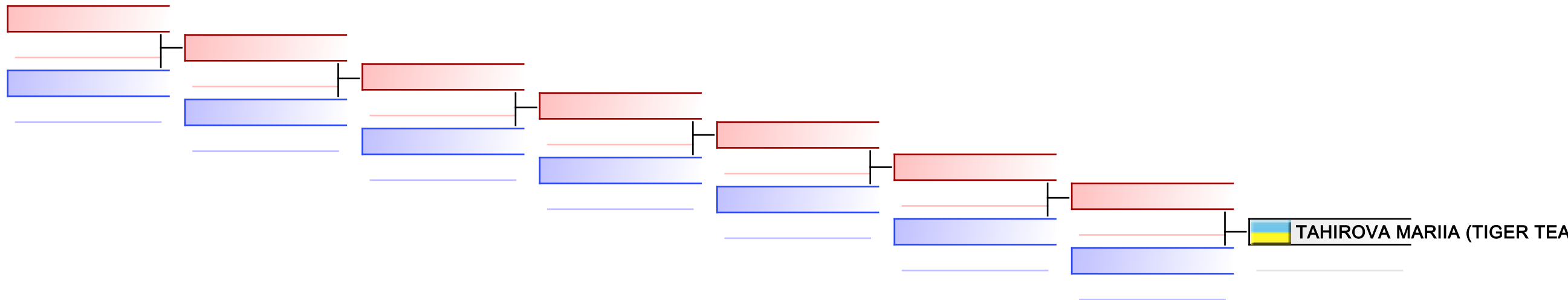

Referees:							
-----------	--	--	--	--	--	--	--

KUMITE GIRLS 9-10 YEARS -27kg

31ST KARATE GRAND PRIX CROATIA

2023-01-22

Tatami
1 16:00

Pool
1

(c)sportdata GmbH & Co KG 2000-2023 (2023-01-22 22:23) v 10.0.0 build 1 (2023-01-19) License: Online_Event_ID-6798_31STKARATEGRANDPRIXCROATIA (expire 2023-02-05)



AZINOVIĆ RUŽA (KK NOVI ZAGREB)
0
 VRBAN MAŠA (KKHZ)
2

REPECHAGE: (1)

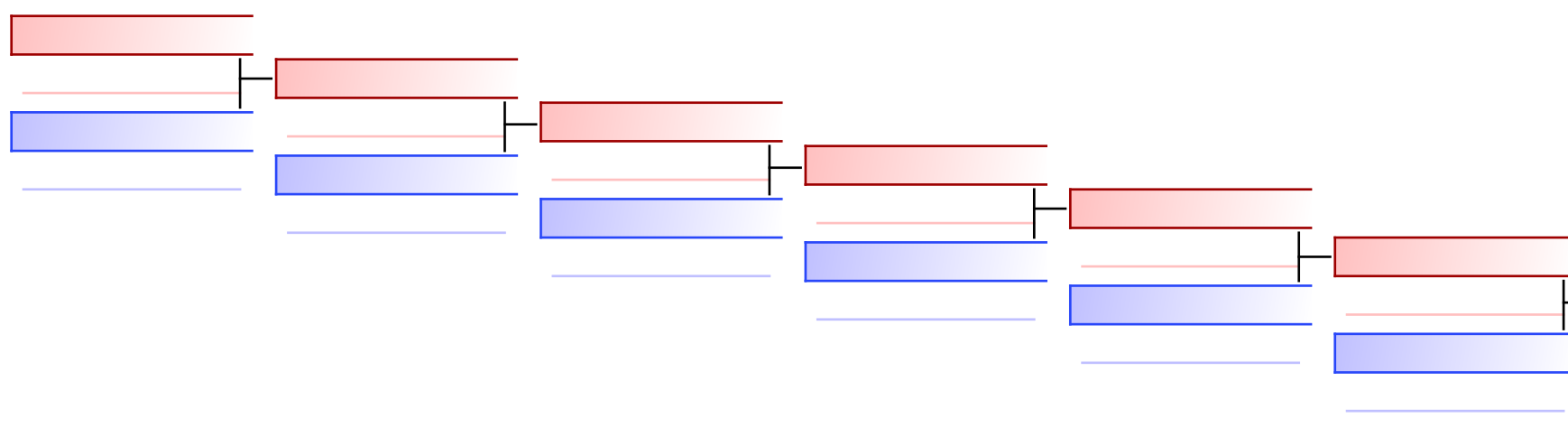

MURASHKINA MARHARYTA (LEON KARATE CLUB)
4
 ŽUGAJ SARA (KK KOSTRENA)
2

Referees:							
-----------	--	--	--	--	--	--	--

KUMITE GIRLS 9-10 YEARS -31kg

31ST KARATE GRAND PRIX CROATIA

2023-01-22

Tatami
2 15:05

Pool
1

(c)sportdata GmbH & Co KG 2000-2023 (2023-01-22 22:23) v 10.0.0 build 1 (2023-01-19) License: Online_Event_ID-6798_31STKARATEGRANDPRIXCROATIA (expire 2023-02-05)

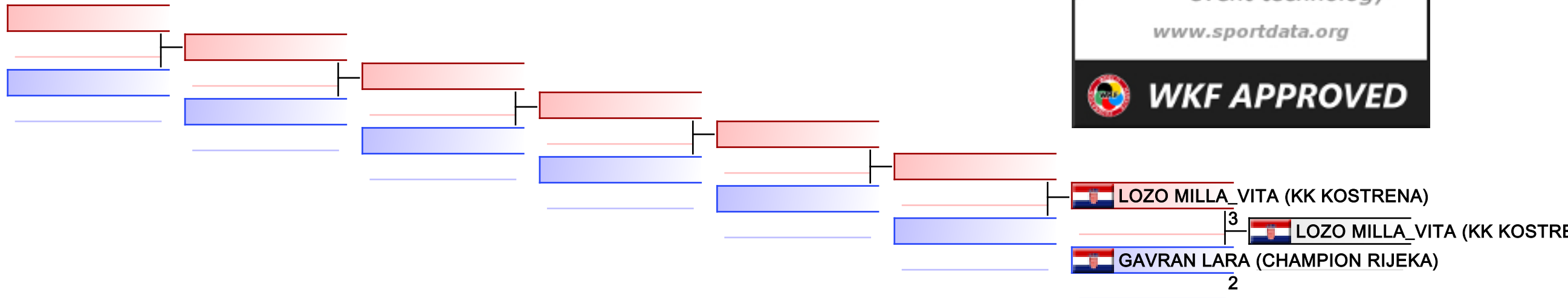

REPECHAGE: (1)

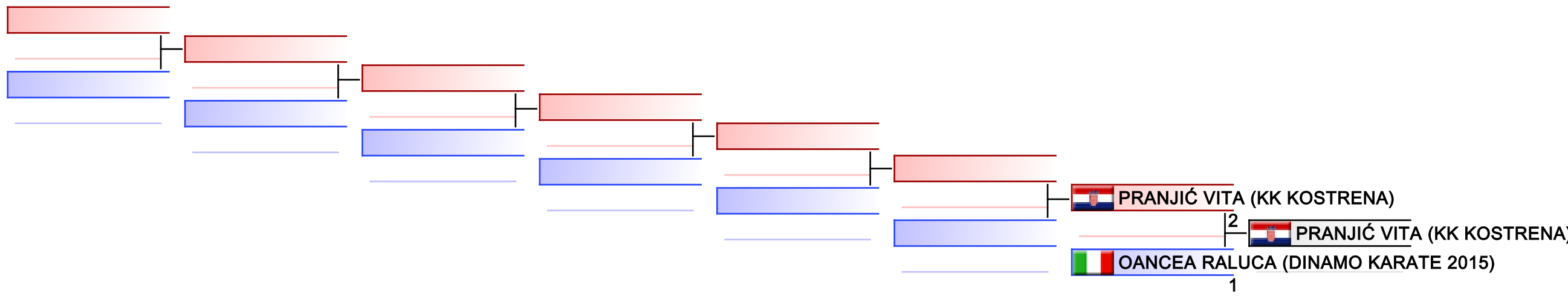

Referees:							
-----------	--	--	--	--	--	--	--

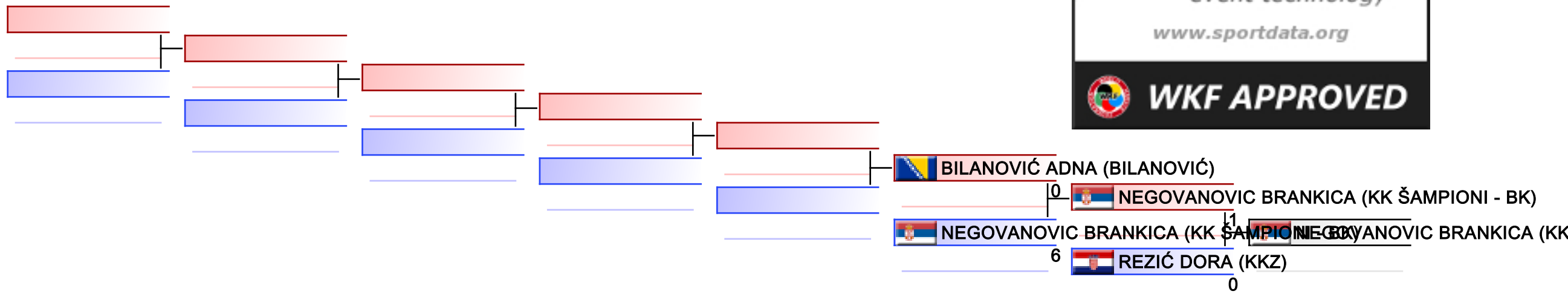

REPECHAGE: (1)

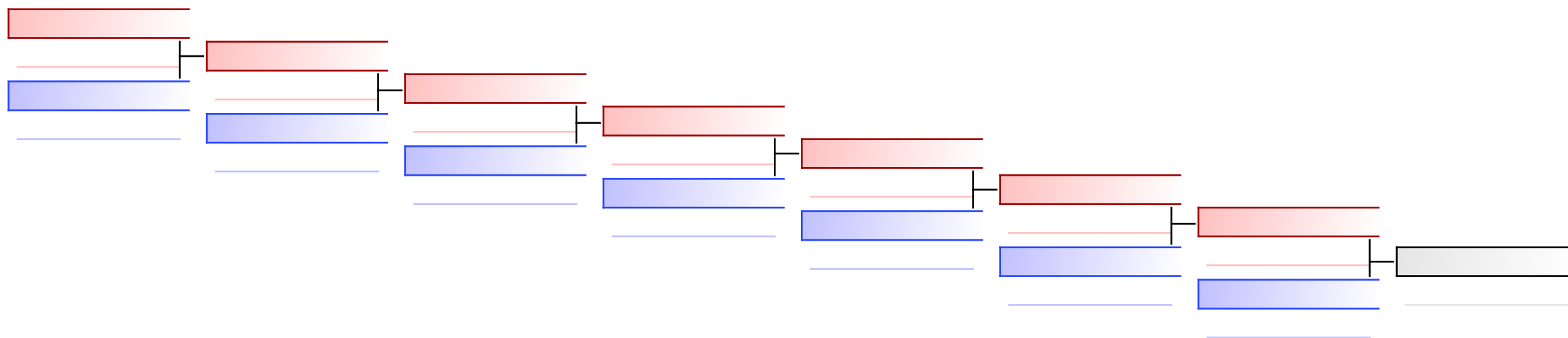

Referees:							
-----------	--	--	--	--	--	--	--

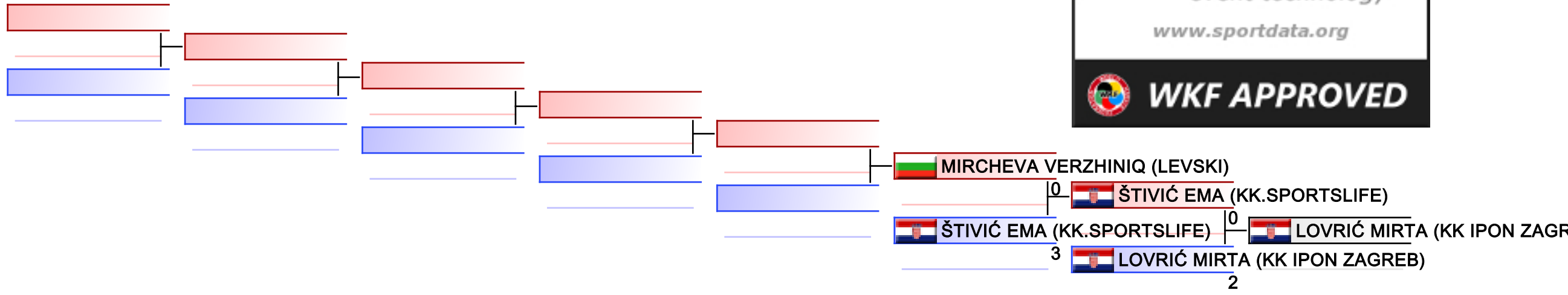

REPECHAGE: (2)

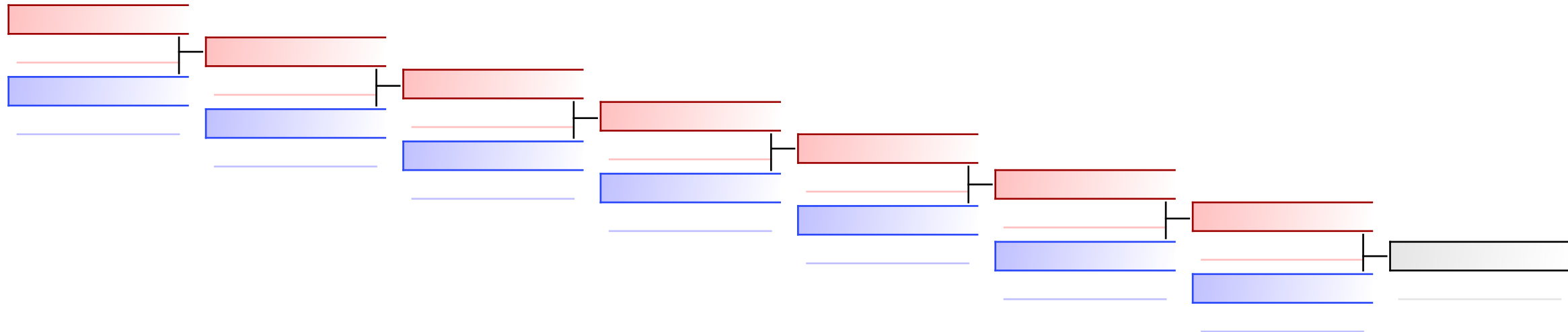

Referees:							
-----------	--	--	--	--	--	--	--

Kumite Female U21 + 68kg
31ST KARATE GRAND PRIX CROATIA

2023-01-21

Tatami
3 09:45

Pool
1

(c)sportdata GmbH & Co KG 2000-2023 (2023-01-22 22:23) v 10.0.0 build 1 (2023-01-19) License: Online_Event_ID-6798_31STKARATEGRANDPRIXCROATIA (expire 2023-02-05)

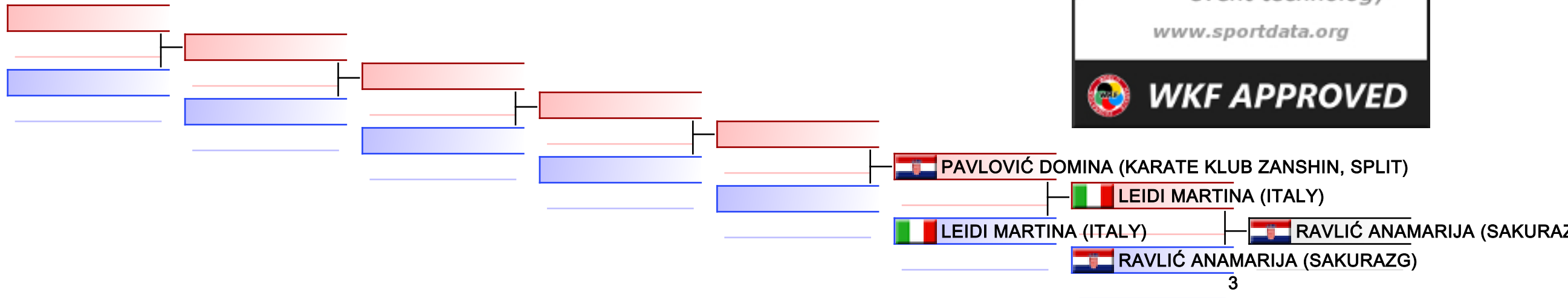

REPECHAGE: (1)

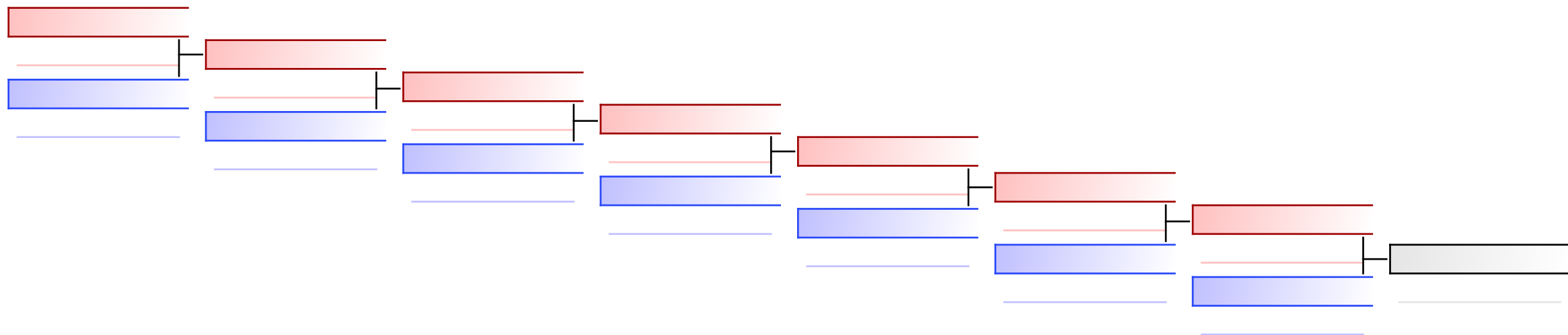

Referees:							
-----------	--	--	--	--	--	--	--

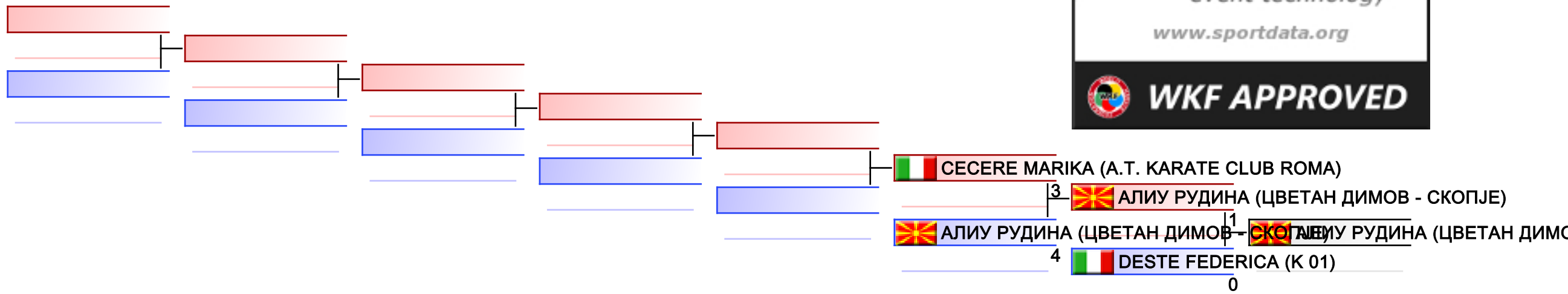

REPECHAGE: (1)

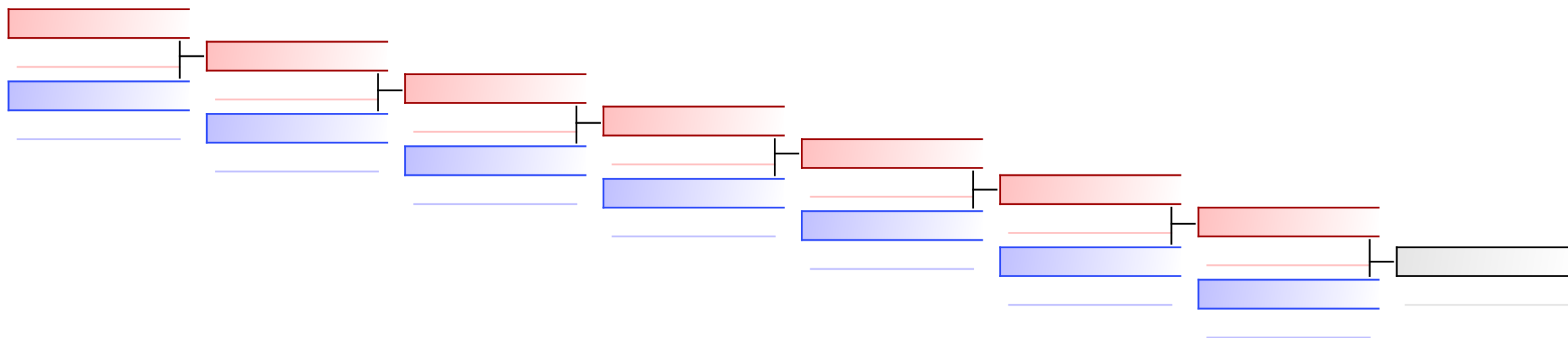

Referees:							
-----------	--	--	--	--	--	--	--

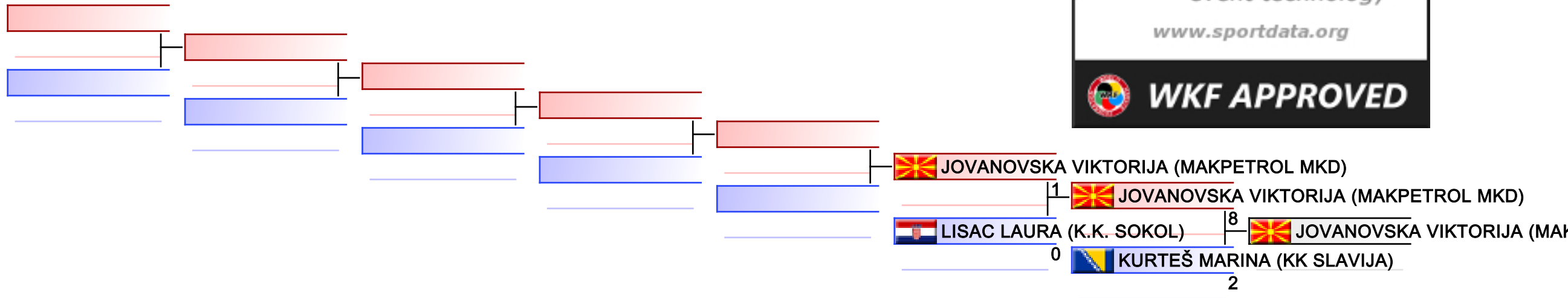

REPECHAGE: (2)

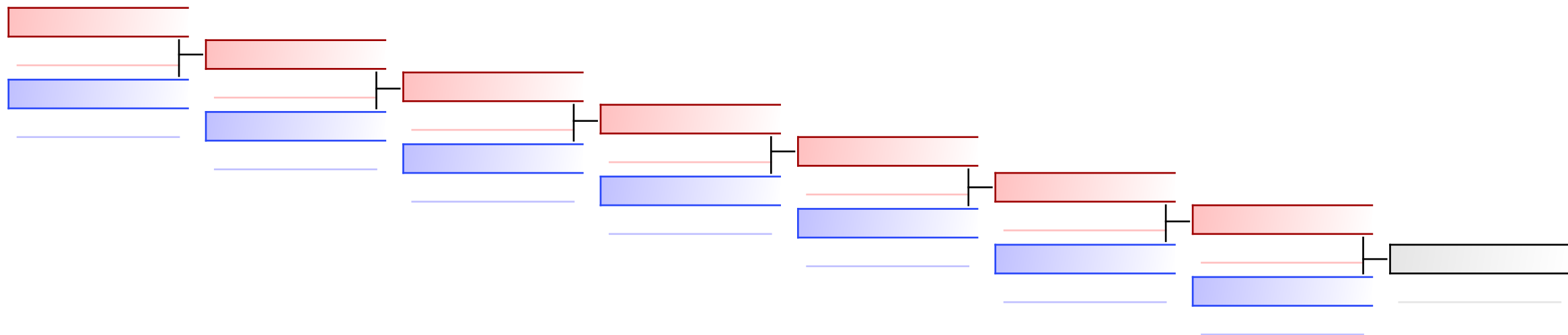

Referees:							
-----------	--	--	--	--	--	--	--

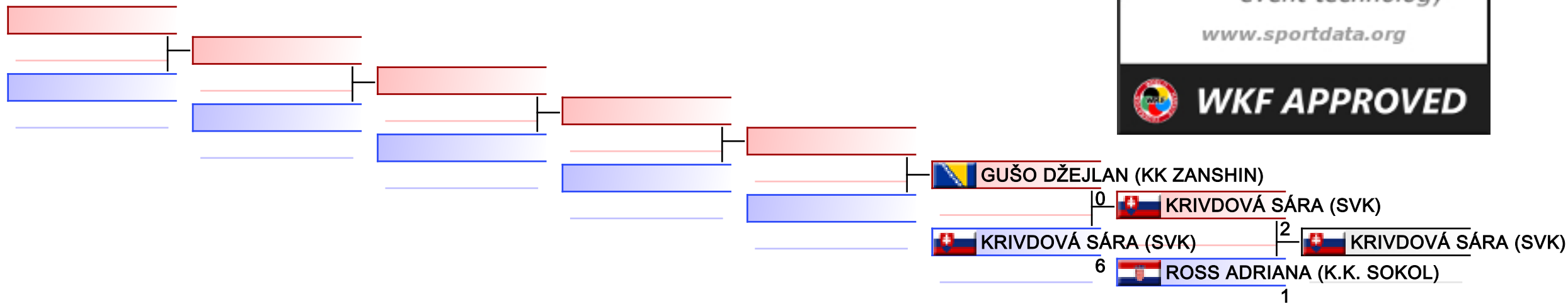

REPECHAGE: (1)

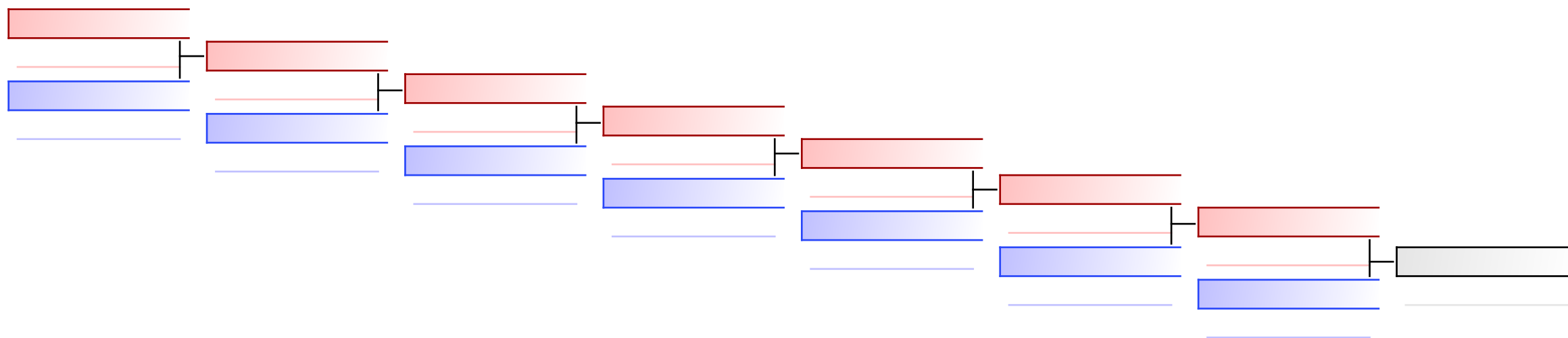

Referees:							
-----------	--	--	--	--	--	--	--

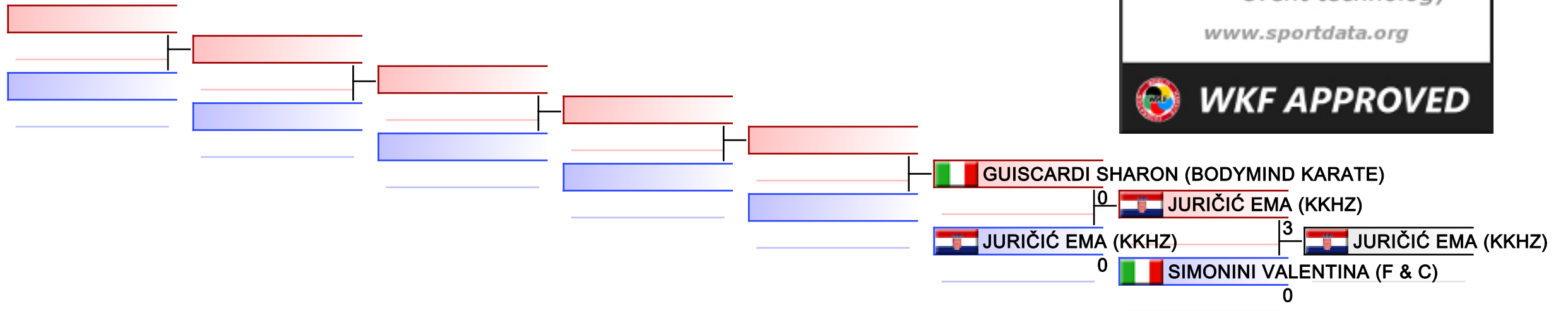

REPECHAGE: (2)

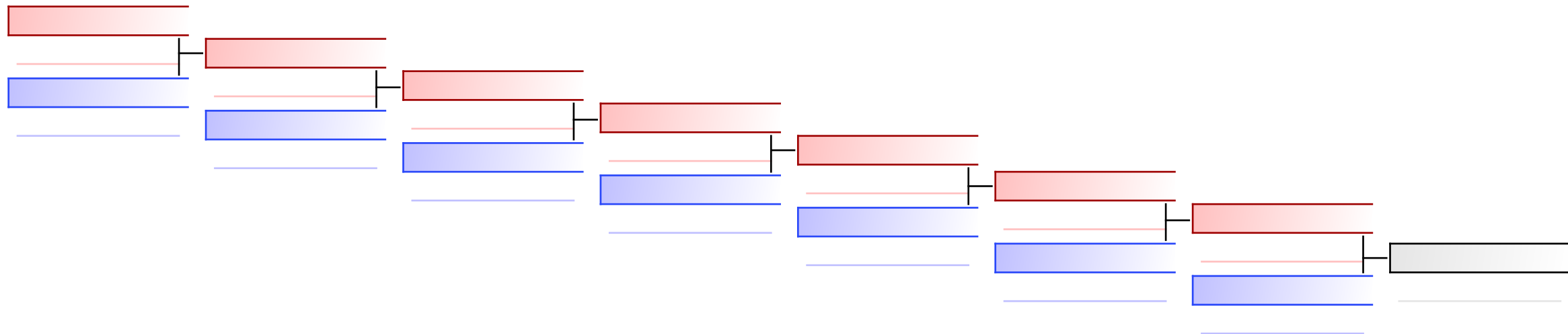

Referees:							
-----------	--	--	--	--	--	--	--

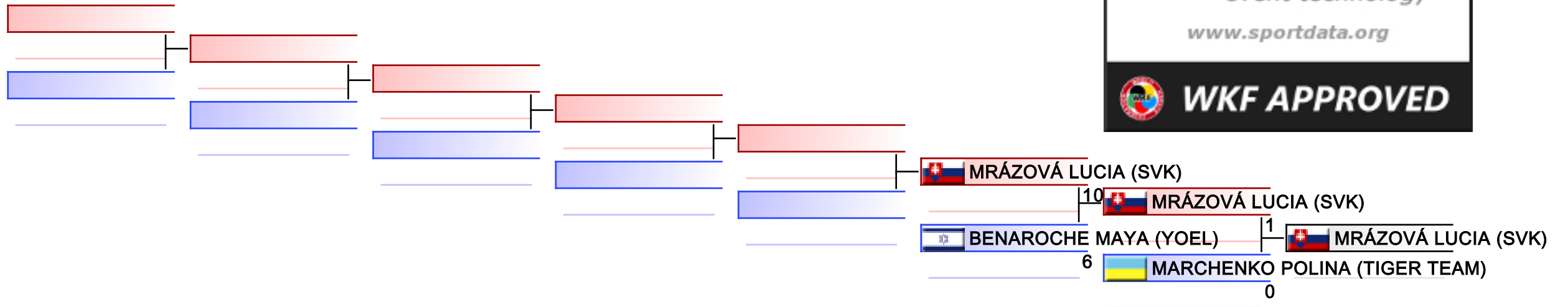

REPECHAGE: (2)

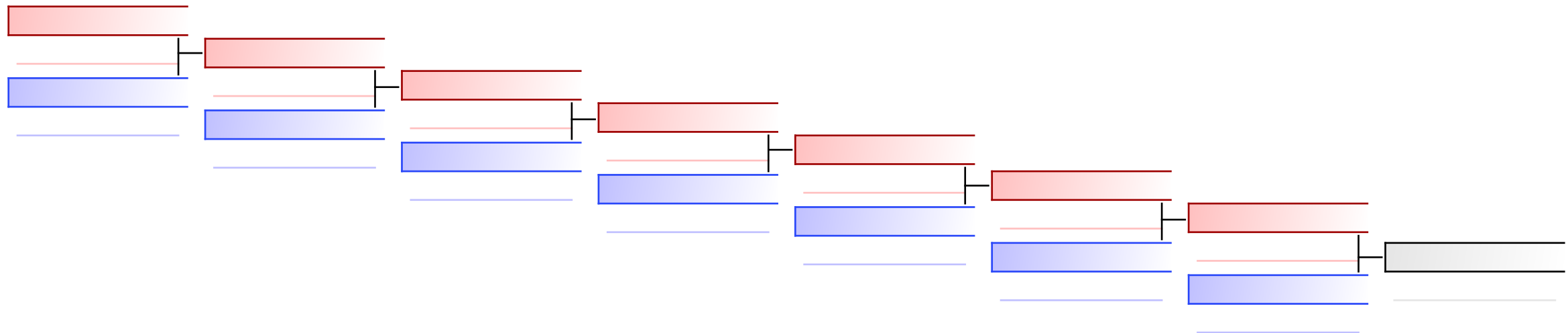

Referees:							
-----------	--	--	--	--	--	--	--

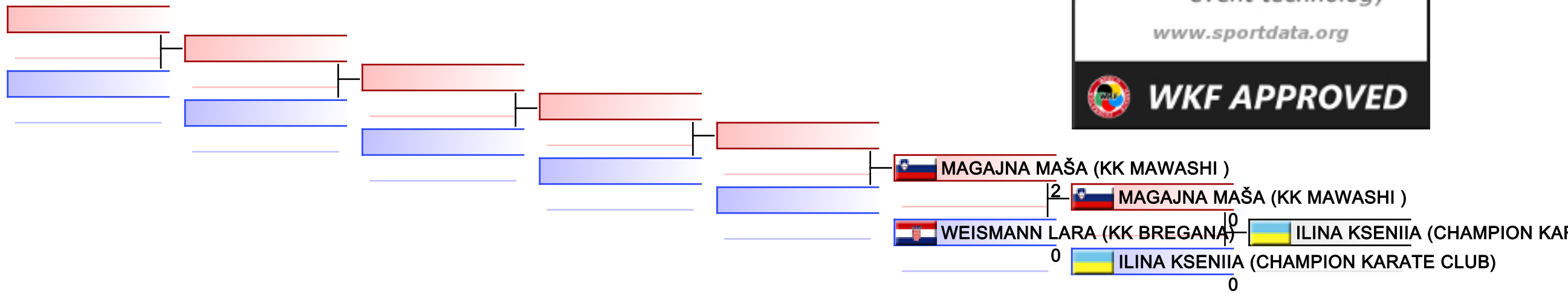

REPECHAGE: (1)

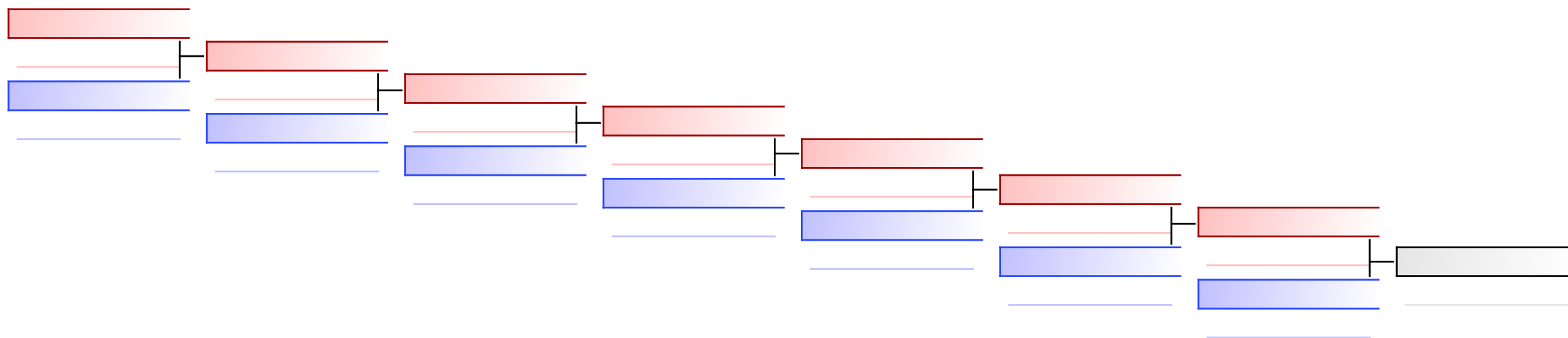

Referees:							
-----------	--	--	--	--	--	--	--

KUMITE GIRLS 9-10 YEARS -35kg

31ST KARATE GRAND PRIX CROATIA

2023-01-22

Tatami
2 15:45

Pool
1

(c)sportdata GmbH & Co KG 2000-2023 (2023-01-22 22:23) v 10.0.0 build 1 (2023-01-19) License: Online_Event_ID-6798_31STKARATEGRANDPRIXCROATIA (expire 2023-02-05)

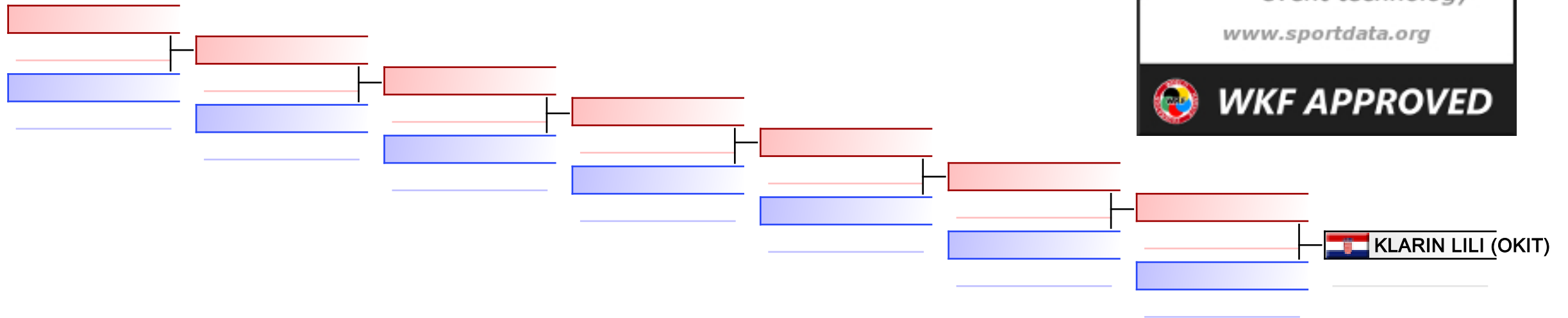

REPECHAGE: (1)

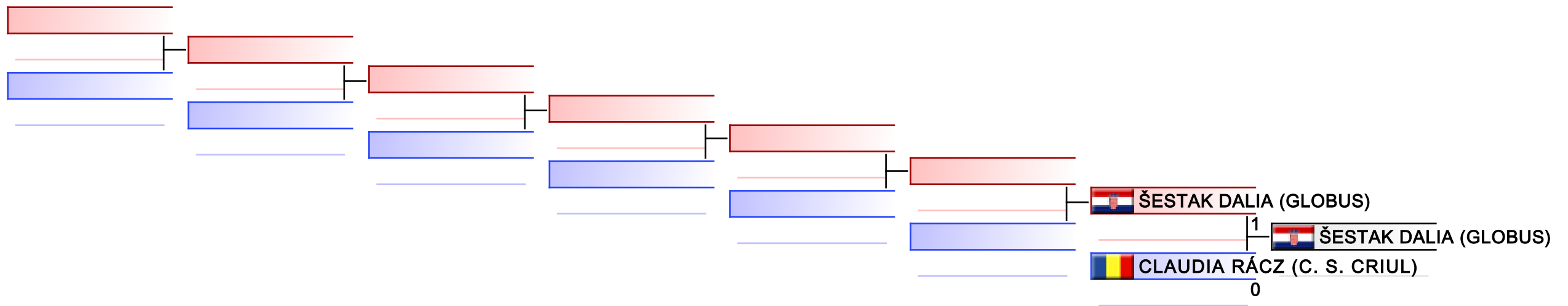

Referees:							
-----------	--	--	--	--	--	--	--

KUMITE GIRLS 9-10 YEARS -39kg

31ST KARATE GRAND PRIX CROATIA

2023-01-22

Tatami
2 16:05

Pool
1

(c)sportdata GmbH & Co KG 2000-2023 (2023-01-22 22:23) v 10.0.0 build 1 (2023-01-19) License: Online_Event_ID-6798_31STKARATEGRANDPRIXCROATIA (expire 2023-02-05)

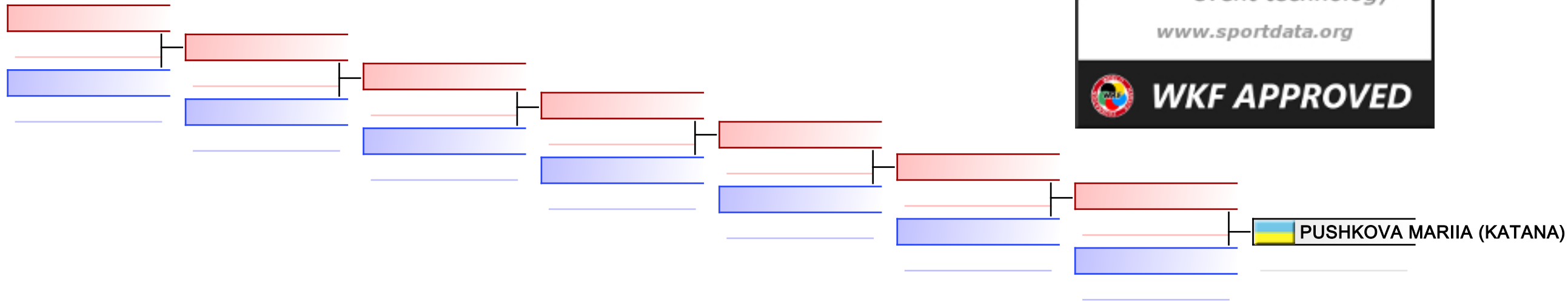

REPECHAGE: (1)

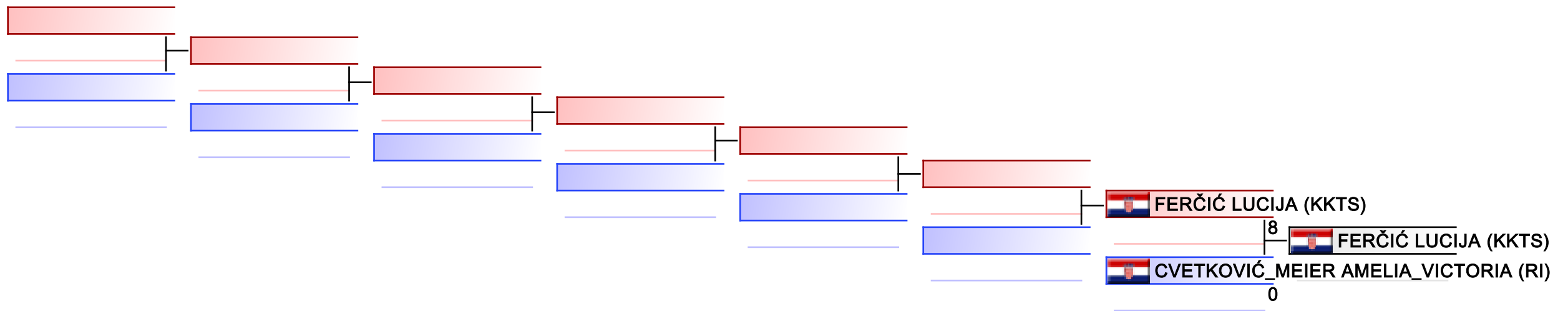

Referees:							
-----------	--	--	--	--	--	--	--

31ST KARATE GRAND PRIX CROATIA - 2023-01-20
K11 - MALE SENIORS VISUALLY IMPAIRED

R1 G1/1 (1)

	Competitors	Kata	1	2	3	4	5	6	7	TOTAL	Extra Total Rank
1	ŠTEKO JOSIP (KK ALFA)	015 GANKAKU	8.6	(7.6)	8.2	8.4	(9.2)			25.2	25.2 1

Results

1	ŠTEKO JOSIP	KARATE KLUB ALFA		CROATIA
---	-------------	------------------	---	---------

31ST KARATE GRAND PRIX CROATIA - 2023-01-20
K12 - MALE SENIORS VISUALLY IMPAIRED

R1 G1/1 (1)

Competitors	Kata	1	2	3	4	5	6	7	TOTAL	Extra Total Rank
1 BATICAN ALWYN (AAK PHILIPPINES)										

31ST KARATE GRAND PRIX CROATIA - 2023-01-20
K21 - MALE SENIORS
INTELLECTUALLY IMPAIRED

R1 G1/1 (1)

	Competitors	Kata	1	2	3	4	5	6	7	TOTAL	Extra Total Rank
1	VEDELAGO CHRISTIAN (KANAZAWA CIMADOLMO)	036 JION	(7.6)	7.0	7.0	(6.5)	7.3			21.3	21.3 1

Results



1	VEDELAGO CHRISTIAN	ASD KARATE CLUB KANAZAWA		ITALY
---	--------------------	--------------------------	---	-------

31ST KARATE GRAND PRIX CROATIA - 2023-01-20
K22 - MALE SENIORS
INTELLECTUALLY IMPAIRED

R1 G1/1 (3)

	Competitors	Kata	1	2	3	4	5	6	7	TOTAL	Extra Total Rank
1	FELETTI GIANLUIGI (KANAZAWA CIMADOLMO)	036 JION	7.0	7.5	(6.3)	(7.6)	6.9			21.4	3
2	BARIĆ STIPE (KK ALFA)	099 UNSU	8.0	(8.3)	8.0	(7.9)	8.1			24.1	1
3	BODULJAK ROKO (KK ALFA)	021 GOJUSHIHO SHO	(7.7)	(8.5)	7.7	7.7	7.9			23.3	2

Results

1	BARIC STIPE	KARATE KLUB ALFA		CROATIA
2	BODULJAK ROKO	KARATE KLUB ALFA		CROATIA
3	FELETTI GIANLUIGI	ASD KARATE CLUB KANAZAWA		ITALY

31ST KARATE GRAND PRIX CROATIA - 2023-01-20
**K30 - MALE CADETS/
 JUNIORS WHEELCHAIR USERS**

R1 G1/1 (1)

Competitors	Kata	1 T	1 A	2 T	2 A	3 T	3 A	4 T	4 A	5 T	5 A	6 T	6 A	7 T	7 A	TEC	ATH	Extra	Total	Rank	
1	MOLNÁR MATTHIAS (KKSBA)																				

31ST KARATE GRAND PRIX CROATIA - 2023-01-20
K30 - MALE SENIORS WHEELCHAIR USERS

R1 G1/1 (1)

Competitors		Kata	1 T	1 A	2 T	2 A	3 T	3 A	4 T	4 A	5 T	5 A	6 T	6 A	7 T	7 A	TEC	ATH	Extra	Total	Rank
1	GIUGE MANUEL (POLISPORTIVA TERRAGLIO)	021 GOJUSHIHO SHO	7.4		7.4		(7.3)		(8.0)		8.0						22.8			22.8	1

Results

1	GIUGE MANUEL	SSD POLISPORTIVA TERRAGLIO		ITALY
---	--------------	----------------------------	---	-------

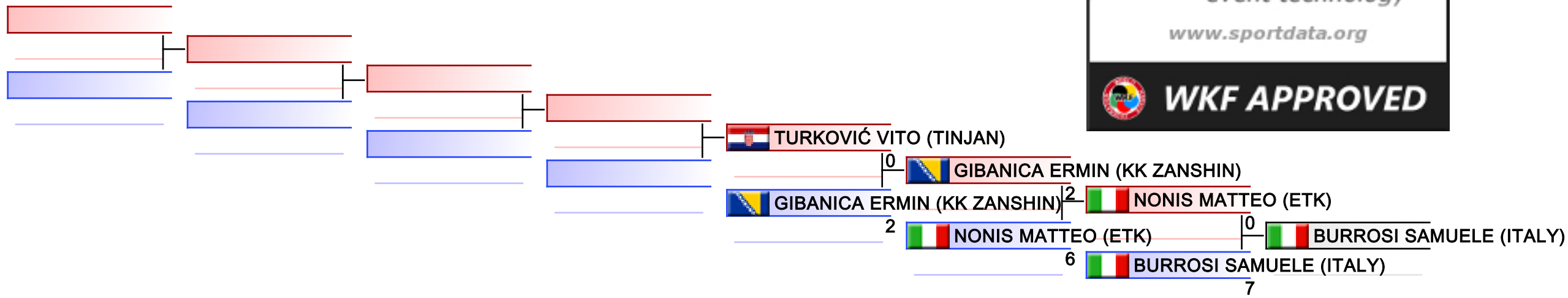

REPECHAGE: (1)

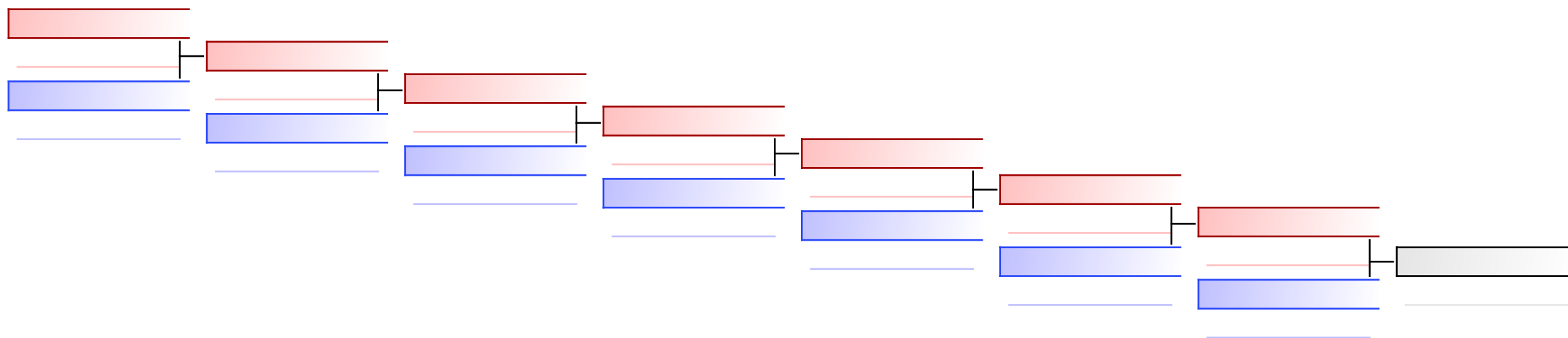

Referees:							
-----------	--	--	--	--	--	--	--

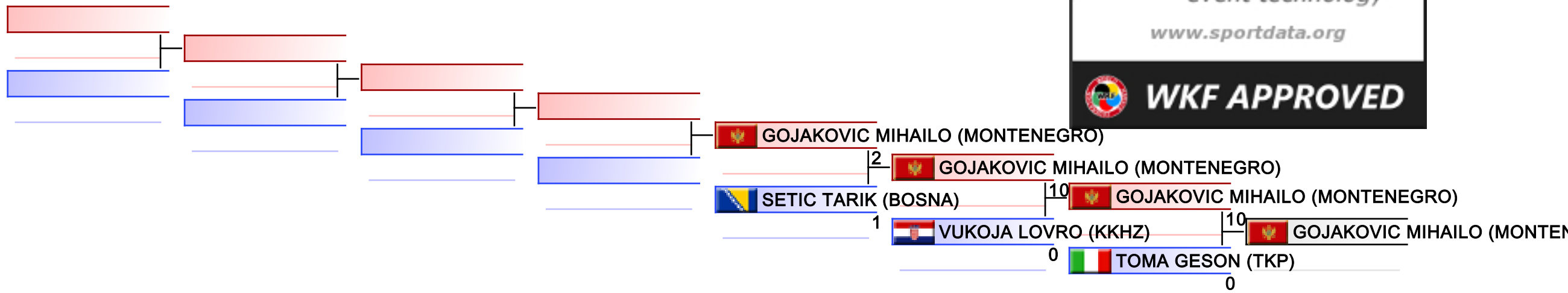

REPECHAGE: (2)

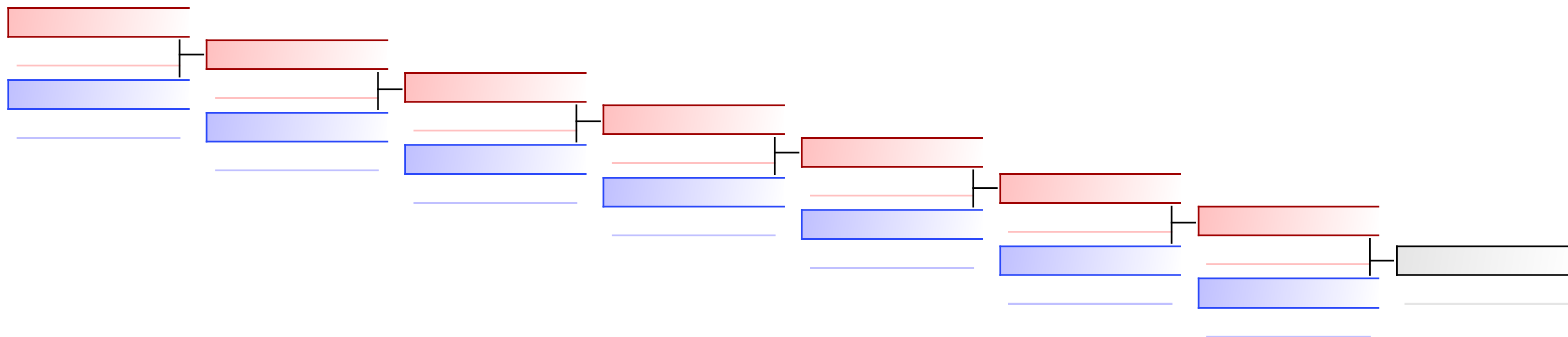

Referees:							
-----------	--	--	--	--	--	--	--

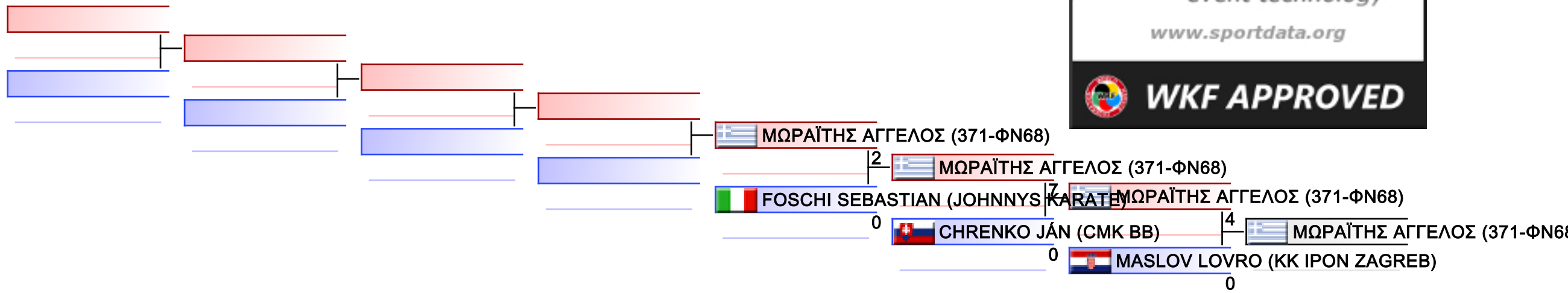

REPECHAGE: (2)

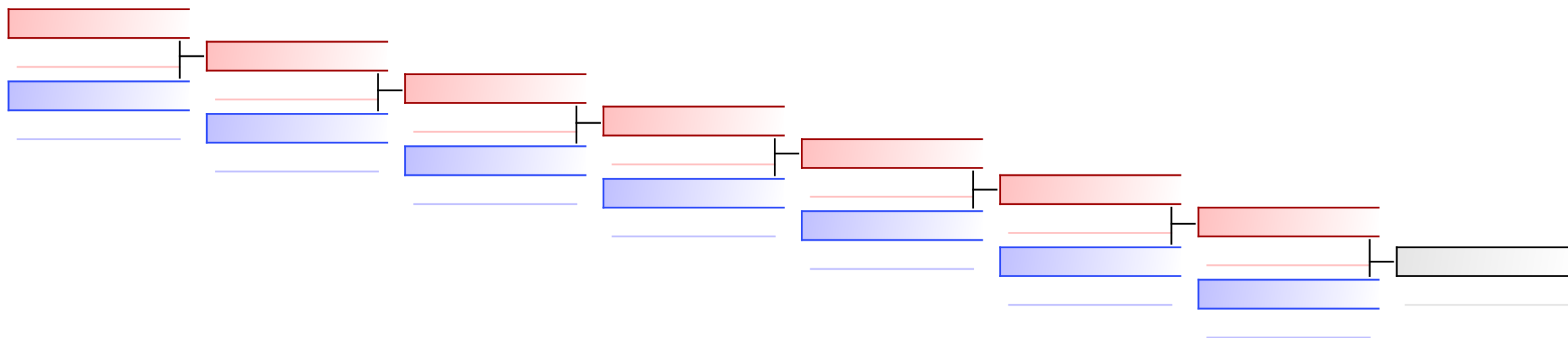

Referees:							
-----------	--	--	--	--	--	--	--

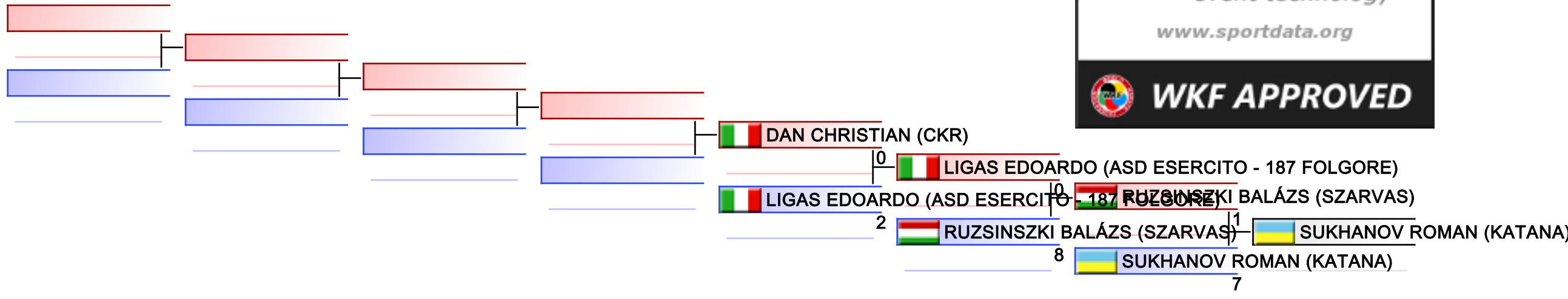

REPECHAGE: (1)

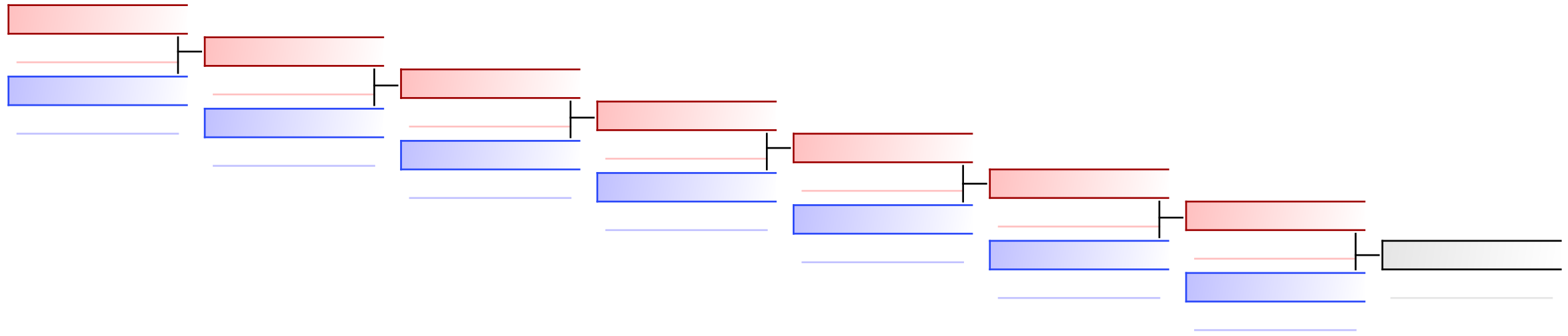

Referees:							
-----------	--	--	--	--	--	--	--

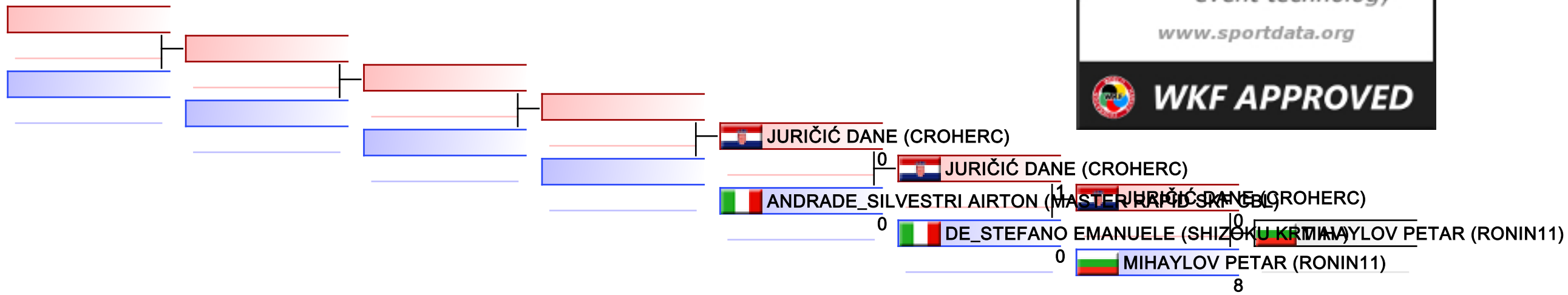

REPECHAGE: (2)

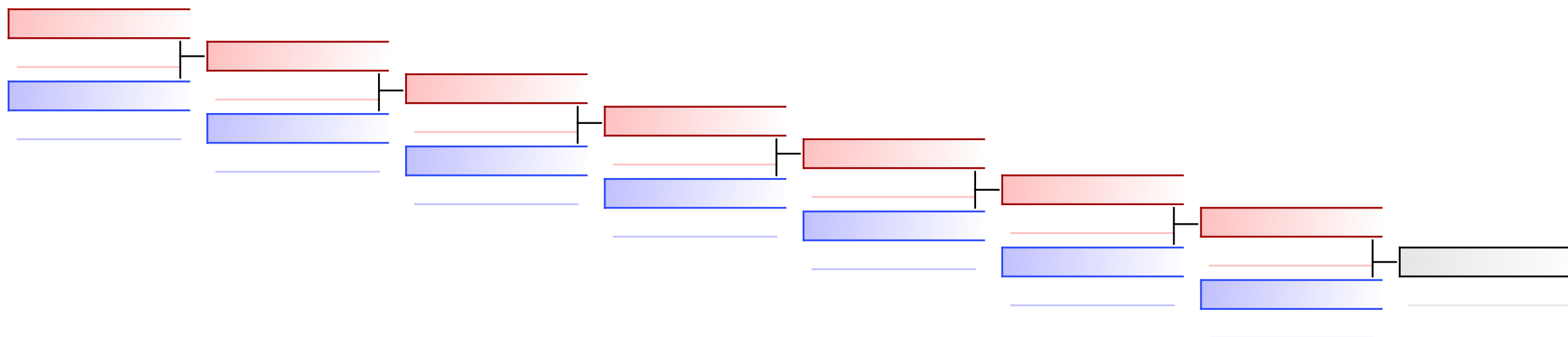

Referees:							
-----------	--	--	--	--	--	--	--

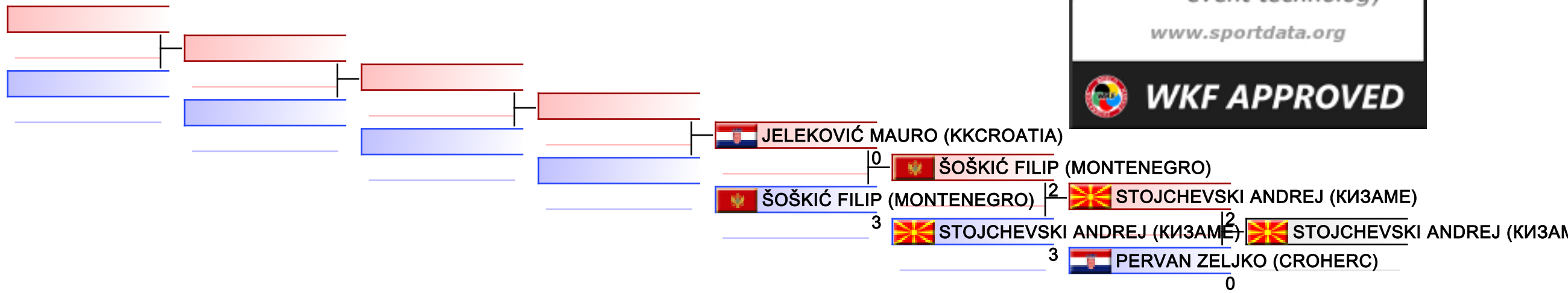

REPECHAGE: (1)

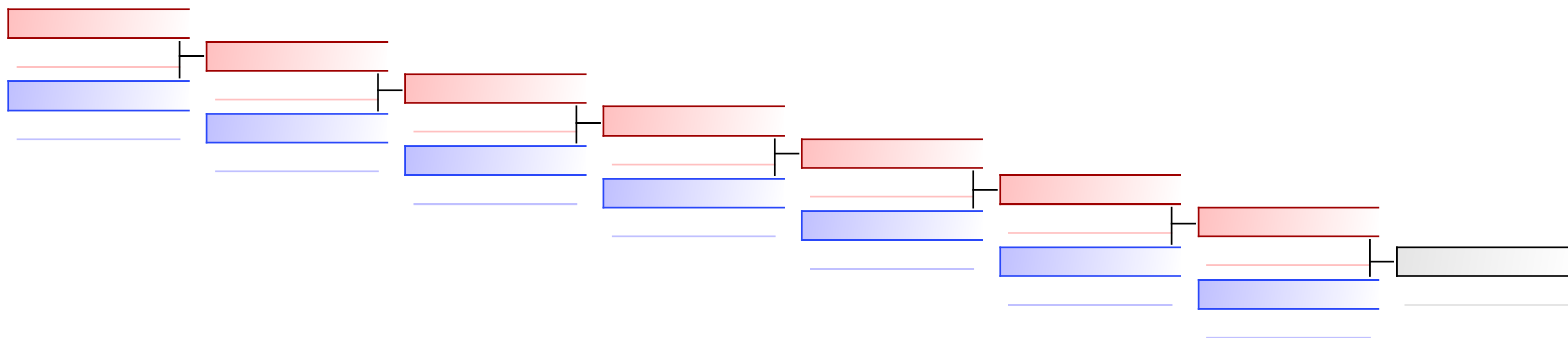

Referees:							
-----------	--	--	--	--	--	--	--

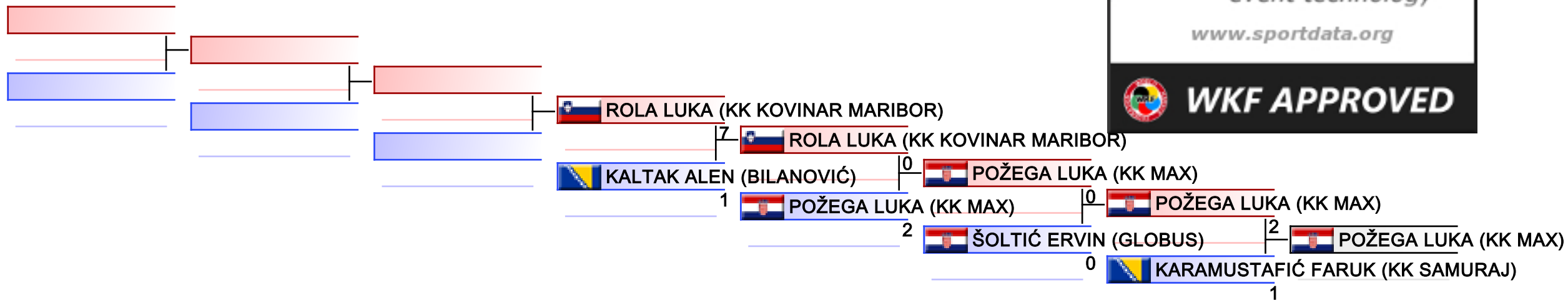

REPECHAGE: (2)

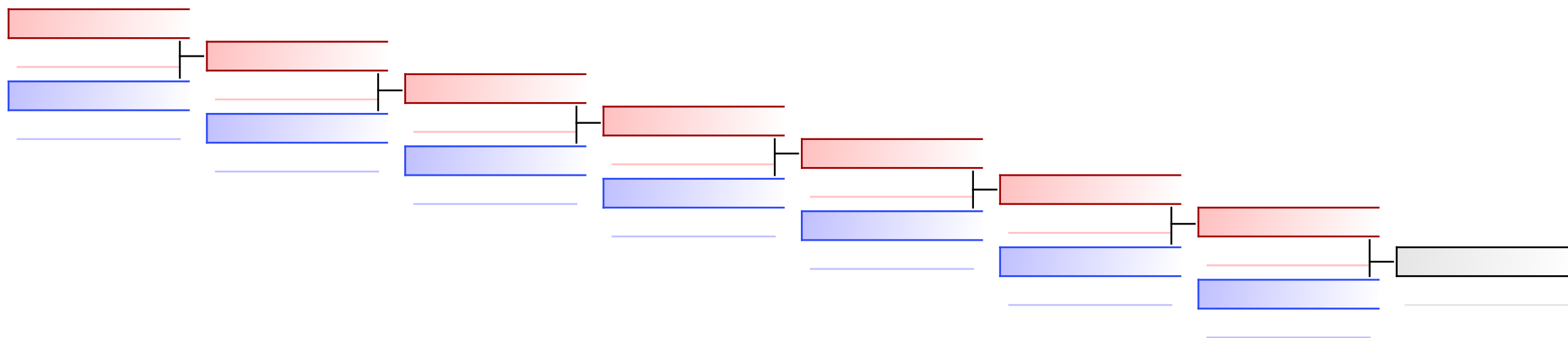

Referees:							
-----------	--	--	--	--	--	--	--

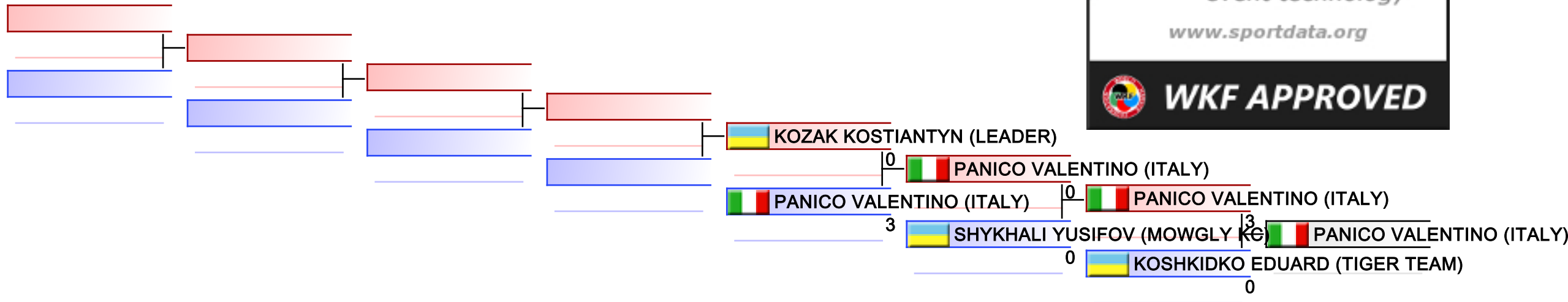

REPECHAGE: (1)

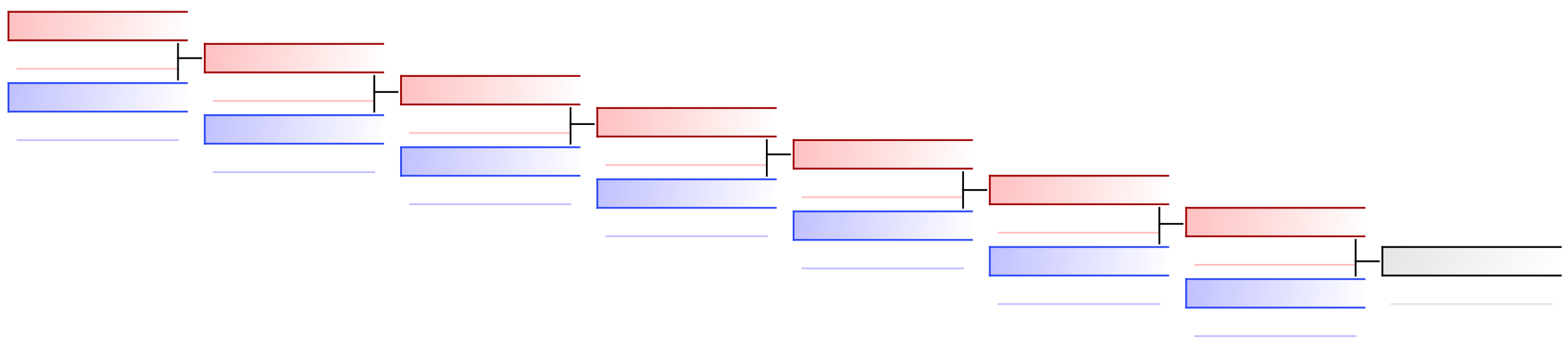

Referees:							
-----------	--	--	--	--	--	--	--

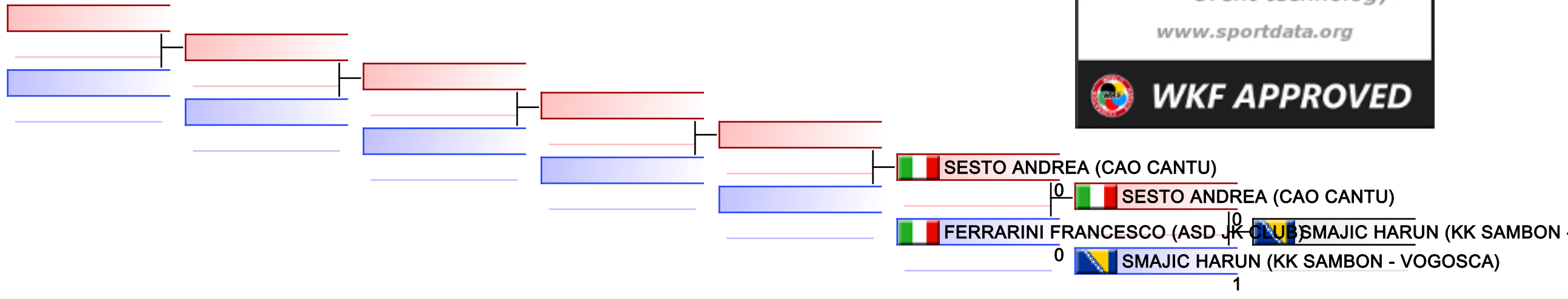

REPECHAGE: (2)

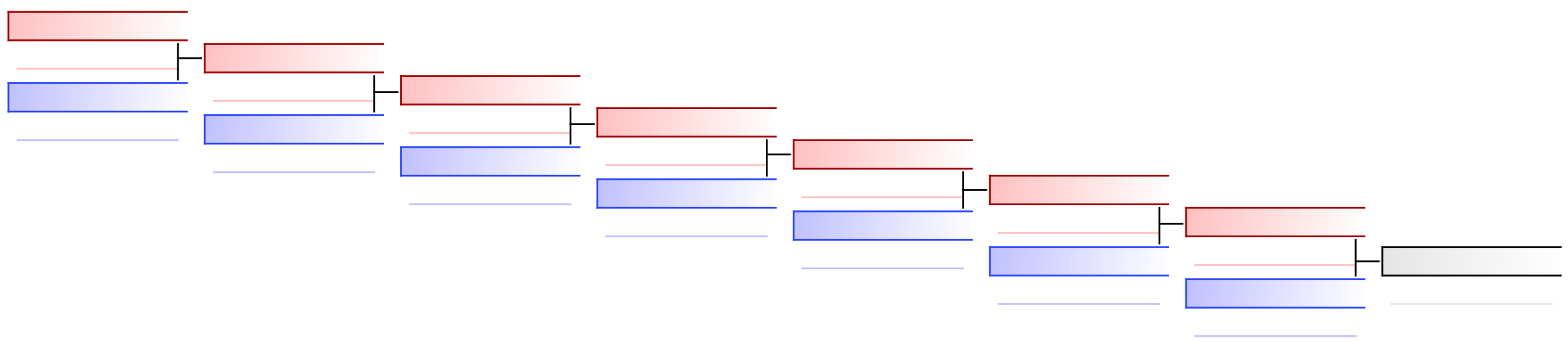

Referees:							
-----------	--	--	--	--	--	--	--

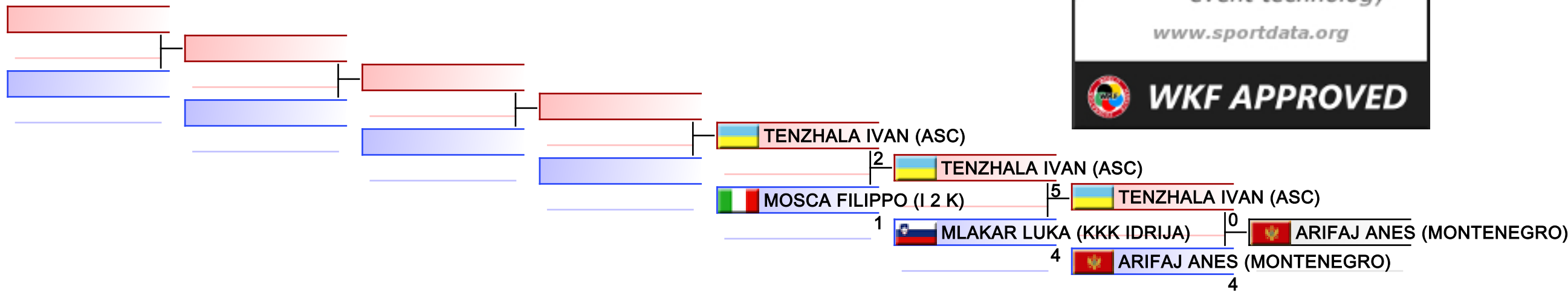

REPECHAGE: (1)

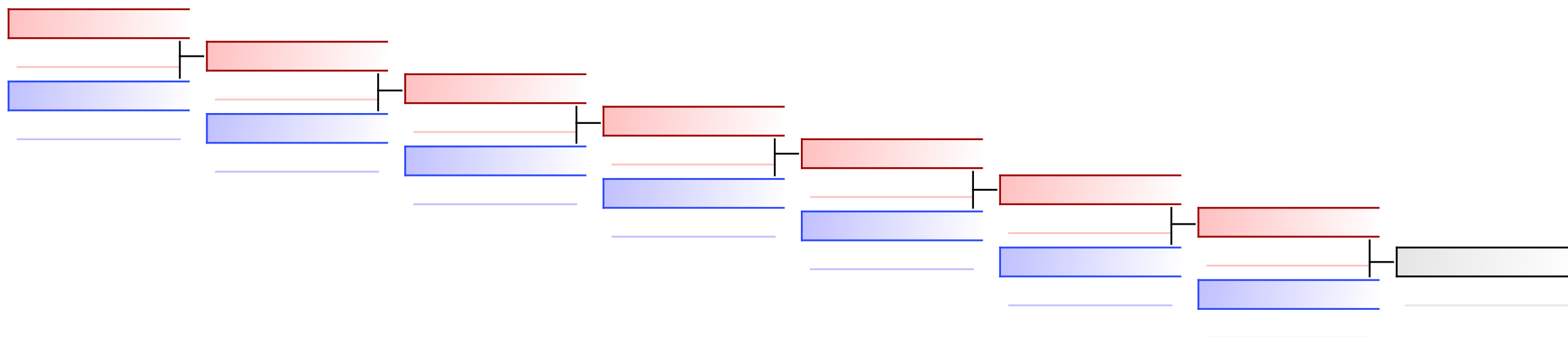

Referees:							
-----------	--	--	--	--	--	--	--

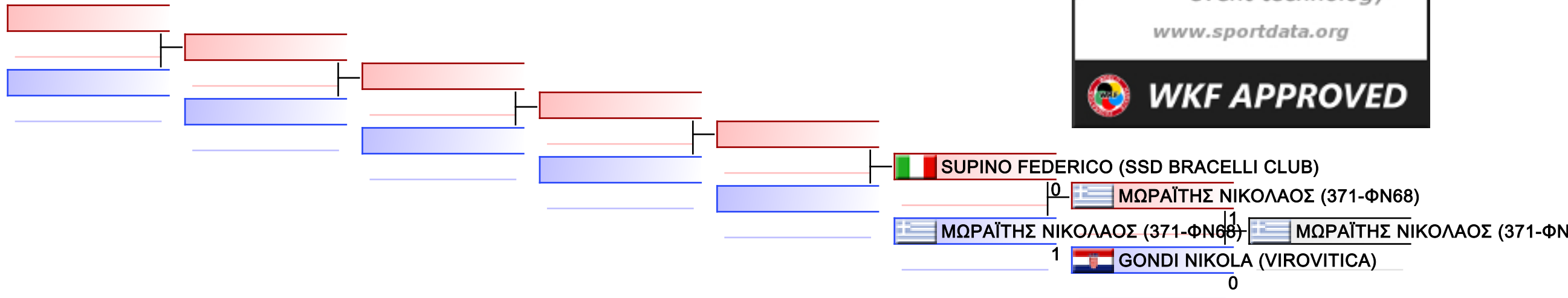

REPECHAGE: (2)

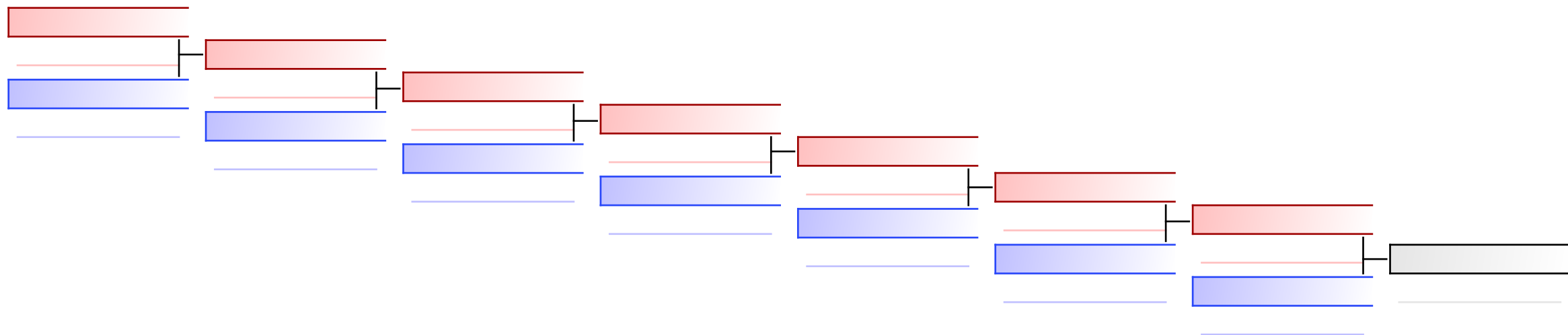

Referees:							
-----------	--	--	--	--	--	--	--

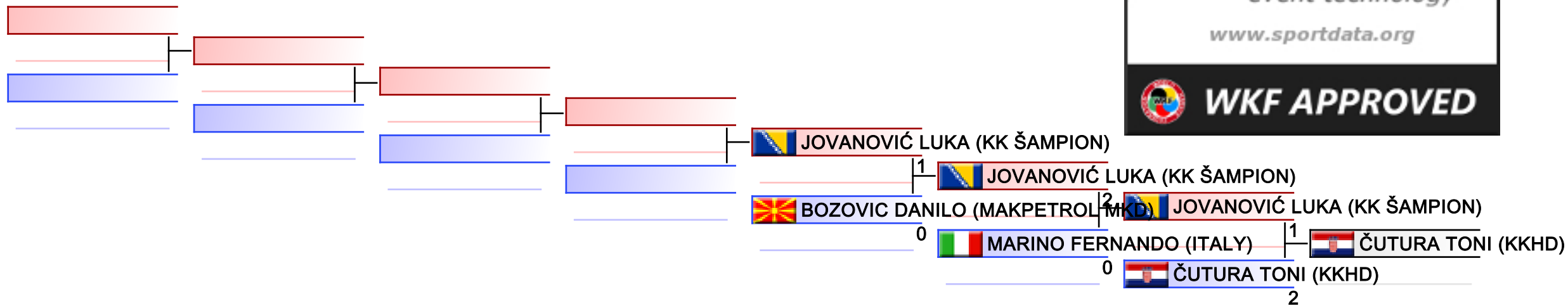

REPECHAGE: (1)

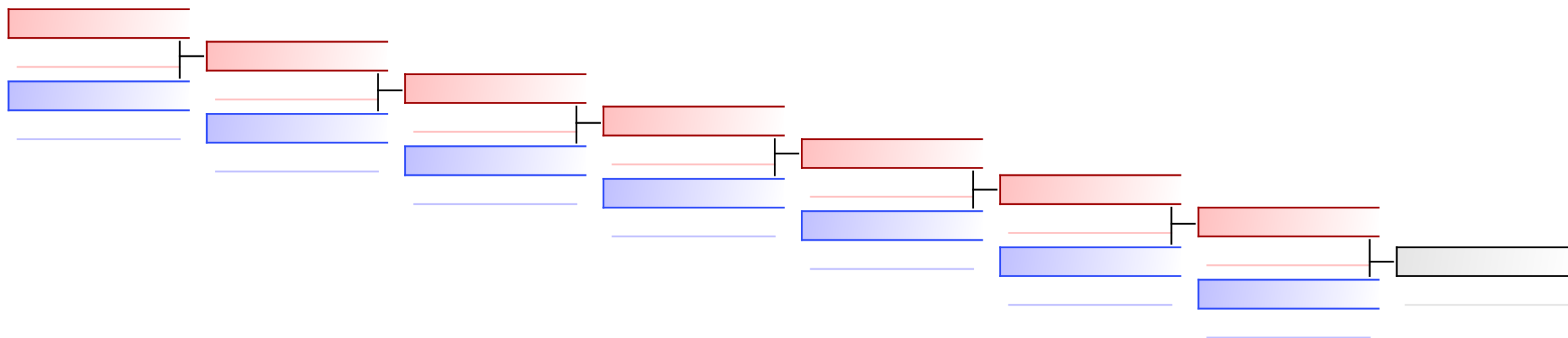

Referees:							
-----------	--	--	--	--	--	--	--

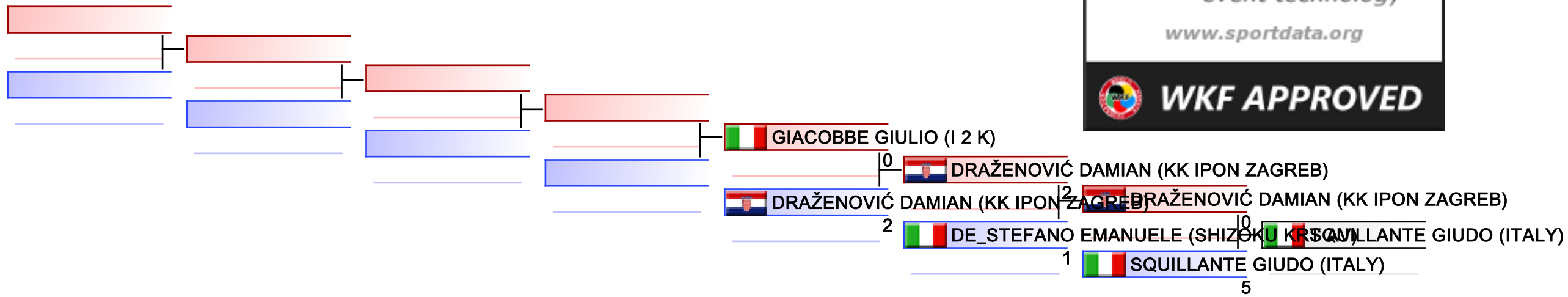

REPECHAGE: (2)

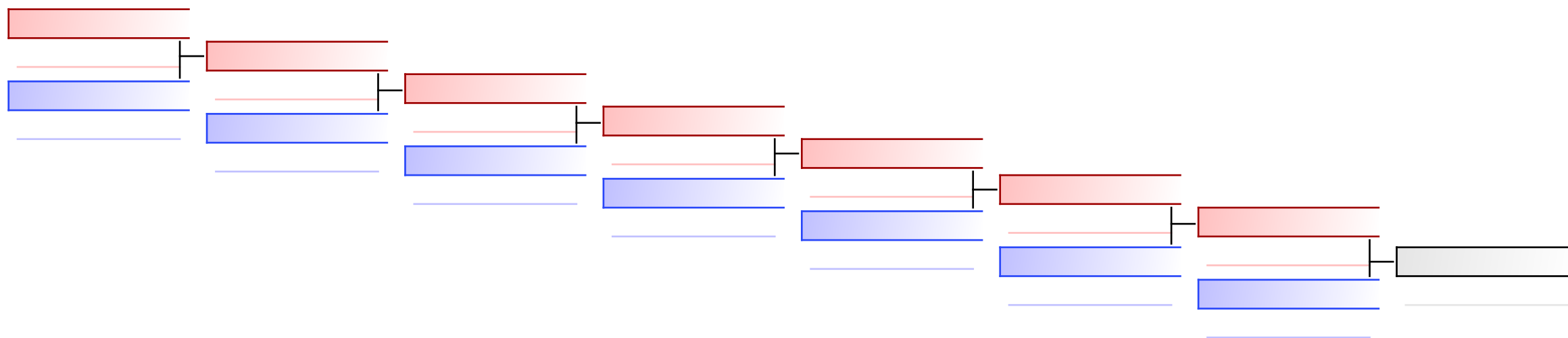

Referees:							
-----------	--	--	--	--	--	--	--

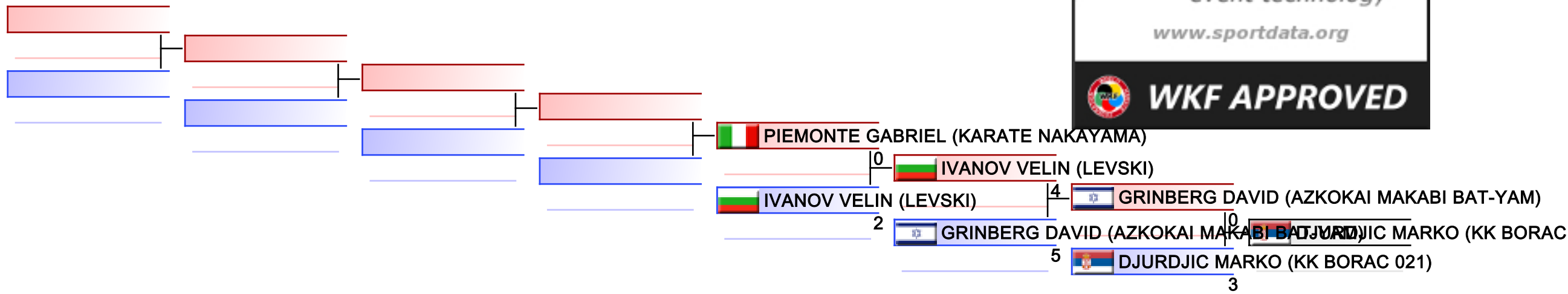

REPECHAGE: (1)

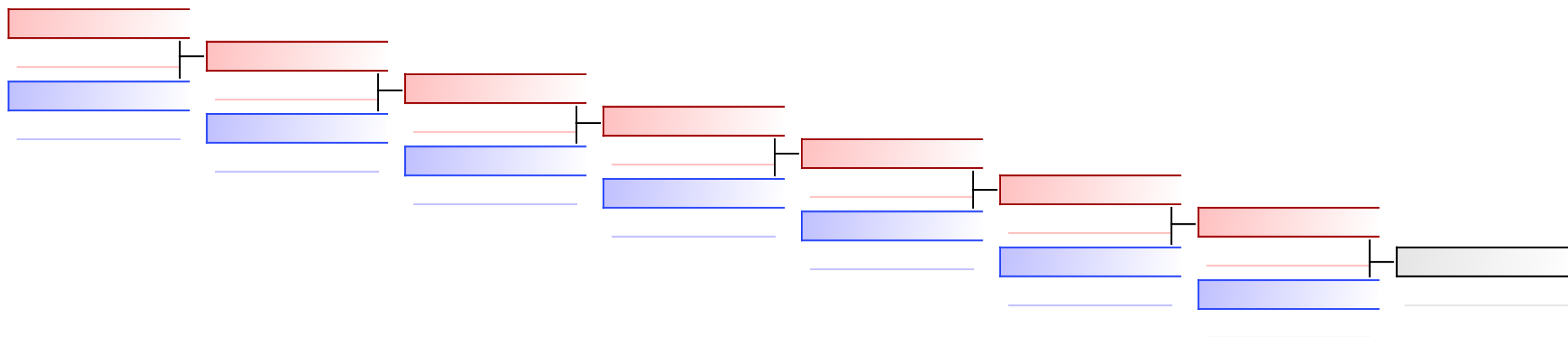

Referees:							
-----------	--	--	--	--	--	--	--

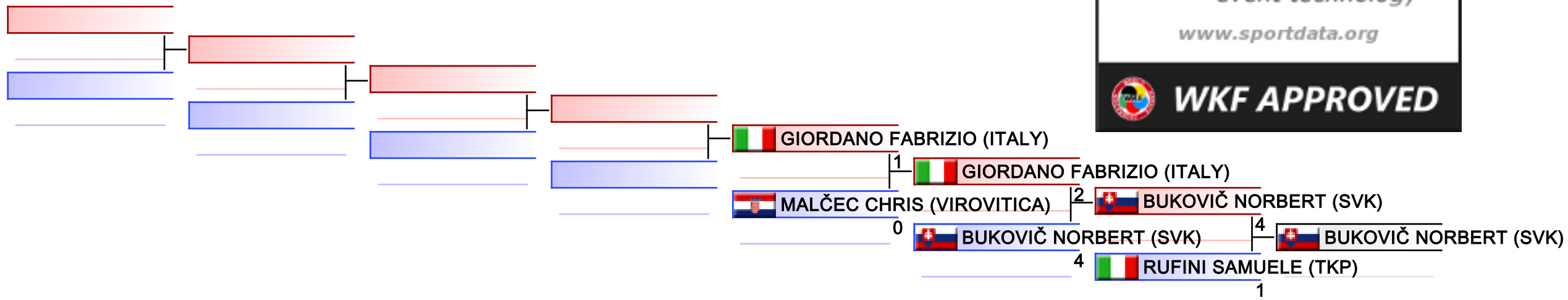

REPECHAGE: (2)

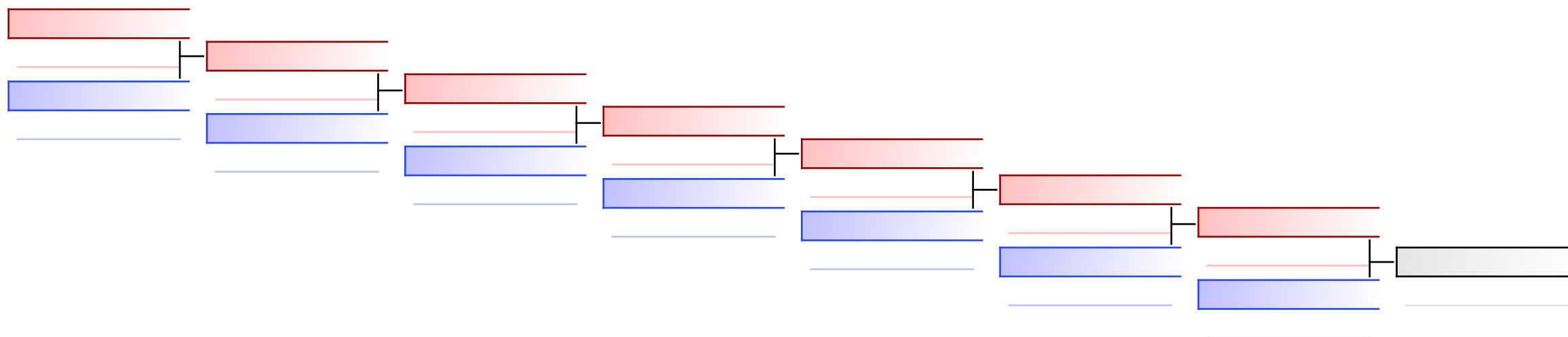

Referees:							
-----------	--	--	--	--	--	--	--

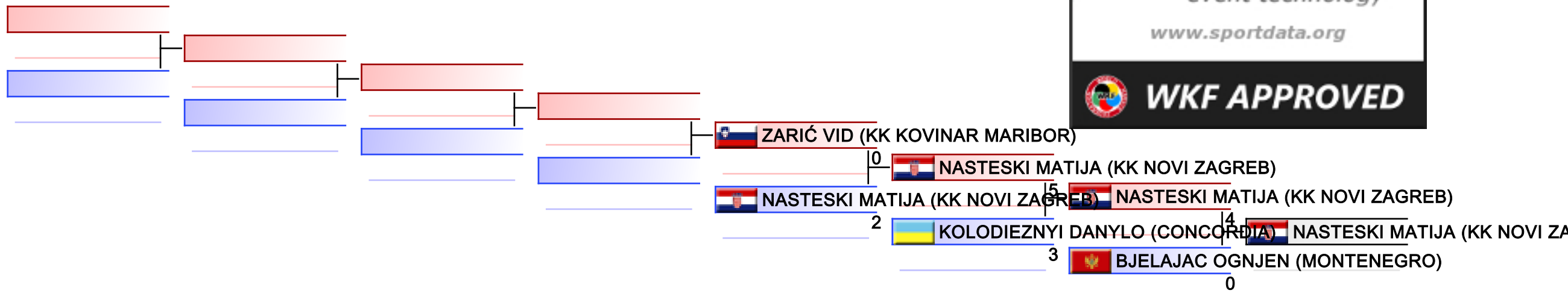

REPECHAGE: (1)

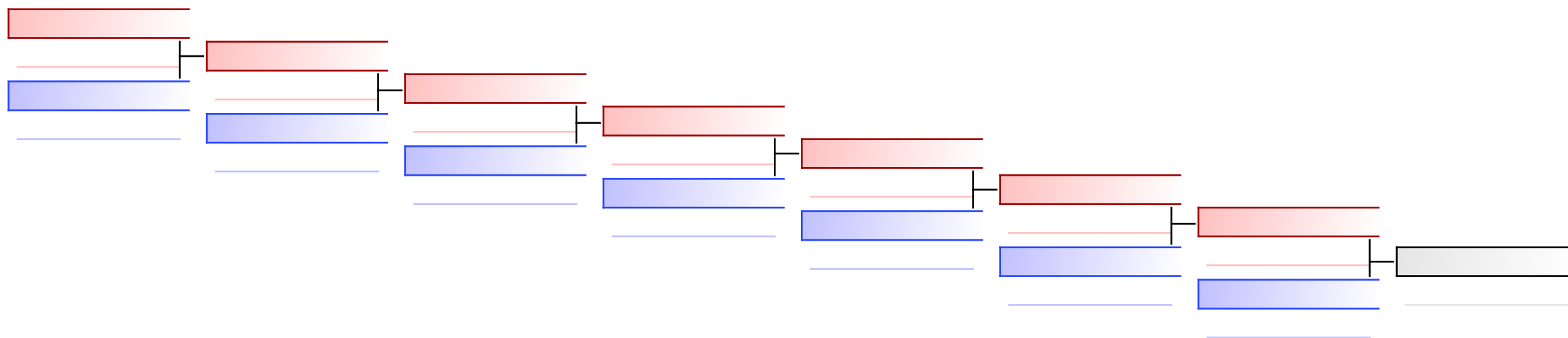

Referees:							
-----------	--	--	--	--	--	--	--

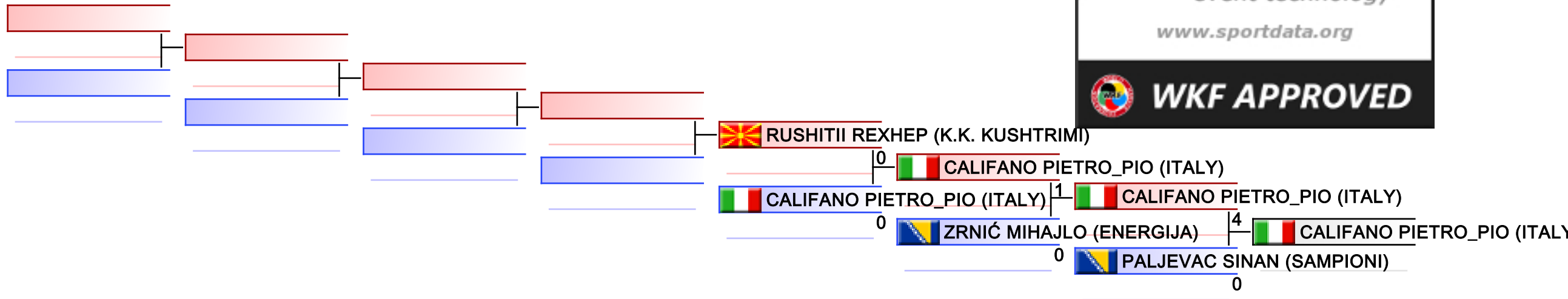

REPECHAGE: (2)

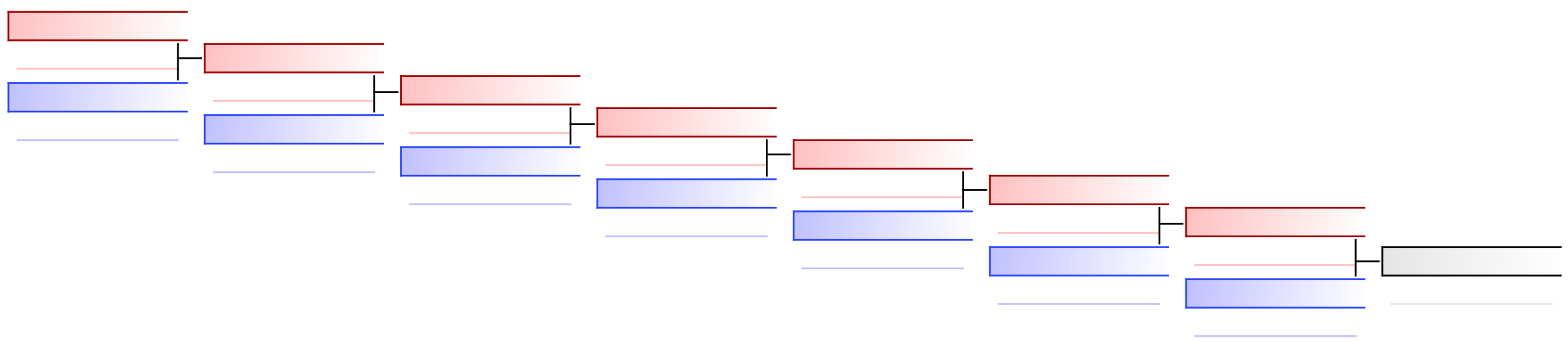

Referees:							
-----------	--	--	--	--	--	--	--

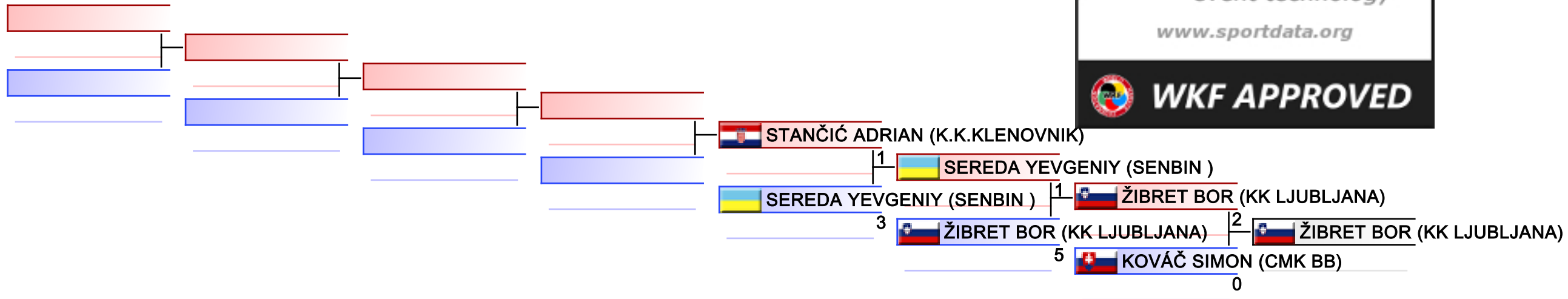

REPECHAGE: (1)

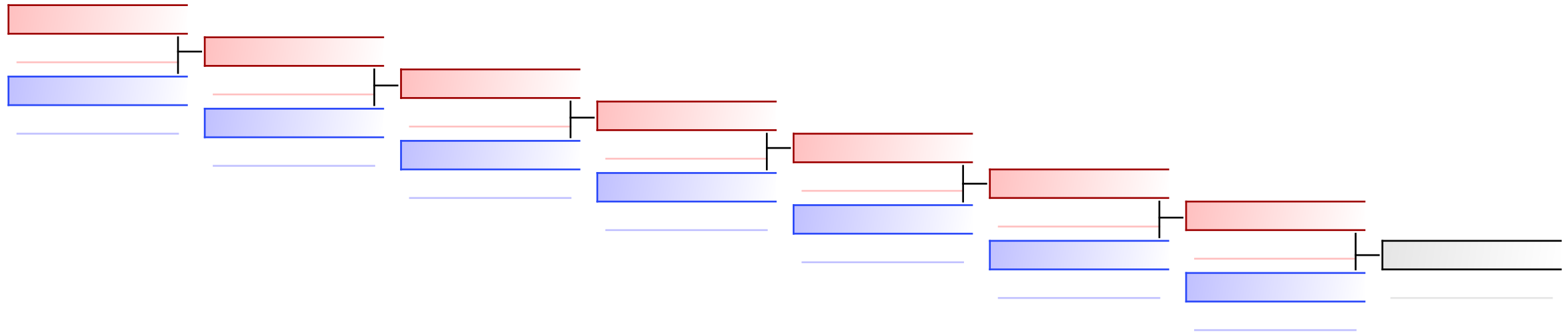

Referees:							
-----------	--	--	--	--	--	--	--

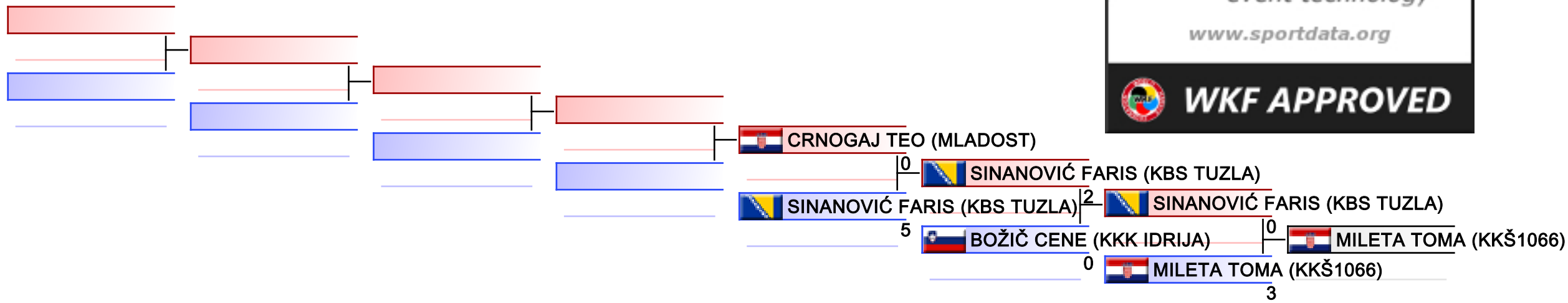

REPECHAGE: (2)

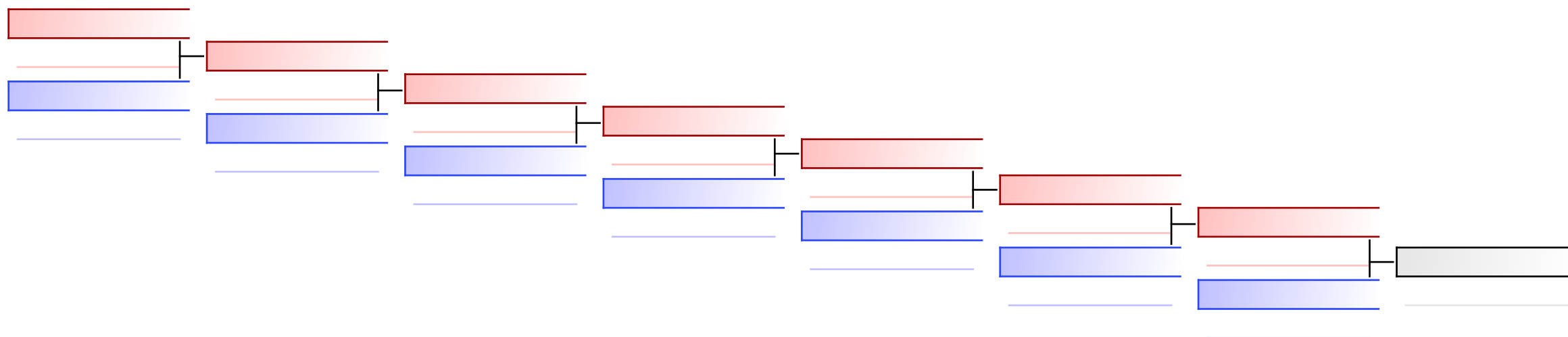

Referees:							
-----------	--	--	--	--	--	--	--

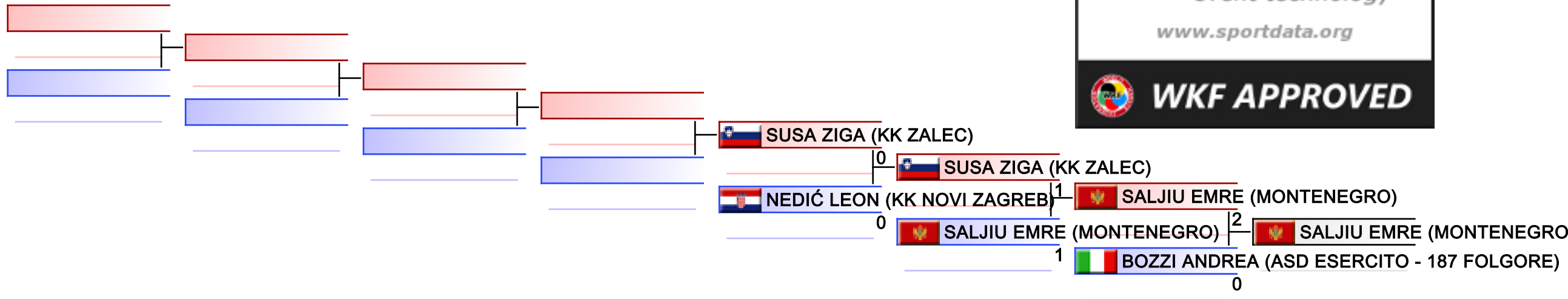

REPECHAGE: (1)

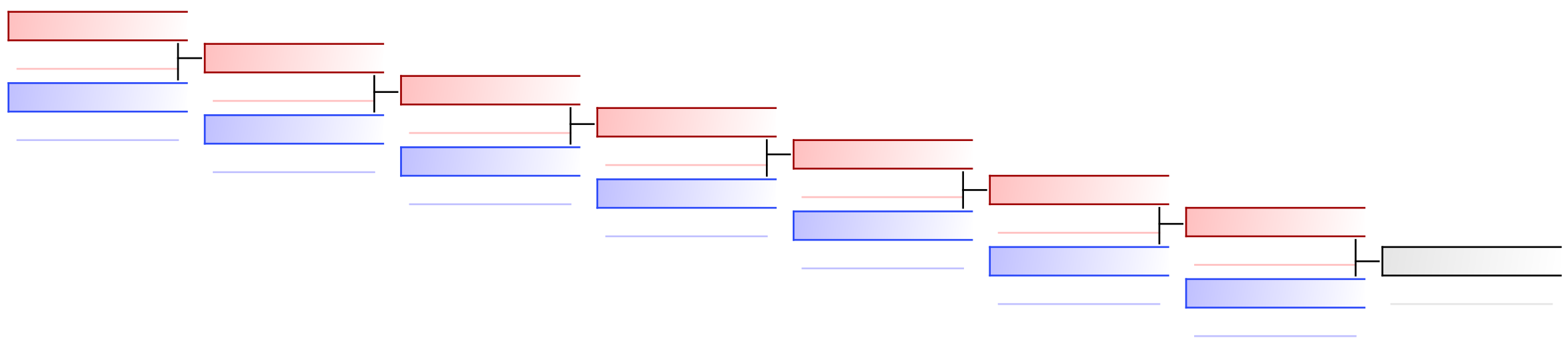

Referees:							
-----------	--	--	--	--	--	--	--

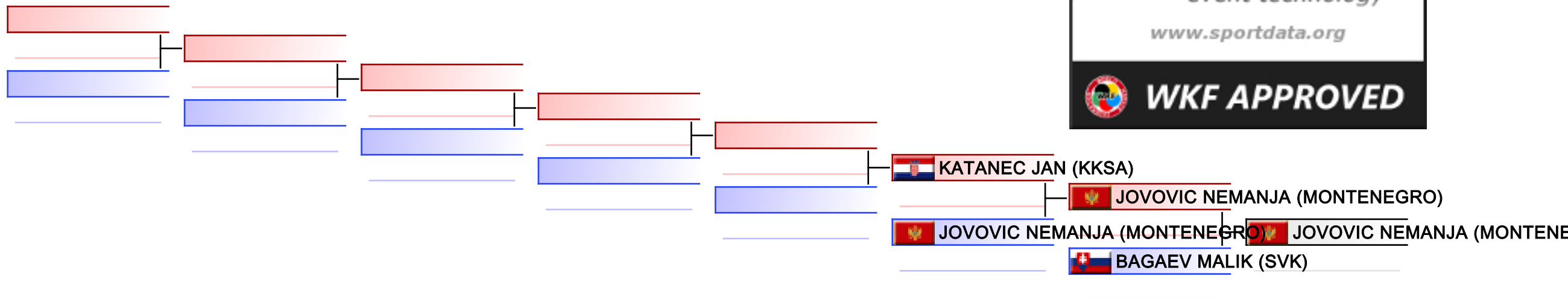

REPECHAGE: (1)

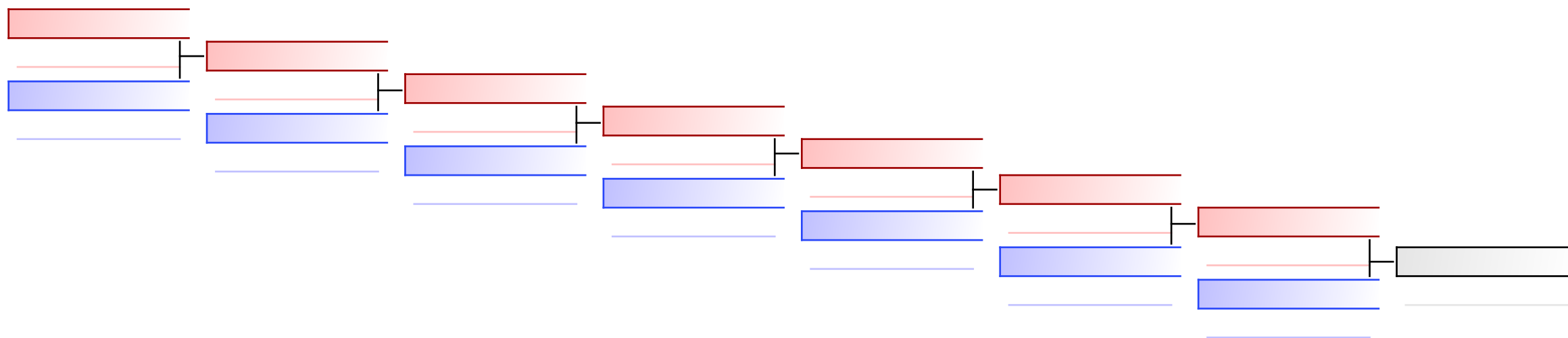

Referees:							
-----------	--	--	--	--	--	--	--

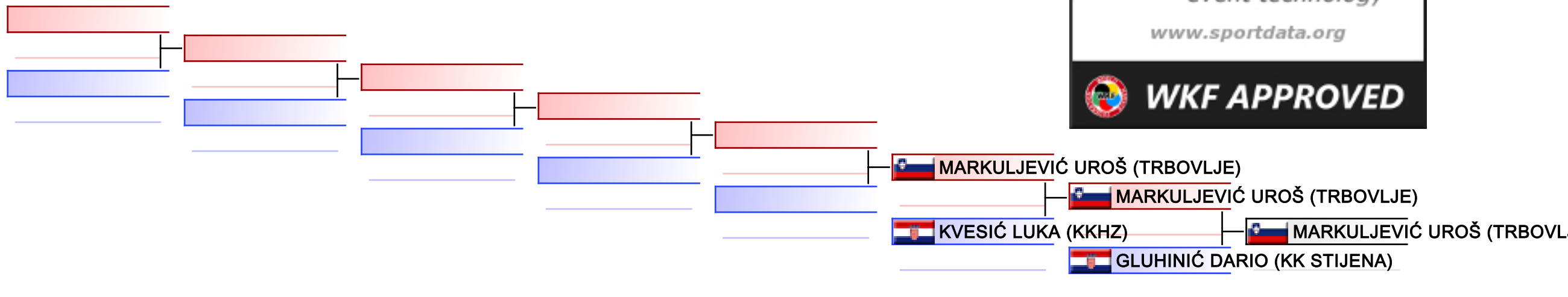

REPECHAGE: (2)

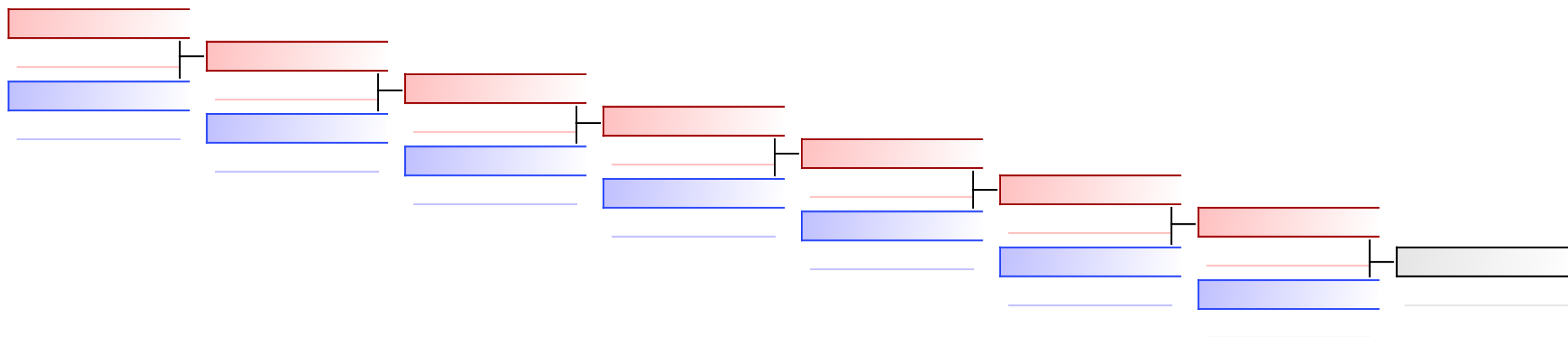

Referees:							
-----------	--	--	--	--	--	--	--

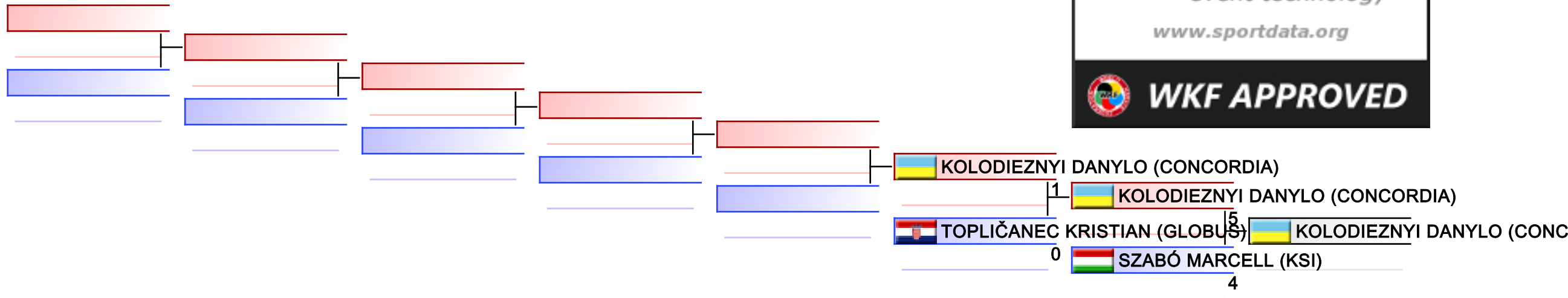

REPECHAGE: (1)

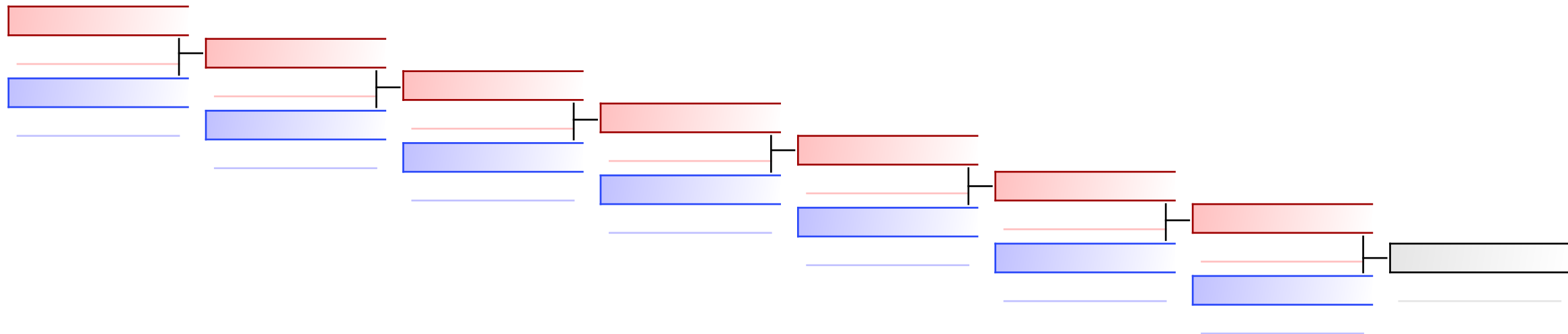

Referees:							
-----------	--	--	--	--	--	--	--

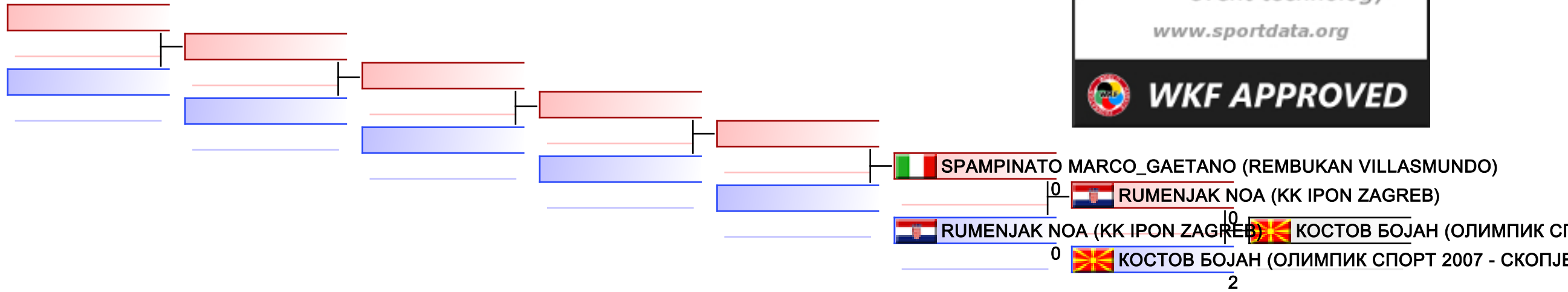

REPECHAGE: (2)

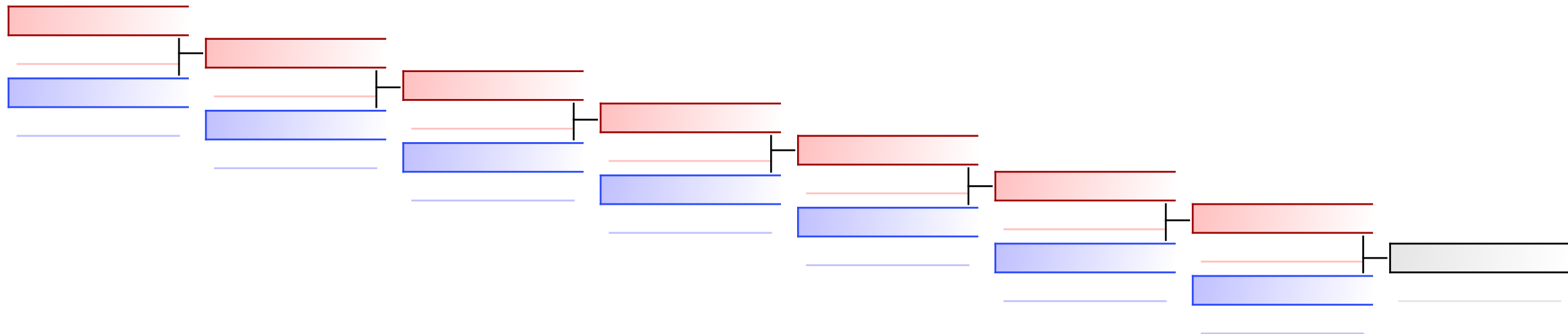

Referees:							
-----------	--	--	--	--	--	--	--

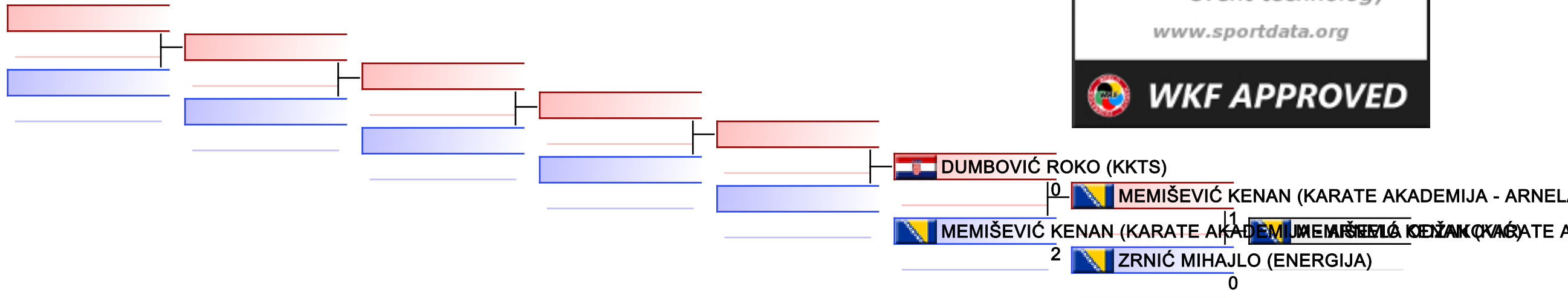

REPECHAGE: (2)

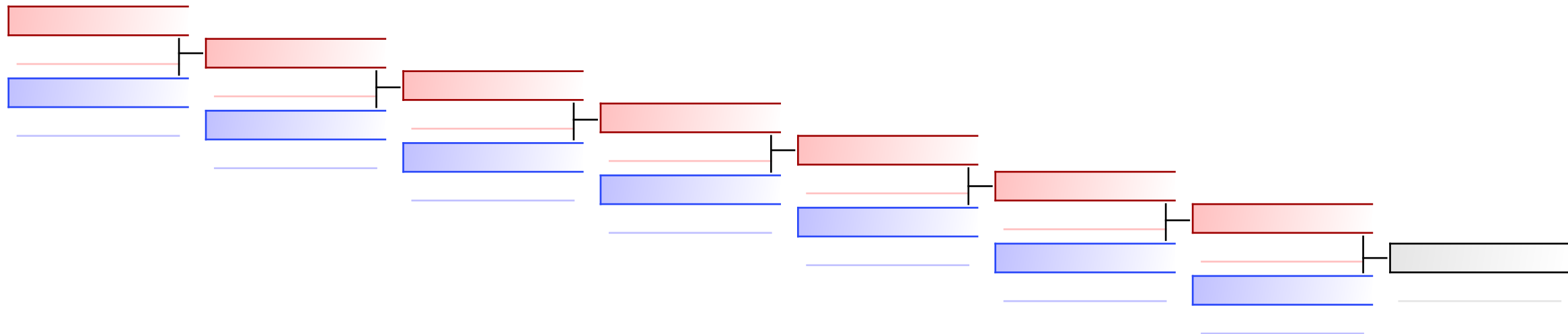

Referees:							
-----------	--	--	--	--	--	--	--

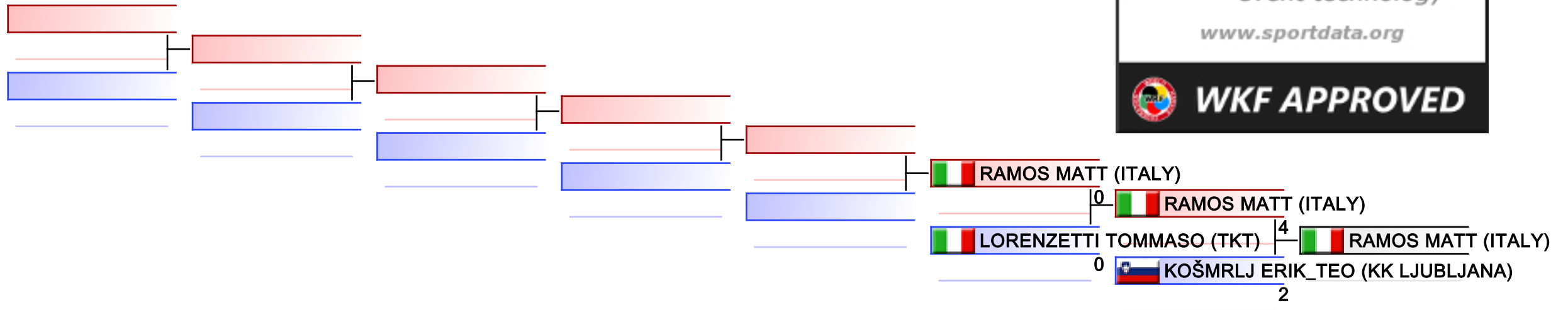

REPECHAGE: (1)

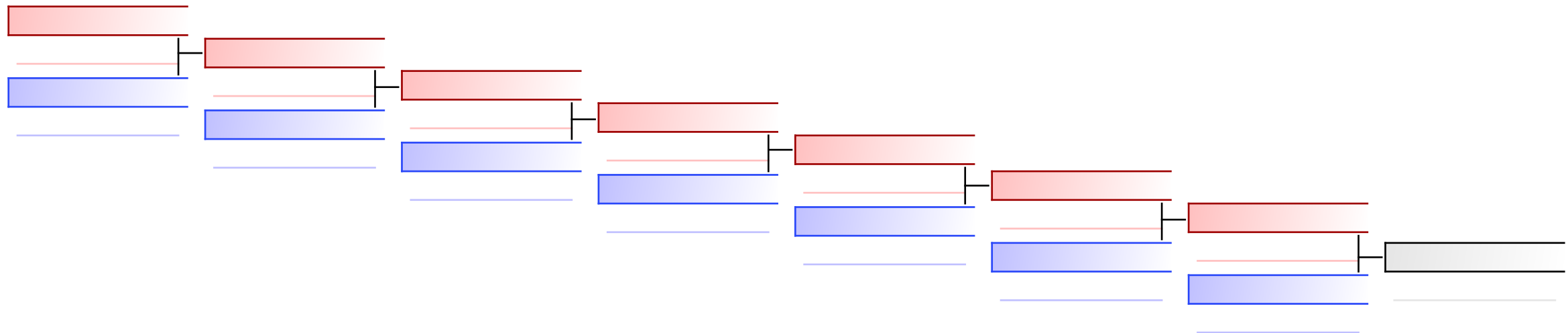

Referees:							
-----------	--	--	--	--	--	--	--

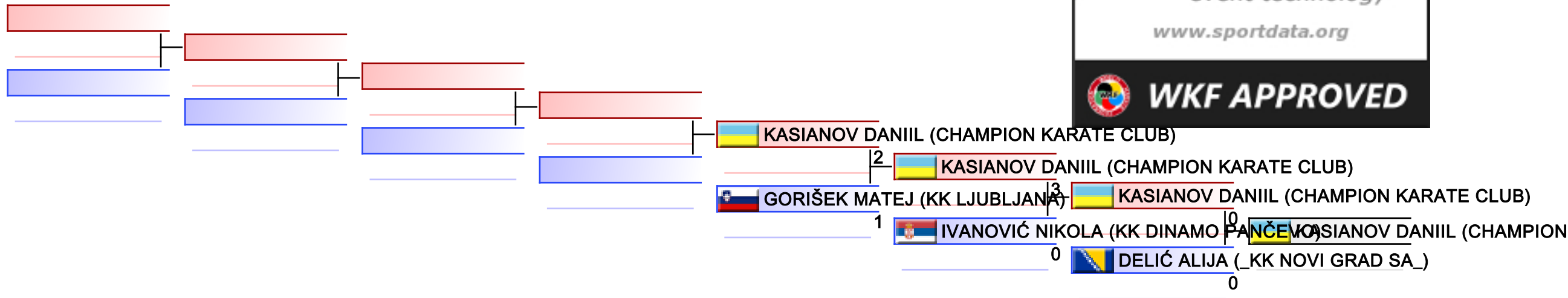

REPECHAGE: (1)

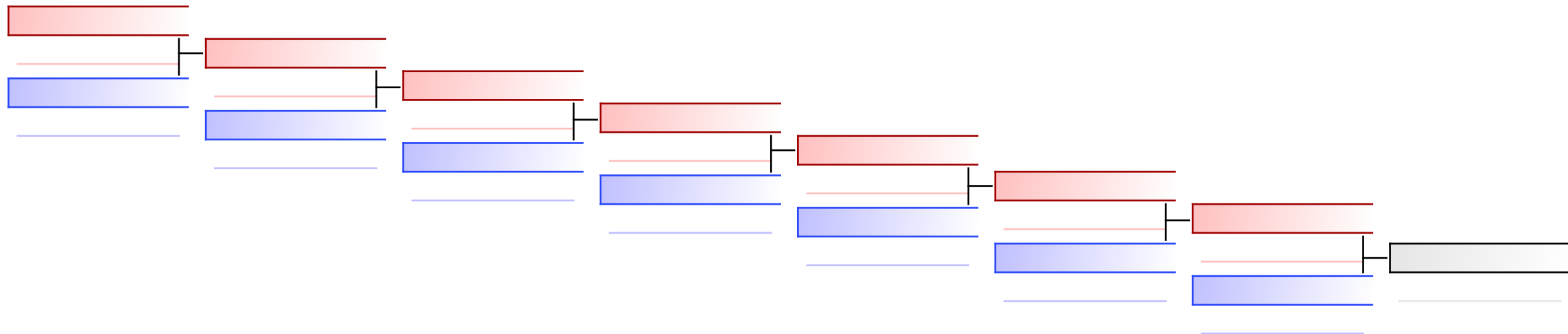

Referees:							
-----------	--	--	--	--	--	--	--

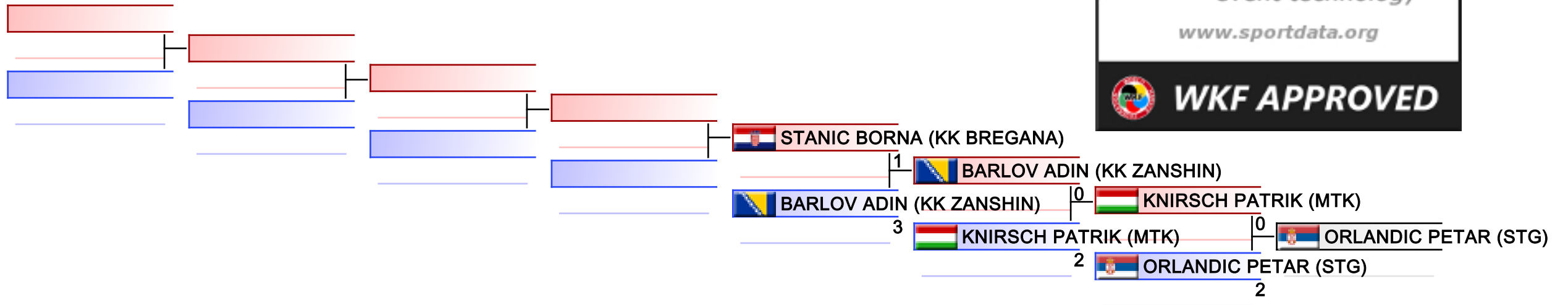

REPECHAGE: (2)

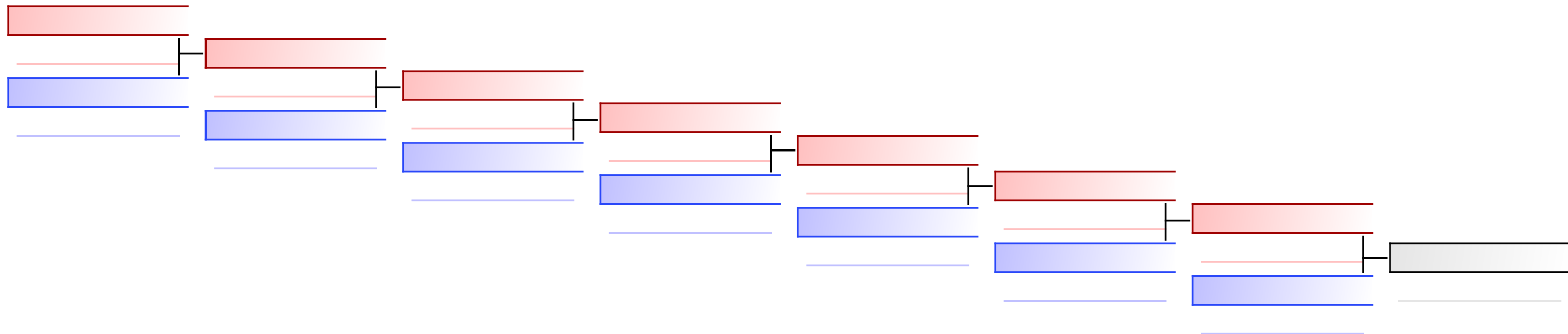

Referees:							
-----------	--	--	--	--	--	--	--

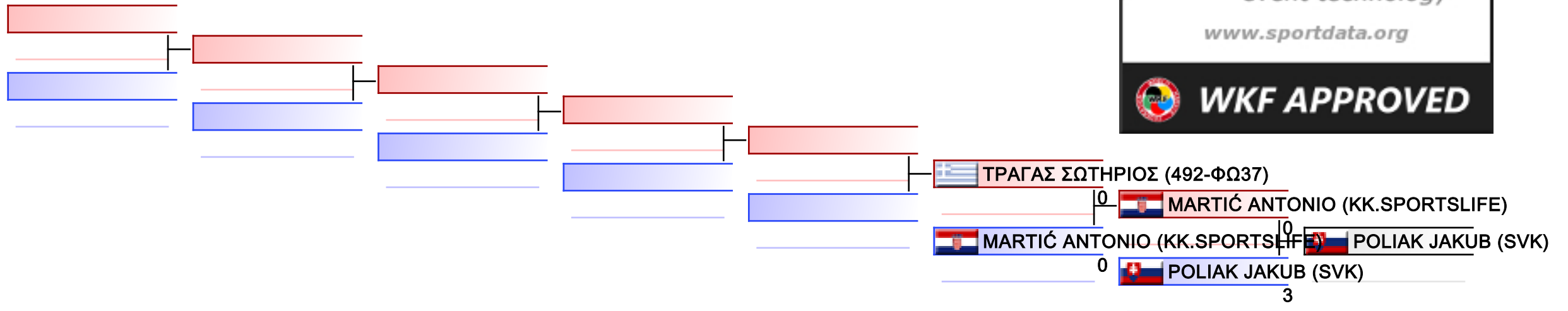

REPECHAGE: (1)

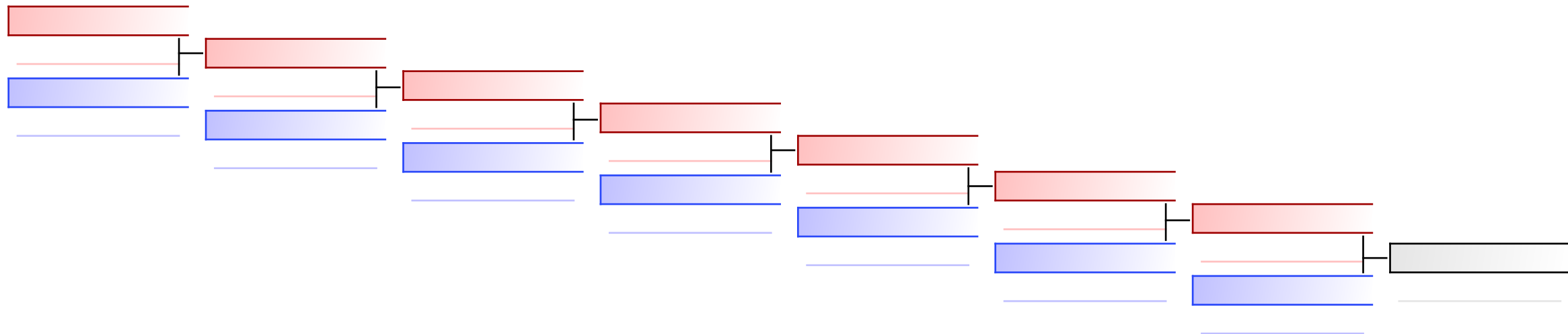

Referees:							
-----------	--	--	--	--	--	--	--

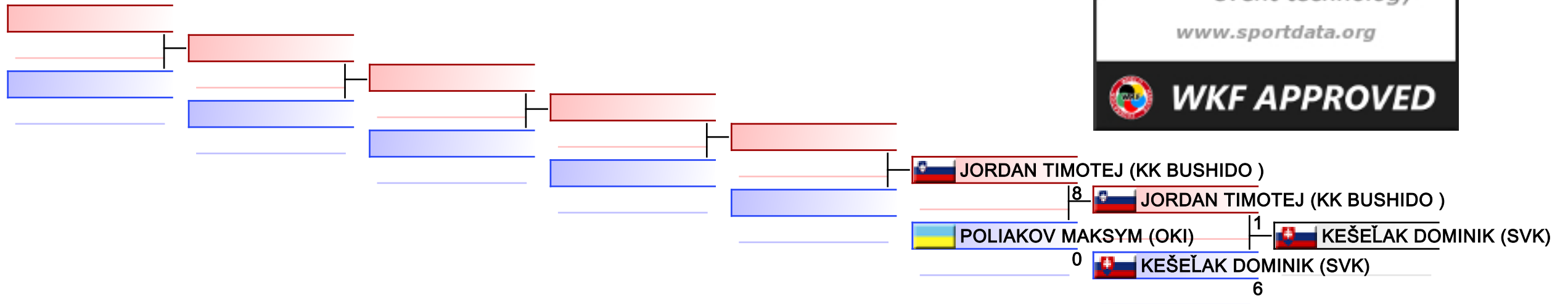

REPECHAGE: (2)

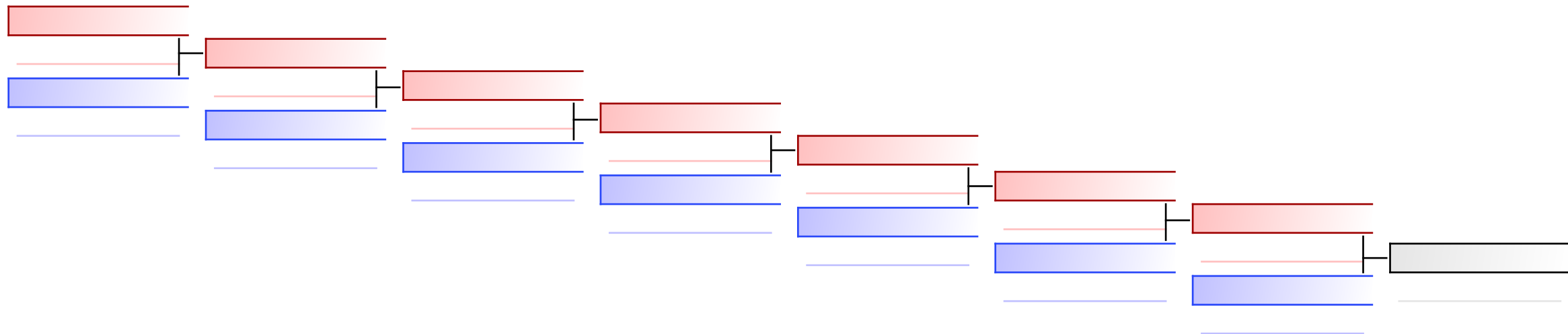

Referees:							
-----------	--	--	--	--	--	--	--

31ST KARATE GRAND PRIX CROATIA - 2023-01-20
K12 - MALE CADETS/
JUNIORS VISUALLY IMPAIRED

R1 G1/1 (1)



Competitors	Kata	1 T	1 A	2 T	2 A	3 T	3 A	4 T	4 A	5 T	5 A	6 T	6 A	7 T	7 A	TEC	ATH	Extra	Total	Rank	
1 ŽUTELIJA NIKO (RI)																					

31ST KARATE GRAND PRIX CROATIA - 2023-01-20
K21 - FEMALE SENIORS
INTELLECTUALLY IMPAIRED

R1 G1/1 (3)

	Competitors	Kata	1	2	3	4	5	6	7	TOTAL	Extra Total Rank
1	MARCAT STEFANIA (KANAZAWA CIMADOLMO)	027 HEIAN SANDAN	6.5	(6.7)	6.5	6.6	(6.1)			19.6	19.6 3
2	YAKYMASHKO FEDERICA (POLISPORTIVA TERRAGLIO)	021 GOJUSHIHO SHO	7.5	(7.9)	7.6	(7.0)	7.4			22.5	22.5 1
3	BEKČIČ DIANDRA (KK VELENJE)	021 GOJUSHIHO SHO	7.3	(8.3)	7.3	(7.2)	7.8			22.4	22.4 2

Results



1	YAKYMASHKO FEDERICA	SSD POLISPORTIVA TERRAGLIO		ITALY
2	BEKČIČ DIANDRA	KARATE KLUB VELENJE		SLOVENIA
3	MARCAT STEFANIA	ASD KARATE CLUB KANAZAWA		ITALY

31ST KARATE GRAND PRIX CROATIA - 2023-01-20
K22 - FEMALE SENIORS
INTELLECTUALLY IMPAIRED

R1 G1/1 (3)

	Competitors	Kata	1	2	3	4	5	6	7	TOTAL	Extra Total Rank
1	PARO CRISTIANA (KANAZAWA CIMADOLMO)	036 JION	7.3	(7.4)	(6.8)	7.0	7.0			21.3	21.3 2
2	TOPIĆ DANIELA (KK ALFA)	021 GOJUSHIHO SHO	8.0	(8.2)	(7.4)	8.2	8.0			24.2	24.2 1
3	CALLEGHER ARIANNA (KANAZAWA CIMADOLMO)	036 JION	7.0	(7.3)	(6.7)	7.2	6.8			21.0	21.0 3

Results

1	TOPIĆ DANIELA	KARATE KLUB ALFA		CROATIA
2	PARO CRISTIANA	ASD KARATE CLUB KANAZAWA		ITALY
3	CALLEGHER ARIANNA	ASD KARATE CLUB KANAZAWA		ITALY

31ST KARATE GRAND PRIX CROATIA - 2023-01-20

KATA female cadets

R1 G1/4 (7) Tatami 5 13:00(2023-01-20)

Competitors	Kata	1	2	3	4	5	6	7	TOTAL	Extra Total Rank
1 DOMINICI ROBERTA (ITALY)	067 PAIKU	7.5	7.7	(8.7)	(7.4)	7.5			22.7	22.7 1
2 KREGAR GABRIJELA (KK SEKI)	041 KANKU SHO	6.5	(7.2)	6.8	(6.3)	6.7			20.0	20.0 6
3 PERVAN JURJA (KK OMEGA)	021 GOJUSHIHO SHO	7.0	(6.8)	(7.5)	6.8	6.9			20.7	20.7 5
4 LAZANSKI MAJA (KARATE KLUB BREŽICE)	068 PAPUREN	7.3	7.4	(7.9)	7.2	(7.1)			21.9	21.9 3
5 STEINBERG ELLA (JKSISR)	012 ENPI	5.8	6.1	(5.5)	5.8	(6.6)			17.7	17.7 7
6 VLAHOVIĆ KATARINA (KK ISKRA)	021 GOJUSHIHO SHO	7.2	(7.1)	(8.2)	7.2	7.3			21.7	21.7 4
7 STAGI NICOLE (SPAZIO SPORT)	002 ANAN DAI	7.1	7.9	(8.1)	(6.9)	7.0			22.0	22.0 2

R1 G2/4 (6) Tatami 5 13:35(2023-01-20)

Competitors	Kata	1	2	3	4	5	6	7	TOTAL	Extra Total Rank
1 PARIMBELLI CAROLINA (MASTER RAPID SKF CBL)	030 HEIKU	7.4	(7.0)	(7.8)	7.2	7.0			21.6	21.6 6
2 STUDENKOVA DARIA (MOWGLY KC)	002 ANAN DAI	(8.7)	(7.6)	8.3	7.6	7.6			23.5	23.5 4
3 BARANOVA ULIANA (OKI)	064 OHAN DAI	(9.0)	7.8	8.0	(7.4)	7.8			23.6	23.6 3
4 SZILÁGYI EMMA (KSI)	043 KISHIMOTO NO KUSHANKU	8.1	7.9	(8.5)	7.7	(7.3)			23.7	23.7 2
5 KADLECAJOVA VIKTORIA (SVK)	002 ANAN DAI	8.4	(8.5)	8.4	8.0	(7.1)			24.8	24.8 1
6 BARIĆ ANTONIJA (KK ALFA) (*2)	020 GOJUSHIHO DAI	7.6	(8.0)	7.9	7.9	(7.5)			23.4	23.4 5

R1 G3/4 (7) Tatami 6 13:00(2023-01-20)

Competitors	Kata	1	2	3	4	5	6	7	TOTAL	Extra Total Rank
1 GOLOD ANASTASIIA (MOWGLY KC)	001 ANAN	(7.5)	7.1	7.4	(6.6)	7.1			21.6	21.6 3
2 GIOMBI SOFIA (KARATE DO TRIESTE)	020 GOJUSHIHO DAI	(6.6)	6.9	(8.0)	7.0	7.4			21.3	21.3 4
3 BABELOVA DANIELA (SSK BA)	002 ANAN DAI	(6.3)	6.8	(7.6)	7.1	7.3			21.2	21.2 5
4 KHOLODNIK DARIA (ZAKHYST)	064 OHAN DAI	(7.4)	(8.0)	7.9	7.6	7.8			23.3	23.3 2
5 MIZRAHI YAARA (JKSISR)	036 JION	(6.1)	(6.6)	6.4	6.4	6.4			19.2	19.2 7
6 POLAK TIA (KK KRANJ SLO)	079 SANSEIRU	(6.2)	6.7	(7.8)	6.7	6.9			20.3	20.3 6
7 ALEKSANDROVA POLINA (OKI)	001 ANAN	(7.6)	8.0	(8.2)	7.8	7.6			23.4	23.4 1

R1 G4/4 (6) Tatami 6 13:30(2023-01-20)

Competitors	Kata	1	2	3	4	5	6	7	TOTAL	Extra Total Rank
1 FODOR AMIRA (KSI)	065 OYADOMARI NO PASSAI	(7.5)	7.6	(8.3)	8.2	7.5			23.3	23.3 2
2 NOAM YUVAL (JKSISR)	012 ENPI	(6.8)	(6.0)	6.4	6.8	6.4			19.6	19.6 6
3 FRIGENI MICHELA (MASTER RAPID SKF CBL)	030 HEIKU	(7.2)	7.2	(7.8)	7.8	7.6			22.6	22.6 5
4 MATTUGINI ESTER (SPAZIO SPORT)	082 SEIENCHIN	(7.3)	7.4	8.0	7.9	(8.2)			23.3	23.3 3
5 LAKNER MAJA (KARATE KLUB BREŽICE)	068 PAPUREN	(7.1)	7.3	(8.1)	8.0	8.0			23.3	23.3 4
6 ŠEĀAVČIĆ KATIA (KK HRVATSKI SOKOL) (*1)	002 ANAN DAI	(7.4)	7.5	(8.5)	8.4	8.3			24.2	24.2 1

R2-G1

Competitors	Kata	1	2	3	4	5	6	7	TOTAL	Extra Total Rank
1 LAZANSKI MAJA (KARATE KLUB BREŽICE)	092 SUPARINPEI	(6.6)	(7.4)	7.1	6.9	7.3			21.3	21.3 7
2 VLAHOVIĆ KATARINA (KK ISKRA)	020 GOJUSHIHO DAI	(6.9)	7.1	(8.1)	7.7	7.9			22.7	22.7 5
3 BARANOVA ULIANA (OKI)	068 PAPUREN	(7.2)	7.9	7.5	7.5	(8.6)			22.9	22.9 4
4 KADLECAJOVA VIKTORIA (SVK)	068 PAPUREN	8.0	(8.4)	8.4	8.0	(7.6)			24.4	24.4 3
5 DOMINICI ROBERTA (ITALY)	002 ANAN DAI	(7.6)	8.6	8.8	8.5	(9.4)			25.9	25.9 1
6 STUDENKOVA DARIA (MOWGLY KC)	068 PAPUREN	(7.9)	8.1	8.2	8.2	(8.9)			24.5	24.5 2
7 SZILÁGYI EMMA (KSI)	065 OYADOMARI NO PASSAI	7.5	(6.8)	(8.3)	7.9	7.0			22.4	22.4 6
8 STAGI NICOLE (SPAZIO SPORT)	068 PAPUREN	7.3	(7.7)	6.8	(6.5)	6.8			20.9	20.9 8

R2-G2

Competitors	Kata	1	2	3	4	5	6	7	TOTAL	Extra Total Rank
1 MATTUGINI ESTER (SPAZIO SPORT)	092 SUPARINPEI	(7.9)	(7.2)	7.2	7.9	7.7			22.8	22.8 7
2 FODOR AMIRA (KSI)	043 KISHIMOTO NO KUSHANKU	(8.4)	7.8	(7.7)	8.3	8.2			24.3	24.3 2
3 LAKNER MAJA (KARATE KLUB BREŽICE)	047 KURURUNFA	7.7	7.5	(7.3)	8.0	(8.1)			23.2	23.2 5
4 KHOLODNIK DARIA (ZAKHYST)	002 ANAN DAI	7.8	8.0	(7.6)	(8.4)	8.4			24.2	24.2 3
5 GOLOD ANASTASIIA (MOWGLY KC)	064 OHAN DAI	(7.4)	7.6	7.5	(8.2)	7.9			23.0	23.0 6
6 ŠEĀAVČIĆ KATIA (KK HRVATSKI SOKOL)	068 PAPUREN	(8.6)	(7.4)	7.9	8.5	8.4			24.8	24.8 1
7 GIOMBI SOFIA (KARATE DO TRIESTE)	021 GOJUSHIHO SHO	7.6	(6.8)	7.6	(7.8)	7.6			22.8	22.8 8

31ST KARATE GRAND PRIX CROATIA - 2023-01-20

KATA female cadets

8	ALEKSANDROVA POLINA (OKI)	002 ANAN DAI	8.0	(7.7)	7.9	(8.1)	7.8						23.7		23.7	4
---	---------------------------	--------------	-----	-------	-----	-------	-----	--	--	--	--	--	------	--	------	---

R3-G1

Competitors	Kata	1	2	3	4	5	6	7	TOTAL	Extra Total Rank
1 STUDENKOVA DARIA (MOWGLY KC)	064 OHAN DAI	(7.8)	(8.1)	8.0	7.9	7.8			23.7	23.7 3
2 KADLECAJOVA VIKTORIA (SVK)	064 OHAN DAI	(8.4)	8.3	8.4	8.2	(7.6)			24.9	24.9 2
3 BARANOVA ULIANA (OKI)	001 ANAN	(8.2)	(7.3)	7.6	7.3	8.0			22.9	22.9 4
4 DOMINICI ROBERTA (ITALY)	043 KISHIMOTO NO KUSHANKU	8.6	(7.8)	(8.9)	8.7	8.2			25.5	25.5 1

R3-G2

Competitors	Kata	1	2	3	4	5	6	7	TOTAL	Extra Total Rank
1 FODOR AMIRA (KSI)	068 PAPUREN	(7.5)	(8.3)	8.2	7.8	7.8			23.8	23.8 2
2 KHOLODNIK DARIA (ZAKHYST)	068 PAPUREN	(7.2)	8.0	(8.4)	8.1	8.0			24.1	24.1 1
3 ALEKSANDROVA POLINA (OKI)	064 OHAN DAI	(7.1)	7.5	8.0	7.6	(8.1)			23.1	23.1 4
4 ŠEĀAVČIĆ KATIA (KK HRVATSKI SOKOL)	008 CHATANYARA KUSHANKU	(7.3)	7.8	(8.5)	7.5	8.3			23.6	23.6 3

R4 Bronze Medal Match 1

Competitors	Kata	1	2	3	4	5	6	7	TOTAL	Extra Total Rank
1 KADLECAJOVA VIKTORIA (SVK)	008 CHATANYARA KUSHANKU	(8.5)	8.0	8.2	(7.9)	8.0			24.2	24.2 1
2 ŠEĀAVČIĆ KATIA (KK HRVATSKI SOKOL)	078 SANSŀ	8.3	(8.5)	7.3	(7.0)	7.8			23.4	23.4 2











R4 Bronze Medal Match 2

Competitors	Kata	1	2	3	4	5	6	7	TOTAL	Extra Total Rank
1 STUDENKOVA DARIA (MOWGLY KC)	092 SUPARINPEI	7.9	8.0	(8.2)	(7.7)	7.7			23.6	23.6 2
2 FODOR AMIRA (KSI)	052 MATSUMURA BASSAI	(7.8)	7.9	(8.4)	7.8	7.9			23.6	23.6 1





R4 Gold Medal Match

Competitors	Kata	1	2	3	4	5	6	7	TOTAL	Extra Total Rank
1 DOMINICI ROBERTA (ITALY)	008 CHATANYARA KUSHANKU	(7.6)	8.0	(8.4)	8.0	8.4			24.4	24.4 2
2 KHOLODNIK DARIA (ZAKHYST)	001 ANAN	(7.4)	8.2	8.2	8.2	(8.6)			24.6	24.6 1

Results

1	KHOLODNIK DARIA	ZAKHYST KARATE CLUB		UKRAINE
2	DOMINICI ROBERTA	ITALIAN NATIONAL TEAM		ITALY
3	KADLECAJOVA VIKTORIA	SLOVAK NATIONAL TEAM		SLOVAKIA
3	FODOR AMIRA	KSI HUNGARY		HUNGARY
5	ŠEĀAVČIĆ KATIA	KARATE KLUB HRVATSKI SOKOL OSIJEK		CROATIA
5	STUDENKOVA DARIA	MOWGLY KARATE CLUB		UKRAINE
7	BARANOVA ULIANA	OKINAWA		UKRAINE
7	ALEKSANDROVA POLINA	OKINAWA		UKRAINE
9	VLAVHOVIĆ KATARINA	KARATE KLUB ISKRA		MONTENEGRO
9	LAKNER MAJA	KARATE KLUB BREŽICE		SLOVENIA
11	SZILÁGYI EMMA	KSI HUNGARY		HUNGARY
11	GOLOD ANASTASIIA	MOWGLY KARATE CLUB		UKRAINE
13	LAZANSKI MAJA	KARATE KLUB BREŽICE		SLOVENIA
13	MATTUGINI ESTER	SPAZIO SPORT FORTE DEI MARMI		ITALY
15	STAGI NICOLE	SPAZIO SPORT FORTE DEI MARMI		ITALY
15	GIOMBI SOFIA	KARATE DO TRIESTE		ITALY
17	PERVAN JURJA	KARATE KLUB OMEGA		CROATIA
17	BARIĆ ANTONIJA	KARATE KLUB ALFA		CROATIA
17	BABELOVA DANIELA	SPORT SCHOOL KARATE BRATISLAVA		SLOVAKIA
17	FRIGENI MICHELA	MASTER RAPID SKF CBL		ITALY
21	KREGAR GABRIJELA	KARATE KLUB SEKI		SLOVENIA
21	PARIMBELLI CAROLINA	MASTER RAPID SKF CBL		ITALY

31ST KARATE GRAND PRIX CROATIA - 2023-01-20
KATA female cadets

21	POLAK TIA	KARATE KLUB KRANJ		SLOVENIA
21	NOAM YUVAL	JKS ISRAEL		ISRAEL
25	STEINBERG ELLA	JKS ISRAEL		ISRAEL
25	MIZRAHI YAARA	JKS ISRAEL		ISRAEL

31ST KARATE GRAND PRIX CROATIA - 2023-01-20

KATA MALE JUNIORS

R1 G1/4 (8) Tatami 1 16:55(2023-01-20)

Competitors	Kata	1	2	3	4	5	6	7	TOTAL	Extra Total Rank
1 APRILOV DENIS (SHURIKEN)	008 CHATANYARA KUSHANKU	6.9	6.9	7.2	(7.6)	(6.2)			21.0	21.0 4
2 BRAVARIĆ ČILO DAMJAN (ENPI RAB)	015 GANKAKU	(7.0)	6.4	7.0	(6.2)	6.8			20.2	20.2 5
3 BUGANIM TOMER (JKSISR)										
4 BOMBARDI LEONARDO (MASTER RAPID SKF CBL)	021 GOJUSHIHO SHO	(7.5)	7.8	(8.1)	8.0	7.8			23.6	23.6 2
5 CALABRESE LUCA (SSKR)										
6 GIOVAGNONI GIOELE (BKP)	066 PACHU	7.8	(7.3)	(8.0)	7.8	8.0			23.6	23.6 3
7 SERDAREVIC NEDIM (KARATE AKADEMIJA - ARNELA ODŽAKOVIĆ)	019 GOJUSHIHO									
8 HUIĆ DINO (KK ALFA)	021 GOJUSHIHO SHO	8.2	(7.7)	8.0	(8.4)	8.4			24.6	24.6 1

R1 G2/4 (8) Tatami 1 17:30(2023-01-20)

Competitors	Kata	1	2	3	4	5	6	7	TOTAL	Extra Total Rank
1 VALDESI FRANCESCO (POLO VERDE-PALERMO)	099 UNSU	7.8	(7.3)	7.3	(7.9)	7.4			22.5	22.5 8
2 PAPPALARDO VINCENZO (ITALY)	021 GOJUSHIHO SHO	8.4	(8.0)	8.2	(8.9)	8.2			24.8	24.8 1
3 JAKOVLJEVIĆ VASILIJ (SU SPARTANCI 026 - S.PALANKA)	041 KANKU SHO	8.0	(7.0)	7.9	(8.1)	7.6			23.5	23.5 5
4 MASSAGLIA MARCO (SPAZIO SPORT)	021 GOJUSHIHO SHO	7.4	(7.2)	7.5	(8.1)	7.8			22.7	22.7 7
5 PURIĆ MILOŠ (KKS BORAC - ČAČAK)	021 GOJUSHIHO SHO	7.6	(7.4)	7.7	(8.6)	7.5			22.8	22.8 6
6 NEDOROŠČIK DANIEL (SHIHAN POPRAD)	002 ANAN DAI	7.9	(7.7)	7.8	(8.1)	8.0			23.7	23.7 4
7 BOŠKOV ALEKSANDAR (KA BUSHIDO)	021 GOJUSHIHO SHO	8.2	7.5	8.1	(8.5)	(7.3)			23.8	23.8 3
8 TARIK SALKIC (KK PERFEKT SARAJEVO)	021 GOJUSHIHO SHO	8.3	7.6	8.0	(8.7)	(7.2)			23.9	23.9 2

R1 G3/4 (8) Tatami 2 16:45(2023-01-20)

Competitors	Kata	1	2	3	4	5	6	7	TOTAL	Extra Total Rank
1 ŠTURLIĆ LUKA (POLET ZAGREB)	041 KANKU SHO	6.2	6.4	(5.8)	(6.8)	6.5			19.1	19.1 8
2 MORETTI OSCAR (MASTER RAPID SKF CBL)	020 GOJUSHIHO DAI	(7.8)	8.2	(8.3)	8.0	8.0			24.2	24.2 2
3 METELENO VITALIJ (KATANA)	001 ANAN	8.2	7.8	8.1	(8.4)	(7.4)			24.1	24.1 3
4 MEŠANOVIĆ BENJAMIN (KK VELENJE)	099 UNSU	7.0	7.7	(7.8)	7.8	(6.3)			22.5	22.5 6
5 SOKOLOV HLIB (ZAKHYST)	041 KANKU SHO	(6.7)	7.5	(7.6)	7.6	6.9			22.0	22.0 7
6 FILIP DENIS (SVK)	001 ANAN	8.4	7.9	(8.5)	8.2	(7.8)			24.5	24.5 1
7 MADONIA FILIPPO_MARIA (REAL SOCIETÀ)	064 OHAN DAI	(7.7)	7.6	7.5	7.7	(6.7)			22.8	22.8 5
8 CALABRESE FILIPPO (MASTER RAPID SKF CBL)	021 GOJUSHIHO SHO	7.9	8.0	8.0	(8.3)	(7.0)			23.9	23.9 4

R1 G4/4 (7) Tatami 2 17:15(2023-01-20)

Competitors	Kata	1	2	3	4	5	6	7	TOTAL	Extra Total Rank
1 FUSCAGNI ALEX (BKP)	002 ANAN DAI	(7.1)	(8.4)	8.1	8.1	7.5			23.7	23.7 2
2 BARLETTA LEONARDO (MASTER RAPID SKF CBL)	030 HEIKU	(8.1)	(7.2)	7.6	7.8	7.7			23.1	23.1 4
3 BICOS NIKITA (SSKR)	001 ANAN	7.4	7.8	(6.9)	7.5	(7.9)			22.7	22.7 5
4 KEKO LUKA (ENPI RAB)	099 UNSU	7.2	(7.9)	(6.7)	7.3	7.6			22.1	22.1 6
5 EDERAR KARIM (MASTER RAPID SKF CBL)	064 OHAN DAI	7.5	(8.1)	7.7	8.0	(7.4)			23.2	23.2 3
6 MATUSKI GEORGI (SHURIKEN)	002 ANAN DAI	(7.8)	(8.3)	8.2	8.2	7.8			24.2	24.2 1
7 CHIKOREL LIOR (JKSISR)	012 ENPI	(6.9)	6.0	5.7	(5.6)	6.5			18.2	18.2 7

R2-G1

Competitors	Kata	1	2	3	4	5	6	7	TOTAL	Extra Total Rank
1 APRILOV DENIS (SHURIKEN)	092 SUPARINPEI	(7.3)	(7.9)	7.3	7.3	7.8			22.4	22.4 8
2 TARIK SALKIC (KK PERFEKT SARAJEVO)	041 KANKU SHO	(7.6)	(8.7)	8.4	7.7	8.6			24.7	24.7 4
3 BOŠKOV ALEKSANDAR (KA BUSHIDO)	092 SUPARINPEI	8.2	(8.5)	8.3	(8.1)	8.2			24.7	24.7 3
4 BOMBARDI LEONARDO (MASTER RAPID SKF CBL)	092 SUPARINPEI	(7.4)	(8.6)	8.1	8.1	7.7			23.9	23.9 7
5 GIOVAGNONI GIOELE (BKP)	068 PAPUREN	8.4	(9.0)	7.9	(7.2)	8.0			24.3	24.3 5
6 PAPPALARDO VINCENZO (ITALY)	099 UNSU	8.7	(9.1)	8.6	8.6	(8.4)			25.9	25.9 1
7 HUIĆ DINO (KK ALFA)	092 SUPARINPEI	(8.1)	(8.8)	8.5	8.4	8.5			25.4	25.4 2
8 NEDOROŠČIK DANIEL (SHIHAN POPRAD)	068 PAPUREN	8.0	8.1	(8.2)	(7.5)	7.9			24.0	24.0 6

R2-G2

Competitors	Kata	1	2	3	4	5	6	7	TOTAL	Extra Total Rank
-------------	------	---	---	---	---	---	---	---	-------	------------------

31ST KARATE GRAND PRIX CROATIA - 2023-01-20

KATA MALE JUNIORS

1	MORETTI OSCAR (MASTER RAPID SKF CBL)	099 UNSU	(7.9)	7.5	7.5	7.5	(7.4)							22.5		22.5	6
2	METELENKO VITALIY (KATANA)	002 ANAN DAI	(7.7)	7.3	7.1	(7.0)	7.7							22.1		22.1	7
3	CALABRESE FILIPPO (MASTER RAPID SKF CBL)	078 SANSAI	(8.0)	8.0	7.0	7.1	(6.8)							22.1		22.1	8
4	EDERAR KARIM (MASTER RAPID SKF CBL)	030 HEIKU	(8.2)	8.2	7.7	(7.6)	8.1							24.0		24.0	3
5	FILIP DENIS (SVK)	002 ANAN DAI	(8.5)	8.2	8.2	(8.1)	8.5							24.9		24.9	1
6	MATUSKI GEORGI (SHURIKEN)	092 SUPARINPEI	7.8	(7.9)	(7.7)	7.8	7.9							23.5		23.5	4
7	FUSCAGNI ALEX (BKP)	064 OHAN DAI	(8.3)	8.3	(8.0)	8.1	8.3							24.7		24.7	2
8	BARLETTA LEONARDO (MASTER RAPID SKF CBL)	092 SUPARINPEI	(8.1)	8.0	(7.5)	7.6	7.5							23.1		23.1	5

R3-G1

Competitors	Kata	1	2	3	4	5	6	7	TOTAL	Extra Total Rank
1 PAPPALARDO VINCENZO (ITALY)	041 KANKU SHO	8.6	8.6	(8.5)	(9.0)	8.7			25.9	25.9 1
2 BOŠKOV ALEKSANDAR (KA BUSHIDO)	015 GANKAKU	(8.1)	8.2	8.2	(8.6)	8.4			24.8	24.8 3
3 HUIČ DINO (KK ALFA)	099 UNSU	8.3	8.4	8.5	(8.8)	(8.2)			25.2	25.2 2
4 TARIK SALKIC (KK PERFEKT SARAJEVO)	099 UNSU	(8.0)	8.3	8.1	(8.6)	8.0			24.4	24.4 4

R4 Bronze Medal Match 1

Competitors	Kata	1	2	3	4	5	6	7	TOTAL	Extra Total Rank
1 FUSCAGNI ALEX (BKP)	068 PAPUREN	8.3	(8.8)	(8.0)	8.2	8.4			24.9	24.9 2
2 HUIČ DINO (KK ALFA)	015 GANKAKU	(8.7)	8.5	8.4	(8.0)	8.5			25.4	25.4 1

R4 Bronze Medal Match 2

Competitors	Kata	1	2	3	4	5	6	7	TOTAL	Extra Total Rank
1 FILIP DENIS (SVK)	092 SUPARINPEI	(8.4)	8.0	(7.8)	8.0	7.8			23.8	23.8 1
2 BOŠKOV ALEKSANDAR (KA BUSHIDO)	099 UNSU	7.9	7.9	7.5	(8.4)	(7.4)			23.3	23.3 2

R4 Gold Medal Match

Competitors	Kata	1	2	3	4	5	6	7	TOTAL	Extra Total Rank
1 MATUSKI GEORGI (SHURIKEN)	001 ANAN	(7.8)	(8.3)	8.0	8.0	8.3			24.3	24.3 2
2 PAPPALARDO VINCENZO (ITALY)	015 GANKAKU	8.2	8.1	(7.6)	8.4	(8.5)			24.7	24.7 1

R3-G2

Competitors	Kata	1	2	3	4	5	6	7	TOTAL	Extra Total Rank
1 EDERAR KARIM (MASTER RAPID SKF CBL)	063 OHAN	7.8	7.8	(7.5)	7.8	(8.0)			23.4	23.4 4
2 FUSCAGNI ALEX (BKP)	045 KOUSOUKUN DAI	8.1	(8.3)	(7.8)	8.2	8.3			24.6	24.6 3
3 MATUSKI GEORGI (SHURIKEN)	064 OHAN DAI	8.4	(8.6)	8.2	(8.0)	8.5			25.1	25.1 1
4 FILIP DENIS (SVK)	064 OHAN DAI	8.3	(8.4)	(8.0)	8.4	8.4			25.1	25.1 2

Results

1	PAPPALARDO VINCENZO	ITALIAN NATIONAL TEAM		ITALY
2	MATUSKI GEORGI	KARATE CLUB SHURIKEN		BULGARIA
3	HUIČ DINO	KARATE KLUB ALFA		CROATIA
3	FILIP DENIS	SLOVAK NATIONAL TEAM		SLOVAKIA
5	FUSCAGNI ALEX	BUSHIDO KARATE PERUGIA		ITALY
5	BOŠKOV ALEKSANDAR	KARATE ACADEMY BUSHIDO		SERBIA
7	TARIK SALKIC	KK PERFEKT SARAJEVO		BOSNIA AND HERZEGOVINA
7	EDERAR KARIM	MASTER RAPID SKF CBL		ITALY
9	GIOVAGNONI GIOELE	BUSHIDO KARATE PERUGIA		ITALY
9	BARLETTA LEONARDO	MASTER RAPID SKF CBL		ITALY
11	NEDOROŠČIK DANIEL	KARATE KLUB SHIHAN POPRAD		SLOVAKIA
11	MORETTI OSCAR	MASTER RAPID SKF CBL		ITALY
13	BOMBARDI LEONARDO	MASTER RAPID SKF CBL		ITALY
13	METELENKO VITALIY	KATANA		UKRAINE
15	APRILOV DENIS	KARATE CLUB SHURIKEN		BULGARIA
15	CALABRESE FILIPPO	MASTER RAPID SKF CBL		ITALY
17	BRAVARIĆ ČILO DAMJAN	ENPI RAB		CROATIA

31ST KARATE GRAND PRIX CROATIA - 2023-01-20
KATA MALE JUNIORS

17	JAKOVLJEVIĆ VASILJE	SPORTSKO UDRUŽENJE SPARTANCI 026 - S. PALANKA		SERBIA
17	MADONIA FILIPPO MARIA	A.S.D REAL SOCIETÀ MONREALE		ITALY
17	BICOS NIKITA	A.S.D. SEN SHIN KAI ROVIGO		ITALY
21	PURIĆ MILOŠ	KLUB KONTAKTNIH SPORTOVA BORAC - ČAČAK		SERBIA
21	MESANOVIĆ BENJAMIN	KARATE KLUB VELENJE		SLOVENIA
21	KEKO LUKA	ENPI RAB		CROATIA
25	MASSAGLIA MARCO	SPAZIO SPORT FORTE DEI MARMI		ITALY
25	SOKOLOV HLIB	ZAKHYST KARATE CLUB		UKRAINE
25	CHIKOREL LIOR	JKS ISRAEL		ISRAEL
29	VALDESI FRANCESCO	A.S.D. POL. POLO VERDE		ITALY
29	ŠTURLIĆ LUKA	KARATE KLUB POLET ZAGREB		CROATIA

31ST KARATE GRAND PRIX CROATIA - 2023-01-20

Kata male seniors

R1 G1/4 (7) Tatami 5 15:10(2023-01-20)

Competitors	Kata	1	2	3	4	5	6	7	TOTAL	Extra Total Rank
1 BEKE BALINT (KSI)	001 ANAN	7.5	(7.3)	(7.7)	7.5	7.4			22.4	22.4 6
2 COSTA PIERLUIGI (REAL SOCIETA)	099 UNSU	(7.8)	(6.7)	7.2	7.3	7.2			21.7	21.7 7
3 EDERAR KARIM (MASTER RAPID SKF CBL)	064 OHAN DAI	8.0	(7.6)	8.2	(8.3)	8.2			24.4	24.4 4
4 SENJUG MAKŠ_LUKA (VIROVITICA)	064 OHAN DAI	(7.7)	7.7	(8.0)	7.7	8.0			23.4	23.4 5
5 SUBOTA UROS (BEOGRAD)	020 GOJUSHIHO DAI	8.6	(8.3)	(9.0)	8.5	8.5			25.6	25.6 1
6 SLUGA JURE (KK SEKI)	099 UNSU	8.2	(8.0)	8.7	8.0	(8.8)			24.9	24.9 3
7 MIKLOVICS DAMIAN (SVK)	001 ANAN	8.4	(7.9)	8.5	8.1	(8.7)			25.0	25.0 2

R1 G2/4 (6) Tatami 5 15:40(2023-01-20)

Competitors	Kata	1	2	3	4	5	6	7	TOTAL	Extra Total Rank
1 BOMBARDI LEONARDO (MASTER RAPID SKF CBL)	021 GOJUSHIHO SHO	(7.1)	7.4	(7.5)	7.2	7.5			22.1	22.1 6
2 HRCKA ROMAN (SVK)	064 OHAN DAI	8.2	7.8	8.0	(7.6)	(8.3)			24.0	24.0 1
3 FUSCAGNI ALEX (BKP)	066 PACHU	(6.8)	(8.0)	7.8	7.2	7.8			22.8	22.8 5
4 ZÖCHLING FLORIAN (LZKNÖ)	068 PAPUREN	7.5	(8.4)	(7.2)	7.3	8.0			22.8	22.8 4
5 STANKOVIĆ ANDRIJA (KK ELID-NIŠ)	021 GOJUSHIHO SHO	(8.3)	7.6	(7.0)	7.8	7.9			23.3	23.3 3
6 KÖSTENBAUMER HANNES (KC FELDKIRCHEN)	002 ANAN DAI	8.0	(8.2)	7.7	(7.0)	7.7			23.4	23.4 2

R1 G3/4 (7) Tatami 6 15:15(2023-01-20)

Competitors	Kata	1	2	3	4	5	6	7	TOTAL	Extra Total Rank
1 PINKUS NIMROD (JKSISR)	041 KANKU SHO	6.7	(7.5)	6.4	6.9	(6.0)			20.0	20.0 6
2 PEDRUZZI THOMAS (MASTER RAPID SKF CBL)	021 GOJUSHIHO SHO	(7.2)	7.7	7.6	(7.8)	7.7			23.0	23.0 5
3 POLSINELLI GUIDO (FF.OO. POLIZIA DI STATO)	041 KANKU SHO	7.9	8.2	(7.6)	8.3	(8.4)			24.4	24.4 1
4 SZOLAR PAVOL (SVK)	001 ANAN	(8.0)	8.0	(8.3)	8.1	8.2			24.3	24.3 2
5 CALABRESE LUCA (SSKR)	001 ANAN	(5.0)	(5.0)	5.0	5.0	5.0			15.0	15.0 7
6 PEDRUZZI OMAR (MASTER RAPID SKF CBL)	021 GOJUSHIHO SHO	(7.5)	7.6	7.7	(7.9)	7.8			23.1	23.1 4
7 VELADŽIĆ SENAID (KBES 5.11-BK)	021 GOJUSHIHO SHO	(7.7)	(8.3)	7.9	7.7	7.9			23.5	23.5 3

R1 G4/4 (6) Tatami 6 15:45(2023-01-20)

Competitors	Kata	1	2	3	4	5	6	7	TOTAL	Extra Total Rank
1 BARLETTA LEONARDO (MASTER RAPID SKF CBL)	030 HEIKU	(7.8)	7.6	(6.5)	7.7	7.7			23.0	23.0 5
2 PICCIONI EDOARDO (KARATETERNI)	002 ANAN DAI	8.0	(7.9)	8.4	8.1	(8.6)			24.5	24.5 1
3 SLEHOFER RICHARD (SVK)	002 ANAN DAI	7.9	(7.7)	(8.2)	8.0	8.1			24.0	24.0 4
4 MATKY RONALD (LZKNÖ)	001 ANAN	7.7	7.5	7.7	(8.2)	(7.4)			22.9	22.9 6
5 VALET PATRICK (KC FELDKIRCHEN)	064 OHAN DAI	8.1	(7.8)	8.0	(8.5)	8.3			24.4	24.4 3
6 GIOVAGNONI GIOELE (BKP)	066 PACHU	8.2	8.1	(7.9)	(8.4)	8.2			24.5	24.5 2

R2-G1

Competitors	Kata	1	2	3	4	5	6	7	TOTAL	Extra Total Rank
1 SUBOTA UROS (BEOGRAD)	021 GOJUSHIHO SHO	8.5	8.4	8.5	(9.1)	(8.3)			25.4	25.4 1
2 ZÖCHLING FLORIAN (LZKNÖ)	064 OHAN DAI	7.3	7.3	(7.5)	(7.2)	7.2			21.8	21.8 8
3 HRCKA ROMAN (SVK)	002 ANAN DAI	8.0	8.1	(7.9)	(9.5)	8.1			24.2	24.2 3
4 SLUGA JURE (KK SEKI)	078 SANSAN	(7.1)	7.7	8.1	(8.4)	7.7			23.5	23.5 6
5 STANKOVIĆ ANDRIJA (KK ELID-NIŠ)	020 GOJUSHIHO DAI	(7.2)	7.9	(8.3)	7.8	8.2			23.9	23.9 4
6 EDERAR KARIM (MASTER RAPID SKF CBL)	030 HEIKU	7.7	(8.0)	8.0	8.0	(6.9)			23.7	23.7 5
7 MIKLOVICS DAMIAN (SVK)	064 OHAN DAI	(7.5)	8.2	8.7	(8.9)	7.5			24.4	24.4 2
8 KÖSTENBAUMER HANNES (KC FELDKIRCHEN)	064 OHAN DAI	(7.4)	7.6	(8.2)	8.1	7.6			23.3	23.3 7

R2-G2

Competitors	Kata	1	2	3	4	5	6	7	TOTAL	Extra Total Rank
1 GIOVAGNONI GIOELE (BKP)	064 OHAN DAI	(7.9)	7.8	7.6	7.9	(7.4)			23.3	23.3 7
2 SLEHOFER RICHARD (SVK)	068 PAPUREN	8.0	(7.5)	7.5	(8.2)	7.8			23.3	23.3 6
3 VALET PATRICK (KC FELDKIRCHEN)	001 ANAN	7.8	8.2	(7.7)	(8.4)	8.0			24.0	24.0 4
4 PEDRUZZI OMAR (MASTER RAPID SKF CBL)	099 UNSU	7.7	(7.9)	7.5	7.6	(7.0)			22.8	22.8 8
5 SZOLAR PAVOL (SVK)	002 ANAN DAI	(8.2)	8.3	8.2	(8.6)	8.2			24.7	24.7 1
6 POLSINELLI GUIDO (FF.OO. POLIZIA DI STATO)	099 UNSU	8.3	(8.5)	8.1	7.7	(7.6)			24.1	24.1 2
7 VELADŽIĆ SENAID (KBES 5.11-BK)	020 GOJUSHIHO DAI	8.1	8.0	(7.9)	(8.3)	7.9			24.0	24.0 3
8 PICCIONI EDOARDO (KARATETERNI)	064 OHAN DAI	7.8	(8.4)	7.9	8.1	(7.7)			23.8	23.8 5

31ST KARATE GRAND PRIX CROATIA - 2023-01-20

Kata male seniors

R3-G1

Competitors	Kata	1	2	3	4	5	6	7	TOTAL	Extra Total Rank
1 SUBOTA UROS (BEOGRAD)	041 KANKU SHO	(8.4)	8.5	8.7	(8.9)	8.4			25.6	25.6 1
2 STANKOVIĆ ANDRIJA (KK ELID-NIŠ)	099 UNSU	(7.2)	7.4	7.8	7.9	(8.2)			23.1	23.1 4
3 MIKLOVICS DAMIAN (SVK)	009 CHIBANA NO KUSHANKU	7.5	7.8	(8.4)	8.4	(7.4)			23.7	23.7 3
4 HRCKA ROMAN (SVK)	068 PAPUREN	(8.0)	8.2	8.6	(9.3)	8.0			24.8	24.8 2

R3-G2

Competitors	Kata	1	2	3	4	5	6	7	TOTAL	Extra Total Rank
1 POLSINELLI GUIDO (FF.OO. POLIZIA DI STATO)	078 SANSAI	(8.4)	8.2	(7.8)	8.0	7.8			24.0	24.0 3
2 VALET PATRICK (KC FELDKIRCHEN)	092 SUPARINPEI	(7.4)	7.9	7.4	7.9	(8.2)			23.2	23.2 4
3 VELADŽIĆ SENAI (KBES 5.11-BK)	099 UNSU	8.0	8.0	(7.7)	8.2	(8.3)			24.2	24.2 2
4 SZOLAR PAVOL (SVK)	063 OHAN	(8.5)	8.1	(7.9)	8.3	8.4			24.8	24.8 1

R4 Bronze Medal Match 1

Competitors	Kata	1	2	3	4	5	6	7	TOTAL	Extra Total Rank
1 HRCKA ROMAN (SVK)	008 CHATANYARA KUSHANKU	(8.1)	8.5	8.4	(9.1)	8.3			25.2	25.2 1
2 POLSINELLI GUIDO (FF.OO. POLIZIA DI STATO)	021 GOJUSHIHO SHO	(7.5)	8.3	8.2	(8.9)	8.1			24.6	24.6 2

R4 Bronze Medal Match 2

Competitors	Kata	1	2	3	4	5	6	7	TOTAL	Extra Total Rank
1 MIKLOVICS DAMIAN (SVK)	043 KISHIMOTO NO KUSHANKU	(8.8)	8.6	8.7	(8.4)	8.4			25.7	25.7 1
2 VELADŽIĆ SENAI (KBES 5.11-BK)	015 GANKAKU	(8.0)	8.2	(8.5)	8.0	8.2			24.4	24.4 2

R4 Gold Medal Match

Competitors	Kata	1	2	3	4	5	6	7	TOTAL	Extra Total Rank
1 SUBOTA UROS (BEOGRAD)	099 UNSU	8.5	9.0	(8.4)	(9.3)	8.8			26.3	26.3 1
2 SZOLAR PAVOL (SVK)	064 OHAN DAI	8.1	8.7	(8.0)	(9.1)	8.6			25.4	25.4 2

Results

1	SUBOTA UROS	SKIPPER		SERBIA
2	SZOLAR PAVOL	SLOVAK NATIONAL TEAM		SLOVAKIA
3	HRCKA ROMAN	SLOVAK NATIONAL TEAM		SLOVAKIA
3	MIKLOVICS DAMIAN	SLOVAK NATIONAL TEAM		SLOVAKIA
5	POLSINELLI GUIDO	G.S.FF.OO. POLIZIA DI STATO		ITALY
5	VELADŽIĆ SENAI	KBES 5.11-BK BOSANSKA KRUPA		BOSNIA AND HERZEGOVINA
7	STANKOVIĆ ANDRIJA	KARATE KLUB ELID-NIŠ		SERBIA
7	VALET PATRICK	INOUE-HA KARATE-DO FELDKIRCHEN		AUSTRIA
9	EDERAR KARIM	MASTER RAPID SKF CBL		ITALY
9	PICCIONI EDOARDO	SSD POLISPORTIVA TERNANA		ITALY
11	SLUGA JURE	KARATE KLUB SEKI		SLOVENIA
11	SLEHOFER RICHARD	SLOVAK NATIONAL TEAM		SLOVAKIA
13	KÖSTENBAUMER HANNES	INOUE-HA KARATE-DO FELDKIRCHEN		AUSTRIA
13	GIOVAGNONI GIOELE	BUSHIDO KARATE PERUGIA		ITALY
15	ZÖCHLING FLORIAN	LZ KARATE NIEDERÖSTERREICH		AUSTRIA
15	PEDRUZZI OMAR	MASTER RAPID SKF CBL		ITALY
17	ŠENJUG MAKS LUKA	KK VIROVITICA		CROATIA
17	FUSCAGNI ALEX	BUSHIDO KARATE PERUGIA		ITALY
17	PINKUS NIMROD	JKS ISRAEL		ISRAEL
17	BARLETTA LEONARDO	MASTER RAPID SKF CBL		ITALY
21	BEKE BÁLINT	KSI HUNGARY		HUNGARY
21	BOMBARDI LEONARDO	MASTER RAPID SKF CBL		ITALY
21	CALABRESE LUCA	A.S.D. SEN SHIN KAI ROVIGO		ITALY
21	MATKY RONALD	LZ KARATE NIEDERÖSTERREICH		AUSTRIA

31ST KARATE GRAND PRIX CROATIA - 2023-01-20
Kata male seniors

25	COSTA PIERLUIGI	A.S.D REAL SOCIETÀ MONREALE		ITALY
----	-----------------	-----------------------------	---	-------

31ST KARATE GRAND PRIX CROATIA - 2023-01-20

Official Results

K11 - MALE SENIORS VISUALLY IMPAIRED

1	ŠTEKO JOSIP	KARATE KLUB ALFA		CRO - CROATIA	
---	-------------	------------------	---	---------------	--

K21 - FEMALE SENIORS INTELLECTUALLY IMPAIRED

1	YAKYMASHKO FEDERICA	SSD POLISPORTIVA TERRAGLIO		ITA - ITALY	
2	BEKČIČ DIANDRA	KARATE KLUB VELENJE		SLO - SLOVENIA	
3	MARCAT STEFANIA	ASD KARATE CLUB KANAZAWA		ITA - ITALY	

K21 - MALE SENIORS INTELLECTUALLY IMPAIRED

1	VEDELAGO CHRISTIAN	ASD KARATE CLUB KANAZAWA		ITA - ITALY	
---	--------------------	--------------------------	---	-------------	--

K22 - FEMALE SENIORS INTELLECTUALLY IMPAIRED

1	TOPIĆ DANIELA	KARATE KLUB ALFA		CRO - CROATIA	
2	PARO CRISTIANA	ASD KARATE CLUB KANAZAWA		ITA - ITALY	
3	CALLEGHER ARIANNA	ASD KARATE CLUB KANAZAWA		ITA - ITALY	

K22 - MALE SENIORS INTELLECTUALLY IMPAIRED

1	BARIĆ STIPE	KARATE KLUB ALFA		CRO - CROATIA	
2	BODULJAK ROKO	KARATE KLUB ALFA		CRO - CROATIA	
3	FELETTO GIANLUIGI	ASD KARATE CLUB KANAZAWA		ITA - ITALY	

K30 - MALE SENIORS WHEELCHAIR USERS

1	GIUGE MANUEL	SSD POLISPORTIVA TERRAGLIO		ITA - ITALY	
---	--------------	----------------------------	---	-------------	--

KATA BOYS 10 YEARS

1	MAVSAR TADEJ	KARATE KLUB SEKI		SLO - SLOVENIA	
2	BERBIĆ IBRAHIM-DŽAN	KARATE KLUB VEZIR		BIH - BOSNIA AND HERZEGOVINA	
3	ŠTEFANIĆ VAL	KARATE KLUB VELENJE		SLO - SLOVENIA	
3	NIKIFOROS MICHAIL	ATHLITIKOS SYLLOGOS AMAROUSIOU		GRE - GREECE	
5	CESAR JAN	KARATE KLUB KAPTOL ZAGREB		CRO - CROATIA	
5	PALKA PATRIK	SPORT SCHOOL KARATE BRATISLAVA		SVK - SLOVAKIA	
7	FAZLIĆ KANAN	KARATE KLUB RESPECT		BIH - BOSNIA AND HERZEGOVINA	
7	ELIAS WASIM	JAMAL SAADA SHOTOKAN KARATE		ISR - ISRAEL	

KATA BOYS 11 YEARS

1	HOZANOVIĆ ARMAN	KARATE KLUB TRBOVLJE		SLO - SLOVENIA	
2	PETRUŠIĆ VEDRAN	KARATE KLUB SHIHAN - ZAGREB		CRO - CROATIA	

31ST KARATE GRAND PRIX CROATIA - 2023-01-20

Official Results

3	IVANOVIC LAZAR	KARATE KLUB PANTER		MNE - MONTENEGRO	
3	MAVSAR TADEJ	KARATE KLUB SEKI		SLO - SLOVENIA	
5	PALKA PATRIK	SPORT SCHOOL KARATE BRATISLAVA		SVK - SLOVAKIA	
5	ČAVAR MATEO	KARATE KLUB TRNJE		CRO - CROATIA	
7	NIKITOVIC NIKSA	KARATE KLUB PANTER		MNE - MONTENEGRO	
7	ZECEVIC VUK	KARATE KLUB PANTER		MNE - MONTENEGRO	

KATA BOYS 12 YEARS

1	BABEL BRANISLAV	SLOVAK NATIONAL TEAM		SVK - SLOVAKIA	
2	GENDES JURAJ	SLOVAK NATIONAL TEAM		SVK - SLOVAKIA	
3	RUDENKO KLYMENTII	CHAMPION KARATE CLUB		UKR - UKRAINE	
3	DŽINOVIĆ DAMIR	KLUB BORILAČKIH SPORTOVA TUZLA		BIH - BOSNIA AND HERZEGOVINA	
5	DAUTORIO IGOR	A.S.D. VILLA PIGNA KARATE		ITA - ITALY	
5	PAŠIĆ ADAM	KARATE KLUB VELENJE		SLO - SLOVENIA	
7	IVKOVIĆ ALEKSANDAR	SLAVKO KRIVSKI TERMAL DARUVAR		CRO - CROATIA	
7	PILIZZARI LEO	SLAVKO KRIVSKI TERMAL DARUVAR		CRO - CROATIA	

KATA BOYS 13 YEARS

1	NARDACCIO MATTEO	ASD FC MOREVILLA		ITA - ITALY	
2	GENDES JURAJ	SLOVAK NATIONAL TEAM		SVK - SLOVAKIA	
3	MILJATOVIĆ ALEKSA	KARATE KLUB SEKI		SLO - SLOVENIA	
3	ORAVCIK JURAJ	SLOVAK NATIONAL TEAM		SVK - SLOVAKIA	
5	BENO VIKTOR	SLOVAK NATIONAL TEAM		SVK - SLOVAKIA	
5	VYTHOULKAS GEORGIOS	ATHLITIKOS SYLLOGOS AMAROUSIOU		GRE - GREECE	
7	KATZIR ASAF	JKS ISRAEL		ISR - ISRAEL	
7	VUKSANOVIĆ ANDRIJA	KK SAMOBOR		CRO - CROATIA	

KATA BOYS 14 YEARS

1	NARDACCIO MATTEO	ASD FC MOREVILLA		ITA - ITALY	
2	GENDES DAVID	SLOVAK NATIONAL TEAM		SVK - SLOVAKIA	
3	KLAČAR LUKA	KKPOTOCI		MNE - MONTENEGRO	
3	VELADŽIĆ ALEM	KBES 5.11-BK BOSANSKA KRUPA		BIH - BOSNIA AND HERZEGOVINA	
5	JURAJA VINKO	KARATE KLUB BUSHIDO, ROGASKA SLATINA		SLO - SLOVENIA	
5	ELIAS MATUS	SLOVAK NATIONAL TEAM		SVK - SLOVAKIA	
7	LIST FABIO	KARATE-DO WEIZ		AUT - AUSTRIA	

31ST KARATE GRAND PRIX CROATIA - 2023-01-20

Official Results

7	MILJATOVIĆ ALEKSA	KARATE KLUB SEKI		SLO - SLOVENIA	
---	-------------------	------------------	---	----------------	--

KATA BOYS 7 YEARS

1	BEGANOVIĆ ARIS	KARATE KLUB REGENERACIJA		BIH - BOSNIA AND HERZEGOVINA	
2	PALKA ADAM	SPORT SCHOOL KARATE BRATISLAVA		SVK - SLOVAKIA	
3	ELIAS OLIVER	ŠK KARATE KACHI NITRA		SVK - SLOVAKIA	

KATA BOYS 8 YEARS

1	BIŠKUP TEO	KK OKINAWA MALI BUKOVEC		CRO - CROATIA	
2	ŽUPAN PATRIK	KARATE KLUB TRNJE		CRO - CROATIA	
3	KOTNIK LIAM	KARATE KLUB SEKI		SLO - SLOVENIA	
3	PALKA ADAM	SPORT SCHOOL KARATE BRATISLAVA		SVK - SLOVAKIA	
5	TSVYATKOV NIKOLAY	ФАЙТЪРС-НСА		BUL - BULGARIA	
5	HAVRYLIUK VARLAM	TIGER TEAM		UKR - UKRAINE	

KATA BOYS 9 YEARS

1	BERBIĆ IBRAHIM-DŽAN	KARATE KLUB VEZIR		BIH - BOSNIA AND HERZEGOVINA	
2	NIKIFOROS MICHAIL	ATHLITIKOS SYLLOGOS AMAROUSIOU		GRE - GREECE	
3	SKAKOVSKYI SAVELII	KATANA		UKR - UKRAINE	
3	PETRUŠIĆ LUKA	KARATE KLUB SHIHAN - ZAGREB		CRO - CROATIA	
5	SAWAED ADI	JAMAL SAADA SHOTOKAN KARATE		ISR - ISRAEL	
5	ČIZMIĆ MATEJ	KARATE KLUB ALFA		CRO - CROATIA	
7	NEGATUROV YEHOR	TIGER TEAM		UKR - UKRAINE	

KATA female cadets

1	KHOLODNIK DARIA	ZAKHYST KARATE CLUB		UKR - UKRAINE	
2	DOMINICI ROBERTA	ITALIAN NATIONAL TEAM		ITA - ITALY	
3	KADLECAJOVA VIKTORIA	SLOVAK NATIONAL TEAM		SVK - SLOVAKIA	
3	FODOR AMIRA	KSI HUNGARY		HUN - HUNGARY	
5	ŠEĀAVČIĆ KATIA	KARATE KLUB HRVATSKI SOKOL OSIJEK		CRO - CROATIA	
5	STUDENKOVA DARIA	MOWGLY KARATE CLUB		UKR - UKRAINE	
7	BARANOVA ULIANA	OKINAWA		UKR - UKRAINE	
7	ALEKSANDROVA POLINA	OKINAWA		UKR - UKRAINE	
9	VLAHOVIĆ KATARINA	KARATE KLUB ISKRA		MNE - MONTENEGRO	
9	LAKNER MAJA	KARATE KLUB BREŽICE		SLO - SLOVENIA	
11	SZILÁGYI EMMA	KSI HUNGARY		HUN - HUNGARY	
11	GOLOD ANASTASIIA	MOWGLY KARATE CLUB		UKR - UKRAINE	

31ST KARATE GRAND PRIX CROATIA - 2023-01-20

Official Results

13	LAZANSKI MAJA	KARATE KLUB BREŽICE		SLO - SLOVENIA	
13	MATTUGINI ESTER	SPAZIO SPORT FORTE DEI MARMI		ITA - ITALY	
15	STAGI NICOLE	SPAZIO SPORT FORTE DEI MARMI		ITA - ITALY	
15	GIOMBI SOFIA	KARATE DO TRIESTE		ITA - ITALY	
17	PERVAN JURJA	KARATE KLUB OMEGA		CRO - CROATIA	
17	BARIĆ ANTONIJA	KARATE KLUB ALFA		CRO - CROATIA	
17	BABELOVA DANIELA	SPORT SCHOOL KARATE BRATISLAVA		SVK - SLOVAKIA	
17	FRIGENI MICHELA	MASTER RAPID SKF CBL		ITA - ITALY	
21	KREGAR GABRIJELA	KARATE KLUB SEKI		SLO - SLOVENIA	
21	PARIMBELLI CAROLINA	MASTER RAPID SKF CBL		ITA - ITALY	
21	POLAK TIA	KARATE KLUB KRANJ		SLO - SLOVENIA	
21	NOAM YUVAL	JKS ISRAEL		ISR - ISRAEL	
25	STEINBERG ELLA	JKS ISRAEL		ISR - ISRAEL	
25	MIZRAHI YAARA	JKS ISRAEL		ISR - ISRAEL	

KATA FEMALE JUNIORS

1	GRUPPIONI ASIA	ITALIAN NATIONAL TEAM		ITA - ITALY	
2	CELO SIMA	LZ KARATE NIEDERÖSTERREICH		AUT - AUSTRIA	
3	DOMINIJANNI ELISA	BERRETTONI FEDERICO		ITA - ITALY	
3	MRAZOVA REBECA	SLOVAK NATIONAL TEAM		SVK - SLOVAKIA	
5	FODOR AMIRA	KSI HUNGARY		HUN - HUNGARY	
5	NIKOLIC MINA	SKIPPER		SRB - SERBIA	
7	ALEKSANDROVA POLINA	OKINAWA		UKR - UKRAINE	
7	KOBAL PAHOR LEA	KARATE KLUB MAWASHI POSTOJNA		SLO - SLOVENIA	
9	VERDONE MELISSA	MASTER RAPID SKF CBL		ITA - ITALY	
9	LUJIĆ ANA	SLAVONSKI BROD		CRO - CROATIA	
11	STANGHERLIN SOFIA	SPORT TARGET		ITA - ITALY	
11	NORIS GIADA	MASTER RAPID SKF CBL		ITA - ITALY	
13	IPPOLITI IRENE	ASD SHOTOKAN KARATE POZZUOLO DEL FRIULI		ITA - ITALY	
13	MESAGLIO MARTINA	ASD SHOTOKAN KARATE POZZUOLO DEL FRIULI		ITA - ITALY	
15	KHOLODNIAK DARIA	ZAKHYST KARATE CLUB		UKR - UKRAINE	
15	TARANENKO SOFIIA	SHOGUN SPORTS CORPORATION - KYIV		UKR - UKRAINE	
17	CAPPELLATO MARIA	A.S.D. SEN SHIN KAI ROVIGO		ITA - ITALY	

31ST KARATE GRAND PRIX CROATIA - 2023-01-20

Official Results

17	BULJAN TEA	KARATE KLUB SHIHAN - ZAGREB		CRO - CROATIA	
17	BARANOVA ULIANA	OKINAWA		UKR - UKRAINE	
17	GOLOD ANASTASIIA	MOWGLY KARATE CLUB		UKR - UKRAINE	
21	KONTREC ALJA	KARATE KLUB MAWASHI POSTOJNA		SLO - SLOVENIA	
21	ZORI ANNA	KARATE DO TRIESTE		ITA - ITALY	
21	BRAMBILLA CHIARA	MASTER RAPID SKF CBL		ITA - ITALY	
21	MAESTRI ERIKA	MASTER RAPID SKF CBL		ITA - ITALY	
25	VIELMI ELISA	MASTER RAPID SKF CBL		ITA - ITALY	
25	NOAM YUVAL	JKS ISRAEL		ISR - ISRAEL	
25	MATTUGINI ESTER	SPAZIO SPORT FORTE DEI MARM		ITA - ITALY	
25	KRSNIK NIKA	KARATE KLUB ALFA		CRO - CROATIA	
29	PARIMBELLI CAROLINA	MASTER RAPID SKF CBL		ITA - ITALY	

Kata female seniors

1	MLADEŽIĆ BOJANA	KARATE ACADEMY BUSHIDO		SRB - SERBIA	
2	NORIS GIADA	MASTER RAPID SKF CBL		ITA - ITALY	
3	CELO FUNDA	LZ KARATE NIEDERÖSTERREICH		AUT - AUSTRIA	
3	MARCHETTI GIULIA	SPORT TARGET		ITA - ITALY	
5	PERUZZI GIADA	SPORT TARGET		ITA - ITALY	
5	MEŠIĆ MINA	KARATE KLUB ČUKARIČKI RODA BEOGRAD		SRB - SERBIA	
7	NADIŽAR LANA TISA	KARATE KLUB KRANJ		SLO - SLOVENIA	
7	BRUNANSKA KRISTINA	SLOVAK NATIONAL TEAM		SVK - SLOVAKIA	
9	VANUSANIKOVA JANA	SLOVAK NATIONAL TEAM		SVK - SLOVAKIA	
9	MALČEC SARA	KK VIROVITICA		CRO - CROATIA	
11	TARANENKO SOFIIA	SHOGUN SPORTS CORPORATION - KYIV		UKR - UKRAINE	
11	CRESCENZI ELISA	G.S.FF.OO. POLIZIA DI STATO		ITA - ITALY	
13	DI LELIO ELENA	ASD ESERCITO - 187° FOLGORE		ITA - ITALY	
13	TAKACOVA TEREZA	SLOVAK NATIONAL TEAM		SVK - SLOVAKIA	
15	HOLLWEGER ANJA	ASKÖ KARATE KARA		AUT - AUSTRIA	
15	CAPPELLATO MARIA	A.S.D. SEN SHIN KAI ROVIGO		ITA - ITALY	
17	SHOR SIMONA	JKS ISRAEL		ISR - ISRAEL	
17	JELEN NIKA	KK SAMOBOR		CRO - CROATIA	
19	LORENZA MEL	SSD POLISPORTIVA TERRAGLIO		ITA - ITALY	
19	LORENZONI ELENA	SPAZIO SPORT FORTE DEI MARM		ITA - ITALY	

31ST KARATE GRAND PRIX CROATIA - 2023-01-20

Official Results

kata female U21				
1	ROVERSI ELENA	ITALIAN NATIONAL TEAM		ITA - ITALY
2	EUSEPI ALESSIA	A.S.D. KARATE ROMA		ITA - ITALY
3	NORIS GIADA	MASTER RAPID SKF CBL		ITA - ITALY
3	RAGUZ IVANA	KARATE KLUB HRVATSKI DRAGOVOLJAC		CRO - CROATIA
5	CRESCENZI ELISA	G.S.FF.OO. POLIZIA DI STATO		ITA - ITALY
5	MEŠIĆ MINA	KARATE KLUB ČUKARIČKI RODA BEOGRAD		SRB - SERBIA
7	VIELMI ELISA	MASTER RAPID SKF CBL		ITA - ITALY
7	DI LELIO ELENA	ASD ESERCITO - 187° FOLGORE		ITA - ITALY
9	NADIŽAR LANA TISA	KARATE KLUB KRANJ		SLO - SLOVENIA
9	NIKOLIC MINA	SKIPPER		SRB - SERBIA
11	JELEN NIKA	KK SAMOBOR		CRO - CROATIA
11	VERDONE MELISSA	MASTER RAPID SKF CBL		ITA - ITALY
13	BRAJA KLARA	KARATE KLUB OMEGA		CRO - CROATIA
13	MESAGLIO MARTINA	ASD SHOTOKAN KARATE POZZUOLO DEL FRIULI		ITA - ITALY
15	ČVOROVIĆ ALEKSANDRA	ŠPORTNO DRUŠTVO GORICA		SLO - SLOVENIA
15	MARCHETTI GIULIA	SPORT TARGET		ITA - ITALY
17	PERUZZI GIADA	SPORT TARGET		ITA - ITALY
17	TAKACOVA TEREZA	SLOVAK NATIONAL TEAM		SVK - SLOVAKIA
19	IPPOLITI IRENE	ASD SHOTOKAN KARATE POZZUOLO DEL FRIULI		ITA - ITALY
19	STANGHERLIN SOFIA	SPORT TARGET		ITA - ITALY
21	BRAMBILLA CHIARA	MASTER RAPID SKF CBL		ITA - ITALY
21	MAESTRI ERIKA	MASTER RAPID SKF CBL		ITA - ITALY

KATA GIRLS 10 YEARS				
1	TALIC LEJLA	KARATE AKADEMIJA - ARNELA ODŽAKOVIĆ		BIH - BOSNIA AND HERZEGOVINA
2	KOSTADINOVA ALEKSANDRA	KARATE DOJO BRAČ		CRO - CROATIA
3	SOTNIKOVA IVANKA	TIGER TEAM		UKR - UKRAINE
3	PAŠIĆ KARLA	KARATE KLUB TRAVNIK GS-TMT		BIH - BOSNIA AND HERZEGOVINA

KATA GIRLS 11 YEARS				
1	HADŽIĆ AZRA	KARATE AKADEMIJA - ARNELA ODŽAKOVIĆ		BIH - BOSNIA AND HERZEGOVINA
2	ŠTURLIĆ MAŠA	KARATE KLUB POLET ZAGREB		CRO - CROATIA

31ST KARATE GRAND PRIX CROATIA - 2023-01-20

Official Results

3	MESAREK ANJA	KARATE KLUB TRNJE		CRO - CROATIA	
3	KRISTIĆ KAROLINA	KARATE KLUB SEKI		SLO - SLOVENIA	
5	PRELEVIĆ LANA	KARATE KLUB ISKRA		MNE - MONTENEGRO	
5	BENKŐ NÓRA	MTK BUDAPEST		HUN - HUNGARY	
7	PISNIK GAJA	LOVRENC NA POHORJU		SLO - SLOVENIA	
7	PHILIP SHIRA	JKS ISRAEL		ISR - ISRAEL	

KATA GIRLS 12 YEARS

1	BERETTA MARTINA	A.S.D. ACADEMIA HYDRA		ITA - ITALY	
2	JERŠIČ ŽANA	KARATE KLUB SEKI		SLO - SLOVENIA	
3	PISNIK MAJA MARI	KARATE KLUB VELENJE		SLO - SLOVENIA	
3	MILJATOVIĆ ANDJELA	KARATE KLUB SEKI		SLO - SLOVENIA	
5	BEŠIĆ LANA	KARATE KLUB MAWASHI POSTOJNA		SLO - SLOVENIA	
5	ŠTURLIĆ MAŠA	KARATE KLUB POLET ZAGREB		CRO - CROATIA	
7	VERČKO ANA	LOVRENC NA POHORJU		SLO - SLOVENIA	
7	RUDOLF NIKA	KARATE KLUB VELENJE		SLO - SLOVENIA	

KATA GIRLS 13 YEARS

1	BELJKAS NEDA	KKPOTOCI		MNE - MONTENEGRO	
2	BERETTA MARTINA	A.S.D. ACADEMIA HYDRA		ITA - ITALY	
3	FRIGENI MICHELA	MASTER RAPID SKF CBL		ITA - ITALY	
3	MILJATOVIĆ ANDJELA	KARATE KLUB SEKI		SLO - SLOVENIA	
5	ALIBALIĆ ZARA	KARATE KLUB RESPECT		BIH - BOSNIA AND HERZEGOVINA	
5	BEŠIĆ LANA	KARATE KLUB MAWASHI POSTOJNA		SLO - SLOVENIA	
7	BENKŐ SZONJA LOLA	MTK BUDAPEST		HUN - HUNGARY	
7	ELII SOFIA	KATANA		UKR - UKRAINE	

KATA GIRLS 14 YEARS

1	KISSKOVÁ KAROLINA	SLOVAK NATIONAL TEAM		SVK - SLOVAKIA	
2	OKOLICANYOVA REBEKA	SLOVAK NATIONAL TEAM		SVK - SLOVAKIA	
3	FRIGENI MICHELA	MASTER RAPID SKF CBL		ITA - ITALY	
3	HUDINA TEA	KARATE KLUB BUSHIDO, ZAGREB		CRO - CROATIA	
5	MAVSAR TAJDA	KARATE KLUB SEKI		SLO - SLOVENIA	
5	VALENTI JENNIFER	MASTER RAPID SKF CBL		ITA - ITALY	
7	MIZRAHI YAARA	JKS ISRAEL		ISR - ISRAEL	
7	BACSÓ KATA	MTK BUDAPEST		HUN - HUNGARY	

31ST KARATE GRAND PRIX CROATIA - 2023-01-20

Official Results

KATA GIRLS 8 YEARS				
1	HUSIĆ LANA	KARATE KLUB SEKI		SLO - SLOVENIA
2	ŠTOKIĆ MATEA	KARATE KLUB TRNJE		CRO - CROATIA
3	VLADIĆ MILA	KARATE KLUB POLET ZAGREB		CRO - CROATIA
3	BUGANOVA ELA	SPORT SCHOOL KARATE BRATISLAVA		SVK - SLOVAKIA
5	SREBRE LANA	KARATE KLUB SEKI		SLO - SLOVENIA
5	GOMBAČ LAURA	KARATE KLUB MAWASHI POSTOJNA		SLO - SLOVENIA

KATA GIRLS 9 YEARS				
1	PODKOPAIEVA MARIIA	KATANA		UKR - UKRAINE
2	PUSHKOVA MARIIA	KATANA		UKR - UKRAINE
3	ADILOVIC ZAHRA	KK MLADOST VITEZ		BIH - BOSNIA AND HERZEGOVINA
3	HUSIĆ LANA	KARATE KLUB SEKI		SLO - SLOVENIA
5	KOSIĆ ANA	KARATE KLUB TEMPO		CRO - CROATIA
5	PISNIK SARA	KARATE KLUB VELENJE		SLO - SLOVENIA

KATA male cadets				
1	MULLER JURAJ	SLOVAK NATIONAL TEAM		SVK - SLOVAKIA
2	CAPONERA EMANUELE	A.S.D. KARATE ROMA		ITA - ITALY
3	FILEŠ MARK	KARATE KLUB ALFA		CRO - CROATIA
3	NEDOROŠČIK DANIEL	KARATE KLUB SHIHAN POPRAD		SVK - SLOVAKIA
5	CALABRESE FILIPPO	MASTER RAPID SKF CBL		ITA - ITALY
5	BICOS NIKITA	A.S.D. SEN SHIN KAI ROVIGO		ITA - ITALY
7	ŽEINSKI IVAN	KARATE KLUB ALFA		CRO - CROATIA
7	GENDES DAVID	SLOVAK NATIONAL TEAM		SVK - SLOVAKIA
9	KHABLO DANYLO	KATANA		UKR - UKRAINE
9	MORETTI OSCAR	MASTER RAPID SKF CBL		ITA - ITALY
11	HLUSHCHENKO ARTUR	OKINAWA		UKR - UKRAINE
11	GULYAS GERGELY	UTE HUNGARY		HUN - HUNGARY
13	KUKIĆ IVAN	KARATE KLUB ALFA		CRO - CROATIA
13	SEMENENKO NIKITA	SENBIN KARATE CLUB		UKR - UKRAINE
15	CICVARIĆ LUKA	KARATE KLUB BREŽICE		SLO - SLOVENIA
15	DI RUBBA LUIGI	ITALIAN NATIONAL TEAM		ITA - ITALY
17	MUSIC ADIN	KARATE KLUB FENIKS		BIH - BOSNIA AND HERZEGOVINA
17	JAKOVLJEVIĆ VASILIJ	SPORTSKO UDRUŽENJE SPARTANCI 026 - S. PALANKA		SRB - SERBIA

31ST KARATE GRAND PRIX CROATIA - 2023-01-20

Official Results

17	GYULAFFY PETER	SLOVAK NATIONAL TEAM		SVK - SLOVAKIA	
17	ROZHKOV DMYTRO	KATANA		UKR - UKRAINE	
21	APRILOV DENIS	KARATE CLUB SHURIKEN		BUL - BULGARIA	
21	PAUNOVIĆ ĐORĐE	KLUB KONTAKTNIH SPORTOVA BORAC - ČAČAK		SRB - SERBIA	
21	RAMIĆ FARIS	KBES 5.11-BK BOSANSKA KRUPA		BIH - BOSNIA AND HERZEGOVINA	
21	KISIĆ FRAN	KARATE KLUB IPON ZAGREB		CRO - CROATIA	
25	PANFILE DAVID	SPAZIO SPORT FORTE DEI MARMI		ITA - ITALY	
25	JOVIČIĆ JOVIĆ DORIAN	KARATE KLUB ČUKARIČKI RODA BEOGRAD		SRB - SERBIA	
25	KRSNIK VITO	KARATE KLUB ALFA		CRO - CROATIA	
25	TOMIČIĆ IVANO	ENPI RAB		CRO - CROATIA	
29	GIUSTINIANO ALESSIO	BERRETTONI FEDERICO		ITA - ITALY	

KATA MALE JUNIORS

1	PAPPALARDO VINCENZO	ITALIAN NATIONAL TEAM		ITA - ITALY	
2	MATUSKI GEORGI	KARATE CLUB SHURIKEN		BUL - BULGARIA	
3	HUIĆ DINO	KARATE KLUB ALFA		CRO - CROATIA	
3	FILIP DENIS	SLOVAK NATIONAL TEAM		SVK - SLOVAKIA	
5	FUSCAGNI ALEX	BUSHIDO KARATE PERUGIA		ITA - ITALY	
5	BOŠKOV ALEKSANDAR	KARATE ACADEMY BUSHIDO		SRB - SERBIA	
7	TARIK SALKIC	KK PERFEKT SARAJEVO		BIH - BOSNIA AND HERZEGOVINA	
7	EDERAR KARIM	MASTER RAPID SKF CBL		ITA - ITALY	
9	GIOVAGNONI GIOELE	BUSHIDO KARATE PERUGIA		ITA - ITALY	
9	BARLETTA LEONARDO	MASTER RAPID SKF CBL		ITA - ITALY	
11	NEDOROŠČIK DANIEL	KARATE KLUB SHIHAN POPRAD		SVK - SLOVAKIA	
11	MORETTI OSCAR	MASTER RAPID SKF CBL		ITA - ITALY	
13	BOMBARDI LEONARDO	MASTER RAPID SKF CBL		ITA - ITALY	
13	METELENKO VITALIY	KATANA		UKR - UKRAINE	
15	APRILOV DENIS	KARATE CLUB SHURIKEN		BUL - BULGARIA	
15	CALABRESE FILIPPO	MASTER RAPID SKF CBL		ITA - ITALY	
17	BRAVARIĆ ČILO DAMJAN	ENPI RAB		CRO - CROATIA	
17	JAKOVLJEVIĆ VASILJE	SPORTSKO UDRUŽENJE SPARTANCI 026 - S. PALANKA		SRB - SERBIA	

31ST KARATE GRAND PRIX CROATIA - 2023-01-20

Official Results

17	MADONIA FILIPPO MARIA	A.S.D REAL SOCIETÀ MONREALE		ITA - ITALY	
17	BICOS NIKITA	A.S.D. SEN SHIN KAI ROVIGO		ITA - ITALY	
21	PURIĆ MILOŠ	KLUB KONTAKTNIH SPORTOVA BORAC - ČAČAK		SRB - SERBIA	
21	MEŠANOVIČ BENJAMIN	KARATE KLUB VELENJE		SLO - SLOVENIA	
21	KEKO LUKA	ENPI RAB		CRO - CROATIA	
25	MASSAGLIA MARCO	SPAZIO SPORT FORTE DEI MARMI		ITA - ITALY	
25	SOKOLOV HLIB	ZAKHYST KARATE CLUB		UKR - UKRAINE	
25	CHIKOREL LIOR	JKS ISRAEL		ISR - ISRAEL	
29	VALDESI FRANCESCO	A.S.D. POL. POLO VERDE		ITA - ITALY	
29	ŠTURLIĆ LUKA	KARATE KLUB POLET ZAGREB		CRO - CROATIA	

Kata male seniors

1	SUBOTA UROS	SKIPPER		SRB - SERBIA	
2	SZOLAR PAVOL	SLOVAK NATIONAL TEAM		SVK - SLOVAKIA	
3	HRCKA ROMAN	SLOVAK NATIONAL TEAM		SVK - SLOVAKIA	
3	MIKLOVICS DAMIAN	SLOVAK NATIONAL TEAM		SVK - SLOVAKIA	
5	POLSINELLI GUIDO	G.S.FF.OO. POLIZIA DI STATO		ITA - ITALY	
5	VELADŽIĆ SENAIĐ	KBES 5.11-BK BOSANSKA KRUPA		BIH - BOSNIA AND HERZEGOVINA	
7	STANKOVIĆ ANDRIJA	KARATE KLUB ELIDNIŠ		SRB - SERBIA	
7	VALET PATRICK	INOUE-HA KARATE-DO FELDKIRCHEN		AUT - AUSTRIA	
9	EDERAR KARIM	MASTER RAPID SKF CBL		ITA - ITALY	
9	PICCIONI EDOARDO	SSD POLISPORTIVA TERNANA		ITA - ITALY	
11	SLUGA JURE	KARATE KLUB SEKI		SLO - SLOVENIA	
11	SLEHOFFER RICHARD	SLOVAK NATIONAL TEAM		SVK - SLOVAKIA	
13	KÖSTENBAUMER HANNES	INOUE-HA KARATE-DO FELDKIRCHEN		AUT - AUSTRIA	
13	GIOVAGNONI GIOELE	BUSHIDO KARATE PERUGIA		ITA - ITALY	
15	ZÖCHLING FLORIAN	LZ KARATE NIEDERÖSTERREICH		AUT - AUSTRIA	
15	PEDRUZZI OMAR	MASTER RAPID SKF CBL		ITA - ITALY	
17	ŠENJUG MAKS LUKA	KK VIROVITICA		CRO - CROATIA	
17	FUSCAGNI ALEX	BUSHIDO KARATE PERUGIA		ITA - ITALY	
17	PINKUS NIMROD	JKS ISRAEL		ISR - ISRAEL	
17	BARLETTA LEONARDO	MASTER RAPID SKF CBL		ITA - ITALY	
21	BEKE BÁLINT	KSI HUNGARY		HUN - HUNGARY	

31ST KARATE GRAND PRIX CROATIA - 2023-01-20

Official Results

21	BOMBARDI LEONARDO	MASTER RAPID SKF CBL		ITA - ITALY	
21	CALABRESE LUCA	A.S.D. SEN SHIN KAI ROVIGO		ITA - ITALY	
21	MATKY RONALD	LZ KARATE NIEDERÖSTERREICH		AUT - AUSTRIA	
25	COSTA PIERLUIGI	A.S.D REAL SOCIETÀ MONREALE		ITA - ITALY	

kata male U21

1	POLSINELLI GUIDO	G.S.FF.OO. POLIZIA DI STATO		ITA - ITALY	
2	BARDOS ÁDÁM	KARATE KLUB SPORTINGBUDO		HUN - HUNGARY	
3	PICCIONI EDOARDO	SSD POLISPORTIVA TERNANA		ITA - ITALY	
3	BINOTTO PIETRO	SPORT TARGET		ITA - ITALY	
5	HRCKA ROMAN	SLOVAK NATIONAL TEAM		SVK - SLOVAKIA	
5	SLUGA JURE	KARATE KLUB SEKI		SLO - SLOVENIA	
7	RELIĆ MATIJA	KK VIROVITICA		CRO - CROATIA	
7	STERNIŠA NEJC	KARATE KLUB MAWASHI POSTOJNA		SLO - SLOVENIA	
9	MATUSKI GEORGI	KARATE CLUB SHURIKEN		BUL - BULGARIA	
9	TKALČEC TOMISLAV	KK OKINAWA MALI BUKOVEC		CRO - CROATIA	
11	VELADŽIĆ SENAJD	KBES 5.11-BK BOSANSKA KRUPA		BIH - BOSNIA AND HERZEGOVINA	
11	BOMBARDI LEONARDO	MASTER RAPID SKF CBL		ITA - ITALY	
13	VALDESI FRANCESCO	A.S.D. POL. POLO VERDE		ITA - ITALY	
13	SOKOLOV HLIB	ZAKHYST KARATE CLUB		UKR - UKRAINE	
15	BEKE BÁLINT	KSI HUNGARY		HUN - HUNGARY	
15	PEDRUZZI THOMAS	MASTER RAPID SKF CBL		ITA - ITALY	
17	BARLETTA LEONARDO	MASTER RAPID SKF CBL		ITA - ITALY	
17	CALABRESE LUCA	A.S.D. SEN SHIN KAI ROVIGO		ITA - ITALY	
17	EDERAR KARIM	MASTER RAPID SKF CBL		ITA - ITALY	
17	MADONIA FILIPPO MARIA	A.S.D REAL SOCIETÀ MONREALE		ITA - ITALY	
21	MASSAGLIA MARCO	SPAZIO SPORT FORTE DEI MARMI		ITA - ITALY	
21	BOROJEVIĆ MARIO	KARATE KLUB TEMPO		CRO - CROATIA	
21	MEŠANOVIČ BENJAMIN	KARATE KLUB VELENJE		SLO - SLOVENIA	
21	MATUŠAN ANTONIO	ENPI RAB		CRO - CROATIA	
25	FAFANDEL DORIAN	ENPI RAB		CRO - CROATIA	

KUMITE BOYS 11-12 YEARS +54KG

1	ZUNĐA EMIR	KARATE KLUB SAMBON - VOGOSCA		BIH - BOSNIA AND HERZEGOVINA	
---	------------	---------------------------------	---	---------------------------------	--

31ST KARATE GRAND PRIX CROATIA - 2023-01-20

Official Results

2	HERCEGOVAC TARIK	KARATE KLUB RESPECT		BIH - BOSNIA AND HERZEGOVINA	
3	MUCIĆ DOMINIK	KARATE KLUB TRNJE		CRO - CROATIA	
3	TURKOVIĆ JAN	KARATE KLUB LJUBLJANA		SLO - SLOVENIA	
5	LOPATKA MARTIN	SPORT SCHOOL KARATE BRATISLAVA		SVK - SLOVAKIA	
5	HRŠAK FILIP	KARATE KLUB HRVATSKI DRAGOVOLJAC		CRO - CROATIA	

KUMITE BOYS 11-12 YEARS -34KG

1	CAFISO EDOARDO	CLUB ARTI ORIENTALI CANTU ASD		ITA - ITALY	
2	PONTIL SCALA LORENZO	TSKS BELLUNO		ITA - ITALY	
3	KHODAKOVSKIY YEVSEVII	CHAMPION KARATE CLUB		UKR - UKRAINE	
3	RUDENKO KLYMENTII	CHAMPION KARATE CLUB		UKR - UKRAINE	
5	MAVSAR TADEJ	KARATE KLUB SEKI		SLO - SLOVENIA	
5	RUSANOV DMYTRO	CHAMPION KARATE CLUB		UKR - UKRAINE	
7	PAŠIĆ ADAM	KARATE KLUB VELENJE		SLO - SLOVENIA	
7	GRADINČIĆ VEDAD	KARATE KLUB VEZIR		BIH - BOSNIA AND HERZEGOVINA	
9	PEJIN IVAN	KARATE KLUB NEVERA		CRO - CROATIA	

KUMITE BOYS 11-12 YEARS -39KG

1	GAŠPAR MARTIN	ŠK CMK BANSKÁ BYSTRICA		SVK - SLOVAKIA	
2	VERCHILOVSKY LIAM	AZKOKAI MAKABI BAT-YAM		ISR - ISRAEL	
3	BAGI ÁDÁM	SZARVAS		HUN - HUNGARY	
3	CARABULEA EGOR	BARS BALTI WKF		MDA - MOLDOVA, REPUBLIC OF	
5	LISTRATOV MATVII	CHAMPION KARATE CLUB		UKR - UKRAINE	
5	BERGNA LORENZO	CLUB ARTI ORIENTALI CANTU ASD		ITA - ITALY	
7	ŠABEC ALJOŠA	KARATE KLUB MAWASHI POSTOJNA		SLO - SLOVENIA	
7	JELEN GAL	KARATE KLUB VELENJE		SLO - SLOVENIA	

KUMITE BOYS 11-12 YEARS -44KG

1	KARAGIANNIS STAVROS	ATHLITIKOS SYLLOGOS AMAROUSIOU		GRE - GREECE	
2	SKATARIC VESELIN	K.K. OMLADINAC		MNE - MONTENEGRO	
3	ŠAKINOVIĆ ADNAN	KARATE KLUB REGENERACIJA		BIH - BOSNIA AND HERZEGOVINA	
3	TRINAJSTIĆ FRAN	KARATE KLUB NEVERA		CRO - CROATIA	

31ST KARATE GRAND PRIX CROATIA - 2023-01-20

Official Results

5	KIRNOSOV ANDREY	AZKOKAI MAKABI BAT-YAM		ISR - ISRAEL	
5	GRUBEŠIĆ PETAR	KARATE KLUB KARLOVAC 1969		CRO - CROATIA	
7	KATZIR EVYATAR	JKS ISRAEL		ISR - ISRAEL	
7	WURTZ NOLAN	TEAM OSCENDA KARATÉ		FRA - FRANCE	
9	PRYNDIUK ARTEM	ASD KARATE CLUB VALDOBBIADENE CROCETTA		ITA - ITALY	
9	HERIĆ NEDIM	KARATE KLUB RAŠID BUČA		BIH - BOSNIA AND HERZEGOVINA	

KUMITE BOYS 11-12 YEARS -49KG

1	KOLESNYK MAKAR	KARATE TEAM CONCORDIA		UKR - UKRAINE	
2	VICKOVIĆ MIHOVIL	KARATE KLUB BUSHIDO, ZAGREB		CRO - CROATIA	
3	GRACIC DAN	KARATE AKADEMIJA - ARNELA ODŽAKOVIĆ		BIH - BOSNIA AND HERZEGOVINA	
3	KVESIĆ VIKTOR	HERCEGOVINA- ZAGREB		CRO - CROATIA	
5	ANDRUSIAK ILLIA	KARATE TEAM CONCORDIA		UKR - UKRAINE	
5	ELIAS WASIM	JAMAL SAADA SHOTOKAN KARATE		ISR - ISRAEL	
7	GOTTI THOMAS	ASD OKINAWA FIGHT		ITA - ITALY	
7	AWAWDI HOSNI	JAMAL SAADA SHOTOKAN KARATE		ISR - ISRAEL	

KUMITE BOYS 11-12 YEARS -54KG

1	TAHIIEV YEVHEN	LEADER TEAM		UKR - UKRAINE	
2	ILINCIC FILIP	K.K. OMLADINAC		MNE - MONTENEGRO	
3	CONVERSINI SIMONE	A.S.D. MABUNI CLUB CIVITAVECCHIA		ITA - ITALY	
3	ZUNDJA AMIR	KARATE KLUB SAMBON - VOGOSCA		BIH - BOSNIA AND HERZEGOVINA	
5	PIRVU RAFAEL	ASD OKINAWA FIGHT		ITA - ITALY	
5	WISSAM ISSA	JAMAL SAADA SHOTOKAN KARATE		ISR - ISRAEL	

KUMITE BOYS 13-14 YEARS +69KG

1	OČKO GAL	SHOTOKAN KARATE KLUB OPLOTNICA		SLO - SLOVENIA	
2	ČOLAK STANKO	KARATE KLUB ŠIROKI ŠIROKI BRIJEG		BIH - BOSNIA AND HERZEGOVINA	
3	MAURO CRISTIAN	ACCADEMIA KARATE UNION TEAM		ITA - ITALY	
3	BERLUSCONI DAVIDE	CLUB ARTI ORIENTALI CANTU ASD		ITA - ITALY	
5	SAWAED TAREK	JAMAL SAADA SHOTOKAN KARATE		ISR - ISRAEL	

KUMITE BOYS 13-14 YEARS -44KG

1	HERULA ROMAN	TIGER TEAM		UKR - UKRAINE	
---	--------------	------------	---	---------------	--

31ST KARATE GRAND PRIX CROATIA - 2023-01-20

Official Results

2	LESKOVAR SVEN	HERCEGOVINA-ZAGREB		CRO - CROATIA	
3	KOVAČIK ŠIMON	TORNADO KARATE TEAM		SVK - SLOVAKIA	
3	BORUP HANSEN ESBEN	ITOSU-KAI BOSATSU		DEN - DENMARK	
5	PANIĆ TINO	GLOBUS ČAKOVEC		CRO - CROATIA	
5	DURAKOVIC HAMZA	KARATE KLUB KUMITE		BIH - BOSNIA AND HERZEGOVINA	
7	STAVARACHI RENAT	BARS BALTI WKF		MDA - MOLDOVA, REPUBLIC OF	
7	KHAZEN KHAZEN	JAMAL SAADA SHOTOKAN KARATE		ISR - ISRAEL	
9	BELTRAMI MASSIMO	CLUB ARTI ORIENTALI CANTU ASD		ITA - ITALY	

KUMITE BOYS 13-14 YEARS -49KG

1	CHEBAN OLEKSANDR	KATANA		UKR - UKRAINE	
2	JANJIĆ FRANKO	KK LOTOS ZAGREB		CRO - CROATIA	
3	HULINA VITO	KARATE KLUB VELIKA GORICA		CRO - CROATIA	
3	SANZARO MICHELE	ASD REMBUKAN KARATE VILLASMUNDO		ITA - ITALY	
5	FIOREMISTO MATTIA	ASD_DINAMO_KARATE		ITA - ITALY	
5	LAKOVIĆ MARKO	KARATE KLUB ISKRA		MNE - MONTENEGRO	
7	HABJANOVIĆ KARLO	KARATE KLUB KTC KRIZEVCI		CRO - CROATIA	
7	KOLESNYK MAKAR	KARATE TEAM CONCORDIA		UKR - UKRAINE	

KUMITE BOYS 13-14 YEARS -54KG

1	CHERNETSKYI BOHDAN	CHAMPION KARATE CLUB		UKR - UKRAINE	
2	PERMOZER MARC	KARATE KLUB KOLEKTOR IDRIJA		SLO - SLOVENIA	
3	RUZSINSZKI BALÁZS	SZARVAS		HUN - HUNGARY	
3	ZELJKO IVAN	KARATE KLUB NOVI ZAGREB		CRO - CROATIA	
5	UDOVIČIĆ JAKOV	KK SAMOBOR		CRO - CROATIA	
5	LIGAS EDOARDO	ASD ESERCITO - 187° FOLGORE		ITA - ITALY	
7	KATZIR ASAF	JKS ISRAEL		ISR - ISRAEL	
7	BEGANOVIĆ AHMED	KK MASTER BUGOJNO		BIH - BOSNIA AND HERZEGOVINA	

KUMITE BOYS 13-14 YEARS -59KG

1	MATIJEVIĆ ANTE	KARATE KLUB KASTAV		CRO - CROATIA	
2	KOZAK KOSTIANTYN	LEADER TEAM		UKR - UKRAINE	
3	OBAJDIN FILIP	KARATE KLUB KASTAV		CRO - CROATIA	
3	MIHOV MARTIN	RONIN11 SOFIA		BUL - BULGARIA	
5	DANDRIA COSIMO	PRO-TEAM ASD		ITA - ITALY	
5	BABIĆ BORNA	KARATE KLUB KOSTRENA		CRO - CROATIA	

31ST KARATE GRAND PRIX CROATIA - 2023-01-20

Official Results

7	NAÑO TOMÁŠ	SLOVAK NATIONAL TEAM		SVK - SLOVAKIA	
---	------------	----------------------	---	----------------	--

KUMITE BOYS 13-14 YEARS -64KG

1	KRŽIŠNIK LAN	KARATE KLUB LJUBLJANA		SLO - SLOVENIA	
2	KINASH YAROSLAV	KARATE TEAM CONCORDIA		UKR - UKRAINE	
3	ŠOLTIĆ ERVIN	GLOBUS ČAKOVEC		CRO - CROATIA	
3	JESENIČ PETER	SLOVAK NATIONAL TEAM		SVK - SLOVAKIA	
5	KONČURAT LOVRO	KARATE KLUB CHAMPION RIJEKA		CRO - CROATIA	
5	LAGINJA JOSIP	KARATE KLUB CHAMPION RIJEKA		CRO - CROATIA	

KUMITE BOYS 13-14 YEARS -69KG

1	FERRARINI FRANCESCO	ASD JUDO KARATE CLUB		ITA - ITALY	
2	VERIĆ NIKŠIĆ JAN	KARATE KLUB KASTAV		CRO - CROATIA	
3	GIULIANO SIMONE	CLUB ARTI ORIENTALI CANTU ASD		ITA - ITALY	
3	SHAKHOV MYKOLA	LEADER TEAM		UKR - UKRAINE	
5	MICHÁLEK JAKUB	SLOVAK NATIONAL TEAM		SVK - SLOVAKIA	
5	HUSAM ISSA	JAMAL SAADA SHOTOKAN KARATE		ISR - ISRAEL	



KUMITE BOYS 7-8 YEARS -24kg

1	CIELO LUCA	ASD KARATE TEAM 1999		ITA - ITALY	
2	KRIŽANOVIĆ MIMICA OLIVER	OKIT VODICE		CRO - CROATIA	
3	HAVRYLIUK VARLAM	TIGER TEAM		UKR - UKRAINE	

KUMITE BOYS 7-8 YEARS -28kg

1	MOLLARD ALETH	TEAM OSCENDA KARATÉ		FRA - FRANCE	
2	CRNKOVIC BORNA	KARATE KLUB TIGAR SISAK		CRO - CROATIA	
3	PAVLIUK NIKITA	KARATE TEAM CONCORDIA		UKR - UKRAINE	
3	BOICHUK OLEKSANDR	LEADER TEAM		UKR - UKRAINE	
5	EDUARD CHIȘ	CRIȘUL SPORT CLUB ORADEAA		ROU - ROMANIA	

KUMITE BOYS 7-8 YEARS -36kg







1	PERKOVIĆ NOA ADRIAN	OKIT VODICE		CRO - CROATIA	
2	LYTKIN ARTEM	LEADER TEAM		UKR - UKRAINE	

KUMITE BOYS 9-10 YEARS +43kg

1	MESIĆ LUKA	KARATE AKADEMIJA OSIJEK KAO		CRO - CROATIA	
2	HORVAT VID	HERCEGOVINA-ZAGREB		CRO - CROATIA	



31ST KARATE GRAND PRIX CROATIA - 2023-01-20

Official Results

KUMITE BOYS 9-10 YEARS -27KG				
1	ZAVOROTNYI OLEKSANDR	LEADER TEAM		UKR - UKRAINE
2	MIRANDA WILLIAM	TEAM OSCENDA KARATÉ		FRA - FRANCE
3	SAWAED ADI	JAMAL SAADA SHOTOKAN KARATE		ISR - ISRAEL
3	BARŠIĆ VITO	KARATE KLUB KARLOVAC 1969		CRO - CROATIA
5	MAČEŠIĆ MIHAEL	TAD RIJEKA		CRO - CROATIA
5	KRAVTSOV MATVII	TIGER TEAM		UKR - UKRAINE
7	BASILE BRAYAN	ASD_DINAMO_KARATE		ITA - ITALY
7	GAROFALO GABRIELE	ASD KARATE TEAM 1999		ITA - ITALY

KUMITE BOYS 9-10 YEARS -31kg				
1	DRAŽIĆ IVAN	HERCEGOVINA- ZAGREB		CRO - CROATIA
2	RIBAR TOMA	KK LOTOS ZAGREB		CRO - CROATIA
3	IATSIUK IVAN	LEADER TEAM		UKR - UKRAINE
3	HLUSHKU NIKITA	LEADER TEAM		UKR - UKRAINE
5	ADILOVIĆ HAMZA	KK MLADOST VITEZ		BIH - BOSNIA AND HERZEGOVINA
5	LYTKIN ARTEM	LEADER TEAM		UKR - UKRAINE
7	KHRISTOFOROV DIMA	TIGER TEAM		UKR - UKRAINE
7	SKAKOVSKYI SAVELII	KATANA		UKR - UKRAINE

KUMITE BOYS 9-10 YEARS -35kg				
1	URSAC PETRU	BARS BALTI WKF		MDA - MOLDOVA, REPUBLIC OF
2	DUDKA NIKITA	KARATE TEAM CONCORDIA		UKR - UKRAINE
3	BUTURAJAC MARK	KARATE KLUB KARLOVAC 1969		CRO - CROATIA
3	PERKOVIĆ BARTOL	KARATE KLUB NOVI ZAGREB		CRO - CROATIA
5	NOVAK LEON	GLOBUS ČAKOVEC		CRO - CROATIA
5	HALEP EMAN	KARATE KLUB VEZIR		BIH - BOSNIA AND HERZEGOVINA

KUMITE BOYS 9-10 YEARS -39kg				
1	CARABULEA EGOR	BARS BALTI WKF		MDA - MOLDOVA, REPUBLIC OF
2	RUSNAK OLEKSII	LEADER TEAM		UKR - UKRAINE
3	JAMINET SAMUEL	TEAM OSCENDA KARATÉ		FRA - FRANCE

KUMITE BOYS 9-10 YEARS -43kg				
1	BELLUZZI MATTEO	ASD KARATE TEAM 1999		ITA - ITALY
2	HAMDAN NASSER	JAMAL SAADA SHOTOKAN KARATE		ISR - ISRAEL

31ST KARATE GRAND PRIX CROATIA - 2023-01-20

Official Results

Kumite female Cadets +61kg				
1	TOMIĆ SARA	HERCEGOVINA-ZAGREB		CRO - CROATIA
2	CORREDDU NICOLE	WORLD WELLNESS KARATE SORSO		ITA - ITALY
3	HUMAR GAJA	KARATE KLUB KOLEKTOR IDRJA		SLO - SLOVENIA
3	KULIKOVÁ VIRA	ŠK CMK BANSKÁ BYSTRICA		SVK - SLOVAKIA
5	SELMAN AJRA	KARATE KLUB VEZIR		BIH - BOSNIA AND HERZEGOVINA
5	CHRASTINOVÁ PETRA	SLOVAK NATIONAL TEAM		SVK - SLOVAKIA
7	TAHIROVA MARIJA	TIGER TEAM		UKR - UKRAINE
7	BORICIC NADJA	MONTENEGRO		MNE - MONTENEGRO
9	KRSTOVIĆ TEODORA	KLUB KONTAKTNIH SPORTOVA BORAC - ČAČAK		SRB - SERBIA

Kumite female cadets -47kg				
1	BOSSI ALESSANDRA	SKORPION KARATE ASD		ITA - ITALY
2	TRSTENJAK AIDA	GLOBUS ČAKOVEC		CRO - CROATIA
3	OSTAPENKO ALISA	LEON KARATE CLUB		UKR - UKRAINE
3	LEGITTIMO LUDOVICA	ITALIAN NATIONAL TEAM		ITA - ITALY
5	JURISIC PATRICIJA	KARATE KLUB KUMITE		BIH - BOSNIA AND HERZEGOVINA
5	GRGUREVIC LEA	KARATE KLUB 10.DAN		CRO - CROATIA
7	OSTOJIĆ TIJANA	KLUB KONTAKTNIH SPORTOVA BORAC - ČAČAK		SRB - SERBIA
7	JURJEVIĆ ALISA EMA	KARATE KLUB BREGANA		CRO - CROATIA
9	SMOLČIĆ TIA	KK LOTOS ZAGREB		CRO - CROATIA

Kumite female cadets -54kg				
1	ZEUMEROVÁ ALEXANDRA	SLOVAK NATIONAL TEAM		SVK - SLOVAKIA
2	BARANOVA ULIANA	OKINAWA		UKR - UKRAINE
3	LUCIANI SYRIA	ITALIAN NATIONAL TEAM		ITA - ITALY
3	ADEL SANDO	SHINDOKAN MACCABI ISRAEL		ISR - ISRAEL
5	KURBEGOVIĆ EDNA	KARATE KLUB LJUBLJANA		SLO - SLOVENIA
5	PUSHKOVA ANASTASIIA	KATANA		UKR - UKRAINE
7	MAJDIAKOVÁ LAURA	ŠK CMK BANSKÁ BYSTRICA		SVK - SLOVAKIA
7	BANDIĆ PETRA	KARATE KLUB ZRINSKI		CRO - CROATIA
9	VASYLIEVA YELYZAVETA	CHAMPION KARATE CLUB		UKR - UKRAINE
9	LEBEN TINKARA	KARATE KLUB KRANJ		SLO - SLOVENIA
11	ABABSA LILAS	JAMAL SAADA SHOTOKAN KARATE		ISR - ISRAEL

31ST KARATE GRAND PRIX CROATIA - 2023-01-20

Official Results

Kumite female Cadets -61kg				
1	DAMJANOVIC JOVANA	MONTENEGRO		MNE - MONTENEGRO
2	VOLOSHYN SOLOMIYA	UNION TEAM		UKR - UKRAINE
3	STRAHIJA LAURA	GLOBUS ČAKOVEC		CRO - CROATIA
3	JESENIČOVÁ NINA	SLOVAK NATIONAL TEAM		SVK - SLOVAKIA
5	REDŽIĆ JANA	KK OPATIJA		CRO - CROATIA
5	JOKSIMOVIĆ ĐURĐA	KLUB KONTAKTNIH SPORTOVA BORAC - ČAČAK		SRB - SERBIA
7	GANDOLA VIOLA	CLUB ARTI ORIENTALI CANTU ASD		ITA - ITALY
7	BATH HANNAH	SPORTSKARATE.DK		DEN - DENMARK
9	MOCCIA MIRIAM	PRO-TEAM ASD		ITA - ITALY
9	VASYLIV TETYANA	LEADER TEAM		UKR - UKRAINE
11	BORGHESI MATILDA	MASTER RAPID SKF CBL		ITA - ITALY

Kumite female Juniors +66kg				
1	PERGOLES ASIJA	ITALIAN NATIONAL TEAM		ITA - ITALY
2	LUKENDA NINA	HERCEGOVINA-ZAGREB		CRO - CROATIA
3	RAJIĆ DUNJA	KARATE KLUB ZADRUGAR		SRB - SERBIA
3	PORTOGHESE MORENA	A.S.D. CHAMPION CENTER		ITA - ITALY
5	MALENKOVA YULIA	OKINAWA		UKR - UKRAINE
5	HOXHAJ ELENA	KARATE KLUB 10.DAN		CRO - CROATIA
7	RONCAGLIA GIULIA	KARATE ALTO VICENTINO		ITA - ITALY
7	JEVTOVIC DUNJA	KARATE KLUB ZANDARMERIJA		SRB - SERBIA
9	RUDALIJA ŠILA	KARATE KLUB NOVI GRAD SARAJEVO_		BIH - BOSNIA AND HERZEGOVINA

Kumite female juniors -48kg				
1	BACKOVIC HELENA	MONTENEGRO		MNE - MONTENEGRO
2	KOCKAREVIC LANA	KARATE KLUB IPON ZAGREB		CRO - CROATIA
3	VITALI VERONICA	FORZA E COSTANZA - BRESCIA		ITA - ITALY
3	BOSSI ALESSANDRA	SKORPION KARATE ASD		ITA - ITALY
5	BATH SOFIA	SPORTSKARATE.DK		DEN - DENMARK
5	PETRESKA MARTINA	ЧОЛЕ - ОХРИД		MKD - NORTH MACEDONIA
7	PERINA CAMILLA	MASTER RAPID SKF CBL		ITA - ITALY
7	DAMATO ALICE	ASD FITNESS CLUB NUOVA FLORIDA		ITA - ITALY

31ST KARATE GRAND PRIX CROATIA - 2023-01-20

Official Results

Kumite female juniors -53kg				
1	PETAN ELA	KLUB BORILNIH VEŠČIN FIGHT CLUB SHONY		SLO - SLOVENIA
2	TSANEVA TEODORA	KARATE CLUB TSANEV		BUL - BULGARIA
3	MAJSEC ISKRA	KK SAMOBOR		CRO - CROATIA
3	VAJDA MAGDALENA	KARATE KLUB IPON ZAGREB		CRO - CROATIA
5	SELIVERSTOVA DARIA	LEADER TEAM		UKR - UKRAINE
5	KYRYCHENKO KATERYNA	SHOGUN SPORTS CORPORATION - KYIV		UKR - UKRAINE
7	МИШОВСКА МИХАЕЛА	ОЛИМПИК СПОРТ 2007 - СКОПЈЕ		MKD - NORTH MACEDONIA
7	BIFULCO ASIA	A.S.D. CHAMPION CENTER		ITA - ITALY
9	IVANČIĆ DOROTEA	HERCEGOVINA-ZAGREB		CRO - CROATIA

Kumite female juniors -59kg				
1	MICOVSKA JOVANA	МАКPETROL MKD		MKD - NORTH MACEDONIA
2	FILIPOV NEVENA	KK MLADOST NOVO MILOSEVO		SRB - SERBIA
3	ŠNAJDER DARJA	K.K. SOKOL		CRO - CROATIA
3	BARANOVA YLIANA	OKINAWA		UKR - UKRAINE
5	MARTURANO IRENE	ITALIAN NATIONAL TEAM		ITA - ITALY
5	STOIMENOVA VENETA	KARATE CLUB TSANEV		BUL - BULGARIA
7	KOCKAREVIĆ EMANUELA	KARATE KLUB MAX IVANKOVO		CRO - CROATIA
7	LUPTAKOVÁ NATÁLIA LEA	SLOVAK NATIONAL TEAM		SVK - SLOVAKIA
9	POLÓNYOVÁ BIANKA	SLOVAK NATIONAL TEAM		SVK - SLOVAKIA
9	CAPITANIO MATILDE	KARATE TRENTO ASD		ITA - ITALY

Kumite female Juniors -66kg				
1	VÁCZY ANNA	SLOVAK NATIONAL TEAM		SVK - SLOVAKIA
2	DESIDERIO ANNAPIA	ITALIAN NATIONAL TEAM		ITA - ITALY
3	ČACKO MIA	KARATE KLUB 10.DAN		CRO - CROATIA
3	MANDIĆ MARIJA	KARATE KLUB ZRINSKI		CRO - CROATIA
5	DALLE FUSINE MARIA CARLOTTA	A.S.D CENTRO SPORT		ITA - ITALY
5	GULIJA LEONA.	GLOBUS ČAKOVEC		CRO - CROATIA
7	SIPOVIC AJLA	KK IPPON SARAJEVO		BIH - BOSNIA AND HERZEGOVINA
7	FILKOVIĆ EMA	KARATE KLUB VELIKA GORICA		CRO - CROATIA
9	DVORSKÁ LUCIA	ŠK CMK BANSKÁ BYSTRICA		SVK - SLOVAKIA

31ST KARATE GRAND PRIX CROATIA - 2023-01-20

Official Results

9	FICHERA CARLA	ASD SHOTOKAN ACIREALE		ITA - ITALY	
---	---------------	-----------------------	---	-------------	--

Kumite Female U21 -55kg

1	BERGANT LAURA	KARATE KLUB POLZELA		SLO - SLOVENIA	
2	SIPOVIC NEJRA	KK IPPON SARAJEVO		BIH - BOSNIA AND HERZEGOVINA	
3	NEGOVANOVIĆ BRANKICA	KARATE KLUB ŠAMPIONI - BANJA KOVILJACA		SRB - SERBIA	
3	LOVRIĆ MIRTA	KARATE KLUB IPON ZAGREB		CRO - CROATIA	
5	REZIĆ DORA	KARATE KLUB ZRINSKI		CRO - CROATIA	
5	ŠTIVIĆ EMA	KARATE KLUB SPORTSLIFE ZG		CRO - CROATIA	
7	BILANOVIĆ ADNA	BILANOVIĆ		BIH - BOSNIA AND HERZEGOVINA	
7	MIRCHEVA VERZHINIQ	K.K. LEVSKI SPARTAK		BUL - BULGARIA	

Kumite Female U21 + 68kg

1	ŽIBRET ZALA MARIA	KARATE KLUB LJUBLJANA		SLO - SLOVENIA	
2	GOLOMBOŠ NIKOLINA	KARATE KLUB TIGAR SISAK		CRO - CROATIA	
3	DI BARI GEMMA	PRO-TEAM ASD		ITA - ITALY	
3	RAVLIĆ ANAMARIJA	KARATE KLUB SAKURA ZAGREB		CRO - CROATIA	
5	DAHALIĆ AZRA	KLUB BORILAČKIH SPORTOVA TUZLA		BIH - BOSNIA AND HERZEGOVINA	
5	LEIDI MARTINA	ITALIAN NATIONAL TEAM		ITA - ITALY	
7	PAVLOVIĆ DOMINA	KARATE KLUB ZANSHIN, SPLIT		CRO - CROATIA	

Kumite Female U21 - 61kg

1	DEBELJAK HANA	KARATE KLUB LJUBLJANA		SLO - SLOVENIA	
2	SIPOVIC EMINA	KK IPPON SARAJEVO		BIH - BOSNIA AND HERZEGOVINA	
3	JOVANOVSKA VIKTORIJA	MAKPETROL MKD		MKD - NORTH MACEDONIA	
3	АЛИУ РУДИНА	ЦВЕТАН ДИМОВ - СКОПЈЕ		MKD - NORTH MACEDONIA	
5	KURTEŠ MARINA	KARATE KLUB SLAVIJA		BIH - BOSNIA AND HERZEGOVINA	
5	DESTE FEDERICA	ASD KARATE 2001		ITA - ITALY	
7	LISAC LAURA	K.K. SOKOL		CRO - CROATIA	
7	CECERE MARIKA	A.T. KARATE CLUB ROMA		ITA - ITALY	

Kumite Female U21 - 68kg

1	ZORKO MIA GRETA	KARATE KLUB STIJENA		CRO - CROATIA	
2	MOLNAR ELIZABETA	KARATE KLUB LJUBLJANA		SLO - SLOVENIA	
3	KRIVDOVÁ SARA	SLOVAK NATIONAL TEAM		SVK - SLOVAKIA	

31ST KARATE GRAND PRIX CROATIA - 2023-01-20

Official Results

3	JURIČIĆ EMA	HERCEGOVINA-ZAGREB		CRO - CROATIA	
5	ROSS ADRIANA	K.K. SOKOL		CRO - CROATIA	
5	SIMONINI VALENTINA	FORZA E COSTANZA - BRESCIA		ITA - ITALY	
7	GUŠO DŽEJLAN	KARATE KLUB ZANSHIN SARAJEVO		BIH - BOSNIA AND HERZEGOVINA	
7	GUISCARDI SHARON	BODYMIND KARATE		ITA - ITALY	

Kumite Female U21 -50kg

1	SGARDELLI EMA	KARATE KLUB CHAMPION RIJEKA		CRO - CROATIA	
2	VITALI VERONICA	FORZA E COSTANZA - BRESCIA		ITA - ITALY	
3	ILINA KSENIIA	CHAMPION KARATE CLUB		UKR - UKRAINE	
3	MRÁZOVÁ LUCIA	SLOVAK NATIONAL TEAM		SVK - SLOVAKIA	
5	MAGAJNA MAŠA	KARATE KLUB MAWASHI POSTOJNA		SLO - SLOVENIA	
5	MARCHENKO POLINA	TIGER TEAM		UKR - UKRAINE	
7	WEISMANN LARA	KARATE KLUB BREGANA		CRO - CROATIA	
7	BENAROCHE MAYA	S.I.K		ISR - ISRAEL	

KUMITE GIRLS 11-12 YEARS +54KG

1	BRKOVIC BERINA	KARATE KLUB WINNER TUZLA		BIH - BOSNIA AND HERZEGOVINA	
2	TERZIĆ INES	K.K. OMLADINAC		MNE - MONTENEGRO	
3	BALLARIN GINEVRA	SSD POLISPORTIVA TERRAGLIO		ITA - ITALY	
3	BALIĆ BERINA	KARATE KLUB RESPECT		BIH - BOSNIA AND HERZEGOVINA	
5	DUJMOVIĆ KLARA	KARATE KLUB NEVERA		CRO - CROATIA	
5	SHEPTIY POLINA	KARATE TEAM CONCORDIA		UKR - UKRAINE	

KUMITE GIRLS 11-12 YEARS -34KG

1	ŠCURIĆ LUCIJA	KK LOTOS ZAGREB		CRO - CROATIA	
2	BILANOVIĆ UMIHANA	BILANOVIĆ		BIH - BOSNIA AND HERZEGOVINA	
3	MARJANOVIĆ ANA	OKIT VODICE		CRO - CROATIA	
3	MARIĆ ANJA	KK LOTOS ZAGREB		CRO - CROATIA	
5	MIRCHEVA IVAILA	K.K. LEVSKI SPARTAK		BUL - BULGARIA	
5	GOUY LOUISON	TEAM OSCENDA KARATÉ		FRA - FRANCE	
7	EGRETIER EMMA	TEAM OSCENDA KARATÉ		FRA - FRANCE	
7	VERONESE MATILDA	CLUB ARTI ORIENTALI CANTU ASD		ITA - ITALY	

KUMITE GIRLS 11-12 YEARS -39KG

1	IVANČIĆ KIARA	SHOTOKAN KARATE KLUB OPLOTNICA		SLO - SLOVENIA	
---	---------------	--------------------------------	---	----------------	--

31ST KARATE GRAND PRIX CROATIA - 2023-01-20

Official Results

2	JEVŠENAK ALINA	SHOTOKAN KARATE KLUB OPLOTNICA		SLO - SLOVENIA	
3	JELČIĆ ROZA	KARATE KLUB TIGAR SISAK		CRO - CROATIA	
3	JERKIN FRANKA	KARATE KLUB CENTAR		CRO - CROATIA	
5	SOTNIKOVA IVANKA	TIGER TEAM		UKR - UKRAINE	
5	BRKANIC AMNA	KARATE AKADEMIJA - ARNELA ODŽAKOVIĆ		BIH - BOSNIA AND HERZEGOVINA	
7	ORLOVA VLADYSLAVA	ALPHA SPORT KARATE CLUB		UKR - UKRAINE	
7	SKITARELIĆ GABI	TAD RIJEKA		CRO - CROATIA	
9	MADUNA IVANA	HERCEGOVINA-ZAGREB		CRO - CROATIA	
9	HEREHOVA DARIJA	ALPHA SPORT KARATE CLUB		UKR - UKRAINE	

KUMITE GIRLS 11-12 YEARS -44KG

1	ŠEVČIKOVÁ NATÁLIA	SLOVAK NATIONAL TEAM		SVK - SLOVAKIA	
2	STELLA FEDERICA	PRO-TEAM ASD		ITA - ITALY	
3	ORLOVA VLADYSLAVA	ALPHA SPORT KARATE CLUB		UKR - UKRAINE	
3	ZAMBERLAN EMMA	ASD KARATE TEAM 1999		ITA - ITALY	
5	KADIĆ NOLA	KK LOTOS ZAGREB		CRO - CROATIA	
5	MURASHKINA VARVARA	LEON KARATE CLUB		UKR - UKRAINE	

KUMITE GIRLS 11-12 YEARS -49KG

1	OMANOVIĆ LAMIJA	KK MASTER BUGOJNO		BIH - BOSNIA AND HERZEGOVINA	
2	IANACHI ČOPIĆ ELIN	OKIT VODICE		CRO - CROATIA	
3	NIKOLOVA MILA	KIZAME		MKD - NORTH MACEDONIA	
3	DVORSKI MIA	KARATE KLUB KTC KRIZEVCI		CRO - CROATIA	
5	PEJNOVIĆ ALESSIA	KARATE KLUB CHAMPION RIJEKA		CRO - CROATIA	
5	REDŽIĆ ELA	KK OPATIJA		CRO - CROATIA	
7	SABLJAK MATEA	KARATE KLUB NEVERA		CRO - CROATIA	

KUMITE GIRLS 11-12 YEARS -54KG

1	PERGALIA AGATHI AGAPI	ATHLITIKOS SYLLOGOS AMAROUSIOU		GRE - GREECE	
2	PERGALIA ANASTASIA EIRINI	ATHLITIKOS SYLLOGOS AMAROUSIOU		GRE - GREECE	
3	JELENKO NINA	SHOTOKAN KARATE KLUB OPLOTNICA		SLO - SLOVENIA	
3	HADŽIĆ AZRA	KARATE KLUB KUMITE		BIH - BOSNIA AND HERZEGOVINA	
5	KIŠ LANA	KARATE KLUB TIGAR SISAK		CRO - CROATIA	
5	VURUŠIĆ TENA	GLOBUS ČAKOVEC		CRO - CROATIA	

31ST KARATE GRAND PRIX CROATIA - 2023-01-20

Official Results

KUMITE GIRLS 13-14 YEARS +64KG				
1	BANOVIĆ JANJA	K.K. OMLADINAC		MNE - MONTENEGRO
2	JANŽEKOVIĆ NUŠA	KARATE SEKCIJA TVD PARTIZAN LJUTOMER		SLO - SLOVENIA
3	SOFTIĆ AJNA	KARATE KLUB RAŠID BUĆA		BIH - BOSNIA AND HERZEGOVINA
3	BARUKČIĆ ANA MARIE	KARATE KLUB TIGAR SISAK		CRO - CROATIA
5	LEDIĆ IRMA	HERCEGOVINA- ZAGREB		CRO - CROATIA
5	STEFANCHUK SOFIIA	CHAMPION KARATE CLUB		UKR - UKRAINE
7	VOLPATO NICOL	SSD POLISPORTIVA TERRAGLIO		ITA - ITALY
7	FEROLA GIORGIA	PRO-TEAM ASD		ITA - ITALY

KUMITE GIRLS 13-14 YEARS -44KG				
1	BULIĆ STELA	KARATE KLUB CROHERC		CRO - CROATIA
2	DATSIUK MARIIA	CHAMPION KARATE CLUB		UKR - UKRAINE
3	STELLA FEDERICA	PRO-TEAM ASD		ITA - ITALY
3	KOTENKO VIERONIKA	CHAMPION KARATE CLUB		UKR - UKRAINE
5	MLAKAR NIKA	KARATE KLUB KOLEKTOR IDRJA		SLO - SLOVENIA
5	IVANČIĆ KIARA	SHOTOKAN KARATE KLUB OPLONICA		SLO - SLOVENIA
7	JERKIN FRANKA	KARATE KLUB CENTAR		CRO - CROATIA
9	LUČIĆ LORENA	KK SAMOBOR		CRO - CROATIA

KUMITE GIRLS 13-14 YEARS -49KG				
1	PANIĆ PAULA	KARATE KLUB IPON ZAGREB		CRO - CROATIA
2	RESHETNIKOVA ALISA	KARATE TEAM CONCORDIA		UKR - UKRAINE
3	BRLETIĆ ELENA	KARATE KLUB PULA		CRO - CROATIA
3	MARIĆ IVA	HERCEGOVINA- ZAGREB		CRO - CROATIA
5	JURJEVIĆ ALISA EMA	KARATE KLUB BREGANA		CRO - CROATIA
5	BILAĆ LAURA	KARATE KLUB HRVATSKI DRAGOVOLJAC		CRO - CROATIA
7	PAVIČIĆ ESTHER	SLAVKO KRIVSKI TERMAL DARUVAR		CRO - CROATIA
7	BERTOLDO MONICA	SSD POLISPORTIVA TERRAGLIO		ITA - ITALY

KUMITE GIRLS 13-14 YEARS -54KG				
1	PERGALIA ANASTASIA EIRINI	ATHLITIKOS SYLLOGOS AMAROUSIOU		GRE - GREECE
2	RADIĆ LORENA	KARATE KLUB IPON ZAGREB		CRO - CROATIA

31ST KARATE GRAND PRIX CROATIA - 2023-01-20

Official Results

3	KRVINA LIA	KARATE KLUB KOLEKTOR IDRIJA		SLO - SLOVENIA	
3	JUKIĆ TARA	OKIT VODICE		CRO - CROATIA	
5	RAUTER HANNAH VELA	KARATE SEKCIJA TVD PARTIZAN LJUTOMER		SLO - SLOVENIA	
5	JELENKO NINA	SHOTOKAN KARATE KLUB OPLOTNICA		SLO - SLOVENIA	
7	MARKOVIĆ NICOLE	KARATE KLUB BUSHIDO, ZAGREB		CRO - CROATIA	
7	HASANOVIĆ ALISA	KARATE KLUB RAŠID BUČA		BIH - BOSNIA AND HERZEGOVINA	

KUMITE GIRLS 13-14 YEARS -59KG

1	ASCIC SEJLA	KARATE KLUB DO TUZLA		BIH - BOSNIA AND HERZEGOVINA	
2	BATH HANNAH	SPORTSKARATE.DK		DEN - DENMARK	
3	KARLOVIĆ NOELI	KARATE KLUB KASTAV		CRO - CROATIA	
3	ŠIMUNDIĆ NIKA	KARATE KLUB KASTAV		CRO - CROATIA	
5	BUBALO NAHLA	KARATE AKADEMIJA - ARNELA ODŽAKOVIĆ		BIH - BOSNIA AND HERZEGOVINA	
5	AHAPIIEVA DARIA	TIGER TEAM		UKR - UKRAINE	
7	GEORGIEVA IVETA	RONIN11 SOFIA		BUL - BULGARIA	
7	MOCCIA MIRIAM	PRO-TEAM ASD		ITA - ITALY	

KUMITE GIRLS 13-14 YEARS -64KG

1	FILIPOVIĆ MARTA	HERCEGOVINA- ZAGREB		CRO - CROATIA	
2	CORREDDU NICOLE	WORLD WELLNESS KARATE SORSO		ITA - ITALY	
3	TAHIROVA MARIIA	TIGER TEAM		UKR - UKRAINE	
3	SAHINOVIC MEDINA	BILANOVIĆ		BIH - BOSNIA AND HERZEGOVINA	
5	MIZRAHI YAARA	JKS ISRAEL		ISR - ISRAEL	
7	BRAČUN MAŠERA IRIS	KARATE KLUB SOKOL, LJUBLJANA		SLO - SLOVENIA	

KUMITE GIRLS 7-8 YEARS -24kg

1	OGREBIĆ TENA	KARATE AKADEMIJA OSIJEK KAO		CRO - CROATIA	
---	--------------	--------------------------------	---	---------------	--

KUMITE GIRLS 9-10 YEARS -27kg

1	SGARDELLI LJATIFI ELLA	KARATE KLUB CHAMPION RIJEKA		CRO - CROATIA	
2	SOKOLNIKOVA ALISA	ALPHA SPORT KARATE CLUB		UKR - UKRAINE	
3	VRBAN MAŠA	HERCEGOVINA- ZAGREB		CRO - CROATIA	
3	MURASHKINA MARHARYTA	LEON KARATE CLUB		UKR - UKRAINE	
5	AZINOVIĆ RUŽA	KARATE KLUB NOVI ZAGREB		CRO - CROATIA	
5	ŽUGAJ SARA	KARATE KLUB KOSTRENA		CRO - CROATIA	

31ST KARATE GRAND PRIX CROATIA - 2023-01-20

Official Results

KUMITE GIRLS 9-10 YEARS -31kg				
1	MARIĆ ANJA	KK LOTOS ZAGREB		CRO - CROATIA
2	MOHLER KATJA	KARATE KLUB NOVI ZAGREB		CRO - CROATIA
3	LOZO MILLA VITA	KARATE KLUB KOSTRENA		CRO - CROATIA
3	PRANJIĆ VITA	KARATE KLUB KOSTRENA		CRO - CROATIA
5	GAVRAN LARA	KARATE KLUB CHAMPION RIJEKA		CRO - CROATIA
5	OANCEA RALUCA	ASD_DINAMO_KARATE		ITA - ITALY

KUMITE GIRLS 9-10 YEARS -35kg				
1	SOTNIKOVA IVANKA	TIGER TEAM		UKR - UKRAINE
2	JAILLARD NELL	TEAM OSCENDA KARATÉ		FRA - FRANCE
3	KLARIN LILI	OKIT VODICE		CRO - CROATIA
3	ŠESTAK DALIA	GLOBUS ČAKOVEC		CRO - CROATIA
5	CLAUDIA RÁCZ	CRİȘUL SPORT CLUB ORADEAA		ROU - ROMANIA

KUMITE GIRLS 9-10 YEARS -39kg				
1	HEREHOVA DARIIA	ALPHA SPORT KARATE CLUB		UKR - UKRAINE
2	BALOG TESA	GLOBUS ČAKOVEC		CRO - CROATIA
3	PUSHKOVA MARIIA	KATANA		UKR - UKRAINE
3	FERČIĆ LUCIJA	KARATE KLUB TIGAR SISAK		CRO - CROATIA
5	CVETKOVIĆ MEIER AMELIA VICTORIA	ZAMET		CRO - CROATIA

Kumite male cadets +70kg				
1	BOHUNICKÝ LUKÁŠ	SLOVAK NATIONAL TEAM		SVK - SLOVAKIA
2	VRANKOVIĆ MARIO	KARATE KLUB CHAMPION RIJEKA		CRO - CROATIA
3	BURROSI SAMUELE	ITALIAN NATIONAL TEAM		ITA - ITALY
3	GOJAKOVIC MIHAILO	MONTENEGRO		MNE - MONTENEGRO
5	NONIS MATTEO	EVOLUTION TEAM KARATE		ITA - ITALY
5	TOMA GESON	TEAM KARATE PULEO FIRENZE		ITA - ITALY
7	GIBANICA ERMIN	KARATE KLUB ZANSHIN SARAJEVO		BIH - BOSNIA AND HERZEGOVINA
7	VUKOJA LOVRO	HERCEGOVINA-ZAGREB		CRO - CROATIA
9	TURKOVIĆ VITO	KARATE KLUB TINJAN		CRO - CROATIA
9	SETIC TARIK	MAWASHI SARAJEVO		BIH - BOSNIA AND HERZEGOVINA

Kumite male cadets -52kg				
1	STETSIV MAKSYM	UNION TEAM		UKR - UKRAINE
2	SALJIU JUSUF	MONTENEGRO		MNE - MONTENEGRO

31ST KARATE GRAND PRIX CROATIA - 2023-01-20

Official Results

3	ΜΩΠΑΪΤΗΣ ΑΓΓΕΛΟΣ	ΑΣΑ ΣΟΤΟΚΑΝ ΚΑΡΑΤΕ		GRE - GREECE	
3	SUKHANOV ROMAN	KATANA		UKR - UKRAINE	
5	MASLOV LOVRO	KARATE KLUB IPON ZAGREB		CRO - CROATIA	
5	RUZSINSZKI BALÁZS	SZARVAS		HUN - HUNGARY	
7	CHRENKO JÁN	ŠK CMK BANSKÁ BYSTRICA		SVK - SLOVAKIA	
7	LIGAS EDOARDO	ASD ESERCITO - 187° FOLGORE		ITA - ITALY	
9	FOSCHI SEBASTIAN	A.S.D. JOHNNYS KARATE BORGO SISA		ITA - ITALY	
9	DAN CHRISTIAN	CENTRO KARATE RIMINI		ITA - ITALY	

Kumite male cadets -57kg

1	PRANNYCHUK NAZARII	LEADER TEAM		UKR - UKRAINE	
2	HRYNENKO ILLIA	TIGER TEAM		UKR - UKRAINE	
3	MIHAYLOV PETAR	RONIN11 SOFIA		BUL - BULGARIA	
3	STOJCHEVSKI ANDREJ	KI3AME		MKD - NORTH MACEDONIA	
5	JURIČIĆ DANE	KARATE KLUB CROHERC		CRO - CROATIA	
5	PERVAN ZELJKO	KARATE KLUB CROHERC		CRO - CROATIA	
7	DE STEFANO EMANUELE	A.S.D. SHIZOKU KARATE AVELLINO		ITA - ITALY	
7	ŠOŠKIĆ FILIP	MONTENEGRO		MNE - MONTENEGRO	
9	ANDRADE SILVESTRI AIRTON	MASTER RAPID SKF CBL		ITA - ITALY	
9	JELEKOVIĆ MAURO	KARATE KLUB CROATIA		CRO - CROATIA	

Kumite male cadets -63kg

1	DJURICIC NENAD	MONTENEGRO		MNE - MONTENEGRO	
2	VUČINIĆ VUK	KARATE KLUB ISKRA		MNE - MONTENEGRO	
3	POŽEGA LUKA	KARATE KLUB MAX IVANKOVO		CRO - CROATIA	
3	PANICO VALENTINO	ITALIAN NATIONAL TEAM		ITA - ITALY	
5	KARAMUSTAFIĆ FARUK	SAMURAJ		BIH - BOSNIA AND HERZEGOVINA	
5	KOSHKIDKO EDUARD	TIGER TEAM		UKR - UKRAINE	
7	ŠOLTIĆ ERVIN	GLOBUS ČAKOVEC		CRO - CROATIA	
7	SHYKHALI YUSIFOV	MOWGLY KARATE CLUB		UKR - UKRAINE	
9	ROLA LUKA	KARATE KLUB KOVINAR MARIBOR		SLO - SLOVENIA	
9	KOZAK KOSTIANTYN	LEADER TEAM		UKR - UKRAINE	
11	KALTAK ALEN	BILANOVIĆ		BIH - BOSNIA AND HERZEGOVINA	

Kumite male cadets -70kg

1	TONIOLO ALVISE	ITALIAN NATIONAL TEAM		ITA - ITALY	
2	STRAHIJA SVEN	GLOBUS ČAKOVEC		CRO - CROATIA	

31ST KARATE GRAND PRIX CROATIA - 2023-01-20

Official Results

3	SMAJIC HARUN	KARATE KLUB SAMBON - VOGOSCA		BIH - BOSNIA AND HERZEGOVINA	
3	ARIFAJ ANES	MONTENEGRO		MNE - MONTENEGRO	
5	SESTO ANDREA	CLUB ARTI ORIENTALI CANTU ASD		ITA - ITALY	
5	TENZHALA IVAN	ALPHA SPORT KARATE CLUB		UKR - UKRAINE	
7	FERRARINI FRANCESCO	ASD JUDO KARATE CLUB		ITA - ITALY	
7	MLAKAR LUKA	KARATE KLUB KOLEKTOR IDRIJA		SLO - SLOVENIA	
9	MOSCA FILIPPO	ASD IPPON 2		ITA - ITALY	

Kumite male juniors +76kg

1	FAJERBACH MAX	HERZEGOVINA- ZAGREB		CRO - CROATIA	
2	KRŽIŠNIK GAL	KARATE KLUB LJUBLJANA		SLO - SLOVENIA	
3	ΜΩΠΑΪΤΗΣ ΝΙΚΟΛΑΟΣ	ΑΣΑ ΣΟΤΟΚΑΝ ΚΑΡΑΤΕ		GRE - GREECE	
3	ČUTURA TONI	KARATE KLUB HRVATSKI DRAGOVOLJAC		CRO - CROATIA	
5	GONDI NIKOLA	KK VIROVITICA		CRO - CROATIA	
5	JOVANOVIĆ LUKA	KARATE KLUB ŠAMPION		BIH - BOSNIA AND HERZEGOVINA	
7	SUPINO FEDERICO	SSD BRACELLI CLUB		ITA - ITALY	
7	MARINO FERNANDO	ITALIAN NATIONAL TEAM		ITA - ITALY	
9	BOZOVIC DANILO	MAKPETROL MKD		MKD - NORTH MACEDONIA	

Kumite male juniors -55kg

1	VOJINOVIC BALS	MONTENEGRO		MNE - MONTENEGRO	
2	CAPMOALE ALEXANDR	BARS BALTI WKF		MDA - MOLDOVA, REPUBLIC OF	
3	DJURDJIC MARKO	KARATE KLUB BORAC 021		SRB - SERBIA	
3	SQUILLANTE GIUDO	ITALIAN NATIONAL TEAM		ITA - ITALY	
5	GRINBERG DAVID	AZKOKAI MAKABI BAT-YAM		ISR - ISRAEL	
5	DRAŽENOVIĆ DAMIAN	KARATE KLUB IPON ZAGREB		CRO - CROATIA	
7	IVANOV VELIN	K.K. LEVSKI SPARTAK		BUL - BULGARIA	
7	DE STEFANO EMANUELE	A.S.D. SHIZOKU KARATE AVELLINO		ITA - ITALY	
9	PIEMONTE GABRIEL	KARATE NAKAYAMA		ITA - ITALY	
9	GIACOBBE GIULIO	ASD IPPON 2		ITA - ITALY	

Kumite male juniors -61kg

1	БЕЛИСТОЈАНОСКИ МАТЕЈ	ОЛИМПИК СПОРТ 2007 - СКОПЈЕ		MKD - NORTH MACEDONIA	
2	PANCHUK ARTEM	TIGER TEAM		UKR - UKRAINE	
3	NASTESKI MATIJA	KARATE KLUB NOVI ZAGREB		CRO - CROATIA	

31ST KARATE GRAND PRIX CROATIA - 2023-01-20

Official Results

3	BUKOVIČ NORBERT	SLOVAK NATIONAL TEAM		SVK - SLOVAKIA	
5	BJELAJAC OGNJEN	MONTENEGRO		MNE - MONTENEGRO	
5	RUFINI SAMUELE	TEAM KARATE PULEO FIRENZE		ITA - ITALY	
7	KOLODIEZNYI DANYLO	KARATE TEAM CONCORDIA		UKR - UKRAINE	
7	GIORDANO FABRIZIO	ITALIAN NATIONAL TEAM		ITA - ITALY	
9	ZARIČ VID	KARATE KLUB KOVINAR MARIBOR		SLO - SLOVENIA	
9	MALČEC CHRIS	KK VIROVITICA		CRO - CROATIA	

Kumite male juniors -68kg

1	DANILOVIĆ ANDRIJA	MONTENEGRO		MNE - MONTENEGRO	
2	PITSUL HEORHII	ALPHA SPORT KARATE CLUB		UKR - UKRAINE	
3	CALIFANO PIETRO PIO	ITALIAN NATIONAL TEAM		ITA - ITALY	
3	ŽIBREČ BOR	KARATE KLUB LJUBLJANA		SLO - SLOVENIA	
5	PALJEVAČ SINAN	KARATE KLUB SAMPIONI		BIH - BOSNIA AND HERZEGOVINA	
5	KOVAČ SIMON	ŠK CMK BANSKA BYSTRICA		SVK - SLOVAKIA	
7	ZRNIČ MIHAJLO	KARATE KLUB ENERGIJA		BIH - BOSNIA AND HERZEGOVINA	
7	SEREDA YEVGENIY	SENBIN KARATE CLUB		UKR - UKRAINE	
9	RUSHITII REXHEP	KUSHTRIMI		MKD - NORTH MACEDONIA	
9	STANČIĆ ADRIAN	KARATE KLUB KLENOVNIK		CRO - CROATIA	

Kumite male juniors -76kg

1	IANNUZZI MARIO	A.S.D. SHIZOKU KARATE AVELLINO		ITA - ITALY	
2	LOZANOVSKI DIMITAR	MAKPETROL MKD		MKD - NORTH MACEDONIA	
3	MILETA TOMA	KARATE KLUB ŠIBENIK 1066		CRO - CROATIA	
3	SALJIU EMRE	MONTENEGRO		MNE - MONTENEGRO	
5	SINANOVIĆ FARIS	KLUB BORILAČKIH SPORTOVA TUZLA		BIH - BOSNIA AND HERZEGOVINA	
5	BOZZI ANDREA	ASD ESERCITO - 187° FOLGORE		ITA - ITALY	
7	BOŽIČ CENE	KARATE KLUB KOLEKTOR IDRIJA		SLO - SLOVENIA	
7	SUSA ZIGA	KARATE KLUB ZALEC		SLO - SLOVENIA	
9	CRNOGAJ TEO	MLADOST		CRO - CROATIA	
9	NEDIĆ LEON	KARATE KLUB NOVI ZAGREB		CRO - CROATIA	

Kumite male Seniors Open Final

1	KVESIĆ ANĐELO	HERCEGOVINA-ZAGREB		CRO - CROATIA	
2	GARIBOVIĆ ENES	KARATE KLUB VARAŽDIN		CRO - CROATIA	

31ST KARATE GRAND PRIX CROATIA - 2023-01-20

Official Results

3	LJUBISA MARIC	KARATE KLUB ZANDARMERIJA		SRB - SERBIA	
4	BUNJEVAC JAKOV	KARATE KLUB KAPTOL ZAGREB		CRO - CROATIA	

Kumite Male U21 +84kg

1	KRESIC SANDRO	KARATE KLUB DO TUZLA		BIH - BOSNIA AND HERZEGOVINA	
2	STOJANOVIC STEFAN	MAKPETROL MKD		MKD - NORTH MACEDONIA	
3	JOVOVIC NEMANJA	MONTENEGRO		MNE - MONTENEGRO	
3	MARKULJEVIĆ UROŠ	KARATE KLUB TRBOVLJE		SLO - SLOVENIA	
5	BAGAEV MALIK	SLOVAK NATIONAL TEAM		SVK - SLOVAKIA	
5	GLUHINIĆ DARIO	KARATE KLUB STIJENA		CRO - CROATIA	
7	KATANEC JAN	KK SAMOBOR		CRO - CROATIA	
7	KVESIĆ LUKA	HERCEGOVINA-ZAGREB		CRO - CROATIA	

Kumite Male U21 -60kg

1	DUJAKOVIĆ PAVLE	KARATE KLUB ENERGIJA		BIH - BOSNIA AND HERZEGOVINA	
2	БЕЛИСТОЈАНОСКИ МАТЕЈ	ОЛИМПИК СПОРТ 2007 - СКОПЈЕ		MKD - NORTH MACEDONIA	
3	KOŁODIEZNYI DANYLO	KARATE TEAM CONCORDIA		UKR - UKRAINE	
3	КОСТОВ БОЈАН	ОЛИМПИК СПОРТ 2007 - СКОПЈЕ		MKD - NORTH MACEDONIA	
5	SZABÓ MARCELL	KSI HUNGARY		HUN - HUNGARY	
5	RUMENJAK NOA	KARATE KLUB IPON ZAGREB		CRO - CROATIA	
7	ТОПЛИЌАНЕС КРИСТИАН	ГЛОБУС ЉАКОВЕЦ		CRO - CROATIA	
7	SPAMPINATO MARCO GAETANO	ASD REMBUKAN KARATE VILLASMUNDO		ITA - ITALY	

Kumite Male U21 -67kg

1	TVRDOŃ ANDREJ	SLOVAK NATIONAL TEAM		SVK - SLOVAKIA	
2	STOJMIROV STEFAN	BOTTONI		MKD - NORTH MACEDONIA	
3	RAMOS MATT	ITALIAN NATIONAL TEAM		ITA - ITALY	
3	MEMIŠEVIĆ KENAN	KARATE AKADEMIJA - ARNELA ODŽAKOVIĆ		BIH - BOSNIA AND HERZEGOVINA	
5	KOŠMRLJ ERIK TEO	KARATE KLUB LJUBLJANA		SLO - SLOVENIA	
5	ZRNIĆ MIHAJLO	KARATE KLUB ENERGIJA		BIH - BOSNIA AND HERZEGOVINA	
7	LORENZETTI TOMMASO	ASD TALARICO KARATE TEAM APS		ITA - ITALY	
7	DUMBOVIĆ ROKO	KARATE KLUB TIGAR SISAK		CRO - CROATIA	

Kumite Male U21 -75kg

1	JANOVČIĆ MAROŠ	SLOVAK NATIONAL TEAM		SVK - SLOVAKIA	
---	----------------	----------------------	---	----------------	--

31ST KARATE GRAND PRIX CROATIA - 2023-01-20

Official Results

2	JOVOVIĆ LAZAR	MONTENEGRO		MNE - MONTENEGRO	
3	KASIANOV DANIIL	CHAMPION KARATE CLUB		UKR - UKRAINE	
3	ORLANDIC PETAR	STUDENTSKI GRAD		SRB - SERBIA	
5	DELIĆ ALIJA	KARATE KLUB NOVI GRAD SARAJEVO		BIH - BOSNIA AND HERZEGOVINA	
5	KNIRSCH PATRIK	MTK BUDAPEST		HUN - HUNGARY	
7	IVANOVIĆ NIKOLA	KARATE KLUB DINAMO PANČEVO		SRB - SERBIA	
7	BARLOV ADIN	KARATE KLUB ZANSHIN SARAJEVO		BIH - BOSNIA AND HERZEGOVINA	
9	GORIŠEK MATEJ	KARATE KLUB LJUBLJANA		SLO - SLOVENIA	
9	STANIC BORNA	KARATE KLUB BREGANA		CRO - CROATIA	

Kumite Male U21 -84kg

1	TRAJKOVSKI VITOMIR	МАКРЕТОЛ МКД		MKD - NORTH MACEDONIA	
2	АНГЕЛОВСКИ АНДРЕЈ	ОЛИМПИК СПОРТ 2007 - СКОПЈЕ		MKD - NORTH MACEDONIA	
3	POLIAK JAKUB	SLOVAK NATIONAL TEAM		SVK - SLOVAKIA	
3	KEŠELĀK DOMINIK	SLOVAK NATIONAL TEAM		SVK - SLOVAKIA	
5	MARTIĆ ANTONIO	KARATE KLUB SPORTSLIFE ZG		CRO - CROATIA	
5	JORDAN TIMOTEJ	KARATE KLUB BUSHIDO, ROGASKA SLATINA		SLO - SLOVENIA	
7	ΤΡΑΓΑΣ ΣΩΤΗΡΙΟΣ	ΑΣΣΚ ΠΕΡΣΕΑΣ		GRE - GREECE	
7	POLIAKOV MAKSYM	OKINAWA		UKR - UKRAINE	

















































31ST KARATE GRAND PRIX CROATIA - 2023-01-20

Medals - Club

Rank	Club	1. Place	2. Place	3. Place
1	 SLOVAK NATIONAL TEAM, SVK	9	5	13
2	 HERCEGOVINA-ZAGREB, CRO	5	3	4
3	 ITALIAN NATIONAL TEAM, ITA	5	2	7
4	 MONTENEGRO, MNE	5	2	4
5	 LEADER TEAM, UKR	3	3	4
6	 KARATE KLUB LJUBLJANA, SLO	3	2	2
7	 ATHLITIKOS SYLLOGOS AMAROUSIOU, GRE	3	2	1
8	 KARATE KLUB ALFA, CRO	3	1	2
9	 TIGER TEAM, UKR	2	2	3
10	 KK LOTOS ZAGREB, CRO	2	2	1
	 MAKPETROL MKD, MKD	2	2	1
12	 KARATE KLUB SEKI, SLO	2	1	7
13	 KATANA, UKR	2	1	3
14	 SHOTOKAN KARATE KLUB OPLOTNICA, SLO	2	1	1
	 BARS BALTI WKF, MDA	2	1	1
16	 KARATE KLUB CHAMPION RIJEKA, CRO	2	1	0
17	 KARATE AKADEMIJA - ARNELA ODŽAKOVIĆ, BIH	2	0	2
18	 ASD KARATE TEAM 1999, ITA	2	0	1
	 SSD POLISPORTIVA TERRAGLIO, ITA	2	0	1
20	 KARATE AKADEMIJA OSIJEK KAO, CRO	2	0	0
	 ASD FC MOREVILLA, ITA	2	0	0
	 KARATE KLUB DO TUZLA, BIH	2	0	0
23	 KARATE TEAM CONCORDIA, UKR	1	3	2
24	 K.K. OMLADINAC, MNE	1	3	0
25	 OKIT VODICE, CRO	1	2	3
26	 KARATE KLUB IPON ZAGREB, CRO	1	2	2
27	 ALPHA SPORT KARATE CLUB, UKR	1	2	1
	 TEAM OSCENDA KARATÉ, FRA	1	2	1
	 ОЛИМПИК СПОРТ 2007 - СКОПЈЕ, MKD	1	2	1
30	 CHAMPION KARATE CLUB, UKR	1	1	6
31	 KARATE KLUB KASTAV, CRO	1	1	3
	 ASD KARATE CLUB KANAZAWA, ITA	1	1	3
33	 KARATE KLUB VEZIR, BIH	1	1	0
	 A.S.D. ACADEMIA HYDRA, ITA	1	1	0
	 UNION TEAM, UKR	1	1	0
36	 KARATE KLUB SAMBON - VOGOSCA, BIH	1	0	2
	 CLUB ARTI ORIENTALI CANTU ASD, ITA	1	0	2
38	 ŠK CMK BANSKÁ BYSTRICA, SVK	1	0	1
	 SKORPION KARATE ASD, ITA	1	0	1
	 KARATE KLUB REGENERACIJA, BIH	1	0	1
	 KARATE KLUB TRBOVLJE, SLO	1	0	1
	 KKPOTOCI, MNE	1	0	1
43	 SKIPPER, SRB	1	0	0
	 KLUB BORILNIH VEŠČIN FIGHT CLUB SHONY, SLO	1	0	0
	 G.S.FF.OO. POLIZIA DI STATO, ITA	1	0	0
	 KARATE KLUB POLZELA, SLO	1	0	0
	 KARATE KLUB STIJENA, CRO	1	0	0









































31ST KARATE GRAND PRIX CROATIA - 2023-01-20

Medals - Club

	 ZAKHYST KARATE CLUB, UKR	1	0	0
	 KARATE KLUB WINNER TUZLA, BIH	1	0	0
	 KK OKINAWA MALI BUKOVEC, CRO	1	0	0
	 KK MASTER BUGOJNO, BIH	1	0	0
	 KARATE KLUB CROHERC, CRO	1	0	0
	 ASD JUDO KARATE CLUB, ITA	1	0	0
	 KARATE ACADEMY BUSHIDO, SRB	1	0	0
	 A.S.D. SHIZOKU KARATE AVELLINO, ITA	1	0	0
	 KARATE KLUB ENERGIJA, BIH	1	0	0
57	 GLOBUS ČAKOVEC, CRO	0	3	3
58	 KARATE KLUB TIGAR SISAK, CRO	0	2	3
59	 KARATE KLUB TRNJE, CRO	0	2	2
60	 A.S.D. KARATE ROMA, ITA	0	2	0
	 KK IPPON SARAJEVO, BIH	0	2	0
	 WORLD WELLNESS KARATE SORSO, ITA	0	2	0
63	 KARATE KLUB NOVI ZAGREB, CRO	0	1	3
	 MASTER RAPID SKF CBL, ITA	0	1	3
65	 KARATE KLUB KOLEKTOR IDRIJA, SLO	0	1	2
	 PRO-TEAM ASD, ITA	0	1	2
	 KARATE KLUB VELENJE, SLO	0	1	2
	 SPORT SCHOOL KARATE BRATISLAVA, SVK	0	1	2
69	 FORZA E COSTANZA - BRESCIA, ITA	0	1	1
	 BILANOVIĆ, BIH	0	1	1
	 JAMAL SAADA SHOTOKAN KARATE, ISR	0	1	1
	 KARATE KLUB BUSHIDO, ZAGREB, CRO	0	1	1
	 KARATE KLUB SHIHAN - ZAGREB, CRO	0	1	1
	 OKINAWA, UKR	0	1	1
	 KARATE KLUB POLET ZAGREB, CRO	0	1	1
	 LZ KARATE NIEDERÖSTERREICH, AUT	0	1	1
	 KARATE KLUB RESPECT, BIH	0	1	1
78	 KARATE CLUB SHURIKEN, BUL	0	1	0
	 KK MLADOST NOVO MILOSEVO, SRB	0	1	0
	 AZKOKAI MAKABI BAT-YAM, ISR	0	1	0
	 KARATE SEKCIJA TVD PARTIZAN LJUTOMER, SLO	0	1	0
	 KARATE KLUB SPORTINGBUDO, HUN	0	1	0
	 KARATE KLUB ŠIROKI ŠIROKI BRIJEG, BIH	0	1	0
	 SPORTSKARATE.DK, DEN	0	1	0
	 KARATE KLUB ISKRA, MNE	0	1	0
	 KARATE DOJO BRAČ, CRO	0	1	0
	 TSKS BELLUNO, ITA	0	1	0
	 KARATE KLUB VARAŽDIN, CRO	0	1	0
	 KARATE CLUB TSANEV, BUL	0	1	0
	 BOTTONI, MKD	0	1	0
91	 SZARVAS, HUN	0	0	2
	 KARATE KLUB KOSTRENA, CRO	0	0	2
	 ΑΣΑ ΣΟΤΟΚΑΝ ΚΑΡΑΤΕ, GRE	0	0	2
	 KARATE KLUB HRVATSKI DRAGOVOLJAC, CRO	0	0	2
	 LEON KARATE CLUB, UKR	0	0	2

31ST KARATE GRAND PRIX CROATIA - 2023-01-20

Medals - Club

	 КИЗАМЕ, MKD	0	0	2
	 SPORT TARGET, ITA	0	0	2
	 RONIN11 SOFIA, BUL	0	0	2
	 KARATE KLUB KARLOVAC 1969, CRO	0	0	2
100	 KARATE KLUB 10.DAN, CRO	0	0	1
	 KARATE KLUB ZRINSKI, CRO	0	0	1
	 A.S.D. MABUNI CLUB CIVITAVECCHIA, ITA	0	0	1
	 KK MLADOST VITEZ, BIH	0	0	1
	 KARATE KLUB ŠAMPIONI - BANJA KOVILJACA, SRB	0	0	1
	 KARATE KLUB SHIHAN POPRAD, SVK	0	0	1
	 KARATE KLUB SAKURA ZAGREB, CRO	0	0	1
	 ЦВЕТАН ДИМОВ - СКОПЈЕ, MKD	0	0	1
	 ACCADEMIA KARATE UNION TEAM, ITA	0	0	1
	 TORNADO KARATE TEAM, SVK	0	0	1
	 ITOSU-KAI BOSATSU, DEN	0	0	1
	 BERRETTONI FEDERICO, ITA	0	0	1
	 KARATE KLUB CENTAR, CRO	0	0	1
	 KARATE KLUB VELIKA GORICA, CRO	0	0	1
	 ASD REMBUKAN KARATE VILLASMUNDO, ITA	0	0	1
	 SHINDOKAN MACCABI ISRAEL, ISR	0	0	1
	 KARATE KLUB KTC KRIZEVCI, CRO	0	0	1
	 KARATE KLUB KUMITE, BIH	0	0	1
	 KLUB BORILAČKIH SPORTOVA TUZLA, BIH	0	0	1
	 KARATE KLUB RAŠID BUČA, BIH	0	0	1
	 ŠK KARATE KACHI NITRA, SVK	0	0	1
	 KARATE KLUB PULA, CRO	0	0	1
	 KARATE KLUB ZADRUGAR, SRB	0	0	1
	 A.S.D. CHAMPION CENTER, ITA	0	0	1
	 KARATE KLUB TRAVNIK GS-TMT, BIH	0	0	1
	 SSD POLISPORTIVA TERNANA, ITA	0	0	1
	 KARATE KLUB NEVERA, CRO	0	0	1
	 KARATE KLUB MAX IVANKOVO, CRO	0	0	1
	 KARATE KLUB BORAC 021, SRB	0	0	1
	 KBES 5.11-BK BOSANSKA KRUPA, BIH	0	0	1
	 KK SAMOBOR, CRO	0	0	1
	 KARATE KLUB ŠIBENIK 1066, CRO	0	0	1
	 KSI HUNGARY, HUN	0	0	1
	 KARATE KLUB ZANDARMERIJA, SRB	0	0	1
	 KARATE KLUB PANTER, MNE	0	0	1
	 K.K. SOKOL, CRO	0	0	1
	 STUDENTSKI GRAD, SRB	0	0	1

Kumite Female U21 + 68kg

31ST KARATE GRAND PRIX CROATIA, CITY SPORTS HALL SAMOBOR, ANDRIJE HEBRANGA 26A, SAMOBOR, CROATIA, CRO

2023-01-21

Tatami
3 09:00

Pool
1/2

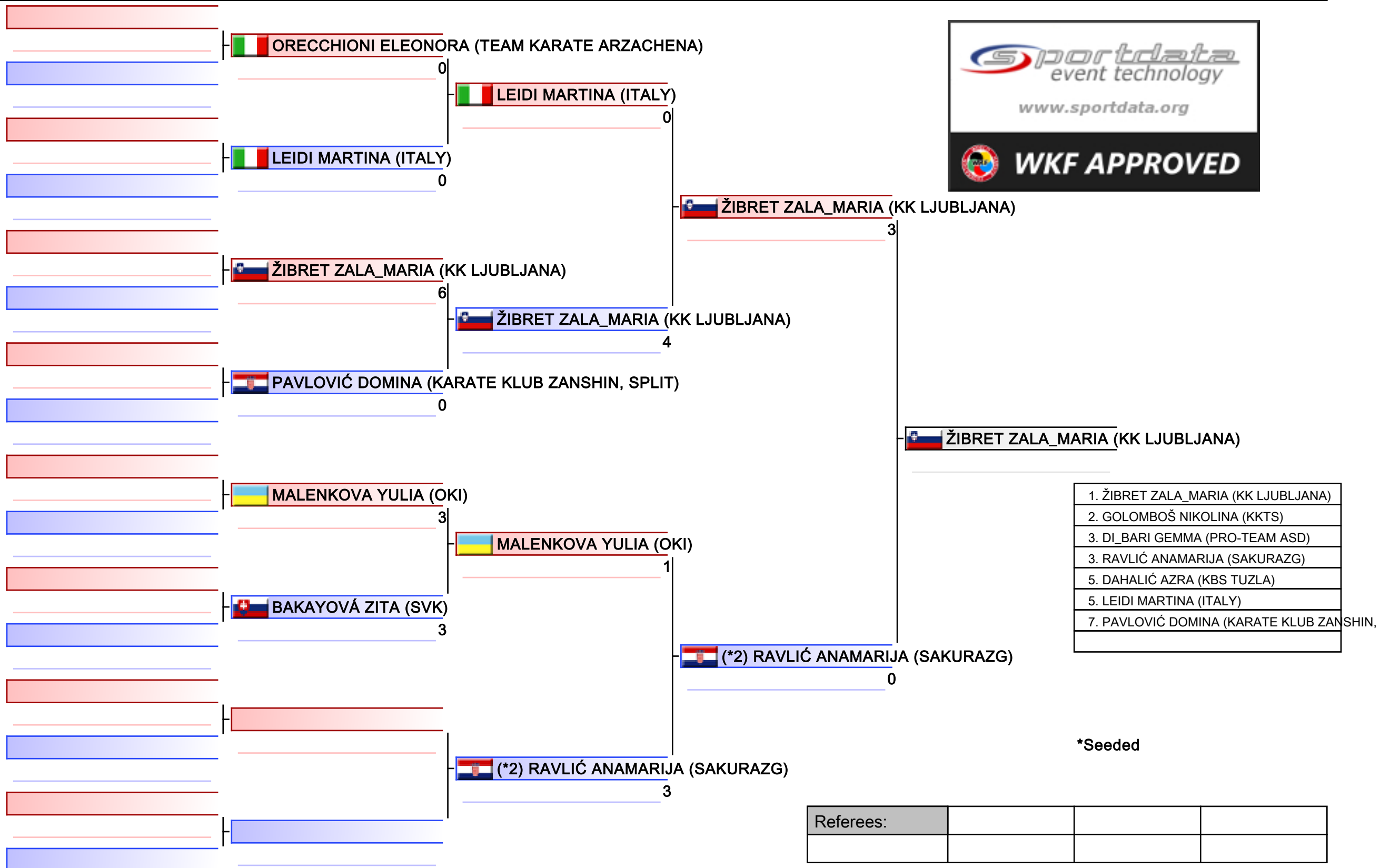

Kumite Female U21 - 61kg

31ST KARATE GRAND PRIX CROATIA, CITY SPORTS HALL SAMOBOR, ANDRIJE HEBRANGA 26A, SAMOBOR, CROATIA, CRO

2023-01-21

Tatami
5 09:00

Pool
1/2

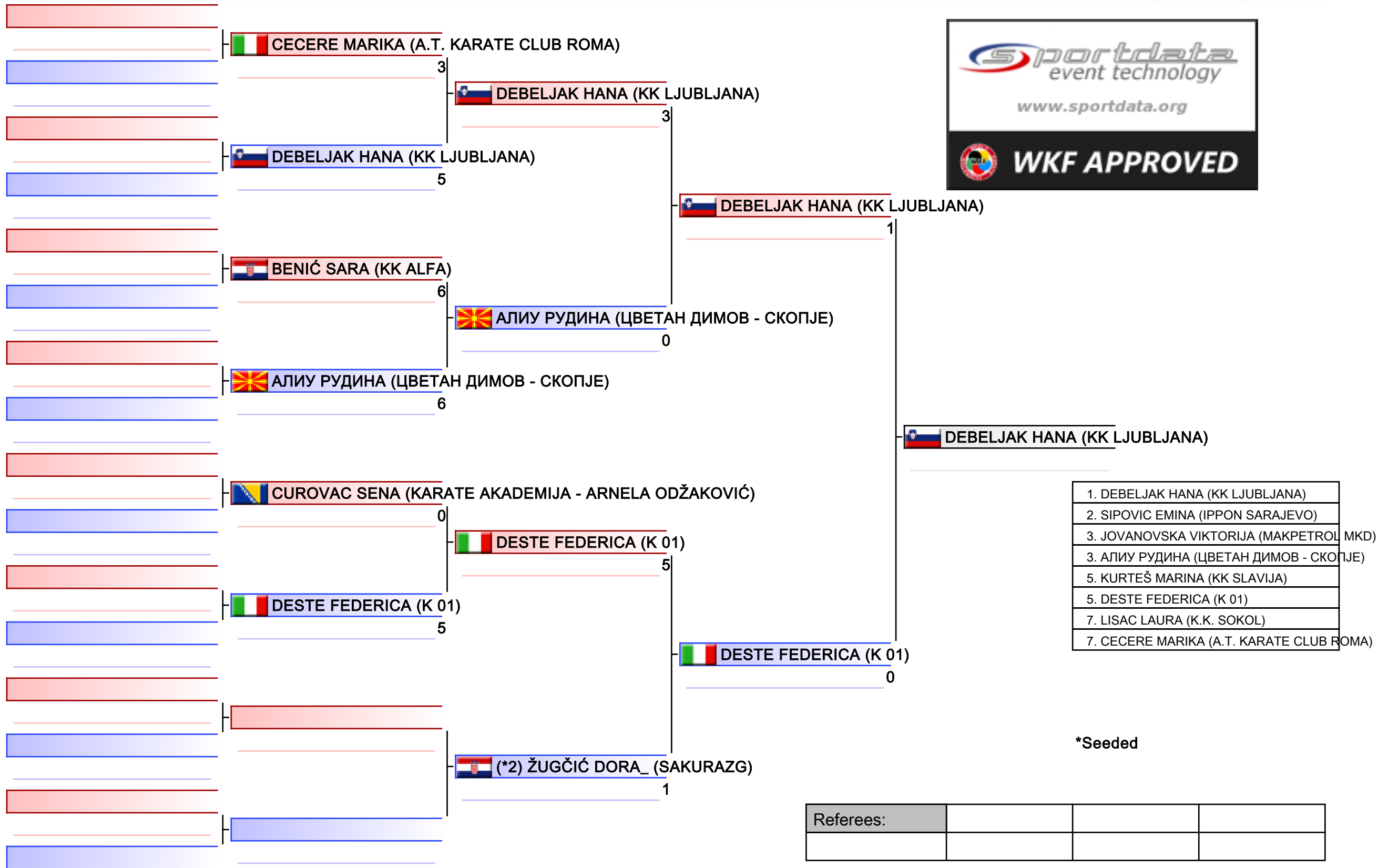

Kumite Female U21 - 68kg

31ST KARATE GRAND PRIX CROATIA, CITY SPORTS HALL SAMOBOR, ANDRIJE HEBRANGA 26A, SAMOBOR, CROATIA, CRO

2023-01-21

Tatami
3 10:00

Pool
1/2

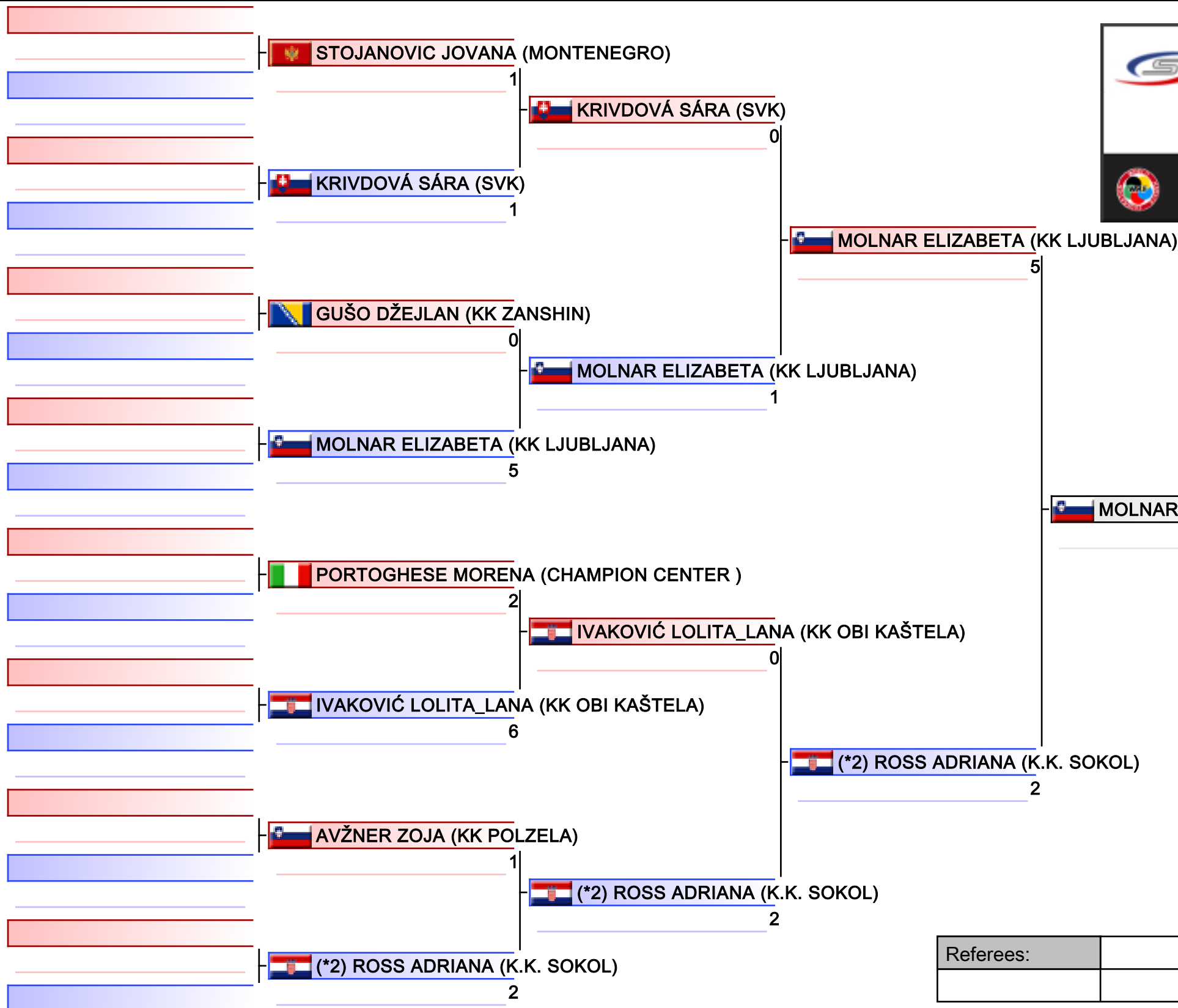

1. ZORKO MIA_GRETA (KK STIJENA)
2. MOLNAR ELIZABETA (KK LJUBLJANA)
3. KRIVDOVÁ SÁRA (SVK)
3. JURIČIĆ EMA (KKHZ)
5. ROSS ADRIANA (K.K. SOKOL)
5. SIMONINI VALENTINA (F & C)
7. GUŠO DŽEJLAN (KK ZANSHIN)
7. GUISCARDI SHARON (BODYMIND KARATE)

*Seeded

Referees:			

Kumite Female U21 -50kg

31ST KARATE GRAND PRIX CROATIA, CITY SPORTS HALL SAMOBOR, ANDRIJE HEBRANGA 26A, SAMOBOR, CROATIA, CRO

2023-01-21

Tatami
1 09:00

Pool
1/2

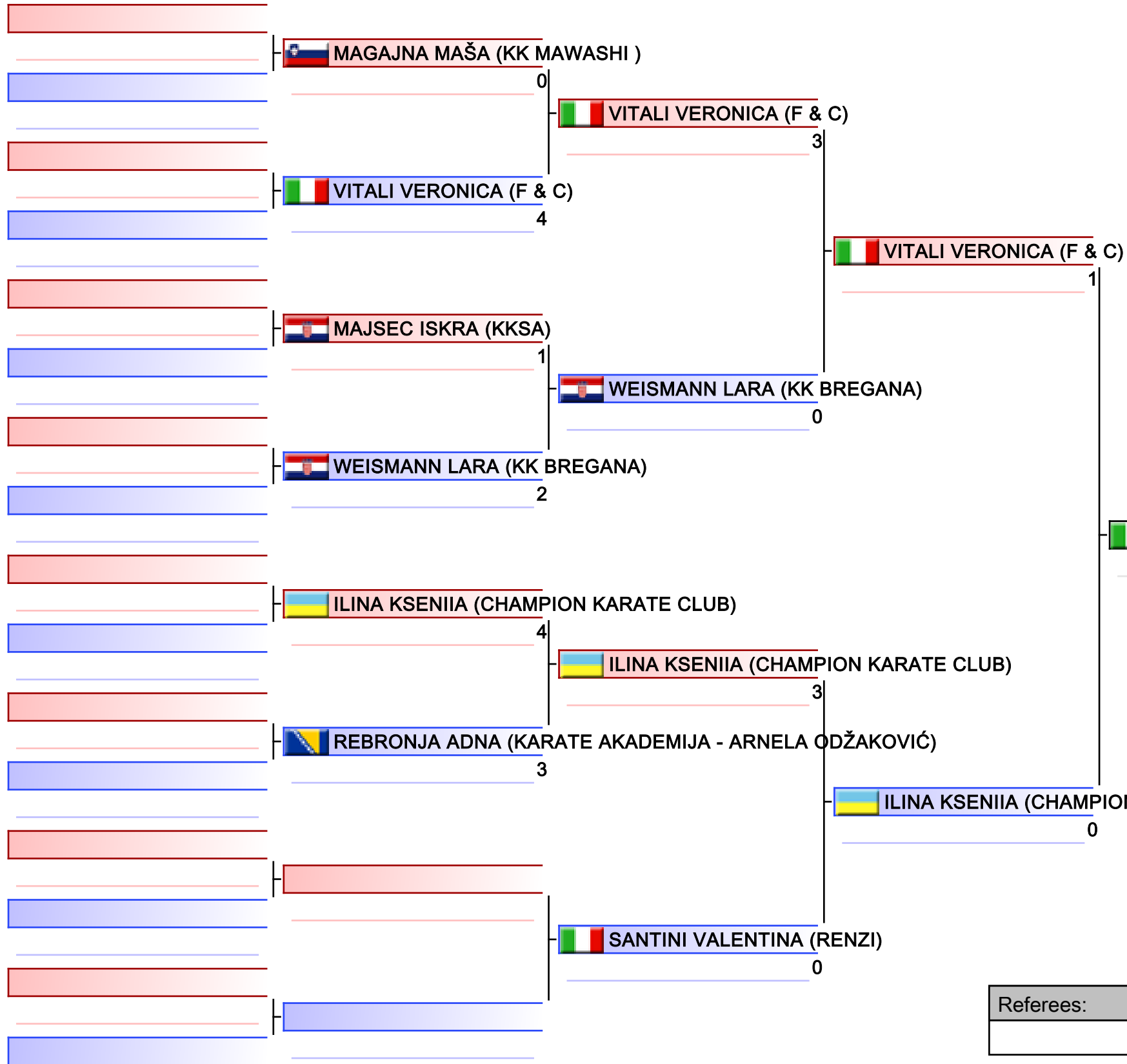

1. SGARDELLI EMA (CHAMPION RIJEKA)
2. VITALI VERONICA (F & C)
3. ILINA KSENIIA (CHAMPION KARATE CLUB)
3. MRÁZOVÁ LUCIA (SVK)
5. MAGAJNA MAŠA (KK MAWASHI)
5. MARCHENKO POLINA (TIGER TEAM)
7. WEISMANN LARA (KK BREGANA)
7. BENAROCHE MAYA (YOEL)

Referees:			

Kumite male cadets +70kg

31ST KARATE GRAND PRIX CROATIA, CITY SPORTS HALL SAMOBOR, ANDRIJE HEBRANGA 26A, SAMOBOR, CROATIA, CRO

2023-01-22

Tatami
1 13:40

Pool
1/2

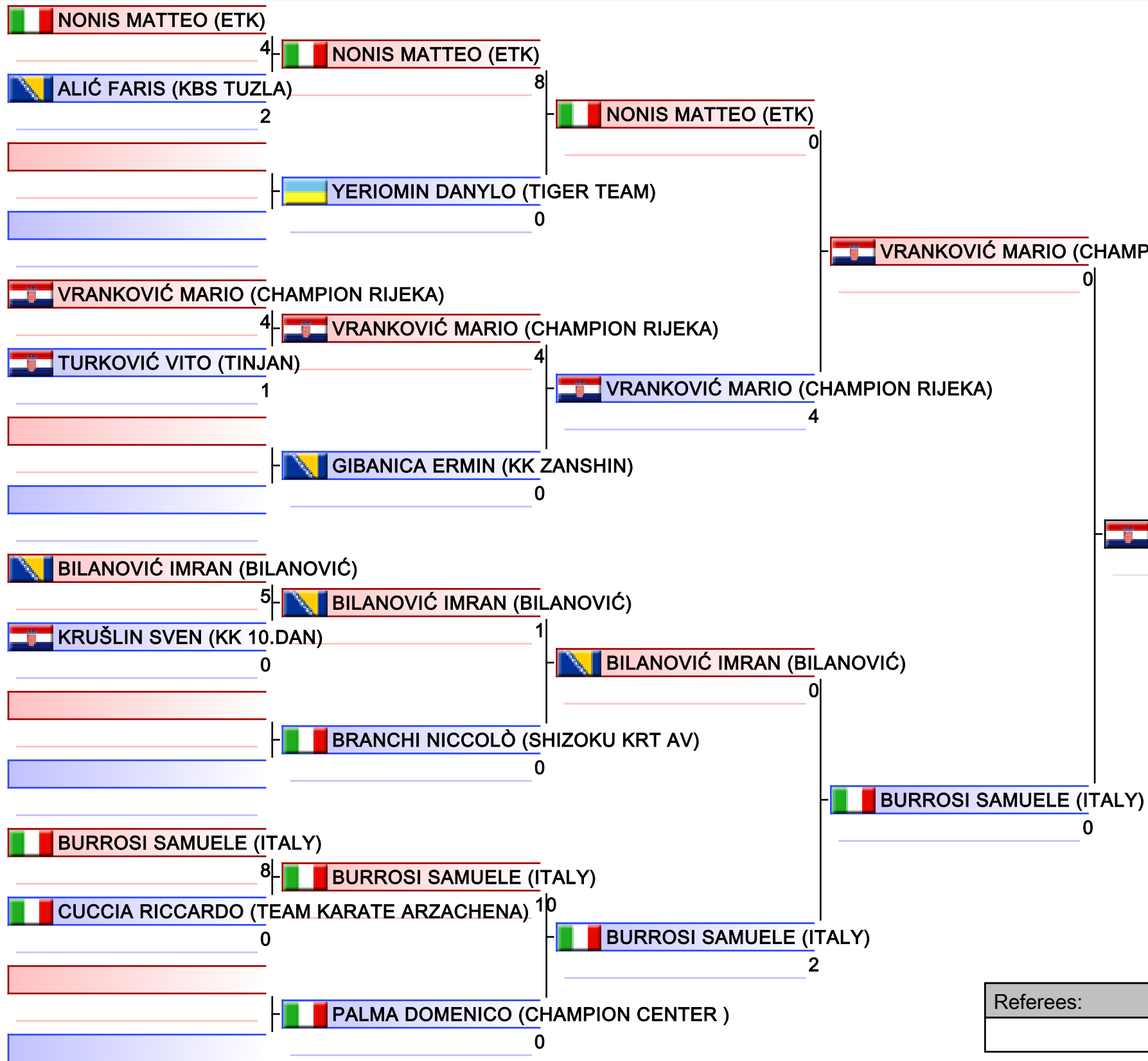

1. BOHUNICKÝ LUKÁŠ (SVK)
2. VRANKOVIĆ MARIO (CHAMPION RIJEKA)
3. BURROSI SAMUELE (ITALY)
3. GOJAKOVIC MIHAILO (MONTENEGRO)
5. NONIS MATTEO (ETK)
5. TOMA GESON (TKP)
7. GIBANICA ERMIN (KK ZANSHIN)
7. VUKOJA LOVRO (KKHZ)

Referees:			

Kumite male cadets -52kg

31ST KARATE GRAND PRIX CROATIA, CITY SPORTS HALL SAMOBOR, ANDRIJE HEBRANGA 26A, SAMOBOR, CROATIA, CRO

2023-01-22

Tatami
5 13:00

Pool
1/2

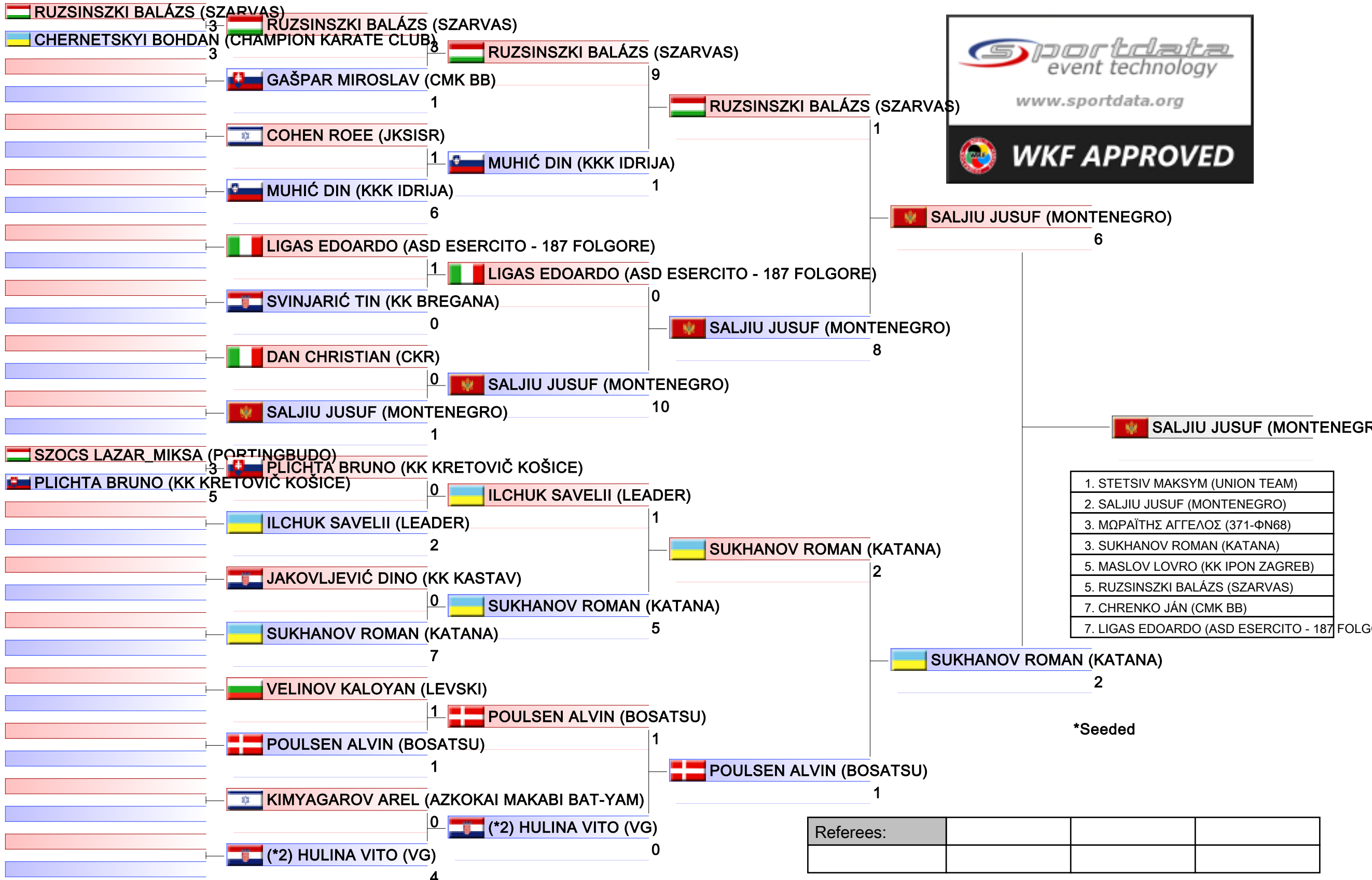

Kumite male cadets -57kg

31ST KARATE GRAND PRIX CROATIA, CITY SPORTS HALL SAMOBOR, ANDRIJE HEBRANGA 26A, SAMOBOR, CROATIA, CRO

2023-01-22

Tatami
3 14:40

Pool
1/2

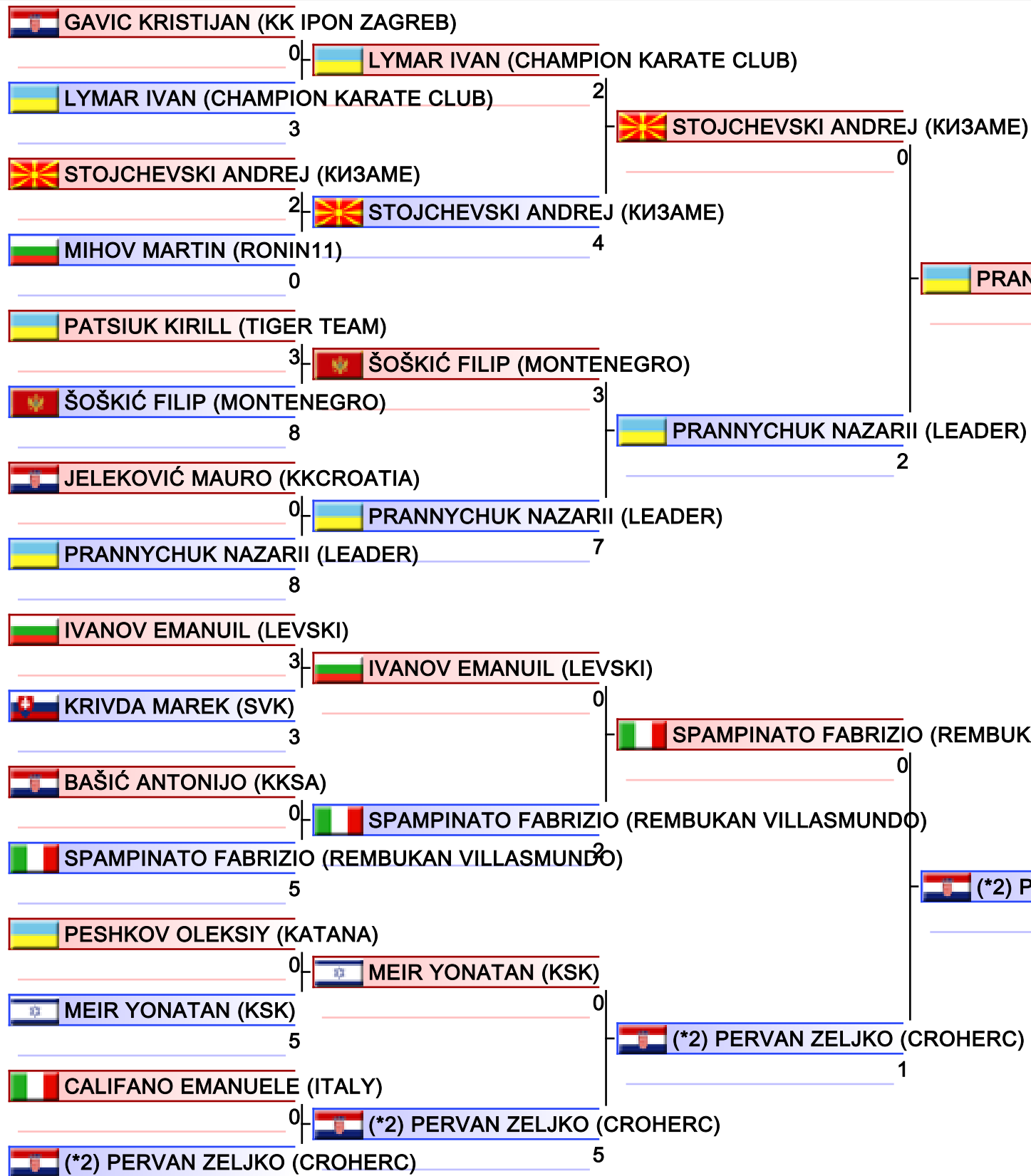

1. PRANNYCHUK NAZARII (LEADER)
2. HRYNENKO ILLIA (TIGER TEAM)
3. MIHAYLOV PETAR (RONIN11)
3. STOJCHEVSKI ANDREJ (KI3AME)
5. JURIČIĆ DANE (CROHERC)
5. PERVAN ZELJKO (CROHERC)
7. DE_STEFANO EMANUELE (SHIZOKU KRT AV)
7. ŠOŠKIĆ FILIP (MONTENEGRO)

*Seeded

Referees:			

Kumite male cadets -63kg

31ST KARATE GRAND PRIX CROATIA, CITY SPORTS HALL SAMOBOR, ANDRIJE HEBRANGA 26A, SAMOBOR, CROATIA, CRO

2023-01-22

Tatami 5 14:35

Pool 1/2

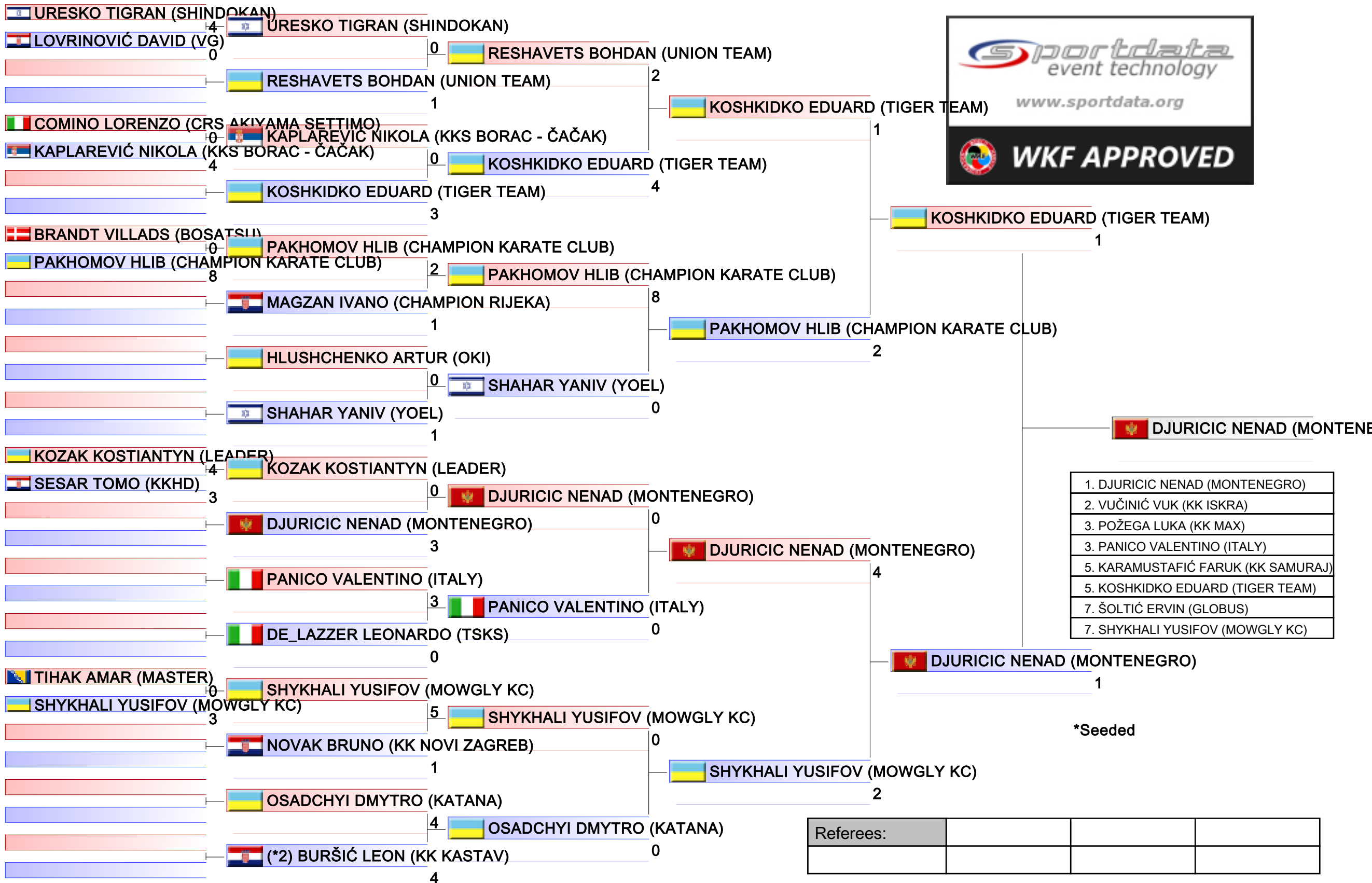

Kumite male cadets -70kg

31ST KARATE GRAND PRIX CROATIA, CITY SPORTS HALL SAMOBOR, ANDRIJE HEBRANGA 26A, SAMOBOR, CROATIA, CRO

2023-01-22

Tatami
3 13:20

Pool
1/2

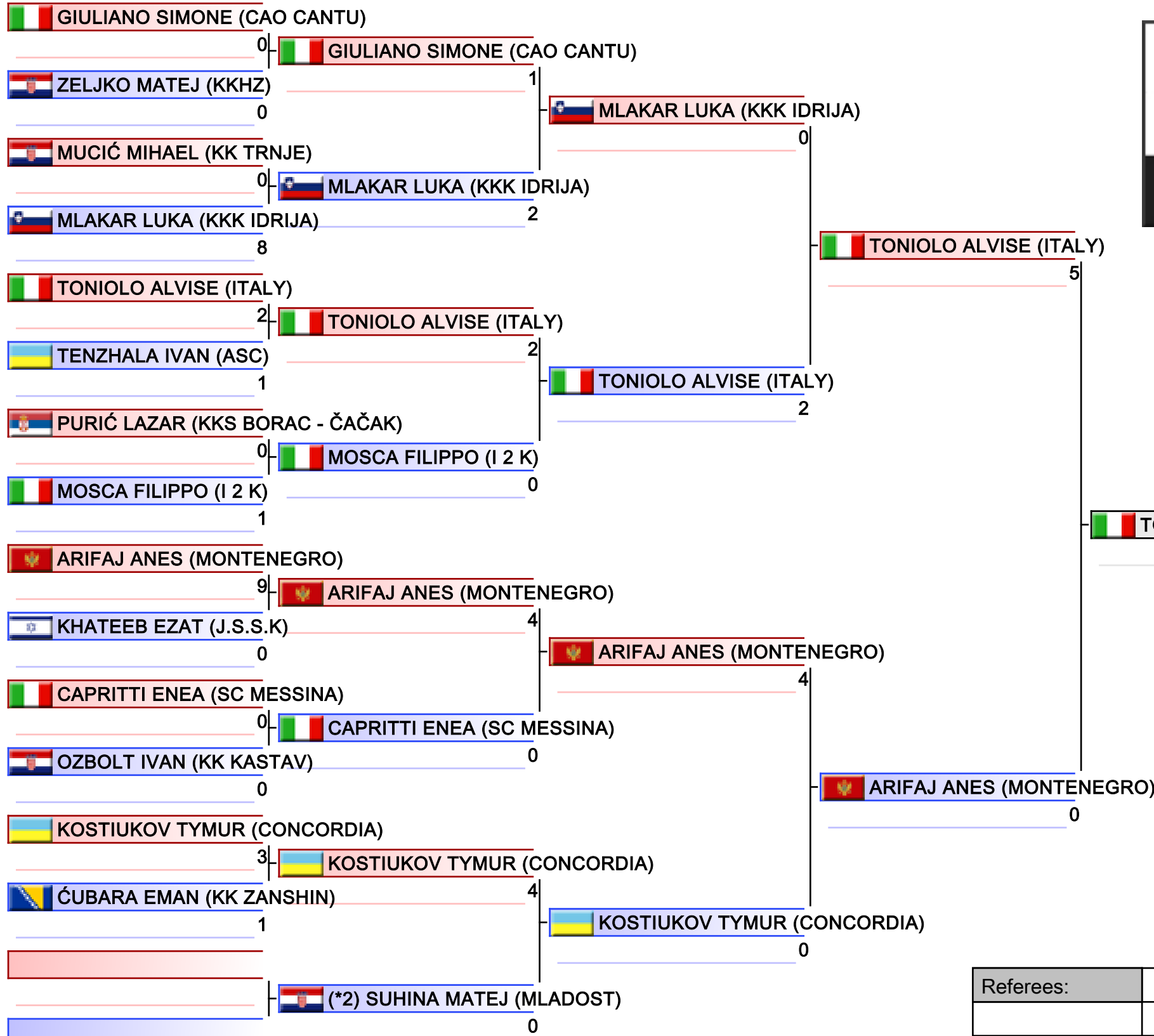

1. TONIOLO ALVISE (ITALY)
2. STRAHIJA SVEN (GLOBUS)
3. SMAJIC HARUN (KK SAMBON - VOGOSCA)
3. ARIFAJ ANES (MONTENEGRO)
5. SESTO ANDREA (CAO CANTU)
5. TENZHALA IVAN (ASC)
7. FERRARINI FRANCESCO (ASD JK CLUB)
7. MLAKAR LUKA (KKK IDRIJA)

*Seeded

Referees:			

Pool winner-Kumite Female U21 + 68kg

31ST KARATE GRAND PRIX CROATIA, CITY SPORTS HALL SAMOBOR, ANDRIJE HEBRANGA 26A, SAMOBOR, CROATIA, CRO

Tatami

Pool
1/1

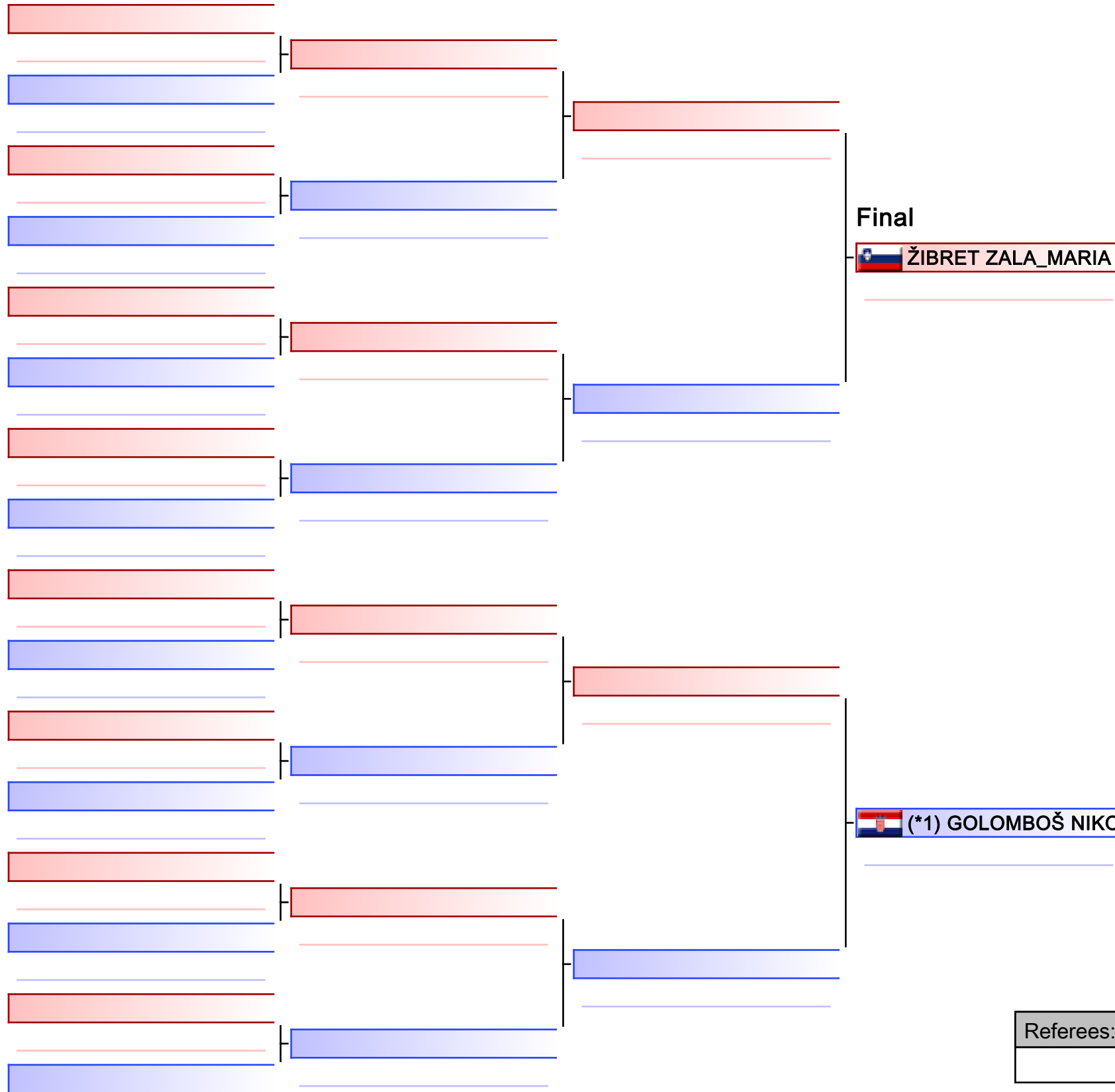

Final

ŽIBRET ZALA_MARIA (KK LJUBLJANA)

4

ŽIBRET ZALA_MARIA (KK LJUBLJANA)

(*1) GOLOMBOŠ NIKOLINA (KKTS)

3

1. ŽIBRET ZALA_MARIA (KK LJUBLJANA)
2. GOLOMBOŠ NIKOLINA (KKTS)
3. DI_BARI GEMMA (PRO-TEAM ASD)
3. RAVLIĆ ANAMARIJA (SAKURAZG)
5. DAHALIĆ AZRA (KBS TUZLA)
5. LEIDI MARTINA (ITALY)
7. PAVLOVIĆ DOMINA (KARATE KLUB ZANSHIN, S)

*Seeded

Referees:			

Pool winner-Kumite Female U21 - 61kg

31ST KARATE GRAND PRIX CROATIA, CITY SPORTS HALL SAMOBOR, ANDRIJE HEBRANGA 26A, SAMOBOR, CROATIA, CRO

Tatami

Pool
1/1

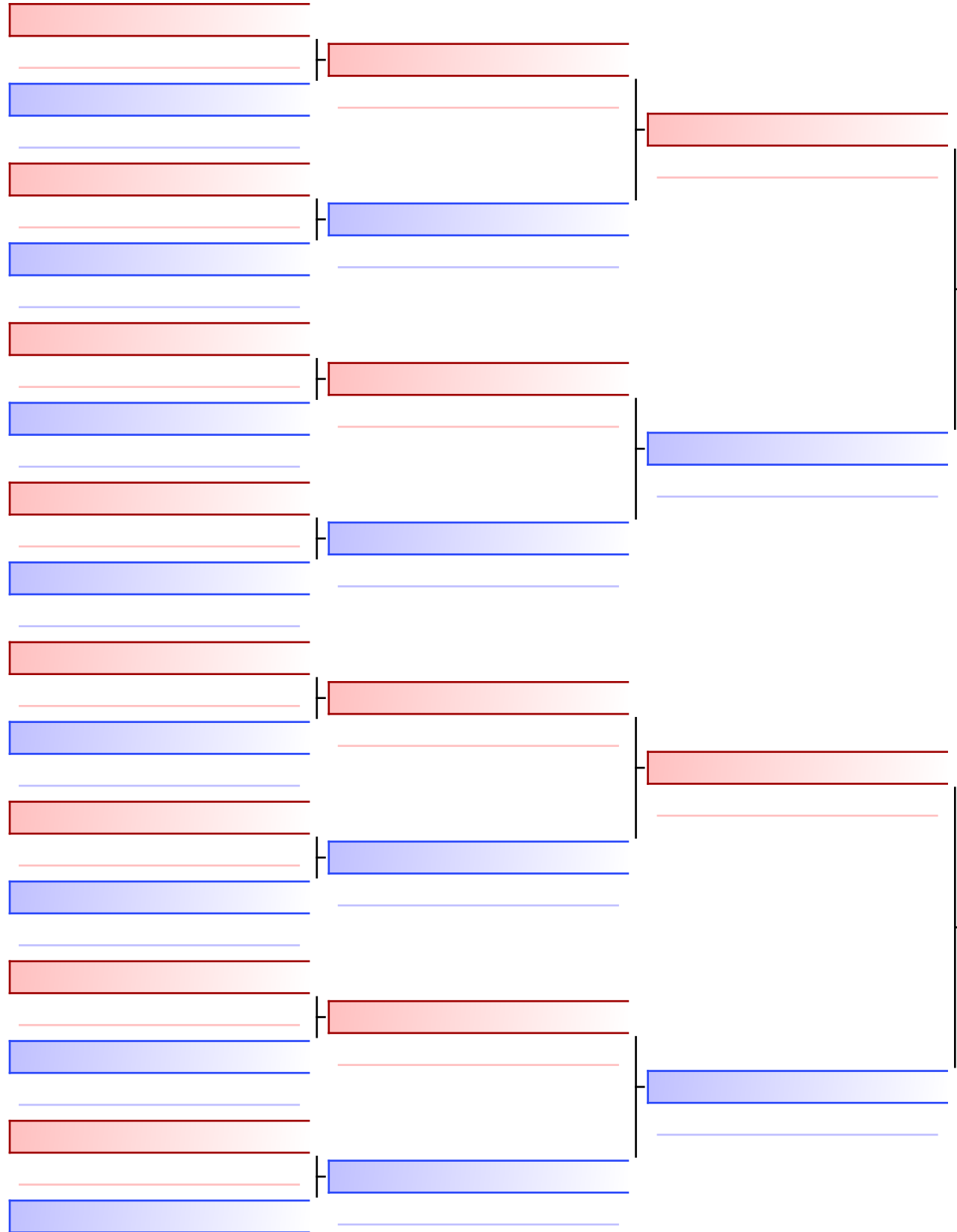

Final

DEBELJAK HANA (KK LJUBLJANA)

4

DEBELJAK HANA (KK LJUBLJANA)

SIPOVIC EMINA (IPPON SARAJEVO)

1

1. DEBELJAK HANA (KK LJUBLJANA)
2. SIPOVIC EMINA (IPPON SARAJEVO)
3. JOVANOVSKA VIKTORIJA (MAKPETROL MKD)
3. ALIU RUDINA (ЦВЕТАН ДИМОВ - СКОПЈЕ)
5. KURTEŠ MARINA (KK SLAVIJA)
5. DESTE FEDERICA (K 01)
7. LISAC LAURA (K.K. SOKOL)
7. CECERE MARIKA (A.T. KARATE CLUB ROMA)

*Seeded

Referees:			

Pool winner-Kumite Female U21 - 68kg

31ST KARATE GRAND PRIX CROATIA, CITY SPORTS HALL SAMOBOR, ANDRIJE HEBRANGA 26A, SAMOBOR, CROATIA, CRO

Tatami

Pool
1/1

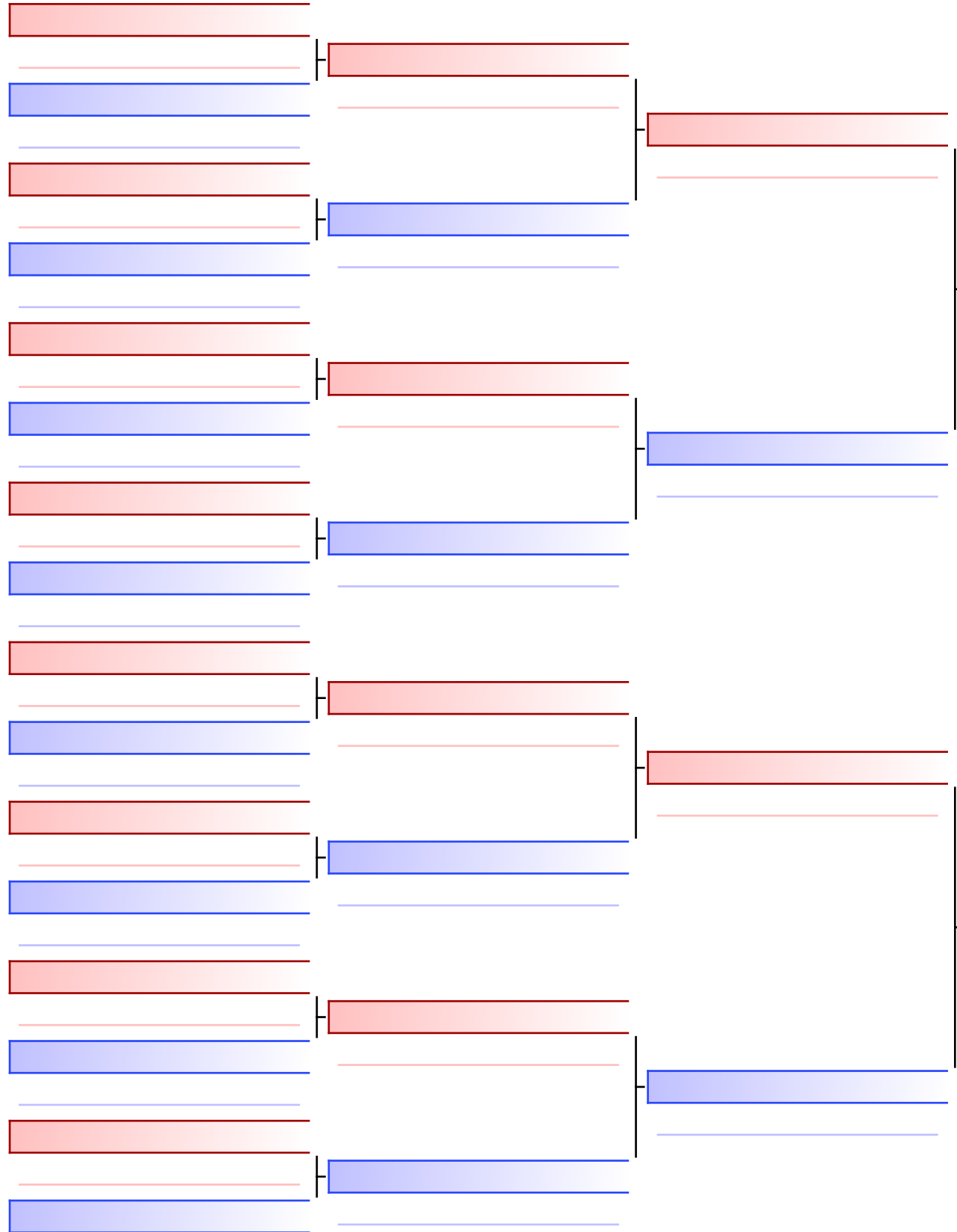

Final

MOLNAR ELIZABETA (KK LJUBLJANA)

1

ZORKO MIA_GRETA (KK STIJENA)

ZORKO MIA_GRETA (KK STIJENA)

3

1. ZORKO MIA_GRETA (KK STIJENA)
2. MOLNAR ELIZABETA (KK LJUBLJANA)
3. KRIVDOVÁ SÁRA (SVK)
3. JURIČIĆ EMA (KKHZ)
5. ROSS ADRIANA (K.K. SOKOL)
5. SIMONINI VALENTINA (F & C)
7. GUŠO DŽEJLAN (KK ZANSHIN)
7. GUISCARDI SHARON (BODYMIND KARATE)

*Seeded

Referees:			

Pool winner-Kumite Female U21 -50kg

31ST KARATE GRAND PRIX CROATIA, CITY SPORTS HALL SAMOBOR, ANDRIJE HEBRANGA 26A, SAMOBOR, CROATIA, CRO

Tatami

Pool
1/1

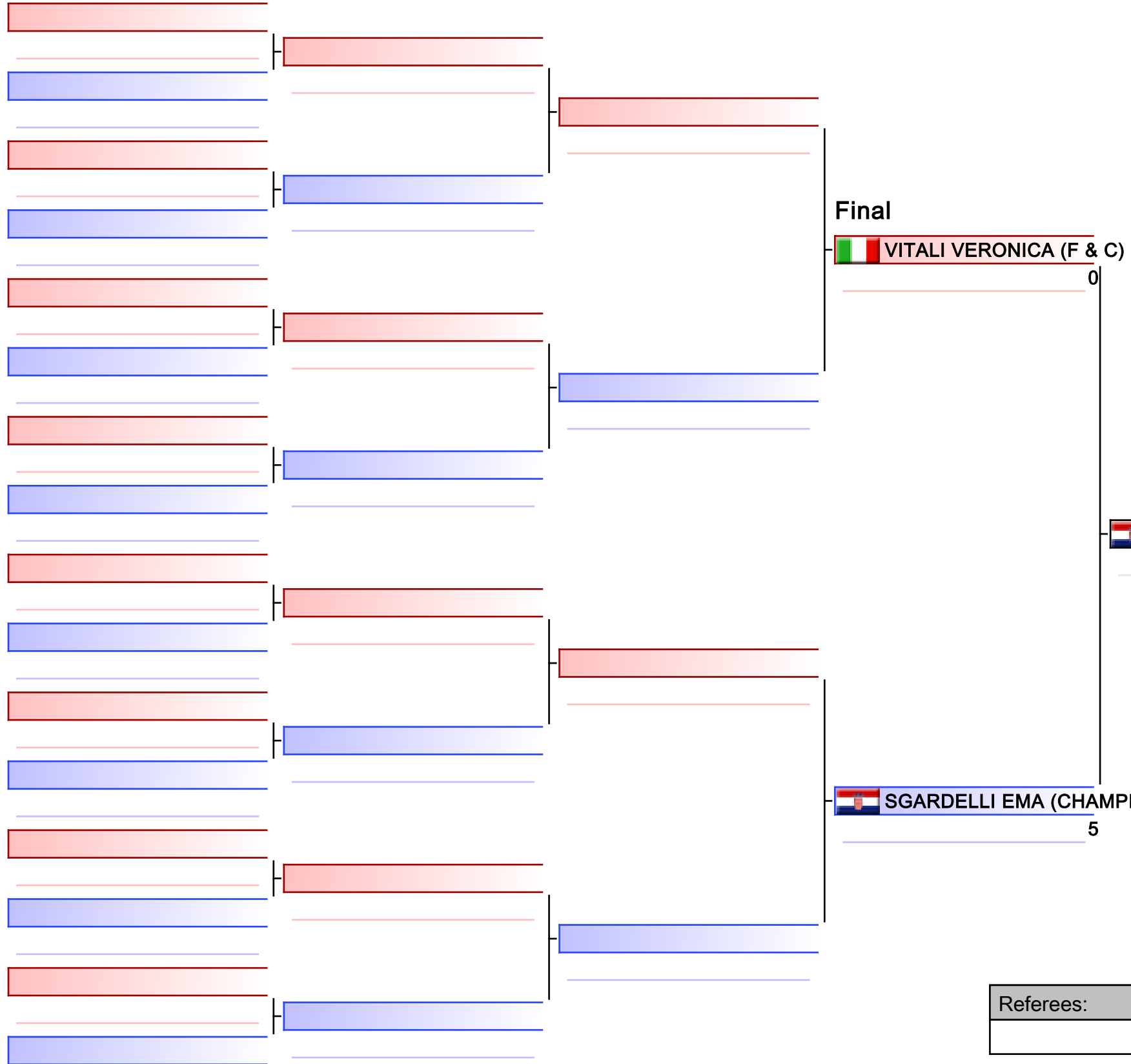

SGARDELLI EMA (CHAMPION RIJEKA)

- | |
|---|
| 1. SGARDELLI EMA (CHAMPION RIJEKA) |
| 2. VITALI VERONICA (F & C) |
| 3. ILINA KSENIIA (CHAMPION KARATE CLUB) |
| 3. MRÁZOVÁ LUCIA (SVK) |
| 5. MAGAJNA MAŠA (KK MAWASHI) |
| 5. MARCHENKO POLINA (TIGER TEAM) |
| 7. WEISMANN LARA (KK BREGANA) |
| 7. BENAROCHE MAYA (YOEL) |

Referees:			

Pool winner-Kumite male cadets +70kg

31ST KARATE GRAND PRIX CROATIA, CITY SPORTS HALL SAMOBOR, ANDRIJE HEBRANGA 26A, SAMOBOR, CROATIA, CRO

Tatami

Pool
1/1

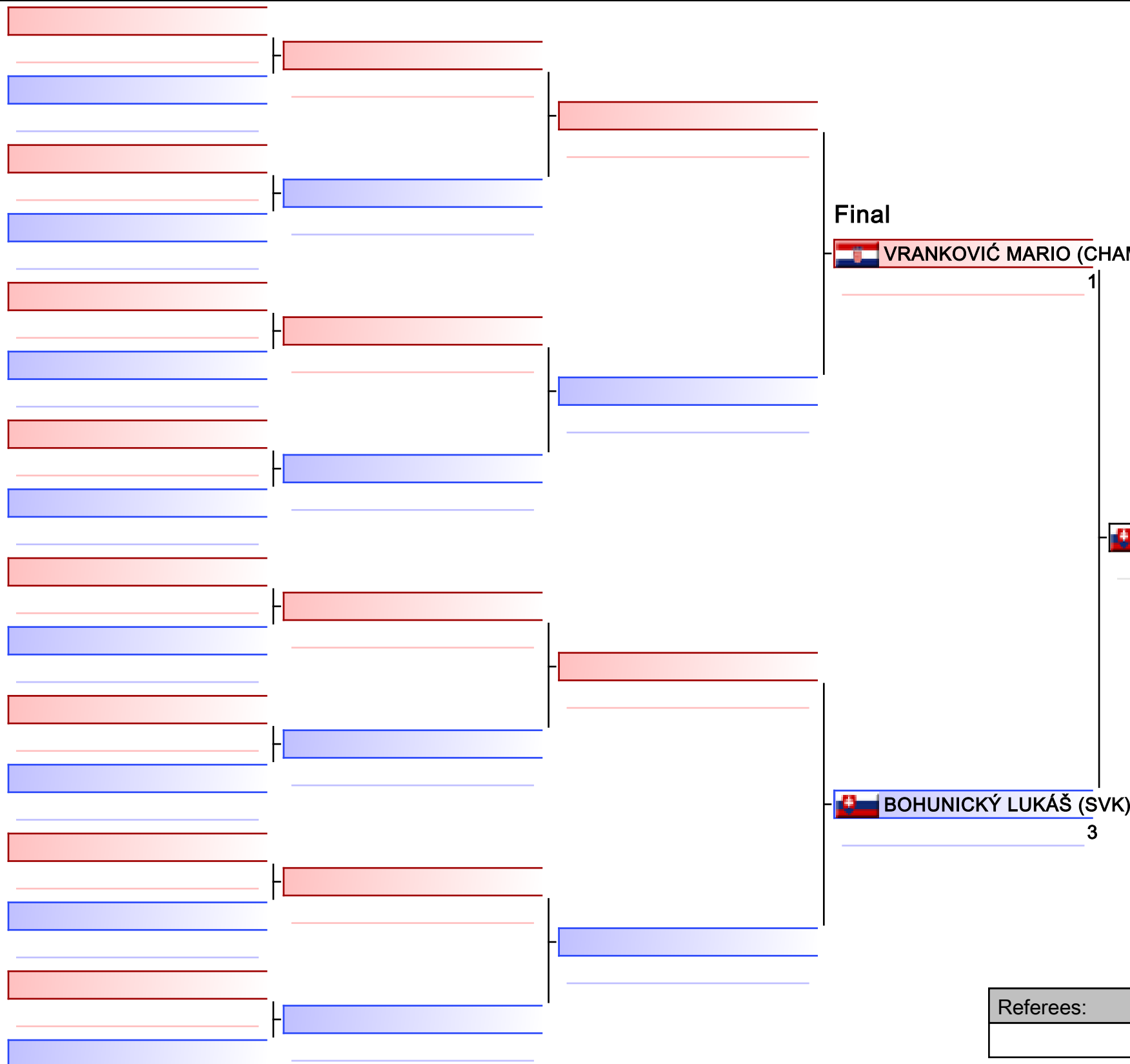

Final

VRANKOVIĆ MARIO (CHAMPION RIJEKA)

1

BOHUNICKÝ LUKÁŠ (SVK)

BOHUNICKÝ LUKÁŠ (SVK)

3

1. BOHUNICKÝ LUKÁŠ (SVK)
2. VRANKOVIĆ MARIO (CHAMPION RIJEKA)
3. BURROSI SAMUELE (ITALY)
3. GOJAKOVIC MIHAILO (MONTENEGRO)
5. NONIS MATTEO (ETK)
5. TOMA GESON (TKP)
7. GIBANICA ERMIN (KK ZANSHIN)
7. VUKOJA LOVRO (KKHZ)

Referees:			

Pool winner-Kumite male cadets -52kg

31ST KARATE GRAND PRIX CROATIA, CITY SPORTS HALL SAMOBOR, ANDRIJE HEBRANGA 26A, SAMOBOR, CROATIA, CRO

Tatami

Pool
1/1

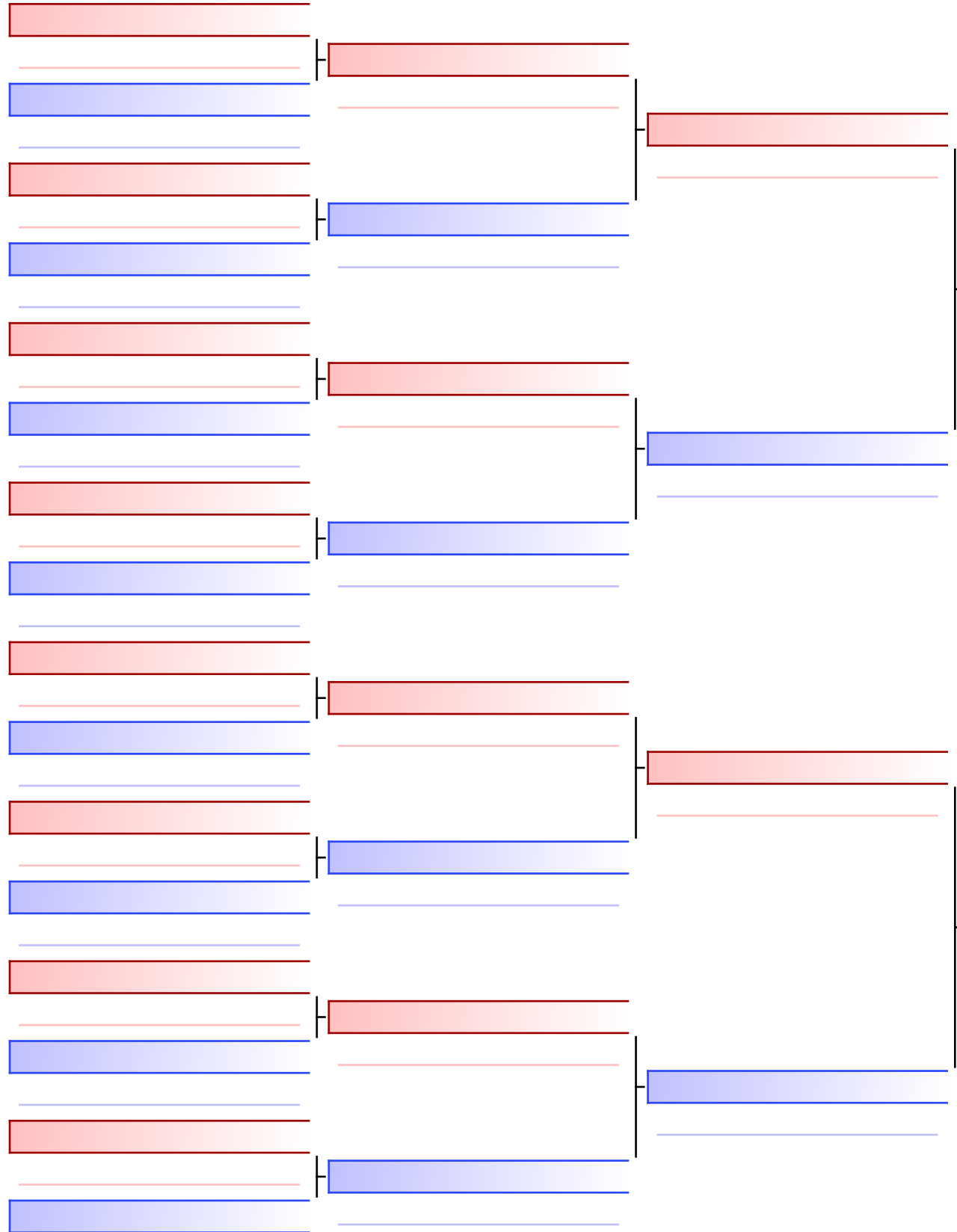

Final

SALJIU JUSUF (MONTENEGRO)

0

STETSIV MAKSYM (UNION TEAM)

STETSIV MAKSYM (UNION TEAM)

0

1. STETSIV MAKSYM (UNION TEAM)
2. SALJIU JUSUF (MONTENEGRO)
3. ΜΩΠΑΪΤΗΣ ΑΓΓΕΛΟΣ (371-ΦΝ68)
3. SUKHANOV ROMAN (KATANA)
5. MASLOV LOVRO (KK IPON ZAGREB)
5. RUZSINSZKI BALÁZS (SZARVAS)
7. CHRENKO JÁN (CMK BB)
7. LIGAS EDOARDO (ASD ESERCITO - 187 FOLGO)

*Seeded

Referees:			

Pool winner-Kumite male cadets -57kg

31ST KARATE GRAND PRIX CROATIA, CITY SPORTS HALL SAMOBOR, ANDRIJE HEBRANGA 26A, SAMOBOR, CROATIA, CRO

Tatami

Pool
1/1

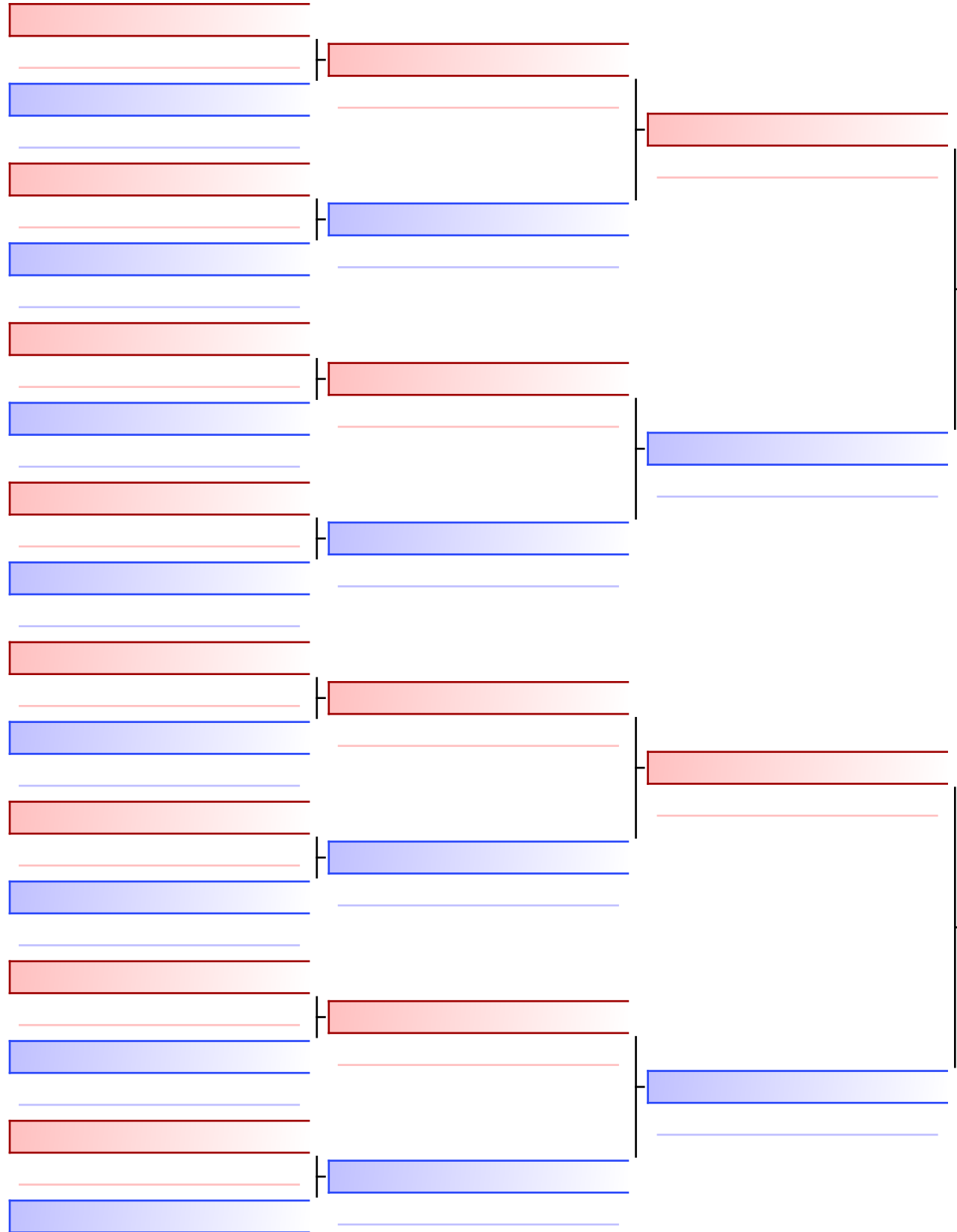

Final

PRANNYCHUK NAZARII (LEADER)

3

PRANNYCHUK NAZARII (LEADER)

HRYNENKO ILLIA (TIGER TEAM)

1

1. PRANNYCHUK NAZARII (LEADER)
2. HRYNENKO ILLIA (TIGER TEAM)
3. MIHAYLOV PETAR (RONIN11)
3. STOJCHEVSKI ANDREJ (KI3AME)
5. JURIČIĆ DANE (CROHERC)
5. PERVAN ZELJKO (CROHERC)
7. DE_STEFANO EMANUELE (SHIZOKU KRT AV)
7. ŠOŠKIĆ FILIP (MONTENEGRO)

***Seeded**

Referees:			

Pool winner-Kumite male cadets -63kg

31ST KARATE GRAND PRIX CROATIA, CITY SPORTS HALL SAMOBOR, ANDRIJE HEBRANGA 26A, SAMOBOR, CROATIA, CRO

Tatami

Pool
1/1

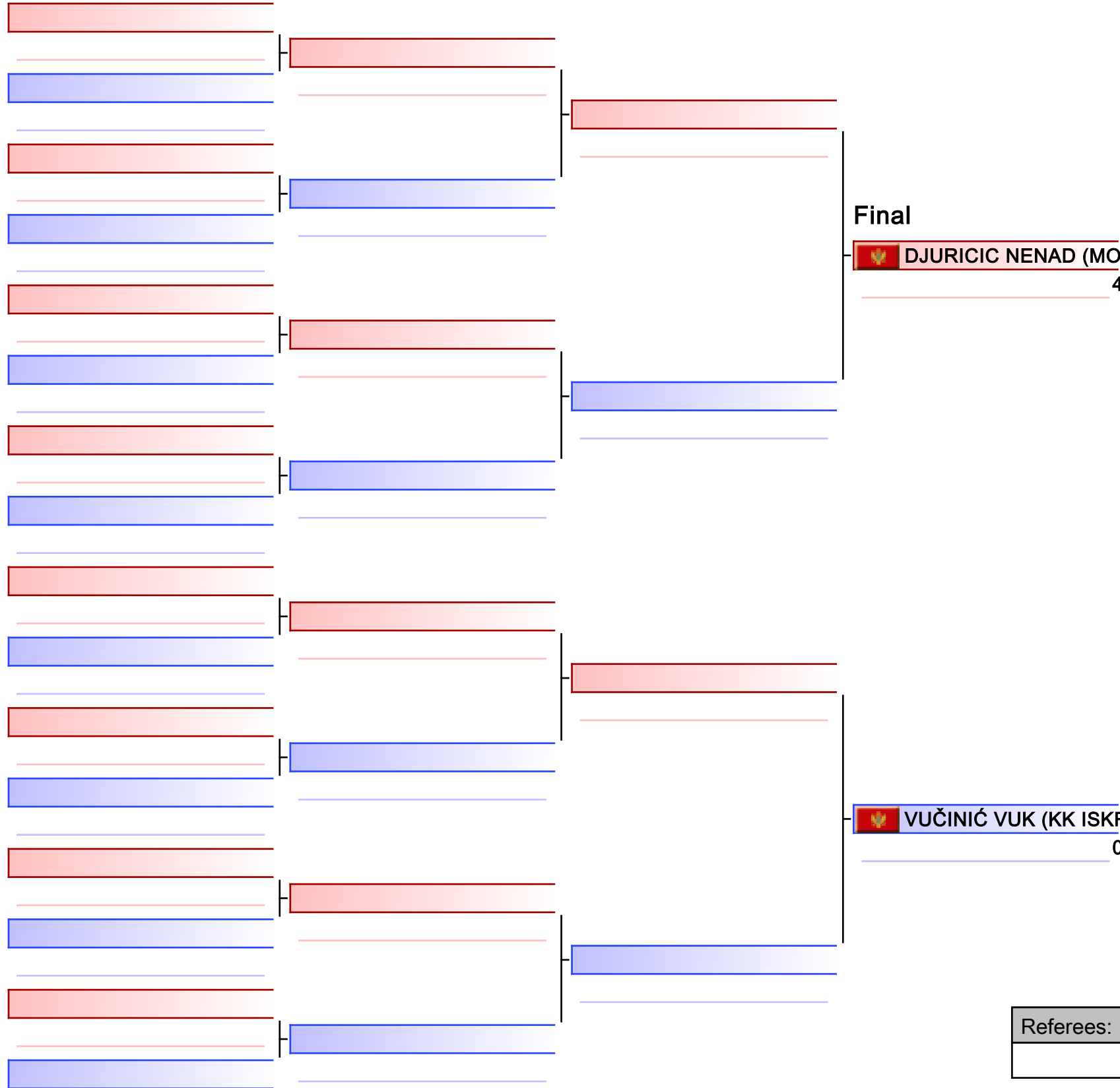

DJURICIC NENAD (MONTENEGRO)

1. DJURICIC NENAD (MONTENEGRO)
2. VUČINIĆ VUK (KK ISKRA)
3. POŽEGA LUKA (KK MAX)
3. PANICO VALENTINO (ITALY)
5. KARAMUSTAFIĆ FARUK (KK SAMURAJ)
5. KOSHKIDKO EDUARD (TIGER TEAM)
7. ŠOLTIĆ ERVIN (GLOBUS)
7. SHYKHALI YUSIFOV (MOWGLY KC)

*Seeded

Referees:			

Pool winner-Kumite male cadets -70kg

31ST KARATE GRAND PRIX CROATIA, CITY SPORTS HALL SAMOBOR, ANDRIJE HEBRANGA 26A, SAMOBOR, CROATIA, CRO

Tatami

Pool
1/1

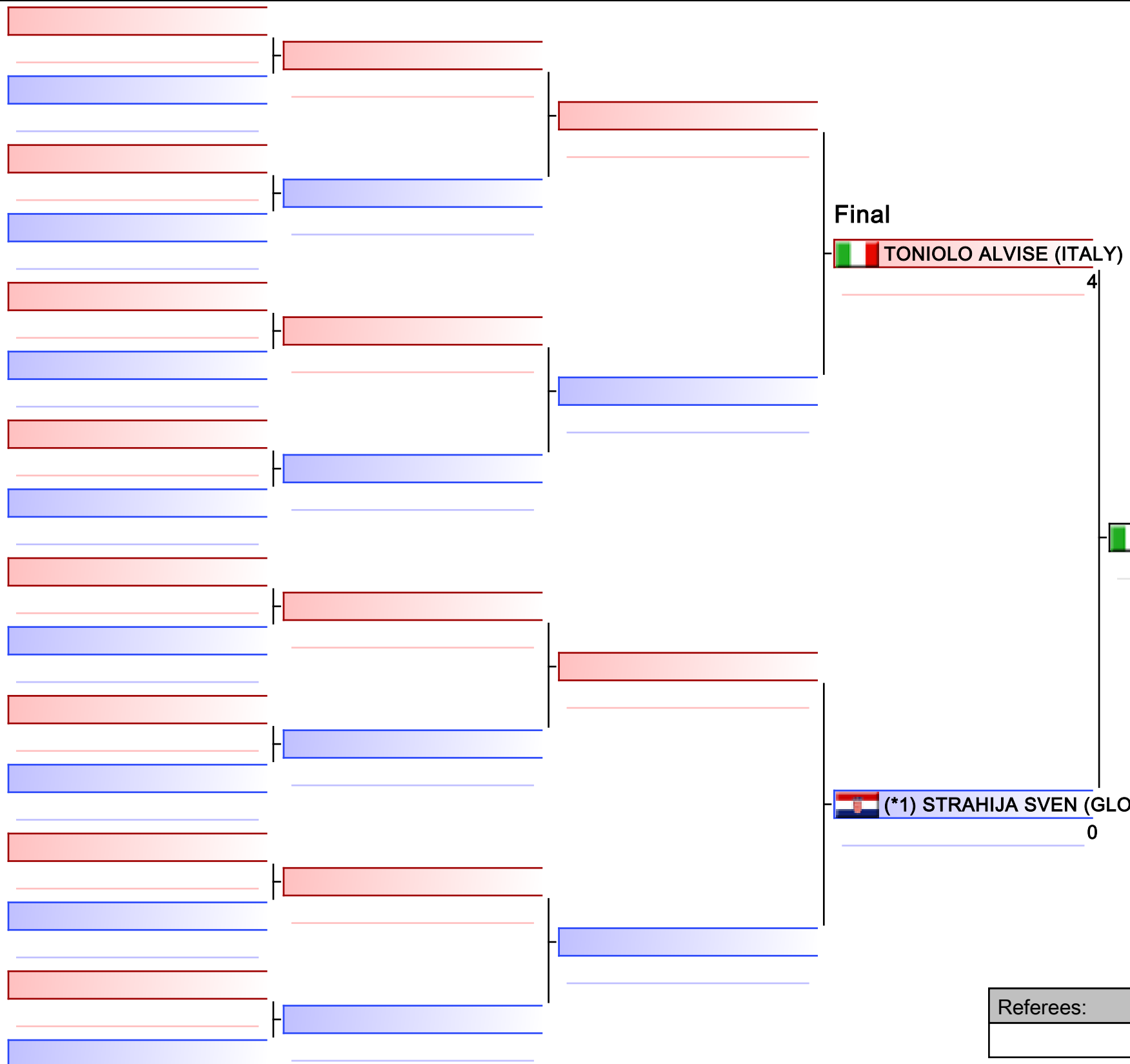

TONIOLO ALVISE (ITALY)

1. TONIOLO ALVISE (ITALY)
2. STRAHIJA SVEN (GLOBUS)
3. SMAJIC HARUN (KK SAMBON - VOGOSCA)
3. ARIFAJ ANES (MONTENEGRO)
5. SESTO ANDREA (CAO CANTU)
5. TENZHALA IVAN (ASC)
7. FERRARINI FRANCESCO (ASD JK CLUB)
7. MLAKAR LUKA (KKK IDRJA)

***Seeded**

Referees:			

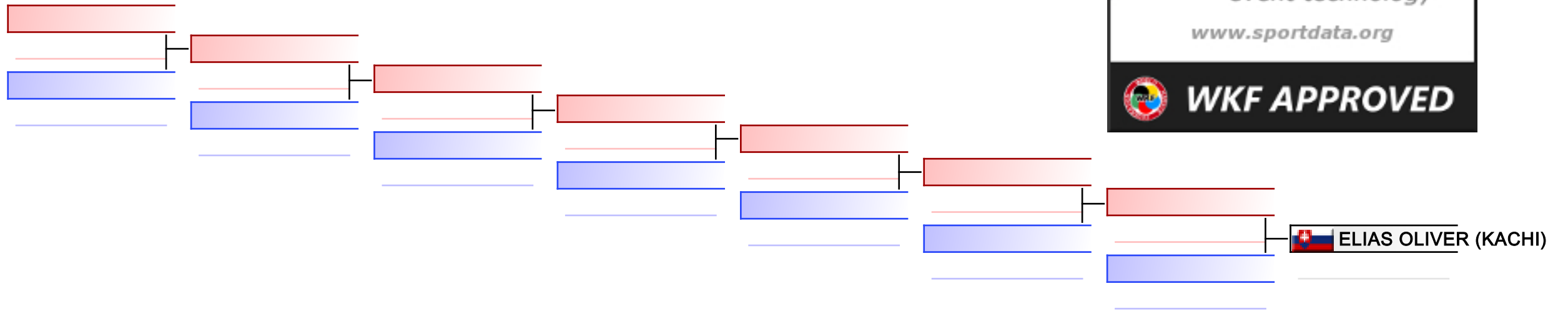

REPECHAGE: (1)

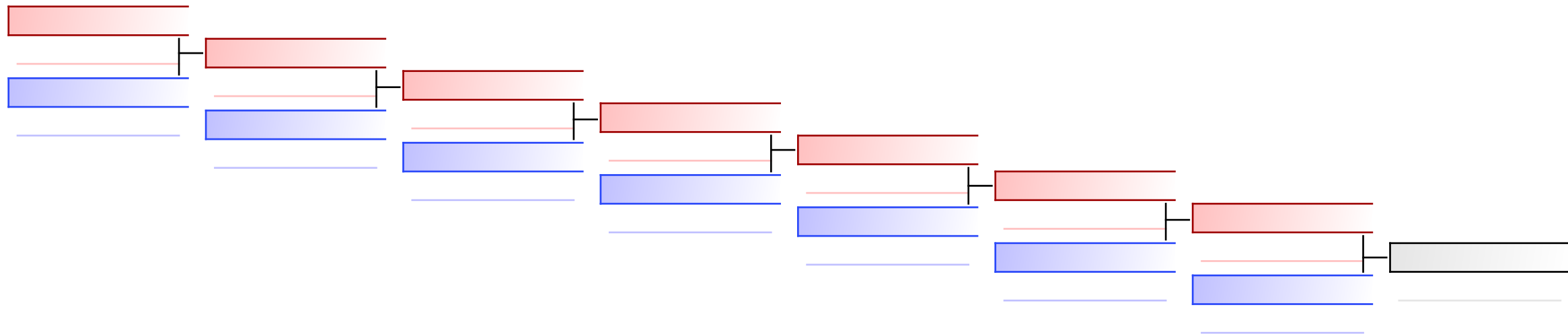

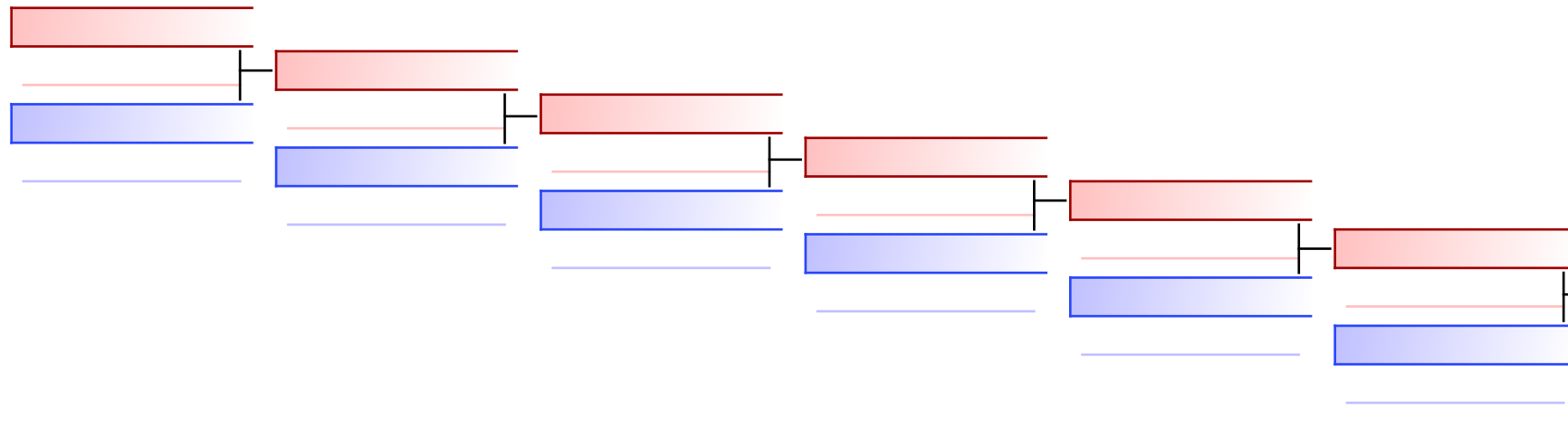

Referees:							
-----------	--	--	--	--	--	--	--

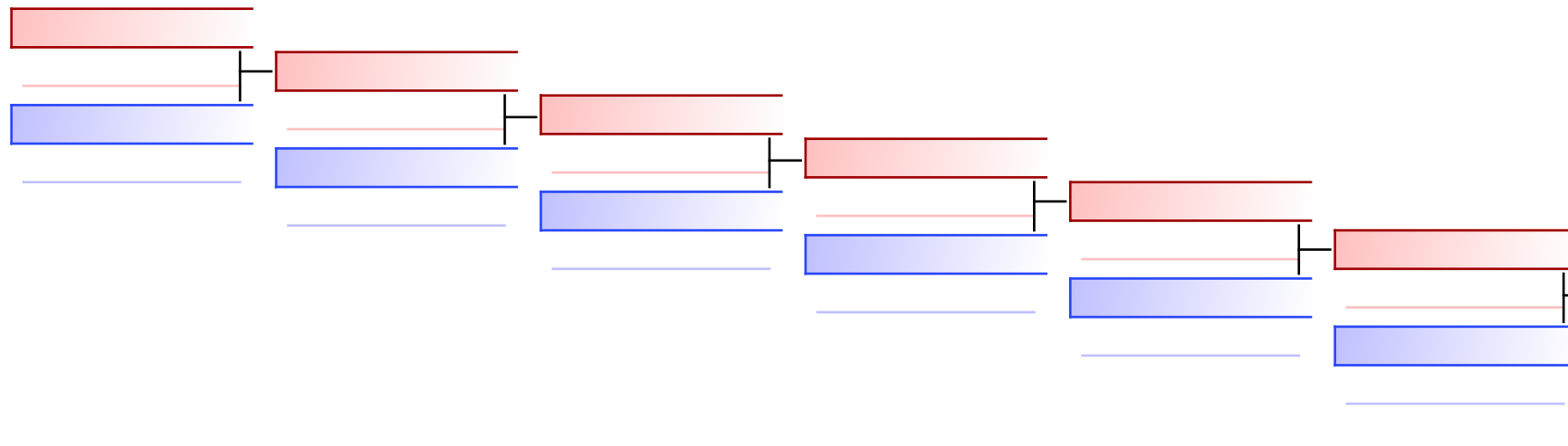

 **KOTNIK LIAM (KK SEKI)**
 **KOTNIK LIAM (KK SEKI)**
 **TSVYATKOV NIKOLAY (FIGHTERS-NSA)**

REPECHAGE: (1)



 **HAVRYLIUK VARLAM (TIGER TEAM)**
 **PALKA ADAM (SSK BA)**
 **PALKA ADAM (SSK BA)**

Referees:							
-----------	--	--	--	--	--	--	--

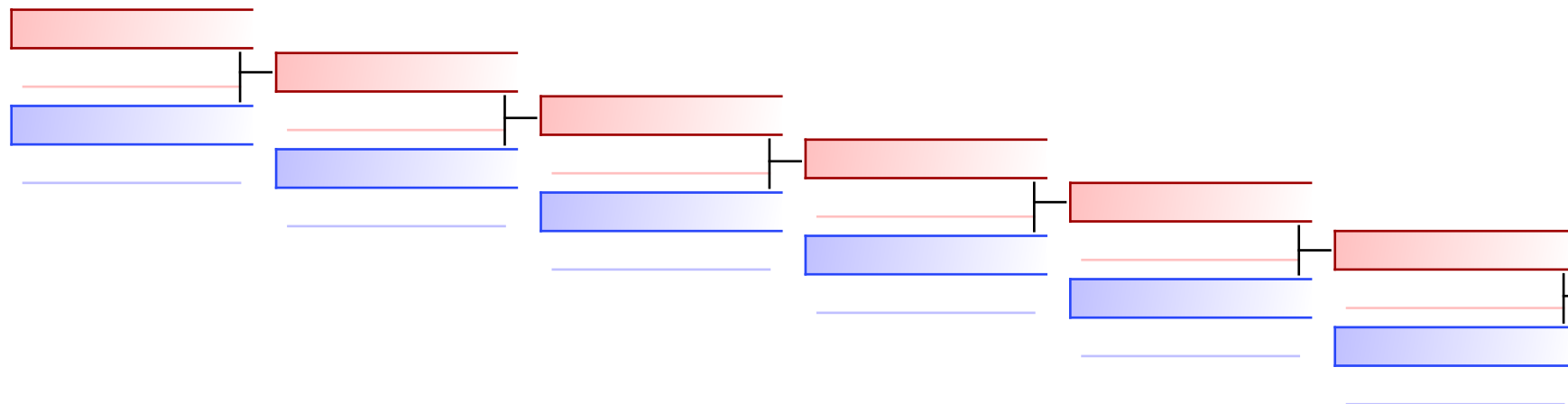

ČIZMIĆ MATEJ (KK ALFA)
 026 Heian Nid. 0

PETRUŠIĆ LUKA (KKSHIHAN)
 026 Heian Nid. 5

REPECHAGE: (1)

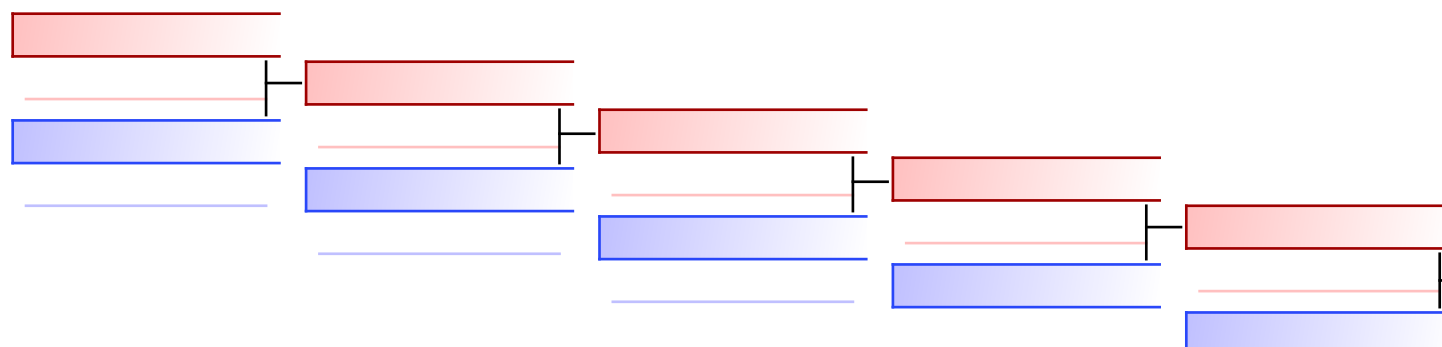

SKAKOVSKYI SAVELII (KATANA)
 018 Gekisai N. 5

SKAKOVSKYI SAVELII (KATANA)
 018 Gekisai N. 3

NEGATUROV YEHOR (TIGER TEAM)
 028 Heian Yon. 0

SAWAED ADI (J.S.S.K)
 026 Heian Nid. 2

Referees:							
-----------	--	--	--	--	--	--	--

KUMITE BOYS 11-12 YEARS +54KG

31ST KARATE GRAND PRIX CROATIA

2023-01-22

Tatami
1 16:50

Pool
1

(c)sportdata GmbH & Co KG 2000-2023 (2023-01-22 22:22) v 10.0.0 build 1 (2023-01-19) License: Online_Event_ID-6798_31STKARATEGRANDPRIXCROATIA (expire 2023-02-05)

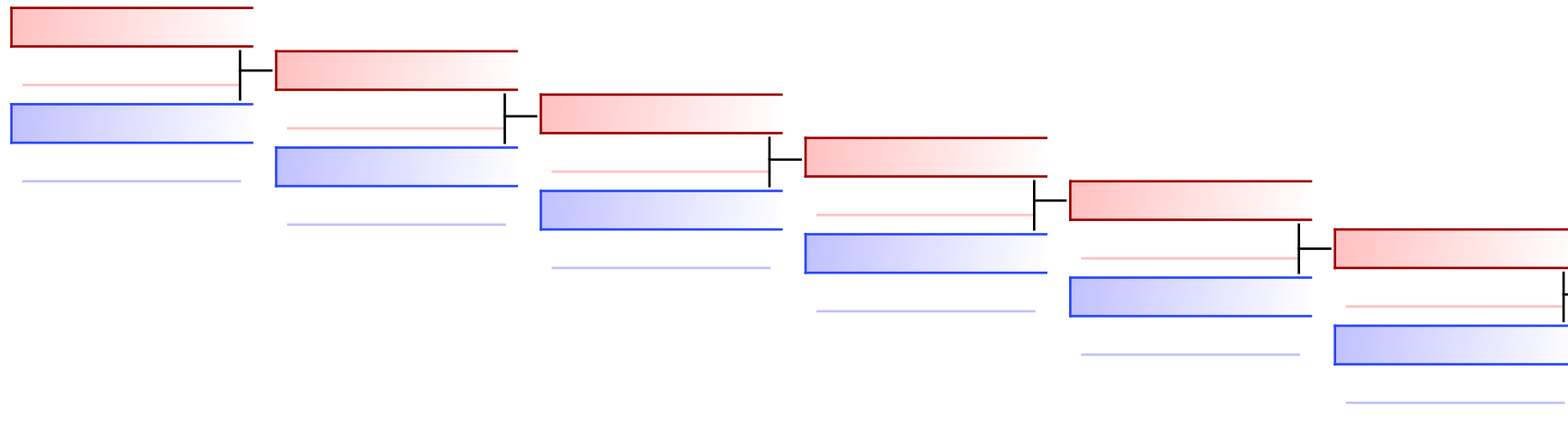

LOPATKA MARTIN (SSK BA)
0
 MUCIĆ DOMINIK (KK TRNJE)
3

REPECHAGE: (1)

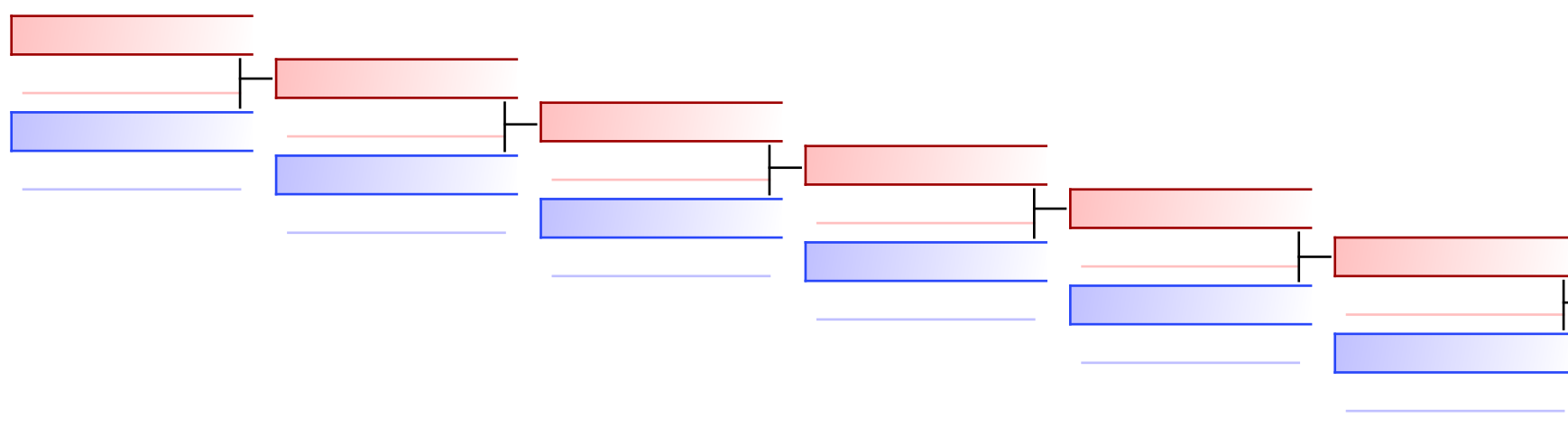

HRŠAK FILIP (KKHD)
0
 TURKOVIĆ JAN (KK LJUBLJANA)
2

Referees:							
-----------	--	--	--	--	--	--	--

KUMITE BOYS 11-12 YEARS -34KG

31ST KARATE GRAND PRIX CROATIA

2023-01-22

Tatami
5 17:15

Pool
1

(c)sportdata GmbH & Co KG 2000-2023 (2023-01-22 22:22) v 10.0.0 build 1 (2023-01-19) License: Online_Event_ID-6798_31STKARATEGRANDPRIXCROATIA (expire 2023-02-05)

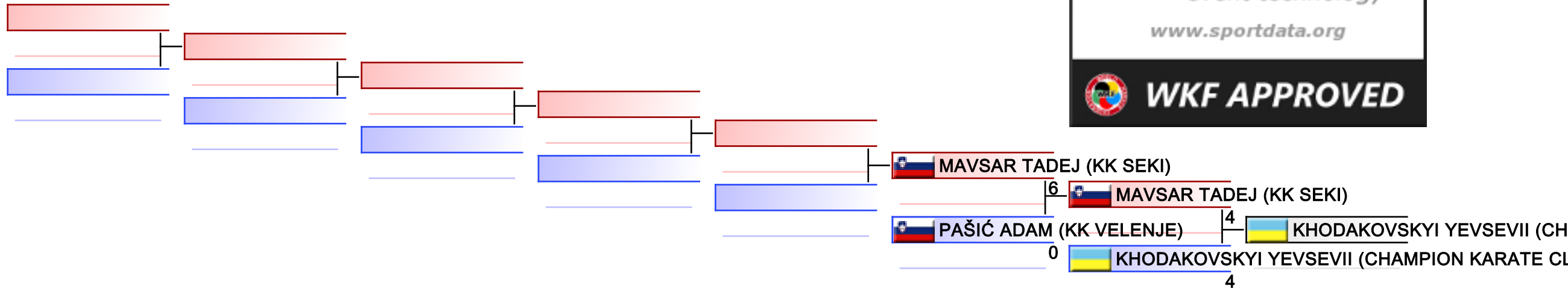

REPECHAGE: (1)

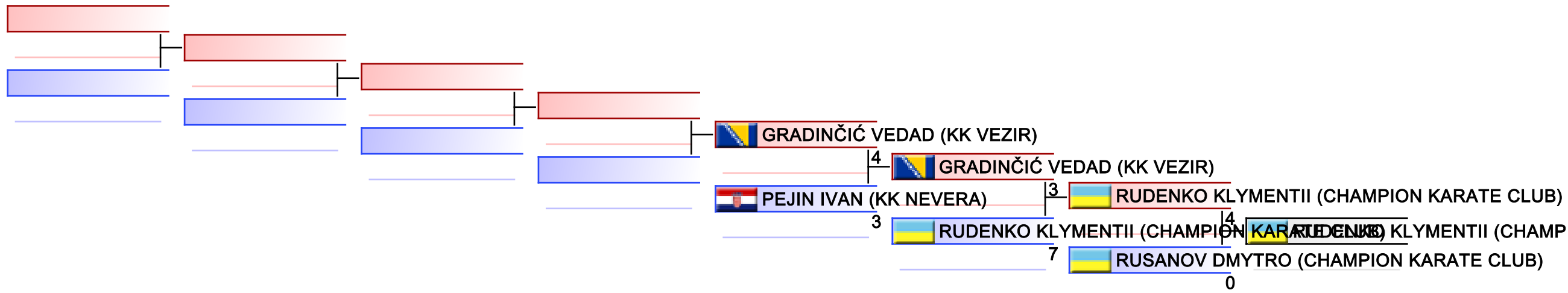

Referees:							
-----------	--	--	--	--	--	--	--

KUMITE BOYS 11-12 YEARS -39KG

31ST KARATE GRAND PRIX CROATIA

2023-01-22

Tatami
2 16:25

Pool
1

(c)sportdata GmbH & Co KG 2000-2023 (2023-01-22 22:22) v 10.0.0 build 1 (2023-01-19) License: Online_Event_ID-6798_31STKARATEGRANDPRIXCROATIA (expire 2023-02-05)

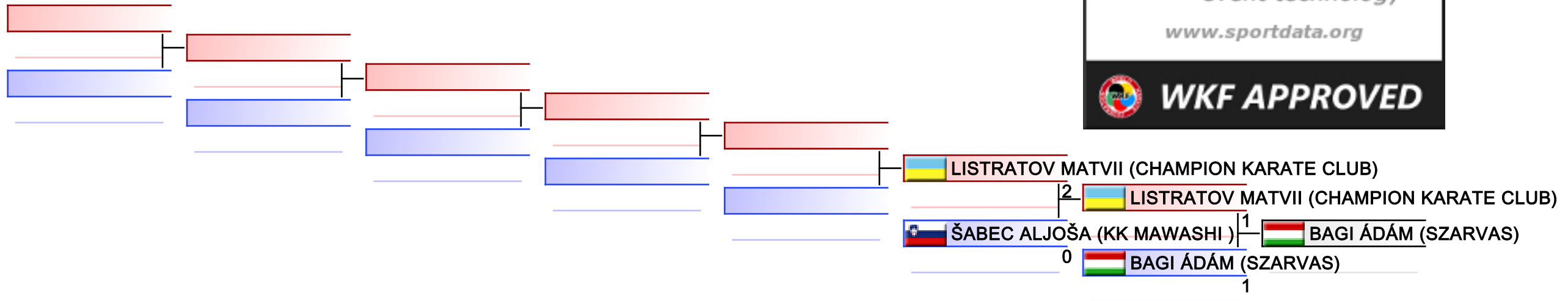

REPECHAGE: (1)

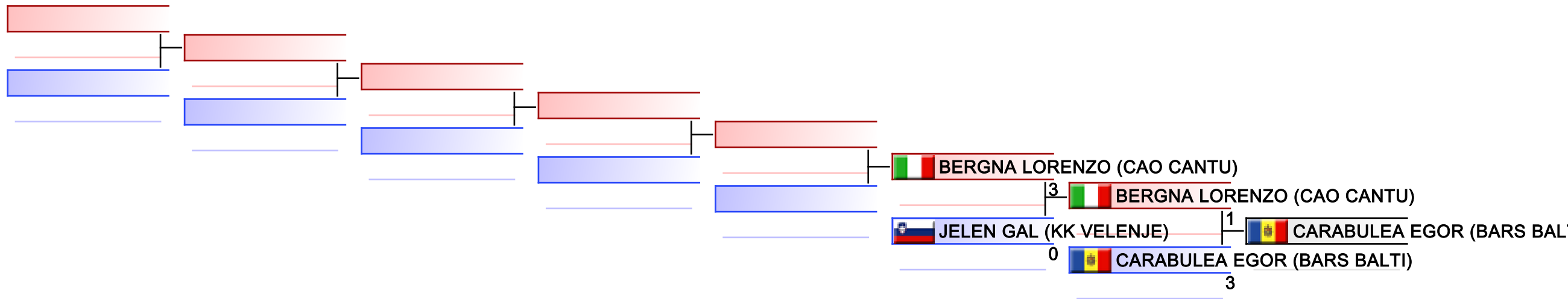

Referees:							
-----------	--	--	--	--	--	--	--

KUMITE BOYS 11-12 YEARS -44KG

31ST KARATE GRAND PRIX CROATIA

2023-01-22

Tatami
3 17:15

Pool
1

(c)sportdata GmbH & Co KG 2000-2023 (2023-01-22 22:22) v 10.0.0 build 1 (2023-01-19) License: Online_Event_ID-6798_31STKARATEGRANDPRIXCROATIA (expire 2023-02-05)

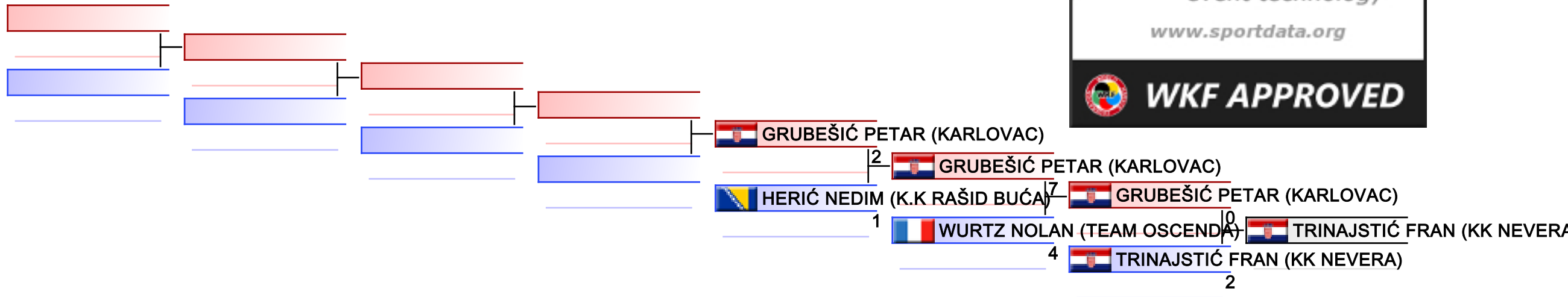

REPECHAGE: (1)

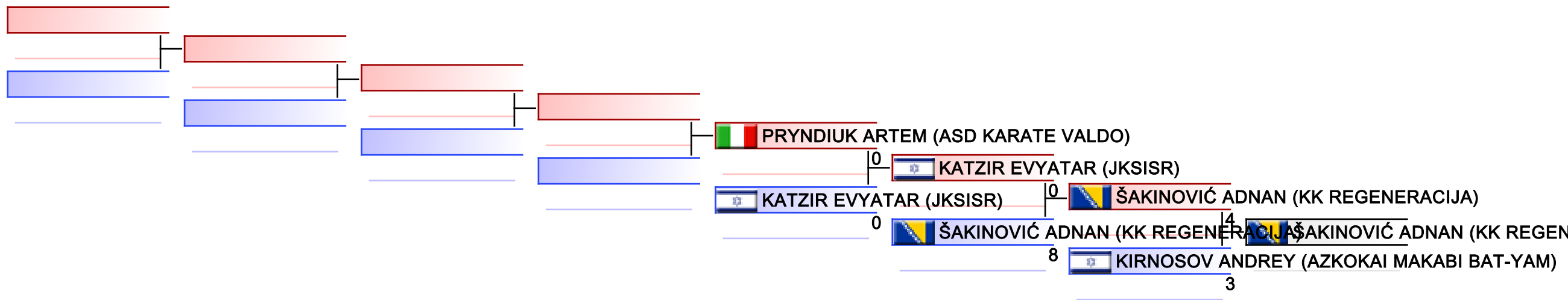

Referees:							
-----------	--	--	--	--	--	--	--

KUMITE BOYS 11-12 YEARS -49KG

31ST KARATE GRAND PRIX CROATIA

2023-01-22

Tatami
4 17:40

Pool
1

(c)sportdata GmbH & Co KG 2000-2023 (2023-01-22 22:22) v 10.0.0 build 1 (2023-01-19) License: Online_Event_ID-6798_31STKARATEGRANDPRIXCROATIA (expire 2023-02-05)

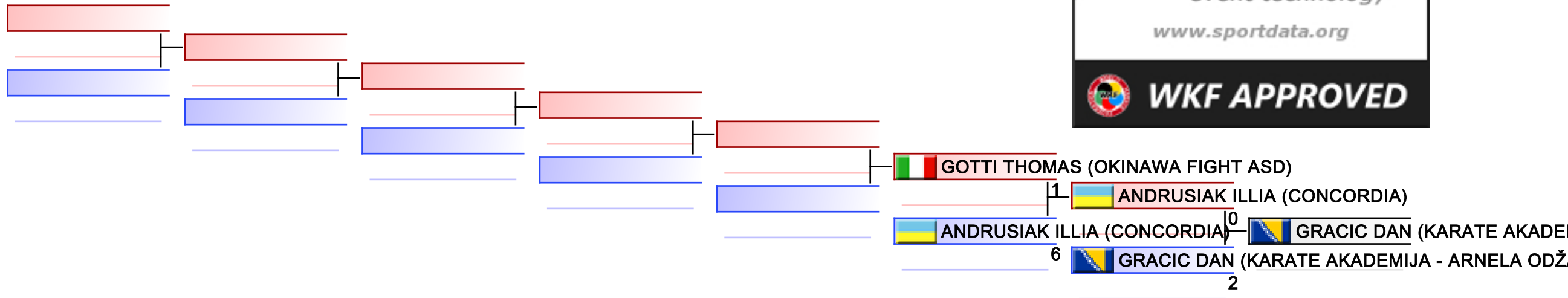

REPECHAGE: (1)

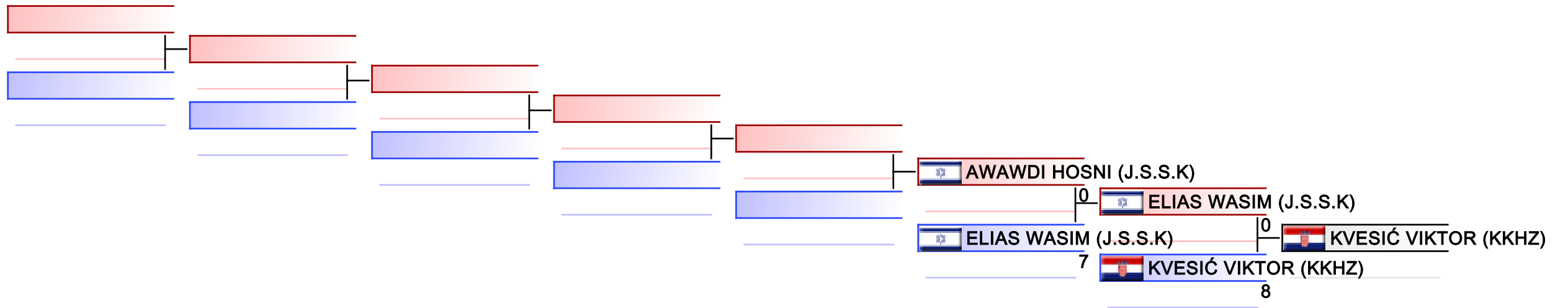

Referees:							
-----------	--	--	--	--	--	--	--

KUMITE BOYS 11-12 YEARS -54KG

31ST KARATE GRAND PRIX CROATIA

2023-01-22

Tatami
6 17:45

Pool
1

(c)sportdata GmbH & Co KG 2000-2023 (2023-01-22 22:22) v 10.0.0 build 1 (2023-01-19) License: Online_Event_ID-6798_31STKARATEGRANDPRIXCROATIA (expire 2023-02-05)



PIRVU RAFAEL (OKINAWA FIGHT ASD)
 0
 CONVERSINI SIMONE (MABUNI)
 5

REPECHAGE: (1)

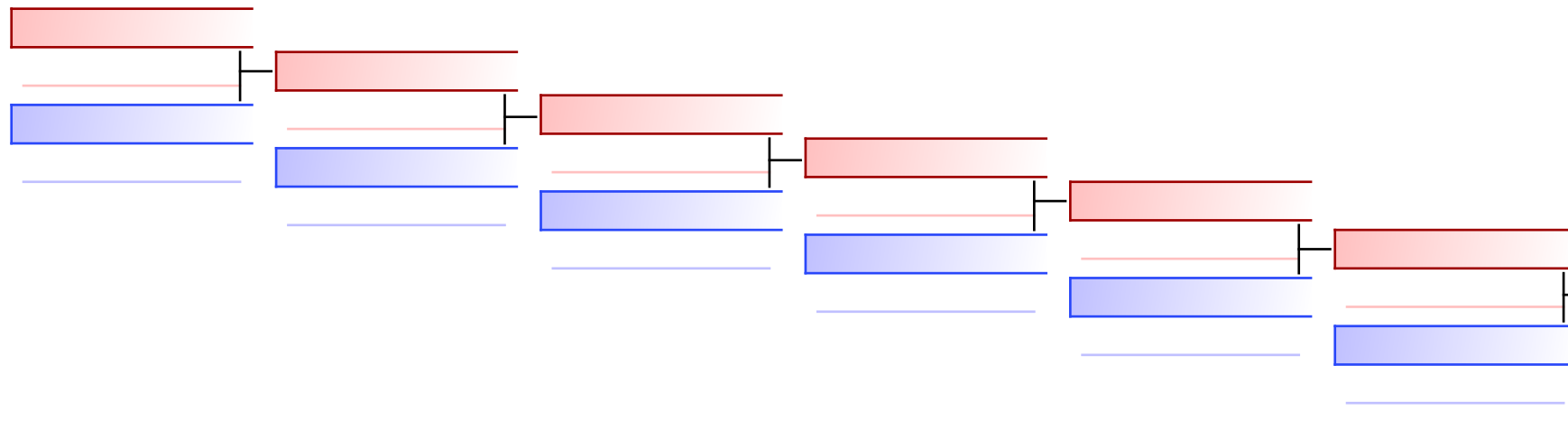

WISSAM ISSA (J.S.S.K)
 1
 ZUNDJA AMIR (KK SAMBON - VOGOSCA)
 6

Referees:							
-----------	--	--	--	--	--	--	--

KUMITE BOYS 13-14 YEARS +69KG

31ST KARATE GRAND PRIX CROATIA

2023-01-22

Tatami
6 18:15

Pool
1

(c)sportdata GmbH & Co KG 2000-2023 (2023-01-22 22:22) v 10.0.0 build 1 (2023-01-19) License: Online_Event_ID-6798_31STKARATEGRANDPRIXCROATIA (expire 2023-02-05)

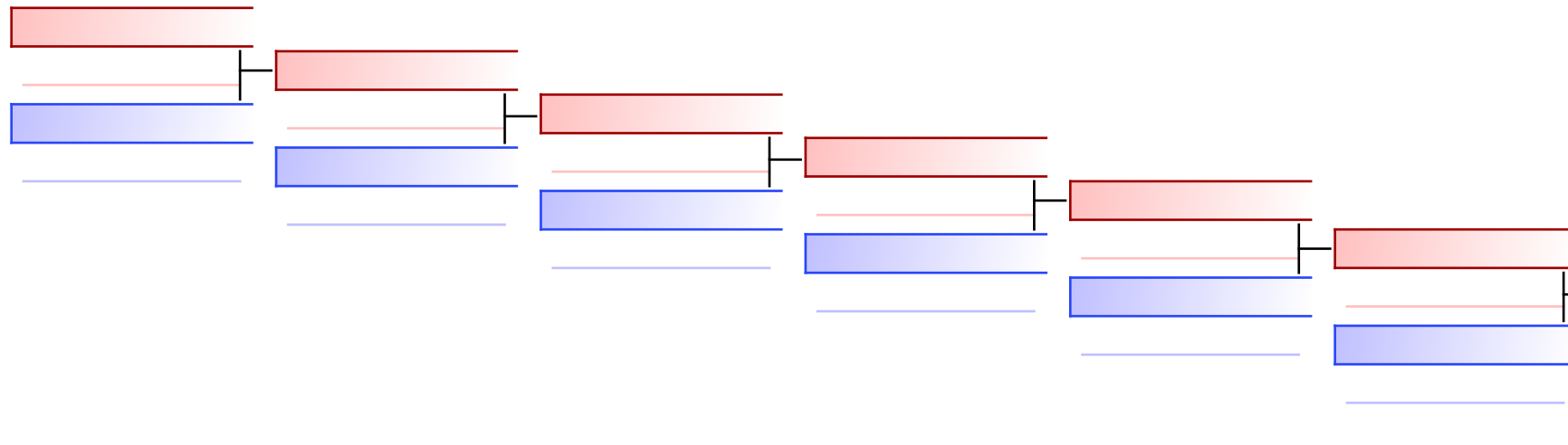

SAWAED TAREK (J.S.S.K)
1
 BERLUSCONI DAVIDE (CAO CA)
 BERLUSCONI DAVIDE (CAO CANTU)
6

REPECHAGE: (1)

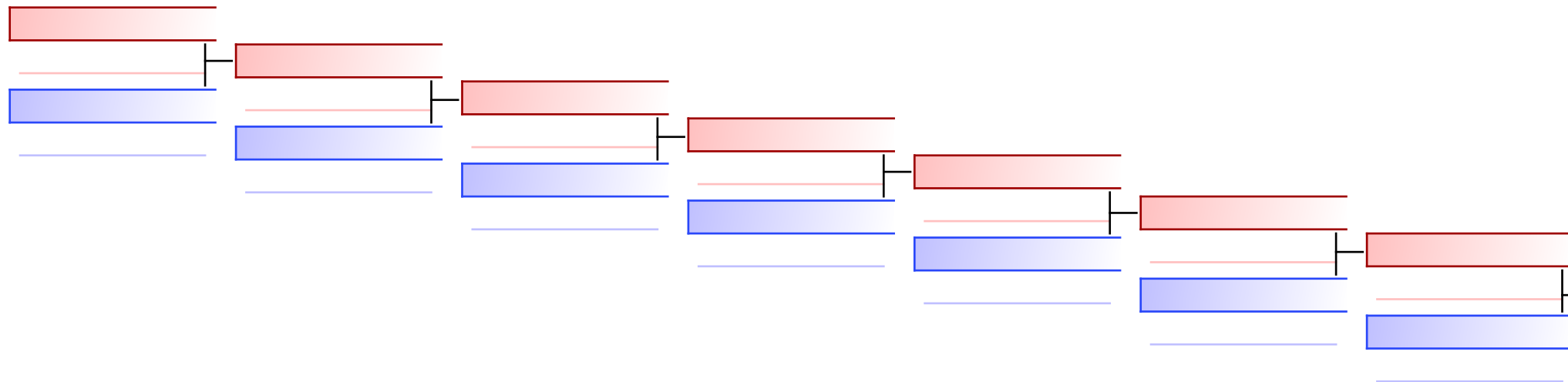

MAURO CRISTIAN (AK)

Referees:							
-----------	--	--	--	--	--	--	--

KUMITE BOYS 13-14 YEARS -44KG

31ST KARATE GRAND PRIX CROATIA

2023-01-22

Tatami
1 18:40

Pool
1

(c)sportdata GmbH & Co KG 2000-2023 (2023-01-22 22:22) v 10.0.0 build 1 (2023-01-19) License: Online_Event_ID-6798_31STKARATEGRANDPRIXCROATIA (expire 2023-02-05)

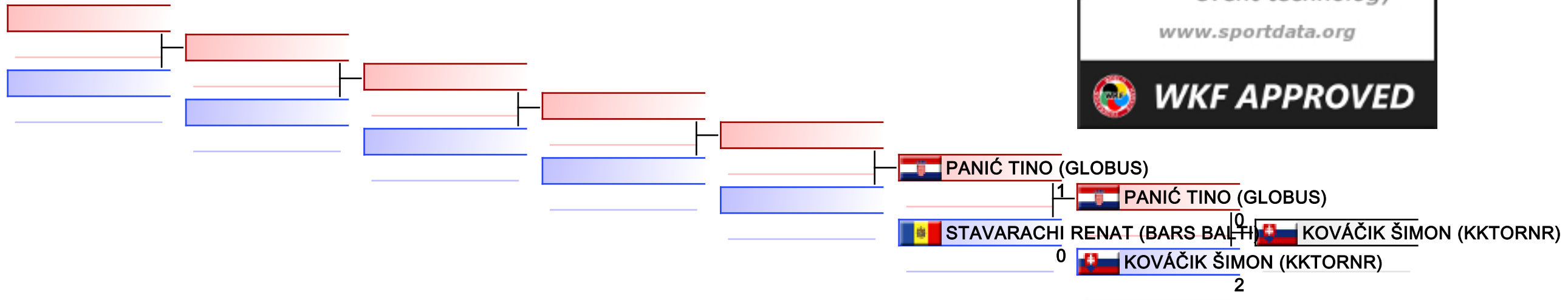

REPECHAGE: (1)

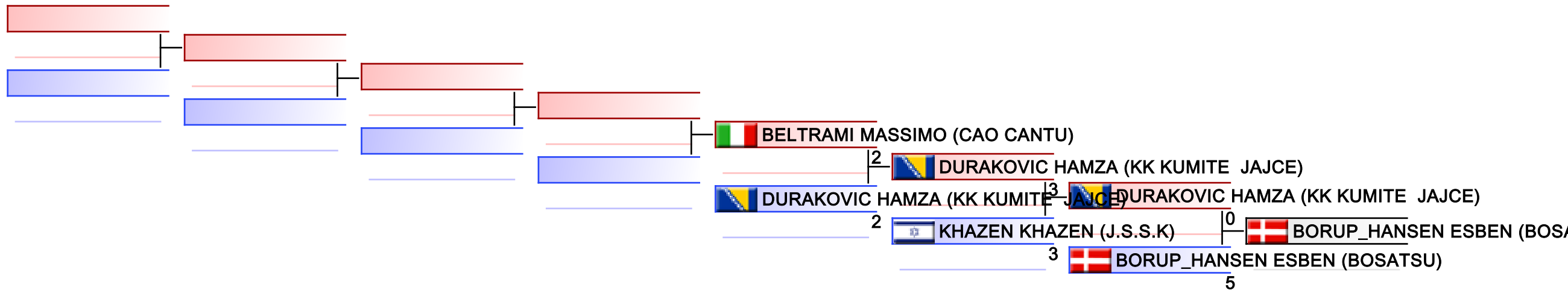

Referees:							
-----------	--	--	--	--	--	--	--

KUMITE BOYS 13-14 YEARS -49KG

31ST KARATE GRAND PRIX CROATIA

2023-01-22

Tatami
2 18:40

Pool
1

(c)sportdata GmbH & Co KG 2000-2023 (2023-01-22 22:22) v 10.0.0 build 1 (2023-01-19) License: Online_Event_ID-6798_31STKARATEGRANDPRIXCROATIA (expire 2023-02-05)

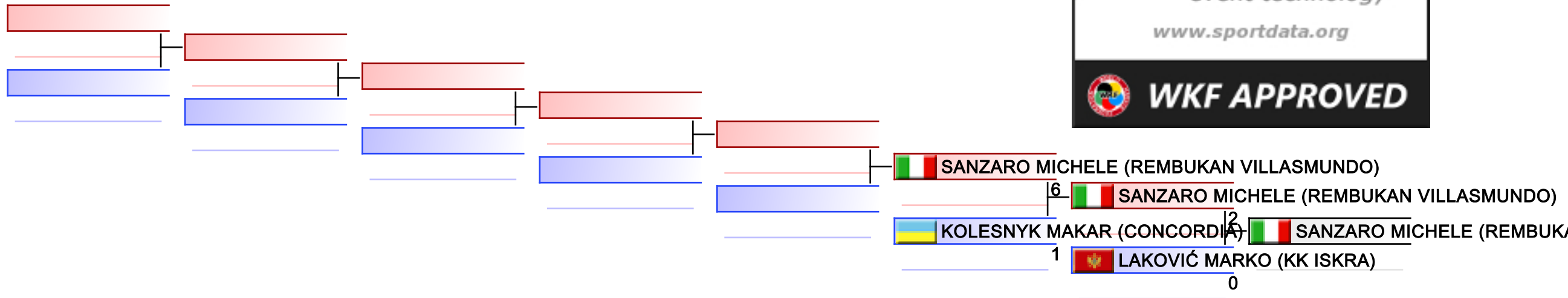

REPECHAGE: (1)

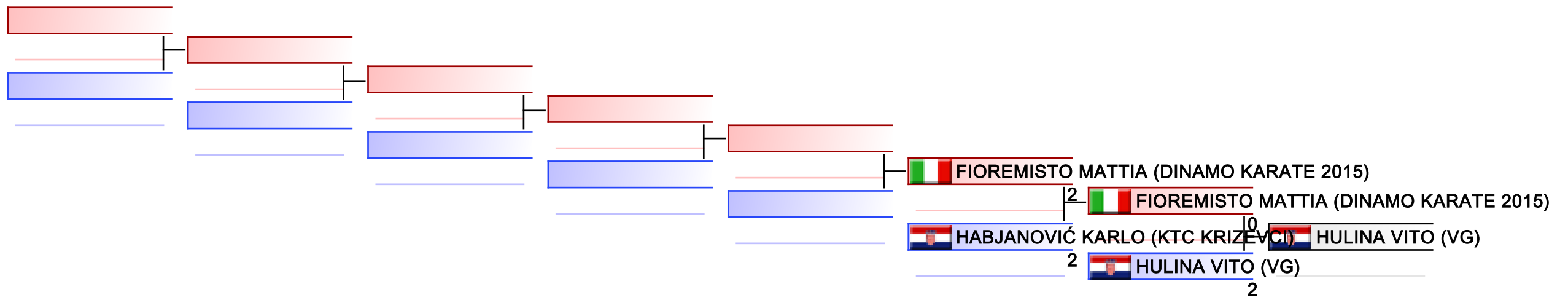

Referees:							
-----------	--	--	--	--	--	--	--

KUMITE BOYS 13-14 YEARS -54KG

31ST KARATE GRAND PRIX CROATIA

2023-01-22

Tatami
5 18:35

Pool
1

(c)sportdata GmbH & Co KG 2000-2023 (2023-01-22 22:22) v 10.0.0 build 1 (2023-01-19) License: Online_Event_ID-6798_31STKARATEGRANDPRIXCROATIA (expire 2023-02-05)

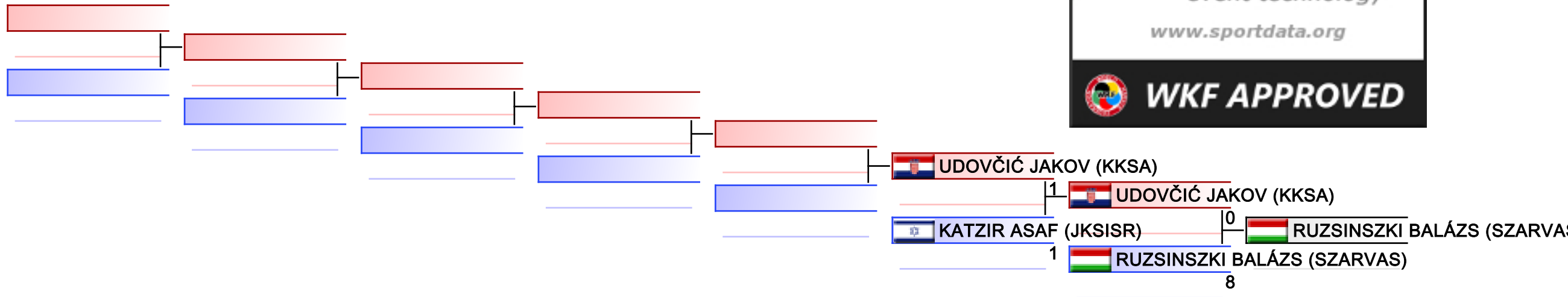

REPECHAGE: (1)

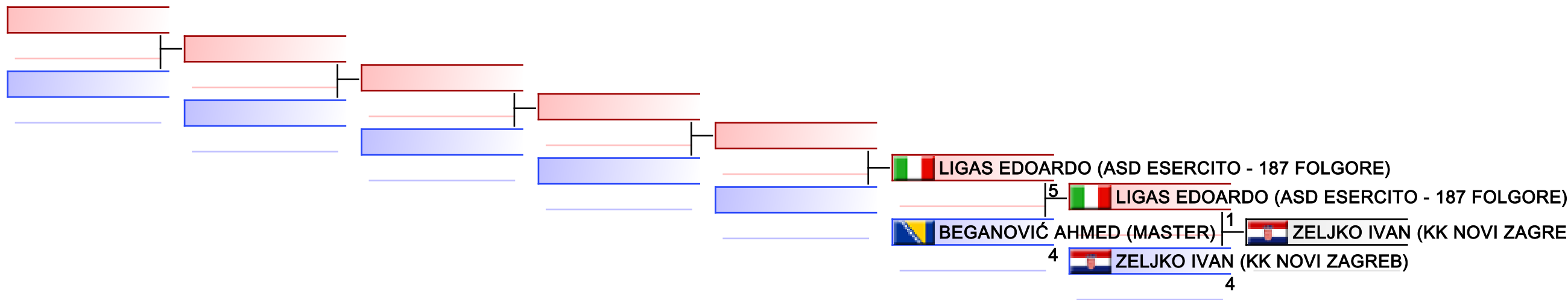

Referees:							
-----------	--	--	--	--	--	--	--

KUMITE BOYS 13-14 YEARS -59KG

31ST KARATE GRAND PRIX CROATIA

2023-01-22

Tatami
6 18:35

Pool
1

(c)sportdata GmbH & Co KG 2000-2023 (2023-01-22 22:22) v 10.0.0 build 1 (2023-01-19) License: Online_Event_ID-6798_31STKARATEGRANDPRIXCROATIA (expire 2023-02-05)

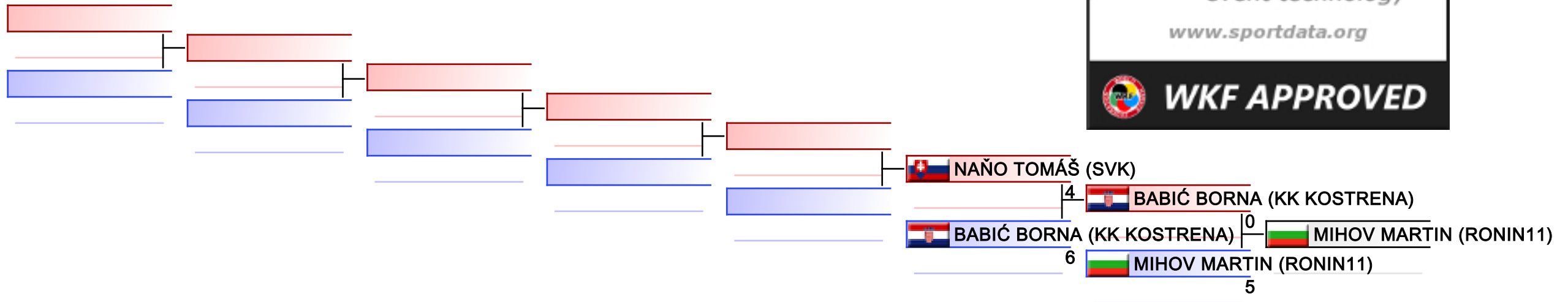

REPECHAGE: (1)

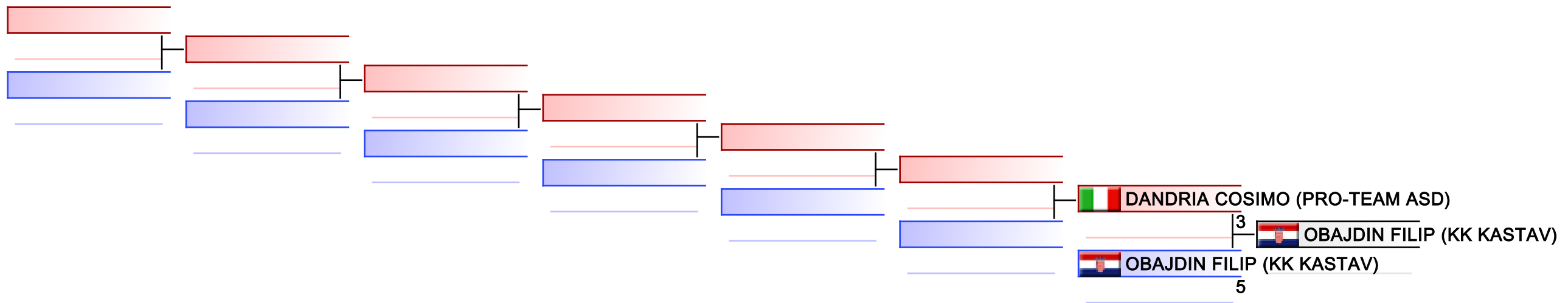

Referees:							
-----------	--	--	--	--	--	--	--

KUMITE BOYS 13-14 YEARS -64KG

31ST KARATE GRAND PRIX CROATIA

2023-01-22

Tatami
2 20:05

Pool
1

(c)sportdata GmbH & Co KG 2000-2023 (2023-01-22 22:22) v 10.0.0 build 1 (2023-01-19) License: Online_Event_ID-6798_31STKARATEGRANDPRIXCROATIA (expire 2023-02-05)

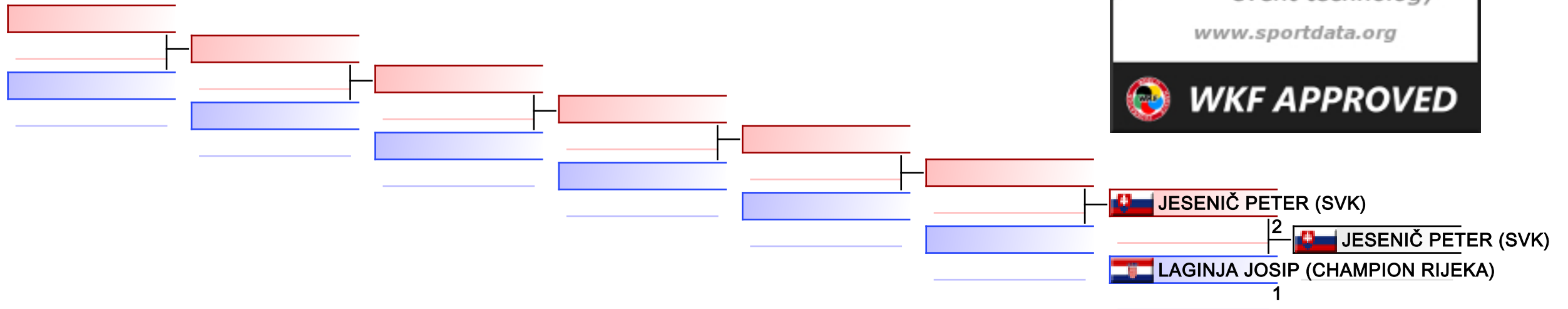

REPECHAGE: (1)

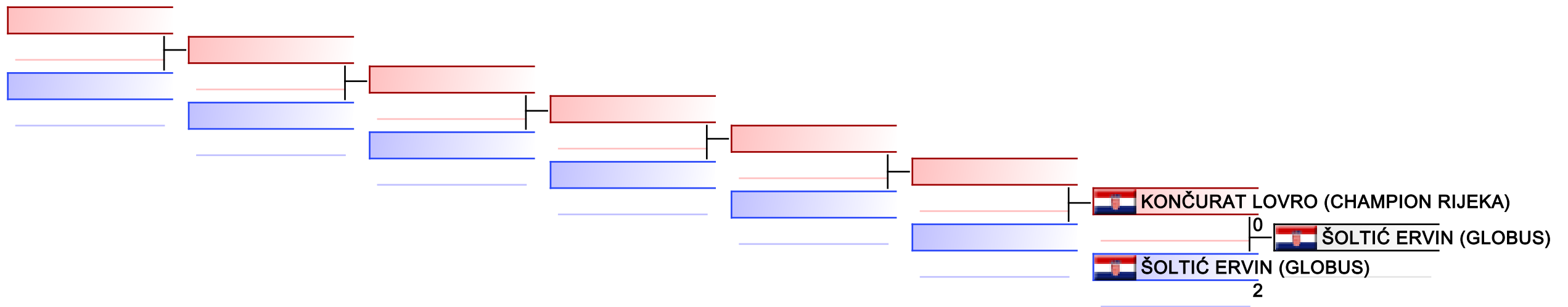

Referees:							
-----------	--	--	--	--	--	--	--