

# RESULTS BOOK

TAWASTIA OPEN KARATE 2/2024

2024.10.05 - 2024.10.05

LIIVUORENTIE 24, HÄMEENLINNA

FINLAND, FIN

[WWW.SPORTDATA.ORG](http://WWW.SPORTDATA.ORG)



## TABLE OF CONTENTS

|  |     |
|--|-----|
| NUMBER OF ENTRIES .....                      | 3   |
| ENTRYLIST .....                              | 4   |
| ENTRYLIST BY WEIGHT CATEGORY .....           | 14  |
| STATISTICS .....                             | 27  |
| NUMBER OF ENTRIES OFFICIALS .....            | 1   |
| ENTRYLIST OFFICIALS .....                    | 29  |
| SESSION STARTLISTS .....                     | 31  |
| SESSION RESULTS .....                        | 32  |
| KATA, MIEHET .....                           | 33  |
| KATA, MIEHET, +35-VUOTIAAT .....             | 61  |
| KATA, MIEHET, U21 .....                      | 69  |
| KATA, NAISSET .....                          | 45  |
| KATA, NAISSET, U21 .....                     | 74  |
| KATA, POJAT, U12 .....                       | 79  |
| KATA, POJAT, U14 .....                       | 93  |
| KATA, POJAT, U16 .....                       | 115 |
| KATA, POJAT, VALK-KELT, U10 .....            | 132 |
| KATA, POJAT, VALK-KELT, U12 .....            | 144 |
| KATA, POJAT, VALKOISET, U8 .....             | 154 |
| KATA, TYTÖT VALK-KELT, U14 .....             | 256 |
| KATA, TYTÖT, KELTAISET, U10 YHDISTETTY ..... | 241 |
| KATA, TYTÖT, U10 .....                       | 161 |
| KATA, TYTÖT, U12 .....                       | 168 |
| KATA, TYTÖT, U14 .....                       | 192 |
| KATA, TYTÖT, U16 .....                       | 211 |
| KATA, TYTÖT, U18 .....                       | 231 |
| KUMITE, MIEHET, AVOIN .....                  | 310 |
| KUMITE, MIEHET, +35-VUOTIAAT, +84 KG .....   | 266 |
| KUMITE, MIEHET, +75KG .....                  | 271 |



|  |     |
|--|-----|
| KUMITE, MIEHET, -75KG YHDISTETTY         | 281 |
| KUMITE, MIEHET, -84KG, +35-V YHDISTETTY  | 291 |
| KUMITE, MIEHET, U21, -75 KG              | 296 |
| KUMITE, MIEHET, U21, -84 KG              | 303 |
| KUMITE, NAISET, AVOIN                    | 325 |
| KUMITE, NAISET, U21, -68KG YHDISTETTY    | 320 |
| KUMITE, POJAT, U10                       | 330 |
| KUMITE, POJAT, U12, +42 KG               | 341 |
| KUMITE, POJAT, U12, -35 KG               | 351 |
| KUMITE, POJAT, U12, -42 KG               | 358 |
| KUMITE, POJAT, U14, +55 KG               | 377 |
| KUMITE, POJAT, U14, -40KG                | 387 |
| KUMITE, POJAT, U14, -45 KG               | 392 |
| KUMITE, POJAT, U14, -50 KG               | 403 |
| KUMITE, POJAT, U14, -55 KG               | 413 |
| KUMITE, POJAT, U16, +70 KG               | 420 |
| KUMITE, POJAT, U16, -52 KG               | 430 |
| KUMITE, POJAT, U16, -57 KG               | 440 |
| KUMITE, POJAT, U16, -63 KG               | 458 |
| KUMITE, POJAT, U16, -70 KG               | 470 |
| KUMITE, POJAT, U18, +68 KG YHDISTETTY    | 483 |
| KUMITE, POJAT, U18, -55 KG               | 488 |
| KUMITE, POJAT, U18, -61 KG               | 493 |
| KUMITE, POJAT, VALKOISET JA KELTAISET U8 | 54  |
| KUMITE, TYTÖT, U10 YHDISTETTY            | 503 |
| KUMITE, TYTÖT, U12, +40 KG               | 520 |
| KUMITE, TYTÖT, U12, -34 KG               | 534 |
| KUMITE, TYTÖT, U12, -40 KG               | 541 |
| KUMITE, TYTÖT, U14, +52 KG               | 551 |
| KUMITE, TYTÖT, U14, -42 KG               | 561 |
| KUMITE, TYTÖT, U14, -47 KG               | 566 |
| KUMITE, TYTÖT, U14, -52 KG               | 578 |
| KUMITE, TYTÖT, U16, +54 KG YHDISTETTY    | 585 |

|   |     |
|---|-----|
| KUMITE, TYTÖT, U16, -47 KG .....            | 595 |
| KUMITE, TYTÖT, U16, -54 KG .....            | 605 |
| KUMITE, TYTÖT, U18, +53KG YHDISTETTY .....  | 615 |
| KUMITE, TYTÖT, U18, -53 KG YHDISTETTY ..... | 625 |
| TEKNIikka U10 .....                         | 635 |
| TEKNIikka U14 YHDISTETTY .....              | 642 |
| TEKNIikka U9 YHDISTETTY .....               | 652 |
| OFFICIAL RESULTS .....                      | 659 |
| MEDAL STANDING .....                        | 670 |

# Tawastia Open Karate 2/2024

FINLAND

2024.10.05 - 2024.10.05

Liivuoentie 24, Hmeenlinna

## Participation List (by Club/Team)

| #              | Code | Club  | Male | Female | Total Entries | Total Athletes |
|----------------|------|---|------|--------|---------------|----------------|
| 1              | +    | FIN Budokwai ry Karate(Budokwai Karate)                 | 7    | 2      | 9             | 8              |
| 2              | +    | FIN Budoseura Imatran Kusanku ry(Imatran Kusanku)       | 3    | 3      | 6             | 6              |
| 3              | +    | FIN Budoseura Oulun Musokai Ry(Musokai)                 | 1    | 0      | 1             | 1              |
| 4              | +    | FIN Forssan-Tammelán Jundokan ry(FT-Jundokan)           | 2    | 0      | 2             | 1              |
| 5              | +    | FIN Hyvinkn Shotokan karate ry(Vesa)                    | 1    | 0      | 1             | 1              |
| 6              | +    | FIN Hmeenlinnan Karateseura(HKS)                        | 10   | 18     | 28            | 16             |
| 7              | +    | FIN JKS Finland - Shotokan Karate Helsinki(JKS Finland) | 12   | 9      | 21            | 13             |
| 8              | +    | FIN Japan Karate Association Tampere ry(JKA-Tampere)    | 9    | 7      | 16            | 13             |
| 9              | +    | FIN Jigotai Karate[2](Jigotai[2])                       | 14   | 5      | 19            | 11             |
| 10             | +    | FIN Joen Mawashi ry[3](JM[3])                           | 5    | 0      | 5             | 3              |
| 11             | +    | FIN Karate Combat Academy(Dumitru)                      | 2    | 0      | 2             | 2              |
| 12             | +    | FIN Korhonen(Korhonen)                                  | 0    | 1      | 1             | 1              |
| 13             | +    | FIN Kotka thaiboxing club(Ktbc)                         | 5    | 1      | 6             | 6              |
| 14             | +    | FIN Lahden Karate[2](LK-FIN[2])                         | 30   | 17     | 47            | 29             |
| 15             | +    | FIN Lakeuden Karate-Jutsu Ry[1](LKJ[1])                 | 1    | 0      | 1             | 1              |
| 16             | +    | FIN Lempln Shotokan Karate[1](JKA Lempl[1])             | 2    | 0      | 2             | 1              |
| 17             | +    | FIN Maksymuk[1](Maksymuk[1])                            | 0    | 4      | 4             | 2              |
| 18             | +    | FIN Nyknen(Nyknen)                                      | 0    | 2      | 2             | 1              |
| 19             | +    | FIN Oulun Karateseura(OKS)                              | 13   | 8      | 21            | 11             |
| 20             | +    | FIN Outokummun Karateseura ry[7](OKS[7])                | 7    | 0      | 7             | 2              |
| 21             | +    | FIN Pietil(Pietil)                                      | 0    | 2      | 2             | 2              |
| 22             | +    | FIN Porin Shotokan(JKA Pori)                            | 16   | 20     | 36            | 18             |
| 23             | +    | FIN Renshin-Kan ry(Renshi)                              | 8    | 1      | 9             | 7              |
| 24             | +    | FIN Shotokan Hervanta Ry(Karate Hervanta)               | 14   | 10     | 24            | 13             |
| 25             | +    | FIN Shuyokai Shotokan Karate-Do(Shuyokai)               | 2    | 1      | 3             | 3              |
| 26             | +    | FIN Sportskarate Kuopio(OM[2])                          | 10   | 3      | 13            | 10             |
| 27             | +    | FIN Sportskarate Pori[9](SKP[9])                        | 2    | 0      | 2             | 1              |
| 28             | +    | FIN Sportskarate.fi(SPF)                                | 4    | 12     | 16            | 9              |
| 29             | +    | FIN Tapanilan Er[1](Er[1])                              | 3    | 9      | 12            | 8              |
| 30             | +    | FIN Vantaan Wado Ryu ry(Wado Ryu ry)                    | 2    | 2      | 4             | 2              |
| <b>Totals:</b> |      |   | 185  | 137    | 322           | 202            |

# Tawastia Open Karate 2/2024

FINLAND  
Liivourentie 24, Hmeenlinna

2024.10.05 - 2024.10.05

## ENTRY LIST BY CLUB

### FINLAND

#### Budokwai ry Karate(Budokwai Karate)

| ID | Sex    | Family Name | Given Name  | Category                         |
|----|--------|-------------|-------------|----------------------------------|
| 1  | Male   | Algahawi    | Yakoot      | Kumite, pojat, U16, +70 kg       |
| 2  | Male   | Banauliker  | Kartik-Otto | Kumite, miehet, -75kg yhdistetty |
| 3  | Male   | Banauliker  | Kartik-Otto | Kumite, miehet, U21, -75 kg      |
| 4  | Female | Ebdul Eziz  | Eva         | Kumite, tytt, U12, +40 kg        |
| 5  | Male   | Grosu       | Nicolas     | Kumite, pojat, U10               |
| 6  | Male   | Heikkil     | Eliel       | Kumite, pojat, U12, +42 kg       |
| 7  | Male   | Ravyse      | Nathan      | Kumite, pojat, U10               |
| 8  | Male   | Sil         | Voitto      | Kumite, pojat, U16, -57 kg       |
| 9  | Female | Yakivets    | Ieva        | Kumite, tytt, U10 yhdistetty     |

Entries: 9

#### Budoseura Imatran Kusanku ry(Imatran Kusanku)

| ID | Sex    | Family Name | Given Name | Category                     |
|----|--------|-------------|------------|------------------------------|
| 10 | Female | Keskinen    | Emilia     | Kumite, tytt, U14, -47 kg    |
| 11 | Male   | Kullberg    | Adam       | Kumite, pojat, U12, +42 kg   |
| 12 | Female | Pohjalainen | Aura       | Kumite, tytt, U14, +52 kg    |
| 13 | Male   | Ralli       | Alexi      | Kumite, pojat, U12, -42 kg   |
| 14 | Female | Ruottinen   | Iina       | Kumite, tytt, U10 yhdistetty |
| 15 | Male   | Ruottinen   | Roope      | Kumite, pojat, U14, -40kg    |

Entries: 6

#### Budoseura Oulun Musokai Ry(Musokai)

| ID | Sex  | Family Name | Given Name | Category                   |
|----|------|-------------|------------|----------------------------|
| 16 | Male | Hannu       | Aarre      | Kumite, pojat, U12, -42 kg |

Entries: 1

#### Forssan-Tammelän Jundokan ry(FT-Jundokan)

| ID | Sex  | Family Name | Given Name | Category              |
|----|------|-------------|------------|-----------------------|
| 17 | Male | Sura        | Juha-Pekka | Kumite, miehet, avoin |
| 18 | Male | Sura        | Juha-Pekka | Kumite, miehet, +75kg |

Entries: 2

#### Hyvinkn Shotokan karate ry(Vesa)

| ID | Sex  | Family Name | Given Name | Category         |
|----|------|-------------|------------|------------------|
| 19 | Male | Pullianen   | Matias     | Kata, pojat, U14 |

Entries: 1

#### Hmeenlinnan Karateseura(HKS)

| ID | Sex    | Family Name | Given Name | Category                              |
|----|--------|-------------|------------|---------------------------------------|
| 20 | Female | Abdelmoaty  | Jasmiina   | Tekniikka U9 yhdistetty               |
| 21 | Female | Abdelmoaty  | Sara       | Kumite, tytt, U10 yhdistetty          |
| 22 | Female | Abdelmoaty  | Sara       | Kata, tytt, keltaiset, U10 yhdistetty |

# Tawastia Open Karate 2/2024

FINLAND  
Liivourentie 24, Hmeenlinna

2024.10.05 - 2024.10.05

## ENTRY LIST BY CLUB

| Hmeenlinnan Karateseura(HKS) |        |             |            |                                       |  |
|------------------------------|--------|-------------|------------|---------------------------------------|--|
| ID                           | Sex    | Family Name | Given Name | Category                              |  |
| 23                           | Female | Hakala      | Hanna      | Kumite, tytt, U12, -40 kg             |  |
| 24                           | Female | Hakala      | Hanna      | Kata, tytt, U12                       |  |
| 25                           | Female | Hakala      | Helena     | Kata, tytt, keltaiset, U10 yhdistetty |  |
| 26                           | Female | Hakala      | Helena     | Tekniikka U9 yhdistetty               |  |
| 27                           | Female | Hakala      | Heli       | Kata, tytt, keltaiset, U10 yhdistetty |  |
| 28                           | Female | Hakala      | Heli       | Kumite, tytt, U10 yhdistetty          |  |
| 29                           | Female | Jokinen     | Helmi      | Kumite, tytt, U16, +54 kg yhdistetty  |  |
| 30                           | Female | Jokinen     | Helmi      | Kumite, tytt, U18, +53kg yhdistetty   |  |
| 31                           | Male   | Kettunen    | Eemeli     | Kumite, pojat, U18, -55 kg            |  |
| 32                           | Male   | Kettunen    | Eemeli     | Kumite, pojat, U16, -52 kg            |  |
| 33                           | Female | Kuusi       | Nika       | Kata, tytt, U16                       |  |
| 34                           | Female | Kuusi       | Nika       | Kata, tytt, U18                       |  |
| 35                           | Male   | Mantere     | Jimi       | Kumite, pojat, U18, +68 kg yhdistetty |  |
| 36                           | Male   | Mantere     | Jimi       | Kumite, miehet, U21, -84 kg           |  |
| 37                           | Male   | Mantere     | Jimi       | Kata, miehet, U21                     |  |
| 38                           | Female | Mkel        | Jenna      | Kata, tytt, U12                       |  |
| 39                           | Female | Naskali     | Jatta      | Kata, tytt, U12                       |  |
| 40                           | Male   | Piikkil     | Onni       | Kata, pojat, U14                      |  |
| 41                           | Female | Pirinen     | Mila       | TEKNIikka U14 yhdistetty              |  |
| 42                           | Female | Pirinen     | Mila       | Kata, tytt valk-kelt, U14             |  |
| 43                           | Female | Salo        | Aleksandra | Kata, tytt, U14                       |  |
| 44                           | Female | Sova        | Elina      | Kata, tytt valk-kelt, U14             |  |
| 45                           | Female | Sova        | Elina      | TEKNIikka U14 yhdistetty              |  |
| 46                           | Female | Tammela     | litu       | Kata, tytt, U18                       |  |
| 47                           | Female | Tammela     | litu       | Kata, tytt, U16                       |  |

Entries: 28

| Japan Karate Association Tampere ry(JKA-Tampere) |        |             |            |                                       |  |
|--|--------|-------------|------------|---------------------------------------|--|
| ID   | Sex    | Family Name | Given Name | Category                              |  |
| 48   | Male   | Ahvonen     | Atte       | Kumite, pojat, U18, -68 kg            |  |
| 49   | Female | Coman       | Anastasia  | Kata, tytt valk-kelt, U14             |  |
| 50   | Female | Coman       | Anastasia  | Kumite, tytt, U14, +52 kg             |  |
| 51   | Female | Hintikka    | Maria      | KATA, NAISSET                         |  |
| 52   | Male   | Jrvinen     | Otso       | KATA, MIEHET                          |  |
| 53   | Male   | Kreus       | Petrus     | Kumite, pojat, U18, +68 kg yhdistetty |  |
| 54   | Female | Lantta      | Wiivi      | Kata, naiset, U21                     |  |
| 55   | Male   | Muurinaho   | Luka       | Kumite, pojat, U16, -52 kg            |  |
| 56   | Male   | Nuhanovic   | Alsad      | Kumite, miehet, U21, -84 kg           |  |
| 57   | Female | Nuhanovic   | Amina      | Kumite, tytt, U12, +40 kg             |  |
| 58   | Female | Nuhanovic   | Amina      | Kata, tytt, U12                       |  |
| 59   | Female | Nuhanovic   | Haska      | Kumite, tytt, U16, -47 kg             |  |
| 60   | Male   | Peltola     | Veikko     | Kumite, miehet, -75kg yhdistetty      |  |
| 61   | Male   | Pihlajisto  | Pauli      | Kumite, pojat, U12, -42 kg            |  |
| 62   | Male   | Simola      | Teemu      | Kumite, miehet, avoin                 |  |
| 63   | Male   | Simola      | Teemu      | Kumite, miehet, +75kg                 |  |

Entries: 16

# Tawastia Open Karate 2/2024

FINLAND  
Liivourentie 24, Hmeenlinna

2024.10.05 - 2024.10.05

## ENTRY LIST BY CLUB

| Jigotai Karate(Jigotai) |        |             |            |  |  |
|-------------------------|--------|-------------|------------|--|--|
| ID                      | Sex    | Family Name | Given Name | Category                                 |  |
| 64                      | Female | Antinkaapo  | Nea        | Kumite, tytt, U14, -47 kg                |  |
| 65                      | Female | Antinkaapo  | Nea        | Kata, tytt, U14                          |  |
| 66                      | Female | Bryssy      | Mae        | Kumite, tytt, U16, +54 kg yhdistetty     |  |
| 67                      | Male   | Hanhinen    | Onni       | Kumite, pojat, U16, -57 kg               |  |
| 68                      | Male   | Hirvonen    | Jesse      | Kumite, pojat, U16, -57 kg               |  |
| 69                      | Male   | Hirvonen    | Jesse      | Kata, pojat, U16                         |  |
| 70                      | Male   | Pienimki    | Roope      | Kata, pojat, U16                         |  |
| 71                      | Male   | Pienimki    | Roope      | Kumite, pojat, U16, +70 kg               |  |
| 72                      | Male   | Pylvnen     | Anton      | Kumite, pojat, U16, -70 kg               |  |
| 73                      | Female | Riimala     | Seela      | Kata, tytt, U14                          |  |
| 74                      | Female | Riimala     | Seela      | Kumite, tytt, U14, -42 kg                |  |
| 75                      | Male   | Tarkkanen   | Otso       | Kumite, pojat, U16, -52 kg               |  |
| 76                      | Male   | Tarkkanen   | Otso       | Kata, pojat, U16                         |  |
| 77                      | Male   | Teppo       | Eino       | Kata, pojat, valkoiset, U8               |  |
| 78                      | Male   | Teppo       | Eino       | KUMITE, POJAT, VALKOISET JA KELTAISET U8 |  |
| 79                      | Male   | Teppo       | Vin        | Kata, pojat, valkoiset, U8               |  |
| 80                      | Male   | Teppo       | Vin        | KUMITE, POJAT, VALKOISET JA KELTAISET U8 |  |
| 81                      | Male   | Tkachenko   | Timofei    | Kata, pojat, U16                         |  |
| 82                      | Male   | Tkachenko   | Timofei    | Kumite, pojat, U16, -70 kg               |  |

Entries: 19

| JKS Finland - Shotokan Karate Helsinki(JKS Finland) |        |                 |              |                                      |  |
|---|--------|-----------------|--------------|--------------------------------------|--|
| ID  | Sex    | Family Name     | Given Name   | Category                             |  |
| 83  | Female | Alatalo         | Onerva       | KATA, NAISET                         |  |
| 84  | Female | Alatalo         | Onerva       | Kumite, tytt, U18, -53 kg yhdistetty |  |
| 85  | Female | Alatalo         | Onerva       | Kata, tytt, U18                      |  |
| 86  | Female | Alatalo         | Vanamo       | Kata, tytt, U14                      |  |
| 87  | Male   | Boke            | Erkan        | KATA, MIEHET                         |  |
| 88  | Male   | Casci           | Giangabriele | Kata, miehet, +35-vuotiaat           |  |
| 89  | Male   | Illanganthilake | Ishan        | Kumite, pojat, U16, -57 kg           |  |
| 90  | Male   | Kamamoto        | Keishiro     | Kumite, miehet, avoin                |  |
| 91  | Male   | Kamamoto        | Keishiro     | KATA, MIEHET                         |  |
| 92  | Male   | Kamamoto        | Keishiro     | Kumite, miehet, -75kg yhdistetty     |  |
| 93  | Male   | Larkin          | Chael        | Kumite, pojat, U10                   |  |
| 94  | Male   | Larkin          | Takehiro     | Kumite, pojat, U14, -50 kg           |  |
| 95  | Male   | Larkin          | Takehiro     | Kata, pojat, U14                     |  |
| 96  | Female | Meyke           | Alexandra    | Kata, tytt, U18                      |  |
| 97  | Female | Meyke           | Alexandra    | Kumite, tytt, U18, +53kg yhdistetty  |  |
| 98  | Male   | NOROUZI         | Arash Leon   | Kumite, pojat, U14, -55 kg           |  |
| 99  | Male   | NOROUZI         | Arash Leon   | Kata, pojat, U14                     |  |
| 100   | Female | Ortiz           | Antonia      | Kata, tytt, U14                      |  |
| 101   | Male   | Vink            | Jeffrey      | Kumite, miehet, avoin                |  |
| 102   | Female | Yamate          | Sakino       | Kumite, naiset, avoin                |  |
| 103   | Female | Yamate          | Sakino       | KATA, NAISET                         |  |

Entries: 21

# Tawastia Open Karate 2/2024

FINLAND  
Liivourentie 24, Hmeenlinna

2024.10.05 - 2024.10.05

## ENTRY LIST BY CLUB

| Joen Mawashi ry(JM) |      |             |            |                            |  |
|---------------------|------|-------------|------------|----------------------------|--|
| ID                  | Sex  | Family Name | Given Name | Category                   |  |
| 104                 | Male | Simonen     | Rene       | Kumite, pojat, U18, -61 kg |  |
| 105                 | Male | Simonen     | Rene       | Kumite, pojat, U16, -63 kg |  |
| 106                 | Male | Simonen     | Tino       | Kumite, pojat, U18, -55 kg |  |
| 107                 | Male | Simonen     | Tino       | Kumite, pojat, U16, -57 kg |  |
| 108                 | Male | Vartiainen  | Juuso      | Kumite, pojat, U16, -63 kg |  |

Entries: 5

| Karate Combat Academy(Dumitru) |      |             |            |                            |  |
|--------------------------------|------|-------------|------------|----------------------------|--|
| ID                             | Sex  | Family Name | Given Name | Category                   |  |
| 109                            | Male | Raiskinmki  | Aaron      | Kumite, pojat, U14, -45 kg |  |
| 110                            | Male | Raiskinmki  | Aatos      | Kumite, pojat, U12, -42 kg |  |

Entries: 2

| Korhonen(Korhonen) |        |             |            |                 |  |
|--------------------|--------|-------------|------------|-----------------|--|
| ID                 | Sex    | Family Name | Given Name | Category        |  |
| 111                | Female | Korhonen    | Meeri      | Kata, tytt, U10 |  |

Entries: 1

| Kotka thaiboxing club(Ktbc) |        |             |            |   |  |
|-----------------------------|--------|-------------|------------|---|--|
| ID                          | Sex    | Family Name | Given Name | Category                                |  |
| 112                         | Male   | Koskinen    | Sulo       | Kumite, pojat, U14, -45 kg              |  |
| 113                         | Female | Leisti      | Charuphat  | Kumite, tytt, U14, -52 kg               |  |
| 114                         | Male   | Leisti      | Pennueng   | Kumite, pojat, U12, -35 kg              |  |
| 115                         | Male   | Luukka      | Eki        | Kumite, miehet, -84kg, +35-v yhdistetty |  |
| 116                         | Male   | Luukka      | Erkko      | Kumite, pojat, U12, -42 kg              |  |
| 117                         | Male   | Luukka      | Erno       | Kumite, pojat, U10                      |  |

Entries: 6

| Lahden Karate(LK-FIN) |        |             |            |                                       |  |
|-----------------------|--------|-------------|------------|---------------------------------------|--|
| ID                    | Sex    | Family Name | Given Name | Category                              |  |
| 118                   | Female | Ahonen      | Venla      | Kata, tytt, U16                       |  |
| 119                   | Female | Asiala      | Erin       | Kata, tytt, U12                       |  |
| 120                   | Male   | Castrn      | Ossi       | Kata, pojat, valk-kelt, U10           |  |
| 121                   | Female | Elpi        | Amelia     | TEKNIKKKA U10                         |  |
| 122                   | Female | Elpi        | Amelia     | Kata, tytt, keltaiset, U10 yhdistetty |  |
| 123                   | Male   | Haakana     | Sisu       | Kata, pojat, valk-kelt, U10           |  |
| 124                   | Female | Haven       | Eevi       | TEKNIKKKA U10                         |  |
| 125                   | Female | Haven       | Eevi       | Kata, tytt, keltaiset, U10 yhdistetty |  |
| 126                   | Female | Haven       | Sara       | Kata, tytt, U16                       |  |
| 127                   | Male   | Huuskonen   | Veeti      | Kata, pojat, U16                      |  |
| 128                   | Male   | Huuskonen   | Veeti      | Kumite, pojat, U16, +70 kg            |  |
| 129                   | Male   | Joukainen   | Justus     | Kata, pojat, valk-kelt, U10           |  |
| 130                   | Male   | Joukainen   | Justus     | Kata, pojat, keltaiset, U10           |  |
| 131                   | Female | Kallio      | Sara       | Kata, tytt, U16                       |  |

# Tawastia Open Karate 2/2024

FINLAND  
Liivuoventie 24, Hmeenlinna

2024.10.05 - 2024.10.05

## ENTRY LIST BY CLUB

| Lahden Karate(LK-FIN) |        |             |            |                             |  |
|-----------------------|--------|-------------|------------|-----------------------------|--|
| ID                    | Sex    | Family Name | Given Name | Category                    |  |
| 132                   | Male   | Kanerva     | Niilo      | Kata, pojat, U12            |  |
| 133                   | Male   | Kekki       | Akseli     | Kata, pojat, valk-kelt, U12 |  |
| 134                   | Male   | Kekki       | Akseli     | TEKNIKKKA U14 yhdistetty    |  |
| 135                   | Male   | Kella       | Kasper     | Kumite, pojat, U14, -50 kg  |  |
| 136                   | Male   | Kella       | Kasper     | Kata, pojat, U14            |  |
| 137                   | Female | Kinnunen    | Anni       | Kata, tytt, U14             |  |
| 138                   | Male   | Kivikoski   | Jere       | Kata, pojat, U16            |  |
| 139                   | Male   | Kivikoski   | Jere       | Kumite, pojat, U16, +70 kg  |  |
| 140                   | Male   | Kivimki     | Veikko     | Kata, pojat, U16            |  |
| 141                   | Male   | Kivimki     | Veikko     | Kumite, pojat, U16, -63 kg  |  |
| 142                   | Female | Lehtinen    | Nea        | KATA, NAISSET               |  |
| 143                   | Female | Lehtinen    | Nea        | Kata, naiset, U21           |  |
| 144                   | Male   | Lehto       | Eemeli     | Kata, pojat, U14            |  |
| 145                   | Male   | Lehto       | Eemeli     | Kumite, pojat, U14, +55 kg  |  |
| 146                   | Female | Lindstrm    | Meri       | Kata, tytt, U16             |  |
| 147                   | Male   | Paukkola    | Nooa       | Kumite, miehet, U21, avoin  |  |
| 148                   | Male   | Paukkola    | Nooa       | Kumite, miehet, avoin       |  |
| 149                   | Male   | Paukkola    | Nooa       | Kumite, miehet, U21, -84 kg |  |
| 150                   | Female | Pyhnen      | lida       | Kumite, tytt, U14, -47 kg   |  |
| 151                   | Female | Pyhnen      | lida       | Kata, tytt, U14             |  |
| 152                   | Male   | Repo        | Leo        | TEKNIKKKA U10               |  |
| 153                   | Male   | Repo        | Leo        | Kata, pojat, valk-kelt, U10 |  |
| 154                   | Male   | Salmensuu   | Toivo      | Kumite, pojat, U14, -50 kg  |  |
| 155                   | Male   | Salmensuu   | Toivo      | Kata, pojat, U14            |  |
| 156                   | Female | Salminen    | Wenla      | TEKNIKKKA U14 yhdistetty    |  |
| 157                   | Female | Salminen    | Wenla      | Kata, tytt valk-kelt, U14   |  |
| 158                   | Male   | Sihvonen    | Eemil      | Kata, pojat, U14            |  |
| 159                   | Female | Stefanski   | Vanessa    | Kumite, tytt, U14, -52 kg   |  |
| 160                   | Female | Stefanski   | Vanessa    | Kata, tytt, U14             |  |
| 161                   | Female | Stefanski   | Vanessa    | Kumite, tytt, U16, -54 kg   |  |
| 162                   | Female | Temonen     | Hilma      | Kata, tytt, U16             |  |
| 163                   | Male   | Tuomisalo   | Rasmus     | Kata, pojat, valk-kelt, U10 |  |
| 164                   | Male   | Vnttinen    | Aleksi     | Kata, pojat, valk-kelt, U12 |  |

Entries: 47

| Lakeuden Karate-Jutsu Ry(LKJ) |      |             |            |                            |  |
|-------------------------------|------|-------------|------------|----------------------------|--|
| ID                            | Sex  | Family Name | Given Name | Category                   |  |
| 165                           | Male | Keltto      | Topias     | Kumite, pojat, U16, -63 kg |  |

Entries: 1

| Lempi Shotokan Karate(JKA Lempi) |      |             |            |                                      |  |
|----------------------------------|------|-------------|------------|--------------------------------------|--|
| ID                               | Sex  | Family Name | Given Name | Category                             |  |
| 166                              | Male | Vlimki      | Risto      | Kumite, miehet, +75kg                |  |
| 167                              | Male | Vlimki      | Risto      | Kumite, miehet, +35-vuotiaat, +84 kg |  |

Entries: 2



# Tawastia Open Karate 2/2024

FINLAND  
Liivourentie 24, Hmeenlinna

2024.10.05 - 2024.10.05

## ENTRY LIST BY CLUB

| Maksymuk(Maksymuk) |        |             |            |                              |  |
|--------------------|--------|-------------|------------|------------------------------|--|
| ID                 | Sex    | Family Name | Given Name | Category                     |  |
| 168                | Female | MAKSYMUK    | POLINA     | Kata, tytt, U12              |  |
| 169                | Female | MAKSYMUK    | POLINA     | Kumite, tytt, U12, +40 kg    |  |
| 170                | Female | MAKSYMUK    | ULIANA     | Kata, tytt, U10              |  |
| 171                | Female | MAKSYMUK    | ULIANA     | Kumite, tytt, U10 yhdistetty |  |

Entries: 4

| Nyknen(Nyknen) |        |             |            |                           |  |
|----------------|--------|-------------|------------|---------------------------|--|
| ID             | Sex    | Family Name | Given Name | Category                  |  |
| 172            | Female | Nyknen      | Tara       | Kumite, tytt, U12, -34 kg |  |
| 173            | Female | Nyknen      | Tara       | Kata, tytt, U12           |  |

Entries: 2

| Oulun Karateseura(OKS) |        |             |            |  |  |
|------------------------|--------|-------------|------------|--|--|
| ID                     | Sex    | Family Name | Given Name | Category                                 |  |
| 174                    | Female | Hannu       | Alva       | Kumite, tytt, U16, -47 kg                |  |
| 175                    | Female | Hannu       | Alva       | Kata, tytt, U18                          |  |
| 176                    | Female | Hannu       | Alva       | Kata, tytt, U16                          |  |
| 177                    | Male   | Hannu       | Eero       | Kumite, pojat, U14, -55 kg               |  |
| 178                    | Male   | Hannu       | Eero       | Kata, pojat, U14                         |  |
| 179                    | Female | Kentt       | Hilda      | Kumite, tytt, U16, -47 kg                |  |
| 180                    | Female | Korpela     | Siiri      | Kumite, tytt, U16, +54 kg yhdistetty     |  |
| 181                    | Female | Korpela     | Siiri      | Kata, tytt, U16                          |  |
| 182                    | Female | Lhetkangas  | Emma       | Kata, tytt, keltaiset, U10 yhdistetty    |  |
| 183                    | Female | Lhetkangas  | Emma       | Kumite, tytt, U10 yhdistetty             |  |
| 184                    | Male   | Lhetkangas  | Luka       | Kata, pojat, U16                         |  |
| 185                    | Male   | Lhetkangas  | Luka       | Kumite, pojat, U16, -70 kg               |  |
| 186                    | Male   | Takala      | Akseli     | Kata, miehet, U21                        |  |
| 187                    | Male   | Takala      | Akseli     | KATA, MIEHET                             |  |
| 188                    | Male   | Takala      | Anton      | Kumite, pojat, U16, -63 kg               |  |
| 189                    | Male   | Takala      | Anton      | Kumite, pojat, U14, +55 kg               |  |
| 190                    | Male   | Tejesvi     | Shashank   | Kumite, pojat, U12, -42 kg               |  |
| 191                    | Male   | Tejesvi     | Shashank   | Kata, pojat, U12                         |  |
| 192                    | Male   | Tejesvi     | Vivaan     | KUMITE, POJAT, VALKOISET JA KELTAISET U8 |  |
| 193                    | Male   | Tejesvi     | Vivaan     | Kata, pojat, valkoiset, U8               |  |
| 194                    | Male   | Vaara       | Santeri    | Kumite, pojat, U16, -57 kg               |  |

Entries: 21

| Outokummun Karateseura ry(OKS) |      |             |            |                                      |  |
|--------------------------------|------|-------------|------------|--------------------------------------|--|
| ID                             | Sex  | Family Name | Given Name | Category                             |  |
| 195                            | Male | Hrknen      | Jarno      | KATA, MIEHET                         |  |
| 196                            | Male | Hrknen      | Jarno      | Kata, miehet, +35-vuotiaat           |  |
| 197                            | Male | Hrknen      | Jarno      | Kumite, miehet, +35-vuotiaat, +84 kg |  |
| 198                            | Male | Hrknen      | Jarno      | Kumite, miehet, +46-vuotiaat, +84 kg |  |
| 199                            | Male | Hrknen      | Jarno      | Kumite, miehet, +75kg                |  |

# Tawastia Open Karate 2/2024

FINLAND  
Liivourentie 24, Hmeenlinna

2024.10.05 - 2024.10.05

## ENTRY LIST BY CLUB

| Outokummun Karateseura ry(OKS) |      |             |            |                            |  |
|--------------------------------|------|-------------|------------|----------------------------|--|
| ID                             | Sex  | Family Name | Given Name | Category                   |  |
| 200                            | Male | Oinonen     | Ville      | Kata, miehet, +35-vuotiaat |  |
| 201                            | Male | Oinonen     | Ville      | KATA, MIEHET               |  |

Entries: 7

| Pietil(Pietil) |        |             |            |                 |  |
|----------------|--------|-------------|------------|-----------------|--|
| ID             | Sex    | Family Name | Given Name | Category        |  |
| 202            | Female | Mustonen    | Amanda     | Kata, tytt, U14 |  |
| 203            | Female | Pietil      | Hilda      | Kata, tytt, U16 |  |

Entries: 2

| Porin Shotokan(JKA Pori) |        |             |            |                                       |  |
|--------------------------|--------|-------------|------------|---------------------------------------|--|
| ID                       | Sex    | Family Name | Given Name | Category                              |  |
| 204                      | Female | Chudina     | Alisa      | Kumite, tytt, U10 yhdistetty          |  |
| 205                      | Female | Chudina     | Alisa      | Kata, tytt, keltaiset, U10 yhdistetty |  |
| 206                      | Male   | Gaetti      | Lucas      | Kata, pojat, U16                      |  |
| 207                      | Male   | Gaetti      | Lucas      | Kumite, pojat, U16, -63 kg            |  |
| 208                      | Female | Heinnen     | Vanessa    | Kumite, tytt, U12, +40 kg             |  |
| 209                      | Female | Heinnen     | Vanessa    | Kata, tytt, U12                       |  |
| 210                      | Male   | Hietava     | Anton      | Kumite, pojat, U12, -42 kg            |  |
| 211                      | Male   | Hietava     | Anton      | Kata, pojat, valk-kelt, U12           |  |
| 212                      | Male   | Kalliomki   | Viljami    | Kumite, pojat, U14, -45 kg            |  |
| 213                      | Male   | Kalliomki   | Viljami    | Kata, pojat, U14                      |  |
| 214                      | Female | Keskimki    | Fanni      | Kata, tytt, keltaiset, U10 yhdistetty |  |
| 215                      | Female | Keskimki    | Fanni      | Kumite, tytt, U10 yhdistetty          |  |
| 216                      | Female | Koskela     | Jasmin     | Kata, tytt, U12                       |  |
| 217                      | Female | Koskela     | Jasmin     | Kumite, tytt, U12, +40 kg             |  |
| 218                      | Female | Lehtiniemi  | Erin       | Kata, tytt, U12                       |  |
| 219                      | Female | Lehtiniemi  | Erin       | Kumite, tytt, U12, +40 kg             |  |
| 220                      | Female | Lindroos    | Emilia     | Kata, tytt, U12                       |  |
| 221                      | Female | Lindroos    | Emilia     | Kumite, tytt, U12, -40 kg             |  |
| 222                      | Female | Mustafina   | Sofia      | Kata, tytt, U16                       |  |
| 223                      | Female | Mustafina   | Sofia      | Kumite, tytt, U16, -47 kg             |  |
| 224                      | Male   | Nummijrvi   | Luukas     | Kata, pojat, U14                      |  |
| 225                      | Male   | Nummijrvi   | Luukas     | Kumite, pojat, U14, +55 kg            |  |
| 226                      | Male   | Roihupalo   | Leo        | Kumite, pojat, U12, -42 kg            |  |
| 227                      | Male   | Roihupalo   | Leo        | Kata, pojat, U12                      |  |
| 228                      | Female | Sankari     | Nelli      | Kata, tytt, U12                       |  |
| 229                      | Female | Sankari     | Nelli      | Kumite, tytt, U12, -40 kg             |  |
| 230                      | Male   | Siivonen    | Kimi       | Kumite, pojat, U12, -42 kg            |  |
| 231                      | Male   | Siivonen    | Kimi       | Kata, pojat, U12                      |  |
| 232                      | Female | Syrjnen     | Lily       | Kumite, tytt, U16, -54 kg             |  |
| 233                      | Female | Syrjnen     | Lily       | Kata, tytt, U16                       |  |
| 234                      | Male   | Vainela     | Juho       | Kumite, pojat, U18, -61 kg            |  |
| 235                      | Male   | Vainela     | Juho       | Kumite, pojat, U18, -68 kg            |  |
| 236                      | Male   | Valve       | Vernereri  | Kata, pojat, U12                      |  |
| 237                      | Male   | Valve       | Vernereri  | Kumite, pojat, U12, +42 kg            |  |

# Tawastia Open Karate 2/2024

FINLAND  
Liivuoventie 24, Hmeenlinna

2024.10.05 - 2024.10.05

## ENTRY LIST BY CLUB

| Porin Shotokan(JKA Pori) |        |             |            |                           |  |
|--------------------------|--------|-------------|------------|---------------------------|--|
| ID                       | Sex    | Family Name | Given Name | Category                  |  |
| 238                      | Female | Veneranta   | Cecilia    | Kumite, tytt, U12, +40 kg |  |
| 239                      | Female | Veneranta   | Cecilia    | Kata, tytt, U12           |  |

Entries: 36

| Renshin-Kan ry(Renshi) |        |             |            |                                  |  |
|------------------------|--------|-------------|------------|----------------------------------|--|
| ID                     | Sex    | Family Name | Given Name | Category                         |  |
| 240                    | Female | Anttila     | Isabella   | Kumite, tytt, U14, -42 kg        |  |
| 241                    | Male   | Anttila     | Ken        | Kumite, pojat, U16, -52 kg       |  |
| 242                    | Male   | Anttila     | Paolo      | Kumite, pojat, U12, -42 kg       |  |
| 243                    | Male   | Hokka       | Mikko      | Kumite, pojat, U16, -70 kg       |  |
| 244                    | Male   | Hnninen     | Aarni      | Kumite, miehet, U21, -75 kg      |  |
| 245                    | Male   | Hnninen     | Aarni      | Kumite, miehet, -75kg yhdistetty |  |
| 246                    | Male   | Hnninen     | Niilo      | Kumite, miehet, U21, -75 kg      |  |
| 247                    | Male   | Hnninen     | Niilo      | Kumite, miehet, -75kg yhdistetty |  |
| 248                    | Male   | Mahmood     | Zohaib     | Kumite, pojat, U14, -45 kg       |  |

Entries: 9

| Shotokan Hervanta Ry(Karate Hervanta) |        |               |                 |                                       |  |
|---------------------------------------|--------|---------------|-----------------|---------------------------------------|--|
| ID                                    | Sex    | Family Name   | Given Name      | Category                              |  |
| 249                                   | Female | Anbar         | Hiba            | Kumite, tytt, U12, -34 kg             |  |
| 250                                   | Female | Anbar         | Hiba            | Kata, tytt, U12                       |  |
| 251                                   | Female | Arun          | Iisha           | Kata, tytt, U12                       |  |
| 252                                   | Female | Arun          | Iisha           | Kumite, tytt, U12, -34 kg             |  |
| 253                                   | Female | Batikeru      | Laasya          | Kumite, tytt, U10 yhdistetty          |  |
| 254                                   | Female | Batikeru      | Laasya          | Kata, tytt, U10                       |  |
| 255                                   | Female | Bhogadi       | Sreshta         | Tekniikka U9 yhdistetty               |  |
| 256                                   | Female | Bhogadi       | Sreshta         | Kata, tytt, keltaiset, U10 yhdistetty |  |
| 257                                   | Female | Hameeda Ahmed | Aisha           | Kumite, tytt, U14, +52 kg             |  |
| 258                                   | Female | Hameeda Ahmed | Aisha           | Kata, tytt valk-kelt, U14             |  |
| 259                                   | Male   | Lakka         | Teuvo           | Kumite, pojat, U12, -35 kg            |  |
| 260                                   | Male   | Lakka         | Teuvo           | Kata, pojat, U12                      |  |
| 261                                   | Male   | Palukuru      | Ronith          | Kumite, pojat, U12, +42 kg            |  |
| 262                                   | Male   | Palukuru      | Ronith          | Kata, pojat, U12                      |  |
| 263                                   | Female | Pelkonen      | Aune            | Kumite, tytt, U16, +54 kg yhdistetty  |  |
| 264                                   | Male   | Rawat         | Ritish Singh    | Kumite, pojat, U12, -35 kg            |  |
| 265                                   | Male   | Rawat         | Ritish Singh    | Kata, pojat, valk-kelt, U12           |  |
| 266                                   | Male   | Sudharsan     | Anirudh Gopalan | Kata, pojat, U12                      |  |
| 267                                   | Male   | Tsegenes      | Dimitris        | Kumite, pojat, U14, -40kg             |  |
| 268                                   | Male   | Tsegenes      | Dimitris        | Kata, pojat, U14                      |  |
| 269                                   | Male   | Zafar Ahmed   | Hasan           | Kata, pojat, valk-kelt, U10           |  |
| 270                                   | Male   | Zafar Ahmed   | Hasan           | Kumite, pojat, U10                    |  |
| 271                                   | Male   | Zia Ahmed     | Hamza           | Kumite, pojat, U12, +42 kg            |  |
| 272                                   | Male   | Zia Ahmed     | Hamza           | Kata, pojat, valk-kelt, U12           |  |

Entries: 24

# Tawastia Open Karate 2/2024

FINLAND  
Liivuoventie 24, Hmeenlinna

2024.10.05 - 2024.10.05

## ENTRY LIST BY CLUB

| Shuyokai Shotokan Karate-Do(Shuyokai) |        |             |            |                            |  |
|---------------------------------------|--------|-------------|------------|----------------------------|--|
| ID                                    | Sex    | Family Name | Given Name | Category                   |  |
| 273                                   | Male   | Forsten     | Niklas     | Kumite, pojat, U16, +70 kg |  |
| 274                                   | Female | Wanic       | Marie      | Kata, tytt, U16            |  |
| 275                                   | Male   | Wanic       | Mark       | Kata, pojat, U14           |  |

Entries: 3

| Sportskarate Kuopio(OM) |        |             |            |   |  |
|-------------------------|--------|-------------|------------|---|--|
| ID                      | Sex    | Family Name | Given Name | Category                                |  |
| 276                     | Male   | Huuskonen   | Kosti      | Kumite, pojat, U14, -50 kg              |  |
| 277                     | Female | Hyvnen      | Lila       | Kumite, tytt, U14, -47 kg               |  |
| 278                     | Male   | Lilja       | Dani       | Kumite, pojat, U12, -42 kg              |  |
| 279                     | Male   | Mattinen    | Nuutti     | Kumite, pojat, U14, -50 kg              |  |
| 280                     | Male   | Mattinen    | Nuutti     | Kumite, pojat, U16, -52 kg              |  |
| 281                     | Female | Rissanen    | Iina       | Kumite, tytt, U18, -53 kg yhdistetty    |  |
| 282                     | Female | Savolainen  | Elli       | Kumite, tytt, U12, +40 kg               |  |
| 283                     | Male   | Tameh       | Abdulkarim | Kumite, pojat, U14, -45 kg              |  |
| 284                     | Male   | Tameh       | Abdulkarim | Kumite, pojat, U14, +55 kg              |  |
| 285                     | Male   | Tameh       | Mohammed   | Kumite, pojat, U16, -57 kg              |  |
| 286                     | Male   | Turunen     | Timo       | Kumite, miehet, -84kg, +35-v yhdistetty |  |
| 287                     | Male   | Vyrynen     | Luukas     | Kumite, pojat, U18, -61 kg              |  |
| 288                     | Male   | Vyrynen     | Luukas     | Kumite, pojat, U16, -57 kg              |  |

Entries: 13

| Sportskarate Pori(SKP) |      |             |            |                            |  |
|------------------------|------|-------------|------------|----------------------------|--|
| ID                     | Sex  | Family Name | Given Name | Category                   |  |
| 289                    | Male | Jrvenp      | Tatu       | Kumite, pojat, U18, -61 kg |  |
| 290                    | Male | Jrvenp      | Tatu       | Kumite, pojat, U16, -57 kg |  |

Entries: 2

| Sportskarate.fi(SPF) |        |             |            |                                       |  |
|----------------------|--------|-------------|------------|---------------------------------------|--|
| ID                   | Sex    | Family Name | Given Name | Category                              |  |
| 291                  | Female | Chepelev    | Sofia      | Kumite, tytt, U16, -54 kg             |  |
| 292                  | Female | Chepelev    | Sofia      | Kumite, tytt, U18, -53 kg yhdistetty  |  |
| 293                  | Male   | Honkanen    | Santtu     | Kumite, pojat, U18, -68 kg            |  |
| 294                  | Male   | Honkanen    | Santtu     | Kumite, pojat, U16, -70 kg            |  |
| 295                  | Female | Itkonen     | Janika     | Kumite, tytt, U18, -53 kg yhdistetty  |  |
| 296                  | Female | Itkonen     | Janika     | Kumite, tytt, U16, -47 kg             |  |
| 297                  | Female | Koivula     | Sofia      | Kumite, naiset, U21, -68kg yhdistetty |  |
| 298                  | Female | Koivula     | Sofia      | Kumite, tytt, U18, +53kg yhdistetty   |  |
| 299                  | Male   | Lauronen    | Leo        | Kumite, pojat, U16, -57 kg            |  |
| 300                  | Male   | Lunin       | Adrian     | Kumite, pojat, U10                    |  |
| 301                  | Female | Luoma-ij    | Ellah      | Kumite, tytt, U10 yhdistetty          |  |
| 302                  | Female | Saadaoui    | Sonya      | Kumite, naiset, avoin                 |  |
| 303                  | Female | Saadaoui    | Sonya      | Kumite, naiset, U21, -68kg yhdistetty |  |
| 304                  | Female | Saadaoui    | Sonya      | Kumite, naiset, U21, avoin            |  |
| 305                  | Female | Saadaoui    | Sonya      | Kumite, naiset, -68 kg                |  |

# Tawastia Open Karate 2/2024

FINLAND  
Liivuoventie 24, Hmeenlinna

2024.10.05 - 2024.10.05

## ENTRY LIST BY CLUB

| Sportskarate.fi(SPF) |        |             |            |                                     |  |
|----------------------|--------|-------------|------------|-------------------------------------|--|
| ID                   | Sex    | Family Name | Given Name | Category                            |  |
| 306                  | Female | Saarnio     | Selja      | Kumite, tytt, U18, +53kg yhdistetty |  |

Entries: 16

| Tapanilan Er(Er) |        |             |            |                                      |  |
|------------------|--------|-------------|------------|--------------------------------------|--|
| ID               | Sex    | Family Name | Given Name | Category                             |  |
| 307              | Female | Heino       | Daisy      | Kata, tytt, U14                      |  |
| 308              | Female | Heino       | Daisy      | Kumite, tytt, U14, -47 kg            |  |
| 309              | Female | Heino       | Lilya      | Kata, tytt, U12                      |  |
| 310              | Female | Heino       | Lilya      | Kumite, tytt, U12, -40 kg            |  |
| 311              | Female | Kontio      | Venla      | Kumite, tytt, U14, +52 kg            |  |
| 312              | Female | Kontio      | Venla      | Kata, tytt, U14                      |  |
| 313              | Female | Lehtinen    | Eleanor    | Kumite, tytt, U16, -54 kg            |  |
| 314              | Female | Mertamo     | Amanda     | Kumite, tytt, U16, +54 kg yhdistetty |  |
| 315              | Female | Niemi       | Tova       | Kumite, tytt, U14, -52 kg            |  |
| 316              | Male   | Sipp        | Emil       | Kumite, pojat, U14, -45 kg           |  |
| 317              | Male   | Sipp        | Emil       | Kata, pojat, U14                     |  |
| 318              | Male   | Wolff       | Arn        | Kumite, pojat, U14, -55 kg           |  |

Entries: 12

| Vantaan Wado Ryu ry(Wado Ryu ry) |        |             |            |                            |  |
|----------------------------------|--------|-------------|------------|----------------------------|--|
| ID                               | Sex    | Family Name | Given Name | Category                   |  |
| 319                              | Male   | Sandgren    | Joona      | Kumite, pojat, U16, -57 kg |  |
| 320                              | Male   | Sandgren    | Joona      | Kata, pojat, U16           |  |
| 321                              | Female | Sember      | Vivi       | Kumite, tytt, U14, -47 kg  |  |
| 322                              | Female | Sember      | Vivi       | Kata, tytt, U14            |  |

Entries: 4

Total Entries:322

# Tawastia Open Karate 2/2024

FINLAND  
Liivuoventie 24, Hmeenlinna

2024.10.05 - 2024.10.05

## ENTRY LIST

### KATA, MIEHET

| CODE | Sex  | Family Name | Given Name | Club / Team / NOC                                   |
|------|------|-------------|------------|---|
| FIN  | Male | Boke        | Erkan      | JKS Finland - Shotokan Karate Helsinki(JKS Finland) |
| FIN  | Male | Hrknen      | Jarno      | Outokummun Karateseura ry(OKS)                      |
| FIN  | Male | Jrvinen     | Otso       | Japan Karate Association Tampere ry(JKA-Tampere)    |
| FIN  | Male | Kamamoto    | Keishiro   | JKS Finland - Shotokan Karate Helsinki(JKS Finland) |
| FIN  | Male | Oinonen     | Ville      | Outokummun Karateseura ry(OKS)                      |
| FIN  | Male | Takala      | Akseli     | Oulun Karateseura(OKS)                              |

Entries: 6

### Kata, miehet, +35-vuotiaat

| CODE | Sex  | Family Name | Given Name   | Club / Team / NOC                                   |
|------|------|-------------|--------------|---|
| FIN  | Male | Casci       | Giangabriele | JKS Finland - Shotokan Karate Helsinki(JKS Finland) |
| FIN  | Male | Hrknen      | Jarno        | Outokummun Karateseura ry(OKS)                      |
| FIN  | Male | Oinonen     | Ville        | Outokummun Karateseura ry(OKS)                      |

Entries: 3

### Kata, miehet, U21

| CODE | Sex  | Family Name | Given Name | Club / Team / NOC            |
|------|------|-------------|------------|------------------------------|
| FIN  | Male | Mantere     | Jimi       | Hmeenlinnan Karateseura(HKS) |
| FIN  | Male | Takala      | Akseli     | Oulun Karateseura(OKS)       |

Entries: 2

### KATA, NAISET

| CODE | Sex    | Family Name | Given Name | Club / Team / NOC                                   |
|------|--------|-------------|------------|---|
| FIN  | Female | Alatalo     | Onerva     | JKS Finland - Shotokan Karate Helsinki(JKS Finland) |
| FIN  | Female | Hintikka    | Maria      | Japan Karate Association Tampere ry(JKA-Tampere)    |
| FIN  | Female | Lehtinen    | Nea        | Lahden Karate(LK-FIN)                               |
| FIN  | Female | Yamate      | Sakino     | JKS Finland - Shotokan Karate Helsinki(JKS Finland) |

Entries: 4

### Kata, naiset, U21

| CODE | Sex    | Family Name | Given Name | Club / Team / NOC                                |
|------|--------|-------------|------------|--|
| FIN  | Female | Lantta      | Wiivi      | Japan Karate Association Tampere ry(JKA-Tampere) |
| FIN  | Female | Lehtinen    | Nea        | Lahden Karate(LK-FIN)                            |

Entries: 2

### Kata, pojat, keltaiset, U10

| CODE | Sex  | Family Name | Given Name | Club / Team / NOC     |
|------|------|-------------|------------|-----------------------|
| FIN  | Male | Joukainen   | Justus     | Lahden Karate(LK-FIN) |

Entries: 1

# Tawastia Open Karate 2/2024

FINLAND  
Liivuoventie 24, Hmeenlinna

2024.10.05 - 2024.10.05

## ENTRY LIST

### Kata, pojat, U12

| CODE | Sex  | Family Name | Given Name      | Club / Team / NOC                     |
|------|------|-------------|-----------------|---------------------------------------|
| FIN  | Male | Kanerva     | Niilo           | Lahden Karate(LK-FIN)                 |
| FIN  | Male | Lakka       | Teuvo           | Shotokan Hervanta Ry(Karate Hervanta) |
| FIN  | Male | Palukuru    | Ronith          | Shotokan Hervanta Ry(Karate Hervanta) |
| FIN  | Male | Roihupalo   | Leo             | Porin Shotokan(JKA Pori)              |
| FIN  | Male | Siivonen    | Kimi            | Porin Shotokan(JKA Pori)              |
| FIN  | Male | Sudharsan   | Anirudh Gopalan | Shotokan Hervanta Ry(Karate Hervanta) |
| FIN  | Male | Tejesvi     | Shashank        | Oulun Karateseura(OKS)                |
| FIN  | Male | Valve       | Verner          | Porin Shotokan(JKA Pori)              |

Entries: 8

### Kata, pojat, U14

| CODE | Sex  | Family Name | Given Name | Club / Team / NOC                                   |
|------|------|-------------|------------|---|
| FIN  | Male | Hannu       | Eero       | Oulun Karateseura(OKS)                              |
| FIN  | Male | Kalliomki   | Viljami    | Porin Shotokan(JKA Pori)                            |
| FIN  | Male | Kella       | Kasper     | Lahden Karate(LK-FIN)                               |
| FIN  | Male | Larkin      | Takehiro   | JKS Finland - Shotokan Karate Helsinki(JKS Finland) |
| FIN  | Male | Lehto       | Eemeli     | Lahden Karate(LK-FIN)                               |
| FIN  | Male | NOROUZI     | Arash Leon | JKS Finland - Shotokan Karate Helsinki(JKS Finland) |
| FIN  | Male | Nummijrvi   | Luukas     | Porin Shotokan(JKA Pori)                            |
| FIN  | Male | Piikkil     | Onni       | Hmeenlinnan Karateseura(HKS)                        |
| FIN  | Male | Pulliainen  | Matias     | Hyvinkn Shotokan karate ry(Vesa)                    |
| FIN  | Male | Salmensuu   | Toivo      | Lahden Karate(LK-FIN)                               |
| FIN  | Male | Sihvonen    | Eemil      | Lahden Karate(LK-FIN)                               |
| FIN  | Male | Sipp        | Emil       | Tapanilan Er(Er)                                    |
| FIN  | Male | Tsegenes    | Dimitris   | Shotokan Hervanta Ry(Karate Hervanta)               |
| FIN  | Male | Wanic       | Mark       | Shuyokai Shotokan Karate-Do(Shuyokai)               |

Entries: 14

### Kata, pojat, U16

| CODE | Sex  | Family Name | Given Name | Club / Team / NOC                |
|------|------|-------------|------------|----------------------------------|
| FIN  | Male | Gaetti      | Lucas      | Porin Shotokan(JKA Pori)         |
| FIN  | Male | Hirvonen    | Jesse      | Jigotai Karate(Jigotai)          |
| FIN  | Male | Huuskonen   | Veeti      | Lahden Karate(LK-FIN)            |
| FIN  | Male | Kivikoski   | Jere       | Lahden Karate(LK-FIN)            |
| FIN  | Male | Kivimki     | Veikko     | Lahden Karate(LK-FIN)            |
| FIN  | Male | Lhetkangas  | Luka       | Oulun Karateseura(OKS)           |
| FIN  | Male | Pienimki    | Roope      | Jigotai Karate(Jigotai)          |
| FIN  | Male | Sandgren    | Joona      | Vantaan Wado Ryu ry(Wado Ryu ry) |
| FIN  | Male | Tarkkanen   | Otso       | Jigotai Karate(Jigotai)          |
| FIN  | Male | Tkachenko   | Timofei    | Jigotai Karate(Jigotai)          |

Entries: 10

### Kata, pojat, valk-kelt, U10

| CODE | Sex  | Family Name | Given Name | Club / Team / NOC     |
|------|------|-------------|------------|-----------------------|
| FIN  | Male | Castrn      | Ossi       | Lahden Karate(LK-FIN) |
| FIN  | Male | Haakana     | Sisu       | Lahden Karate(LK-FIN) |

# Tawastia Open Karate 2/2024

FINLAND  
Liivuoventie 24, Hmeenlinna

2024.10.05 - 2024.10.05

## ENTRY LIST

### Kata, pojat, valk-kelt, U10

| CODE | Sex  | Family Name | Given Name | Club / Team / NOC                     |
|------|------|-------------|------------|---------------------------------------|
| FIN  | Male | Joukainen   | Justus     | Lahden Karate(LK-FIN)                 |
| FIN  | Male | Repo        | Leo        | Lahden Karate(LK-FIN)                 |
| FIN  | Male | Tuomisalo   | Rasmus     | Lahden Karate(LK-FIN)                 |
| FIN  | Male | Zafar Ahmed | Hasan      | Shotokan Hervanta Ry(Karate Hervanta) |

Entries: 6

### Kata, pojat, valk-kelt, U12

| CODE | Sex  | Family Name | Given Name   | Club / Team / NOC                     |
|------|------|-------------|--------------|---------------------------------------|
| FIN  | Male | Hietava     | Anton        | Porin Shotokan(JKA Pori)              |
| FIN  | Male | Kekki       | Akseli       | Lahden Karate(LK-FIN)                 |
| FIN  | Male | Rawat       | Ritish Singh | Shotokan Hervanta Ry(Karate Hervanta) |
| FIN  | Male | Vnttinen    | Aleksi       | Lahden Karate(LK-FIN)                 |
| FIN  | Male | Zia Ahmed   | Hamza        | Shotokan Hervanta Ry(Karate Hervanta) |

Entries: 5

### Kata, pojat, valkoiset, U8

| CODE | Sex  | Family Name | Given Name | Club / Team / NOC       |
|------|------|-------------|------------|-------------------------|
| FIN  | Male | Tejesvi     | Vivaan     | Oulun Karateseura(OKS)  |
| FIN  | Male | Teppo       | Eino       | Jigotai Karate(Jigotai) |
| FIN  | Male | Teppo       | Vin        | Jigotai Karate(Jigotai) |

Entries: 3

### Kata, tytt valk-kelt, U14

| CODE | Sex    | Family Name   | Given Name | Club / Team / NOC                                |
|------|--------|---------------|------------|--|
| FIN  | Female | Coman         | Anastasia  | Japan Karate Association Tampere ry(JKA-Tampere) |
| FIN  | Female | Hameeda Ahmed | Aisha      | Shotokan Hervanta Ry(Karate Hervanta)            |
| FIN  | Female | Pirinen       | Mila       | Hmeenlinnan Karateseura(HKS)                     |
| FIN  | Female | Salminen      | Wenla      | Lahden Karate(LK-FIN)                            |
| FIN  | Female | Sova          | Elina      | Hmeenlinnan Karateseura(HKS)                     |

Entries: 5

### Kata, tytt, keltaiset, U10 yhdistetty

| CODE | Sex    | Family Name | Given Name | Club / Team / NOC                     |
|------|--------|-------------|------------|---------------------------------------|
| FIN  | Female | Abdelmoaty  | Sara       | Hmeenlinnan Karateseura(HKS)          |
| FIN  | Female | Bhogadi     | Sreshtha   | Shotokan Hervanta Ry(Karate Hervanta) |
| FIN  | Female | Chudina     | Alisa      | Porin Shotokan(JKA Pori)              |
| FIN  | Female | Elpi        | Amelia     | Lahden Karate(LK-FIN)                 |
| FIN  | Female | Hakala      | Helena     | Hmeenlinnan Karateseura(HKS)          |
| FIN  | Female | Hakala      | Heli       | Hmeenlinnan Karateseura(HKS)          |
| FIN  | Female | Haven       | Eevi       | Lahden Karate(LK-FIN)                 |
| FIN  | Female | Keskimki    | Fanni      | Porin Shotokan(JKA Pori)              |
| FIN  | Female | Lhetkangas  | Emma       | Oulun Karateseura(OKS)                |

Entries: 9

### Kata, tytt, U10

| CODE | Sex | Family Name | Given Name | Club / Team / NOC |
|------|-----|-------------|------------|-------------------|
|------|-----|-------------|------------|-------------------|



# Tawastia Open Karate 2/2024

FINLAND  
Liivuoventie 24, Hmeenlinna

2024.10.05 - 2024.10.05

## ENTRY LIST

### Kata, tytt, U10

| CODE | Sex    | Family Name | Given Name | Club / Team / NOC                     |
|------|--------|-------------|------------|---------------------------------------|
| FIN  | Female | Batikeru    | Laasya     | Shotokan Hervanta Ry(Karate Hervanta) |
| FIN  | Female | Korhonen    | Meeri      | Korhonen(Korhonen)                    |
| FIN  | Female | MAKSYMUK    | ULIANA     | Maksymuk(Maksymuk)                    |

Entries: 3

### Kata, tytt, U12

| CODE | Sex    | Family Name | Given Name | Club / Team / NOC                                |
|------|--------|-------------|------------|--|
| FIN  | Female | Anbar       | Hiba       | Shotokan Hervanta Ry(Karate Hervanta)            |
| FIN  | Female | Arun        | Iisha      | Shotokan Hervanta Ry(Karate Hervanta)            |
| FIN  | Female | Asiala      | Erin       | Lahden Karate(LK-FIN)                            |
| FIN  | Female | Hakala      | Hanna      | Hmeenlinnan Karateseura(HKS)                     |
| FIN  | Female | Heino       | Lilya      | Tapanilan Er(Er)                                 |
| FIN  | Female | Heinnen     | Vanessa    | Porin Shotokan(JKA Pori)                         |
| FIN  | Female | Koskela     | Jasmin     | Porin Shotokan(JKA Pori)                         |
| FIN  | Female | Lehtiniemi  | Erin       | Porin Shotokan(JKA Pori)                         |
| FIN  | Female | Lindroos    | Emilia     | Porin Shotokan(JKA Pori)                         |
| FIN  | Female | MAKSYMUK    | POLINA     | Maksymuk(Maksymuk)                               |
| FIN  | Female | Mkel        | Jenna      | Hmeenlinnan Karateseura(HKS)                     |
| FIN  | Female | Naskali     | Jatta      | Hmeenlinnan Karateseura(HKS)                     |
| FIN  | Female | Nuhanovic   | Amina      | Japan Karate Association Tampere ry(JKA-Tampere) |
| FIN  | Female | Nyknen      | Tara       | Nyknen(Nyknen)                                   |
| FIN  | Female | Sankari     | Nelli      | Porin Shotokan(JKA Pori)                         |
| FIN  | Female | Veneranta   | Cecilia    | Porin Shotokan(JKA Pori)                         |

Entries: 16

### Kata, tytt, U14

| CODE | Sex    | Family Name | Given Name | Club / Team / NOC                                   |
|------|--------|-------------|------------|---|
| FIN  | Female | Alatalo     | Vanamo     | JKS Finland - Shotokan Karate Helsinki(JKS Finland) |
| FIN  | Female | Antinkaapo  | Nea        | Jigotai Karate(Jigotai)                             |
| FIN  | Female | Heino       | Daisy      | Tapanilan Er(Er)                                    |
| FIN  | Female | Kinnunen    | Anni       | Lahden Karate(LK-FIN)                               |
| FIN  | Female | Kontio      | Venla      | Tapanilan Er(Er)                                    |
| FIN  | Female | Mustonen    | Amanda     | Pietil(Pietil)                                      |
| FIN  | Female | Ortiz       | Antonia    | JKS Finland - Shotokan Karate Helsinki(JKS Finland) |
| FIN  | Female | Pyhnen      | Iida       | Lahden Karate(LK-FIN)                               |
| FIN  | Female | Riimala     | Seela      | Jigotai Karate(Jigotai)                             |
| FIN  | Female | Salo        | Aleksandra | Hmeenlinnan Karateseura(HKS)                        |
| FIN  | Female | Sember      | Vivi       | Vantaan Wado Ryu ry(Wado Ryu ry)                    |
| FIN  | Female | Stefanski   | Vanessa    | Lahden Karate(LK-FIN)                               |

Entries: 12

### Kata, tytt, U16

| CODE | Sex    | Family Name | Given Name | Club / Team / NOC      |
|------|--------|-------------|------------|------------------------|
| FIN  | Female | Ahonen      | Venla      | Lahden Karate(LK-FIN)  |
| FIN  | Female | Hannu       | Alva       | Oulun Karateseura(OKS) |

# Tawastia Open Karate 2/2024

FINLAND  
Liiviuorentie 24, Hmeenlinna

2024.10.05 - 2024.10.05

## ENTRY LIST

### Kata, tytt, U16

| CODE | Sex    | Family Name | Given Name | Club / Team / NOC                     |
|------|--------|-------------|------------|---------------------------------------|
| FIN  | Female | Haven       | Sara       | Lahden Karate(LK-FIN)                 |
| FIN  | Female | Kallio      | Sara       | Lahden Karate(LK-FIN)                 |
| FIN  | Female | Korpela     | Siiri      | Oulun Karataseura(OKS)                |
| FIN  | Female | Kuusi       | Nika       | Hmeenlinnan Karataseura(HKS)          |
| FIN  | Female | Lindstrm    | Meri       | Lahden Karate(LK-FIN)                 |
| FIN  | Female | Mustafina   | Sofia      | Porin Shotokan(JKA Pori)              |
| FIN  | Female | Pietil      | Hilda      | Pietil(Pietil)                        |
| FIN  | Female | Syrjnen     | Lily       | Porin Shotokan(JKA Pori)              |
| FIN  | Female | Tammela     | Iitu       | Hmeenlinnan Karataseura(HKS)          |
| FIN  | Female | Temonen     | Hilma      | Lahden Karate(LK-FIN)                 |
| FIN  | Female | Wanic       | Marie      | Shuyokai Shotokan Karate-Do(Shuyokai) |

Entries: 13

### Kata, tytt, U18

| CODE | Sex    | Family Name | Given Name | Club / Team / NOC                                   |
|------|--------|-------------|------------|---|
| FIN  | Female | Alatalo     | Onerva     | JKS Finland - Shotokan Karate Helsinki(JKS Finland) |
| FIN  | Female | Hannu       | Alva       | Oulun Karataseura(OKS)                              |
| FIN  | Female | Kuusi       | Nika       | Hmeenlinnan Karataseura(HKS)                        |
| FIN  | Female | Meyke       | Alexandra  | JKS Finland - Shotokan Karate Helsinki(JKS Finland) |
| FIN  | Female | Tammela     | Iitu       | Hmeenlinnan Karataseura(HKS)                        |

Entries: 5

### Kumite, miehet, avoin

| CODE | Sex  | Family Name | Given Name | Club / Team / NOC                                   |
|------|------|-------------|------------|---|
| FIN  | Male | Kamamoto    | Keishiro   | JKS Finland - Shotokan Karate Helsinki(JKS Finland) |
| FIN  | Male | Paukkola    | Nooa       | Lahden Karate(LK-FIN)                               |
| FIN  | Male | Simola      | Teemu      | Japan Karate Association Tampere ry(JKA-Tampere)    |
| FIN  | Male | Sura        | Juha-Pekka | Forssan-Tammelalan Jundokan ry(FT-Jundokan)         |
| FIN  | Male | Vink        | Jeffrey    | JKS Finland - Shotokan Karate Helsinki(JKS Finland) |

Entries: 5

### Kumite, miehet, +35-vuotiaat, +84 kg

| CODE | Sex  | Family Name | Given Name | Club / Team / NOC                 |
|------|------|-------------|------------|-----------------------------------|
| FIN  | Male | Hrknen      | Jarno      | Outokummun Karataseura ry(OKS)    |
| FIN  | Male | Vlimki      | Risto      | Lempln Shotokan Karate(JKA Lempl) |

Entries: 2

### Kumite, miehet, +46-vuotiaat, +84 kg

| CODE | Sex  | Family Name | Given Name | Club / Team / NOC              |
|------|------|-------------|------------|--------------------------------|
| FIN  | Male | Hrknen      | Jarno      | Outokummun Karataseura ry(OKS) |

Entries: 1

# Tawastia Open Karate 2/2024

FINLAND  
Liivourentie 24, Hmeenlinna

2024.10.05 - 2024.10.05

## ENTRY LIST

### Kumite, miehet, +75kg

| CODE | Sex  | Family Name | Given Name | Club / Team / NOC                                |
|------|------|-------------|------------|--|
| FIN  | Male | Hrknen      | Jarno      | Outokummun Karateseura ry(OKS)                   |
| FIN  | Male | Simola      | Teemu      | Japan Karate Association Tampere ry(JKA-Tampere) |
| FIN  | Male | Sura        | Juha-Pekka | Forssan-Tammelan Jundokan ry(FT-Jundokan)        |
| FIN  | Male | Vlimki      | Risto      | Lempln Shotokan Karate(JKA Lempl)                |

Entries: 4

### Kumite, miehet, -75kg yhdistetty

| CODE | Sex  | Family Name | Given Name  | Club / Team / NOC                                   |
|------|------|-------------|-------------|---|
| FIN  | Male | Banauliker  | Kartik-Otto | Budokwai ry Karate(Budokwai Karate)                 |
| FIN  | Male | Hnninen     | Aarni       | Renshin-Kan ry(Renshi)                              |
| FIN  | Male | Hnninen     | Niilo       | Renshin-Kan ry(Renshi)                              |
| FIN  | Male | Kamamoto    | Keishiro    | JKS Finland - Shotokan Karate Helsinki(JKS Finland) |
| FIN  | Male | Peltola     | Veikko      | Japan Karate Association Tampere ry(JKA-Tampere)    |

Entries: 5

### Kumite, miehet, -84kg, +35-v yhdistetty

| CODE | Sex  | Family Name | Given Name | Club / Team / NOC           |
|------|------|-------------|------------|-----------------------------|
| FIN  | Male | Luukka      | Eki        | Kotka thaiboxing club(Ktbc) |
| FIN  | Male | Turunen     | Timo       | Sportskarate Kuopio(OM)     |

Entries: 2

### Kumite, miehet, U21, avoin

| CODE | Sex  | Family Name | Given Name | Club / Team / NOC     |
|------|------|-------------|------------|-----------------------|
| FIN  | Male | Paukkola    | Nooa       | Lahden Karate(LK-FIN) |

Entries: 1

### Kumite, miehet, U21, -75 kg

| CODE | Sex  | Family Name | Given Name  | Club / Team / NOC                   |
|------|------|-------------|-------------|-------------------------------------|
| FIN  | Male | Banauliker  | Kartik-Otto | Budokwai ry Karate(Budokwai Karate) |
| FIN  | Male | Hnninen     | Aarni       | Renshin-Kan ry(Renshi)              |
| FIN  | Male | Hnninen     | Niilo       | Renshin-Kan ry(Renshi)              |

Entries: 3

### Kumite, miehet, U21, -84 kg

| CODE | Sex  | Family Name | Given Name | Club / Team / NOC                                |
|------|------|-------------|------------|--|
| FIN  | Male | Mantere     | Jimi       | Hmeenlinnan Karateseura(HKS)                     |
| FIN  | Male | Nuhanovic   | Alsad      | Japan Karate Association Tampere ry(JKA-Tampere) |
| FIN  | Male | Paukkola    | Nooa       | Lahden Karate(LK-FIN)                            |

Entries: 3

### Kumite, naiset, avoin

| CODE | Sex    | Family Name | Given Name | Club / Team / NOC    |
|------|--------|-------------|------------|----------------------|
| FIN  | Female | Saadaoui    | Sonya      | Sportskarate.fi(SPF) |

# Tawastia Open Karate 2/2024

FINLAND  
Liivourentie 24, Hmeenlinna

2024.10.05 - 2024.10.05

## ENTRY LIST

### Kumite, naiset, avoin

| CODE | Sex    | Family Name | Given Name | Club / Team / NOC                                   |
|------|--------|-------------|------------|---|
| FIN  | Female | Yamate      | Sakino     | JKS Finland - Shotokan Karate Helsinki(JKS Finland) |

Entries: 2

### Kumite, naiset, -68 kg

| CODE | Sex    | Family Name | Given Name | Club / Team / NOC    |
|------|--------|-------------|------------|----------------------|
| FIN  | Female | Saadaoui    | Sonya      | Sportskarate.fi(SPF) |

Entries: 1

### Kumite, naiset, U21, avoin

| CODE | Sex    | Family Name | Given Name | Club / Team / NOC    |
|------|--------|-------------|------------|----------------------|
| FIN  | Female | Saadaoui    | Sonya      | Sportskarate.fi(SPF) |

Entries: 1

### Kumite, naiset, U21, -68kg yhdistetty

| CODE | Sex    | Family Name | Given Name | Club / Team / NOC    |
|------|--------|-------------|------------|----------------------|
| FIN  | Female | Koivula     | Sofia      | Sportskarate.fi(SPF) |
| FIN  | Female | Saadaoui    | Sonya      | Sportskarate.fi(SPF) |

Entries: 2

### Kumite, pojat, U10

| CODE | Sex  | Family Name | Given Name | Club / Team / NOC                                   |
|------|------|-------------|------------|---|
| FIN  | Male | Grosu       | Nicolas    | Budokwai ry Karate(Budokwai Karate)                 |
| FIN  | Male | Larkin      | Chael      | JKS Finland - Shotokan Karate Helsinki(JKS Finland) |
| FIN  | Male | Lunin       | Adrian     | Sportskarate.fi(SPF)                                |
| FIN  | Male | Luukka      | Erno       | Kotka thaiboxing club(Ktbc)                         |
| FIN  | Male | Ravyse      | Nathan     | Budokwai ry Karate(Budokwai Karate)                 |
| FIN  | Male | Zafar Ahmed | Hasan      | Shotokan Hervanta Ry(Karate Hervanta)               |

Entries: 6

### Kumite, pojat, U12, +42 kg

| CODE | Sex  | Family Name | Given Name | Club / Team / NOC                             |
|------|------|-------------|------------|---|
| FIN  | Male | Heikkil     | Eliel      | Budokwai ry Karate(Budokwai Karate)           |
| FIN  | Male | Kullberg    | Adam       | Budoseura Imatran Kusanku ry(Imatran Kusanku) |
| FIN  | Male | Palukuru    | Ronith     | Shotokan Hervanta Ry(Karate Hervanta)         |
| FIN  | Male | Valve       | Veneri     | Porin Shotokan(JKA Pori)                      |
| FIN  | Male | Zia Ahmed   | Hamza      | Shotokan Hervanta Ry(Karate Hervanta)         |

Entries: 5

### Kumite, pojat, U12, -35 kg

| CODE | Sex  | Family Name | Given Name   | Club / Team / NOC                     |
|------|------|-------------|--------------|---------------------------------------|
| FIN  | Male | Lakka       | Teuvo        | Shotokan Hervanta Ry(Karate Hervanta) |
| FIN  | Male | Leisti      | Pennueng     | Kotka thaiboxing club(Ktbc)           |
| FIN  | Male | Rawat       | Ritish Singh | Shotokan Hervanta Ry(Karate Hervanta) |

Entries: 3

# Tawastia Open Karate 2/2024

FINLAND  
Liivourentie 24, Hmeenlinna

2024.10.05 - 2024.10.05

## ENTRY LIST

| Kumite, pojat, U12, -42 kg |      |             |            |  |
|----------------------------|------|-------------|------------|--|
| CODE                       | Sex  | Family Name | Given Name | Club / Team / NOC                                |
| FIN                        | Male | Anttila     | Paolo      | Renshin-Kan ry(Renshi)                           |
| FIN                        | Male | Hannu       | Aarre      | Budoseura Oulun Musokai Ry(Musokai)              |
| FIN                        | Male | Hietava     | Anton      | Porin Shotokan(JKA Pori)                         |
| FIN                        | Male | Lilja       | Dani       | Sportskarate Kuopio(OM)                          |
| FIN                        | Male | Luukka      | Erkko      | Kotka thaiboxing club(Ktbc)                      |
| FIN                        | Male | Pihlajisto  | Pauli      | Japan Karate Association Tampere ry(JKA-Tampere) |
| FIN                        | Male | Raiskinmki  | Aatos      | Karate Combat Academy(Dumitru)                   |
| FIN                        | Male | Ralli       | Alexi      | Budoseura Imatran Kusanku ry(Imatran Kusanku)    |
| FIN                        | Male | Roihupalo   | Leo        | Porin Shotokan(JKA Pori)                         |
| FIN                        | Male | Siivonen    | Kimi       | Porin Shotokan(JKA Pori)                         |
| FIN                        | Male | Tejesvi     | Shashank   | Oulun Karateseura(OKS)                           |

Entries: 11

| Kumite, pojat, U14, +55 kg |      |             |            |                          |
|----------------------------|------|-------------|------------|--------------------------|
| CODE                       | Sex  | Family Name | Given Name | Club / Team / NOC        |
| FIN                        | Male | Lehto       | Eemeli     | Lahden Karate(LK-FIN)    |
| FIN                        | Male | Nummijrvi   | Luukas     | Porin Shotokan(JKA Pori) |
| FIN                        | Male | Takala      | Anton      | Oulun Karateseura(OKS)   |
| FIN                        | Male | Tameh       | Abdulkarim | Sportskarate Kuopio(OM)  |

Entries: 4

| Kumite, pojat, U14, -40kg |      |             |            |   |
|---------------------------|------|-------------|------------|---|
| CODE                      | Sex  | Family Name | Given Name | Club / Team / NOC                             |
| FIN                       | Male | Ruottinen   | Roope      | Budoseura Imatran Kusanku ry(Imatran Kusanku) |
| FIN                       | Male | Tsegenes    | Dimitris   | Shotokan Hervanta Ry(Karate Hervanta)         |

Entries: 2

| Kumite, pojat, U14, -45 kg |      |             |            |                                |
|----------------------------|------|-------------|------------|--------------------------------|
| CODE                       | Sex  | Family Name | Given Name | Club / Team / NOC              |
| FIN                        | Male | Kalliomki   | Viljami    | Porin Shotokan(JKA Pori)       |
| FIN                        | Male | Koskinen    | Sulo       | Kotka thaiboxing club(Ktbc)    |
| FIN                        | Male | Mahmood     | Zohaib     | Renshin-Kan ry(Renshi)         |
| FIN                        | Male | Raiskinmki  | Aaron      | Karate Combat Academy(Dumitru) |
| FIN                        | Male | Sipp        | Emil       | Tapanilan Er(Er)               |
| FIN                        | Male | Tameh       | Abdulkarim | Sportskarate Kuopio(OM)        |

Entries: 6

| Kumite, pojat, U14, -50 kg |      |             |            |   |
|----------------------------|------|-------------|------------|---|
| CODE                       | Sex  | Family Name | Given Name | Club / Team / NOC                                   |
| FIN                        | Male | Huuskonen   | Kosti      | Sportskarate Kuopio(OM)                             |
| FIN                        | Male | Kella       | Kasperii   | Lahden Karate(LK-FIN)                               |
| FIN                        | Male | Larkin      | Takehiro   | JKS Finland - Shotokan Karate Helsinki(JKS Finland) |
| FIN                        | Male | Mattinen    | Nuutti     | Sportskarate Kuopio(OM)                             |
| FIN                        | Male | Salmensuu   | Toivo      | Lahden Karate(LK-FIN)                               |

Entries: 5

# Tawastia Open Karate 2/2024

FINLAND  
Liivourentie 24, Hmeenlinna

2024.10.05 - 2024.10.05

## ENTRY LIST

### Kumite, pojat, U14, -55 kg

| CODE | Sex  | Family Name | Given Name | Club / Team / NOC                                   |
|------|------|-------------|------------|---|
| FIN  | Male | Hannu       | Eero       | Oulun Karateseura(OKS)                              |
| FIN  | Male | NOROUZI     | Arash Leon | JKS Finland - Shotokan Karate Helsinki(JKS Finland) |
| FIN  | Male | Wolff       | Arn        | Tapanilan Er(Er)                                    |

Entries: 3

### Kumite, pojat, U16, +70 kg

| CODE | Sex  | Family Name | Given Name | Club / Team / NOC                     |
|------|------|-------------|------------|---------------------------------------|
| FIN  | Male | Algahawi    | Yakoot     | Budokwai ry Karate(Budokwai Karate)   |
| FIN  | Male | Forsten     | Niklas     | Shuyokai Shotokan Karate-Do(Shuyokai) |
| FIN  | Male | Huuskonen   | Veeti      | Lahden Karate(LK-FIN)                 |
| FIN  | Male | Kivikoski   | Jere       | Lahden Karate(LK-FIN)                 |
| FIN  | Male | Pienimki    | Roope      | Jigotai Karate(Jigotai)               |

Entries: 5

### Kumite, pojat, U16, -52 kg

| CODE | Sex  | Family Name | Given Name | Club / Team / NOC                                |
|------|------|-------------|------------|--|
| FIN  | Male | Anttila     | Ken        | Renshin-Kan ry(Renshi)                           |
| FIN  | Male | Kettunen    | Eemeli     | Hmeenlinnan Karateseura(HKS)                     |
| FIN  | Male | Mattinen    | Nuutti     | Sportskarate Kuopio(OM)                          |
| FIN  | Male | Muurinaho   | Luka       | Japan Karate Association Tampere ry(JKA-Tampere) |
| FIN  | Male | Tarkkanen   | Otso       | Jigotai Karate(Jigotai)                          |

Entries: 5

### Kumite, pojat, U16, -57 kg

| CODE | Sex  | Family Name     | Given Name | Club / Team / NOC                                   |
|------|------|-----------------|------------|---|
| FIN  | Male | Hanhinen        | Onni       | Jigotai Karate(Jigotai)                             |
| FIN  | Male | Hirvonen        | Jesse      | Jigotai Karate(Jigotai)                             |
| FIN  | Male | Illanganthilake | Ishan      | JKS Finland - Shotokan Karate Helsinki(JKS Finland) |
| FIN  | Male | Jrvenp          | Tatu       | Sportskarate Pori(SKP)                              |
| FIN  | Male | Lauronen        | Leo        | Sportskarate.fi(SPF)                                |
| FIN  | Male | Sandgren        | Joona      | Vantaan Wado Ryu ry(Wado Ryu ry)                    |
| FIN  | Male | Simonen         | Tino       | Joen Mawashi ry(JM)                                 |
| FIN  | Male | Sil             | Voitto     | Budokwai ry Karate(Budokwai Karate)                 |
| FIN  | Male | Tameh           | Mohammed   | Sportskarate Kuopio(OM)                             |
| FIN  | Male | Vaara           | Santeri    | Oulun Karateseura(OKS)                              |
| FIN  | Male | Vyrynen         | Luukas     | Sportskarate Kuopio(OM)                             |

Entries: 11

### Kumite, pojat, U16, -63 kg

| CODE | Sex  | Family Name | Given Name | Club / Team / NOC             |
|------|------|-------------|------------|-------------------------------|
| FIN  | Male | Gaetti      | Lucas      | Porin Shotokan(JKA Pori)      |
| FIN  | Male | Keltto      | Topias     | Lakeuden Karate-Jutsu Ry(LKJ) |
| FIN  | Male | Kivimki     | Veikko     | Lahden Karate(LK-FIN)         |
| FIN  | Male | Simonen     | Rene       | Joen Mawashi ry(JM)           |
| FIN  | Male | Takala      | Anton      | Oulun Karateseura(OKS)        |

# Tawastia Open Karate 2/2024

FINLAND  
Liiviuorentie 24, Hmeenlinna

2024.10.05 - 2024.10.05

## ENTRY LIST

### Kumite, pojat, U16, -63 kg

| CODE | Sex  | Family Name | Given Name | Club / Team / NOC   |
|------|------|-------------|------------|---------------------|
| FIN  | Male | Vartiainen  | Juuso      | Joen Mawashi ry(JM) |

Entries: 6

### Kumite, pojat, U16, -70 kg

| CODE | Sex  | Family Name | Given Name | Club / Team / NOC       |
|------|------|-------------|------------|-------------------------|
| FIN  | Male | Hokka       | Mikko      | Renshin-Kan ry(Renshi)  |
| FIN  | Male | Honkanen    | Santtu     | Sportskarate.fi(SPF)    |
| FIN  | Male | Lhetkangas  | Luka       | Oulun Karataseura(OKS)  |
| FIN  | Male | Pylvnen     | Anton      | Jigotai Karate(Jigotai) |
| FIN  | Male | Tkachenko   | Timofei    | Jigotai Karate(Jigotai) |

Entries: 5

### Kumite, pojat, U18, +68 kg yhdistetty

| CODE | Sex  | Family Name | Given Name | Club / Team / NOC                                |
|------|------|-------------|------------|--|
| FIN  | Male | Kreus       | Petrus     | Japan Karate Association Tampere ry(JKA-Tampere) |
| FIN  | Male | Mantere     | Jimi       | Hmeenlinnan Karataseura(HKS)                     |

Entries: 2

### Kumite, pojat, U18, -55 kg

| CODE | Sex  | Family Name | Given Name | Club / Team / NOC            |
|------|------|-------------|------------|------------------------------|
| FIN  | Male | Kettunen    | Eemeli     | Hmeenlinnan Karataseura(HKS) |
| FIN  | Male | Simonen     | Tino       | Joen Mawashi ry(JM)          |

Entries: 2

### Kumite, pojat, U18, -61 kg

| CODE | Sex  | Family Name | Given Name | Club / Team / NOC        |
|------|------|-------------|------------|--------------------------|
| FIN  | Male | Jrvenp      | Tatu       | Sportskarate Pori(SKP)   |
| FIN  | Male | Simonen     | Rene       | Joen Mawashi ry(JM)      |
| FIN  | Male | Vainela     | Juho       | Porin Shotokan(JKA Pori) |
| FIN  | Male | Vyrynen     | Luukas     | Sportskarate Kuopio(OM)  |

Entries: 4

### Kumite, pojat, U18, -68 kg

| CODE | Sex  | Family Name | Given Name | Club / Team / NOC                                |
|------|------|-------------|------------|--|
| FIN  | Male | Ahvonen     | Atte       | Japan Karate Association Tampere ry(JKA-Tampere) |
| FIN  | Male | Honkanen    | Santtu     | Sportskarate.fi(SPF)                             |
| FIN  | Male | Vainela     | Juho       | Porin Shotokan(JKA Pori)                         |

Entries: 3

### KUMITE, POJAT, VALKOISET JA KELTAISET U8

| CODE | Sex  | Family Name | Given Name | Club / Team / NOC       |
|------|------|-------------|------------|-------------------------|
| FIN  | Male | Tejesvi     | Vivaan     | Oulun Karataseura(OKS)  |
| FIN  | Male | Teppo       | Eino       | Jigotai Karate(Jigotai) |
| FIN  | Male | Teppo       | Vin        | Jigotai Karate(Jigotai) |

Entries: 3

# Tawastia Open Karate 2/2024

FINLAND  
Liivourentie 24, Hmeenlinna

2024.10.05 - 2024.10.05

## ENTRY LIST

| Kumite, tytt, U10 yhdistetty |        |             |            |   |
|------------------------------|--------|-------------|------------|---|
| CODE                         | Sex    | Family Name | Given Name | Club / Team / NOC                             |
| FIN                          | Female | Abdelmoaty  | Sara       | Hmeenlinnan Karateseura(HKS)                  |
| FIN                          | Female | Batikeru    | Laasya     | Shotokan Hervanta Ry(Karate Hervanta)         |
| FIN                          | Female | Chudina     | Alisa      | Porin Shotokan(JKA Pori)                      |
| FIN                          | Female | Hakala      | Heli       | Hmeenlinnan Karateseura(HKS)                  |
| FIN                          | Female | Keskimki    | Fanni      | Porin Shotokan(JKA Pori)                      |
| FIN                          | Female | Luoma-ij    | Ellah      | Sportskarate.fi(SPF)                          |
| FIN                          | Female | Lhetkangas  | Emma       | Oulun Karateseura(OKS)                        |
| FIN                          | Female | MAKSYMUK    | ULIANA     | Maksymuk(Maksymuk)                            |
| FIN                          | Female | Ruottinen   | Iina       | Budoseura Imatran Kusanku ry(Imatran Kusanku) |
| FIN                          | Female | Yakivets    | Ieva       | Budokwai ry Karate(Budokwai Karate)           |

Entries: 10

| Kumite, tytt, U12, +40 kg |        |             |            |  |
|---------------------------|--------|-------------|------------|--|
| CODE                      | Sex    | Family Name | Given Name | Club / Team / NOC                                |
| FIN                       | Female | Ebdul Eziz  | Eva        | Budokwai ry Karate(Budokwai Karate)              |
| FIN                       | Female | Heinnen     | Vanessa    | Porin Shotokan(JKA Pori)                         |
| FIN                       | Female | Koskela     | Jasmin     | Porin Shotokan(JKA Pori)                         |
| FIN                       | Female | Lehtiniemi  | Erin       | Porin Shotokan(JKA Pori)                         |
| FIN                       | Female | MAKSYMUK    | POLINA     | Maksymuk(Maksymuk)                               |
| FIN                       | Female | Nuhanovic   | Amina      | Japan Karate Association Tampere ry(JKA-Tampere) |
| FIN                       | Female | Savolainen  | Elli       | Sportskarate Kuopio(OM)                          |
| FIN                       | Female | Veneranta   | Cecilia    | Porin Shotokan(JKA Pori)                         |

Entries: 8

| Kumite, tytt, U12, -34 kg |        |             |            |                                       |
|---------------------------|--------|-------------|------------|---------------------------------------|
| CODE                      | Sex    | Family Name | Given Name | Club / Team / NOC                     |
| FIN                       | Female | Anbar       | Hiba       | Shotokan Hervanta Ry(Karate Hervanta) |
| FIN                       | Female | Arun        | Iisha      | Shotokan Hervanta Ry(Karate Hervanta) |
| FIN                       | Female | Nyknen      | Tara       | Nyknen(Nyknen)                        |

Entries: 3

| Kumite, tytt, U12, -40 kg |        |             |            |                              |
|---------------------------|--------|-------------|------------|------------------------------|
| CODE                      | Sex    | Family Name | Given Name | Club / Team / NOC            |
| FIN                       | Female | Hakala      | Hanna      | Hmeenlinnan Karateseura(HKS) |
| FIN                       | Female | Heino       | Lilya      | Tapanilan Er(Er)             |
| FIN                       | Female | Lindroos    | Emilia     | Porin Shotokan(JKA Pori)     |
| FIN                       | Female | Sankari     | Nelli      | Porin Shotokan(JKA Pori)     |

Entries: 4

| Kumite, tytt, U14, +52 kg |        |               |            |  |
|---------------------------|--------|---------------|------------|--|
| CODE                      | Sex    | Family Name   | Given Name | Club / Team / NOC                                |
| FIN                       | Female | Coman         | Anastasia  | Japan Karate Association Tampere ry(JKA-Tampere) |
| FIN                       | Female | Hameeda Ahmed | Aisha      | Shotokan Hervanta Ry(Karate Hervanta)            |
| FIN                       | Female | Kontio        | Venla      | Tapanilan Er(Er)                                 |
| FIN                       | Female | Pohjalainen   | Aura       | Budoseura Imatran Kusanku ry(Imatran Kusanku)    |



# Tawastia Open Karate 2/2024

FINLAND  
Liivourentie 24, Hmeenlinna

2024.10.05 - 2024.10.05

## ENTRY LIST

Entries: 4

### Kumite, tytt, U14, -42 kg

| CODE | Sex    | Family Name | Given Name | Club / Team / NOC       |
|------|--------|-------------|------------|-------------------------|
| FIN  | Female | Anttila     | Isabella   | Renshin-Kan ry(Renshi)  |
| FIN  | Female | Riimala     | Seela      | Jigotai Karate(Jigotai) |

Entries: 2

### Kumite, tytt, U14, -47 kg

| CODE | Sex    | Family Name | Given Name | Club / Team / NOC                             |
|------|--------|-------------|------------|---|
| FIN  | Female | Antinkaapo  | Nea        | Jigotai Karate(Jigotai)                       |
| FIN  | Female | Heino       | Daisy      | Tapanilan Er(Er)                              |
| FIN  | Female | Hyvnen      | Lila       | Sportskarate Kuopio(OM)                       |
| FIN  | Female | Keskinen    | Emilia     | Budoseura Imatran Kusanku ry(Imatran Kusanku) |
| FIN  | Female | Pyhnen      | Iida       | Lahden Karate(LK-FIN)                         |
| FIN  | Female | Sember      | Vivi       | Vantaan Wado Ryu ry(Wado Ryu ry)              |

Entries: 6

### Kumite, tytt, U14, -52 kg

| CODE | Sex    | Family Name | Given Name | Club / Team / NOC           |
|------|--------|-------------|------------|-----------------------------|
| FIN  | Female | Leisti      | Charuphat  | Kotka thaiboxing club(Ktbc) |
| FIN  | Female | Niemi       | Tova       | Tapanilan Er(Er)            |
| FIN  | Female | Stefanski   | Vanessa    | Lahden Karate(LK-FIN)       |

Entries: 3

### Kumite, tytt, U16, +54 kg yhdistetty

| CODE | Sex    | Family Name | Given Name | Club / Team / NOC                     |
|------|--------|-------------|------------|---------------------------------------|
| FIN  | Female | Bryssy      | Mae        | Jigotai Karate(Jigotai)               |
| FIN  | Female | Jokinen     | Helmi      | Hmeenlinnan Karateseura(HKS)          |
| FIN  | Female | Korpela     | Siiri      | Oulun Karateseura(OKS)                |
| FIN  | Female | Mertamo     | Amanda     | Tapanilan Er(Er)                      |
| FIN  | Female | Pelkonen    | Aune       | Shotokan Hervanta Ry(Karate Hervanta) |

Entries: 5

### Kumite, tytt, U16, -47 kg

| CODE | Sex    | Family Name | Given Name | Club / Team / NOC                                |
|------|--------|-------------|------------|--|
| FIN  | Female | Hannu       | Alva       | Oulun Karateseura(OKS)                           |
| FIN  | Female | Itkonen     | Janika     | Sportskarate.fi(SPF)                             |
| FIN  | Female | Kentt       | Hilda      | Oulun Karateseura(OKS)                           |
| FIN  | Female | Mustafina   | Sofia      | Porin Shotokan(JKA Pori)                         |
| FIN  | Female | Nuhanovic   | Haska      | Japan Karate Association Tampere ry(JKA-Tampere) |

Entries: 5

### Kumite, tytt, U16, -54 kg

| CODE | Sex    | Family Name | Given Name | Club / Team / NOC     |
|------|--------|-------------|------------|-----------------------|
| FIN  | Female | Chepelev    | Sofia      | Sportskarate.fi(SPF)  |
| FIN  | Female | Lehtinen    | Eleanor    | Tapanilan Er(Er)      |
| FIN  | Female | Stefanski   | Vanessa    | Lahden Karate(LK-FIN) |

# Tawastia Open Karate 2/2024

FINLAND  
Liiviuorentie 24, Hmeenlinna

2024.10.05 - 2024.10.05

## ENTRY LIST

### Kumite, tytt, U16, -54 kg

| CODE | Sex    | Family Name | Given Name | Club / Team / NOC        |
|------|--------|-------------|------------|--------------------------|
| FIN  | Female | Syrjnen     | Lily       | Porin Shotokan(JKA Pori) |

Entries: 4

### Kumite, tytt, U18, +53kg yhdistetty

| CODE | Sex    | Family Name | Given Name | Club / Team / NOC                                   |
|------|--------|-------------|------------|---|
| FIN  | Female | Jokinen     | Helmi      | Hmeenlinnan Karateseura(HKS)                        |
| FIN  | Female | Koivula     | Sofia      | Sportskarate.fi(SPF)                                |
| FIN  | Female | Meyke       | Alexandra  | JKS Finland - Shotokan Karate Helsinki(JKS Finland) |
| FIN  | Female | Saarnio     | Selja      | Sportskarate.fi(SPF)                                |

Entries: 4

### Kumite, tytt, U18, -53 kg yhdistetty

| CODE | Sex    | Family Name | Given Name | Club / Team / NOC                                   |
|------|--------|-------------|------------|---|
| FIN  | Female | Alatalo     | Onerva     | JKS Finland - Shotokan Karate Helsinki(JKS Finland) |
| FIN  | Female | Chepelev    | Sofia      | Sportskarate.fi(SPF)                                |
| FIN  | Female | Itkonen     | Janika     | Sportskarate.fi(SPF)                                |
| FIN  | Female | Rissanen    | Iina       | Sportskarate Kuopio(OM)                             |

Entries: 4

### TEKNIikka U10

| CODE | Sex    | Family Name | Given Name | Club / Team / NOC     |
|------|--------|-------------|------------|-----------------------|
| FIN  | Female | Elpi        | Amelia     | Lahden Karate(LK-FIN) |
| FIN  | Female | Haven       | Eevi       | Lahden Karate(LK-FIN) |
| FIN  | Male   | Repo        | Leo        | Lahden Karate(LK-FIN) |

Entries: 3

### TEKNIikka U14 yhdistetty

| CODE | Sex    | Family Name | Given Name | Club / Team / NOC            |
|------|--------|-------------|------------|------------------------------|
| FIN  | Male   | Kekki       | Akseli     | Lahden Karate(LK-FIN)        |
| FIN  | Female | Pirinen     | Mila       | Hmeenlinnan Karateseura(HKS) |
| FIN  | Female | Salminen    | Wenla      | Lahden Karate(LK-FIN)        |
| FIN  | Female | Sova        | Elina      | Hmeenlinnan Karateseura(HKS) |

Entries: 4

### Tekniikka U9 yhdistetty

| CODE | Sex    | Family Name | Given Name | Club / Team / NOC                     |
|------|--------|-------------|------------|---------------------------------------|
| FIN  | Female | Abdelmoaty  | Jasmiina   | Hmeenlinnan Karateseura(HKS)          |
| FIN  | Female | Bhogadi     | Sreshta    | Shotokan Hervanta Ry(Karate Hervanta) |
| FIN  | Female | Hakala      | Helena     | Hmeenlinnan Karateseura(HKS)          |

Entries: 3

Total Entries:322

# Tawastia Open Karate 2/2024

FINLAND  
Liivuoventie 24, Hmeenlinna

2024.10.05 - 2024.10.05

## Statistics

Participating Countries: 1

Participating Regions: 0

Participating Team/Clubs: 30

|              | Competitors | Entries    |
|--------------|-------------|------------|
| Female       | 89          | 145        |
| Male         | 113         | 177        |
| <b>Total</b> | <b>202</b>  | <b>322</b> |

### Entries per Category

|  | Entries | Teams |
|--|---------|-------|
| KATA, MIEHET                             | 6       | -     |
| KATA, NAISET                             | 4       | -     |
| KUMITE, POJAT, VALKOISET JA KELTAISET U8 | 3       | -     |
| Kata, miehet, +35-vuotiaat               | 3       | -     |
| Kata, miehet, U21                        | 2       | -     |
| Kata, naiset, U21                        | 2       | -     |
| Kata, pojat, U12                         | 8       | -     |
| Kata, pojat, U14                         | 14      | -     |
| Kata, pojat, U16                         | 10      | -     |
| Kata, pojat, keltaiset, U10              | 1       | -     |
| Kata, pojat, valk-kelt, U10              | 6       | -     |
| Kata, pojat, valk-kelt, U12              | 5       | -     |
| Kata, pojat, valkoiset, U8               | 3       | -     |
| Kata, tytt valk-kelt, U14                | 5       | -     |
| Kata, tytt, U10                          | 3       | -     |
| Kata, tytt, U12                          | 16      | -     |
| Kata, tytt, U14                          | 12      | -     |
| Kata, tytt, U16                          | 13      | -     |
| Kata, tytt, U18                          | 5       | -     |
| Kata, tytt, keltaiset, U10 yhdistetty    | 9       | -     |
| Kumite, miehet, avoin                    | 5       | -     |
| Kumite, miehet, +35-vuotiaat, +84 kg     | 2       | -     |
| Kumite, miehet, +46-vuotiaat, +84 kg     | 1       | -     |
| Kumite, miehet, +75kg                    | 4       | -     |
| Kumite, miehet, -75kg yhdistetty         | 5       | -     |
| Kumite, miehet, -84kg, +35-v yhdistetty  | 2       | -     |
| Kumite, miehet, U21, avoin               | 1       | -     |
| Kumite, miehet, U21, -75 kg              | 3       | -     |
| Kumite, miehet, U21, -84 kg              | 3       | -     |
| Kumite, naiset, avoin                    | 2       | -     |

# Tawastia Open Karate 2/2024

FINLAND  
Liiviuorentie 24, Hmeenlinna

2024.10.05 - 2024.10.05

## Statistics

|                                       |            |          |
|---------------------------------------|------------|----------|
| Kumite, naiset, -68 kg                | 1          | -        |
| Kumite, naiset, U21, avoin            | 1          | -        |
| Kumite, naiset, U21, -68kg yhdistetty | 2          | -        |
| Kumite, pojat, U10                    | 6          | -        |
| Kumite, pojat, U12, +42 kg            | 5          | -        |
| Kumite, pojat, U12, -35 kg            | 3          | -        |
| Kumite, pojat, U12, -42 kg            | 11         | -        |
| Kumite, pojat, U14, +55 kg            | 4          | -        |
| Kumite, pojat, U14, -40kg             | 2          | -        |
| Kumite, pojat, U14, -45 kg            | 6          | -        |
| Kumite, pojat, U14, -50 kg            | 5          | -        |
| Kumite, pojat, U14, -55 kg            | 3          | -        |
| Kumite, pojat, U16, +70 kg            | 5          | -        |
| Kumite, pojat, U16, -52 kg            | 5          | -        |
| Kumite, pojat, U16, -57 kg            | 11         | -        |
| Kumite, pojat, U16, -63 kg            | 6          | -        |
| Kumite, pojat, U16, -70 kg            | 5          | -        |
| Kumite, pojat, U18, +68 kg yhdistetty | 2          | -        |
| Kumite, pojat, U18, -55 kg            | 2          | -        |
| Kumite, pojat, U18, -61 kg            | 4          | -        |
| Kumite, pojat, U18, -68 kg            | 3          | -        |
| Kumite, tytt, U10 yhdistetty          | 10         | -        |
| Kumite, tytt, U12, +40 kg             | 8          | -        |
| Kumite, tytt, U12, -34 kg             | 3          | -        |
| Kumite, tytt, U12, -40 kg             | 4          | -        |
| Kumite, tytt, U14, +52 kg             | 4          | -        |
| Kumite, tytt, U14, -42 kg             | 2          | -        |
| Kumite, tytt, U14, -47 kg             | 6          | -        |
| Kumite, tytt, U14, -52 kg             | 3          | -        |
| Kumite, tytt, U16, +54 kg yhdistetty  | 5          | -        |
| Kumite, tytt, U16, -47 kg             | 5          | -        |
| Kumite, tytt, U16, -54 kg             | 4          | -        |
| Kumite, tytt, U18, +53kg yhdistetty   | 4          | -        |
| Kumite, tytt, U18, -53 kg yhdistetty  | 4          | -        |
| TEKNIikka U10                         | 3          | -        |
| TEKNIikka U14 yhdistetty              | 4          | -        |
| Tekniikka U9 yhdistetty               | 3          | -        |
| <b>Totals:</b>                        | <b>322</b> | <b>0</b> |

# Tawastia Open Karate 2/2024

FINLAND  
Liivuoentie 24, Hmeenlinna

2024.10.05 - 2024.10.05

## ENTRY LIST - OFFICIALS

| Coach  |          |     |             |            |       |
|--|----------|-----|-------------|------------|-------|
| <b>Budokwai ry Karate(Budokwai Karate)</b>                 |          |     |             |            |       |
| 1  |          | FIN | Kartik-Otto | Banauliker | Coach |
| 2  |          | FIN | Ismo        | Laitakari  | Coach |
| Entries: 2   |          |     |             |            |       |
| <b>Budoseura Imatran Kusanku ry(Imatran Kusanku)</b>       |          |     |             |            |       |
| 3  |          | FIN | Vesa        | Ruottinen  | Coach |
| 4  |          | FIN | Arttu       | Venlinen   | Coach |
| Entries: 2   |          |     |             |            |       |
| <b>Budoseura Oulun Musokai Ry(Musokai)</b>                 |          |     |             |            |       |
| 5  | 60065764 | FIN | Jari        | Hannu      | Coach |
| Entries: 1   |          |     |             |            |       |
| <b>Hmeenlinnan Karateseura(HKS)</b>                        |          |     |             |            |       |
| 6  | FIN2118  | FIN | Nelli       | Mantere    | Coach |
| Entries: 1   |          |     |             |            |       |
| <b>Japan Karate Association Tampere ry(JKA-Tampere)</b>    |          |     |             |            |       |
| 7  |          | FIN | Harri       | Ahvonen    | Coach |
| 8  |          | FIN | Marko       | Hautala    | Coach |
| 9  |          | FIN | Petrus      | Kreus      | Coach |
| 10   |          | FIN | Alsad       | Nuhanovic  | Coach |
| Entries: 4   |          |     |             |            |       |
| <b>Jigotai Karate(Jigotai)</b>                             |          |     |             |            |       |
| 11   |          | FIN | Tommi       | Tarkkanen  | Coach |
| Entries: 1   |          |     |             |            |       |
| <b>JKS Finland - Shotokan Karate Helsinki(JKS Finland)</b> |          |     |             |            |       |
| 12   |          | FIN | Jani        | Alatalo    | Coach |
| 13   |          | FIN | Sammy       | Rohner     | Coach |
| Entries: 2   |          |     |             |            |       |
| <b>Joen Mawashi ry(JM)</b>                                 |          |     |             |            |       |
| 14   |          | FIN | Klaus       | Tefke      | Coach |
| Entries: 1   |          |     |             |            |       |
| <b>Lahden Karate(LK-FIN)</b>                               |          |     |             |            |       |
| 15   |          | FIN | Hannu       | Kella      | Coach |
| 16   |          | FIN | Hanna       | Saario     | Coach |
| 17   |          | FIN | Miia        | Stefanski  | Coach |
| Entries: 3   |          |     |             |            |       |
| <b>Mikkelin Karateseura(Mikkelin Karateseura)</b>          |          |     |             |            |       |
| 18   |          | FIN | Alisa       | Laatunen   | Coach |
| Entries: 1   |          |     |             |            |       |
| <b>Oulun Karateseura(OKS)</b>                              |          |     |             |            |       |
| 19   |          | FIN | Mika        | Alamaula   | Coach |
| 20   |          | FIN | Harri       | Takala     | Coach |
| Entries: 2   |          |     |             |            |       |
| <b>Outokummun Karateseura ry(OKS)</b>                      |          |     |             |            |       |
| 21   |          | FIN | Kari        | Koskinen   | Coach |
| Entries: 1   |          |     |             |            |       |

# Tawastia Open Karate 2/2024

FINLAND  
Liivourentie 24, Hmeenlinna

2024.10.05 - 2024.10.05

## ENTRY LIST - OFFICIALS

### Coach

#### Porin Shotokan(JKA Pori)

|    |  |     |        |           |       |
|----|--|-----|--------|-----------|-------|
| 22 |  | FIN | Matias | Inberg    | Coach |
| 23 |  | FIN | Jarno  | Nummijrvi | Coach |
| 24 |  | FIN | Mikko  | Viitanen  | Coach |
| 25 |  | FIN | Teppo  | Yrjnkoski | Coach |

Entries: 4

#### Shotokan Hervanta Ry(Karate Hervanta)

|    |  |     |         |           |       |
|----|--|-----|---------|-----------|-------|
| 26 |  | FIN | Ishnavi | Naik      | Coach |
| 27 |  | FIN | Arun    | Ravindran | Coach |

Entries: 2

#### Sportskarate Kuopio(OM)

|    |  |     |       |          |       |
|----|--|-----|-------|----------|-------|
| 28 |  | FIN | Petri | Toivanen | Coach |
|----|--|-----|-------|----------|-------|

Entries: 1

#### Sportskarate Pori(SKP)

|    |  |     |      |        |       |
|----|--|-----|------|--------|-------|
| 29 |  | FIN | Rami | Jrvenp | Coach |
|----|--|-----|------|--------|-------|

Entries: 1

#### Tapanilan Er(Er)

|    |  |     |       |           |       |
|----|--|-----|-------|-----------|-------|
| 30 |  | FIN | Maija | Laaksonen | Coach |
| 31 |  | FIN | Jussi | Mertamo   | Coach |
| 32 |  | FIN | Satu  | Olnonen   | Coach |

Entries: 3

#### Vantaan Wado Ryu ry(Wado Ryu ry)

|    |  |     |       |       |       |
|----|--|-----|-------|-------|-------|
| 33 |  | FIN | Marko | Koivu | Coach |
|----|--|-----|-------|-------|-------|

Entries: 1

### Referee

#### Japan Karate Association Tampere ry(JKA-Tampere)

|    |  |     |          |        |         |
|----|--|-----|----------|--------|---------|
| 34 |  | FIN | Mauricio | Laakso | Referee |
|----|--|-----|----------|--------|---------|

Entries: 1

#### Porin Shotokan(JKA Pori)

|    |  |     |       |        |         |
|----|--|-----|-------|--------|---------|
| 35 |  | FIN | Vesa  | Alanko | Referee |
| 36 |  | FIN | Ilkka | Mkil   | Referee |

Entries: 2

Total Entries:36

## Daily Schedule

| Order | Bout | Phase | Weight Category | Corner | Name | Seed | NOC |
|-------|------|-------|-----------------|--------|------|------|-----|
|-------|------|-------|-----------------|--------|------|------|-----|

Daily Schedule

- Results

| Order | Bout | Start Time | Weight Category | Corner | Seed | Name | NOC | Winner | Result | Decision |
|-------|------|------------|-----------------|--------|------|------|-----|--------|--------|----------|
|-------|------|------------|-----------------|--------|------|------|-----|--------|--------|----------|



# KATA, MIEHET

Tawastia Open Karate 2/2024

**ENTRIES BY WEIGHT CATEGORY**  
**KATA, MIEHET**

As of 6 OCT 2024

| Country Code | ID | Gender | Name              | Seeding |
|--------------|----|--------|-------------------|---------|
| FIN          |    | M      | Boke Erkan        |         |
| FIN          |    | M      | Hrknen Jarno      |         |
| FIN          |    | M      | Jrvinen Otso      |         |
| FIN          |    | M      | Kamamoto Keishiro |         |
| FIN          |    | M      | Oinonen Ville     |         |
| FIN          |    | M      | Takala Akseli     |         |

# KATA, MIEHET

Tawastia Open Karate 2/2024, Liivuoentie 24, Hämeenlinna, FIN

2024-10-05

Tatami  
2 13:20

Pool  
1/1

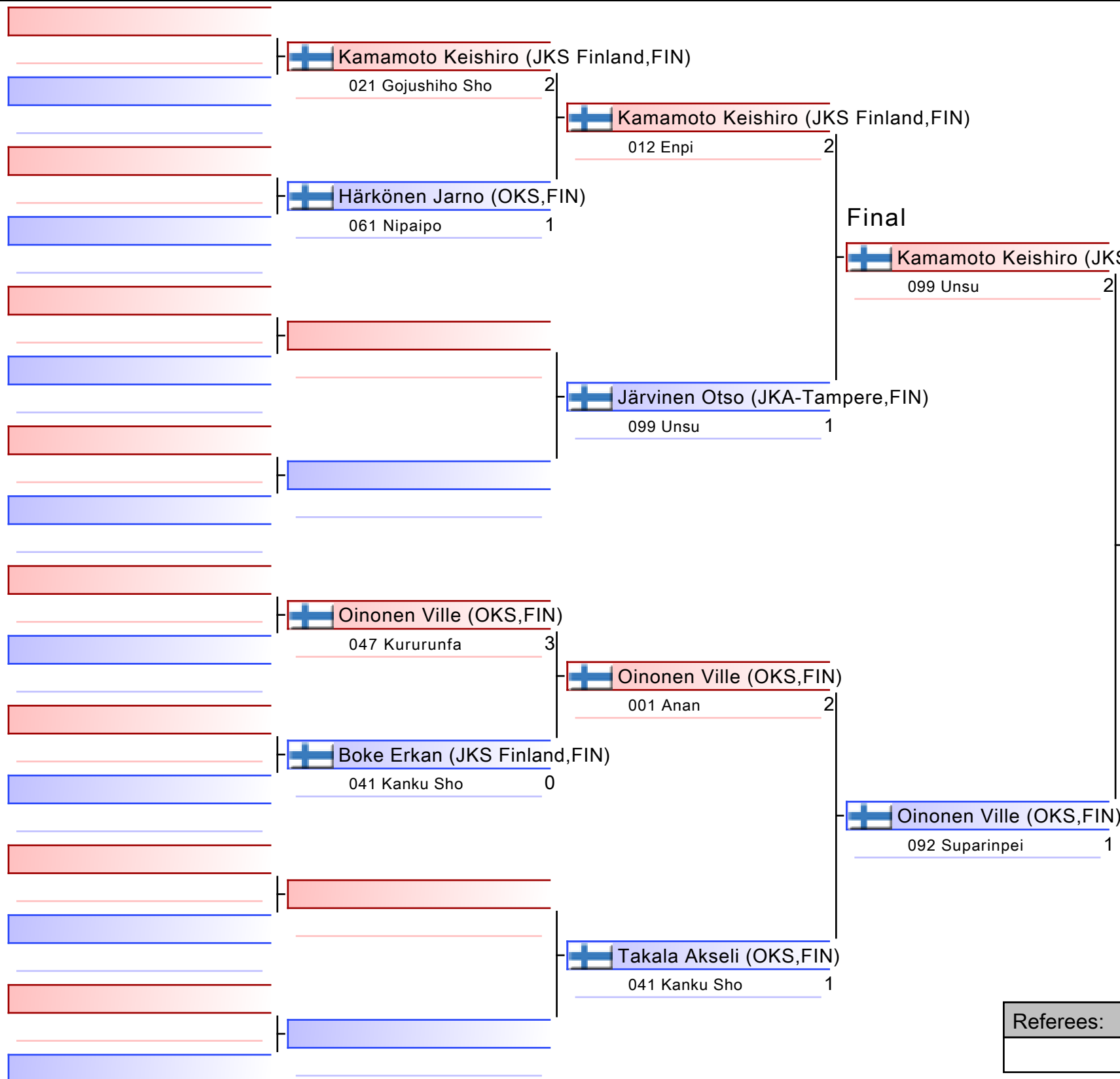

Kamamoto Keishiro (JKS Finland,FIN)

|  |
|--|
| 1. KAMAMOTO KEISHIRO (JKS FINLAND,FIN) |
| 2. OINONEN VILLE (OKS,FIN)             |
| 3. TAKALA AKSELI (OKS,FIN)             |
| 4. HÄRKÖNEN JARNO (OKS,FIN)            |
| 5. JÄRVINEN OTSO (JKA-TAMPERE,FIN)     |
| 5. BOKE ERKAN (JKS FINLAND,FIN)        |
|  |
|  |

|           |  |  |  |
|-----------|--|--|--|
| Referees: |  |  |  |
|           |  |  |  |

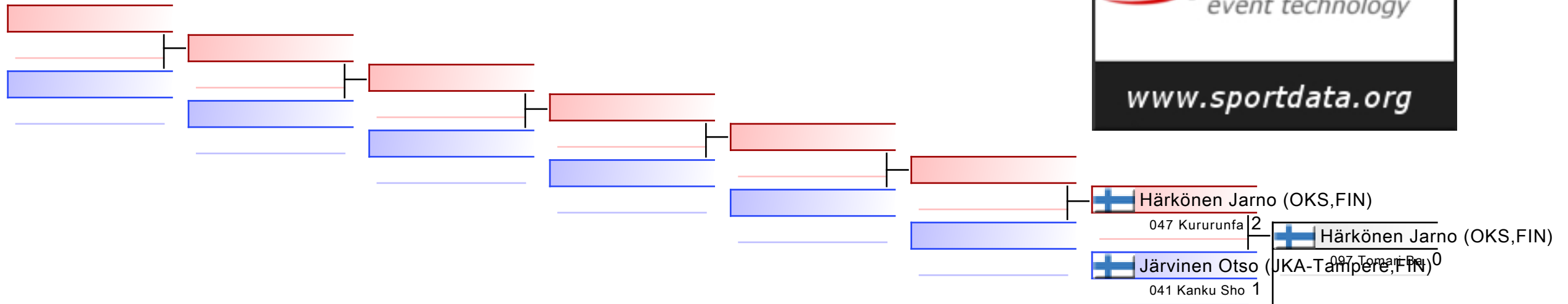

REPECHAGE: (1)

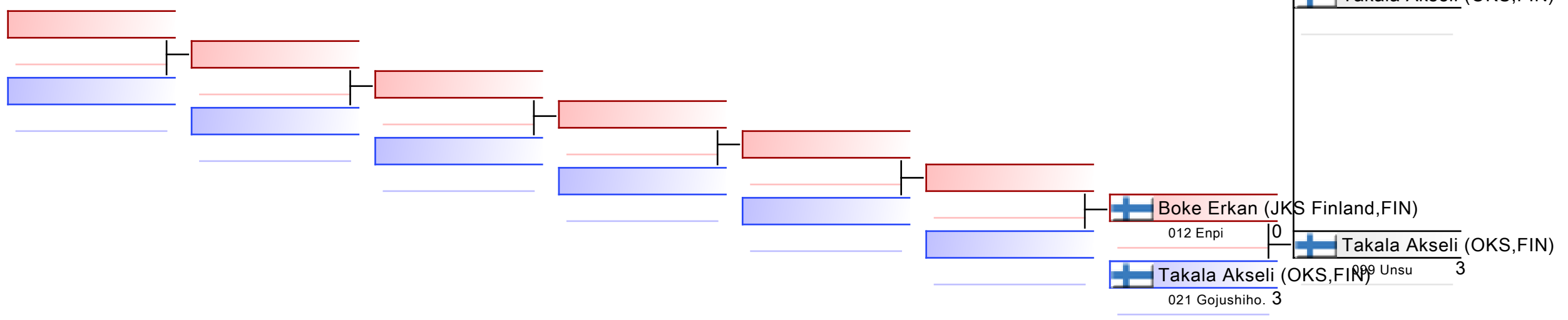

|           |  |  |  |  |  |  |  |
|-----------|--|--|--|--|--|--|--|
| Referees: |  |  |  |  |  |  |  |
|-----------|--|--|--|--|--|--|--|

# Tawastia Open Karate 2/2024

Liivuoentie 24, Hmeenlinna, FINLAND

|            |                                     |         |       |             |                        |                |    |
|------------|-------------------------------------|---------|-------|-------------|------------------------|----------------|----|
| Court Nr.  | 1                                   | Pool    | 1     | Date        | 2024-10-06             | Field Position | 57 |
| <b>RED</b> |                                     |         |       | <b>BLUE</b> |                        |                |    |
| NOC        | KAMAMOTO KEISHIRO (JKS FINLAND,FIN) |         |       | NOC         | HRKNEN JARNO (OKS,FIN) |                |    |
| Category   | KATA, MIEHET                        |         |       |             |                        |                |    |
| 3 Points   | 2 Points                            | 1 Point | Score | 1 Point     | 2 Points               | 3 Points       |    |
|            |                                     |         | :     |             |                        |                |    |
| Penatlity  |                                     |         |       | Penatlity   |                        |                |    |
|            |                                     |         |       |             |                        |                |    |
|            |                                     |         | Total |             |                        |                |    |

## Decision of Superiority

| Judge 1 | Judge 2 | Judge 3 | Judge 4 | Judge 5 | Judge 6 | Judge 7 | Referee |
|---------|---------|---------|---------|---------|---------|---------|---------|
|         |         |         |         |         |         |         |         |

Name \_\_\_\_\_  
 Signature \_\_\_\_\_



# Tawastia Open Karate 2/2024

Liivuoentie 24, Hmeenlinna, FINLAND

|            |                         |         |       |             |                              |                |    |
|------------|-------------------------|---------|-------|-------------|------------------------------|----------------|----|
| Court Nr.  | 1                       | Pool    | 1     | Date        | 2024-10-06                   | Field Position | 59 |
| <b>RED</b> |                         |         |       | <b>BLUE</b> |                              |                |    |
| NOC        | OINONEN VILLE (OKS,FIN) |         |       | NOC         | BOKE ERKAN (JKS FINLAND,FIN) |                |    |
| Category   | KATA, MIEHET            |         |       |             |                              |                |    |
| 3 Points   | 2 Points                | 1 Point | Score | 1 Point     | 2 Points                     | 3 Points       |    |
|            |                         |         | :     |             |                              |                |    |
| Penatlity  |                         |         |       | Penatlity   |                              |                |    |
|            |                         |         |       |             |                              |                |    |
|            |                         |         | Total |             |                              |                |    |

## Decision of Superiority

| Judge 1 | Judge 2 | Judge 3 | Judge 4 | Judge 5 | Judge 6 | Judge 7 | Referee |
|---------|---------|---------|---------|---------|---------|---------|---------|
|         |         |         |         |         |         |         |         |

Name \_\_\_\_\_

Signature \_\_\_\_\_



# Tawastia Open Karate 2/2024

Liivuoventie 24, Hmeenlinna, FINLAND

|            |                                     |         |       |             |                                |                |    |
|------------|-------------------------------------|---------|-------|-------------|--------------------------------|----------------|----|
| Court Nr.  | 1                                   | Pool    | 1     | Date        | 2024-10-06                     | Field Position | 61 |
| <b>RED</b> |                                     |         |       | <b>BLUE</b> |                                |                |    |
| NOC        | KAMAMOTO KEISHIRO (JKS FINLAND,FIN) |         |       | NOC         | JRVINEN OTSO (JKA-TAMPERE,FIN) |                |    |
| Category   | KATA, MIEHET                        |         |       |             |                                |                |    |
| 3 Points   | 2 Points                            | 1 Point | Score | 1 Point     | 2 Points                       | 3 Points       |    |
|            |                                     |         | :     |             |                                |                |    |
| Penatlity  |                                     |         |       | Penatlity   |                                |                |    |
|            |                                     |         |       |             |                                |                |    |
|            |                                     |         | Total |             |                                |                |    |

## Decision of Superiority

| Judge 1 | Judge 2 | Judge 3 | Judge 4 | Judge 5 | Judge 6 | Judge 7 | Referee |
|---------|---------|---------|---------|---------|---------|---------|---------|
|         |         |         |         |         |         |         |         |

Name \_\_\_\_\_  
 Signature \_\_\_\_\_



# Tawastia Open Karate 2/2024

Liivuoentie 24, Hmeenlinna, FINLAND

|            |                         |         |       |             |                         |                |    |
|------------|-------------------------|---------|-------|-------------|-------------------------|----------------|----|
| Court Nr.  | 1                       | Pool    | 1     | Date        | 2024-10-06              | Field Position | 62 |
| <b>RED</b> |                         |         |       | <b>BLUE</b> |                         |                |    |
| NOC        | OINONEN VILLE (OKS,FIN) |         |       | NOC         | TAKALA AKSELI (OKS,FIN) |                |    |
| Category   | KATA, MIEHET            |         |       |             |                         |                |    |
| 3 Points   | 2 Points                | 1 Point | Score | 1 Point     | 2 Points                | 3 Points       |    |
|            |                         |         | :     |             |                         |                |    |
| Penatlity  |                         |         |       | Penatlity   |                         |                |    |
|            |                         |         |       |             |                         |                |    |
|            |                         |         | Total |             |                         |                |    |

## Decision of Superiority

| Judge 1 | Judge 2 | Judge 3 | Judge 4 | Judge 5 | Judge 6 | Judge 7 | Referee |
|---------|---------|---------|---------|---------|---------|---------|---------|
|         |         |         |         |         |         |         |         |

Name \_\_\_\_\_

Signature \_\_\_\_\_





# Tawastia Open Karate 2/2024

Liivourentie 24, Hmeenlinna, FINLAND

|            |  |         |       |             |                         |                |    |
|------------|--|---------|-------|-------------|-------------------------|----------------|----|
| Court Nr.  | 1                                      | Pool    | 1     | Date        | 2024-10-06              | Field Position | 63 |
| <b>RED</b> |  |         |       | <b>BLUE</b> |                         |                |    |
| NOC        | KAMAMOTO KEISHIRO (JKS<br>FINLAND,FIN) |         |       | NOC         | OINONEN VILLE (OKS,FIN) |                |    |
| Category   | KATA, MIEHET                           |         |       |             |                         |                |    |
| 3 Points   | 2 Points                               | 1 Point | Score | 1 Point     | 2 Points                | 3 Points       |    |
|            |  |         | :     |             |                         |                |    |
| Penatlity  |  |         |       | Penatlity   |                         |                |    |
|            |  |         |       |             |                         |                |    |
|            |  |         | Total |             |                         |                |    |

## Decision of Superiority

| Judge 1 | Judge 2 | Judge 3 | Judge 4 | Judge 5 | Judge 6 | Judge 7 | Referee |
|---------|---------|---------|---------|---------|---------|---------|---------|
|         |         |         |         |         |         |         |         |

Name \_\_\_\_\_

Signature \_\_\_\_\_



# Tawastia Open Karate 2/2024

Liivuoentie 24, Hmeenlinna, FINLAND

|            |                        |         |       |             |                                |                |   |
|------------|------------------------|---------|-------|-------------|--------------------------------|----------------|---|
| Court Nr.  | 1                      | Pool    | 1     | Date        | 2024-10-06                     | Field Position | 0 |
| <b>RED</b> |                        |         |       | <b>BLUE</b> |                                |                |   |
| NOC        | HRKNEN JARNO (OKS,FIN) |         |       | NOC         | JRVINEN OTSO (JKA-TAMPERE,FIN) |                |   |
| Category   | KATA, MIEHET           |         |       |             |                                |                |   |
| 3 Points   | 2 Points               | 1 Point | Score | 1 Point     | 2 Points                       | 3 Points       |   |
|            |                        |         | :     |             |                                |                |   |
| Penatlity  |                        |         |       | Penatlity   |                                |                |   |
|            |                        |         |       |             |                                |                |   |
|            |                        |         | Total |             |                                |                |   |

## Decision of Superiority

| Judge 1 | Judge 2 | Judge 3 | Judge 4 | Judge 5 | Judge 6 | Judge 7 | Referee |
|---------|---------|---------|---------|---------|---------|---------|---------|
|         |         |         |         |         |         |         |         |

Name \_\_\_\_\_  
 Signature \_\_\_\_\_



# Tawastia Open Karate 2/2024

Liivuoentie 24, Hmeenlinna, FINLAND

|            |                              |         |       |             |                         |                |   |
|------------|------------------------------|---------|-------|-------------|-------------------------|----------------|---|
| Court Nr.  | 2                            | Pool    | 2     | Date        | 2024-10-06              | Field Position | 0 |
| <b>RED</b> |                              |         |       | <b>BLUE</b> |                         |                |   |
| NOC        | BOKE ERKAN (JKS FINLAND,FIN) |         |       | NOC         | TAKALA AKSELI (OKS,FIN) |                |   |
| Category   | KATA, MIEHET                 |         |       |             |                         |                |   |
| 3 Points   | 2 Points                     | 1 Point | Score | 1 Point     | 2 Points                | 3 Points       |   |
|            |                              |         | :     |             |                         |                |   |
| Penatlity  |                              |         |       | Penatlity   |                         |                |   |
|            |                              |         |       |             |                         |                |   |
|            |                              |         | Total |             |                         |                |   |

## Decision of Superiority

| Judge 1 | Judge 2 | Judge 3 | Judge 4 | Judge 5 | Judge 6 | Judge 7 | Referee |
|---------|---------|---------|---------|---------|---------|---------|---------|
|         |         |         |         |         |         |         |         |

Name \_\_\_\_\_

Signature \_\_\_\_\_



## Official Results

| KATA, MIEHET |                   |  |   |               |  |
|--------------|-------------------|--|---|---------------|--|
| 1            | KAMAMOTO KEISHIRO | JKS FINLAND -<br>SHOTOKAN KARATE<br>HELSINKI |  | FIN - FINLAND |  |
| 2            | OINONEN VILLE     | OUTOKUMMUN<br>KARATESEURA RY                 |  | FIN - FINLAND |  |
| 3            | TAKALA AKSELI     | OULUN<br>KARATESEURA                         |  | FIN - FINLAND |  |
| 4            | HÄRKÖNEN JARNO    | OUTOKUMMUN<br>KARATESEURA RY                 |  | FIN - FINLAND |  |
| 5            | JÄRVINEN OTSO     | JAPAN KARATE<br>ASSOCIATION<br>TAMPERE RY    |  | FIN - FINLAND |  |
| 5            | BOKE ERKAN        | JKS FINLAND -<br>SHOTOKAN KARATE<br>HELSINKI |  | FIN - FINLAND |  |

# KATA, NAISSET

Tawastia Open Karate 2/2024

**ENTRIES BY WEIGHT CATEGORY**  
**KATA, NAISET**

As of 6 OCT 2024

| Country Code | ID | Gender | Name           | Seeding |
|--------------|----|--------|----------------|---------|
| FIN          |    | F      | Alatalo Onerva |         |
| FIN          |    | F      | Hintikka Maria |         |
| FIN          |    | F      | Lehtinen Nea   |         |
| FIN          |    | F      | Yamate Sakino  |         |

# KATA, NAISET

Tawastia Open Karate 2/2024, Liivuoentie 24, Hämeenlinna, FIN

2024-10-05

Tatami  
2 12:50

Pool  
1/1

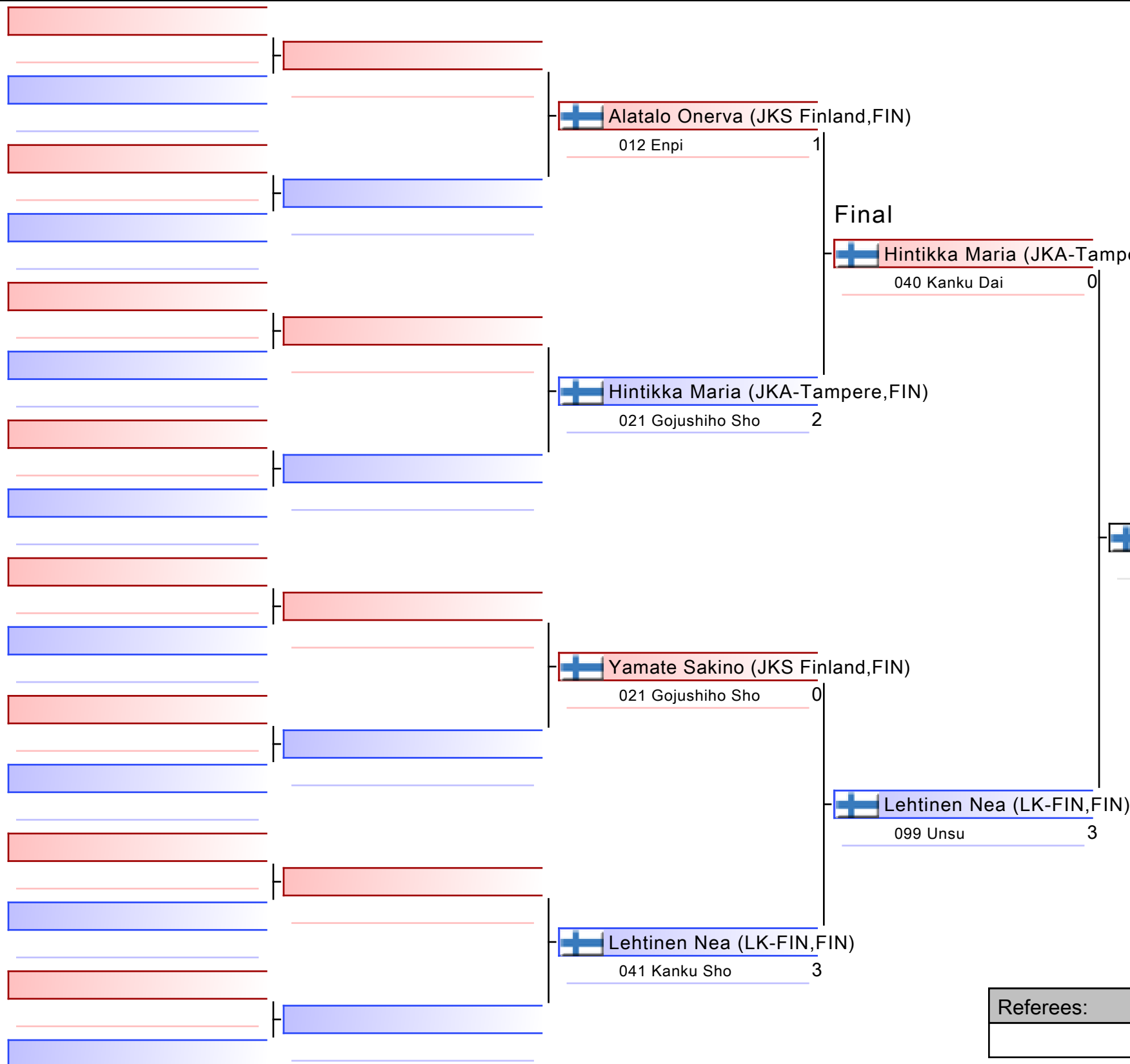

|                                     |
|-------------------------------------|
| 1. LEHTINEN NEA (LK-FIN,FIN)        |
| 2. HINTIKKA MARIA (JKA-TAMPERE,FIN) |
| 3. ALATALO ONERVA (JKS FINLAND,FIN) |
| 4. YAMATE SAKINO (JKS FINLAND,FIN)  |
|                                     |
|                                     |
|                                     |

|           |  |  |  |
|-----------|--|--|--|
| Referees: |  |  |  |
|           |  |  |  |

# KATA, NAISSET

Tawastia Open Karate 2/2024

2024-10-05

Tatami  
2 12:50

Pool  
1

(c)sportdata GmbH & Co KG 2000-2024 (2024-10-06 10:03) v 10.2.0 build 1 (2024-09-26 10:14 CET) License: Online\_Event\_ID-8546\_TawastiaOpenKarate22024 (expire 2024-10-20)

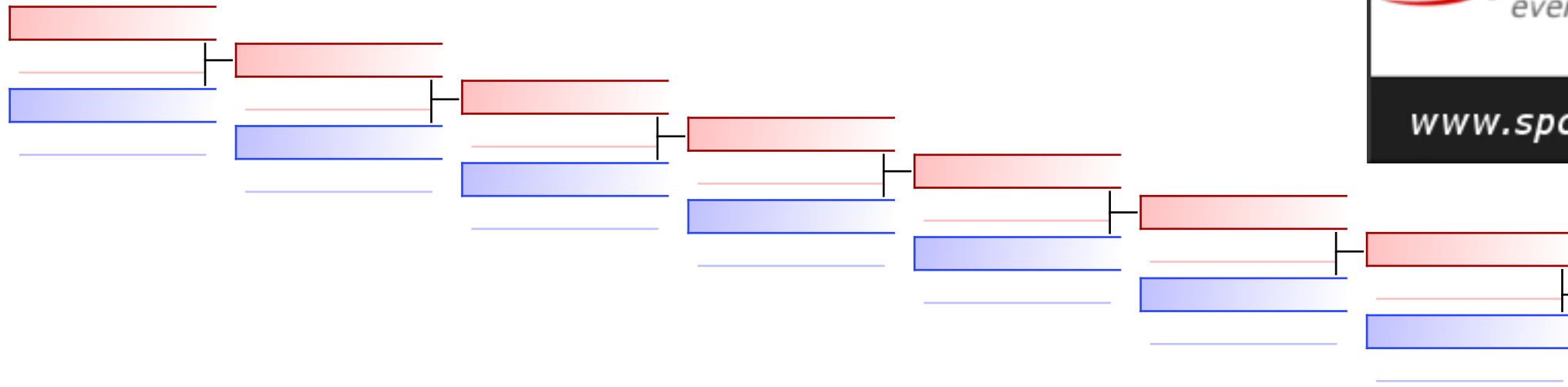

## REPECHAGE: (1)

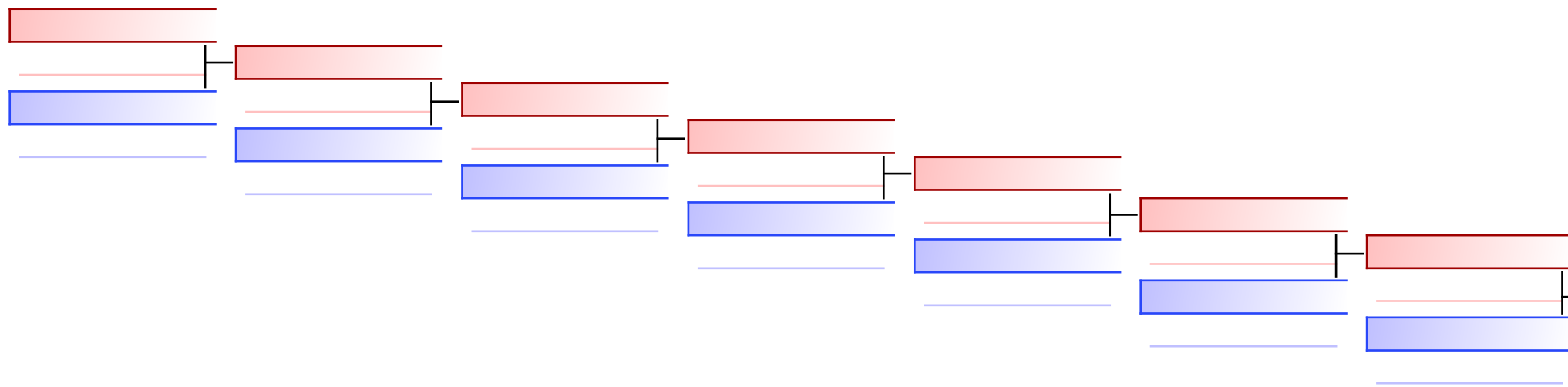

 Alatalo Onerva (JKS Finland,FIN)  
015 Gankaku 2

 Alatalo Onerva (JKS Finland,FIN)

 Yamate Sakino (JKS Finland,FIN)  
099 Unsu 1

|           |  |  |  |  |  |  |  |
|-----------|--|--|--|--|--|--|--|
| Referees: |  |  |  |  |  |  |  |
|-----------|--|--|--|--|--|--|--|



# Tawastia Open Karate 2/2024

Liivuoentie 24, Hmeenlinna, FINLAND

|                 |                                  |         |       |             |                                  |                |    |
|-----------------|----------------------------------|---------|-------|-------------|----------------------------------|----------------|----|
| Court Nr.       | 1                                | Pool    | 1     | Date        | 2024-10-06                       | Field Position | 61 |
| <b>RED</b>      |                                  |         |       | <b>BLUE</b> |                                  |                |    |
| <b>NOC</b>      | ALATALO ONERVA (JKS FINLAND,FIN) |         |       | <b>NOC</b>  | HINTIKKA MARIA (JKA-TAMPERE,FIN) |                |    |
| <b>Category</b> | KATA, NAISET                     |         |       |             |                                  |                |    |
| 3 Points        | 2 Points                         | 1 Point | Score | 1 Point     | 2 Points                         | 3 Points       |    |
|                 |                                  |         | :     |             |                                  |                |    |
| Penatlity       |                                  |         |       | Penatlity   |                                  |                |    |
|                 |                                  |         |       |             |                                  |                |    |
|                 |                                  |         | Total |             |                                  |                |    |

## Decision of Superiority

| Judge 1 | Judge 2 | Judge 3 | Judge 4 | Judge 5 | Judge 6 | Judge 7 | Referee |
|---------|---------|---------|---------|---------|---------|---------|---------|
|         |         |         |         |         |         |         |         |

Name \_\_\_\_\_

Signature \_\_\_\_\_



# Tawastia Open Karate 2/2024

Liivuoentie 24, Hmeenlinna, FINLAND

|            |                                 |         |       |             |                           |                |    |
|------------|---------------------------------|---------|-------|-------------|---------------------------|----------------|----|
| Court Nr.  | 1                               | Pool    | 1     | Date        | 2024-10-06                | Field Position | 62 |
| <b>RED</b> |                                 |         |       | <b>BLUE</b> |                           |                |    |
| NOC        | YAMATE SAKINO (JKS FINLAND,FIN) |         |       | NOC         | LEHTINEN NEA (LK-FIN,FIN) |                |    |
| Category   | KATA, NAISET                    |         |       |             |                           |                |    |
| 3 Points   | 2 Points                        | 1 Point | Score | 1 Point     | 2 Points                  | 3 Points       |    |
|            |                                 |         | :     |             |                           |                |    |
| Penatlity  |                                 |         |       | Penatlity   |                           |                |    |
|            |                                 |         |       |             |                           |                |    |
|            |                                 |         | Total |             |                           |                |    |

## Decision of Superiority

|         |         |         |         |         |         |         |         |
|---------|---------|---------|---------|---------|---------|---------|---------|
| Judge 1 | Judge 2 | Judge 3 | Judge 4 | Judge 5 | Judge 6 | Judge 7 | Referee |
|         |         |         |         |         |         |         |         |

Name \_\_\_\_\_

Signature \_\_\_\_\_



# Tawastia Open Karate 2/2024

Liivuoentie 24, Hmeenlinna, FINLAND

|            |                                  |         |       |             |                           |                |    |
|------------|----------------------------------|---------|-------|-------------|---------------------------|----------------|----|
| Court Nr.  | 1                                | Pool    | 1     | Date        | 2024-10-06                | Field Position | 63 |
| <b>RED</b> |                                  |         |       | <b>BLUE</b> |                           |                |    |
| NOC        | HINTIKKA MARIA (JKA-TAMPERE,FIN) |         |       | NOC         | LEHTINEN NEA (LK-FIN,FIN) |                |    |
| Category   | KATA, NAISET                     |         |       |             |                           |                |    |
| 3 Points   | 2 Points                         | 1 Point | Score | 1 Point     | 2 Points                  | 3 Points       |    |
|            |                                  |         | :     |             |                           |                |    |
| Penatlity  |                                  |         |       | Penatlity   |                           |                |    |
|            |                                  |         |       |             |                           |                |    |
|            |                                  |         | Total |             |                           |                |    |

## Decision of Superiority

| Judge 1 | Judge 2 | Judge 3 | Judge 4 | Judge 5 | Judge 6 | Judge 7 | Referee |
|---------|---------|---------|---------|---------|---------|---------|---------|
|         |         |         |         |         |         |         |         |





Name \_\_\_\_\_

Signature \_\_\_\_\_





## Official Results

| KATA, NAISET |                |  |   |               |
|--------------|----------------|--|---|---------------|
| 1            | LEHTINEN NEA   | LAHDEN KARATE                                |  | FIN - FINLAND |
| 2            | HINTIKKA MARIA | JAPAN KARATE<br>ASSOCIATION<br>TAMPERE RY    |  | FIN - FINLAND |
| 3            | ALATALO ONERVA | JKS FINLAND -<br>SHOTOKAN KARATE<br>HELSINKI |  | FIN - FINLAND |
| 4            | YAMATE SAKINO  | JKS FINLAND -<br>SHOTOKAN KARATE<br>HELSINKI |  | FIN - FINLAND |

KUMITE, POJAT, VALKOISET JA  
KELTAISET U8

Tawastia Open Karate 2/2024

**ENTRIES BY WEIGHT CATEGORY**  
**KUMITE, POJAT, VALKOISET JA KELTAISET U8**

As of 6 OCT 2024

| Country Code | ID | Gender | Name           | Seeding |
|--------------|----|--------|----------------|---------|
| FIN          |    | M      | Tejesvi Vivaan |         |
| FIN          |    | M      | Teppo Eino     |         |
| FIN          |    | M      | Teppo Vin      |         |

# KUMITE, POJAT, VALKOISET JA KELTAISET U8 - Round Robin (each against each)

Tawastia Open Karate 2/2024, Liivourentie 24, Hämeenlinna, FIN









2024-10-05

Tatami

1 11:05

Pool

1/1

|   |  |   |   |
|---|--|---|---|
| 1 |  Teppo Eino (Jigotai,FIN)  | 0 |  Tejesvi Vivaan (OKS,FIN)  |
| 2 |  Tejesvi Vivaan (OKS,FIN)  | 2 |   |
| 3 |  Teppo Eino (Jigotai,FIN)  | 0 |  Teppo Väinö (Jigotai,FIN) |
| 4 |  Teppo Väinö (Jigotai,FIN) | 2 |   |
| 5 |  Tejesvi Vivaan (OKS,FIN)  | 2 |  Tejesvi Vivaan (OKS,FIN)  |
| 6 |  Teppo Väinö (Jigotai,FIN) | 0 |   |



|                              |
|------------------------------|
| 1. TEJESVI VIVAAN (OKS,FIN)  |
| 2. TEPPO VÄINÖ (JIGOTAI,FIN) |
| 3. TEPPO EINO (JIGOTAI,FIN)  |
|                              |
|                              |
|                              |
|                              |

|           |  |  |  |
|-----------|--|--|--|
| Referees: |  |  |  |
|           |  |  |  |



# Tawastia Open Karate 2/2024

Liivuoentie 24, Hmeenlinna, FINLAND

|            |  |         |            |             |                          |                |       |
|------------|--|---------|------------|-------------|--------------------------|----------------|-------|
| Court Nr.  | 1  | Pool    | 1          | Date        | 2024-10-06               | Field Position | -9951 |
| <b>RED</b> |  |         |            | <b>BLUE</b> |                          |                |       |
| NOC        | TEPPO EINO (JIGOTAI,FIN)                 |         |            | NOC         | TEJESVI VIVAAN (OKS,FIN) |                |       |
| Category   | KUMITE, POJAT, VALKOISET JA KELTAISET U8 |         |            |             |                          |                |       |
| 3 Points   | 2 Points                                 | 1 Point | Score      | 1 Point     | 2 Points                 | 3 Points       |       |
|            |  |         | 0 : 2      |             |                          |                |       |
| Penatlity  |  |         |            | Penatlity   |                          |                |       |
| C1: , C2:  |  |         | <b>0:2</b> | C1: , C2:   |                          |                |       |
|            |  |         | Total      | WINNER      |                          |                |       |

PTS

## Decision of Superiority

| Judge 1 | Judge 2 | Judge 3 | Judge 4 | Judge 5 | Judge 6 | Judge 7 | Referee |
|---------|---------|---------|---------|---------|---------|---------|---------|
|         |         |         |         |         |         |         |         |

Name

Signature

\_\_\_\_\_  
\_\_\_\_\_



# Tawastia Open Karate 2/2024

Liivuoentie 24, Hmeenlinna, FINLAND

|            |  |         |            |             |                         |                |       |
|------------|--|---------|------------|-------------|-------------------------|----------------|-------|
| Court Nr.  | 1  | Pool    | 1          | Date        | 2024-10-06              | Field Position | -9950 |
| <b>RED</b> |  |         |            | <b>BLUE</b> |                         |                |       |
| NOC        | TEPPO EINO (JIGOTAI,FIN)                 |         |            | NOC         | TEPPO VIN (JIGOTAI,FIN) |                |       |
| Category   | KUMITE, POJAT, VALKOISET JA KELTAISET U8 |         |            |             |                         |                |       |
| 3 Points   | 2 Points                                 | 1 Point | Score      | 1 Point     | 2 Points                | 3 Points       |       |
|            |  |         | 0 : 2      |             |                         |                |       |
| Penatlity  |  |         |            | Penatlity   |                         |                |       |
| C1: , C2:  |  |         | <b>0:2</b> | C1: , C2:   |                         |                |       |
|            |  |         | Total      | WINNER      |                         |                |       |

PTS

## Decision of Superiority

| Judge 1 | Judge 2 | Judge 3 | Judge 4 | Judge 5 | Judge 6 | Judge 7 | Referee |
|---------|---------|---------|---------|---------|---------|---------|---------|
|         |         |         |         |         |         |         |         |

Name

Signature

\_\_\_\_\_  
\_\_\_\_\_



# Tawastia Open Karate 2/2024

Liivuoentie 24, Hmeenlinna, FINLAND

|            |  |         |            |             |                         |                |       |
|------------|--|---------|------------|-------------|-------------------------|----------------|-------|
| Court Nr.  | 1  | Pool    | 1          | Date        | 2024-10-06              | Field Position | -9949 |
| <b>RED</b> |  |         |            | <b>BLUE</b> |                         |                |       |
| NOC        | TEJESVI VIVAAN (OKS,FIN)                 |         |            | NOC         | TEPPO VIN (JIGOTAI,FIN) |                |       |
| Category   | KUMITE, POJAT, VALKOISET JA KELTAISET U8 |         |            |             |                         |                |       |
| 3 Points   | 2 Points                                 | 1 Point | Score      | 1 Point     | 2 Points                | 3 Points       |       |
|            |  |         | 2 : 0      |             |                         |                |       |
| Penatlity  |  |         |            | Penatlity   |                         |                |       |
| C1: , C2:  |  |         | <b>2:0</b> | C1: , C2:   |                         |                |       |
| WINNER     |  |         | Total      |             |                         |                |       |

PTS

## Decision of Superiority

| Judge 1 | Judge 2 | Judge 3 | Judge 4 | Judge 5 | Judge 6 | Judge 7 | Referee |
|---------|---------|---------|---------|---------|---------|---------|---------|
|         |         |         |         |         |         |         |         |

Name



Signature

\_\_\_\_\_  
\_\_\_\_\_



Tawastia Open Karate 2/2024 - 2024-10-05

Official Results

| KUMITE, POJAT, VALKOISET JA KELTAISET U8 |                |                      |   |               |
|--|----------------|----------------------|---|---------------|
| 1  | TEJESVI VIVAAN | OULUN<br>KARATESEURA |  | FIN - FINLAND |
| 2  | TEPPO VÄINÖ    | JIGOTAI KARATE       |  | FIN - FINLAND |
| 3  | TEPPO EINO     | JIGOTAI KARATE       |  | FIN - FINLAND |

# KATA, MIEHET, +35-VUOTIAAT

Tawastia Open Karate 2/2024

**ENTRIES BY WEIGHT CATEGORY**  
**Kata, miehet, +35-vuotiaat**

As of 6 OCT 2024

| Country Code | ID | Gender | Name               | Seeding |
|--------------|----|--------|--------------------|---------|
| FIN          |    | M      | Casci Giangabriele |         |
| FIN          |    | M      | Hrknen Jarno       |         |
| FIN          |    | M      | Oinonen Ville      |         |

# Kata, miehet, +35-vuotiaat

Tawastia Open Karate 2/2024, Liivourentie 24, Hämeenlinna, FIN

2024-10-05

Tatami  
2 12:35

Pool  
1/1

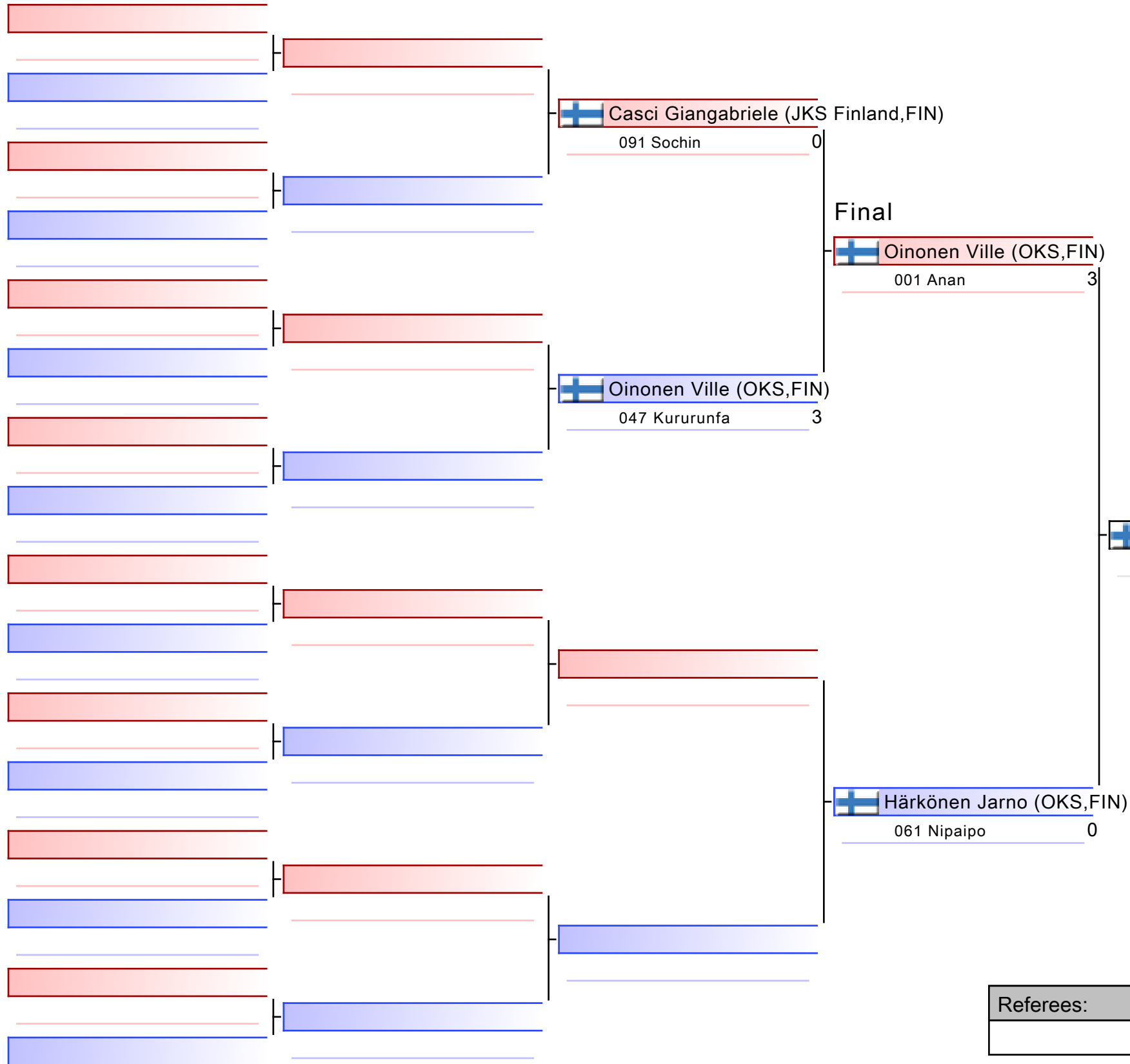

**Oinonen Ville (OKS, FIN)**

|   |
|---|
| 1. OINONEN VILLE (OKS,FIN)              |
| 2. HÄRKÖNEN JARNO (OKS,FIN)             |
| 3. CASCI GIANGABRIELE (JKS FINLAND,FIN) |
|   |
|   |
|   |
|   |

|           |  |  |  |
|-----------|--|--|--|
| Referees: |  |  |  |
|           |  |  |  |

# Kata, miehet, +35-vuotiaat

Tawastia Open Karate 2/2024

2024-10-05

Tatami  
2 12:35

Pool  
1

(c)sportdata GmbH & Co KG 2000-2024 (2024-10-06 10:03) v 10.2.0 build 1 (2024-09-26 10:14 CET) License: Online\_Event\_ID-8546\_TawastiaOpenKarate2024 (expire 2024-10-20)

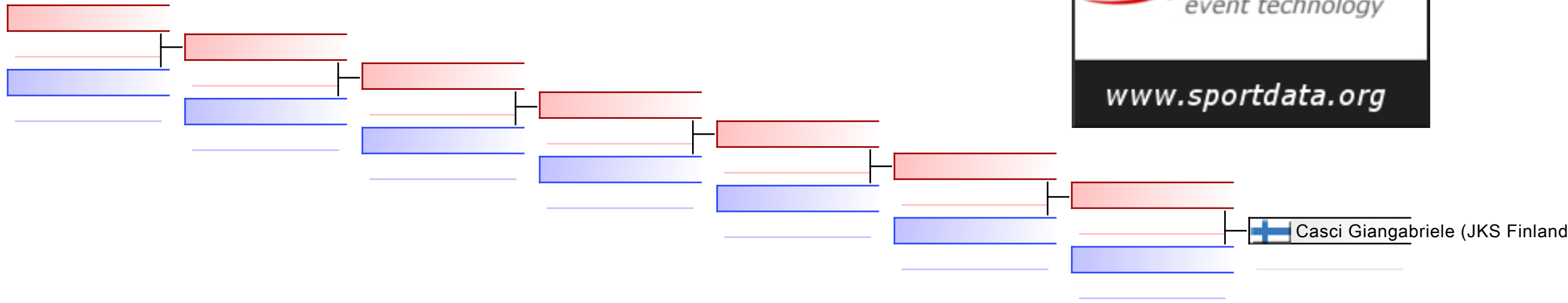

## REPECHAGE: (1)

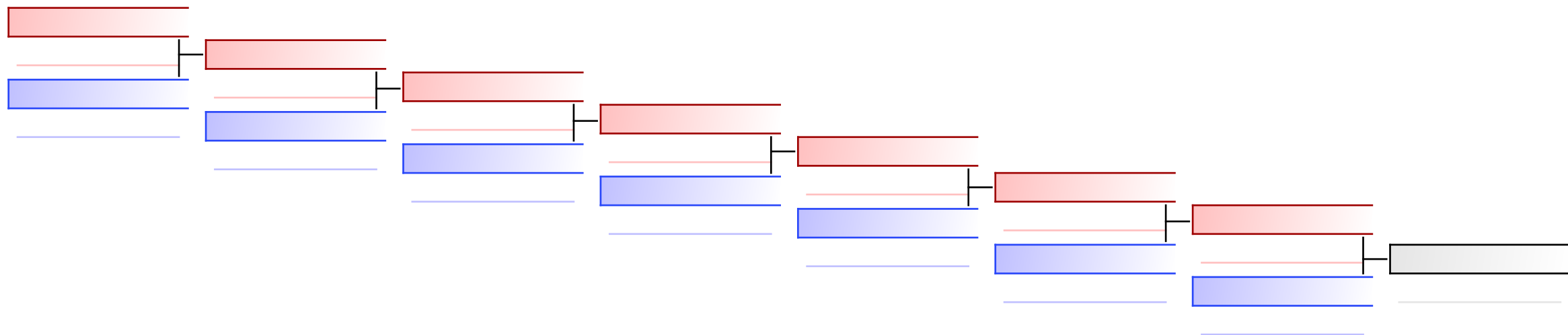

|           |  |  |  |  |  |  |  |
|-----------|--|--|--|--|--|--|--|
| Referees: |  |  |  |  |  |  |  |
|-----------|--|--|--|--|--|--|--|



# Tawastia Open Karate 2/2024

Liivuoentie 24, Hmeenlinna, FINLAND

|            |                                      |         |       |             |                         |                |    |
|------------|--------------------------------------|---------|-------|-------------|-------------------------|----------------|----|
| Court Nr.  | 1                                    | Pool    | 1     | Date        | 2024-10-06              | Field Position | 61 |
| <b>RED</b> |                                      |         |       | <b>BLUE</b> |                         |                |    |
| NOC        | CASCI GIANGABRIELE (JKS FINLAND,FIN) |         |       | NOC         | OINONEN VILLE (OKS,FIN) |                |    |
| Category   | Kata, miehet, +35-vuotiaat           |         |       |             |                         |                |    |
| 3 Points   | 2 Points                             | 1 Point | Score | 1 Point     | 2 Points                | 3 Points       |    |
|            |                                      |         | :     |             |                         |                |    |
| Penatlity  |                                      |         |       | Penatlity   |                         |                |    |
|            |                                      |         |       |             |                         |                |    |
|            |                                      |         | Total |             |                         |                |    |

## Decision of Superiority

| Judge 1 | Judge 2 | Judge 3 | Judge 4 | Judge 5 | Judge 6 | Judge 7 | Referee |
|---------|---------|---------|---------|---------|---------|---------|---------|
|         |         |         |         |         |         |         |         |

Name \_\_\_\_\_  
 Signature \_\_\_\_\_



# Tawastia Open Karate 2/2024

Liivuoentie 24, Hmeenlinna, FINLAND

|            |                            |         |       |             |                        |                |    |
|------------|----------------------------|---------|-------|-------------|------------------------|----------------|----|
| Court Nr.  | 1                          | Pool    | 1     | Date        | 2024-10-06             | Field Position | 63 |
| <b>RED</b> |                            |         |       | <b>BLUE</b> |                        |                |    |
| NOC        | OINONEN VILLE (OKS,FIN)    |         |       | NOC         | HRKNEN JARNO (OKS,FIN) |                |    |
| Category   | Kata, miehet, +35-vuotiaat |         |       |             |                        |                |    |
| 3 Points   | 2 Points                   | 1 Point | Score | 1 Point     | 2 Points               | 3 Points       |    |
|            |                            |         | :     |             |                        |                |    |
| Penatlity  |                            |         |       | Penatlity   |                        |                |    |
|            |                            |         |       |             |                        |                |    |
|            |                            |         | Total |             |                        |                |    |

## Decision of Superiority

|         |         |         |         |         |         |         |         |
|---------|---------|---------|---------|---------|---------|---------|---------|
| Judge 1 | Judge 2 | Judge 3 | Judge 4 | Judge 5 | Judge 6 | Judge 7 | Referee |
|         |         |         |         |         |         |         |         |

Name

Signature



\_\_\_\_\_

\_\_\_\_\_





## Official Results

| Kata, miehet, +35-vuotiaat |                    |  |   |               |
|----------------------------|--------------------|--|---|---------------|
| 1                          | OINONEN VILLE      | OUTOKUMMUN<br>KARATESEURA RY                 |  | FIN - FINLAND |
| 2                          | HÄRKÖNEN JARNO     | OUTOKUMMUN<br>KARATESEURA RY                 |  | FIN - FINLAND |
| 3                          | CASCI GIANGABRIELE | JKS FINLAND -<br>SHOTOKAN KARATE<br>HELSINKI |  | FIN - FINLAND |

# KATA, MIEHET, U21

Tawastia Open Karate 2/2024

**ENTRIES BY WEIGHT CATEGORY**  
**Kata, miehet, U21**

As of 6 OCT 2024

| Country Code | ID | Gender | Name          | Seeding |
|--------------|----|--------|---------------|---------|
| FIN          |    | M      | Mantere Jimi  |         |
| FIN          |    | M      | Takala Akseli |         |

# Kata, miehet, U21

Tawastia Open Karate 2/2024, Liivourentie 24, Hämeenlinna, FIN

2024-10-05

Tatami  
2 13:55

Pool  
1/1

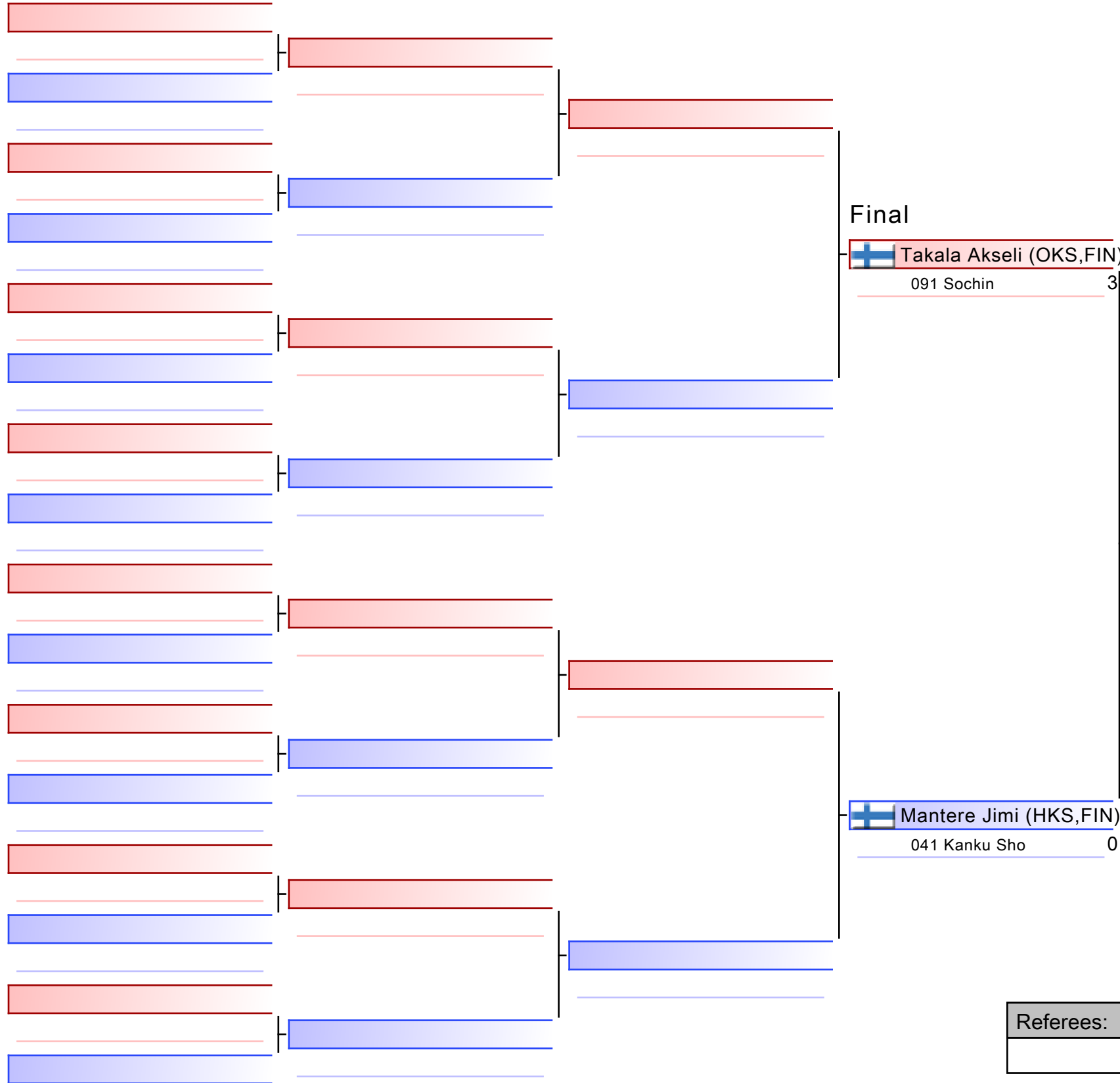

Takala Akseli (OKS,FIN)

|                            |
|----------------------------|
| 1. TAKALA AKSELI (OKS,FIN) |
| 2. MANTERE JIMI (HKS,FIN)  |
|                            |
|                            |
|                            |
|                            |
|                            |

|           |  |  |  |
|-----------|--|--|--|
| Referees: |  |  |  |
|           |  |  |  |

# Tawastia Open Karate 2/2024

Liivuoentie 24, Hmeenlinna, FINLAND

|            |                         |         |       |             |                        |                |    |
|------------|-------------------------|---------|-------|-------------|------------------------|----------------|----|
| Court Nr.  | 1                       | Pool    | 1     | Date        | 2024-10-06             | Field Position | 63 |
| <b>RED</b> |                         |         |       | <b>BLUE</b> |                        |                |    |
| NOC        | TAKALA AKSELI (OKS,FIN) |         |       | NOC         | MANTERE JIMI (HKS,FIN) |                |    |
| Category   | Kata, miehet, U21       |         |       |             |                        |                |    |
| 3 Points   | 2 Points                | 1 Point | Score | 1 Point     | 2 Points               | 3 Points       |    |
|            |                         |         | :     |             |                        |                |    |
| Penatlity  |                         |         |       | Penatlity   |                        |                |    |
|            |                         |         |       |             |                        |                |    |
|            |                         |         | Total |             |                        |                |    |

## Decision of Superiority

| Judge 1 | Judge 2 | Judge 3 | Judge 4 | Judge 5 | Judge 6 | Judge 7 | Referee |
|---------|---------|---------|---------|---------|---------|---------|---------|
|         |         |         |         |         |         |         |         |

Name \_\_\_\_\_



Signature \_\_\_\_\_





Tawastia Open Karate 2/2024 - 2024-10-05

Official Results

| Kata, miehet, U21 |               |                             |   |               |  |
|-------------------|---------------|-----------------------------|---|---------------|--|
| 1                 | TAKALA AKSELI | OULUN<br>KARATESEURA        |  | FIN - FINLAND |  |
| 2                 | MANTERE JIMI  | HÄMEENLINNAN<br>KARATESEURA |  | FIN - FINLAND |  |

# KATA, NAISSET, U21

Tawastia Open Karate 2/2024

**ENTRIES BY WEIGHT CATEGORY**  
**Kata, naiset, U21**

As of 6 OCT 2024

| Country Code | ID | Gender | Name         | Seeding |
|--------------|----|--------|--------------|---------|
| FIN          |    | F      | Lantta Wiivi |         |
| FIN          |    | F      | Lehtinen Nea |         |

# Kata, naiset, U21

Tawastia Open Karate 2/2024, Liivourentie 24, Hämeenlinna, FIN

2024-10-05

Tatami  
2 12:30

Pool  
1/1

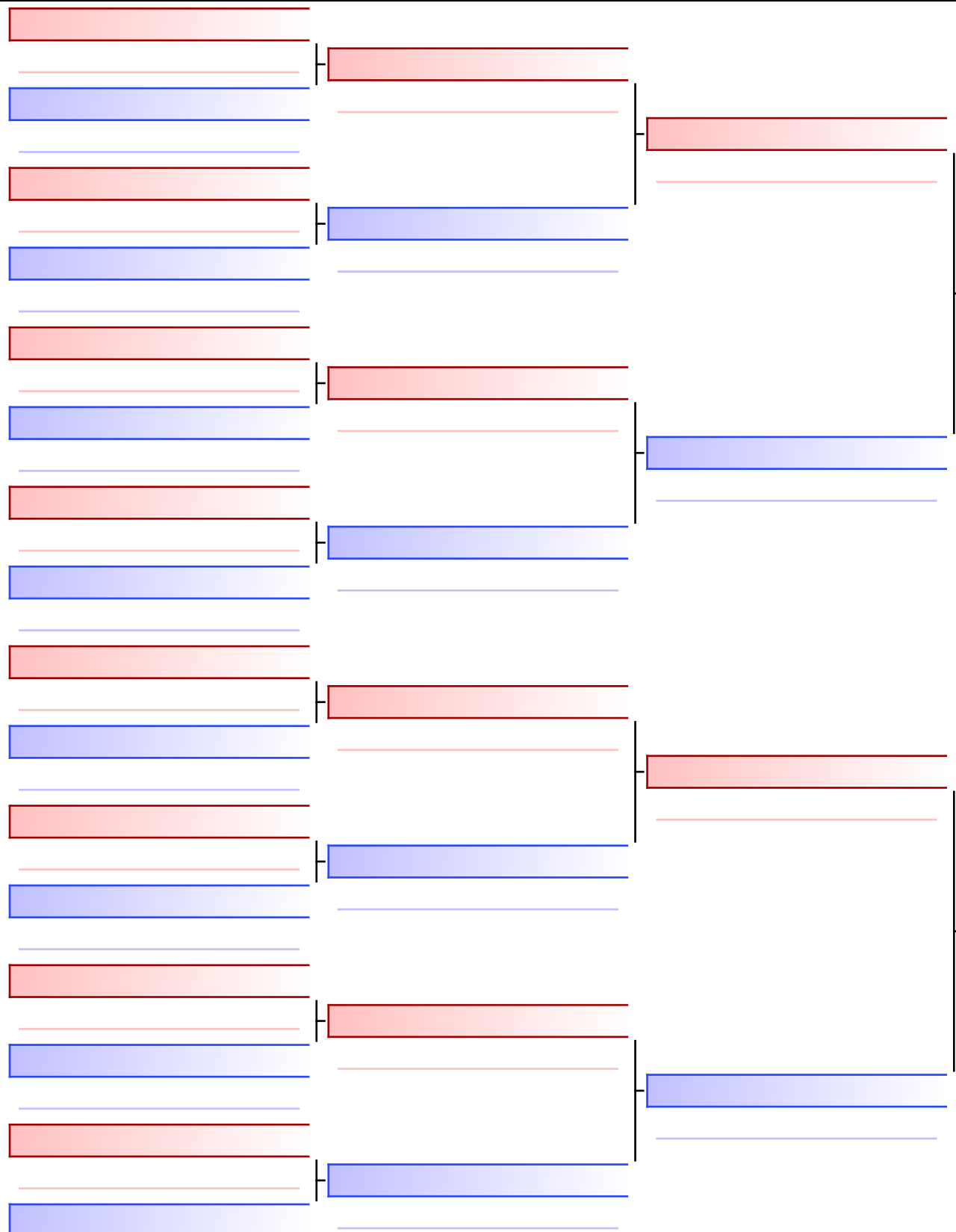

## Final

Lantta Wiivi (JKA-Tampere,FIN)

047 Kururunfa 0

Lehtinen Nea (LK-FIN,FIN)

Lehtinen Nea (LK-FIN,FIN)

021 Gojushiho Sho 3

|                                   |
|-----------------------------------|
| 1. LEHTINEN NEA (LK-FIN,FIN)      |
| 2. LANTTA WIIVI (JKA-TAMPERE,FIN) |
|                                   |
|                                   |
|                                   |
|                                   |
|                                   |

|           |  |  |  |
|-----------|--|--|--|
| Referees: |  |  |  |
|           |  |  |  |

# Tawastia Open Karate 2/2024

Liivuoentie 24, Hmeenlinna, FINLAND

|            |                                |         |       |             |                           |                |    |
|------------|--------------------------------|---------|-------|-------------|---------------------------|----------------|----|
| Court Nr.  | 1                              | Pool    | 1     | Date        | 2024-10-06                | Field Position | 63 |
| <b>RED</b> |                                |         |       | <b>BLUE</b> |                           |                |    |
| NOC        | LANTTA WIIVI (JKA-TAMPERE,FIN) |         |       | NOC         | LEHTINEN NEA (LK-FIN,FIN) |                |    |
| Category   | Kata, naiset, U21              |         |       |             |                           |                |    |
| 3 Points   | 2 Points                       | 1 Point | Score | 1 Point     | 2 Points                  | 3 Points       |    |
|            |                                |         | :     |             |                           |                |    |
| Penatlity  |                                |         |       | Penatlity   |                           |                |    |
|            |                                |         |       |             |                           |                |    |
|            |                                |         | Total |             |                           |                |    |

## Decision of Superiority



| Judge 1 | Judge 2 | Judge 3 | Judge 4 | Judge 5 | Judge 6 | Judge 7 | Referee |
|---------|---------|---------|---------|---------|---------|---------|---------|
|         |         |         |         |         |         |         |         |

Name \_\_\_\_\_  
 Signature \_\_\_\_\_



Tawastia Open Karate 2/2024 - 2024-10-05

Official Results

| Kata, naiset, U21 |              |   |   |               |
|-------------------|--------------|---|---|---------------|
| 1                 | LEHTINEN NEA | LAHDEN KARATE                             |  | FIN - FINLAND |
| 2                 | LANTTA WIIVI | JAPAN KARATE<br>ASSOCIATION<br>TAMPERE RY |  | FIN - FINLAND |

# KATA, POJAT, U12

Tawastia Open Karate 2/2024

**ENTRIES BY WEIGHT CATEGORY**  
**Kata, pojat, U12**

As of 6 OCT 2024

| Country Code | ID | Gender | Name                      | Seeding |
|--------------|----|--------|---------------------------|---------|
| FIN          |    | M      | Kanerva Niilo             |         |
| FIN          |    | M      | Lakka Teuvo               |         |
| FIN          |    | M      | Palukuru Ronith           |         |
| FIN          |    | M      | Roihupalo Leo             |         |
| FIN          |    | M      | Siivonen Kimi             |         |
| FIN          |    | M      | Sudharsan Anirudh Gopalan |         |
| FIN          |    | M      | Tejesvi Shashank          |         |
| FIN          |    | M      | Valve Verner              |         |



# Kata, pojat, U12

Tawastia Open Karate 2/2024, Liivourentie 24, Hämeenlinna, FIN

2024-10-05

Tatami  
1 13:05

Pool  
1/1

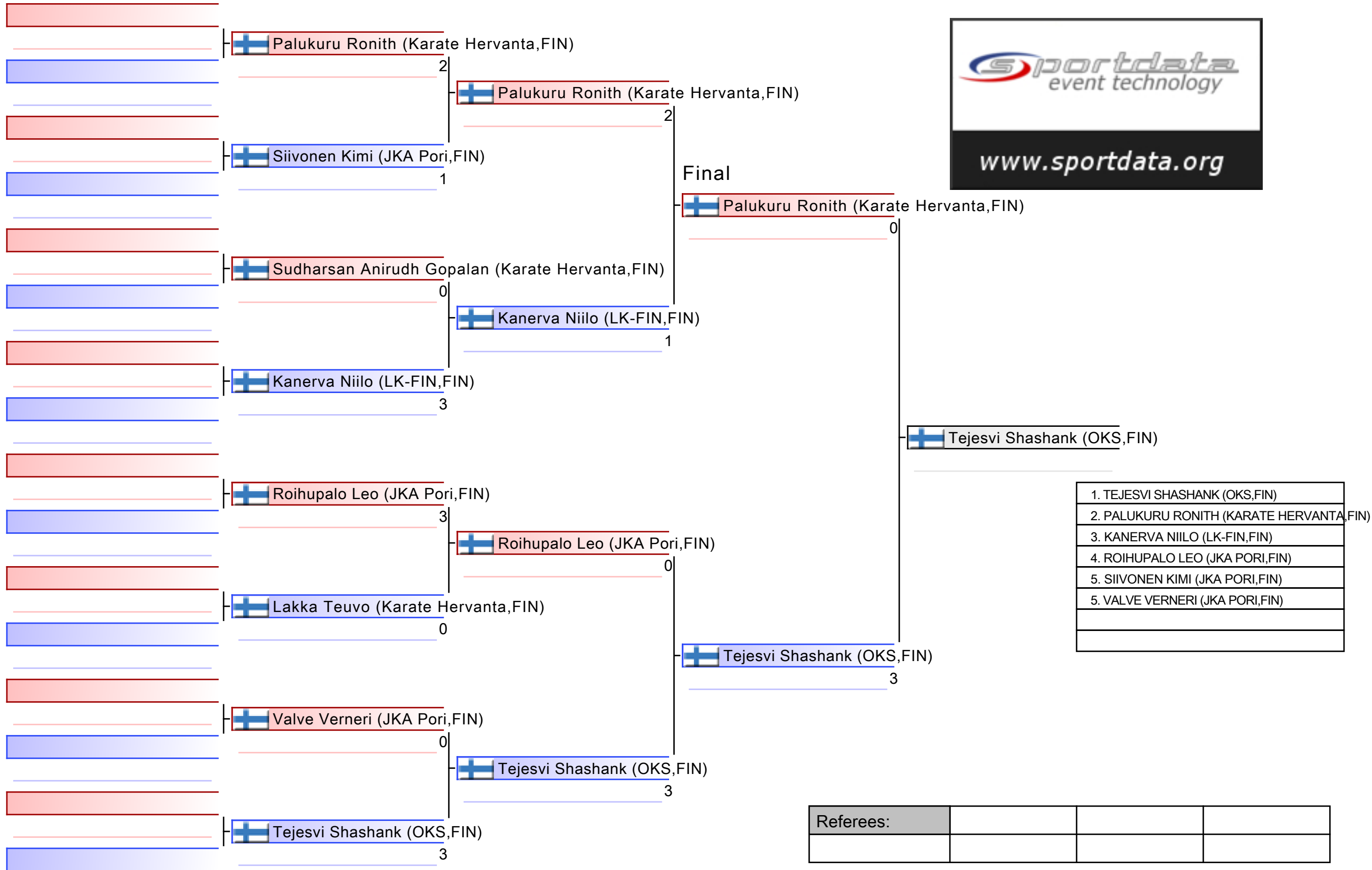

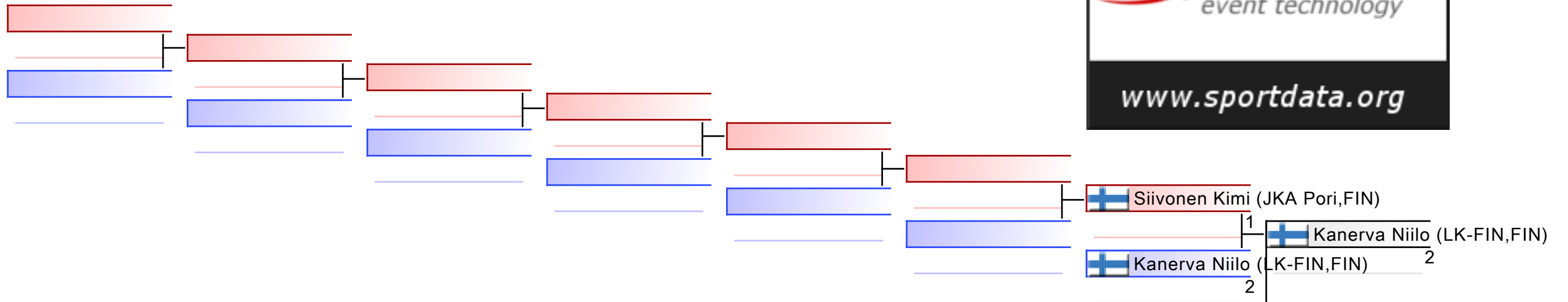

REPECHAGE: (1)

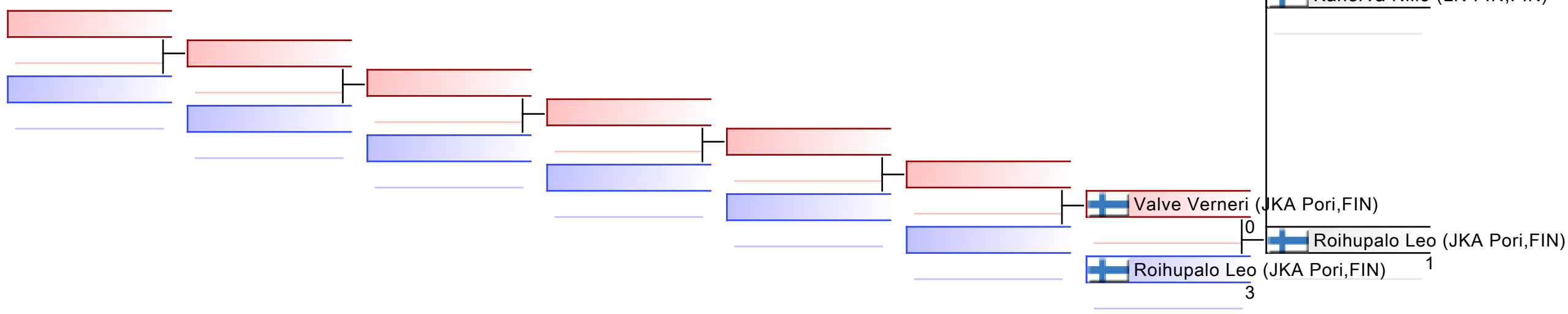

|           |  |  |  |  |  |  |  |
|-----------|--|--|--|--|--|--|--|
| Referees: |  |  |  |  |  |  |  |
|-----------|--|--|--|--|--|--|--|

# Tawastia Open Karate 2/2024

Liivuoentie 24, Hmeenlinna, FINLAND

|            |                                       |         |       |             |                              |                |    |
|------------|---------------------------------------|---------|-------|-------------|------------------------------|----------------|----|
| Court Nr.  | 1                                     | Pool    | 1     | Date        | 2024-10-06                   | Field Position | 57 |
| <b>RED</b> |                                       |         |       | <b>BLUE</b> |                              |                |    |
| NOC        | PALUKURU RONITH (KARATE HERVANTA,FIN) |         |       | NOC         | SIIVONEN KIMI (JKA PORI,FIN) |                |    |
| Category   | Kata, pojat, U12                      |         |       |             |                              |                |    |
| 3 Points   | 2 Points                              | 1 Point | Score | 1 Point     | 2 Points                     | 3 Points       |    |
|            |                                       |         | :     |             |                              |                |    |
| Penatlity  |                                       |         |       | Penatlity   |                              |                |    |
|            |                                       |         |       |             |                              |                |    |
|            |                                       |         | Total |             |                              |                |    |

## Decision of Superiority

|         |         |         |         |         |         |         |         |
|---------|---------|---------|---------|---------|---------|---------|---------|
| Judge 1 | Judge 2 | Judge 3 | Judge 4 | Judge 5 | Judge 6 | Judge 7 | Referee |
|         |         |         |         |         |         |         |         |

Name \_\_\_\_\_

Signature \_\_\_\_\_



# Tawastia Open Karate 2/2024

Liivuoentie 24, Hmeenlinna, FINLAND

|            |  |         |       |             |                            |                |    |
|------------|--|---------|-------|-------------|----------------------------|----------------|----|
| Court Nr.  | 1  | Pool    | 1     | Date        | 2024-10-06                 | Field Position | 58 |
| <b>RED</b> |  |         |       | <b>BLUE</b> |                            |                |    |
| NOC        | SUDHARSAN ANIRUDH GOPALAN<br>(KARATE HERVANTA,FIN) |         |       | NOC         | KANERVA NIILO (LK-FIN,FIN) |                |    |
| Category   | Kata, pojat, U12                                   |         |       |             |                            |                |    |
| 3 Points   | 2 Points   | 1 Point | Score | 1 Point     | 2 Points                   | 3 Points       |    |
|            |  |         | :     |             |                            |                |    |
| Penatlity  |  |         |       | Penatlity   |                            |                |    |
|            |  |         |       |             |                            |                |    |
|            |  |         | Total |             |                            |                |    |

## Decision of Superiority

|         |         |         |         |         |         |         |         |
|---------|---------|---------|---------|---------|---------|---------|---------|
| Judge 1 | Judge 2 | Judge 3 | Judge 4 | Judge 5 | Judge 6 | Judge 7 | Referee |
|         |         |         |         |         |         |         |         |

Name \_\_\_\_\_

Signature \_\_\_\_\_



# Tawastia Open Karate 2/2024

Liivuoentie 24, Hmeenlinna, FINLAND

|            |                              |         |       |             |                                   |                |    |
|------------|------------------------------|---------|-------|-------------|-----------------------------------|----------------|----|
| Court Nr.  | 1                            | Pool    | 1     | Date        | 2024-10-06                        | Field Position | 59 |
| <b>RED</b> |                              |         |       | <b>BLUE</b> |                                   |                |    |
| NOC        | ROIHUPALO LEO (JKA PORI,FIN) |         |       | NOC         | LAKKA TEUVO (KARATE HERVANTA,FIN) |                |    |
| Category   | Kata, pojat, U12             |         |       |             |                                   |                |    |
| 3 Points   | 2 Points                     | 1 Point | Score | 1 Point     | 2 Points                          | 3 Points       |    |
|            |                              |         | :     |             |                                   |                |    |
| Penatlity  |                              |         |       | Penatlity   |                                   |                |    |
|            |                              |         |       |             |                                   |                |    |
|            |                              |         | Total |             |                                   |                |    |

## Decision of Superiority

|         |         |         |         |         |         |         |         |
|---------|---------|---------|---------|---------|---------|---------|---------|
| Judge 1 | Judge 2 | Judge 3 | Judge 4 | Judge 5 | Judge 6 | Judge 7 | Referee |
|         |         |         |         |         |         |         |         |

Name \_\_\_\_\_  
 Signature \_\_\_\_\_



# Tawastia Open Karate 2/2024

Liivuoentie 24, Hmeenlinna, FINLAND

|            |                              |         |       |             |                            |                |    |
|------------|------------------------------|---------|-------|-------------|----------------------------|----------------|----|
| Court Nr.  | 1                            | Pool    | 1     | Date        | 2024-10-06                 | Field Position | 60 |
| <b>RED</b> |                              |         |       | <b>BLUE</b> |                            |                |    |
| NOC        | VALVE VERNERI (JKA PORI,FIN) |         |       | NOC         | TEJESVI SHASHANK (OKS,FIN) |                |    |
| Category   | Kata, pojat, U12             |         |       |             |                            |                |    |
| 3 Points   | 2 Points                     | 1 Point | Score | 1 Point     | 2 Points                   | 3 Points       |    |
|            |                              |         | :     |             |                            |                |    |
| Penatlity  |                              |         |       | Penatlity   |                            |                |    |
|            |                              |         |       |             |                            |                |    |
|            |                              |         | Total |             |                            |                |    |

## Decision of Superiority

| Judge 1 | Judge 2 | Judge 3 | Judge 4 | Judge 5 | Judge 6 | Judge 7 | Referee |
|---------|---------|---------|---------|---------|---------|---------|---------|
|         |         |         |         |         |         |         |         |

Name \_\_\_\_\_  
 Signature \_\_\_\_\_



# Tawastia Open Karate 2/2024

Liivuorentie 24, Hmeenlinna, FINLAND

|            |                                       |         |       |             |                            |                |    |
|------------|---------------------------------------|---------|-------|-------------|----------------------------|----------------|----|
| Court Nr.  | 1                                     | Pool    | 1     | Date        | 2024-10-06                 | Field Position | 61 |
| <b>RED</b> |                                       |         |       | <b>BLUE</b> |                            |                |    |
| NOC        | PALUKURU RONITH (KARATE HERVANTA,FIN) |         |       | NOC         | KANERVA NIILO (LK-FIN,FIN) |                |    |
| Category   | Kata, pojat, U12                      |         |       |             |                            |                |    |
| 3 Points   | 2 Points                              | 1 Point | Score | 1 Point     | 2 Points                   | 3 Points       |    |
|            |                                       |         | :     |             |                            |                |    |
| Penatlity  |                                       |         |       | Penatlity   |                            |                |    |
|            |                                       |         |       |             |                            |                |    |
|            |                                       |         | Total |             |                            |                |    |

## Decision of Superiority

| Judge 1 | Judge 2 | Judge 3 | Judge 4 | Judge 5 | Judge 6 | Judge 7 | Referee |
|---------|---------|---------|---------|---------|---------|---------|---------|
|         |         |         |         |         |         |         |         |

Name \_\_\_\_\_

Signature \_\_\_\_\_



# Tawastia Open Karate 2/2024

Liivuoentie 24, Hmeenlinna, FINLAND

|            |                              |         |       |             |                            |                |    |
|------------|------------------------------|---------|-------|-------------|----------------------------|----------------|----|
| Court Nr.  | 1                            | Pool    | 1     | Date        | 2024-10-06                 | Field Position | 62 |
| <b>RED</b> |                              |         |       | <b>BLUE</b> |                            |                |    |
| NOC        | ROIHUPALO LEO (JKA PORI,FIN) |         |       | NOC         | TEJESVI SHASHANK (OKS,FIN) |                |    |
| Category   | Kata, pojat, U12             |         |       |             |                            |                |    |
| 3 Points   | 2 Points                     | 1 Point | Score | 1 Point     | 2 Points                   | 3 Points       |    |
|            |                              |         | :     |             |                            |                |    |
| Penatlity  |                              |         |       | Penatlity   |                            |                |    |
|            |                              |         |       |             |                            |                |    |
|            |                              |         | Total |             |                            |                |    |

## Decision of Superiority

| Judge 1 | Judge 2 | Judge 3 | Judge 4 | Judge 5 | Judge 6 | Judge 7 | Referee |
|---------|---------|---------|---------|---------|---------|---------|---------|
|         |         |         |         |         |         |         |         |

Name \_\_\_\_\_

Signature \_\_\_\_\_





# Tawastia Open Karate 2/2024

Liivuoentie 24, Hmeenlinna, FINLAND

|            |                                       |         |       |             |                            |                |    |
|------------|---------------------------------------|---------|-------|-------------|----------------------------|----------------|----|
| Court Nr.  | 1                                     | Pool    | 1     | Date        | 2024-10-06                 | Field Position | 63 |
| <b>RED</b> |                                       |         |       | <b>BLUE</b> |                            |                |    |
| NOC        | PALUKURU RONITH (KARATE HERVANTA,FIN) |         |       | NOC         | TEJESVI SHASHANK (OKS,FIN) |                |    |
| Category   | Kata, pojat, U12                      |         |       |             |                            |                |    |
| 3 Points   | 2 Points                              | 1 Point | Score | 1 Point     | 2 Points                   | 3 Points       |    |
|            |                                       |         | :     |             |                            |                |    |
| Penatlity  |                                       |         |       | Penatlity   |                            |                |    |
|            |                                       |         |       |             |                            |                |    |
|            |                                       |         | Total |             |                            |                |    |

## Decision of Superiority

| Judge 1 | Judge 2 | Judge 3 | Judge 4 | Judge 5 | Judge 6 | Judge 7 | Referee |
|---------|---------|---------|---------|---------|---------|---------|---------|
|         |         |         |         |         |         |         |         |

Name \_\_\_\_\_  
 Signature \_\_\_\_\_



# Tawastia Open Karate 2/2024

Liivuoentie 24, Hmeenlinna, FINLAND

|            |                              |         |       |             |                            |                |   |
|------------|------------------------------|---------|-------|-------------|----------------------------|----------------|---|
| Court Nr.  | 1                            | Pool    | 1     | Date        | 2024-10-06                 | Field Position | 0 |
| <b>RED</b> |                              |         |       | <b>BLUE</b> |                            |                |   |
| NOC        | SIIVONEN KIMI (JKA PORI,FIN) |         |       | NOC         | KANERVA NIILO (LK-FIN,FIN) |                |   |
| Category   | Kata, pojat, U12             |         |       |             |                            |                |   |
| 3 Points   | 2 Points                     | 1 Point | Score | 1 Point     | 2 Points                   | 3 Points       |   |
|            |                              |         | :     |             |                            |                |   |
| Penatlity  |                              |         |       | Penatlity   |                            |                |   |
|            |                              |         |       |             |                            |                |   |
|            |                              |         | Total |             |                            |                |   |

## Decision of Superiority

| Judge 1 | Judge 2 | Judge 3 | Judge 4 | Judge 5 | Judge 6 | Judge 7 | Referee |
|---------|---------|---------|---------|---------|---------|---------|---------|
|         |         |         |         |         |         |         |         |

Name \_\_\_\_\_

Signature \_\_\_\_\_



# Tawastia Open Karate 2/2024

Liivuoentie 24, Hmeenlinna, FINLAND

|            |                              |         |       |             |                              |                |   |
|------------|------------------------------|---------|-------|-------------|------------------------------|----------------|---|
| Court Nr.  | 2                            | Pool    | 2     | Date        | 2024-10-06                   | Field Position | 0 |
| <b>RED</b> |                              |         |       | <b>BLUE</b> |                              |                |   |
| NOC        | VALVE VERNERI (JKA PORI,FIN) |         |       | NOC         | ROIHUPALO LEO (JKA PORI,FIN) |                |   |
| Category   | Kata, pojat, U12             |         |       |             |                              |                |   |
| 3 Points   | 2 Points                     | 1 Point | Score | 1 Point     | 2 Points                     | 3 Points       |   |
|            |                              |         | :     |             |                              |                |   |
| Penatlity  |                              |         |       | Penatlity   |                              |                |   |
|            |                              |         |       |             |                              |                |   |
|            |                              |         | Total |             |                              |                |   |

## Decision of Superiority

|         |         |         |         |         |         |         |         |
|---------|---------|---------|---------|---------|---------|---------|---------|
| Judge 1 | Judge 2 | Judge 3 | Judge 4 | Judge 5 | Judge 6 | Judge 7 | Referee |
|         |         |         |         |         |         |         |         |

Name







Signature

\_\_\_\_\_

\_\_\_\_\_



## Official Results

| Kata, pojat, U12 |                  |                         |   |               |
|------------------|------------------|-------------------------|---|---------------|
| 1                | TEJESVI SHASHANK | OULUN<br>KARATESEURA    |  | FIN - FINLAND |
| 2                | PALUKURU RONITH  | SHOTOKAN<br>HERVANTA RY |  | FIN - FINLAND |
| 3                | KANERVA NIILO    | LAHDEN KARATE           |  | FIN - FINLAND |
| 4                | ROIHUPALO LEO    | PORIN SHOTOKAN          |  | FIN - FINLAND |
| 5                | SIIVONEN KIMI    | PORIN SHOTOKAN          |  | FIN - FINLAND |
| 5                | VALVE VERNERI    | PORIN SHOTOKAN          |  | FIN - FINLAND |

# KATA, POJAT, U14

Tawastia Open Karate 2/2024

**ENTRIES BY WEIGHT CATEGORY**  
**Kata, pojat, U14**

As of 6 OCT 2024

| Country Code | ID | Gender | Name               | Seeding |
|--------------|----|--------|--------------------|---------|
| FIN          |    | M      | Hannu Eero         |         |
| FIN          |    | M      | Kalliomki Viljami  |         |
| FIN          |    | M      | Kella Kasper       |         |
| FIN          |    | M      | Larkin Takehiro    |         |
| FIN          |    | M      | Lehto Eemeli       |         |
| FIN          |    | M      | NOROUZI Arash Leon |         |
| FIN          |    | M      | Nummijrvi Luukas   |         |
| FIN          |    | M      | Piikkil Onni       |         |
| FIN          |    | M      | Pulliainen Matias  |         |
| FIN          |    | M      | Salmensuu Toivo    |         |
| FIN          |    | M      | Sihvonen Eemil     |         |
| FIN          |    | M      | Sipp Emil          |         |
| FIN          |    | M      | Tsegenes Dimitris  |         |
| FIN          |    | M      | Wanic Mark         |         |

# Kata, pojat, U14

Tawastia Open Karate 2/2024, Liivuoentie 24, Hämeenlinna, FIN

2024-10-05

Tatami  
1 14:40

Pool  
1/1

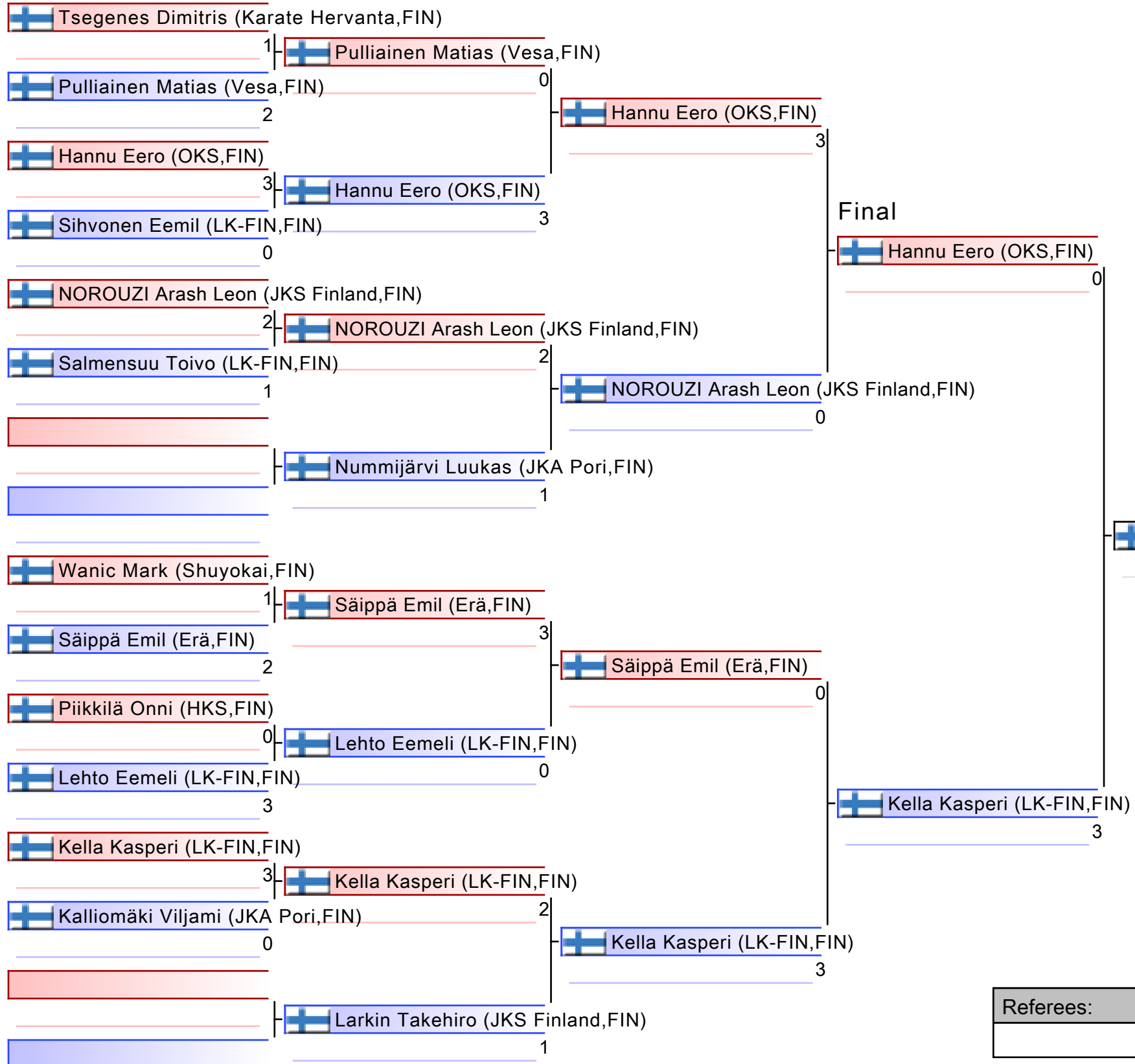

|   |
|---|
| 1. KELLA KASPERI (LK-FIN,FIN)           |
| 2. HANNU EERO (OKS,FIN)                 |
| 3. LARKIN TAKEHIRO (JKS FINLAND,FIN)    |
| 4. SIHVONEN EEMIL (LK-FIN,FIN)          |
| 5. NOROUZI ARASH LEON (JKS FINLAND,FIN) |
| 5. SÄIPPÄ EMIL (ERÄ,FIN)                |
| 7. PULLIAINEN MATIAS (VESA,FIN)         |
| 7. KALLIOMÄKI VILJAMI (JKA PORI,FIN)    |

|           |  |  |  |
|-----------|--|--|--|
| Referees: |  |  |  |
|           |  |  |  |

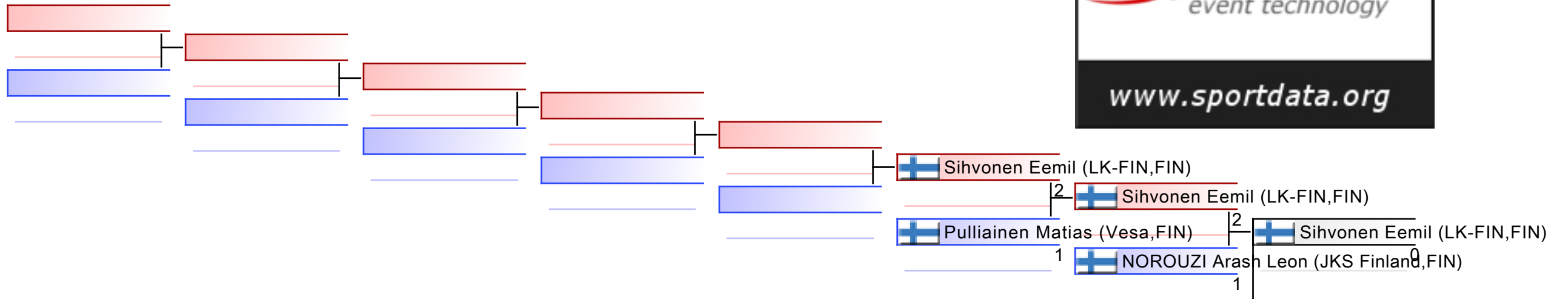

REPECHAGE: (1)

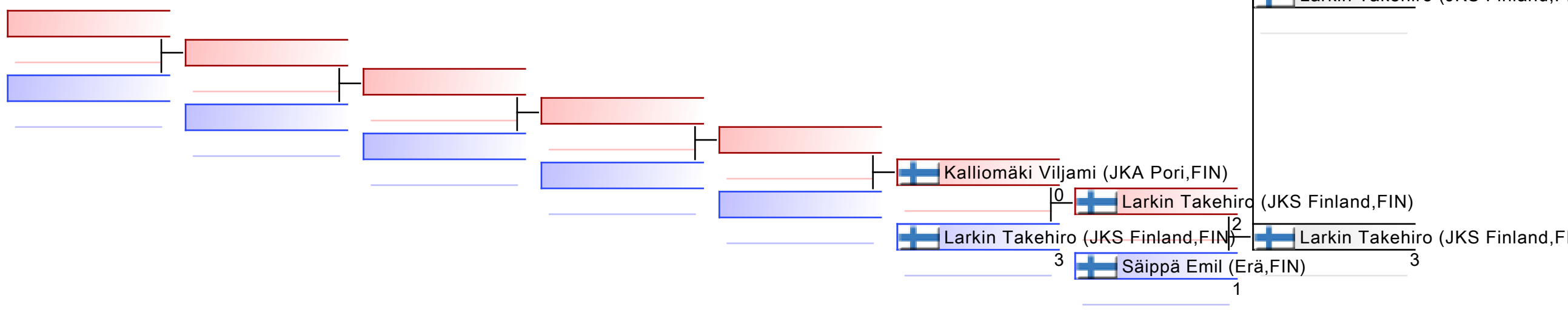

|           |  |  |  |  |  |  |  |
|-----------|--|--|--|--|--|--|--|
| Referees: |  |  |  |  |  |  |  |
|-----------|--|--|--|--|--|--|--|



# Tawastia Open Karate 2/2024

Liivuoentie 24, Hmeenlinna, FINLAND

|            |   |         |       |             |                              |                |    |
|------------|---|---------|-------|-------------|------------------------------|----------------|----|
| Court Nr.  | 1                                       | Pool    | 1     | Date        | 2024-10-06                   | Field Position | 49 |
| <b>RED</b> |   |         |       | <b>BLUE</b> |                              |                |    |
| NOC        | TSEGENES DIMITRIS (KARATE HERVANTA,FIN) |         |       | NOC         | PULLIAINEN MATIAS (VESA,FIN) |                |    |
| Category   | Kata, pojat, U14                        |         |       |             |                              |                |    |
| 3 Points   | 2 Points                                | 1 Point | Score | 1 Point     | 2 Points                     | 3 Points       |    |
|            |   |         | :     |             |                              |                |    |
| Penatlity  |   |         |       | Penatlity   |                              |                |    |
|            |   |         |       |             |                              |                |    |
|            |   |         | Total |             |                              |                |    |

## Decision of Superiority

| Judge 1 | Judge 2 | Judge 3 | Judge 4 | Judge 5 | Judge 6 | Judge 7 | Referee |
|---------|---------|---------|---------|---------|---------|---------|---------|
|         |         |         |         |         |         |         |         |

Name \_\_\_\_\_  
 Signature \_\_\_\_\_



# Tawastia Open Karate 2/2024

Liivuoentie 24, Hmeenlinna, FINLAND

|            |                      |         |       |             |                             |                |    |
|------------|----------------------|---------|-------|-------------|-----------------------------|----------------|----|
| Court Nr.  | 1                    | Pool    | 1     | Date        | 2024-10-06                  | Field Position | 50 |
| <b>RED</b> |                      |         |       | <b>BLUE</b> |                             |                |    |
| NOC        | HANNU EERO (OKS,FIN) |         |       | NOC         | SIHVONEN EEMIL (LK-FIN,FIN) |                |    |
| Category   | Kata, pojat, U14     |         |       |             |                             |                |    |
| 3 Points   | 2 Points             | 1 Point | Score | 1 Point     | 2 Points                    | 3 Points       |    |
|            |                      |         | :     |             |                             |                |    |
| Penatlity  |                      |         |       | Penatlity   |                             |                |    |
|            |                      |         |       |             |                             |                |    |
|            |                      |         | Total |             |                             |                |    |

## Decision of Superiority

| Judge 1 | Judge 2 | Judge 3 | Judge 4 | Judge 5 | Judge 6 | Judge 7 | Referee |
|---------|---------|---------|---------|---------|---------|---------|---------|
|         |         |         |         |         |         |         |         |

Name \_\_\_\_\_

Signature \_\_\_\_\_



# Tawastia Open Karate 2/2024

Liivuoventie 24, Hmeenlinna, FINLAND

|            |                                      |         |       |             |                              |                |    |
|------------|--------------------------------------|---------|-------|-------------|------------------------------|----------------|----|
| Court Nr.  | 1                                    | Pool    | 1     | Date        | 2024-10-06                   | Field Position | 51 |
| <b>RED</b> |                                      |         |       | <b>BLUE</b> |                              |                |    |
| NOC        | NOROUZI ARASH LEON (JKS FINLAND,FIN) |         |       | NOC         | SALMENSUU TOIVO (LK-FIN,FIN) |                |    |
| Category   | Kata, pojat, U14                     |         |       |             |                              |                |    |
| 3 Points   | 2 Points                             | 1 Point | Score | 1 Point     | 2 Points                     | 3 Points       |    |
|            |                                      |         | :     |             |                              |                |    |
| Penatlity  |                                      |         |       | Penatlity   |                              |                |    |
|            |                                      |         |       |             |                              |                |    |
|            |                                      |         | Total |             |                              |                |    |

## Decision of Superiority

| Judge 1 | Judge 2 | Judge 3 | Judge 4 | Judge 5 | Judge 6 | Judge 7 | Referee |
|---------|---------|---------|---------|---------|---------|---------|---------|
|         |         |         |         |         |         |         |         |

Name \_\_\_\_\_

Signature \_\_\_\_\_



# Tawastia Open Karate 2/2024

Liivuoentie 24, Hmeenlinna, FINLAND

|            |                           |         |       |             |                    |                |    |
|------------|---------------------------|---------|-------|-------------|--------------------|----------------|----|
| Court Nr.  | 1                         | Pool    | 1     | Date        | 2024-10-06         | Field Position | 53 |
| <b>RED</b> |                           |         |       | <b>BLUE</b> |                    |                |    |
| NOC        | WANIC MARK (SHUYOKAI,FIN) |         |       | NOC         | SIPP EMIL (ER,FIN) |                |    |
| Category   | Kata, pojat, U14          |         |       |             |                    |                |    |
| 3 Points   | 2 Points                  | 1 Point | Score | 1 Point     | 2 Points           | 3 Points       |    |
|            |                           |         | :     |             |                    |                |    |
| Penatlity  |                           |         |       | Penatlity   |                    |                |    |
|            |                           |         |       |             |                    |                |    |
|            |                           |         | Total |             |                    |                |    |

## Decision of Superiority

| Judge 1 | Judge 2 | Judge 3 | Judge 4 | Judge 5 | Judge 6 | Judge 7 | Referee |
|---------|---------|---------|---------|---------|---------|---------|---------|
|         |         |         |         |         |         |         |         |

Name \_\_\_\_\_  
 Signature \_\_\_\_\_



# Tawastia Open Karate 2/2024

Liivuoentie 24, Hmeenlinna, FINLAND

|            |                        |         |       |             |                           |                |    |
|------------|------------------------|---------|-------|-------------|---------------------------|----------------|----|
| Court Nr.  | 1                      | Pool    | 1     | Date        | 2024-10-06                | Field Position | 54 |
| <b>RED</b> |                        |         |       | <b>BLUE</b> |                           |                |    |
| NOC        | PIIKKIL ONNI (HKS,FIN) |         |       | NOC         | LEHTO EEMELI (LK-FIN,FIN) |                |    |
| Category   | Kata, pojat, U14       |         |       |             |                           |                |    |
| 3 Points   | 2 Points               | 1 Point | Score | 1 Point     | 2 Points                  | 3 Points       |    |
|            |                        |         | :     |             |                           |                |    |
| Penatlity  |                        |         |       | Penatlity   |                           |                |    |
|            |                        |         |       |             |                           |                |    |
|            |                        |         | Total |             |                           |                |    |

## Decision of Superiority

|         |         |         |         |         |         |         |         |
|---------|---------|---------|---------|---------|---------|---------|---------|
| Judge 1 | Judge 2 | Judge 3 | Judge 4 | Judge 5 | Judge 6 | Judge 7 | Referee |
|         |         |         |         |         |         |         |         |

Name

Signature

\_\_\_\_\_  
\_\_\_\_\_



# Tawastia Open Karate 2/2024

Liivuoentie 24, Hmeenlinna, FINLAND

|            |                            |         |       |             |                                  |                |    |
|------------|----------------------------|---------|-------|-------------|----------------------------------|----------------|----|
| Court Nr.  | 1                          | Pool    | 1     | Date        | 2024-10-06                       | Field Position | 55 |
| <b>RED</b> |                            |         |       | <b>BLUE</b> |                                  |                |    |
| NOC        | KELLA KASPERI (LK-FIN,FIN) |         |       | NOC         | KALLIOMKI VILJAMI (JKA PORI,FIN) |                |    |
| Category   | Kata, pojat, U14           |         |       |             |                                  |                |    |
| 3 Points   | 2 Points                   | 1 Point | Score | 1 Point     | 2 Points                         | 3 Points       |    |
|            |                            |         | :     |             |                                  |                |    |
| Penatlity  |                            |         |       | Penatlity   |                                  |                |    |
|            |                            |         |       |             |                                  |                |    |
|            |                            |         | Total |             |                                  |                |    |

## Decision of Superiority

|         |         |         |         |         |         |         |         |
|---------|---------|---------|---------|---------|---------|---------|---------|
| Judge 1 | Judge 2 | Judge 3 | Judge 4 | Judge 5 | Judge 6 | Judge 7 | Referee |
|         |         |         |         |         |         |         |         |

Name \_\_\_\_\_

Signature \_\_\_\_\_



# Tawastia Open Karate 2/2024

Liivuoentie 24, Hmeenlinna, FINLAND

|            |                              |         |       |             |                      |                |    |
|------------|------------------------------|---------|-------|-------------|----------------------|----------------|----|
| Court Nr.  | 1                            | Pool    | 1     | Date        | 2024-10-06           | Field Position | 57 |
| <b>RED</b> |                              |         |       | <b>BLUE</b> |                      |                |    |
| NOC        | PULLIAINEN MATIAS (VESA,FIN) |         |       | NOC         | HANNU EERO (OKS,FIN) |                |    |
| Category   | Kata, pojat, U14             |         |       |             |                      |                |    |
| 3 Points   | 2 Points                     | 1 Point | Score | 1 Point     | 2 Points             | 3 Points       |    |
|            |                              |         | :     |             |                      |                |    |
| Penatlity  |                              |         |       | Penatlity   |                      |                |    |
|            |                              |         |       |             |                      |                |    |
|            |                              |         | Total |             |                      |                |    |

## Decision of Superiority

|         |         |         |         |         |         |         |         |
|---------|---------|---------|---------|---------|---------|---------|---------|
| Judge 1 | Judge 2 | Judge 3 | Judge 4 | Judge 5 | Judge 6 | Judge 7 | Referee |
|         |         |         |         |         |         |         |         |

Name

Signature

\_\_\_\_\_

\_\_\_\_\_



# Tawastia Open Karate 2/2024

Liivuoentie 24, Hmeenlinna, FINLAND

|            |                                      |         |       |             |                                 |                |    |
|------------|--------------------------------------|---------|-------|-------------|---------------------------------|----------------|----|
| Court Nr.  | 1                                    | Pool    | 1     | Date        | 2024-10-06                      | Field Position | 58 |
| <b>RED</b> |                                      |         |       | <b>BLUE</b> |                                 |                |    |
| NOC        | NOROUZI ARASH LEON (JKS FINLAND,FIN) |         |       | NOC         | NUMMIJRVI LUUKAS (JKA PORI,FIN) |                |    |
| Category   | Kata, pojat, U14                     |         |       |             |                                 |                |    |
| 3 Points   | 2 Points                             | 1 Point | Score | 1 Point     | 2 Points                        | 3 Points       |    |
|            |                                      |         | :     |             |                                 |                |    |
| Penatlity  |                                      |         |       | Penatlity   |                                 |                |    |
|            |                                      |         |       |             |                                 |                |    |
|            |                                      |         | Total |             |                                 |                |    |

## Decision of Superiority

| Judge 1 | Judge 2 | Judge 3 | Judge 4 | Judge 5 | Judge 6 | Judge 7 | Referee |
|---------|---------|---------|---------|---------|---------|---------|---------|
|         |         |         |         |         |         |         |         |

Name \_\_\_\_\_  
 Signature \_\_\_\_\_





# Tawastia Open Karate 2/2024

Liivuoentie 24, Hmeenlinna, FINLAND

|            |                    |         |       |             |                           |                |    |
|------------|--------------------|---------|-------|-------------|---------------------------|----------------|----|
| Court Nr.  | 1                  | Pool    | 1     | Date        | 2024-10-06                | Field Position | 59 |
| <b>RED</b> |                    |         |       | <b>BLUE</b> |                           |                |    |
| NOC        | SIPP EMIL (ER,FIN) |         |       | NOC         | LEHTO EEMELI (LK-FIN,FIN) |                |    |
| Category   | Kata, pojat, U14   |         |       |             |                           |                |    |
| 3 Points   | 2 Points           | 1 Point | Score | 1 Point     | 2 Points                  | 3 Points       |    |
|            |                    |         | :     |             |                           |                |    |
| Penatlity  |                    |         |       | Penatlity   |                           |                |    |
|            |                    |         |       |             |                           |                |    |
|            |                    |         | Total |             |                           |                |    |

## Decision of Superiority

|         |         |         |         |         |         |         |         |
|---------|---------|---------|---------|---------|---------|---------|---------|
| Judge 1 | Judge 2 | Judge 3 | Judge 4 | Judge 5 | Judge 6 | Judge 7 | Referee |
|         |         |         |         |         |         |         |         |

Name

Signature

\_\_\_\_\_

\_\_\_\_\_



# Tawastia Open Karate 2/2024

Liivuoentie 24, Hmeenlinna, FINLAND

|            |                            |         |       |             |                                   |                |    |
|------------|----------------------------|---------|-------|-------------|-----------------------------------|----------------|----|
| Court Nr.  | 1                          | Pool    | 1     | Date        | 2024-10-06                        | Field Position | 60 |
| <b>RED</b> |                            |         |       | <b>BLUE</b> |                                   |                |    |
| NOC        | KELLA KASPERI (LK-FIN,FIN) |         |       | NOC         | LARKIN TAKEHIRO (JKS FINLAND,FIN) |                |    |
| Category   | Kata, pojat, U14           |         |       |             |                                   |                |    |
| 3 Points   | 2 Points                   | 1 Point | Score | 1 Point     | 2 Points                          | 3 Points       |    |
|            |                            |         | :     |             |                                   |                |    |
| Penatlity  |                            |         |       | Penatlity   |                                   |                |    |
|            |                            |         |       |             |                                   |                |    |
|            |                            |         | Total |             |                                   |                |    |

## Decision of Superiority

| Judge 1 | Judge 2 | Judge 3 | Judge 4 | Judge 5 | Judge 6 | Judge 7 | Referee |
|---------|---------|---------|---------|---------|---------|---------|---------|
|         |         |         |         |         |         |         |         |

Name \_\_\_\_\_

Signature \_\_\_\_\_



# Tawastia Open Karate 2/2024

Liivuoentie 24, Hmeenlinna, FINLAND

|            |                      |         |       |             |                                      |                |    |
|------------|----------------------|---------|-------|-------------|--------------------------------------|----------------|----|
| Court Nr.  | 1                    | Pool    | 1     | Date        | 2024-10-06                           | Field Position | 61 |
| <b>RED</b> |                      |         |       | <b>BLUE</b> |                                      |                |    |
| NOC        | HANNU EERO (OKS,FIN) |         |       | NOC         | NOROUZI ARASH LEON (JKS FINLAND,FIN) |                |    |
| Category   | Kata, pojat, U14     |         |       |             |                                      |                |    |
| 3 Points   | 2 Points             | 1 Point | Score | 1 Point     | 2 Points                             | 3 Points       |    |
|            |                      |         | :     |             |                                      |                |    |
| Penatlity  |                      |         |       | Penatlity   |                                      |                |    |
|            |                      |         |       |             |                                      |                |    |
|            |                      |         | Total |             |                                      |                |    |

## Decision of Superiority

|         |         |         |         |         |         |         |         |
|---------|---------|---------|---------|---------|---------|---------|---------|
| Judge 1 | Judge 2 | Judge 3 | Judge 4 | Judge 5 | Judge 6 | Judge 7 | Referee |
|         |         |         |         |         |         |         |         |

Name

Signature

\_\_\_\_\_

\_\_\_\_\_



# Tawastia Open Karate 2/2024

Liivuoentie 24, Hmeenlinna, FINLAND

|            |                    |         |       |             |                            |                |    |
|------------|--------------------|---------|-------|-------------|----------------------------|----------------|----|
| Court Nr.  | 1                  | Pool    | 1     | Date        | 2024-10-06                 | Field Position | 62 |
| <b>RED</b> |                    |         |       | <b>BLUE</b> |                            |                |    |
| NOC        | SIPP EMIL (ER,FIN) |         |       | NOC         | KELLA KASPERI (LK-FIN,FIN) |                |    |
| Category   | Kata, pojat, U14   |         |       |             |                            |                |    |
| 3 Points   | 2 Points           | 1 Point | Score | 1 Point     | 2 Points                   | 3 Points       |    |
|            |                    |         | :     |             |                            |                |    |
| Penatlity  |                    |         |       | Penatlity   |                            |                |    |
|            |                    |         |       |             |                            |                |    |
|            |                    |         | Total |             |                            |                |    |

## Decision of Superiority

|         |         |         |         |         |         |         |         |
|---------|---------|---------|---------|---------|---------|---------|---------|
| Judge 1 | Judge 2 | Judge 3 | Judge 4 | Judge 5 | Judge 6 | Judge 7 | Referee |
|         |         |         |         |         |         |         |         |

Name

Signature

\_\_\_\_\_

\_\_\_\_\_



# Tawastia Open Karate 2/2024

Liivuoentie 24, Hmeenlinna, FINLAND

|            |                      |         |       |             |                            |                |    |
|------------|----------------------|---------|-------|-------------|----------------------------|----------------|----|
| Court Nr.  | 1                    | Pool    | 1     | Date        | 2024-10-06                 | Field Position | 63 |
| <b>RED</b> |                      |         |       | <b>BLUE</b> |                            |                |    |
| NOC        | HANNU EERO (OKS,FIN) |         |       | NOC         | KELLA KASPERI (LK-FIN,FIN) |                |    |
| Category   | Kata, pojat, U14     |         |       |             |                            |                |    |
| 3 Points   | 2 Points             | 1 Point | Score | 1 Point     | 2 Points                   | 3 Points       |    |
|            |                      |         | :     |             |                            |                |    |
| Penatlity  |                      |         |       | Penatlity   |                            |                |    |
|            |                      |         |       |             |                            |                |    |
|            |                      |         | Total |             |                            |                |    |

## Decision of Superiority

| Judge 1 | Judge 2 | Judge 3 | Judge 4 | Judge 5 | Judge 6 | Judge 7 | Referee |
|---------|---------|---------|---------|---------|---------|---------|---------|
|         |         |         |         |         |         |         |         |

Name \_\_\_\_\_

Signature \_\_\_\_\_



# Tawastia Open Karate 2/2024

Liivuoentie 24, Hmeenlinna, FINLAND

|            |                             |         |       |             |                                      |                |   |
|------------|-----------------------------|---------|-------|-------------|--------------------------------------|----------------|---|
| Court Nr.  | 1                           | Pool    | 1     | Date        | 2024-10-06                           | Field Position | 0 |
| <b>RED</b> |                             |         |       | <b>BLUE</b> |                                      |                |   |
| NOC        | SIHVONEN EEMIL (LK-FIN,FIN) |         |       | NOC         | NOROUZI ARASH LEON (JKS FINLAND,FIN) |                |   |
| Category   | Kata, pojat, U14            |         |       |             |                                      |                |   |
| 3 Points   | 2 Points                    | 1 Point | Score | 1 Point     | 2 Points                             | 3 Points       |   |
|            |                             |         | :     |             |                                      |                |   |
| Penatlity  |                             |         |       | Penatlity   |                                      |                |   |
|            |                             |         |       |             |                                      |                |   |
|            |                             |         | Total |             |                                      |                |   |

## Decision of Superiority

| Judge 1 | Judge 2 | Judge 3 | Judge 4 | Judge 5 | Judge 6 | Judge 7 | Referee |
|---------|---------|---------|---------|---------|---------|---------|---------|
|         |         |         |         |         |         |         |         |

Name \_\_\_\_\_  
 Signature \_\_\_\_\_



# Tawastia Open Karate 2/2024

Liivuoentie 24, Hmeenlinna, FINLAND

|            |                             |         |       |             |                              |                |   |
|------------|-----------------------------|---------|-------|-------------|------------------------------|----------------|---|
| Court Nr.  | 1                           | Pool    | 1     | Date        | 2024-10-06                   | Field Position | 2 |
| <b>RED</b> |                             |         |       | <b>BLUE</b> |                              |                |   |
| NOC        | SIHVONEN EEMIL (LK-FIN,FIN) |         |       | NOC         | PULLIAINEN MATIAS (VESA,FIN) |                |   |
| Category   | Kata, pojat, U14            |         |       |             |                              |                |   |
| 3 Points   | 2 Points                    | 1 Point | Score | 1 Point     | 2 Points                     | 3 Points       |   |
|            |                             |         | :     |             |                              |                |   |
| Penatlity  |                             |         |       | Penatlity   |                              |                |   |
|            |                             |         |       |             |                              |                |   |
|            |                             |         | Total |             |                              |                |   |

## Decision of Superiority

|         |         |         |         |         |         |         |         |
|---------|---------|---------|---------|---------|---------|---------|---------|
| Judge 1 | Judge 2 | Judge 3 | Judge 4 | Judge 5 | Judge 6 | Judge 7 | Referee |
|         |         |         |         |         |         |         |         |

Name \_\_\_\_\_

Signature \_\_\_\_\_



# Tawastia Open Karate 2/2024

Liivuoentie 24, Hmeenlinna, FINLAND

|            |                                   |         |       |             |                    |                |   |
|------------|-----------------------------------|---------|-------|-------------|--------------------|----------------|---|
| Court Nr.  | 2                                 | Pool    | 2     | Date        | 2024-10-06         | Field Position | 0 |
| <b>RED</b> |                                   |         |       | <b>BLUE</b> |                    |                |   |
| NOC        | LARKIN TAKEHIRO (JKS FINLAND,FIN) |         |       | NOC         | SIPP EMIL (ER,FIN) |                |   |
| Category   | Kata, pojat, U14                  |         |       |             |                    |                |   |
| 3 Points   | 2 Points                          | 1 Point | Score | 1 Point     | 2 Points           | 3 Points       |   |
|            |                                   |         | :     |             |                    |                |   |
| Penatlity  |                                   |         |       | Penatlity   |                    |                |   |
|            |                                   |         |       |             |                    |                |   |
|            |                                   |         | Total |             |                    |                |   |

## Decision of Superiority

| Judge 1 | Judge 2 | Judge 3 | Judge 4 | Judge 5 | Judge 6 | Judge 7 | Referee |
|---------|---------|---------|---------|---------|---------|---------|---------|
|         |         |         |         |         |         |         |         |

Name \_\_\_\_\_

Signature \_\_\_\_\_





# Tawastia Open Karate 2/2024

Liivuoentie 24, Hmeenlinna, FINLAND

|            |                                  |         |       |             |                                   |                |   |
|------------|----------------------------------|---------|-------|-------------|-----------------------------------|----------------|---|
| Court Nr.  | 2                                | Pool    | 2     | Date        | 2024-10-06                        | Field Position | 2 |
| <b>RED</b> |                                  |         |       | <b>BLUE</b> |                                   |                |   |
| NOC        | KALLIOMKI VILJAMI (JKA PORI,FIN) |         |       | NOC         | LARKIN TAKEHIRO (JKS FINLAND,FIN) |                |   |
| Category   | Kata, pojat, U14                 |         |       |             |                                   |                |   |
| 3 Points   | 2 Points                         | 1 Point | Score | 1 Point     | 2 Points                          | 3 Points       |   |
|            |                                  |         | :     |             |                                   |                |   |
| Penatlity  |                                  |         |       | Penatlity   |                                   |                |   |
|            |                                  |         |       |             |                                   |                |   |
|            |                                  |         | Total |             |                                   |                |   |

## Decision of Superiority

| Judge 1 | Judge 2 | Judge 3 | Judge 4 | Judge 5 | Judge 6 | Judge 7 | Referee |
|---------|---------|---------|---------|---------|---------|---------|---------|
|         |         |         |         |         |         |         |         |

Name \_\_\_\_\_  
 Signature \_\_\_\_\_



## Tawastia Open Karate 2/2024 - 2024-10-05

## Official Results

| Kata, pojat, U14 |                    |  |   |               |
|------------------|--------------------|--|---|---------------|
| 1                | KELLA KASPERI      | LAHDEN KARATE                                |  | FIN - FINLAND |
| 2                | HANNU EERO         | OULUN<br>KARATESEURA                         |  | FIN - FINLAND |
| 3                | LARKIN TAKEHIRO    | JKS FINLAND -<br>SHOTOKAN KARATE<br>HELSINKI |  | FIN - FINLAND |
| 4                | SIHVONEN EEMIL     | LAHDEN KARATE                                |  | FIN - FINLAND |
| 5                | NOROUZI ARASH LEON | JKS FINLAND -<br>SHOTOKAN KARATE<br>HELSINKI |  | FIN - FINLAND |
| 5                | SÄIPPÄ EMIL        | TAPANILAN ERÄ                                |  | FIN - FINLAND |
| 7                | PULLIAINEN MATIAS  | HYVINKÄÄN<br>SHOTOKAN KARATE<br>RY           |  | FIN - FINLAND |
| 7                | KALLIOMÄKI VILJAMI | PORIN SHOTOKAN                               |  | FIN - FINLAND |

# KATA, POJAT, U16

Tawastia Open Karate 2/2024

**ENTRIES BY WEIGHT CATEGORY**  
**Kata, pojat, U16**

As of 6 OCT 2024

| Country Code | ID | Gender | Name              | Seeding |
|--------------|----|--------|-------------------|---------|
| FIN          |    | M      | Gaetti Lucas      |         |
| FIN          |    | M      | Hirvonen Jesse    |         |
| FIN          |    | M      | Huuskonen Veeti   |         |
| FIN          |    | M      | Kivikoski Jere    |         |
| FIN          |    | M      | Kivimki Veikko    |         |
| FIN          |    | M      | Lhetkangas Luka   |         |
| FIN          |    | M      | Pienimki Roope    |         |
| FIN          |    | M      | Sandgren Joonas   |         |
| FIN          |    | M      | Tarkkanen Otso    |         |
| FIN          |    | M      | Tkachenko Timofei |         |

# Kata, pojat, U16

Tawastia Open Karate 2/2024, Liivourentie 24, Hämeenlinna, FIN

2024-10-05

Tatami  
2 11:20

Pool  
1/1

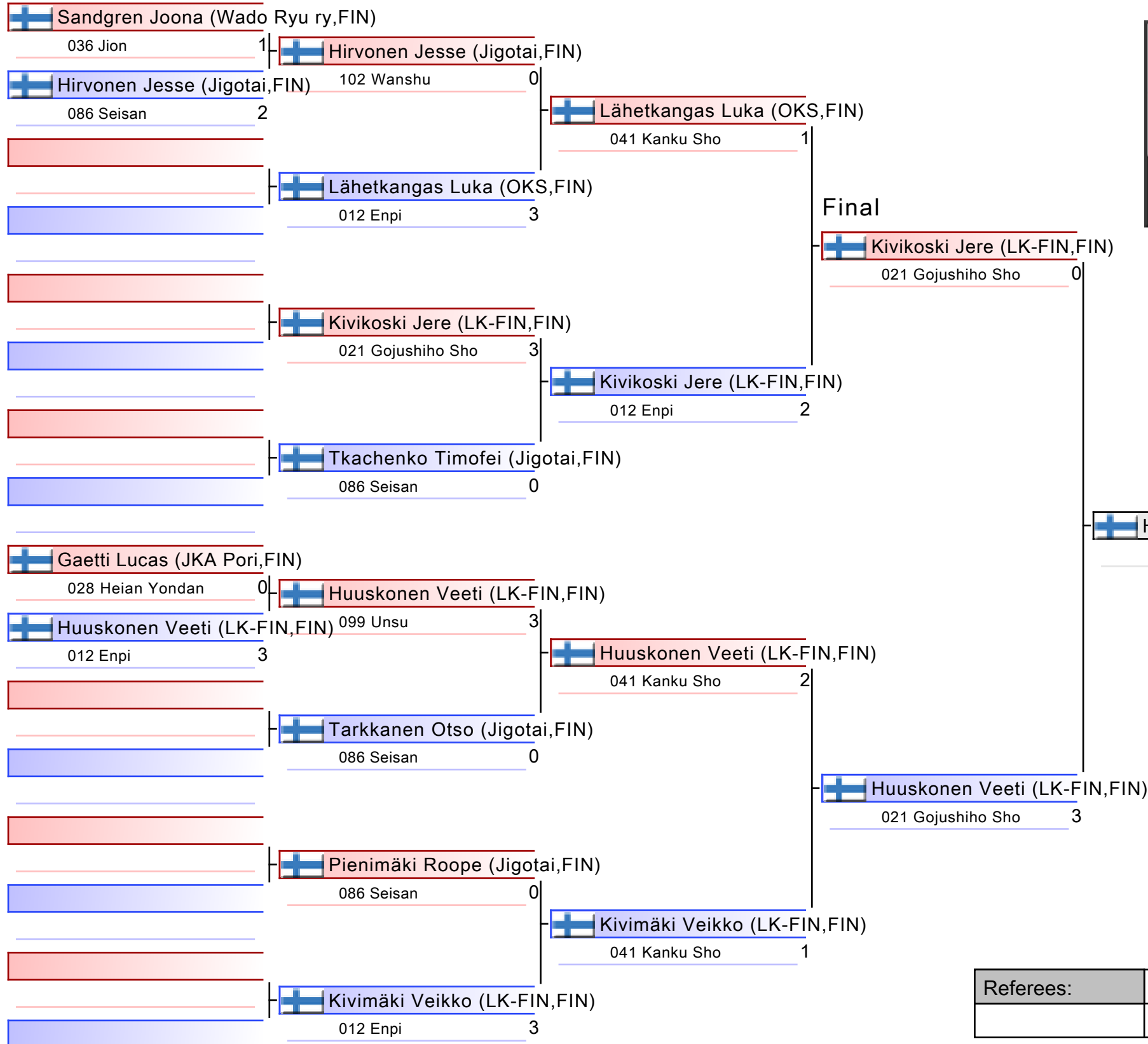

|                                    |
|------------------------------------|
| 1. HUUSKONEN VEETI (LK-FIN,FIN)    |
| 2. KIVIKOSKI JERE (LK-FIN,FIN)     |
| 3. LÄHETKANGAS LUKA (OKS,FIN)      |
| 4. KIVIMÄKI VEIKKO (LK-FIN,FIN)    |
| 5. TKACHENKO TIMOFEI (JIGOTAI,FIN) |
| 5. TARKKANEN OTSO (JIGOTAI,FIN)    |
| 7. GAETTI LUCAS (JKA PORI,FIN)     |
|                                    |

|           |  |  |  |
|-----------|--|--|--|
| Referees: |  |  |  |
|           |  |  |  |

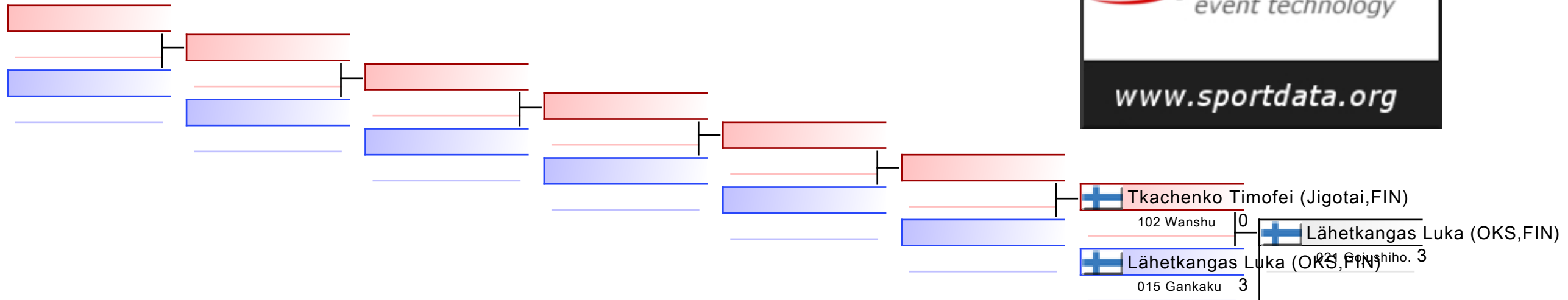

REPECHAGE: (1)

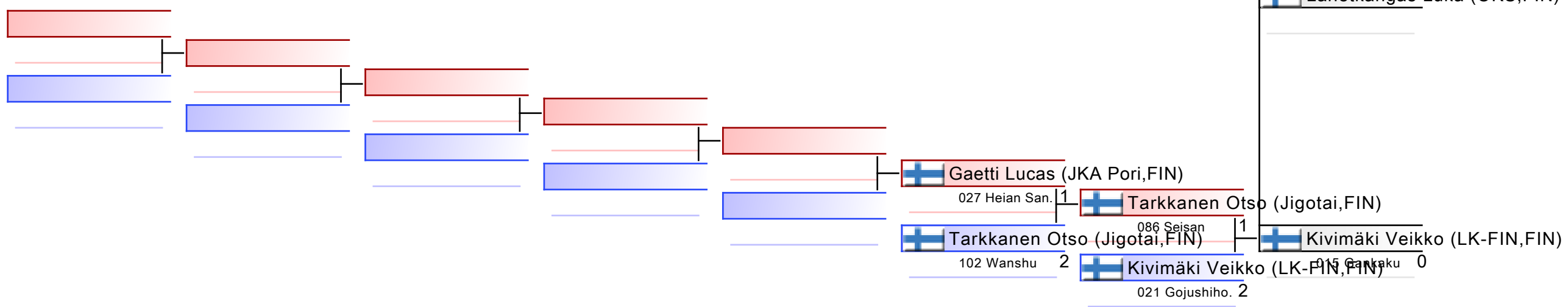

|           |  |  |  |  |  |  |  |
|-----------|--|--|--|--|--|--|--|
| Referees: |  |  |  |  |  |  |  |
|-----------|--|--|--|--|--|--|--|

# Tawastia Open Karate 2/2024

Liivuoentie 24, Hmeenlinna, FINLAND

|            |                                  |         |       |             |                              |                |    |
|------------|----------------------------------|---------|-------|-------------|------------------------------|----------------|----|
| Court Nr.  | 1                                | Pool    | 1     | Date        | 2024-10-06                   | Field Position | 49 |
| <b>RED</b> |                                  |         |       | <b>BLUE</b> |                              |                |    |
| NOC        | SANDGREN JOONA (WADO RYU RY,FIN) |         |       | NOC         | HIRVONEN JESSE (JIGOTAI,FIN) |                |    |
| Category   | Kata, pojat, U16                 |         |       |             |                              |                |    |
| 3 Points   | 2 Points                         | 1 Point | Score | 1 Point     | 2 Points                     | 3 Points       |    |
|            |                                  |         | :     |             |                              |                |    |
| Penatlity  |                                  |         |       | Penatlity   |                              |                |    |
|            |                                  |         |       |             |                              |                |    |
|            |                                  |         | Total |             |                              |                |    |

## Decision of Superiority

| Judge 1 | Judge 2 | Judge 3 | Judge 4 | Judge 5 | Judge 6 | Judge 7 | Referee |
|---------|---------|---------|---------|---------|---------|---------|---------|
|         |         |         |         |         |         |         |         |

Name \_\_\_\_\_

Signature \_\_\_\_\_



# Tawastia Open Karate 2/2024

Liivuoentie 24, Hmeenlinna, FINLAND

|            |                             |         |       |             |                              |                |    |
|------------|-----------------------------|---------|-------|-------------|------------------------------|----------------|----|
| Court Nr.  | 1                           | Pool    | 1     | Date        | 2024-10-06                   | Field Position | 53 |
| <b>RED</b> |                             |         |       | <b>BLUE</b> |                              |                |    |
| NOC        | GAETTI LUCAS (JKA PORI,FIN) |         |       | NOC         | HUUSKONEN VEETI (LK-FIN,FIN) |                |    |
| Category   | Kata, pojat, U16            |         |       |             |                              |                |    |
| 3 Points   | 2 Points                    | 1 Point | Score | 1 Point     | 2 Points                     | 3 Points       |    |
|            |                             |         | :     |             |                              |                |    |
| Penatlity  |                             |         |       | Penatlity   |                              |                |    |
|            |                             |         |       |             |                              |                |    |
|            |                             |         | Total |             |                              |                |    |

## Decision of Superiority

| Judge 1 | Judge 2 | Judge 3 | Judge 4 | Judge 5 | Judge 6 | Judge 7 | Referee |
|---------|---------|---------|---------|---------|---------|---------|---------|
|         |         |         |         |         |         |         |         |

Name \_\_\_\_\_  
 Signature \_\_\_\_\_





# Tawastia Open Karate 2/2024

Liivuoentie 24, Hmeenlinna, FINLAND

|            |                              |         |       |             |                           |                |    |
|------------|------------------------------|---------|-------|-------------|---------------------------|----------------|----|
| Court Nr.  | 1                            | Pool    | 1     | Date        | 2024-10-06                | Field Position | 57 |
| <b>RED</b> |                              |         |       | <b>BLUE</b> |                           |                |    |
| NOC        | HIRVONEN JESSE (JIGOTAI,FIN) |         |       | NOC         | LHETKANGAS LUKA (OKS,FIN) |                |    |
| Category   | Kata, pojat, U16             |         |       |             |                           |                |    |
| 3 Points   | 2 Points                     | 1 Point | Score | 1 Point     | 2 Points                  | 3 Points       |    |
|            |                              |         | :     |             |                           |                |    |
| Penatlity  |                              |         |       | Penatlity   |                           |                |    |
|            |                              |         |       |             |                           |                |    |
|            |                              |         | Total |             |                           |                |    |

## Decision of Superiority

|         |         |         |         |         |         |         |         |
|---------|---------|---------|---------|---------|---------|---------|---------|
| Judge 1 | Judge 2 | Judge 3 | Judge 4 | Judge 5 | Judge 6 | Judge 7 | Referee |
|         |         |         |         |         |         |         |         |

Name

Signature

\_\_\_\_\_

\_\_\_\_\_



# Tawastia Open Karate 2/2024

Liivuoentie 24, Hmeenlinna, FINLAND

|            |                             |         |       |             |                                 |                |    |
|------------|-----------------------------|---------|-------|-------------|---------------------------------|----------------|----|
| Court Nr.  | 1                           | Pool    | 1     | Date        | 2024-10-06                      | Field Position | 58 |
| <b>RED</b> |                             |         |       | <b>BLUE</b> |                                 |                |    |
| NOC        | KIVIKOSKI JERE (LK-FIN,FIN) |         |       | NOC         | TKACHENKO TIMOFEI (JIGOTAI,FIN) |                |    |
| Category   | Kata, pojat, U16            |         |       |             |                                 |                |    |
| 3 Points   | 2 Points                    | 1 Point | Score | 1 Point     | 2 Points                        | 3 Points       |    |
|            |                             |         | :     |             |                                 |                |    |
| Penatlity  |                             |         |       | Penatlity   |                                 |                |    |
|            |                             |         |       |             |                                 |                |    |
|            |                             |         | Total |             |                                 |                |    |

## Decision of Superiority

| Judge 1 | Judge 2 | Judge 3 | Judge 4 | Judge 5 | Judge 6 | Judge 7 | Referee |
|---------|---------|---------|---------|---------|---------|---------|---------|
|         |         |         |         |         |         |         |         |

Name \_\_\_\_\_  
 Signature \_\_\_\_\_



# Tawastia Open Karate 2/2024

Liivuoentie 24, Hmeenlinna, FINLAND

|            |                              |         |       |             |                              |                |    |
|------------|------------------------------|---------|-------|-------------|------------------------------|----------------|----|
| Court Nr.  | 1                            | Pool    | 1     | Date        | 2024-10-06                   | Field Position | 59 |
| <b>RED</b> |                              |         |       | <b>BLUE</b> |                              |                |    |
| NOC        | HUUSKONEN VEETI (LK-FIN,FIN) |         |       | NOC         | TARKKANEN OTSO (JIGOTAI,FIN) |                |    |
| Category   | Kata, pojat, U16             |         |       |             |                              |                |    |
| 3 Points   | 2 Points                     | 1 Point | Score | 1 Point     | 2 Points                     | 3 Points       |    |
|            |                              |         | :     |             |                              |                |    |
| Penatlity  |                              |         |       | Penatlity   |                              |                |    |
|            |                              |         |       |             |                              |                |    |
|            |                              |         | Total |             |                              |                |    |

## Decision of Superiority

| Judge 1 | Judge 2 | Judge 3 | Judge 4 | Judge 5 | Judge 6 | Judge 7 | Referee |
|---------|---------|---------|---------|---------|---------|---------|---------|
|         |         |         |         |         |         |         |         |

Name \_\_\_\_\_

Signature \_\_\_\_\_



# Tawastia Open Karate 2/2024

Liivuoentie 24, Hmeenlinna, FINLAND

|            |                              |         |       |             |                             |                |    |
|------------|------------------------------|---------|-------|-------------|-----------------------------|----------------|----|
| Court Nr.  | 1                            | Pool    | 1     | Date        | 2024-10-06                  | Field Position | 60 |
| <b>RED</b> |                              |         |       | <b>BLUE</b> |                             |                |    |
| NOC        | PIENIMKI ROOPE (JIGOTAI,FIN) |         |       | NOC         | KIVIMKI VEIKKO (LK-FIN,FIN) |                |    |
| Category   | Kata, pojat, U16             |         |       |             |                             |                |    |
| 3 Points   | 2 Points                     | 1 Point | Score | 1 Point     | 2 Points                    | 3 Points       |    |
|            |                              |         | :     |             |                             |                |    |
| Penatlity  |                              |         |       | Penatlity   |                             |                |    |
|            |                              |         |       |             |                             |                |    |
|            |                              |         | Total |             |                             |                |    |

## Decision of Superiority

| Judge 1 | Judge 2 | Judge 3 | Judge 4 | Judge 5 | Judge 6 | Judge 7 | Referee |
|---------|---------|---------|---------|---------|---------|---------|---------|
|         |         |         |         |         |         |         |         |

Name \_\_\_\_\_  
 Signature \_\_\_\_\_



# Tawastia Open Karate 2/2024

Liivuoentie 24, Hmeenlinna, FINLAND

|            |                           |         |       |             |                             |                |    |
|------------|---------------------------|---------|-------|-------------|-----------------------------|----------------|----|
| Court Nr.  | 1                         | Pool    | 1     | Date        | 2024-10-06                  | Field Position | 61 |
| <b>RED</b> |                           |         |       | <b>BLUE</b> |                             |                |    |
| NOC        | LHETKANGAS LUKA (OKS,FIN) |         |       | NOC         | KIVIKOSKI JERE (LK-FIN,FIN) |                |    |
| Category   | Kata, pojat, U16          |         |       |             |                             |                |    |
| 3 Points   | 2 Points                  | 1 Point | Score | 1 Point     | 2 Points                    | 3 Points       |    |
|            |                           |         | :     |             |                             |                |    |
| Penatlity  |                           |         |       | Penatlity   |                             |                |    |
|            |                           |         |       |             |                             |                |    |
|            |                           |         | Total |             |                             |                |    |

## Decision of Superiority

| Judge 1 | Judge 2 | Judge 3 | Judge 4 | Judge 5 | Judge 6 | Judge 7 | Referee |
|---------|---------|---------|---------|---------|---------|---------|---------|
|         |         |         |         |         |         |         |         |

Name \_\_\_\_\_

Signature \_\_\_\_\_



# Tawastia Open Karate 2/2024

Liivuoentie 24, Hmeenlinna, FINLAND

|            |                              |         |       |             |                             |                |    |
|------------|------------------------------|---------|-------|-------------|-----------------------------|----------------|----|
| Court Nr.  | 1                            | Pool    | 1     | Date        | 2024-10-06                  | Field Position | 62 |
| <b>RED</b> |                              |         |       | <b>BLUE</b> |                             |                |    |
| NOC        | HUUSKONEN VEETI (LK-FIN,FIN) |         |       | NOC         | KIVIMKI VEIKKO (LK-FIN,FIN) |                |    |
| Category   | Kata, pojat, U16             |         |       |             |                             |                |    |
| 3 Points   | 2 Points                     | 1 Point | Score | 1 Point     | 2 Points                    | 3 Points       |    |
|            |                              |         | :     |             |                             |                |    |
| Penatlity  |                              |         |       | Penatlity   |                             |                |    |
|            |                              |         |       |             |                             |                |    |
|            |                              |         | Total |             |                             |                |    |

## Decision of Superiority

|         |         |         |         |         |         |         |         |
|---------|---------|---------|---------|---------|---------|---------|---------|
| Judge 1 | Judge 2 | Judge 3 | Judge 4 | Judge 5 | Judge 6 | Judge 7 | Referee |
|         |         |         |         |         |         |         |         |

Name

Signature

\_\_\_\_\_

\_\_\_\_\_



# Tawastia Open Karate 2/2024

Liivuoentie 24, Hmeenlinna, FINLAND

|            |                             |         |       |             |                              |                |    |
|------------|-----------------------------|---------|-------|-------------|------------------------------|----------------|----|
| Court Nr.  | 1                           | Pool    | 1     | Date        | 2024-10-06                   | Field Position | 63 |
| <b>RED</b> |                             |         |       | <b>BLUE</b> |                              |                |    |
| NOC        | KIVIKOSKI JERE (LK-FIN,FIN) |         |       | NOC         | HUUSKONEN VEETI (LK-FIN,FIN) |                |    |
| Category   | Kata, pojat, U16            |         |       |             |                              |                |    |
| 3 Points   | 2 Points                    | 1 Point | Score | 1 Point     | 2 Points                     | 3 Points       |    |
|            |                             |         | :     |             |                              |                |    |
| Penatlity  |                             |         |       | Penatlity   |                              |                |    |
|            |                             |         |       |             |                              |                |    |
|            |                             |         | Total |             |                              |                |    |

## Decision of Superiority

| Judge 1 | Judge 2 | Judge 3 | Judge 4 | Judge 5 | Judge 6 | Judge 7 | Referee |
|---------|---------|---------|---------|---------|---------|---------|---------|
|         |         |         |         |         |         |         |         |

Name \_\_\_\_\_

Signature \_\_\_\_\_



# Tawastia Open Karate 2/2024

Liivuoentie 24, Hmeenlinna, FINLAND

|            |                                 |         |       |             |                           |                |   |
|------------|---------------------------------|---------|-------|-------------|---------------------------|----------------|---|
| Court Nr.  | 1                               | Pool    | 1     | Date        | 2024-10-06                | Field Position | 0 |
| <b>RED</b> |                                 |         |       | <b>BLUE</b> |                           |                |   |
| NOC        | TKACHENKO TIMOFEI (JIGOTAI,FIN) |         |       | NOC         | LHETKANGAS LUKA (OKS,FIN) |                |   |
| Category   | Kata, pojat, U16                |         |       |             |                           |                |   |
| 3 Points   | 2 Points                        | 1 Point | Score | 1 Point     | 2 Points                  | 3 Points       |   |
|            |                                 |         | :     |             |                           |                |   |
| Penatlity  |                                 |         |       | Penatlity   |                           |                |   |
|            |                                 |         |       |             |                           |                |   |
|            |                                 |         | Total |             |                           |                |   |

## Decision of Superiority

| Judge 1 | Judge 2 | Judge 3 | Judge 4 | Judge 5 | Judge 6 | Judge 7 | Referee |
|---------|---------|---------|---------|---------|---------|---------|---------|
|         |         |         |         |         |         |         |         |

Name \_\_\_\_\_

Signature \_\_\_\_\_





# Tawastia Open Karate 2/2024

Liivuoentie 24, Hmeenlinna, FINLAND

|            |                              |         |       |             |                             |                |   |
|------------|------------------------------|---------|-------|-------------|-----------------------------|----------------|---|
| Court Nr.  | 2                            | Pool    | 2     | Date        | 2024-10-06                  | Field Position | 0 |
| <b>RED</b> |                              |         |       | <b>BLUE</b> |                             |                |   |
| NOC        | TARKKANEN OTSO (JIGOTAI,FIN) |         |       | NOC         | KIVIMKI VEIKKO (LK-FIN,FIN) |                |   |
| Category   | Kata, pojat, U16             |         |       |             |                             |                |   |
| 3 Points   | 2 Points                     | 1 Point | Score | 1 Point     | 2 Points                    | 3 Points       |   |
|            |                              |         | :     |             |                             |                |   |
| Penatlity  |                              |         |       | Penatlity   |                             |                |   |
|            |                              |         |       |             |                             |                |   |
|            |                              |         | Total |             |                             |                |   |

## Decision of Superiority

| Judge 1 | Judge 2 | Judge 3 | Judge 4 | Judge 5 | Judge 6 | Judge 7 | Referee |
|---------|---------|---------|---------|---------|---------|---------|---------|
|         |         |         |         |         |         |         |         |

Name \_\_\_\_\_

Signature \_\_\_\_\_



# Tawastia Open Karate 2/2024

Liivuoentie 24, Hmeenlinna, FINLAND

|            |                             |         |       |             |                              |                |   |
|------------|-----------------------------|---------|-------|-------------|------------------------------|----------------|---|
| Court Nr.  | 2                           | Pool    | 2     | Date        | 2024-10-06                   | Field Position | 2 |
| <b>RED</b> |                             |         |       | <b>BLUE</b> |                              |                |   |
| NOC        | GAETTI LUCAS (JKA PORI,FIN) |         |       | NOC         | TARKKANEN OTSO (JIGOTAI,FIN) |                |   |
| Category   | Kata, pojat, U16            |         |       |             |                              |                |   |
| 3 Points   | 2 Points                    | 1 Point | Score | 1 Point     | 2 Points                     | 3 Points       |   |
|            |                             |         | :     |             |                              |                |   |
| Penatlity  |                             |         |       | Penatlity   |                              |                |   |
|            |                             |         |       |             |                              |                |   |
|            |                             |         | Total |             |                              |                |   |

## Decision of Superiority







| Judge 1 | Judge 2 | Judge 3 | Judge 4 | Judge 5 | Judge 6 | Judge 7 | Referee |
|---------|---------|---------|---------|---------|---------|---------|---------|
|         |         |         |         |         |         |         |         |

Name \_\_\_\_\_  
 Signature \_\_\_\_\_



## Tawastia Open Karate 2/2024 - 2024-10-05

## Official Results

| Kata, pojat, U16 |                   |                      |   |               |
|------------------|-------------------|----------------------|---|---------------|
| 1                | HUUSKONEN VEETI   | LAHDEN KARATE        |  | FIN - FINLAND |
| 2                | KIVIKOSKI JERE    | LAHDEN KARATE        |  | FIN - FINLAND |
| 3                | LÄHETKANGAS LUKA  | OULUN<br>KARATESEURA |  | FIN - FINLAND |
| 4                | KIVIMÄKI VEIKKO   | LAHDEN KARATE        |  | FIN - FINLAND |
| 5                | TKACHENKO TIMOFEI | JIGOTAI KARATE       |  | FIN - FINLAND |
| 5                | TARKKANEN OTSO    | JIGOTAI KARATE       |  | FIN - FINLAND |
| 7                | GAETTI LUCAS      | PORIN SHOTOKAN       |  | FIN - FINLAND |

# KATA, POJAT, VALK-KELT, U10

Tawastia Open Karate 2/2024

**ENTRIES BY WEIGHT CATEGORY**  
**Kata, pojat, valk-kelt, U10**

As of 6 OCT 2024

| Country Code | ID | Gender | Name              | Seeding |
|--------------|----|--------|-------------------|---------|
| FIN          |    | M      | Castrn Ossi       |         |
| FIN          |    | M      | Haakana Sisu      |         |
| FIN          |    | M      | Joukainen Justus  |         |
| FIN          |    | M      | Repo Leo          |         |
| FIN          |    | M      | Tuomisalo Rasmus  |         |
| FIN          |    | M      | Zafar Ahmed Hasan |         |

# Kata, pojat, valk-kelt, U10

Tawastia Open Karate 2/2024, Liivuoentie 24, Hämeenlinna, FIN

2024-10-05

Tatami  
1 10:10

Pool  
1/1

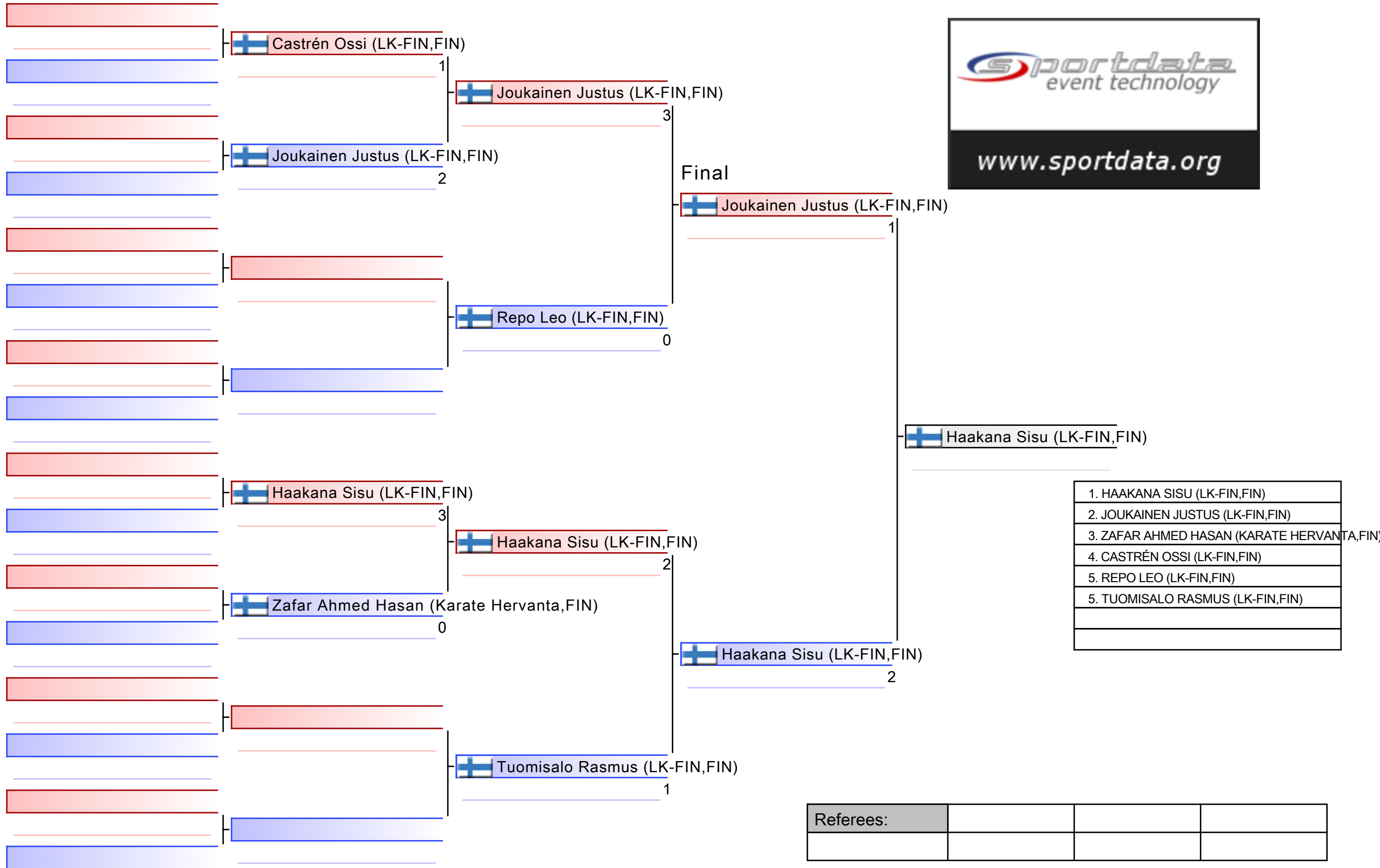

# Kata, pojat, valk-kelt, U10

Tawastia Open Karate 2/2024

2024-10-05

Tatami  
1 10:10

Pool  
1

(c)sportdata GmbH & Co KG 2000-2024 (2024-10-06 10:03) v 10.2.0 build 1 (2024-09-26 10:14 CET) License: Online\_Event\_ID-8546\_TawastiaOpenKarate22024 (expire 2024-10-20)

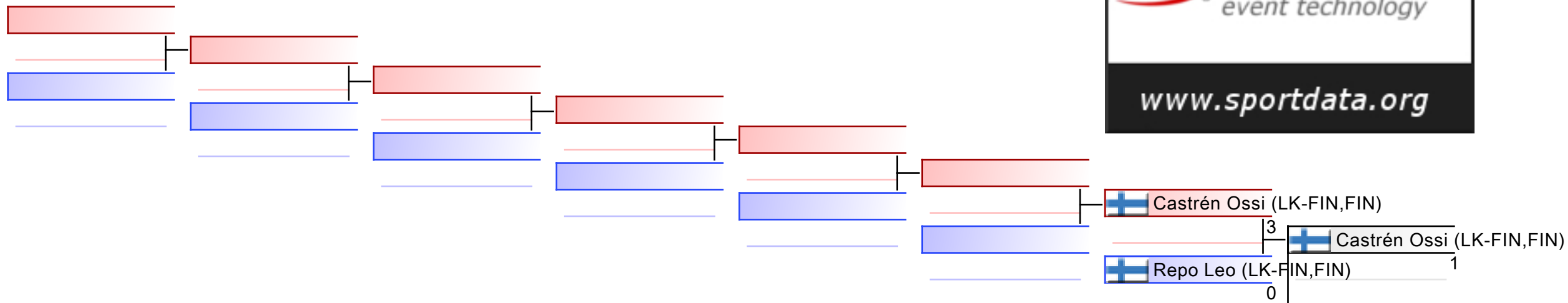

## REPECHAGE: (1)

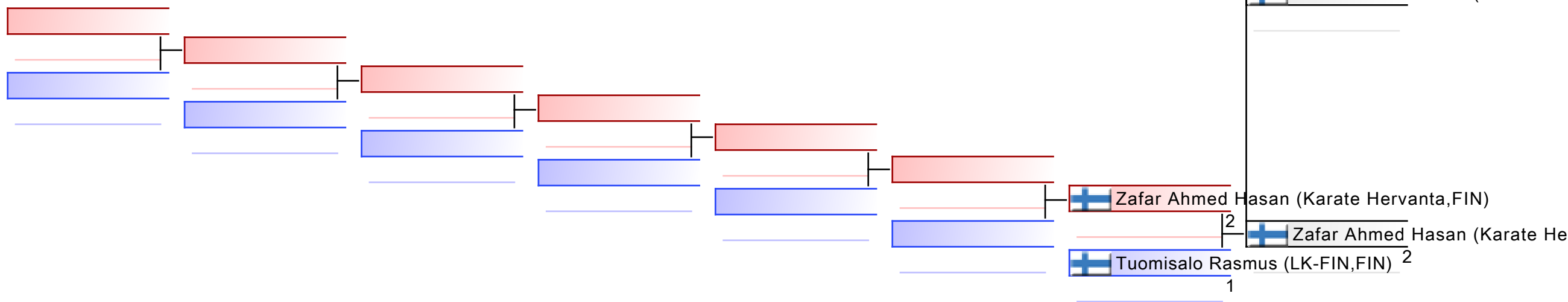

|           |  |  |  |  |  |  |  |
|-----------|--|--|--|--|--|--|--|
| Referees: |  |  |  |  |  |  |  |
|-----------|--|--|--|--|--|--|--|

# Tawastia Open Karate 2/2024

Liivuoentie 24, Hmeenlinna, FINLAND

|            |                             |         |       |             |                               |                |    |
|------------|-----------------------------|---------|-------|-------------|-------------------------------|----------------|----|
| Court Nr.  | 1                           | Pool    | 1     | Date        | 2024-10-06                    | Field Position | 57 |
| <b>RED</b> |                             |         |       | <b>BLUE</b> |                               |                |    |
| NOC        | CASTRN OSSI (LK-FIN,FIN)    |         |       | NOC         | JOUKAINEN JUSTUS (LK-FIN,FIN) |                |    |
| Category   | Kata, pojat, valk-kelt, U10 |         |       |             |                               |                |    |
| 3 Points   | 2 Points                    | 1 Point | Score | 1 Point     | 2 Points                      | 3 Points       |    |
|            |                             |         | :     |             |                               |                |    |
| Penatlity  |                             |         |       | Penatlity   |                               |                |    |
|            |                             |         |       |             |                               |                |    |
|            |                             |         | Total |             |                               |                |    |

## Decision of Superiority

|         |         |         |         |         |         |         |         |
|---------|---------|---------|---------|---------|---------|---------|---------|
| Judge 1 | Judge 2 | Judge 3 | Judge 4 | Judge 5 | Judge 6 | Judge 7 | Referee |
|         |         |         |         |         |         |         |         |

Name

Signature

\_\_\_\_\_

\_\_\_\_\_





# Tawastia Open Karate 2/2024

Liivuoentie 24, Hmeenlinna, FINLAND

|            |                             |         |       |             |   |                |    |
|------------|-----------------------------|---------|-------|-------------|---|----------------|----|
| Court Nr.  | 1                           | Pool    | 1     | Date        | 2024-10-06                              | Field Position | 59 |
| <b>RED</b> |                             |         |       | <b>BLUE</b> |   |                |    |
| NOC        | HAAKANA SISU (LK-FIN,FIN)   |         |       | NOC         | ZAFAR AHMED HASAN (KARATE HERVANTA,FIN) |                |    |
| Category   | Kata, pojat, valk-kelt, U10 |         |       |             |   |                |    |
| 3 Points   | 2 Points                    | 1 Point | Score | 1 Point     | 2 Points                                | 3 Points       |    |
|            |                             |         | :     |             |   |                |    |
| Penatlity  |                             |         |       | Penatlity   |   |                |    |
|            |                             |         |       |             |   |                |    |
|            |                             |         | Total |             |   |                |    |

## Decision of Superiority

|         |         |         |         |         |         |         |         |
|---------|---------|---------|---------|---------|---------|---------|---------|
| Judge 1 | Judge 2 | Judge 3 | Judge 4 | Judge 5 | Judge 6 | Judge 7 | Referee |
|         |         |         |         |         |         |         |         |

Name \_\_\_\_\_

Signature \_\_\_\_\_



# Tawastia Open Karate 2/2024

Liivuoentie 24, Hmeenlinna, FINLAND

|            |                               |         |       |             |                       |                |    |
|------------|-------------------------------|---------|-------|-------------|-----------------------|----------------|----|
| Court Nr.  | 1                             | Pool    | 1     | Date        | 2024-10-06            | Field Position | 61 |
| <b>RED</b> |                               |         |       | <b>BLUE</b> |                       |                |    |
| NOC        | JOUKAINEN JUSTUS (LK-FIN,FIN) |         |       | NOC         | REPO LEO (LK-FIN,FIN) |                |    |
| Category   | Kata, pojat, valk-kelt, U10   |         |       |             |                       |                |    |
| 3 Points   | 2 Points                      | 1 Point | Score | 1 Point     | 2 Points              | 3 Points       |    |
|            |                               |         | :     |             |                       |                |    |
| Penatlity  |                               |         |       | Penatlity   |                       |                |    |
|            |                               |         |       |             |                       |                |    |
|            |                               |         | Total |             |                       |                |    |

## Decision of Superiority

|         |         |         |         |         |         |         |         |
|---------|---------|---------|---------|---------|---------|---------|---------|
| Judge 1 | Judge 2 | Judge 3 | Judge 4 | Judge 5 | Judge 6 | Judge 7 | Referee |
|         |         |         |         |         |         |         |         |

Name

Signature

\_\_\_\_\_

\_\_\_\_\_



# Tawastia Open Karate 2/2024

Liivuoentie 24, Hmeenlinna, FINLAND

|            |                             |         |       |             |                               |                |    |
|------------|-----------------------------|---------|-------|-------------|-------------------------------|----------------|----|
| Court Nr.  | 1                           | Pool    | 1     | Date        | 2024-10-06                    | Field Position | 62 |
| <b>RED</b> |                             |         |       | <b>BLUE</b> |                               |                |    |
| NOC        | HAAKANA SISU (LK-FIN,FIN)   |         |       | NOC         | TUOMISALO RASMUS (LK-FIN,FIN) |                |    |
| Category   | Kata, pojat, valk-kelt, U10 |         |       |             |                               |                |    |
| 3 Points   | 2 Points                    | 1 Point | Score | 1 Point     | 2 Points                      | 3 Points       |    |
|            |                             |         | :     |             |                               |                |    |
| Penatlity  |                             |         |       | Penatlity   |                               |                |    |
|            |                             |         |       |             |                               |                |    |
|            |                             |         | Total |             |                               |                |    |

## Decision of Superiority

|         |         |         |         |         |         |         |         |
|---------|---------|---------|---------|---------|---------|---------|---------|
| Judge 1 | Judge 2 | Judge 3 | Judge 4 | Judge 5 | Judge 6 | Judge 7 | Referee |
|         |         |         |         |         |         |         |         |

Name

Signature

\_\_\_\_\_

\_\_\_\_\_



# Tawastia Open Karate 2/2024

Liivuoentie 24, Hmeenlinna, FINLAND

|            |                               |         |       |             |                           |                |    |
|------------|-------------------------------|---------|-------|-------------|---------------------------|----------------|----|
| Court Nr.  | 1                             | Pool    | 1     | Date        | 2024-10-06                | Field Position | 63 |
| <b>RED</b> |                               |         |       | <b>BLUE</b> |                           |                |    |
| NOC        | JOUKAINEN JUSTUS (LK-FIN,FIN) |         |       | NOC         | HAAKANA SISU (LK-FIN,FIN) |                |    |
| Category   | Kata, pojat, valk-kelt, U10   |         |       |             |                           |                |    |
| 3 Points   | 2 Points                      | 1 Point | Score | 1 Point     | 2 Points                  | 3 Points       |    |
|            |                               |         | :     |             |                           |                |    |
| Penatlity  |                               |         |       | Penatlity   |                           |                |    |
|            |                               |         |       |             |                           |                |    |
|            |                               |         | Total |             |                           |                |    |

## Decision of Superiority

| Judge 1 | Judge 2 | Judge 3 | Judge 4 | Judge 5 | Judge 6 | Judge 7 | Referee |
|---------|---------|---------|---------|---------|---------|---------|---------|
|         |         |         |         |         |         |         |         |

Name \_\_\_\_\_  
 Signature \_\_\_\_\_



# Tawastia Open Karate 2/2024

Liivuoventie 24, Hmeenlinna, FINLAND

|            |                             |         |       |             |                       |                |   |
|------------|-----------------------------|---------|-------|-------------|-----------------------|----------------|---|
| Court Nr.  | 1                           | Pool    | 1     | Date        | 2024-10-06            | Field Position | 0 |
| <b>RED</b> |                             |         |       | <b>BLUE</b> |                       |                |   |
| NOC        | CASTRN OSSI (LK-FIN,FIN)    |         |       | NOC         | REPO LEO (LK-FIN,FIN) |                |   |
| Category   | Kata, pojat, valk-kelt, U10 |         |       |             |                       |                |   |
| 3 Points   | 2 Points                    | 1 Point | Score | 1 Point     | 2 Points              | 3 Points       |   |
|            |                             |         | :     |             |                       |                |   |
| Penatlity  |                             |         |       | Penatlity   |                       |                |   |
|            |                             |         |       |             |                       |                |   |
|            |                             |         | Total |             |                       |                |   |

## Decision of Superiority

|         |         |         |         |         |         |         |         |
|---------|---------|---------|---------|---------|---------|---------|---------|
| Judge 1 | Judge 2 | Judge 3 | Judge 4 | Judge 5 | Judge 6 | Judge 7 | Referee |
|         |         |         |         |         |         |         |         |

Name

Signature

\_\_\_\_\_

\_\_\_\_\_



# Tawastia Open Karate 2/2024

Liivuoentie 24, Hmeenlinna, FINLAND

|            |   |         |       |             |                               |                |   |
|------------|---|---------|-------|-------------|-------------------------------|----------------|---|
| Court Nr.  | 2                                       | Pool    | 2     | Date        | 2024-10-06                    | Field Position | 0 |
| <b>RED</b> |   |         |       | <b>BLUE</b> |                               |                |   |
| NOC        | ZAFAR AHMED HASAN (KARATE HERVANTA,FIN) |         |       | NOC         | TUOMISALO RASMUS (LK-FIN,FIN) |                |   |
| Category   | Kata, pojat, valk-kelt, U10             |         |       |             |                               |                |   |
| 3 Points   | 2 Points                                | 1 Point | Score | 1 Point     | 2 Points                      | 3 Points       |   |
|            |   |         | :     |             |                               |                |   |
| Penatlity  |   |         |       | Penatlity   |                               |                |   |
|            |   |         |       |             |                               |                |   |
|            |   |         | Total |             |                               |                |   |

## Decision of Superiority

|         |         |         |         |         |         |         |         |
|---------|---------|---------|---------|---------|---------|---------|---------|
| Judge 1 | Judge 2 | Judge 3 | Judge 4 | Judge 5 | Judge 6 | Judge 7 | Referee |
|         |         |         |         |         |         |         |         |

Name

Signature







\_\_\_\_\_

\_\_\_\_\_



## Tawastia Open Karate 2/2024 - 2024-10-05

## Official Results

| Kata, pojat, valk-kelt, U10 |                   |                         |   |               |
|-----------------------------|-------------------|-------------------------|---|---------------|
| 1                           | HAAKANA SISU      | LAHDEN KARATE           |  | FIN - FINLAND |
| 2                           | JOUKAINEN JUSTUS  | LAHDEN KARATE           |  | FIN - FINLAND |
| 3                           | ZAFAR AHMED HASAN | SHOTOKAN<br>HERVANTA RY |  | FIN - FINLAND |
| 4                           | CASTRÉN OSSI      | LAHDEN KARATE           |  | FIN - FINLAND |
| 5                           | REPO LEO          | LAHDEN KARATE           |  | FIN - FINLAND |
| 5                           | TUOMISALO RASMUS  | LAHDEN KARATE           |  | FIN - FINLAND |

# KATA, POJAT, VALK-KELT, U12



Tawastia Open Karate 2/2024

**ENTRIES BY WEIGHT CATEGORY**  
**Kata, pojat, valk-kelt, U12**

As of 6 OCT 2024

| Country Code | ID | Gender | Name               | Seeding |
|--------------|----|--------|--------------------|---------|
| FIN          |    | M      | Hietava Anton      |         |
| FIN          |    | M      | Kekki Akseli       |         |
| FIN          |    | M      | Rawat Ritish Singh |         |
| FIN          |    | M      | Vnttinen Aleksii   |         |
| FIN          |    | M      | Zia Ahmed Hamza    |         |

# Kata, pojat, valk-kelt, U12

Tawastia Open Karate 2/2024, Liivuoentie 24, Hämeenlinna, FIN

2024-10-05

Tatami

1 12:35

Pool

1/1

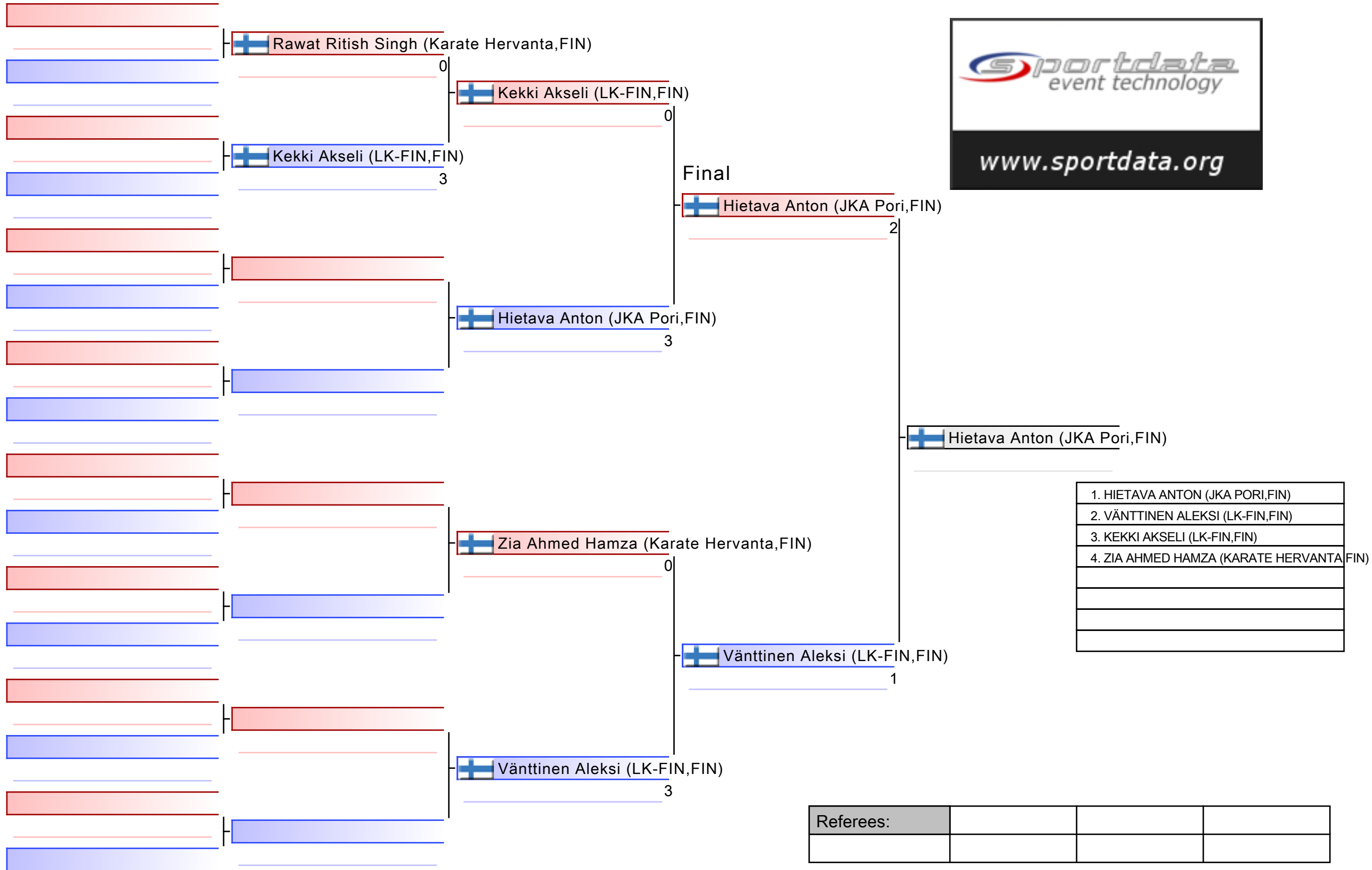

# Kata, pojat, valk-kelt, U12

Tawastia Open Karate 2/2024

2024-10-05

Tatami  
1 12:35

Pool  
1

(c)sportdata GmbH & Co KG 2000-2024 (2024-10-06 10:03) v 10.2.0 build 1 (2024-09-26 10:14 CET) License: Online\_Event\_ID-8546\_TawastiaOpenKarate22024 (expire 2024-10-20)

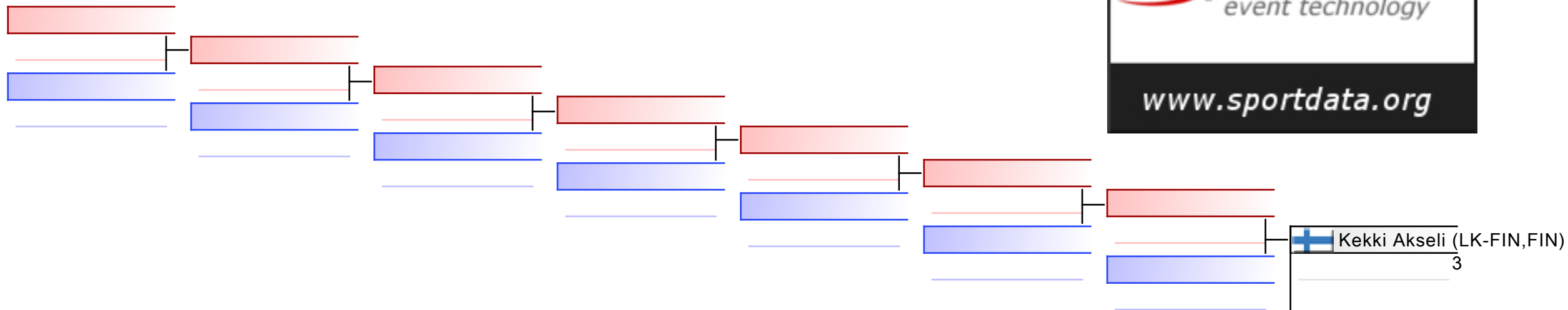

## REPECHAGE: (1)

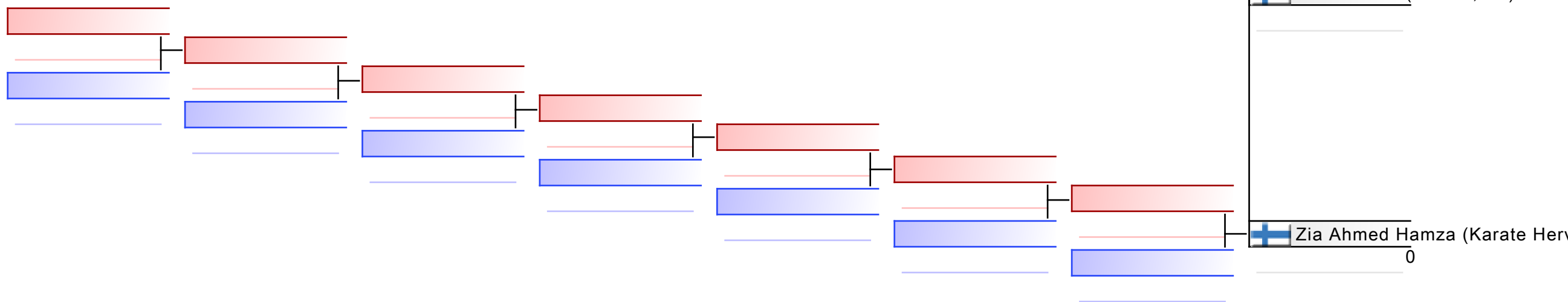

|           |  |  |  |  |  |  |  |
|-----------|--|--|--|--|--|--|--|
| Referees: |  |  |  |  |  |  |  |
|-----------|--|--|--|--|--|--|--|

# Tawastia Open Karate 2/2024

Liivuoentie 24, Hmeenlinna, FINLAND

|            |  |         |       |             |                           |                |    |
|------------|--|---------|-------|-------------|---------------------------|----------------|----|
| Court Nr.  | 1  | Pool    | 1     | Date        | 2024-10-06                | Field Position | 57 |
| <b>RED</b> |  |         |       | <b>BLUE</b> |                           |                |    |
| NOC        | RAWAT RITISH SINGH (KARATE HERVANTA,FIN) |         |       | NOC         | KEKKI AKSELI (LK-FIN,FIN) |                |    |
| Category   | Kata, pojat, valk-kelt, U12              |         |       |             |                           |                |    |
| 3 Points   | 2 Points                                 | 1 Point | Score | 1 Point     | 2 Points                  | 3 Points       |    |
|            |  |         | :     |             |                           |                |    |
| Penatlity  |  |         |       | Penatlity   |                           |                |    |
|            |  |         |       |             |                           |                |    |
|            |  |         | Total |             |                           |                |    |

## Decision of Superiority

|         |         |         |         |         |         |         |         |
|---------|---------|---------|---------|---------|---------|---------|---------|
| Judge 1 | Judge 2 | Judge 3 | Judge 4 | Judge 5 | Judge 6 | Judge 7 | Referee |
|         |         |         |         |         |         |         |         |

Name \_\_\_\_\_

Signature \_\_\_\_\_



# Tawastia Open Karate 2/2024

Liivuoentie 24, Hmeenlinna, FINLAND

|            |                             |         |       |             |                              |                |    |
|------------|-----------------------------|---------|-------|-------------|------------------------------|----------------|----|
| Court Nr.  | 1                           | Pool    | 1     | Date        | 2024-10-06                   | Field Position | 61 |
| <b>RED</b> |                             |         |       | <b>BLUE</b> |                              |                |    |
| NOC        | KEKKI AKSELI (LK-FIN,FIN)   |         |       | NOC         | HIETAVA ANTON (JKA PORI,FIN) |                |    |
| Category   | Kata, pojat, valk-kelt, U12 |         |       |             |                              |                |    |
| 3 Points   | 2 Points                    | 1 Point | Score | 1 Point     | 2 Points                     | 3 Points       |    |
|            |                             |         | :     |             |                              |                |    |
| Penatlity  |                             |         |       | Penatlity   |                              |                |    |
|            |                             |         |       |             |                              |                |    |
|            |                             |         | Total |             |                              |                |    |

## Decision of Superiority

| Judge 1 | Judge 2 | Judge 3 | Judge 4 | Judge 5 | Judge 6 | Judge 7 | Referee |
|---------|---------|---------|---------|---------|---------|---------|---------|
|         |         |         |         |         |         |         |         |

Name \_\_\_\_\_  
 Signature \_\_\_\_\_



# Tawastia Open Karate 2/2024

Liivuoventie 24, Hmeenlinna, FINLAND

|            |                                       |         |       |             |                              |                |    |
|------------|---------------------------------------|---------|-------|-------------|------------------------------|----------------|----|
| Court Nr.  | 1                                     | Pool    | 1     | Date        | 2024-10-06                   | Field Position | 62 |
| <b>RED</b> |                                       |         |       | <b>BLUE</b> |                              |                |    |
| NOC        | ZIA AHMED HAMZA (KARATE HERVANTA,FIN) |         |       | NOC         | VNTTINEN ALEKSI (LK-FIN,FIN) |                |    |
| Category   | Kata, pojat, valk-kelt, U12           |         |       |             |                              |                |    |
| 3 Points   | 2 Points                              | 1 Point | Score | 1 Point     | 2 Points                     | 3 Points       |    |
|            |                                       |         | :     |             |                              |                |    |
| Penatlity  |                                       |         |       | Penatlity   |                              |                |    |
|            |                                       |         |       |             |                              |                |    |
|            |                                       |         | Total |             |                              |                |    |

## Decision of Superiority

|         |         |         |         |         |         |         |         |
|---------|---------|---------|---------|---------|---------|---------|---------|
| Judge 1 | Judge 2 | Judge 3 | Judge 4 | Judge 5 | Judge 6 | Judge 7 | Referee |
|         |         |         |         |         |         |         |         |

Name

Signature

\_\_\_\_\_  
\_\_\_\_\_



# Tawastia Open Karate 2/2024

Liivuoentie 24, Hmeenlinna, FINLAND

|            |                              |         |       |             |                              |                |    |
|------------|------------------------------|---------|-------|-------------|------------------------------|----------------|----|
| Court Nr.  | 1                            | Pool    | 1     | Date        | 2024-10-06                   | Field Position | 63 |
| <b>RED</b> |                              |         |       | <b>BLUE</b> |                              |                |    |
| NOC        | HIETAVA ANTON (JKA PORI,FIN) |         |       | NOC         | VNTTINEN ALEKSI (LK-FIN,FIN) |                |    |
| Category   | Kata, pojat, valk-kelt, U12  |         |       |             |                              |                |    |
| 3 Points   | 2 Points                     | 1 Point | Score | 1 Point     | 2 Points                     | 3 Points       |    |
|            |                              |         | :     |             |                              |                |    |
| Penatlity  |                              |         |       | Penatlity   |                              |                |    |
|            |                              |         |       |             |                              |                |    |
|            |                              |         | Total |             |                              |                |    |

## Decision of Superiority

|         |         |         |         |         |         |         |         |
|---------|---------|---------|---------|---------|---------|---------|---------|
| Judge 1 | Judge 2 | Judge 3 | Judge 4 | Judge 5 | Judge 6 | Judge 7 | Referee |
|         |         |         |         |         |         |         |         |

Name

Signature

\_\_\_\_\_

\_\_\_\_\_











Tawastia Open Karate 2/2024 - 2024-10-05

Official Results

| Kata, pojat, valk-kelt, U12 |                  |                         |   |               |
|-----------------------------|------------------|-------------------------|---|---------------|
| 1                           | HIETAVA ANTON    | PORIN SHOTOKAN          |  | FIN - FINLAND |
| 2                           | VÄNTTINEN ALEKSI | LAHDEN KARATE           |  | FIN - FINLAND |
| 3                           | KEKKI AKSELI     | LAHDEN KARATE           |  | FIN - FINLAND |
| 4                           | ZIA AHMED HAMZA  | SHOTOKAN<br>HERVANTA RY |  | FIN - FINLAND |

# KATA, POJAT, VALKOISET, U8

Tawastia Open Karate 2/2024

**ENTRIES BY WEIGHT CATEGORY**  
**Kata, pojat, valkoiset, U8**

As of 6 OCT 2024

| Country Code | ID | Gender | Name           | Seeding |
|--------------|----|--------|----------------|---------|
| FIN          |    | M      | Tejesvi Vivaan |         |
| FIN          |    | M      | Teppo Eino     |         |
| FIN          |    | M      | Teppo Vin      |         |

# Kata, pojat, valkoiset, U8 - Round Robin (each against each)

Tawastia Open Karate 2/2024, Liivuaarentie 24, Hämeenlinna, FIN









2024-10-05

Tatami

1 10:20

Pool

1/1

|   |  |   |  |
|---|--|---|--|
| 1 |  Teppo Eino (Jigotai,FIN)  | 0 |  Tejesvi Vivaan (OKS,FIN) |
| 2 |  Tejesvi Vivaan (OKS,FIN)  | 3 |  |
| 3 |  Teppo Eino (Jigotai,FIN)  | 3 |  Teppo Eino (Jigotai,FIN) |
| 4 |  Teppo Väinö (Jigotai,FIN) | 0 |  |
| 5 |  Tejesvi Vivaan (OKS,FIN)  | 3 |  Tejesvi Vivaan (OKS,FIN) |
| 6 |  Teppo Väinö (Jigotai,FIN) | 0 |  |



|                              |
|------------------------------|
| 1. TEJESVI VIVAAN (OKS,FIN)  |
| 2. TEPPU EINO (JIGOTAI,FIN)  |
| 3. TEPPU VÄINÖ (JIGOTAI,FIN) |
|                              |
|                              |
|                              |
|                              |

|           |  |  |  |
|-----------|--|--|--|
| Referees: |  |  |  |
|           |  |  |  |

# Tawastia Open Karate 2/2024

Liivuoentie 24, Hmeenlinna, FINLAND

|            |                            |         |       |             |                          |                |       |
|------------|----------------------------|---------|-------|-------------|--------------------------|----------------|-------|
| Court Nr.  | 1                          | Pool    | 1     | Date        | 2024-10-06               | Field Position | -9951 |
| <b>RED</b> |                            |         |       | <b>BLUE</b> |                          |                |       |
| NOC        | TEPPO EINO (JIGOTAI,FIN)   |         |       | NOC         | TEJESVI VIVAAN (OKS,FIN) |                |       |
| Category   | Kata, pojat, valkoiset, U8 |         |       |             |                          |                |       |
| 3 Points   | 2 Points                   | 1 Point | Score | 1 Point     | 2 Points                 | 3 Points       |       |
|            |                            |         | :     |             |                          |                |       |
| Penatlity  |                            |         |       | Penatlity   |                          |                |       |
|            |                            |         |       |             |                          |                |       |
|            |                            |         | Total |             |                          |                |       |

## Decision of Superiority

|         |         |         |         |         |         |         |         |
|---------|---------|---------|---------|---------|---------|---------|---------|
| Judge 1 | Judge 2 | Judge 3 | Judge 4 | Judge 5 | Judge 6 | Judge 7 | Referee |
|         |         |         |         |         |         |         |         |

Name

Signature

\_\_\_\_\_  
\_\_\_\_\_



# Tawastia Open Karate 2/2024

Liivuoentie 24, Hmeenlinna, FINLAND

|            |                            |         |       |             |                         |                |       |
|------------|----------------------------|---------|-------|-------------|-------------------------|----------------|-------|
| Court Nr.  | 1                          | Pool    | 1     | Date        | 2024-10-06              | Field Position | -9950 |
| <b>RED</b> |                            |         |       | <b>BLUE</b> |                         |                |       |
| NOC        | TEPPO EINO (JIGOTAI,FIN)   |         |       | NOC         | TEPPO VIN (JIGOTAI,FIN) |                |       |
| Category   | Kata, pojat, valkoiset, U8 |         |       |             |                         |                |       |
| 3 Points   | 2 Points                   | 1 Point | Score | 1 Point     | 2 Points                | 3 Points       |       |
|            |                            |         | :     |             |                         |                |       |
| Penatlity  |                            |         |       | Penatlity   |                         |                |       |
|            |                            |         |       |             |                         |                |       |
|            |                            |         | Total |             |                         |                |       |

## Decision of Superiority

|         |         |         |         |         |         |         |         |
|---------|---------|---------|---------|---------|---------|---------|---------|
| Judge 1 | Judge 2 | Judge 3 | Judge 4 | Judge 5 | Judge 6 | Judge 7 | Referee |
|         |         |         |         |         |         |         |         |

Name

Signature

\_\_\_\_\_

\_\_\_\_\_



# Tawastia Open Karate 2/2024

Liivuoentie 24, Hmeenlinna, FINLAND

|            |                            |         |       |             |                         |                |       |
|------------|----------------------------|---------|-------|-------------|-------------------------|----------------|-------|
| Court Nr.  | 1                          | Pool    | 1     | Date        | 2024-10-06              | Field Position | -9949 |
| <b>RED</b> |                            |         |       | <b>BLUE</b> |                         |                |       |
| NOC        | TEJESVI VIVAAN (OKS,FIN)   |         |       | NOC         | TEPPO VIN (JIGOTAI,FIN) |                |       |
| Category   | Kata, pojat, valkoiset, U8 |         |       |             |                         |                |       |
| 3 Points   | 2 Points                   | 1 Point | Score | 1 Point     | 2 Points                | 3 Points       |       |
|            |                            |         | :     |             |                         |                |       |
| Penatlity  |                            |         |       | Penatlity   |                         |                |       |
|            |                            |         |       |             |                         |                |       |
|            |                            |         | Total |             |                         |                |       |

## Decision of Superiority

| Judge 1 | Judge 2 | Judge 3 | Judge 4 | Judge 5 | Judge 6 | Judge 7 | Referee |
|---------|---------|---------|---------|---------|---------|---------|---------|
|         |         |         |         |         |         |         |         |



Name \_\_\_\_\_

Signature \_\_\_\_\_



Tawastia Open Karate 2/2024 - 2024-10-05

Official Results

| Kata, pojat, valkoiset, U8 |                |                      |   |               |  |
|----------------------------|----------------|----------------------|---|---------------|--|
| 1                          | TEJESVI VIVAAN | OULUN<br>KARATESEURA |  | FIN - FINLAND |  |
| 2                          | TEPPO EINO     | JIGOTAI KARATE       |  | FIN - FINLAND |  |
| 3                          | TEPPO VÄINÖ    | JIGOTAI KARATE       |  | FIN - FINLAND |  |



# KATA, TYTÖT, U10

Tawastia Open Karate 2/2024

**ENTRIES BY WEIGHT CATEGORY**

**Kata, tytt, U10**

As of 6 OCT 2024

| Country Code | ID | Gender | Name            | Seeding |
|--------------|----|--------|-----------------|---------|
| FIN          |    | F      | Batikeru Laasya |         |
| FIN          |    | F      | Korhonen Meeri  |         |
| FIN          |    | F      | MAKSYMUK ULIANA |         |

# Kata, tytöt, U10 - Round Robin (each against each)

Tawastia Open Karate 2/2024, Liivuoentie 24, Hämeenlinna, FIN

2024-10-05

Tatami

1 10:00

Pool

1/1

- 1 🇫🇮 Korhonen Meeri (Korhonen,FIN)  

1| 🇫🇮 MAKSYMUK ULIANA (Maksymuk,FIN)
- 2 🇫🇮 MAKSYMUK ULIANA (Maksymuk,FIN)  

2
- 3 🇫🇮 Korhonen Meeri (Korhonen,FIN)  

3| 🇫🇮 Korhonen Meeri (Korhonen,FIN)
- 4 🇫🇮 Batikeru Laasya (Karate Hervanta,FIN)  

0
- 5 🇫🇮 MAKSYMUK ULIANA (Maksymuk,FIN)  

3| 🇫🇮 MAKSYMUK ULIANA (Maksymuk,FIN)
- 6 🇫🇮 Batikeru Laasya (Karate Hervanta,FIN)  

0



|  |
|--|
| 1. MAKSYMUK ULIANA (MAKSYMUK,FIN)        |
| 2. KORHONEN MEERI (KORHONEN,FIN)         |
| 3. BATIKERU LAASYA (KARATE HERVANTA,FIN) |
|  |
|  |
|  |
|  |

|           |  |  |  |  |
|-----------|--|--|--|--|
| Referees: |  |  |  |  |
|           |  |  |  |  |

# Tawastia Open Karate 2/2024

Liivuoentie 24, Hmeenlinna, FINLAND

|            |                               |         |       |             |                                |                |       |
|------------|-------------------------------|---------|-------|-------------|--------------------------------|----------------|-------|
| Court Nr.  | 1                             | Pool    | 1     | Date        | 2024-10-06                     | Field Position | -9951 |
| <b>RED</b> |                               |         |       | <b>BLUE</b> |                                |                |       |
| NOC        | KORHONEN MEERI (KORHONEN,FIN) |         |       | NOC         | MAKSYMUK ULIANA (MAKSYMUK,FIN) |                |       |
| Category   | Kata, tytt, U10               |         |       |             |                                |                |       |
| 3 Points   | 2 Points                      | 1 Point | Score | 1 Point     | 2 Points                       | 3 Points       |       |
|            |                               |         | :     |             |                                |                |       |
| Penatlity  |                               |         |       | Penatlity   |                                |                |       |
|            |                               |         |       |             |                                |                |       |
|            |                               |         | Total |             |                                |                |       |

## Decision of Superiority

| Judge 1 | Judge 2 | Judge 3 | Judge 4 | Judge 5 | Judge 6 | Judge 7 | Referee |
|---------|---------|---------|---------|---------|---------|---------|---------|
|         |         |         |         |         |         |         |         |

Name \_\_\_\_\_  
 Signature \_\_\_\_\_



# Tawastia Open Karate 2/2024

Liivuoentie 24, Hmeenlinna, FINLAND

|            |                               |         |       |             |                                       |                |       |
|------------|-------------------------------|---------|-------|-------------|---------------------------------------|----------------|-------|
| Court Nr.  | 1                             | Pool    | 1     | Date        | 2024-10-06                            | Field Position | -9950 |
| <b>RED</b> |                               |         |       | <b>BLUE</b> |                                       |                |       |
| NOC        | KORHONEN MEERI (KORHONEN,FIN) |         |       | NOC         | BATIKERU LAASYA (KARATE HERVANTA,FIN) |                |       |
| Category   | Kata, tytt, U10               |         |       |             |                                       |                |       |
| 3 Points   | 2 Points                      | 1 Point | Score | 1 Point     | 2 Points                              | 3 Points       |       |
|            |                               |         | :     |             |                                       |                |       |
| Penatlity  |                               |         |       | Penatlity   |                                       |                |       |
|            |                               |         |       |             |                                       |                |       |
|            |                               |         | Total |             |                                       |                |       |

## Decision of Superiority

|         |         |         |         |         |         |         |         |
|---------|---------|---------|---------|---------|---------|---------|---------|
| Judge 1 | Judge 2 | Judge 3 | Judge 4 | Judge 5 | Judge 6 | Judge 7 | Referee |
|         |         |         |         |         |         |         |         |

Name \_\_\_\_\_

Signature \_\_\_\_\_



# Tawastia Open Karate 2/2024

Liivuoentie 24, Hmeenlinna, FINLAND

|            |                                |         |       |             |                                       |                |       |
|------------|--------------------------------|---------|-------|-------------|---------------------------------------|----------------|-------|
| Court Nr.  | 1                              | Pool    | 1     | Date        | 2024-10-06                            | Field Position | -9949 |
| <b>RED</b> |                                |         |       | <b>BLUE</b> |                                       |                |       |
| NOC        | MAKSYMUK ULIANA (MAKSYMUK,FIN) |         |       | NOC         | BATIKERU LAASYA (KARATE HERVANTA,FIN) |                |       |
| Category   | Kata, tytt, U10                |         |       |             |                                       |                |       |
| 3 Points   | 2 Points                       | 1 Point | Score | 1 Point     | 2 Points                              | 3 Points       |       |
|            |                                |         | :     |             |                                       |                |       |
| Penatlity  |                                |         |       | Penatlity   |                                       |                |       |
|            |                                |         |       |             |                                       |                |       |
|            |                                |         | Total |             |                                       |                |       |

## Decision of Superiority

|         |         |         |         |         |         |         |         |
|---------|---------|---------|---------|---------|---------|---------|---------|
| Judge 1 | Judge 2 | Judge 3 | Judge 4 | Judge 5 | Judge 6 | Judge 7 | Referee |
|         |         |         |         |         |         |         |         |



Name \_\_\_\_\_

Signature \_\_\_\_\_



Tawastia Open Karate 2/2024 - 2024-10-05

Official Results

| Kata, tytöt, U10 |                 |                         |   |               |
|------------------|-----------------|-------------------------|---|---------------|
| 1                | MAKSYMUK ULIANA | MAKSYMUK                |  | FIN - FINLAND |
| 2                | KORHONEN MEERI  | KORHONEN                |  | FIN - FINLAND |
| 3                | BATIKERU LAASYA | SHOTOKAN<br>HERVANTA RY |  | FIN - FINLAND |

# KATA, TYTÖT, U12



Tawastia Open Karate 2/2024

**ENTRIES BY WEIGHT CATEGORY**  
**Kata, tytt, U12**

As of 6 OCT 2024

| Country Code | ID | Gender | Name              | Seeding |
|--------------|----|--------|-------------------|---------|
| FIN          |    | F      | Anbar Hiba        |         |
| FIN          |    | F      | Arun Isha         |         |
| FIN          |    | F      | Asiala Erin       |         |
| FIN          |    | F      | Hakala Hanna      |         |
| FIN          |    | F      | Heino Lilya       |         |
| FIN          |    | F      | Heinnen Vanessa   |         |
| FIN          |    | F      | Koskela Jasmin    |         |
| FIN          |    | F      | Lehtiniemi Erin   |         |
| FIN          |    | F      | Lindroos Emilia   |         |
| FIN          |    | F      | MAKSYMUK POLINA   |         |
| FIN          |    | F      | Mkel Jenna        |         |
| FIN          |    | F      | Naskali Jatta     |         |
| FIN          |    | F      | Nuhanovic Amina   |         |
| FIN          |    | F      | Nyknen Tara       |         |
| FIN          |    | F      | Sankari Nelli     |         |
| FIN          |    | F      | Veneranta Cecilia |         |

# Kata, tytöt, U12

Tawastia Open Karate 2/2024, Liivourentie 24, Hämeenlinna, FIN

2024-10-05

Tatami  
1 13:40

Pool  
1/1

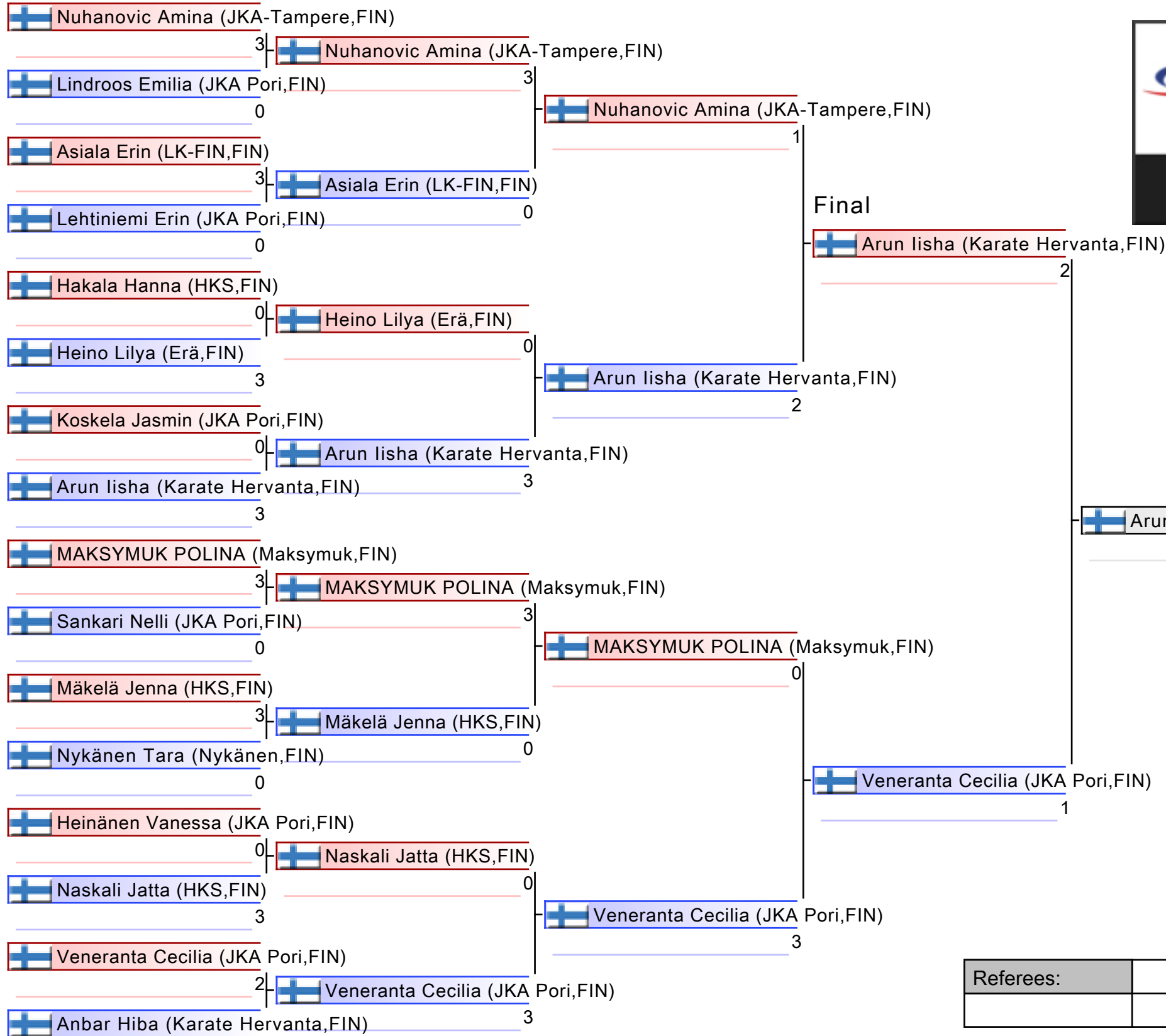

|                                      |
|--------------------------------------|
| 1. ARUN IISHA (KARATE HERVANTA,FIN)  |
| 2. VENERANTA CECILIA (JKA PORI,FIN)  |
| 3. KOSKELA JASMIN (JKA PORI,FIN)     |
| 4. ANBAR HIBA (KARATE HERVANTA,FIN)  |
| 5. NUHANOVIC AMINA (JKA-TAMPERE,FIN) |
| 5. MAKSYMUK POLINA (MAKSYMUK,FIN)    |
| 7. HEINO LILYA (ERÄ,FIN)             |
| 7. NASKALI JATTA (HKS,FIN)           |

|           |  |  |  |
|-----------|--|--|--|
| Referees: |  |  |  |
|           |  |  |  |

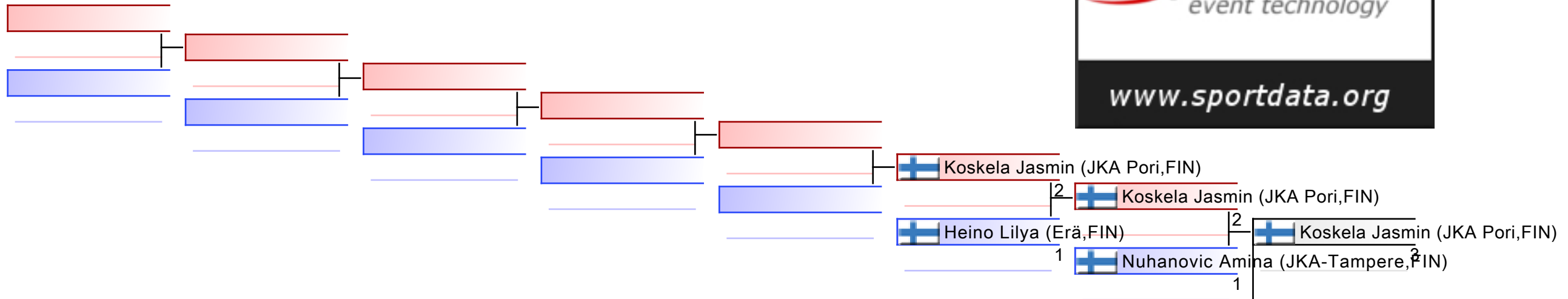

REPECHAGE: (1)

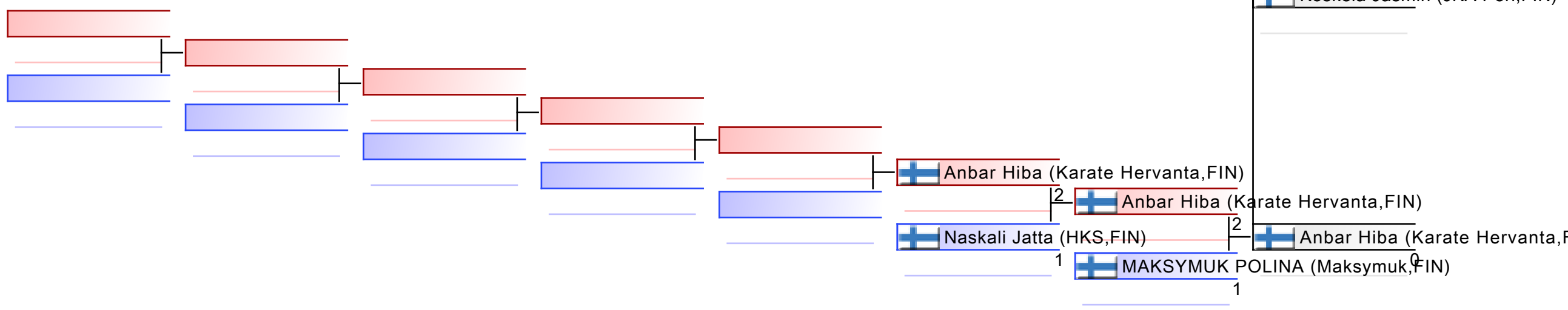

|           |  |  |  |  |  |  |  |
|-----------|--|--|--|--|--|--|--|
| Referees: |  |  |  |  |  |  |  |
|-----------|--|--|--|--|--|--|--|

# Tawastia Open Karate 2/2024

Liivuoentie 24, Hmeenlinna, FINLAND

|            |                                      |         |       |             |                                |                |    |
|------------|--------------------------------------|---------|-------|-------------|--------------------------------|----------------|----|
| Court Nr.  | 1                                    | Pool    | 1     | Date        | 2024-10-06                     | Field Position | 49 |
| <b>RED</b> |                                      |         |       | <b>BLUE</b> |                                |                |    |
| NOC        | NUHANOVIC AMINA<br>(JKA-TAMPERE,FIN) |         |       | NOC         | LINDROOS EMILIA (JKA PORI,FIN) |                |    |
| Category   | Kata, tytt, U12                      |         |       |             |                                |                |    |
| 3 Points   | 2 Points                             | 1 Point | Score | 1 Point     | 2 Points                       | 3 Points       |    |
|            |                                      |         | :     |             |                                |                |    |
| Penatlity  |                                      |         |       | Penatlity   |                                |                |    |
|            |                                      |         |       |             |                                |                |    |
|            |                                      |         | Total |             |                                |                |    |

## Decision of Superiority

| Judge 1 | Judge 2 | Judge 3 | Judge 4 | Judge 5 | Judge 6 | Judge 7 | Referee |
|---------|---------|---------|---------|---------|---------|---------|---------|
|         |         |         |         |         |         |         |         |

Name \_\_\_\_\_  
Signature \_\_\_\_\_



# Tawastia Open Karate 2/2024

Liivuoentie 24, Hmeenlinna, FINLAND

|            |                          |         |       |             |                                |                |    |
|------------|--------------------------|---------|-------|-------------|--------------------------------|----------------|----|
| Court Nr.  | 1                        | Pool    | 1     | Date        | 2024-10-06                     | Field Position | 50 |
| <b>RED</b> |                          |         |       | <b>BLUE</b> |                                |                |    |
| NOC        | ASIALA ERIN (LK-FIN,FIN) |         |       | NOC         | LEHTINIEMI ERIN (JKA PORI,FIN) |                |    |
| Category   | Kata, tytt, U12          |         |       |             |                                |                |    |
| 3 Points   | 2 Points                 | 1 Point | Score | 1 Point     | 2 Points                       | 3 Points       |    |
|            |                          |         | :     |             |                                |                |    |
| Penatlity  |                          |         |       | Penatlity   |                                |                |    |
|            |                          |         |       |             |                                |                |    |
|            |                          |         | Total |             |                                |                |    |

## Decision of Superiority

|         |         |         |         |         |         |         |         |
|---------|---------|---------|---------|---------|---------|---------|---------|
| Judge 1 | Judge 2 | Judge 3 | Judge 4 | Judge 5 | Judge 6 | Judge 7 | Referee |
|         |         |         |         |         |         |         |         |

Name

Signature

\_\_\_\_\_

\_\_\_\_\_



# Tawastia Open Karate 2/2024

Liivuoentie 24, Hmeenlinna, FINLAND

|            |                        |         |       |             |                      |                |    |
|------------|------------------------|---------|-------|-------------|----------------------|----------------|----|
| Court Nr.  | 1                      | Pool    | 1     | Date        | 2024-10-06           | Field Position | 51 |
| <b>RED</b> |                        |         |       | <b>BLUE</b> |                      |                |    |
| NOC        | HAKALA HANNA (HKS,FIN) |         |       | NOC         | HEINO LILYA (ER,FIN) |                |    |
| Category   | Kata, tytt, U12        |         |       |             |                      |                |    |
| 3 Points   | 2 Points               | 1 Point | Score | 1 Point     | 2 Points             | 3 Points       |    |
|            |                        |         | :     |             |                      |                |    |
| Penatlity  |                        |         |       | Penatlity   |                      |                |    |
|            |                        |         |       |             |                      |                |    |
|            |                        |         | Total |             |                      |                |    |

## Decision of Superiority

| Judge 1 | Judge 2 | Judge 3 | Judge 4 | Judge 5 | Judge 6 | Judge 7 | Referee |
|---------|---------|---------|---------|---------|---------|---------|---------|
|         |         |         |         |         |         |         |         |

Name \_\_\_\_\_  
 Signature \_\_\_\_\_



# Tawastia Open Karate 2/2024

Liivuoentie 24, Hmeenlinna, FINLAND

|            |                               |         |       |             |                                  |                |    |
|------------|-------------------------------|---------|-------|-------------|----------------------------------|----------------|----|
| Court Nr.  | 1                             | Pool    | 1     | Date        | 2024-10-06                       | Field Position | 52 |
| <b>RED</b> |                               |         |       | <b>BLUE</b> |                                  |                |    |
| NOC        | KOSKELA JASMIN (JKA PORI,FIN) |         |       | NOC         | ARUN IISHA (KARATE HERVANTA,FIN) |                |    |
| Category   | Kata, tytt, U12               |         |       |             |                                  |                |    |
| 3 Points   | 2 Points                      | 1 Point | Score | 1 Point     | 2 Points                         | 3 Points       |    |
|            |                               |         | :     |             |                                  |                |    |
| Penatlity  |                               |         |       | Penatlity   |                                  |                |    |
|            |                               |         |       |             |                                  |                |    |
|            |                               |         | Total |             |                                  |                |    |

## Decision of Superiority

|         |         |         |         |         |         |         |         |
|---------|---------|---------|---------|---------|---------|---------|---------|
| Judge 1 | Judge 2 | Judge 3 | Judge 4 | Judge 5 | Judge 6 | Judge 7 | Referee |
|         |         |         |         |         |         |         |         |

Name \_\_\_\_\_  
 Signature \_\_\_\_\_



# Tawastia Open Karate 2/2024

Liivuoentie 24, Hmeenlinna, FINLAND

|            |                                |         |       |             |                              |                |    |
|------------|--------------------------------|---------|-------|-------------|------------------------------|----------------|----|
| Court Nr.  | 1                              | Pool    | 1     | Date        | 2024-10-06                   | Field Position | 53 |
| <b>RED</b> |                                |         |       | <b>BLUE</b> |                              |                |    |
| NOC        | MAKSYMUK POLINA (MAKSYMUK,FIN) |         |       | NOC         | SANKARI NELLI (JKA PORI,FIN) |                |    |
| Category   | Kata, tytt, U12                |         |       |             |                              |                |    |
| 3 Points   | 2 Points                       | 1 Point | Score | 1 Point     | 2 Points                     | 3 Points       |    |
|            |                                |         | :     |             |                              |                |    |
| Penatlity  |                                |         |       | Penatlity   |                              |                |    |
|            |                                |         |       |             |                              |                |    |
|            |                                |         | Total |             |                              |                |    |

## Decision of Superiority

|         |         |         |         |         |         |         |         |
|---------|---------|---------|---------|---------|---------|---------|---------|
| Judge 1 | Judge 2 | Judge 3 | Judge 4 | Judge 5 | Judge 6 | Judge 7 | Referee |
|         |         |         |         |         |         |         |         |

Name \_\_\_\_\_

Signature \_\_\_\_\_





# Tawastia Open Karate 2/2024

Liivuoentie 24, Hmeenlinna, FINLAND

|            |                      |         |       |             |                          |                |    |
|------------|----------------------|---------|-------|-------------|--------------------------|----------------|----|
| Court Nr.  | 1                    | Pool    | 1     | Date        | 2024-10-06               | Field Position | 54 |
| <b>RED</b> |                      |         |       | <b>BLUE</b> |                          |                |    |
| NOC        | MKEL JENNA (HKS,FIN) |         |       | NOC         | NYKNEN TARA (NYKNEN,FIN) |                |    |
| Category   | Kata, tytt, U12      |         |       |             |                          |                |    |
| 3 Points   | 2 Points             | 1 Point | Score | 1 Point     | 2 Points                 | 3 Points       |    |
|            |                      |         | :     |             |                          |                |    |
| Penatlity  |                      |         |       | Penatlity   |                          |                |    |
|            |                      |         |       |             |                          |                |    |
|            |                      |         | Total |             |                          |                |    |

## Decision of Superiority

| Judge 1 | Judge 2 | Judge 3 | Judge 4 | Judge 5 | Judge 6 | Judge 7 | Referee |
|---------|---------|---------|---------|---------|---------|---------|---------|
|         |         |         |         |         |         |         |         |

Name \_\_\_\_\_

Signature \_\_\_\_\_



# Tawastia Open Karate 2/2024

Liivuoentie 24, Hmeenlinna, FINLAND

|            |                                |         |       |             |                         |                |    |
|------------|--------------------------------|---------|-------|-------------|-------------------------|----------------|----|
| Court Nr.  | 1                              | Pool    | 1     | Date        | 2024-10-06              | Field Position | 55 |
| <b>RED</b> |                                |         |       | <b>BLUE</b> |                         |                |    |
| NOC        | HEINNEN VANESSA (JKA PORI,FIN) |         |       | NOC         | NASKALI JATTA (HKS,FIN) |                |    |
| Category   | Kata, tytt, U12                |         |       |             |                         |                |    |
| 3 Points   | 2 Points                       | 1 Point | Score | 1 Point     | 2 Points                | 3 Points       |    |
|            |                                |         | :     |             |                         |                |    |
| Penatlity  |                                |         |       | Penatlity   |                         |                |    |
|            |                                |         |       |             |                         |                |    |
|            |                                |         | Total |             |                         |                |    |

## Decision of Superiority

| Judge 1 | Judge 2 | Judge 3 | Judge 4 | Judge 5 | Judge 6 | Judge 7 | Referee |
|---------|---------|---------|---------|---------|---------|---------|---------|
|         |         |         |         |         |         |         |         |

Name \_\_\_\_\_  
 Signature \_\_\_\_\_



# Tawastia Open Karate 2/2024

Liivuoentie 24, Hmeenlinna, FINLAND

|            |                                  |         |       |             |                                  |                |    |
|------------|----------------------------------|---------|-------|-------------|----------------------------------|----------------|----|
| Court Nr.  | 1                                | Pool    | 1     | Date        | 2024-10-06                       | Field Position | 56 |
| <b>RED</b> |                                  |         |       | <b>BLUE</b> |                                  |                |    |
| NOC        | VENERANTA CECILIA (JKA PORI,FIN) |         |       | NOC         | ANBAR HIBA (KARATE HERVANTA,FIN) |                |    |
| Category   | Kata, tytt, U12                  |         |       |             |                                  |                |    |
| 3 Points   | 2 Points                         | 1 Point | Score | 1 Point     | 2 Points                         | 3 Points       |    |
|            |                                  |         | :     |             |                                  |                |    |
| Penatlity  |                                  |         |       | Penatlity   |                                  |                |    |
|            |                                  |         |       |             |                                  |                |    |
|            |                                  |         | Total |             |                                  |                |    |

## Decision of Superiority

| Judge 1 | Judge 2 | Judge 3 | Judge 4 | Judge 5 | Judge 6 | Judge 7 | Referee |
|---------|---------|---------|---------|---------|---------|---------|---------|
|         |         |         |         |         |         |         |         |

Name \_\_\_\_\_  
 Signature \_\_\_\_\_



# Tawastia Open Karate 2/2024

Liivuoentie 24, Hmeenlinna, FINLAND

|            |                                      |         |       |             |                          |                |    |
|------------|--------------------------------------|---------|-------|-------------|--------------------------|----------------|----|
| Court Nr.  | 1                                    | Pool    | 1     | Date        | 2024-10-06               | Field Position | 57 |
| <b>RED</b> |                                      |         |       | <b>BLUE</b> |                          |                |    |
| NOC        | NUHANOVIC AMINA<br>(JKA-TAMPERE,FIN) |         |       | NOC         | ASIALA ERIN (LK-FIN,FIN) |                |    |
| Category   | Kata, tytt, U12                      |         |       |             |                          |                |    |
| 3 Points   | 2 Points                             | 1 Point | Score | 1 Point     | 2 Points                 | 3 Points       |    |
|            |                                      |         | :     |             |                          |                |    |
| Penatlity  |                                      |         |       | Penatlity   |                          |                |    |
|            |                                      |         |       |             |                          |                |    |
|            |                                      |         | Total |             |                          |                |    |

## Decision of Superiority

| Judge 1 | Judge 2 | Judge 3 | Judge 4 | Judge 5 | Judge 6 | Judge 7 | Referee |
|---------|---------|---------|---------|---------|---------|---------|---------|
|         |         |         |         |         |         |         |         |

Name \_\_\_\_\_

Signature \_\_\_\_\_



# Tawastia Open Karate 2/2024

Liivuoentie 24, Hmeenlinna, FINLAND

|            |                      |         |       |             |                                  |                |    |
|------------|----------------------|---------|-------|-------------|----------------------------------|----------------|----|
| Court Nr.  | 1                    | Pool    | 1     | Date        | 2024-10-06                       | Field Position | 58 |
| <b>RED</b> |                      |         |       | <b>BLUE</b> |                                  |                |    |
| NOC        | HEINO LILYA (ER,FIN) |         |       | NOC         | ARUN IISHA (KARATE HERVANTA,FIN) |                |    |
| Category   | Kata, tytt, U12      |         |       |             |                                  |                |    |
| 3 Points   | 2 Points             | 1 Point | Score | 1 Point     | 2 Points                         | 3 Points       |    |
|            |                      |         | :     |             |                                  |                |    |
| Penatlity  |                      |         |       | Penatlity   |                                  |                |    |
|            |                      |         |       |             |                                  |                |    |
|            |                      |         | Total |             |                                  |                |    |

## Decision of Superiority

| Judge 1 | Judge 2 | Judge 3 | Judge 4 | Judge 5 | Judge 6 | Judge 7 | Referee |
|---------|---------|---------|---------|---------|---------|---------|---------|
|         |         |         |         |         |         |         |         |

Name \_\_\_\_\_  
 Signature \_\_\_\_\_



# Tawastia Open Karate 2/2024

Liivuoentie 24, Hmeenlinna, FINLAND

|            |                                |         |       |             |                      |                |    |
|------------|--------------------------------|---------|-------|-------------|----------------------|----------------|----|
| Court Nr.  | 1                              | Pool    | 1     | Date        | 2024-10-06           | Field Position | 59 |
| <b>RED</b> |                                |         |       | <b>BLUE</b> |                      |                |    |
| NOC        | MAKSYMUK POLINA (MAKSYMUK,FIN) |         |       | NOC         | MKEL JENNA (HKS,FIN) |                |    |
| Category   | Kata, tytt, U12                |         |       |             |                      |                |    |
| 3 Points   | 2 Points                       | 1 Point | Score | 1 Point     | 2 Points             | 3 Points       |    |
|            |                                |         | :     |             |                      |                |    |
| Penatlity  |                                |         |       | Penatlity   |                      |                |    |
|            |                                |         |       |             |                      |                |    |
|            |                                |         | Total |             |                      |                |    |

## Decision of Superiority

| Judge 1 | Judge 2 | Judge 3 | Judge 4 | Judge 5 | Judge 6 | Judge 7 | Referee |
|---------|---------|---------|---------|---------|---------|---------|---------|
|         |         |         |         |         |         |         |         |

Name \_\_\_\_\_

Signature \_\_\_\_\_



# Tawastia Open Karate 2/2024

Liivuoentie 24, Hmeenlinna, FINLAND

|            |                         |         |       |             |                                  |                |    |
|------------|-------------------------|---------|-------|-------------|----------------------------------|----------------|----|
| Court Nr.  | 1                       | Pool    | 1     | Date        | 2024-10-06                       | Field Position | 60 |
| <b>RED</b> |                         |         |       | <b>BLUE</b> |                                  |                |    |
| NOC        | NASKALI JATTA (HKS,FIN) |         |       | NOC         | VENERANTA CECILIA (JKA PORI,FIN) |                |    |
| Category   | Kata, tytt, U12         |         |       |             |                                  |                |    |
| 3 Points   | 2 Points                | 1 Point | Score | 1 Point     | 2 Points                         | 3 Points       |    |
|            |                         |         | :     |             |                                  |                |    |
| Penatlity  |                         |         |       | Penatlity   |                                  |                |    |
|            |                         |         |       |             |                                  |                |    |
|            |                         |         | Total |             |                                  |                |    |

## Decision of Superiority

|         |         |         |         |         |         |         |         |
|---------|---------|---------|---------|---------|---------|---------|---------|
| Judge 1 | Judge 2 | Judge 3 | Judge 4 | Judge 5 | Judge 6 | Judge 7 | Referee |
|         |         |         |         |         |         |         |         |

Name

Signature

\_\_\_\_\_

\_\_\_\_\_



# Tawastia Open Karate 2/2024

Liivuoentie 24, Hmeenlinna, FINLAND

|            |                                      |         |       |             |                                     |                |    |
|------------|--------------------------------------|---------|-------|-------------|-------------------------------------|----------------|----|
| Court Nr.  | 1                                    | Pool    | 1     | Date        | 2024-10-06                          | Field Position | 61 |
| <b>RED</b> |                                      |         |       | <b>BLUE</b> |                                     |                |    |
| NOC        | NUHANOVIC AMINA<br>(JKA-TAMPERE,FIN) |         |       | NOC         | ARUN IISHA (KARATE<br>HERVANTA,FIN) |                |    |
| Category   | Kata, tytt, U12                      |         |       |             |                                     |                |    |
| 3 Points   | 2 Points                             | 1 Point | Score | 1 Point     | 2 Points                            | 3 Points       |    |
|            |                                      |         | :     |             |                                     |                |    |
| Penatlity  |                                      |         |       | Penatlity   |                                     |                |    |
|            |                                      |         |       |             |                                     |                |    |
|            |                                      |         | Total |             |                                     |                |    |

## Decision of Superiority

| Judge 1 | Judge 2 | Judge 3 | Judge 4 | Judge 5 | Judge 6 | Judge 7 | Referee |
|---------|---------|---------|---------|---------|---------|---------|---------|
|         |         |         |         |         |         |         |         |

Name \_\_\_\_\_  
Signature \_\_\_\_\_





# Tawastia Open Karate 2/2024

Liivuoentie 24, Hmeenlinna, FINLAND

|            |                                |         |       |             |                                  |                |    |
|------------|--------------------------------|---------|-------|-------------|----------------------------------|----------------|----|
| Court Nr.  | 1                              | Pool    | 1     | Date        | 2024-10-06                       | Field Position | 62 |
| <b>RED</b> |                                |         |       | <b>BLUE</b> |                                  |                |    |
| NOC        | MAKSYMUK POLINA (MAKSYMUK,FIN) |         |       | NOC         | VENERANTA CECILIA (JKA PORI,FIN) |                |    |
| Category   | Kata, tytt, U12                |         |       |             |                                  |                |    |
| 3 Points   | 2 Points                       | 1 Point | Score | 1 Point     | 2 Points                         | 3 Points       |    |
|            |                                |         | :     |             |                                  |                |    |
| Penatlity  |                                |         |       | Penatlity   |                                  |                |    |
|            |                                |         |       |             |                                  |                |    |
|            |                                |         | Total |             |                                  |                |    |

## Decision of Superiority

| Judge 1 | Judge 2 | Judge 3 | Judge 4 | Judge 5 | Judge 6 | Judge 7 | Referee |
|---------|---------|---------|---------|---------|---------|---------|---------|
|         |         |         |         |         |         |         |         |

Name \_\_\_\_\_

Signature \_\_\_\_\_



# Tawastia Open Karate 2/2024

Liivuoentie 24, Hmeenlinna, FINLAND

|            |                                  |         |       |             |                                  |                |    |
|------------|----------------------------------|---------|-------|-------------|----------------------------------|----------------|----|
| Court Nr.  | 1                                | Pool    | 1     | Date        | 2024-10-06                       | Field Position | 63 |
| <b>RED</b> |                                  |         |       | <b>BLUE</b> |                                  |                |    |
| NOC        | ARUN IISHA (KARATE HERVANTA,FIN) |         |       | NOC         | VENERANTA CECILIA (JKA PORI,FIN) |                |    |
| Category   | Kata, tytt, U12                  |         |       |             |                                  |                |    |
| 3 Points   | 2 Points                         | 1 Point | Score | 1 Point     | 2 Points                         | 3 Points       |    |
|            |                                  |         | :     |             |                                  |                |    |
| Penatlity  |                                  |         |       | Penatlity   |                                  |                |    |
|            |                                  |         |       |             |                                  |                |    |
|            |                                  |         | Total |             |                                  |                |    |

## Decision of Superiority

| Judge 1 | Judge 2 | Judge 3 | Judge 4 | Judge 5 | Judge 6 | Judge 7 | Referee |
|---------|---------|---------|---------|---------|---------|---------|---------|
|         |         |         |         |         |         |         |         |

Name \_\_\_\_\_

Signature \_\_\_\_\_



# Tawastia Open Karate 2/2024

Liivuoentie 24, Hmeenlinna, FINLAND

|            |                               |         |       |             |                                   |                |   |
|------------|-------------------------------|---------|-------|-------------|-----------------------------------|----------------|---|
| Court Nr.  | 1                             | Pool    | 1     | Date        | 2024-10-06                        | Field Position | 0 |
| <b>RED</b> |                               |         |       | <b>BLUE</b> |                                   |                |   |
| NOC        | KOSKELA JASMIN (JKA PORI,FIN) |         |       | NOC         | NUHANOVIC AMINA (JKA-TAMPERE,FIN) |                |   |
| Category   | Kata, tytt, U12               |         |       |             |                                   |                |   |
| 3 Points   | 2 Points                      | 1 Point | Score | 1 Point     | 2 Points                          | 3 Points       |   |
|            |                               |         | :     |             |                                   |                |   |
| Penatlity  |                               |         |       | Penatlity   |                                   |                |   |
|            |                               |         |       |             |                                   |                |   |
|            |                               |         | Total |             |                                   |                |   |

## Decision of Superiority

| Judge 1 | Judge 2 | Judge 3 | Judge 4 | Judge 5 | Judge 6 | Judge 7 | Referee |
|---------|---------|---------|---------|---------|---------|---------|---------|
|         |         |         |         |         |         |         |         |

Name \_\_\_\_\_  
 Signature \_\_\_\_\_



# Tawastia Open Karate 2/2024

Liivuoentie 24, Hmeenlinna, FINLAND

|            |                               |         |       |             |                      |                |   |
|------------|-------------------------------|---------|-------|-------------|----------------------|----------------|---|
| Court Nr.  | 1                             | Pool    | 1     | Date        | 2024-10-06           | Field Position | 2 |
| <b>RED</b> |                               |         |       | <b>BLUE</b> |                      |                |   |
| NOC        | KOSKELA JASMIN (JKA PORI,FIN) |         |       | NOC         | HEINO LILYA (ER,FIN) |                |   |
| Category   | Kata, tytt, U12               |         |       |             |                      |                |   |
| 3 Points   | 2 Points                      | 1 Point | Score | 1 Point     | 2 Points             | 3 Points       |   |
|            |                               |         | :     |             |                      |                |   |
| Penatlity  |                               |         |       | Penatlity   |                      |                |   |
|            |                               |         |       |             |                      |                |   |
|            |                               |         | Total |             |                      |                |   |

## Decision of Superiority

|         |         |         |         |         |         |         |         |
|---------|---------|---------|---------|---------|---------|---------|---------|
| Judge 1 | Judge 2 | Judge 3 | Judge 4 | Judge 5 | Judge 6 | Judge 7 | Referee |
|         |         |         |         |         |         |         |         |

Name

Signature

\_\_\_\_\_

\_\_\_\_\_



# Tawastia Open Karate 2/2024

Liivuoentie 24, Hmeenlinna, FINLAND

|            |                                  |         |       |             |                                |                |   |
|------------|----------------------------------|---------|-------|-------------|--------------------------------|----------------|---|
| Court Nr.  | 2                                | Pool    | 2     | Date        | 2024-10-06                     | Field Position | 0 |
| <b>RED</b> |                                  |         |       | <b>BLUE</b> |                                |                |   |
| NOC        | ANBAR HIBA (KARATE HERVANTA,FIN) |         |       | NOC         | MAKSYMUK POLINA (MAKSYMUK,FIN) |                |   |
| Category   | Kata, tytt, U12                  |         |       |             |                                |                |   |
| 3 Points   | 2 Points                         | 1 Point | Score | 1 Point     | 2 Points                       | 3 Points       |   |
|            |                                  |         | :     |             |                                |                |   |
| Penatlity  |                                  |         |       | Penatlity   |                                |                |   |
|            |                                  |         |       |             |                                |                |   |
|            |                                  |         | Total |             |                                |                |   |

## Decision of Superiority

| Judge 1 | Judge 2 | Judge 3 | Judge 4 | Judge 5 | Judge 6 | Judge 7 | Referee |
|---------|---------|---------|---------|---------|---------|---------|---------|
|         |         |         |         |         |         |         |         |

Name \_\_\_\_\_  
 Signature \_\_\_\_\_



# Tawastia Open Karate 2/2024

Liivuoentie 24, Hmeenlinna, FINLAND

|            |                                  |         |       |             |                         |                |   |
|------------|----------------------------------|---------|-------|-------------|-------------------------|----------------|---|
| Court Nr.  | 2                                | Pool    | 2     | Date        | 2024-10-06              | Field Position | 2 |
| <b>RED</b> |                                  |         |       | <b>BLUE</b> |                         |                |   |
| NOC        | ANBAR HIBA (KARATE HERVANTA,FIN) |         |       | NOC         | NASKALI JATTA (HKS,FIN) |                |   |
| Category   | Kata, tytt, U12                  |         |       |             |                         |                |   |
| 3 Points   | 2 Points                         | 1 Point | Score | 1 Point     | 2 Points                | 3 Points       |   |
|            |                                  |         | :     |             |                         |                |   |
| Penatlity  |                                  |         |       | Penatlity   |                         |                |   |
|            |                                  |         |       |             |                         |                |   |
|            |                                  |         | Total |             |                         |                |   |

## Decision of Superiority

|         |         |         |         |         |         |         |         |
|---------|---------|---------|---------|---------|---------|---------|---------|
| Judge 1 | Judge 2 | Judge 3 | Judge 4 | Judge 5 | Judge 6 | Judge 7 | Referee |
|         |         |         |         |         |         |         |         |







Name \_\_\_\_\_

Signature \_\_\_\_\_



## Tawastia Open Karate 2/2024 - 2024-10-05

## Official Results

| Kata, tytöt, U12 |                   |   |   |               |
|------------------|-------------------|---|---|---------------|
| 1                | ARUN IISHA        | SHOTOKAN<br>HERVANTA RY                   |  | FIN - FINLAND |
| 2                | VENERANTA CECILIA | PORIN SHOTOKAN                            |  | FIN - FINLAND |
| 3                | KOSKELA JASMIN    | PORIN SHOTOKAN                            |  | FIN - FINLAND |
| 4                | ANBAR HIBA        | SHOTOKAN<br>HERVANTA RY                   |  | FIN - FINLAND |
| 5                | NUHANOVIC AMINA   | JAPAN KARATE<br>ASSOCIATION<br>TAMPERE RY |  | FIN - FINLAND |
| 5                | MAKSYMUK POLINA   | MAKSYMUK                                  |  | FIN - FINLAND |
| 7                | HEINO LILYA       | TAPANILAN ERÄ                             |  | FIN - FINLAND |
| 7                | NASKALI JATTA     | HÄMEENLINNAN<br>KARATESEURA               |  | FIN - FINLAND |

# KATA, TYTÖT, U14



Tawastia Open Karate 2/2024

**ENTRIES BY WEIGHT CATEGORY**  
**Kata, tytt, U14**

As of 6 OCT 2024

| Country Code | ID | Gender | Name              | Seeding |
|--------------|----|--------|-------------------|---------|
| FIN          |    | F      | Alatalo Vanamo    |         |
| FIN          |    | F      | Antinkaapo Nea    |         |
| FIN          |    | F      | Heino Daisy       |         |
| FIN          |    | F      | Kinnunen Anni     |         |
| FIN          |    | F      | Kontio Venla      |         |
| FIN          |    | F      | Mustonen Amanda   |         |
| FIN          |    | F      | Ortiz Antonia     |         |
| FIN          |    | F      | Pyhnen Iida       |         |
| FIN          |    | F      | Riimala Seela     |         |
| FIN          |    | F      | Salo Aleksandra   |         |
| FIN          |    | F      | Sember Vivi       |         |
| FIN          |    | F      | Stefanski Vanessa |         |

# Kata, tytöt, U14

Tawastia Open Karate 2/2024, Liivourentie 24, Hämeenlinna, FIN

2024-10-05

Tatami  
1 15:25

Pool  
1/1

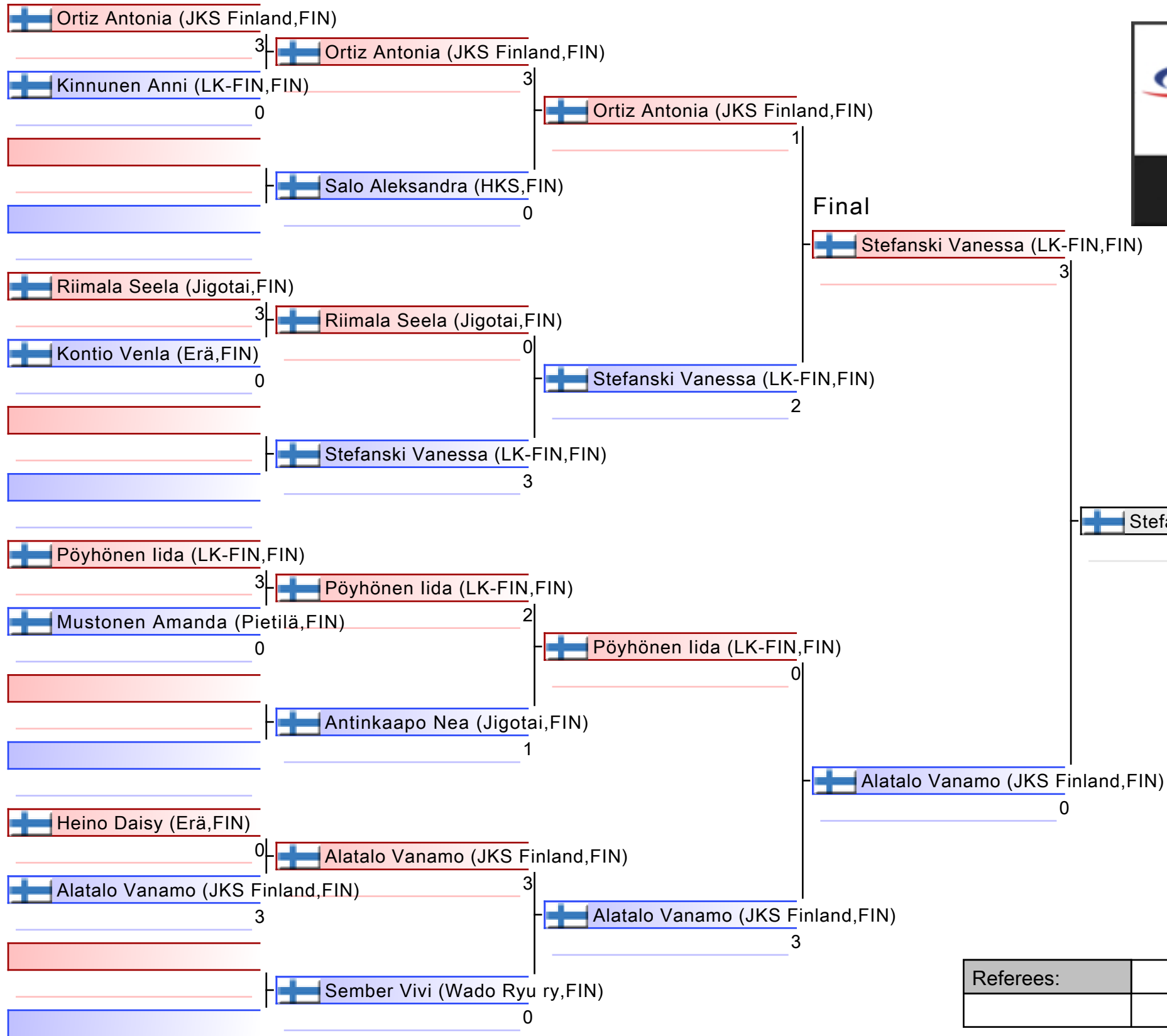

- |                                     |
|-------------------------------------|
| 1. STEFANSKI VANESSA (LK-FIN,FIN)   |
| 2. ALATALO VANAMO (JKS FINLAND,FIN) |
| 3. ORTIZ ANTONIA (JKS FINLAND,FIN)  |
| 4. PÖYHÖNEN IIDA (LK-FIN,FIN)       |
| 5. RIIMALA SEELA (JIGOTAI,FIN)      |
| 5. HEINO DAISY (ERÄ,FIN)            |
| 7. SEMBER VIVI (WADO RYU RY,FIN)    |
|                                     |

|           |  |  |  |
|-----------|--|--|--|
| Referees: |  |  |  |
|           |  |  |  |

# Kata, tytöt, U14

Tawastia Open Karate 2/2024

2024-10-05

Tatami  
1 15:25

Pool  
1

(c)sportdata GmbH & Co KG 2000-2024 (2024-10-06 10:03) v 10.2.0 build 1 (2024-09-26 10:14 CET) License: Online\_Event\_ID-8546\_TawastiaOpenKarate22024 (expire 2024-10-20)

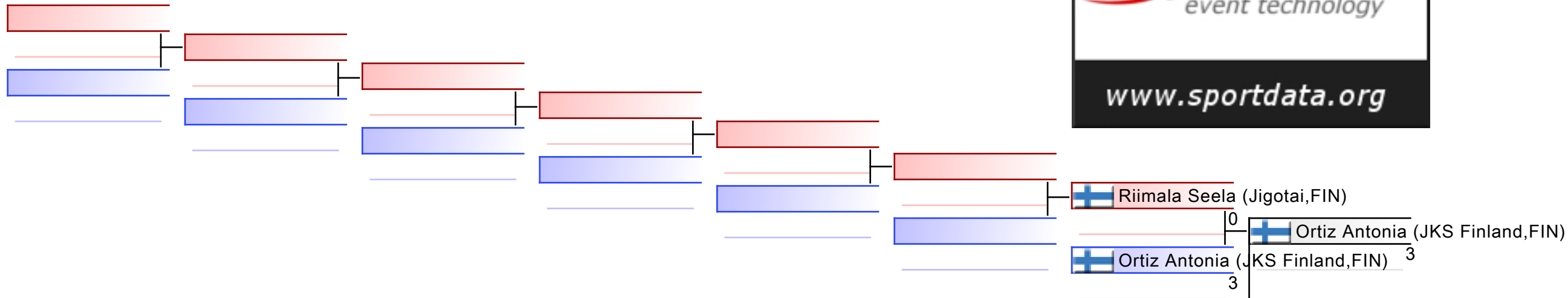

## REPECHAGE: (1)

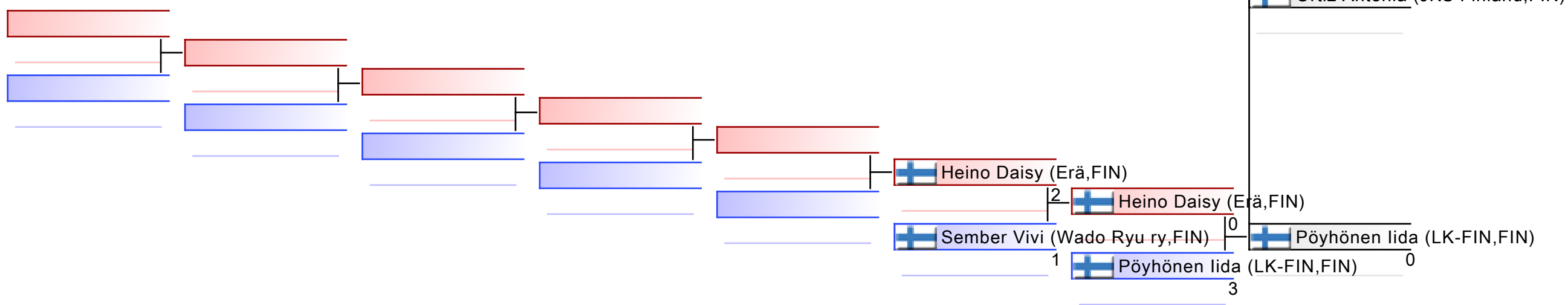

|           |  |  |  |  |  |  |  |
|-----------|--|--|--|--|--|--|--|
| Referees: |  |  |  |  |  |  |  |
|-----------|--|--|--|--|--|--|--|

# Tawastia Open Karate 2/2024

Liivuoentie 24, Hmeenlinna, FINLAND

|            |                                 |         |       |             |                            |                |    |
|------------|---------------------------------|---------|-------|-------------|----------------------------|----------------|----|
| Court Nr.  | 1                               | Pool    | 1     | Date        | 2024-10-06                 | Field Position | 49 |
| <b>RED</b> |                                 |         |       | <b>BLUE</b> |                            |                |    |
| NOC        | ORTIZ ANTONIA (JKS FINLAND,FIN) |         |       | NOC         | KINNUNEN ANNI (LK-FIN,FIN) |                |    |
| Category   | Kata, tytt, U14                 |         |       |             |                            |                |    |
| 3 Points   | 2 Points                        | 1 Point | Score | 1 Point     | 2 Points                   | 3 Points       |    |
|            |                                 |         | :     |             |                            |                |    |
| Penatlity  |                                 |         |       | Penatlity   |                            |                |    |
|            |                                 |         |       |             |                            |                |    |
|            |                                 |         | Total |             |                            |                |    |

## Decision of Superiority

| Judge 1 | Judge 2 | Judge 3 | Judge 4 | Judge 5 | Judge 6 | Judge 7 | Referee |
|---------|---------|---------|---------|---------|---------|---------|---------|
|         |         |         |         |         |         |         |         |

Name \_\_\_\_\_

Signature \_\_\_\_\_



# Tawastia Open Karate 2/2024

Liivuoentie 24, Hmeenlinna, FINLAND

|            |                             |         |       |             |                       |                |    |
|------------|-----------------------------|---------|-------|-------------|-----------------------|----------------|----|
| Court Nr.  | 1                           | Pool    | 1     | Date        | 2024-10-06            | Field Position | 51 |
| <b>RED</b> |                             |         |       | <b>BLUE</b> |                       |                |    |
| NOC        | RIIMALA SEELA (JIGOTAI,FIN) |         |       | NOC         | KONTIO VENLA (ER,FIN) |                |    |
| Category   | Kata, tytt, U14             |         |       |             |                       |                |    |
| 3 Points   | 2 Points                    | 1 Point | Score | 1 Point     | 2 Points              | 3 Points       |    |
|            |                             |         | :     |             |                       |                |    |
| Penatlity  |                             |         |       | Penatlity   |                       |                |    |
|            |                             |         |       |             |                       |                |    |
|            |                             |         | Total |             |                       |                |    |

## Decision of Superiority

| Judge 1 | Judge 2 | Judge 3 | Judge 4 | Judge 5 | Judge 6 | Judge 7 | Referee |
|---------|---------|---------|---------|---------|---------|---------|---------|
|         |         |         |         |         |         |         |         |

Name \_\_\_\_\_  
 Signature \_\_\_\_\_



# Tawastia Open Karate 2/2024

Liivuoentie 24, Hmeenlinna, FINLAND

|            |                          |         |       |             |                              |                |    |
|------------|--------------------------|---------|-------|-------------|------------------------------|----------------|----|
| Court Nr.  | 1                        | Pool    | 1     | Date        | 2024-10-06                   | Field Position | 53 |
| <b>RED</b> |                          |         |       | <b>BLUE</b> |                              |                |    |
| NOC        | PYHNEN IIDA (LK-FIN,FIN) |         |       | NOC         | MUSTONEN AMANDA (PIETIL,FIN) |                |    |
| Category   | Kata, tytt, U14          |         |       |             |                              |                |    |
| 3 Points   | 2 Points                 | 1 Point | Score | 1 Point     | 2 Points                     | 3 Points       |    |
|            |                          |         | :     |             |                              |                |    |
| Penatlity  |                          |         |       | Penatlity   |                              |                |    |
|            |                          |         |       |             |                              |                |    |
|            |                          |         | Total |             |                              |                |    |

## Decision of Superiority

|         |         |         |         |         |         |         |         |
|---------|---------|---------|---------|---------|---------|---------|---------|
| Judge 1 | Judge 2 | Judge 3 | Judge 4 | Judge 5 | Judge 6 | Judge 7 | Referee |
|         |         |         |         |         |         |         |         |

Name \_\_\_\_\_

Signature \_\_\_\_\_



# Tawastia Open Karate 2/2024

Liivuoentie 24, Hmeenlinna, FINLAND

|            |                      |         |       |             |                                     |                |    |
|------------|----------------------|---------|-------|-------------|-------------------------------------|----------------|----|
| Court Nr.  | 1                    | Pool    | 1     | Date        | 2024-10-06                          | Field Position | 55 |
| <b>RED</b> |                      |         |       | <b>BLUE</b> |                                     |                |    |
| NOC        | HEINO DAISY (ER,FIN) |         |       | NOC         | ALATALO VANAMO (JKS<br>FINLAND,FIN) |                |    |
| Category   | Kata, tytt, U14      |         |       |             |                                     |                |    |
| 3 Points   | 2 Points             | 1 Point | Score | 1 Point     | 2 Points                            | 3 Points       |    |
|            |                      |         | :     |             |                                     |                |    |
| Penatlity  |                      |         |       | Penatlity   |                                     |                |    |
|            |                      |         |       |             |                                     |                |    |
|            |                      |         | Total |             |                                     |                |    |

## Decision of Superiority

| Judge 1 | Judge 2 | Judge 3 | Judge 4 | Judge 5 | Judge 6 | Judge 7 | Referee |
|---------|---------|---------|---------|---------|---------|---------|---------|
|         |         |         |         |         |         |         |         |

Name \_\_\_\_\_

Signature \_\_\_\_\_



# Tawastia Open Karate 2/2024

Liivuoentie 24, Hmeenlinna, FINLAND

|            |                                 |         |       |             |                           |                |    |
|------------|---------------------------------|---------|-------|-------------|---------------------------|----------------|----|
| Court Nr.  | 1                               | Pool    | 1     | Date        | 2024-10-06                | Field Position | 57 |
| <b>RED</b> |                                 |         |       | <b>BLUE</b> |                           |                |    |
| NOC        | ORTIZ ANTONIA (JKS FINLAND,FIN) |         |       | NOC         | SALO ALEKSANDRA (HKS,FIN) |                |    |
| Category   | Kata, tytt, U14                 |         |       |             |                           |                |    |
| 3 Points   | 2 Points                        | 1 Point | Score | 1 Point     | 2 Points                  | 3 Points       |    |
|            |                                 |         | :     |             |                           |                |    |
| Penatlity  |                                 |         |       | Penatlity   |                           |                |    |
|            |                                 |         |       |             |                           |                |    |
|            |                                 |         | Total |             |                           |                |    |

## Decision of Superiority

| Judge 1 | Judge 2 | Judge 3 | Judge 4 | Judge 5 | Judge 6 | Judge 7 | Referee |
|---------|---------|---------|---------|---------|---------|---------|---------|
|         |         |         |         |         |         |         |         |

Name \_\_\_\_\_

Signature \_\_\_\_\_





# Tawastia Open Karate 2/2024

Liivuoventie 24, Hmeenlinna, FINLAND

|            |                             |         |       |             |                                |                |    |
|------------|-----------------------------|---------|-------|-------------|--------------------------------|----------------|----|
| Court Nr.  | 1                           | Pool    | 1     | Date        | 2024-10-06                     | Field Position | 58 |
| <b>RED</b> |                             |         |       | <b>BLUE</b> |                                |                |    |
| NOC        | RIIMALA SEELA (JIGOTAI,FIN) |         |       | NOC         | STEFANSKI VANESSA (LK-FIN,FIN) |                |    |
| Category   | Kata, tytt, U14             |         |       |             |                                |                |    |
| 3 Points   | 2 Points                    | 1 Point | Score | 1 Point     | 2 Points                       | 3 Points       |    |
|            |                             |         | :     |             |                                |                |    |
| Penatlity  |                             |         |       | Penatlity   |                                |                |    |
|            |                             |         |       |             |                                |                |    |
|            |                             |         | Total |             |                                |                |    |

## Decision of Superiority

| Judge 1 | Judge 2 | Judge 3 | Judge 4 | Judge 5 | Judge 6 | Judge 7 | Referee |
|---------|---------|---------|---------|---------|---------|---------|---------|
|         |         |         |         |         |         |         |         |

Name \_\_\_\_\_

Signature \_\_\_\_\_



# Tawastia Open Karate 2/2024

Liivuoentie 24, Hmeenlinna, FINLAND

|            |                          |         |       |             |                              |                |    |
|------------|--------------------------|---------|-------|-------------|------------------------------|----------------|----|
| Court Nr.  | 1                        | Pool    | 1     | Date        | 2024-10-06                   | Field Position | 59 |
| <b>RED</b> |                          |         |       | <b>BLUE</b> |                              |                |    |
| NOC        | PYHNEN IIDA (LK-FIN,FIN) |         |       | NOC         | ANTINKAAPO NEA (JIGOTAI,FIN) |                |    |
| Category   | Kata, tytt, U14          |         |       |             |                              |                |    |
| 3 Points   | 2 Points                 | 1 Point | Score | 1 Point     | 2 Points                     | 3 Points       |    |
|            |                          |         | :     |             |                              |                |    |
| Penatlity  |                          |         |       | Penatlity   |                              |                |    |
|            |                          |         |       |             |                              |                |    |
|            |                          |         | Total |             |                              |                |    |

## Decision of Superiority

| Judge 1 | Judge 2 | Judge 3 | Judge 4 | Judge 5 | Judge 6 | Judge 7 | Referee |
|---------|---------|---------|---------|---------|---------|---------|---------|
|         |         |         |         |         |         |         |         |

Name \_\_\_\_\_

Signature \_\_\_\_\_



# Tawastia Open Karate 2/2024

Liivuoentie 24, Hmeenlinna, FINLAND

|            |                                  |         |       |             |                               |                |    |
|------------|----------------------------------|---------|-------|-------------|-------------------------------|----------------|----|
| Court Nr.  | 1                                | Pool    | 1     | Date        | 2024-10-06                    | Field Position | 60 |
| <b>RED</b> |                                  |         |       | <b>BLUE</b> |                               |                |    |
| NOC        | ALATALO VANAMO (JKS FINLAND,FIN) |         |       | NOC         | SEMBER VIVI (WADO RYU RY,FIN) |                |    |
| Category   | Kata, tytt, U14                  |         |       |             |                               |                |    |
| 3 Points   | 2 Points                         | 1 Point | Score | 1 Point     | 2 Points                      | 3 Points       |    |
|            |                                  |         | :     |             |                               |                |    |
| Penatlity  |                                  |         |       | Penatlity   |                               |                |    |
|            |                                  |         |       |             |                               |                |    |
|            |                                  |         | Total |             |                               |                |    |

## Decision of Superiority

| Judge 1 | Judge 2 | Judge 3 | Judge 4 | Judge 5 | Judge 6 | Judge 7 | Referee |
|---------|---------|---------|---------|---------|---------|---------|---------|
|         |         |         |         |         |         |         |         |

Name \_\_\_\_\_

Signature \_\_\_\_\_



# Tawastia Open Karate 2/2024

Liivuoentie 24, Hmeenlinna, FINLAND

|            |                                 |         |       |             |                                |                |    |
|------------|---------------------------------|---------|-------|-------------|--------------------------------|----------------|----|
| Court Nr.  | 1                               | Pool    | 1     | Date        | 2024-10-06                     | Field Position | 61 |
| <b>RED</b> |                                 |         |       | <b>BLUE</b> |                                |                |    |
| NOC        | ORTIZ ANTONIA (JKS FINLAND,FIN) |         |       | NOC         | STEFANSKI VANESSA (LK-FIN,FIN) |                |    |
| Category   | Kata, tytt, U14                 |         |       |             |                                |                |    |
| 3 Points   | 2 Points                        | 1 Point | Score | 1 Point     | 2 Points                       | 3 Points       |    |
|            |                                 |         | :     |             |                                |                |    |
| Penatlity  |                                 |         |       | Penatlity   |                                |                |    |
|            |                                 |         |       |             |                                |                |    |
|            |                                 |         | Total |             |                                |                |    |

## Decision of Superiority

| Judge 1 | Judge 2 | Judge 3 | Judge 4 | Judge 5 | Judge 6 | Judge 7 | Referee |
|---------|---------|---------|---------|---------|---------|---------|---------|
|         |         |         |         |         |         |         |         |

Name \_\_\_\_\_

Signature \_\_\_\_\_



# Tawastia Open Karate 2/2024

Liivuoentie 24, Hmeenlinna, FINLAND

|            |                          |         |       |             |                                  |                |    |
|------------|--------------------------|---------|-------|-------------|----------------------------------|----------------|----|
| Court Nr.  | 1                        | Pool    | 1     | Date        | 2024-10-06                       | Field Position | 62 |
| <b>RED</b> |                          |         |       | <b>BLUE</b> |                                  |                |    |
| NOC        | PYHNEN IIDA (LK-FIN,FIN) |         |       | NOC         | ALATALO VANAMO (JKS FINLAND,FIN) |                |    |
| Category   | Kata, tytt, U14          |         |       |             |                                  |                |    |
| 3 Points   | 2 Points                 | 1 Point | Score | 1 Point     | 2 Points                         | 3 Points       |    |
|            |                          |         | :     |             |                                  |                |    |
| Penatlity  |                          |         |       | Penatlity   |                                  |                |    |
|            |                          |         |       |             |                                  |                |    |
|            |                          |         | Total |             |                                  |                |    |

## Decision of Superiority

|         |         |         |         |         |         |         |         |
|---------|---------|---------|---------|---------|---------|---------|---------|
| Judge 1 | Judge 2 | Judge 3 | Judge 4 | Judge 5 | Judge 6 | Judge 7 | Referee |
|         |         |         |         |         |         |         |         |

Name \_\_\_\_\_

Signature \_\_\_\_\_



# Tawastia Open Karate 2/2024

Liivuoentie 24, Hmeenlinna, FINLAND

|            |                                |         |       |             |                                  |                |    |
|------------|--------------------------------|---------|-------|-------------|----------------------------------|----------------|----|
| Court Nr.  | 1                              | Pool    | 1     | Date        | 2024-10-06                       | Field Position | 63 |
| <b>RED</b> |                                |         |       | <b>BLUE</b> |                                  |                |    |
| NOC        | STEFANSKI VANESSA (LK-FIN,FIN) |         |       | NOC         | ALATALO VANAMO (JKS FINLAND,FIN) |                |    |
| Category   | Kata, tytt, U14                |         |       |             |                                  |                |    |
| 3 Points   | 2 Points                       | 1 Point | Score | 1 Point     | 2 Points                         | 3 Points       |    |
|            |                                |         | :     |             |                                  |                |    |
| Penatlity  |                                |         |       | Penatlity   |                                  |                |    |
|            |                                |         |       |             |                                  |                |    |
|            |                                |         | Total |             |                                  |                |    |

## Decision of Superiority

|         |         |         |         |         |         |         |         |
|---------|---------|---------|---------|---------|---------|---------|---------|
| Judge 1 | Judge 2 | Judge 3 | Judge 4 | Judge 5 | Judge 6 | Judge 7 | Referee |
|         |         |         |         |         |         |         |         |

Name \_\_\_\_\_

Signature \_\_\_\_\_



# Tawastia Open Karate 2/2024

Liivuoentie 24, Hmeenlinna, FINLAND

|            |                             |         |       |             |                                 |                |   |
|------------|-----------------------------|---------|-------|-------------|---------------------------------|----------------|---|
| Court Nr.  | 1                           | Pool    | 1     | Date        | 2024-10-06                      | Field Position | 0 |
| <b>RED</b> |                             |         |       | <b>BLUE</b> |                                 |                |   |
| NOC        | RIIMALA SEELA (JIGOTAI,FIN) |         |       | NOC         | ORTIZ ANTONIA (JKS FINLAND,FIN) |                |   |
| Category   | Kata, tytt, U14             |         |       |             |                                 |                |   |
| 3 Points   | 2 Points                    | 1 Point | Score | 1 Point     | 2 Points                        | 3 Points       |   |
|            |                             |         | :     |             |                                 |                |   |
| Penatlity  |                             |         |       | Penatlity   |                                 |                |   |
|            |                             |         |       |             |                                 |                |   |
|            |                             |         | Total |             |                                 |                |   |

## Decision of Superiority

| Judge 1 | Judge 2 | Judge 3 | Judge 4 | Judge 5 | Judge 6 | Judge 7 | Referee |
|---------|---------|---------|---------|---------|---------|---------|---------|
|         |         |         |         |         |         |         |         |

Name \_\_\_\_\_  
 Signature \_\_\_\_\_



# Tawastia Open Karate 2/2024

Liivuoentie 24, Hmeenlinna, FINLAND

|            |                      |         |       |             |                          |                |   |
|------------|----------------------|---------|-------|-------------|--------------------------|----------------|---|
| Court Nr.  | 2                    | Pool    | 2     | Date        | 2024-10-06               | Field Position | 0 |
| <b>RED</b> |                      |         |       | <b>BLUE</b> |                          |                |   |
| NOC        | HEINO DAISY (ER,FIN) |         |       | NOC         | PYHNEN IIDA (LK-FIN,FIN) |                |   |
| Category   | Kata, tytt, U14      |         |       |             |                          |                |   |
| 3 Points   | 2 Points             | 1 Point | Score | 1 Point     | 2 Points                 | 3 Points       |   |
|            |                      |         | :     |             |                          |                |   |
| Penatlity  |                      |         |       | Penatlity   |                          |                |   |
|            |                      |         |       |             |                          |                |   |
|            |                      |         | Total |             |                          |                |   |

## Decision of Superiority

|         |         |         |         |         |         |         |         |
|---------|---------|---------|---------|---------|---------|---------|---------|
| Judge 1 | Judge 2 | Judge 3 | Judge 4 | Judge 5 | Judge 6 | Judge 7 | Referee |
|         |         |         |         |         |         |         |         |

Name

Signature

\_\_\_\_\_

\_\_\_\_\_





# Tawastia Open Karate 2/2024

Liivuoentie 24, Hmeenlinna, FINLAND

|            |                      |         |       |             |                               |                |   |
|------------|----------------------|---------|-------|-------------|-------------------------------|----------------|---|
| Court Nr.  | 2                    | Pool    | 2     | Date        | 2024-10-06                    | Field Position | 2 |
| <b>RED</b> |                      |         |       | <b>BLUE</b> |                               |                |   |
| NOC        | HEINO DAISY (ER,FIN) |         |       | NOC         | SEMBER VIVI (WADO RYU RY,FIN) |                |   |
| Category   | Kata, tytt, U14      |         |       |             |                               |                |   |
| 3 Points   | 2 Points             | 1 Point | Score | 1 Point     | 2 Points                      | 3 Points       |   |
|            |                      |         | :     |             |                               |                |   |
| Penatlity  |                      |         |       | Penatlity   |                               |                |   |
|            |                      |         |       |             |                               |                |   |
|            |                      |         | Total |             |                               |                |   |

## Decision of Superiority



| Judge 1 | Judge 2 | Judge 3 | Judge 4 | Judge 5 | Judge 6 | Judge 7 | Referee |
|---------|---------|---------|---------|---------|---------|---------|---------|
|         |         |         |         |         |         |         |         |

Name \_\_\_\_\_  
 Signature \_\_\_\_\_



## Tawastia Open Karate 2/2024 - 2024-10-05

## Official Results

| Kata, tytöt, U14 |                   |  |   |               |
|------------------|-------------------|--|---|---------------|
| 1                | STEFANSKI VANESSA | LAHDEN KARATE                                |  | FIN - FINLAND |
| 2                | ALATALO VANAMO    | JKS FINLAND -<br>SHOTOKAN KARATE<br>HELSINKI |  | FIN - FINLAND |
| 3                | ORTIZ ANTONIA     | JKS FINLAND -<br>SHOTOKAN KARATE<br>HELSINKI |  | FIN - FINLAND |
| 4                | PÖYHÖNEN IIDA     | LAHDEN KARATE                                |  | FIN - FINLAND |
| 5                | RIIMALA SEELA     | JIGOTAI KARATE                               |  | FIN - FINLAND |
| 5                | HEINO DAISY       | TAPANILAN ERÄ                                |  | FIN - FINLAND |
| 7                | SEMBER VIVI       | VANTAAN WADO RYU<br>RY                       |  | FIN - FINLAND |

# KATA, TYTÖT, U16

Tawastia Open Karate 2/2024

**ENTRIES BY WEIGHT CATEGORY**

**Kata, tytt, U16**

As of 6 OCT 2024

| Country Code | ID | Gender | Name            | Seeding |
|--------------|----|--------|-----------------|---------|
| FIN          |    | F      | Ahonen Venla    |         |
| FIN          |    | F      | Hannu Alva      |         |
| FIN          |    | F      | Haven Sara      |         |
| FIN          |    | F      | Kallio Sara     |         |
| FIN          |    | F      | Korpela Siiri   |         |
| FIN          |    | F      | Kuusi Nika      |         |
| FIN          |    | F      | Lindstrm Meri   |         |
| FIN          |    | F      | Mustafina Sofia |         |
| FIN          |    | F      | Pietil Hilda    |         |
| FIN          |    | F      | Syrjnen Lily    |         |
| FIN          |    | F      | Tammela Iitu    |         |
| FIN          |    | F      | Temonen Hilma   |         |
| FIN          |    | F      | Wanic Marie     |         |

# Kata, tytöt, U16

Tawastia Open Karate 2/2024, Liivourentie 24, Hämeenlinna, FIN

2024-10-05

Tatami  
2 10:00

Pool  
1/1

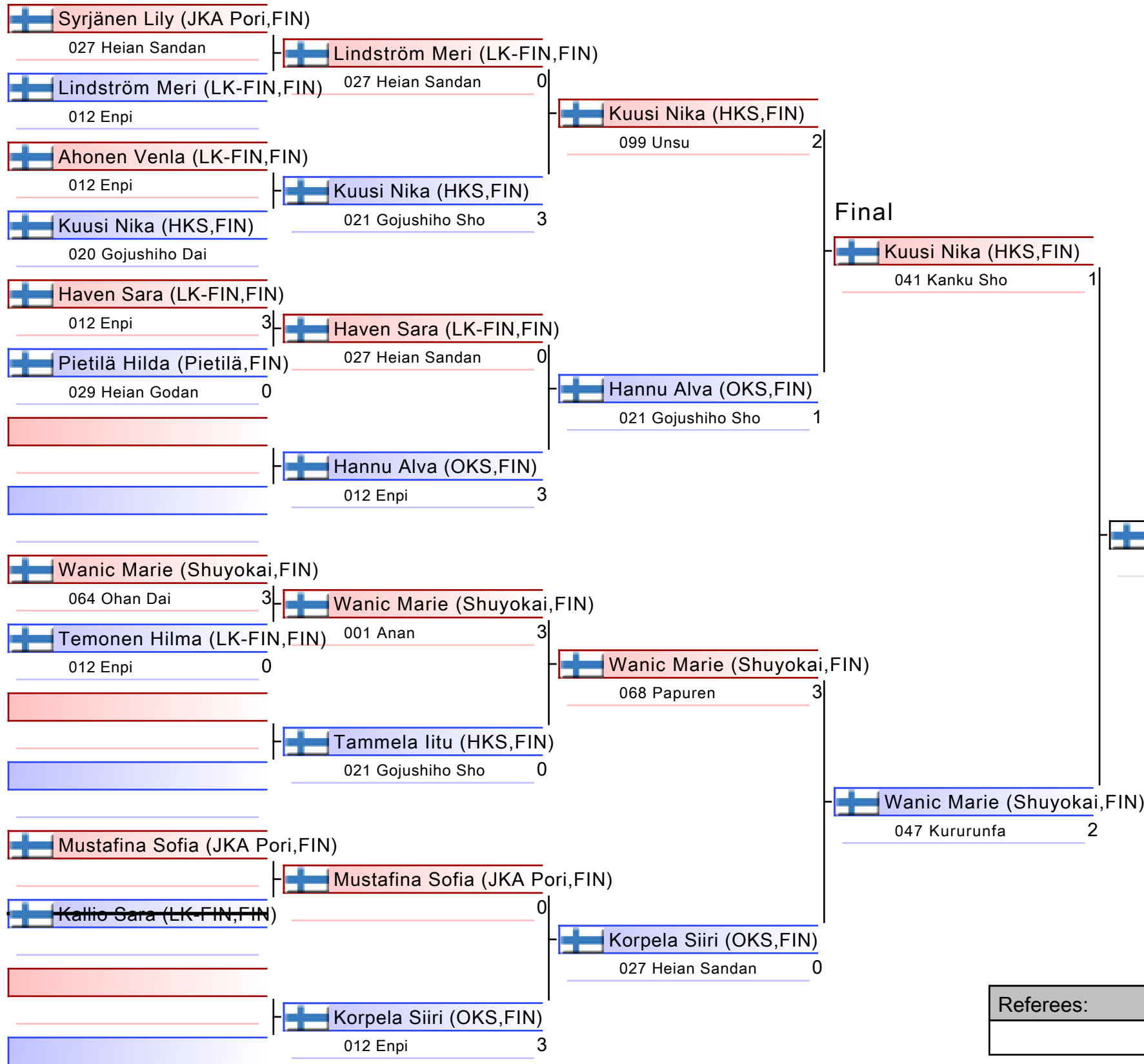

|                                |
|--------------------------------|
| 1. WANIC MARIE (SHUYOKAI,FIN)  |
| 2. KUUSI NIKKA (HKS,FIN)       |
| 3. HANNU ALVA (OKS,FIN)        |
| 4. TEMONEN HILMA (LK-FIN,FIN)  |
| 5. AHONEN VENLA (LK-FIN,FIN)   |
| 5. KORPELA SIIRI (OKS,FIN)     |
| 7. LINDSTRÖM MERI (LK-FIN,FIN) |
| 7. TAMMELA IITU (HKS,FIN)      |

|           |  |  |  |
|-----------|--|--|--|
| Referees: |  |  |  |
|           |  |  |  |

# Kata, tytöt, U16

Tawastia Open Karate 2/2024

2024-10-05

Tatami  
2 10:00

Pool  
1

(c)sportdata GmbH & Co KG 2000-2024 (2024-10-06 10:03) v 10.2.0 build 1 (2024-09-26 10:14 CET) License: Online\_Event\_ID-8546\_TawastiaOpenKarate22024 (expire 2024-10-20)

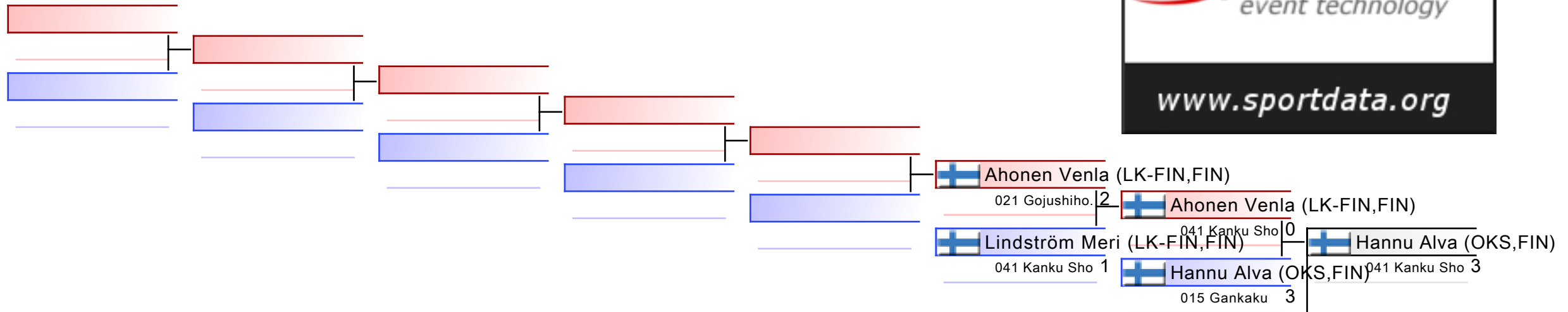

## REPECHAGE: (1)

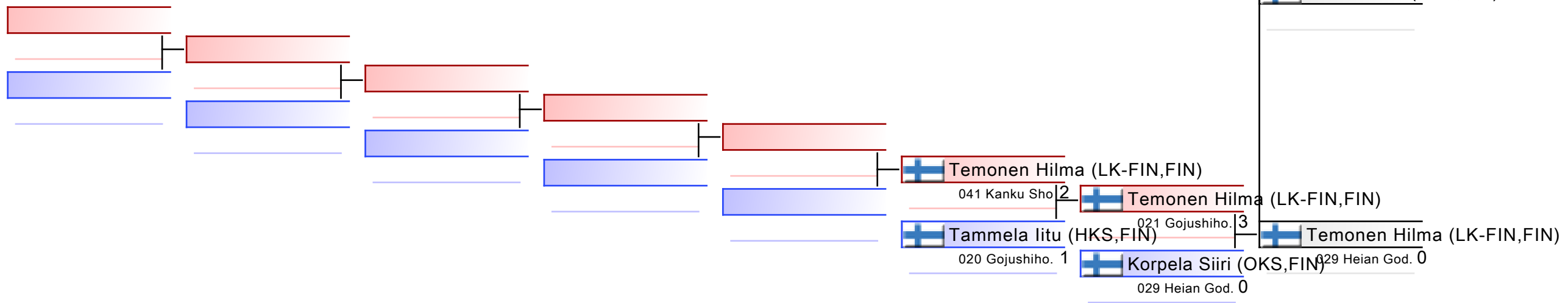

|           |  |  |  |  |  |  |  |
|-----------|--|--|--|--|--|--|--|
| Referees: |  |  |  |  |  |  |  |
|-----------|--|--|--|--|--|--|--|

# Tawastia Open Karate 2/2024

Liivuoentie 24, Hmeenlinna, FINLAND

|            |                             |         |                  |             |                            |                |    |
|------------|-----------------------------|---------|------------------|-------------|----------------------------|----------------|----|
| Court Nr.  | 1                           | Pool    | 1                | Date        | 2024-10-06                 | Field Position | 49 |
| <b>RED</b> |                             |         |                  | <b>BLUE</b> |                            |                |    |
| NOC        | SYRJNEN LILY (JKA PORI,FIN) |         |                  | NOC         | LINDSTRM MERI (LK-FIN,FIN) |                |    |
| Category   | Kata, tytt, U16             |         |                  |             |                            |                |    |
| 3 Points   | 2 Points                    | 1 Point | Score            | 1 Point     | 2 Points                   | 3 Points       |    |
|            |                             |         | 19 : 21          |             |                            |                |    |
| Penatlity  |                             |         |                  | Penatlity   |                            |                |    |
|            |                             |         | <b>19.8:2 ..</b> |             |                            |                |    |
|            |                             |         | Total            | WINNER      |                            |                |    |

POINTS

## Decision of Superiority

| Judge 1 | Judge 2 | Judge 3 | Judge 4 | Judge 5 | Judge 6 | Judge 7 | Referee |
|---------|---------|---------|---------|---------|---------|---------|---------|
|         |         |         |         |         |         |         |         |

Name

Signature

\_\_\_\_\_  
\_\_\_\_\_



# Tawastia Open Karate 2/2024

Liivuoentie 24, Hmeenlinna, FINLAND

|            |                           |         |                  |             |                      |                |    |
|------------|---------------------------|---------|------------------|-------------|----------------------|----------------|----|
| Court Nr.  | 1                         | Pool    | 1                | Date        | 2024-10-06           | Field Position | 50 |
| <b>RED</b> |                           |         |                  | <b>BLUE</b> |                      |                |    |
| NOC        | AHONEN VENLA (LK-FIN,FIN) |         |                  | NOC         | KUUSI NIKA (HKS,FIN) |                |    |
| Category   | Kata, tytt, U16           |         |                  |             |                      |                |    |
| 3 Points   | 2 Points                  | 1 Point | Score            | 1 Point     | 2 Points             | 3 Points       |    |
|            |                           |         | 22 : 23          |             |                      |                |    |
| Penatlity  |                           |         |                  | Penatlity   |                      |                |    |
|            |                           |         | <b>22.0:2 ..</b> |             |                      |                |    |
|            |                           |         | Total            | WINNER      |                      |                |    |

POINTS

## Decision of Superiority

| Judge 1 | Judge 2 | Judge 3 | Judge 4 | Judge 5 | Judge 6 | Judge 7 | Referee |
|---------|---------|---------|---------|---------|---------|---------|---------|
|         |         |         |         |         |         |         |         |

Name

Signature

\_\_\_\_\_  
\_\_\_\_\_





# Tawastia Open Karate 2/2024

Liivuoentie 24, Hmeenlinna, FINLAND

|            |                         |         |       |             |                           |                |    |
|------------|-------------------------|---------|-------|-------------|---------------------------|----------------|----|
| Court Nr.  | 1                       | Pool    | 1     | Date        | 2024-10-06                | Field Position | 51 |
| <b>RED</b> |                         |         |       | <b>BLUE</b> |                           |                |    |
| NOC        | HAVEN SARA (LK-FIN,FIN) |         |       | NOC         | PIETIL HILDA (PIETIL,FIN) |                |    |
| Category   | Kata, tytt, U16         |         |       |             |                           |                |    |
| 3 Points   | 2 Points                | 1 Point | Score | 1 Point     | 2 Points                  | 3 Points       |    |
|            |                         |         | :     |             |                           |                |    |
| Penatlity  |                         |         |       | Penatlity   |                           |                |    |
|            |                         |         |       |             |                           |                |    |
|            |                         |         | Total |             |                           |                |    |

## Decision of Superiority

| Judge 1 | Judge 2 | Judge 3 | Judge 4 | Judge 5 | Judge 6 | Judge 7 | Referee |
|---------|---------|---------|---------|---------|---------|---------|---------|
|         |         |         |         |         |         |         |         |

Name \_\_\_\_\_

Signature \_\_\_\_\_



# Tawastia Open Karate 2/2024

Liivuoentie 24, Hmeenlinna, FINLAND

|            |                            |         |       |             |                            |                |    |
|------------|----------------------------|---------|-------|-------------|----------------------------|----------------|----|
| Court Nr.  | 1                          | Pool    | 1     | Date        | 2024-10-06                 | Field Position | 53 |
| <b>RED</b> |                            |         |       | <b>BLUE</b> |                            |                |    |
| NOC        | WANIC MARIE (SHUYOKAI,FIN) |         |       | NOC         | TEMONEN HILMA (LK-FIN,FIN) |                |    |
| Category   | Kata, tytt, U16            |         |       |             |                            |                |    |
| 3 Points   | 2 Points                   | 1 Point | Score | 1 Point     | 2 Points                   | 3 Points       |    |
|            |                            |         | :     |             |                            |                |    |
| Penatlity  |                            |         |       | Penatlity   |                            |                |    |
|            |                            |         |       |             |                            |                |    |
|            |                            |         | Total |             |                            |                |    |

## Decision of Superiority

| Judge 1 | Judge 2 | Judge 3 | Judge 4 | Judge 5 | Judge 6 | Judge 7 | Referee |
|---------|---------|---------|---------|---------|---------|---------|---------|
|         |         |         |         |         |         |         |         |

Name \_\_\_\_\_

Signature \_\_\_\_\_



# Tawastia Open Karate 2/2024

Liivuoentie 24, Hmeenlinna, FINLAND

|            |                            |         |       |             |                      |                |    |
|------------|----------------------------|---------|-------|-------------|----------------------|----------------|----|
| Court Nr.  | 1                          | Pool    | 1     | Date        | 2024-10-06           | Field Position | 57 |
| <b>RED</b> |                            |         |       | <b>BLUE</b> |                      |                |    |
| NOC        | LINDSTRM MERI (LK-FIN,FIN) |         |       | NOC         | KUUSI NIKA (HKS,FIN) |                |    |
| Category   | Kata, tytt, U16            |         |       |             |                      |                |    |
| 3 Points   | 2 Points                   | 1 Point | Score | 1 Point     | 2 Points             | 3 Points       |    |
|            |                            |         | :     |             |                      |                |    |
| Penatlity  |                            |         |       | Penatlity   |                      |                |    |
|            |                            |         |       |             |                      |                |    |
|            |                            |         | Total |             |                      |                |    |

## Decision of Superiority

| Judge 1 | Judge 2 | Judge 3 | Judge 4 | Judge 5 | Judge 6 | Judge 7 | Referee |
|---------|---------|---------|---------|---------|---------|---------|---------|
|         |         |         |         |         |         |         |         |

Name \_\_\_\_\_

Signature \_\_\_\_\_



# Tawastia Open Karate 2/2024

Liivuoentie 24, Hmeenlinna, FINLAND

|            |                         |         |       |             |                      |                |    |
|------------|-------------------------|---------|-------|-------------|----------------------|----------------|----|
| Court Nr.  | 1                       | Pool    | 1     | Date        | 2024-10-06           | Field Position | 58 |
| <b>RED</b> |                         |         |       | <b>BLUE</b> |                      |                |    |
| NOC        | HAVEN SARA (LK-FIN,FIN) |         |       | NOC         | HANNU ALVA (OKS,FIN) |                |    |
| Category   | Kata, tytt, U16         |         |       |             |                      |                |    |
| 3 Points   | 2 Points                | 1 Point | Score | 1 Point     | 2 Points             | 3 Points       |    |
|            |                         |         | :     |             |                      |                |    |
| Penatlity  |                         |         |       | Penatlity   |                      |                |    |
|            |                         |         |       |             |                      |                |    |
|            |                         |         | Total |             |                      |                |    |

## Decision of Superiority

| Judge 1 | Judge 2 | Judge 3 | Judge 4 | Judge 5 | Judge 6 | Judge 7 | Referee |
|---------|---------|---------|---------|---------|---------|---------|---------|
|         |         |         |         |         |         |         |         |

Name \_\_\_\_\_  
 Signature \_\_\_\_\_



# Tawastia Open Karate 2/2024

Liivuoentie 24, Hmeenlinna, FINLAND

|            |                            |         |       |             |                        |                |    |
|------------|----------------------------|---------|-------|-------------|------------------------|----------------|----|
| Court Nr.  | 1                          | Pool    | 1     | Date        | 2024-10-06             | Field Position | 59 |
| <b>RED</b> |                            |         |       | <b>BLUE</b> |                        |                |    |
| NOC        | WANIC MARIE (SHUYOKAI,FIN) |         |       | NOC         | TAMMELA IITU (HKS,FIN) |                |    |
| Category   | Kata, tytt, U16            |         |       |             |                        |                |    |
| 3 Points   | 2 Points                   | 1 Point | Score | 1 Point     | 2 Points               | 3 Points       |    |
|            |                            |         | :     |             |                        |                |    |
| Penatlity  |                            |         |       | Penatlity   |                        |                |    |
|            |                            |         |       |             |                        |                |    |
|            |                            |         | Total |             |                        |                |    |

## Decision of Superiority

| Judge 1 | Judge 2 | Judge 3 | Judge 4 | Judge 5 | Judge 6 | Judge 7 | Referee |
|---------|---------|---------|---------|---------|---------|---------|---------|
|         |         |         |         |         |         |         |         |

Name \_\_\_\_\_

Signature \_\_\_\_\_



# Tawastia Open Karate 2/2024

Liivuoentie 24, Hmeenlinna, FINLAND

|            |                                |         |       |             |                         |                |    |
|------------|--------------------------------|---------|-------|-------------|-------------------------|----------------|----|
| Court Nr.  | 1                              | Pool    | 1     | Date        | 2024-10-06              | Field Position | 60 |
| <b>RED</b> |                                |         |       | <b>BLUE</b> |                         |                |    |
| NOC        | MUSTAFINA SOFIA (JKA PORI,FIN) |         |       | NOC         | KORPELA SIIRI (OKS,FIN) |                |    |
| Category   | Kata, tytt, U16                |         |       |             |                         |                |    |
| 3 Points   | 2 Points                       | 1 Point | Score | 1 Point     | 2 Points                | 3 Points       |    |
|            |                                |         | :     |             |                         |                |    |
| Penatlity  |                                |         |       | Penatlity   |                         |                |    |
|            |                                |         |       |             |                         |                |    |
|            |                                |         | Total |             |                         |                |    |

## Decision of Superiority

| Judge 1 | Judge 2 | Judge 3 | Judge 4 | Judge 5 | Judge 6 | Judge 7 | Referee |
|---------|---------|---------|---------|---------|---------|---------|---------|
|         |         |         |         |         |         |         |         |

Name \_\_\_\_\_

Signature \_\_\_\_\_



# Tawastia Open Karate 2/2024

Liivuoentie 24, Hmeenlinna, FINLAND

|            |                      |         |       |             |                      |                |    |
|------------|----------------------|---------|-------|-------------|----------------------|----------------|----|
| Court Nr.  | 1                    | Pool    | 1     | Date        | 2024-10-06           | Field Position | 61 |
| <b>RED</b> |                      |         |       | <b>BLUE</b> |                      |                |    |
| NOC        | KUUSI NIKA (HKS,FIN) |         |       | NOC         | HANNU ALVA (OKS,FIN) |                |    |
| Category   | Kata, tytt, U16      |         |       |             |                      |                |    |
| 3 Points   | 2 Points             | 1 Point | Score | 1 Point     | 2 Points             | 3 Points       |    |
|            |                      |         | :     |             |                      |                |    |
| Penatlity  |                      |         |       | Penatlity   |                      |                |    |
|            |                      |         |       |             |                      |                |    |
|            |                      |         | Total |             |                      |                |    |

## Decision of Superiority

| Judge 1 | Judge 2 | Judge 3 | Judge 4 | Judge 5 | Judge 6 | Judge 7 | Referee |
|---------|---------|---------|---------|---------|---------|---------|---------|
|         |         |         |         |         |         |         |         |

Name \_\_\_\_\_

Signature \_\_\_\_\_



# Tawastia Open Karate 2/2024

Liivuoentie 24, Hmeenlinna, FINLAND

|            |                            |         |       |             |                         |                |    |
|------------|----------------------------|---------|-------|-------------|-------------------------|----------------|----|
| Court Nr.  | 1                          | Pool    | 1     | Date        | 2024-10-06              | Field Position | 62 |
| <b>RED</b> |                            |         |       | <b>BLUE</b> |                         |                |    |
| NOC        | WANIC MARIE (SHUYOKAI,FIN) |         |       | NOC         | KORPELA SIIRI (OKS,FIN) |                |    |
| Category   | Kata, tytt, U16            |         |       |             |                         |                |    |
| 3 Points   | 2 Points                   | 1 Point | Score | 1 Point     | 2 Points                | 3 Points       |    |
|            |                            |         | :     |             |                         |                |    |
| Penatlity  |                            |         |       | Penatlity   |                         |                |    |
|            |                            |         |       |             |                         |                |    |
|            |                            |         | Total |             |                         |                |    |

## Decision of Superiority

|         |         |         |         |         |         |         |         |
|---------|---------|---------|---------|---------|---------|---------|---------|
| Judge 1 | Judge 2 | Judge 3 | Judge 4 | Judge 5 | Judge 6 | Judge 7 | Referee |
|         |         |         |         |         |         |         |         |

Name

Signature

\_\_\_\_\_

\_\_\_\_\_





# Tawastia Open Karate 2/2024

Liivuoentie 24, Hmeenlinna, FINLAND

|            |                      |         |       |             |                            |                |    |
|------------|----------------------|---------|-------|-------------|----------------------------|----------------|----|
| Court Nr.  | 1                    | Pool    | 1     | Date        | 2024-10-06                 | Field Position | 63 |
| <b>RED</b> |                      |         |       | <b>BLUE</b> |                            |                |    |
| NOC        | KUUSI NIKA (HKS,FIN) |         |       | NOC         | WANIC MARIE (SHUYOKAI,FIN) |                |    |
| Category   | Kata, tytt, U16      |         |       |             |                            |                |    |
| 3 Points   | 2 Points             | 1 Point | Score | 1 Point     | 2 Points                   | 3 Points       |    |
|            |                      |         | :     |             |                            |                |    |
| Penatlity  |                      |         |       | Penatlity   |                            |                |    |
|            |                      |         |       |             |                            |                |    |
|            |                      |         | Total |             |                            |                |    |

## Decision of Superiority

| Judge 1 | Judge 2 | Judge 3 | Judge 4 | Judge 5 | Judge 6 | Judge 7 | Referee |
|---------|---------|---------|---------|---------|---------|---------|---------|
|         |         |         |         |         |         |         |         |

Name \_\_\_\_\_  
 Signature \_\_\_\_\_



# Tawastia Open Karate 2/2024

Liivuoentie 24, Hmeenlinna, FINLAND

|            |                           |         |       |             |                      |                |   |
|------------|---------------------------|---------|-------|-------------|----------------------|----------------|---|
| Court Nr.  | 1                         | Pool    | 1     | Date        | 2024-10-06           | Field Position | 0 |
| <b>RED</b> |                           |         |       | <b>BLUE</b> |                      |                |   |
| NOC        | AHONEN VENLA (LK-FIN,FIN) |         |       | NOC         | HANNU ALVA (OKS,FIN) |                |   |
| Category   | Kata, tytt, U16           |         |       |             |                      |                |   |
| 3 Points   | 2 Points                  | 1 Point | Score | 1 Point     | 2 Points             | 3 Points       |   |
|            |                           |         | :     |             |                      |                |   |
| Penatlity  |                           |         |       | Penatlity   |                      |                |   |
|            |                           |         |       |             |                      |                |   |
|            |                           |         | Total |             |                      |                |   |

## Decision of Superiority

| Judge 1 | Judge 2 | Judge 3 | Judge 4 | Judge 5 | Judge 6 | Judge 7 | Referee |
|---------|---------|---------|---------|---------|---------|---------|---------|
|         |         |         |         |         |         |         |         |

Name \_\_\_\_\_  
 Signature \_\_\_\_\_



# Tawastia Open Karate 2/2024

Liivuoentie 24, Hmeenlinna, FINLAND

|            |                           |         |       |             |                            |                |   |
|------------|---------------------------|---------|-------|-------------|----------------------------|----------------|---|
| Court Nr.  | 1                         | Pool    | 1     | Date        | 2024-10-06                 | Field Position | 2 |
| <b>RED</b> |                           |         |       | <b>BLUE</b> |                            |                |   |
| NOC        | AHONEN VENLA (LK-FIN,FIN) |         |       | NOC         | LINDSTRM MERI (LK-FIN,FIN) |                |   |
| Category   | Kata, tytt, U16           |         |       |             |                            |                |   |
| 3 Points   | 2 Points                  | 1 Point | Score | 1 Point     | 2 Points                   | 3 Points       |   |
|            |                           |         | :     |             |                            |                |   |
| Penatlity  |                           |         |       | Penatlity   |                            |                |   |
|            |                           |         |       |             |                            |                |   |
|            |                           |         | Total |             |                            |                |   |

## Decision of Superiority

| Judge 1 | Judge 2 | Judge 3 | Judge 4 | Judge 5 | Judge 6 | Judge 7 | Referee |
|---------|---------|---------|---------|---------|---------|---------|---------|
|         |         |         |         |         |         |         |         |

Name \_\_\_\_\_

Signature \_\_\_\_\_



# Tawastia Open Karate 2/2024

Liivuoentie 24, Hmeenlinna, FINLAND

|            |                            |         |       |             |                         |                |   |
|------------|----------------------------|---------|-------|-------------|-------------------------|----------------|---|
| Court Nr.  | 2                          | Pool    | 2     | Date        | 2024-10-06              | Field Position | 0 |
| <b>RED</b> |                            |         |       | <b>BLUE</b> |                         |                |   |
| NOC        | TEMONEN HILMA (LK-FIN,FIN) |         |       | NOC         | KORPELA SIIRI (OKS,FIN) |                |   |
| Category   | Kata, tytt, U16            |         |       |             |                         |                |   |
| 3 Points   | 2 Points                   | 1 Point | Score | 1 Point     | 2 Points                | 3 Points       |   |
|            |                            |         | :     |             |                         |                |   |
| Penatlity  |                            |         |       | Penatlity   |                         |                |   |
|            |                            |         |       |             |                         |                |   |
|            |                            |         | Total |             |                         |                |   |

## Decision of Superiority

| Judge 1 | Judge 2 | Judge 3 | Judge 4 | Judge 5 | Judge 6 | Judge 7 | Referee |
|---------|---------|---------|---------|---------|---------|---------|---------|
|         |         |         |         |         |         |         |         |

Name \_\_\_\_\_

Signature \_\_\_\_\_



# Tawastia Open Karate 2/2024

Liivuoventie 24, Hmeenlinna, FINLAND

|            |                            |         |       |             |                        |                |   |
|------------|----------------------------|---------|-------|-------------|------------------------|----------------|---|
| Court Nr.  | 2                          | Pool    | 2     | Date        | 2024-10-06             | Field Position | 2 |
| <b>RED</b> |                            |         |       | <b>BLUE</b> |                        |                |   |
| NOC        | TEMONEN HILMA (LK-FIN,FIN) |         |       | NOC         | TAMMELA IITU (HKS,FIN) |                |   |
| Category   | Kata, tytt, U16            |         |       |             |                        |                |   |
| 3 Points   | 2 Points                   | 1 Point | Score | 1 Point     | 2 Points               | 3 Points       |   |
|            |                            |         | :     |             |                        |                |   |
| Penatlity  |                            |         |       | Penatlity   |                        |                |   |
|            |                            |         |       |             |                        |                |   |
|            |                            |         | Total |             |                        |                |   |

## Decision of Superiority

| Judge 1 | Judge 2 | Judge 3 | Judge 4 | Judge 5 | Judge 6 | Judge 7 | Referee |
|---------|---------|---------|---------|---------|---------|---------|---------|
|         |         |         |         |         |         |         |         |

Name \_\_\_\_\_

Signature \_\_\_\_\_



## Tawastia Open Karate 2/2024 - 2024-10-05

## Official Results

| Kata, tytöt, U16 |                |                                    |   |               |  |
|------------------|----------------|------------------------------------|---|---------------|--|
| 1                | WANIC MARIE    | SHUYOKAI<br>SHOTOKAN KARATE-<br>DO |  | FIN - FINLAND |  |
| 2                | KUUSI NIKA     | HAMEENLINNAN<br>KARATESEURA        |  | FIN - FINLAND |  |
| 3                | HANNU ALVA     | OULUN<br>KARATESEURA               |  | FIN - FINLAND |  |
| 4                | TEMONEN HILMA  | LAHDEN KARATE                      |  | FIN - FINLAND |  |
| 5                | AHONEN VENLA   | LAHDEN KARATE                      |  | FIN - FINLAND |  |
| 5                | KORPELA SIIRI  | OULUN<br>KARATESEURA               |  | FIN - FINLAND |  |
| 7                | LINDSTRÖM MERI | LAHDEN KARATE                      |  | FIN - FINLAND |  |
| 7                | TAMMELA IITU   | HAMEENLINNAN<br>KARATESEURA        |  | FIN - FINLAND |  |

# KATA, TYTÖT, U18

Tawastia Open Karate 2/2024

**ENTRIES BY WEIGHT CATEGORY**

**Kata, tytt, U18**

As of 6 OCT 2024

| Country Code | ID | Gender | Name            | Seeding |
|--------------|----|--------|-----------------|---------|
| FIN          |    | F      | Alatalo Onerva  |         |
| FIN          |    | F      | Hannu Alva      |         |
| FIN          |    | F      | Kuusi Nika      |         |
| FIN          |    | F      | Meyke Alexandra |         |
| FIN          |    | F      | Tammela litu    |         |



# Kata, tytöt, U18

Tawastia Open Karate 2/2024, Liivourentie 24, Hämeenlinna, FIN

2024-10-05

Tatami  
2 10:55

Pool  
1/1

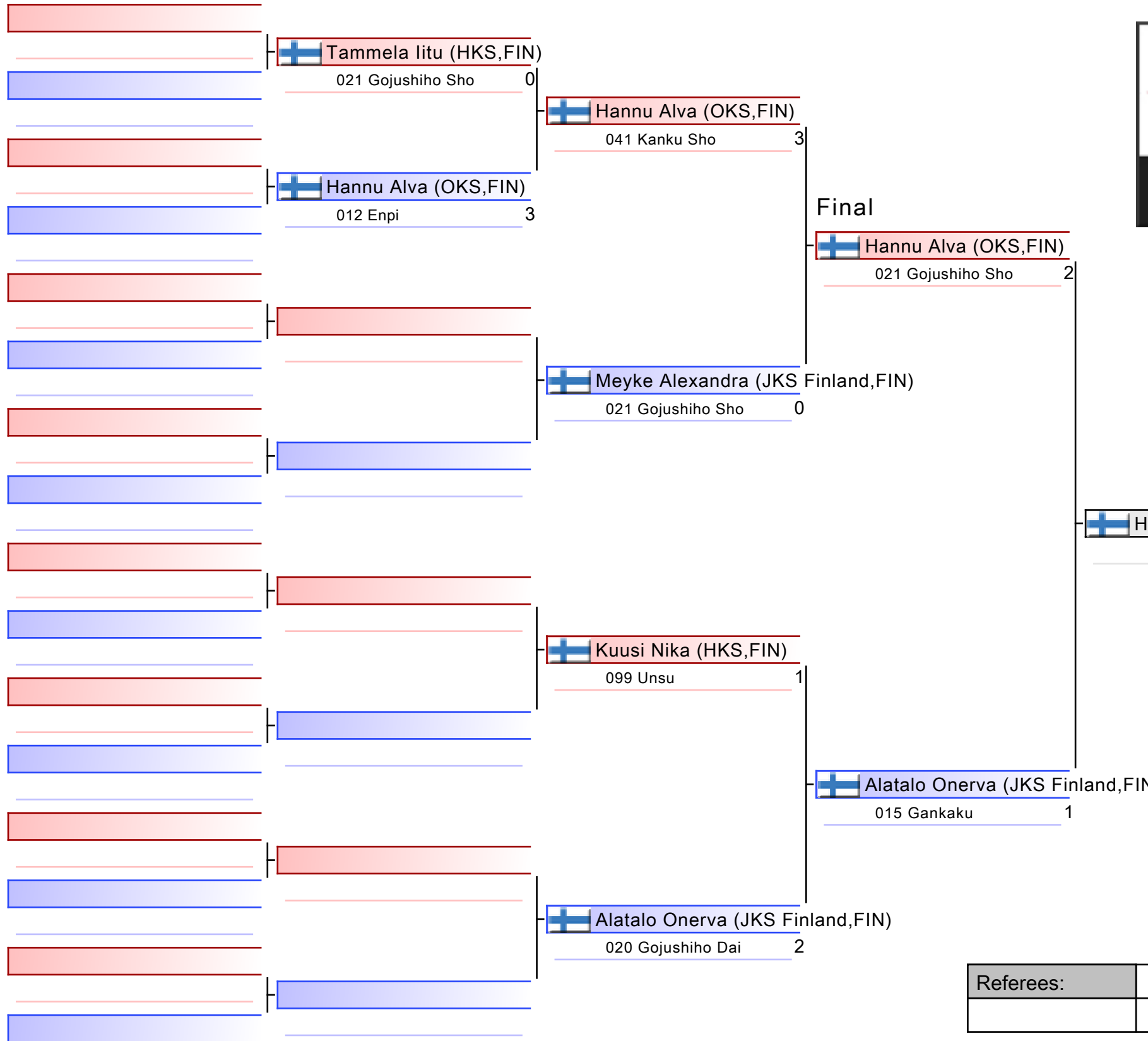

Hannu Alva (OKS,FIN)

|                                      |
|--------------------------------------|
| 1. HANNU ALVA (OKS,FIN)              |
| 2. ALATALO ONERVA (JKS FINLAND,FIN)  |
| 3. KUUSI NIKA (HKS,FIN)              |
| 4. MEYKE ALEXANDRA (JKS FINLAND,FIN) |
| 5. TAMMELA IITU (HKS,FIN)            |
|                                      |
|                                      |

|           |  |  |  |
|-----------|--|--|--|
| Referees: |  |  |  |
|           |  |  |  |

# Kata, tytöt, U18

Tawastia Open Karate 2/2024

2024-10-05

Tatami

2 10:55

Pool

1

(c)sportdata GmbH & Co KG 2000-2024 (2024-10-06 10:03) v 10.2.0 build 1 (2024-09-26 10:14 CET) License: Online\_Event\_ID-8546\_TawastiaOpenKarate2024 (expire 2024-10-20)

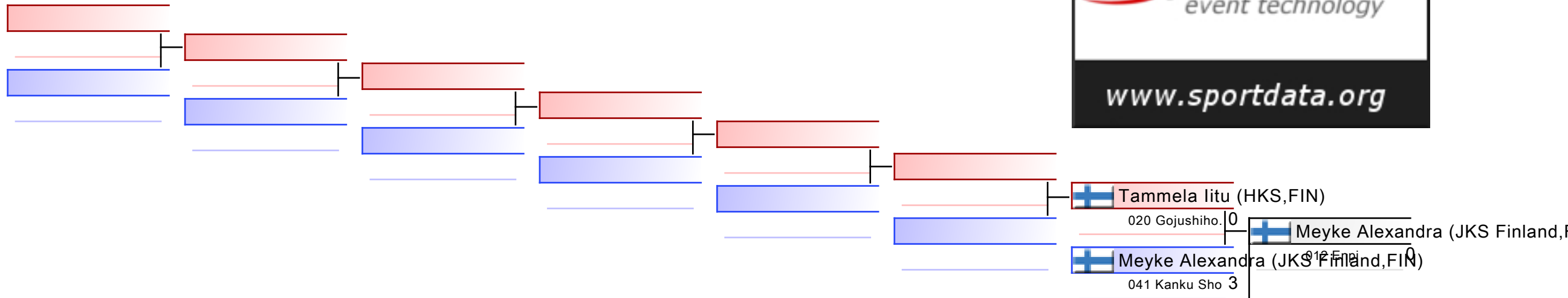

## REPECHAGE: (1)

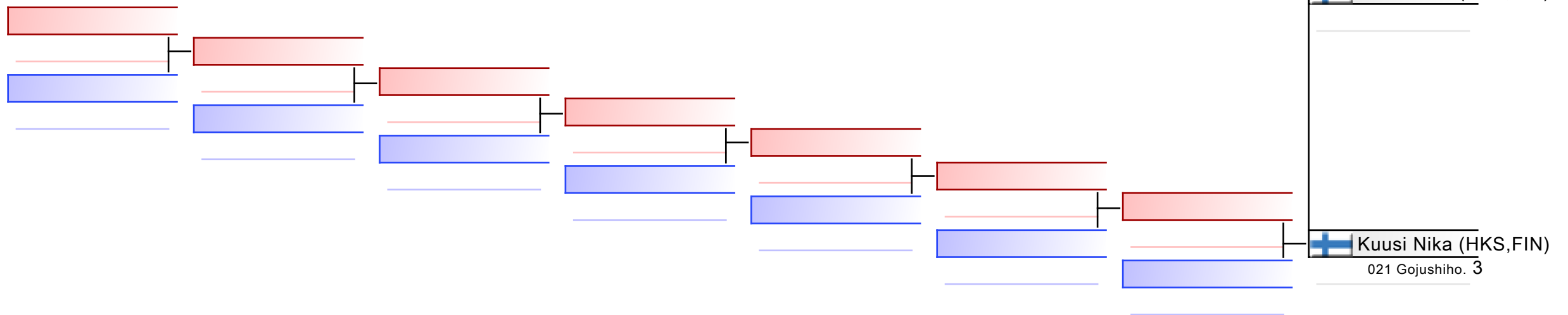

|           |  |  |  |  |  |  |  |
|-----------|--|--|--|--|--|--|--|
| Referees: |  |  |  |  |  |  |  |
|-----------|--|--|--|--|--|--|--|

# Tawastia Open Karate 2/2024

Liivuoentie 24, Hmeenlinna, FINLAND

|            |                        |         |       |             |                      |                |    |
|------------|------------------------|---------|-------|-------------|----------------------|----------------|----|
| Court Nr.  | 1                      | Pool    | 1     | Date        | 2024-10-06           | Field Position | 57 |
| <b>RED</b> |                        |         |       | <b>BLUE</b> |                      |                |    |
| NOC        | TAMMELA IITU (HKS,FIN) |         |       | NOC         | HANNU ALVA (OKS,FIN) |                |    |
| Category   | Kata, tytt, U18        |         |       |             |                      |                |    |
| 3 Points   | 2 Points               | 1 Point | Score | 1 Point     | 2 Points             | 3 Points       |    |
|            |                        |         | :     |             |                      |                |    |
| Penatlity  |                        |         |       | Penatlity   |                      |                |    |
|            |                        |         |       |             |                      |                |    |
|            |                        |         | Total |             |                      |                |    |

## Decision of Superiority

|         |         |         |         |         |         |         |         |
|---------|---------|---------|---------|---------|---------|---------|---------|
| Judge 1 | Judge 2 | Judge 3 | Judge 4 | Judge 5 | Judge 6 | Judge 7 | Referee |
|         |         |         |         |         |         |         |         |

Name

Signature

\_\_\_\_\_

\_\_\_\_\_



# Tawastia Open Karate 2/2024

Liivuoentie 24, Hmeenlinna, FINLAND

|            |                      |         |       |             |                                   |                |    |
|------------|----------------------|---------|-------|-------------|-----------------------------------|----------------|----|
| Court Nr.  | 1                    | Pool    | 1     | Date        | 2024-10-06                        | Field Position | 61 |
| <b>RED</b> |                      |         |       | <b>BLUE</b> |                                   |                |    |
| NOC        | HANNU ALVA (OKS,FIN) |         |       | NOC         | MEYKE ALEXANDRA (JKS FINLAND,FIN) |                |    |
| Category   | Kata, tytt, U18      |         |       |             |                                   |                |    |
| 3 Points   | 2 Points             | 1 Point | Score | 1 Point     | 2 Points                          | 3 Points       |    |
|            |                      |         | :     |             |                                   |                |    |
| Penatlity  |                      |         |       | Penatlity   |                                   |                |    |
|            |                      |         |       |             |                                   |                |    |
|            |                      |         | Total |             |                                   |                |    |

## Decision of Superiority

| Judge 1 | Judge 2 | Judge 3 | Judge 4 | Judge 5 | Judge 6 | Judge 7 | Referee |
|---------|---------|---------|---------|---------|---------|---------|---------|
|         |         |         |         |         |         |         |         |

Name \_\_\_\_\_

Signature \_\_\_\_\_



# Tawastia Open Karate 2/2024

Liivuoentie 24, Hmeenlinna, FINLAND

|            |                      |         |       |             |                                     |                |    |
|------------|----------------------|---------|-------|-------------|-------------------------------------|----------------|----|
| Court Nr.  | 1                    | Pool    | 1     | Date        | 2024-10-06                          | Field Position | 62 |
| <b>RED</b> |                      |         |       | <b>BLUE</b> |                                     |                |    |
| NOC        | KUUSI NIKA (HKS,FIN) |         |       | NOC         | ALATALO ONERVA (JKS<br>FINLAND,FIN) |                |    |
| Category   | Kata, tytt, U18      |         |       |             |                                     |                |    |
| 3 Points   | 2 Points             | 1 Point | Score | 1 Point     | 2 Points                            | 3 Points       |    |
|            |                      |         | :     |             |                                     |                |    |
| Penatlity  |                      |         |       | Penatlity   |                                     |                |    |
|            |                      |         |       |             |                                     |                |    |
|            |                      |         | Total |             |                                     |                |    |

## Decision of Superiority

| Judge 1 | Judge 2 | Judge 3 | Judge 4 | Judge 5 | Judge 6 | Judge 7 | Referee |
|---------|---------|---------|---------|---------|---------|---------|---------|
|         |         |         |         |         |         |         |         |

Name \_\_\_\_\_

Signature \_\_\_\_\_



# Tawastia Open Karate 2/2024

Liivuoentie 24, Hmeenlinna, FINLAND

|            |                      |         |       |             |                                     |                |    |
|------------|----------------------|---------|-------|-------------|-------------------------------------|----------------|----|
| Court Nr.  | 1                    | Pool    | 1     | Date        | 2024-10-06                          | Field Position | 63 |
| <b>RED</b> |                      |         |       | <b>BLUE</b> |                                     |                |    |
| NOC        | HANNU ALVA (OKS,FIN) |         |       | NOC         | ALATALO ONERVA (JKS<br>FINLAND,FIN) |                |    |
| Category   | Kata, tytt, U18      |         |       |             |                                     |                |    |
| 3 Points   | 2 Points             | 1 Point | Score | 1 Point     | 2 Points                            | 3 Points       |    |
|            |                      |         | :     |             |                                     |                |    |
| Penatlity  |                      |         |       | Penatlity   |                                     |                |    |
|            |                      |         |       |             |                                     |                |    |
|            |                      |         | Total |             |                                     |                |    |

## Decision of Superiority

|         |         |         |         |         |         |         |         |
|---------|---------|---------|---------|---------|---------|---------|---------|
| Judge 1 | Judge 2 | Judge 3 | Judge 4 | Judge 5 | Judge 6 | Judge 7 | Referee |
|         |         |         |         |         |         |         |         |

Name

Signature

\_\_\_\_\_

\_\_\_\_\_



# Tawastia Open Karate 2/2024

Liivuoentie 24, Hmeenlinna, FINLAND

|            |                        |         |       |             |                                   |                |   |
|------------|------------------------|---------|-------|-------------|-----------------------------------|----------------|---|
| Court Nr.  | 1                      | Pool    | 1     | Date        | 2024-10-06                        | Field Position | 0 |
| <b>RED</b> |                        |         |       | <b>BLUE</b> |                                   |                |   |
| NOC        | TAMMELA IITU (HKS,FIN) |         |       | NOC         | MEYKE ALEXANDRA (JKS FINLAND,FIN) |                |   |
| Category   | Kata, tytt, U18        |         |       |             |                                   |                |   |
| 3 Points   | 2 Points               | 1 Point | Score | 1 Point     | 2 Points                          | 3 Points       |   |
|            |                        |         | :     |             |                                   |                |   |
| Penatlity  |                        |         |       | Penatlity   |                                   |                |   |
|            |                        |         |       |             |                                   |                |   |
|            |                        |         | Total |             |                                   |                |   |

## Decision of Superiority

|         |         |         |         |         |         |         |         |
|---------|---------|---------|---------|---------|---------|---------|---------|
| Judge 1 | Judge 2 | Judge 3 | Judge 4 | Judge 5 | Judge 6 | Judge 7 | Referee |
|         |         |         |         |         |         |         |         |

Name

Signature





\_\_\_\_\_

\_\_\_\_\_



## Tawastia Open Karate 2/2024 - 2024-10-05

## Official Results

| Kata, tytöt, U18 |                 |  |   |               |  |
|------------------|-----------------|--|---|---------------|--|
| 1                | HANNU ALVA      | OULUN<br>KARATESEURA                         |  | FIN - FINLAND |  |
| 2                | ALATALO ONERVA  | JKS FINLAND -<br>SHOTOKAN KARATE<br>HELSINKI |  | FIN - FINLAND |  |
| 3                | KUUSI NIKA      | HÄMEENLINNAN<br>KARATESEURA                  |  | FIN - FINLAND |  |
| 4                | MEYKE ALEXANDRA | JKS FINLAND -<br>SHOTOKAN KARATE<br>HELSINKI |  | FIN - FINLAND |  |
| 5                | TAMMELA IITU    | HÄMEENLINNAN<br>KARATESEURA                  |  | FIN - FINLAND |  |



KATA, TYTÖT, KELTAISET, U10  
YHDISTETTY

Tawastia Open Karate 2/2024

**ENTRIES BY WEIGHT CATEGORY**  
**Kata, tytt, keltaiset, U10 yhdistetty**

As of 6 OCT 2024

| Country Code | ID | Gender | Name            | Seeding |
|--------------|----|--------|-----------------|---------|
| FIN          |    | F      | Abdelmoaty Sara |         |
| FIN          |    | F      | Bhogadi Sreshta |         |
| FIN          |    | F      | Chudina Alisa   |         |
| FIN          |    | F      | Elpi Amelia     |         |
| FIN          |    | F      | Hakala Helena   |         |
| FIN          |    | F      | Hakala Heli     |         |
| FIN          |    | F      | Haven Eevi      |         |
| FIN          |    | F      | Keskimki Fanni  |         |
| FIN          |    | F      | Lhetkangas Emma |         |

# Kata, tytöt, keltaiset, U10 yhdistetty

Tawastia Open Karate 2/2024, Liivuoventie 24, Hämeenlinna, FIN

2024-10-05

Tatami  
1 10:25

Pool  
1/1

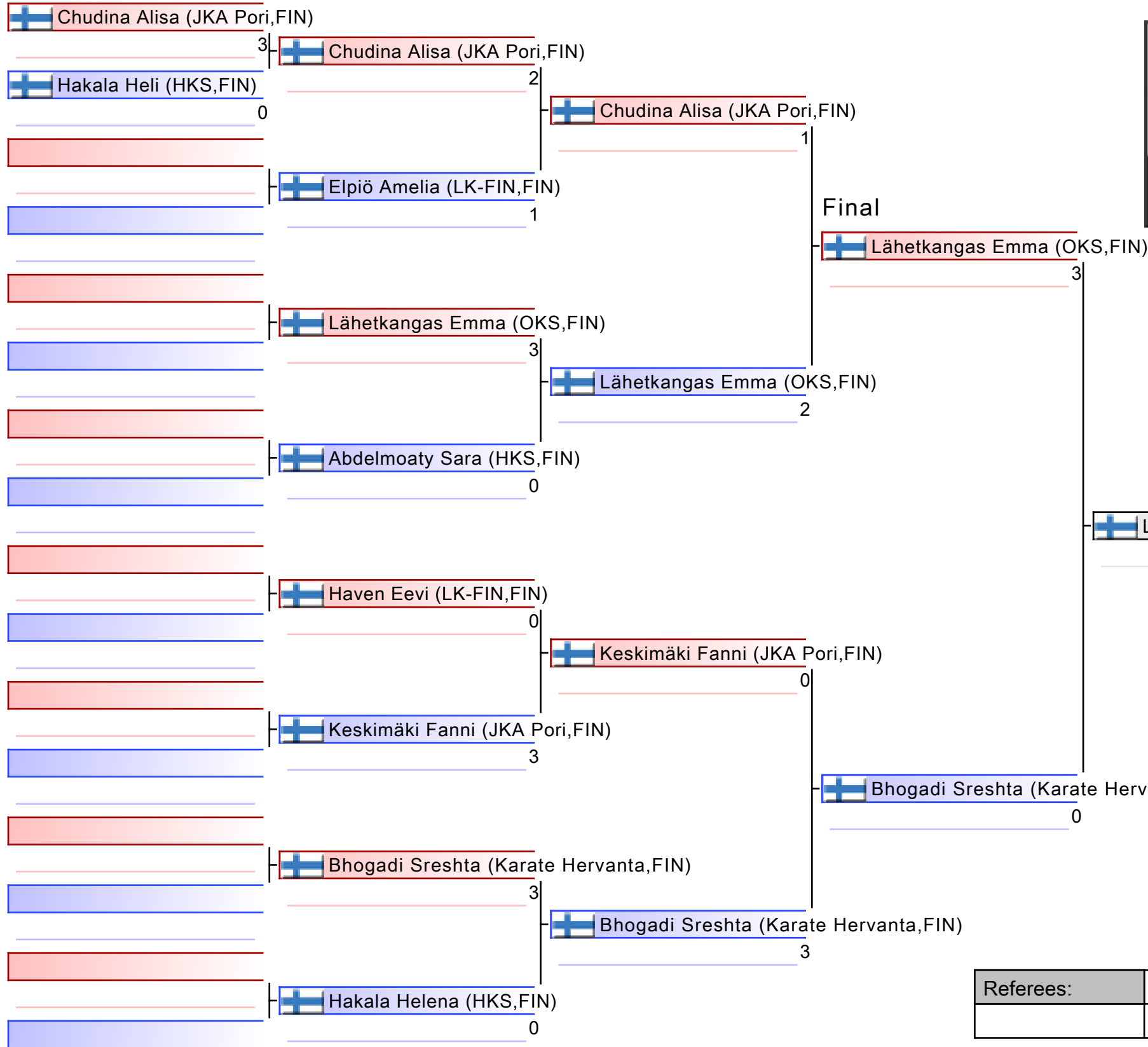

|  |
|--|
| 1. LÄHETKANGAS EMMA (OKS,FIN)            |
| 2. BHOGADI SRESHTA (KARATE HERVANTA,FIN) |
| 3. CHUDINA ALISA (JKA PORI,FIN)          |
| 4. HAKALA HELENA (HKS,FIN)               |
| 5. ABDELMOATY SARA (HKS,FIN)             |
| 5. KESKIMÄKI FANNI (JKA PORI,FIN)        |
|  |
|  |

|           |  |  |  |
|-----------|--|--|--|
| Referees: |  |  |  |
|           |  |  |  |

# Kata, tytöt, keltaiset, U10 yhdistetty

Tawastia Open Karate 2/2024

2024-10-05

Tatami  
1 10:25

Pool  
1

(c)sportdata GmbH & Co KG 2000-2024 (2024-10-06 10:03) v 10.2.0 build 1 (2024-09-26 10:14 CET) License: Online\_Event\_ID-8546\_TawastiaOpenKarate22024 (expire 2024-10-20)

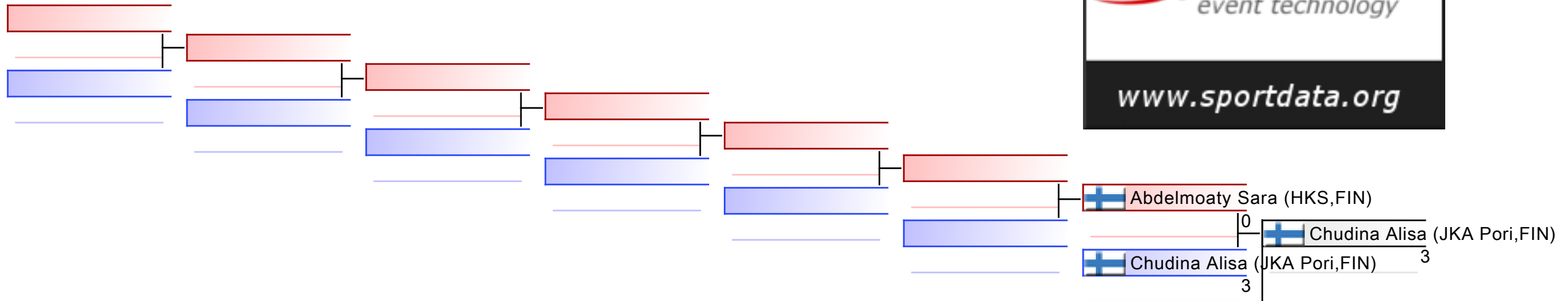

## REPECHAGE: (1)

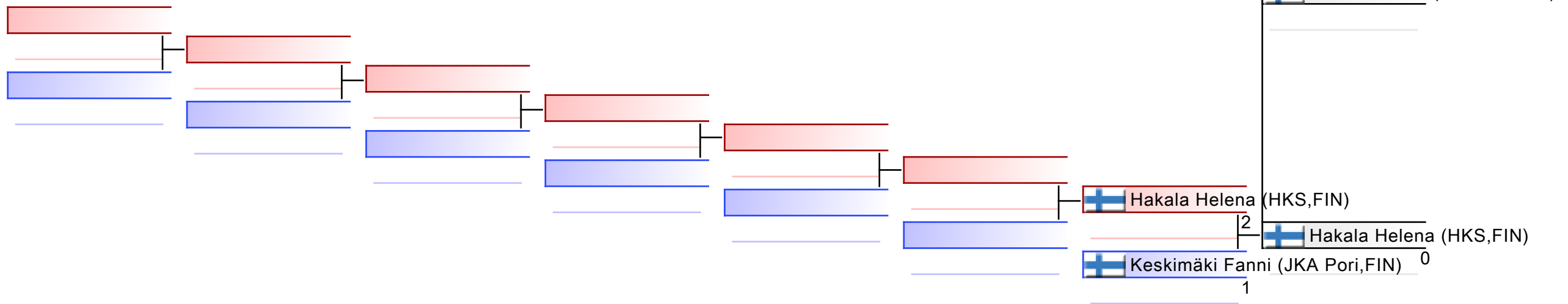

|           |  |  |  |  |  |  |  |
|-----------|--|--|--|--|--|--|--|
| Referees: |  |  |  |  |  |  |  |
|-----------|--|--|--|--|--|--|--|

# Tawastia Open Karate 2/2024

Liivuoentie 24, Hmeenlinna, FINLAND

|            |                                       |         |       |             |                       |                |    |
|------------|---------------------------------------|---------|-------|-------------|-----------------------|----------------|----|
| Court Nr.  | 1                                     | Pool    | 1     | Date        | 2024-10-06            | Field Position | 49 |
| <b>RED</b> |                                       |         |       | <b>BLUE</b> |                       |                |    |
| NOC        | CHUDINA ALISA (JKA PORI,FIN)          |         |       | NOC         | HAKALA HELI (HKS,FIN) |                |    |
| Category   | Kata, tytt, keltaiset, U10 yhdistetty |         |       |             |                       |                |    |
| 3 Points   | 2 Points                              | 1 Point | Score | 1 Point     | 2 Points              | 3 Points       |    |
|            |                                       |         | :     |             |                       |                |    |
| Penatlity  |                                       |         |       | Penatlity   |                       |                |    |
|            |                                       |         |       |             |                       |                |    |
|            |                                       |         | Total |             |                       |                |    |

## Decision of Superiority

| Judge 1 | Judge 2 | Judge 3 | Judge 4 | Judge 5 | Judge 6 | Judge 7 | Referee |
|---------|---------|---------|---------|---------|---------|---------|---------|
|         |         |         |         |         |         |         |         |

Name \_\_\_\_\_  
 Signature \_\_\_\_\_



# Tawastia Open Karate 2/2024

Liivuoentie 24, Hmeenlinna, FINLAND

|            |                                       |         |       |             |                          |                |    |
|------------|---------------------------------------|---------|-------|-------------|--------------------------|----------------|----|
| Court Nr.  | 1                                     | Pool    | 1     | Date        | 2024-10-06               | Field Position | 57 |
| <b>RED</b> |                                       |         |       | <b>BLUE</b> |                          |                |    |
| NOC        | CHUDINA ALISA (JKA PORI,FIN)          |         |       | NOC         | ELPI AMELIA (LK-FIN,FIN) |                |    |
| Category   | Kata, tytt, keltaiset, U10 yhdistetty |         |       |             |                          |                |    |
| 3 Points   | 2 Points                              | 1 Point | Score | 1 Point     | 2 Points                 | 3 Points       |    |
|            |                                       |         | :     |             |                          |                |    |
| Penatlity  |                                       |         |       | Penatlity   |                          |                |    |
|            |                                       |         |       |             |                          |                |    |
|            |                                       |         | Total |             |                          |                |    |

## Decision of Superiority

| Judge 1 | Judge 2 | Judge 3 | Judge 4 | Judge 5 | Judge 6 | Judge 7 | Referee |
|---------|---------|---------|---------|---------|---------|---------|---------|
|         |         |         |         |         |         |         |         |

Name \_\_\_\_\_  
 Signature \_\_\_\_\_



# Tawastia Open Karate 2/2024

Liivuoentie 24, Hmeenlinna, FINLAND

|            |                                       |         |       |             |                           |                |    |
|------------|---------------------------------------|---------|-------|-------------|---------------------------|----------------|----|
| Court Nr.  | 1                                     | Pool    | 1     | Date        | 2024-10-06                | Field Position | 58 |
| <b>RED</b> |                                       |         |       | <b>BLUE</b> |                           |                |    |
| NOC        | LHETKANGAS EMMA (OKS,FIN)             |         |       | NOC         | ABDELMOATY SARA (HKS,FIN) |                |    |
| Category   | Kata, tytt, keltaiset, U10 yhdistetty |         |       |             |                           |                |    |
| 3 Points   | 2 Points                              | 1 Point | Score | 1 Point     | 2 Points                  | 3 Points       |    |
|            |                                       |         | :     |             |                           |                |    |
| Penatlity  |                                       |         |       | Penatlity   |                           |                |    |
|            |                                       |         |       |             |                           |                |    |
|            |                                       |         | Total |             |                           |                |    |

## Decision of Superiority

| Judge 1 | Judge 2 | Judge 3 | Judge 4 | Judge 5 | Judge 6 | Judge 7 | Referee |
|---------|---------|---------|---------|---------|---------|---------|---------|
|         |         |         |         |         |         |         |         |

Name \_\_\_\_\_

Signature \_\_\_\_\_



# Tawastia Open Karate 2/2024

Liivuoentie 24, Hmeenlinna, FINLAND

|            |                                       |         |       |             |                               |                |    |
|------------|---------------------------------------|---------|-------|-------------|-------------------------------|----------------|----|
| Court Nr.  | 1                                     | Pool    | 1     | Date        | 2024-10-06                    | Field Position | 59 |
| <b>RED</b> |                                       |         |       | <b>BLUE</b> |                               |                |    |
| NOC        | HAVEN EEVI (LK-FIN,FIN)               |         |       | NOC         | KESKIMKI FANNI (JKA PORI,FIN) |                |    |
| Category   | Kata, tytt, keltaiset, U10 yhdistetty |         |       |             |                               |                |    |
| 3 Points   | 2 Points                              | 1 Point | Score | 1 Point     | 2 Points                      | 3 Points       |    |
|            |                                       |         | :     |             |                               |                |    |
| Penatlity  |                                       |         |       | Penatlity   |                               |                |    |
|            |                                       |         |       |             |                               |                |    |
|            |                                       |         | Total |             |                               |                |    |

## Decision of Superiority

|         |         |         |         |         |         |         |         |
|---------|---------|---------|---------|---------|---------|---------|---------|
| Judge 1 | Judge 2 | Judge 3 | Judge 4 | Judge 5 | Judge 6 | Judge 7 | Referee |
|         |         |         |         |         |         |         |         |

Name \_\_\_\_\_

Signature \_\_\_\_\_





# Tawastia Open Karate 2/2024

Liivuoentie 24, Hmeenlinna, FINLAND

|            |   |         |       |             |                          |                |    |
|------------|---|---------|-------|-------------|--------------------------|----------------|----|
| Court Nr.  | 1                                       | Pool    | 1     | Date        | 2024-10-06               | Field Position | 60 |
| <b>RED</b> |   |         |       | <b>BLUE</b> |                          |                |    |
| NOC        | BHO GADI SRESHTA (KARATE HERVANTA, FIN) |         |       | NOC         | HAKALA HELENA (HKS, FIN) |                |    |
| Category   | Kata, tytt, keltaiset, U10 yhdistetty   |         |       |             |                          |                |    |
| 3 Points   | 2 Points                                | 1 Point | Score | 1 Point     | 2 Points                 | 3 Points       |    |
|            |   |         | :     |             |                          |                |    |
| Penatlity  |   |         |       | Penatlity   |                          |                |    |
|            |   |         |       |             |                          |                |    |
|            |   |         | Total |             |                          |                |    |

## Decision of Superiority

| Judge 1 | Judge 2 | Judge 3 | Judge 4 | Judge 5 | Judge 6 | Judge 7 | Referee |
|---------|---------|---------|---------|---------|---------|---------|---------|
|         |         |         |         |         |         |         |         |

Name \_\_\_\_\_

Signature \_\_\_\_\_



# Tawastia Open Karate 2/2024

Liivuoentie 24, Hmeenlinna, FINLAND

|            |                                       |         |       |             |                           |                |    |
|------------|---------------------------------------|---------|-------|-------------|---------------------------|----------------|----|
| Court Nr.  | 1                                     | Pool    | 1     | Date        | 2024-10-06                | Field Position | 61 |
| <b>RED</b> |                                       |         |       | <b>BLUE</b> |                           |                |    |
| NOC        | CHUDINA ALISA (JKA PORI,FIN)          |         |       | NOC         | LHETKANGAS EMMA (OKS,FIN) |                |    |
| Category   | Kata, tytt, keltaiset, U10 yhdistetty |         |       |             |                           |                |    |
| 3 Points   | 2 Points                              | 1 Point | Score | 1 Point     | 2 Points                  | 3 Points       |    |
|            |                                       |         | :     |             |                           |                |    |
| Penatlity  |                                       |         |       | Penatlity   |                           |                |    |
|            |                                       |         |       |             |                           |                |    |
|            |                                       |         | Total |             |                           |                |    |

## Decision of Superiority

|         |         |         |         |         |         |         |         |
|---------|---------|---------|---------|---------|---------|---------|---------|
| Judge 1 | Judge 2 | Judge 3 | Judge 4 | Judge 5 | Judge 6 | Judge 7 | Referee |
|         |         |         |         |         |         |         |         |

Name

Signature

\_\_\_\_\_

\_\_\_\_\_



# Tawastia Open Karate 2/2024

Liivuoentie 24, Hmeenlinna, FINLAND

|            |                                       |         |       |             |                                       |                |    |
|------------|---------------------------------------|---------|-------|-------------|---------------------------------------|----------------|----|
| Court Nr.  | 1                                     | Pool    | 1     | Date        | 2024-10-06                            | Field Position | 62 |
| <b>RED</b> |                                       |         |       | <b>BLUE</b> |                                       |                |    |
| NOC        | KESKIMKI FANNI (JKA PORI,FIN)         |         |       | NOC         | BHOGADI SRESHTA (KARATE HERVANTA,FIN) |                |    |
| Category   | Kata, tytt, keltaiset, U10 yhdistetty |         |       |             |                                       |                |    |
| 3 Points   | 2 Points                              | 1 Point | Score | 1 Point     | 2 Points                              | 3 Points       |    |
|            |                                       |         | :     |             |                                       |                |    |
| Penatlity  |                                       |         |       | Penatlity   |                                       |                |    |
|            |                                       |         |       |             |                                       |                |    |
|            |                                       |         | Total |             |                                       |                |    |

## Decision of Superiority

|         |         |         |         |         |         |         |         |
|---------|---------|---------|---------|---------|---------|---------|---------|
| Judge 1 | Judge 2 | Judge 3 | Judge 4 | Judge 5 | Judge 6 | Judge 7 | Referee |
|         |         |         |         |         |         |         |         |

Name

Signature

\_\_\_\_\_  
\_\_\_\_\_



# Tawastia Open Karate 2/2024

Liivuoentie 24, Hmeenlinna, FINLAND

|            |                                       |         |       |             |                                       |                |    |
|------------|---------------------------------------|---------|-------|-------------|---------------------------------------|----------------|----|
| Court Nr.  | 1                                     | Pool    | 1     | Date        | 2024-10-06                            | Field Position | 63 |
| <b>RED</b> |                                       |         |       | <b>BLUE</b> |                                       |                |    |
| NOC        | LHETKANGAS EMMA (OKS,FIN)             |         |       | NOC         | BHOGADI SRESHTA (KARATE HERVANTA,FIN) |                |    |
| Category   | Kata, tytt, keltaiset, U10 yhdistetty |         |       |             |                                       |                |    |
| 3 Points   | 2 Points                              | 1 Point | Score | 1 Point     | 2 Points                              | 3 Points       |    |
|            |                                       |         | :     |             |                                       |                |    |
| Penatlity  |                                       |         |       | Penatlity   |                                       |                |    |
|            |                                       |         |       |             |                                       |                |    |
|            |                                       |         | Total |             |                                       |                |    |

## Decision of Superiority

|         |         |         |         |         |         |         |         |
|---------|---------|---------|---------|---------|---------|---------|---------|
| Judge 1 | Judge 2 | Judge 3 | Judge 4 | Judge 5 | Judge 6 | Judge 7 | Referee |
|         |         |         |         |         |         |         |         |

Name

Signature

\_\_\_\_\_

\_\_\_\_\_



# Tawastia Open Karate 2/2024

Liivuoentie 24, Hmeenlinna, FINLAND

|            |                                       |         |       |             |                              |                |   |
|------------|---------------------------------------|---------|-------|-------------|------------------------------|----------------|---|
| Court Nr.  | 1                                     | Pool    | 1     | Date        | 2024-10-06                   | Field Position | 0 |
| <b>RED</b> |                                       |         |       | <b>BLUE</b> |                              |                |   |
| NOC        | ABDELMOATY SARA (HKS,FIN)             |         |       | NOC         | CHUDINA ALISA (JKA PORI,FIN) |                |   |
| Category   | Kata, tytt, keltaiset, U10 yhdistetty |         |       |             |                              |                |   |
| 3 Points   | 2 Points                              | 1 Point | Score | 1 Point     | 2 Points                     | 3 Points       |   |
|            |                                       |         | :     |             |                              |                |   |
| Penatlity  |                                       |         |       | Penatlity   |                              |                |   |
|            |                                       |         |       |             |                              |                |   |
|            |                                       |         | Total |             |                              |                |   |

## Decision of Superiority

|         |         |         |         |         |         |         |         |
|---------|---------|---------|---------|---------|---------|---------|---------|
| Judge 1 | Judge 2 | Judge 3 | Judge 4 | Judge 5 | Judge 6 | Judge 7 | Referee |
|         |         |         |         |         |         |         |         |

Name

Signature

\_\_\_\_\_

\_\_\_\_\_



# Tawastia Open Karate 2/2024

Liivuoentie 24, Hmeenlinna, FINLAND

|            |                                       |         |       |             |                               |                |   |
|------------|---------------------------------------|---------|-------|-------------|-------------------------------|----------------|---|
| Court Nr.  | 2                                     | Pool    | 2     | Date        | 2024-10-06                    | Field Position | 0 |
| <b>RED</b> |                                       |         |       | <b>BLUE</b> |                               |                |   |
| NOC        | HAKALA HELENA (HKS,FIN)               |         |       | NOC         | KESKIMKI FANNI (JKA PORI,FIN) |                |   |
| Category   | Kata, tytt, keltaiset, U10 yhdistetty |         |       |             |                               |                |   |
| 3 Points   | 2 Points                              | 1 Point | Score | 1 Point     | 2 Points                      | 3 Points       |   |
|            |                                       |         | :     |             |                               |                |   |
| Penatlity  |                                       |         |       | Penatlity   |                               |                |   |
|            |                                       |         |       |             |                               |                |   |
|            |                                       |         | Total |             |                               |                |   |

## Decision of Superiority

|         |         |         |         |         |         |         |         |
|---------|---------|---------|---------|---------|---------|---------|---------|
| Judge 1 | Judge 2 | Judge 3 | Judge 4 | Judge 5 | Judge 6 | Judge 7 | Referee |
|         |         |         |         |         |         |         |         |

Name

Signature





\_\_\_\_\_

\_\_\_\_\_



## Tawastia Open Karate 2/2024 - 2024-10-05

## Official Results

| Kata, tytöt, keltaiset, U10 yhdistetty |                  |                             |   |               |
|--|------------------|-----------------------------|---|---------------|
| 1                                      | LÄHETKANGAS EMMA | OULUN<br>KARATESEURA        |  | FIN - FINLAND |
| 2                                      | BHOGADI SRESHTA  | SHOTOKAN<br>HERVANTA RY     |  | FIN - FINLAND |
| 3                                      | CHUDINA ALISA    | PORIN SHOTOKAN              |  | FIN - FINLAND |
| 4                                      | HAKALA HELENA    | HÄMEENLINNAN<br>KARATESEURA |  | FIN - FINLAND |
| 5                                      | ABDELMOATY SARA  | HÄMEENLINNAN<br>KARATESEURA |  | FIN - FINLAND |
| 5                                      | KESKIMÄKI FANNI  | PORIN SHOTOKAN              |  | FIN - FINLAND |

# KATA, TYTÖT VALK-KELT, U14



Tawastia Open Karate 2/2024

**ENTRIES BY WEIGHT CATEGORY**  
**Kata, tytt valk-kelt, U14**

As of 6 OCT 2024

| Country Code | ID | Gender | Name                | Seeding |
|--------------|----|--------|---------------------|---------|
| FIN          |    | F      | Coman Anastasia     |         |
| FIN          |    | F      | Hameeda Ahmed Aisha |         |
| FIN          |    | F      | Pirinen Mila        |         |
| FIN          |    | F      | Salminen Wenla      |         |
| FIN          |    | F      | Sova Elina          |         |

# Kata, tytöt valk-kelt, U14

Tawastia Open Karate 2/2024, Liivuoventie 24, Hämeenlinna, FIN

2024-10-05

Tatami  
1 12:45

Pool  
1/1

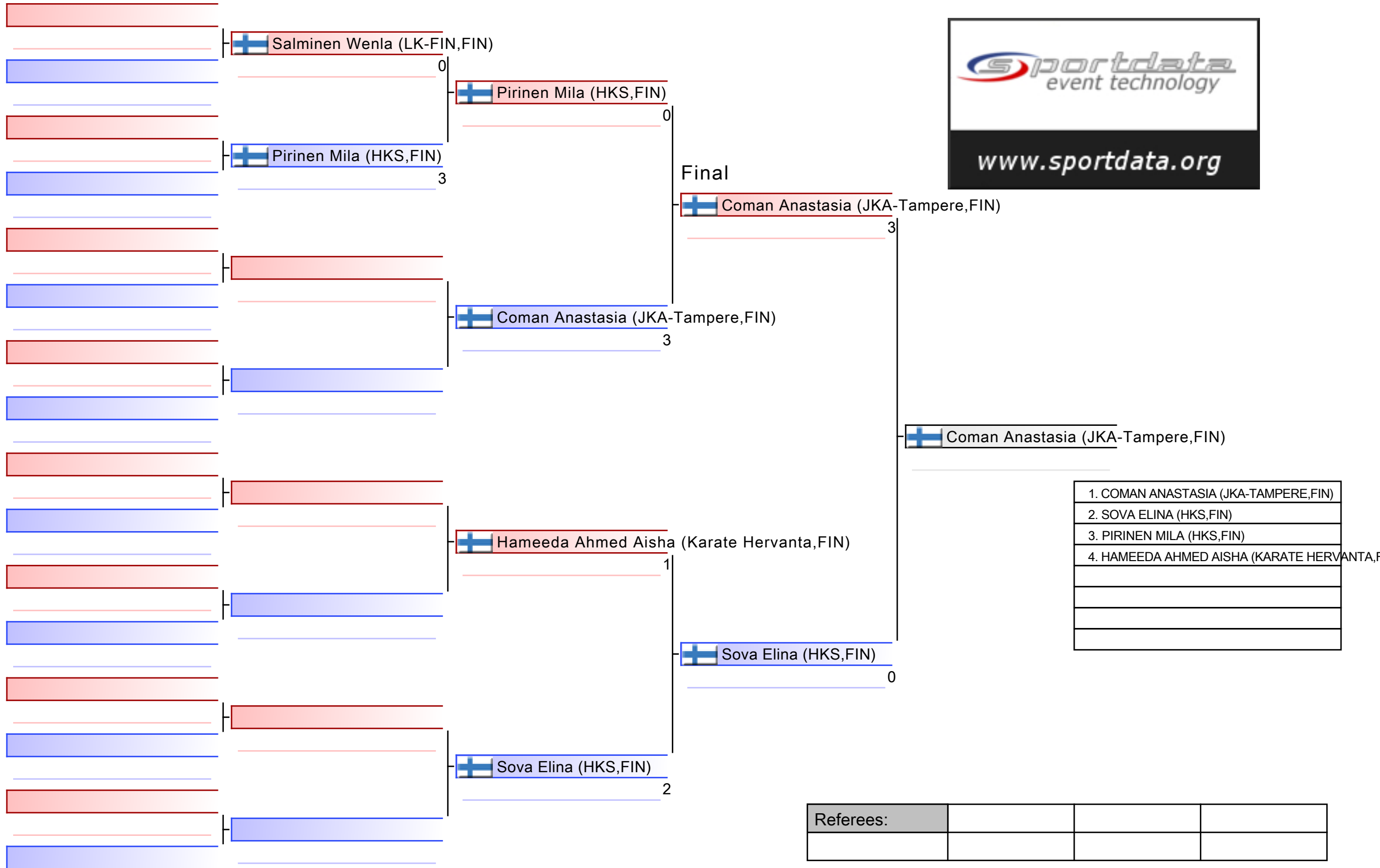

# Kata, tytöt valk-kelt, U14

Tawastia Open Karate 2/2024

2024-10-05

Tatami  
1 12:45

Pool  
1

(c)sportdata GmbH & Co KG 2000-2024 (2024-10-06 10:03) v 10.2.0 build 1 (2024-09-26 10:14 CET) License: Online\_Event\_ID-8546\_TawastiaOpenKarate22024 (expire 2024-10-20)

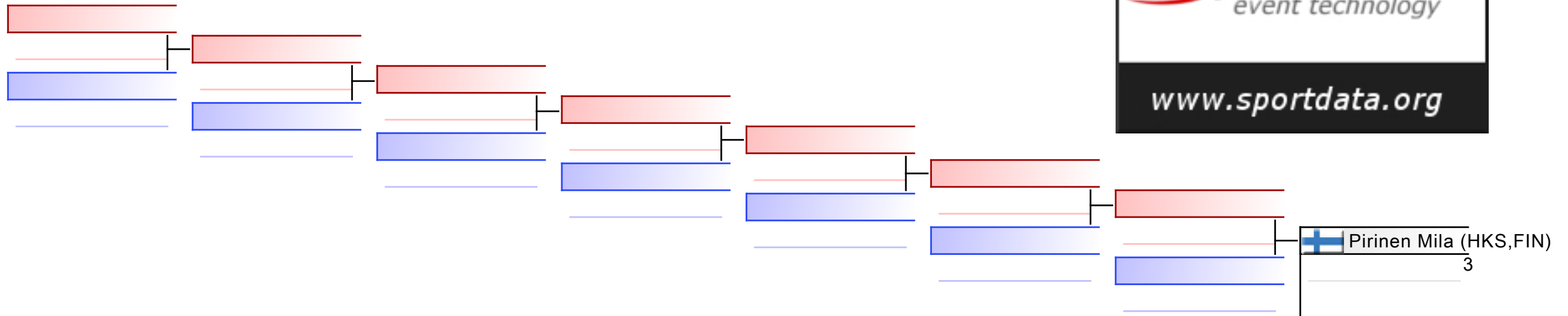

## REPECHAGE: (1)

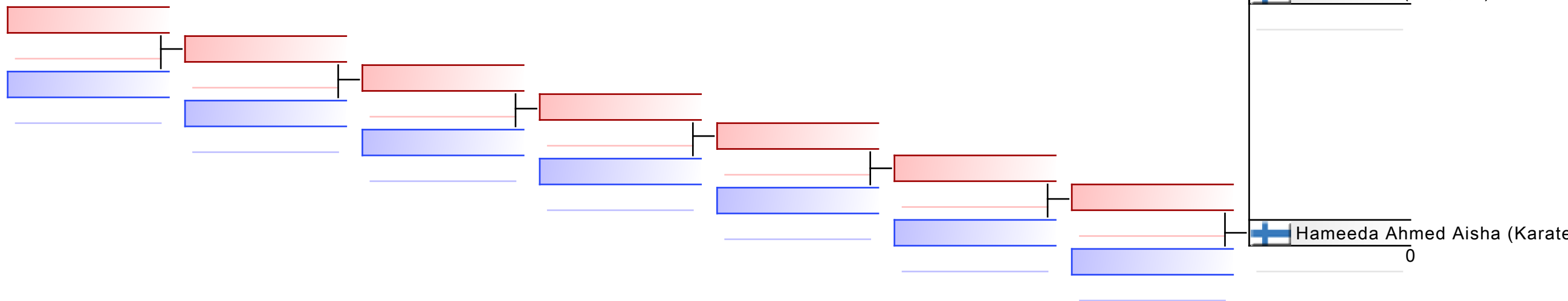

|           |  |  |  |  |  |  |  |
|-----------|--|--|--|--|--|--|--|
| Referees: |  |  |  |  |  |  |  |
|-----------|--|--|--|--|--|--|--|

# Tawastia Open Karate 2/2024

Liivuoentie 24, Hmeenlinna, FINLAND

|            |                             |         |       |             |                        |                |    |
|------------|-----------------------------|---------|-------|-------------|------------------------|----------------|----|
| Court Nr.  | 1                           | Pool    | 1     | Date        | 2024-10-06             | Field Position | 57 |
| <b>RED</b> |                             |         |       | <b>BLUE</b> |                        |                |    |
| NOC        | SALMINEN WENLA (LK-FIN,FIN) |         |       | NOC         | PIRINEN MILA (HKS,FIN) |                |    |
| Category   | Kata, tytt valk-kelt, U14   |         |       |             |                        |                |    |
| 3 Points   | 2 Points                    | 1 Point | Score | 1 Point     | 2 Points               | 3 Points       |    |
|            |                             |         | :     |             |                        |                |    |
| Penatlity  |                             |         |       | Penatlity   |                        |                |    |
|            |                             |         |       |             |                        |                |    |
|            |                             |         | Total |             |                        |                |    |

## Decision of Superiority

|         |         |         |         |         |         |         |         |
|---------|---------|---------|---------|---------|---------|---------|---------|
| Judge 1 | Judge 2 | Judge 3 | Judge 4 | Judge 5 | Judge 6 | Judge 7 | Referee |
|         |         |         |         |         |         |         |         |

Name \_\_\_\_\_

Signature \_\_\_\_\_



# Tawastia Open Karate 2/2024

Liivuoentie 24, Hmeenlinna, FINLAND

|            |                           |         |       |             |                                   |                |    |
|------------|---------------------------|---------|-------|-------------|-----------------------------------|----------------|----|
| Court Nr.  | 1                         | Pool    | 1     | Date        | 2024-10-06                        | Field Position | 61 |
| <b>RED</b> |                           |         |       | <b>BLUE</b> |                                   |                |    |
| NOC        | PIRINEN MILA (HKS,FIN)    |         |       | NOC         | COMAN ANASTASIA (JKA-TAMPERE,FIN) |                |    |
| Category   | Kata, tytt valk-kelt, U14 |         |       |             |                                   |                |    |
| 3 Points   | 2 Points                  | 1 Point | Score | 1 Point     | 2 Points                          | 3 Points       |    |
|            |                           |         | :     |             |                                   |                |    |
| Penatlity  |                           |         |       | Penatlity   |                                   |                |    |
|            |                           |         |       |             |                                   |                |    |
|            |                           |         | Total |             |                                   |                |    |

## Decision of Superiority

| Judge 1 | Judge 2 | Judge 3 | Judge 4 | Judge 5 | Judge 6 | Judge 7 | Referee |
|---------|---------|---------|---------|---------|---------|---------|---------|
|         |         |         |         |         |         |         |         |

Name \_\_\_\_\_  
 Signature \_\_\_\_\_



# Tawastia Open Karate 2/2024

Liivuoentie 24, Hmeenlinna, FINLAND

|            |   |         |       |             |                      |                |    |
|------------|---|---------|-------|-------------|----------------------|----------------|----|
| Court Nr.  | 1   | Pool    | 1     | Date        | 2024-10-06           | Field Position | 62 |
| <b>RED</b> |   |         |       | <b>BLUE</b> |                      |                |    |
| NOC        | HAMEEDA AHMED AISHA (KARATE HERVANTA,FIN) |         |       | NOC         | SOVA ELINA (HKS,FIN) |                |    |
| Category   | Kata, tytt valk-kelt, U14                 |         |       |             |                      |                |    |
| 3 Points   | 2 Points                                  | 1 Point | Score | 1 Point     | 2 Points             | 3 Points       |    |
|            |   |         | :     |             |                      |                |    |
| Penatlity  |   |         |       | Penatlity   |                      |                |    |
|            |   |         |       |             |                      |                |    |
|            |   |         | Total |             |                      |                |    |

## Decision of Superiority

|         |         |         |         |         |         |         |         |
|---------|---------|---------|---------|---------|---------|---------|---------|
| Judge 1 | Judge 2 | Judge 3 | Judge 4 | Judge 5 | Judge 6 | Judge 7 | Referee |
|         |         |         |         |         |         |         |         |

Name \_\_\_\_\_

Signature \_\_\_\_\_



# Tawastia Open Karate 2/2024

Liivuoentie 24, Hmeenlinna, FINLAND

|            |                                      |         |       |             |                      |                |    |
|------------|--------------------------------------|---------|-------|-------------|----------------------|----------------|----|
| Court Nr.  | 1                                    | Pool    | 1     | Date        | 2024-10-06           | Field Position | 63 |
| <b>RED</b> |                                      |         |       | <b>BLUE</b> |                      |                |    |
| NOC        | COMAN ANASTASIA<br>(JKA-TAMPERE,FIN) |         |       | NOC         | SOVA ELINA (HKS,FIN) |                |    |
| Category   | Kata, tytt valk-kelt, U14            |         |       |             |                      |                |    |
| 3 Points   | 2 Points                             | 1 Point | Score | 1 Point     | 2 Points             | 3 Points       |    |
|            |                                      |         | :     |             |                      |                |    |
| Penatlity  |                                      |         |       | Penatlity   |                      |                |    |
|            |                                      |         |       |             |                      |                |    |
|            |                                      |         | Total |             |                      |                |    |

## Decision of Superiority

| Judge 1 | Judge 2 | Judge 3 | Judge 4 | Judge 5 | Judge 6 | Judge 7 | Referee |
|---------|---------|---------|---------|---------|---------|---------|---------|
|         |         |         |         |         |         |         |         |

Name \_\_\_\_\_





Signature \_\_\_\_\_







## Official Results

| Kata, tytöt valk-kelt, U14 |                     |                                     |   |               |  |
|----------------------------|---------------------|-------------------------------------|---|---------------|--|
| 1                          | COMAN ANASTASIA     | JAPAN KARATE ASSOCIATION TAMPERE RY |  | FIN - FINLAND |  |
| 2                          | SOVA ELINA          | HAMEENLINNAN KARATESEURA            |  | FIN - FINLAND |  |
| 3                          | PIRINEN MILA        | HAMEENLINNAN KARATESEURA            |  | FIN - FINLAND |  |
| 4                          | HAMEEDA AHMED AISHA | SHOTOKAN HERVANTA RY                |  | FIN - FINLAND |  |

KUMITE, MIEHET, +35-VUOTIAAT,  
+84 KG

Tawastia Open Karate 2/2024

**ENTRIES BY WEIGHT CATEGORY**  
Kumite, miehet, +35-vuotiaat, +84 kg

As of 6 OCT 2024

| Country Code | ID | Gender | Name         | Seeding |
|--------------|----|--------|--------------|---------|
| FIN          |    | M      | Hrknen Jarno |         |
| FIN          |    | M      | Vlimki Risto |         |

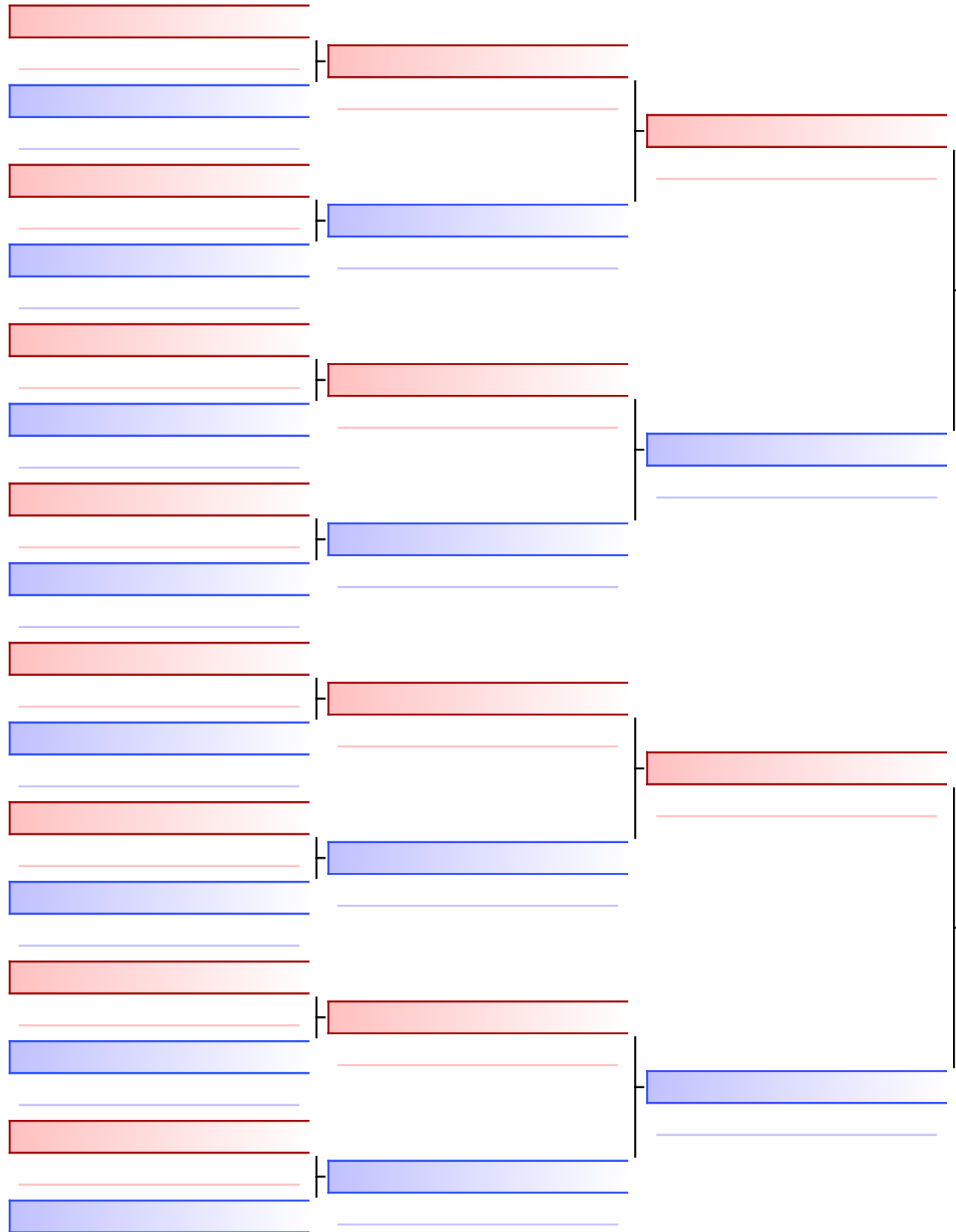

Final

Härkönen Jarno (OKS,FIN)

0

Välimäki Risto (JKA Lempäälä,FIN)

Välimäki Risto (JKA Lempäälä,FIN)

2

|                                      |
|--------------------------------------|
| 1. VÄLIMÄKI RISTO (JKA LEMPÄÄLÄ,FIN) |
| 2. HÄRKÖNEN JARNO (OKS,FIN)          |
|                                      |
|                                      |
|                                      |
|                                      |
|                                      |

|           |  |  |  |
|-----------|--|--|--|
| Referees: |  |  |  |
|           |  |  |  |

# Tawastia Open Karate 2/2024

Liivuoentie 24, Hmeenlinna, FINLAND

|            |                                      |         |            |             |                              |                |    |
|------------|--------------------------------------|---------|------------|-------------|------------------------------|----------------|----|
| Court Nr.  | 1                                    | Pool    | 1          | Date        | 2024-10-06                   | Field Position | 63 |
| <b>RED</b> |                                      |         |            | <b>BLUE</b> |                              |                |    |
| NOC        | HRKNEN JARNO (OKS,FIN)               |         |            | NOC         | VLIMKI RISTO (JKA LEMPL,FIN) |                |    |
| Category   | Kumite, miehet, +35-vuotiaat, +84 kg |         |            |             |                              |                |    |
| 3 Points   | 2 Points                             | 1 Point | Score      | 1 Point     | 2 Points                     | 3 Points       |    |
|            |                                      |         | 0 : 2      |             |                              |                |    |
| Penatlity  |                                      |         |            | Penatlity   |                              |                |    |
| C1: , C2:  |                                      |         | <b>0:2</b> | C1: , C2:   |                              |                |    |
|            |                                      |         | Total      | WINNER      |                              |                |    |

PTS

## Decision of Superiority

| Judge 1 | Judge 2 | Judge 3 | Judge 4 | Judge 5 | Judge 6 | Judge 7 | Referee |
|---------|---------|---------|---------|---------|---------|---------|---------|
|         |         |         |         |         |         |         |         |

Name



Signature

\_\_\_\_\_  
\_\_\_\_\_



Tawastia Open Karate 2/2024 - 2024-10-05

Official Results

| Kumite, miehet, +35-vuotiaat, +84 kg |                |                              |   |               |
|--------------------------------------|----------------|------------------------------|---|---------------|
| 1                                    | VÄLIMÄKI RISTO | LEMPÄÄLÄN<br>SHOTOKAN KARATE |  | FIN - FINLAND |
| 2                                    | HÄRKÖNEN JARNO | OUTOKUMMUN<br>KARATESEURA RY |  | FIN - FINLAND |

# KUMITE, MIEHET, +75KG

Tawastia Open Karate 2/2024

**ENTRIES BY WEIGHT CATEGORY**  
**Kumite, miehet, +75kg**

As of 6 OCT 2024

| Country Code | ID | Gender | Name            | Seeding |
|--------------|----|--------|-----------------|---------|
| FIN          |    | M      | Hrknen Jarno    |         |
| FIN          |    | M      | Simola Teemu    |         |
| FIN          |    | M      | Sura Juha-Pekka |         |
| FIN          |    | M      | Vlimki Risto    |         |



# Kumite, miehet, +75kg - Round Robin (each against each)

Tawastia Open Karate 2/2024, Liivuaarentie 24, Hämeenlinna, FIN



















2024-10-05

Tatami

3 16:45

Pool

1/1

- 1  Härkönen Jarno (OKS,FIN) 9 |  Härkönen Jarno (OKS,FIN)
- 2  Sura Juha-Pekka (FT-Jundokan,FIN) 3
- 3  Simola Teemu (JKA-Tampere,FIN) 7 |  Simola Teemu (JKA-Tampere,FIN)
- 4  Välimäki Risto (JKA Lempäälä,FIN) 0
- 5  Härkönen Jarno (OKS,FIN) 6 |  Simola Teemu (JKA-Tampere,FIN)
- 6  Simola Teemu (JKA-Tampere,FIN) 12
- 7  Välimäki Risto (JKA Lempäälä,FIN) 4 |  Välimäki Risto (JKA Lempäälä,FIN)
- 8  Sura Juha-Pekka (FT-Jundokan,FIN) 3
- 9  Härkönen Jarno (OKS,FIN) 6 |  Härkönen Jarno (OKS,FIN)
- 10  Välimäki Risto (JKA Lempäälä,FIN) 2
- 11  Sura Juha-Pekka (FT-Jundokan,FIN) 5 |  Simola Teemu (JKA-Tampere,FIN)
- 12  Simola Teemu (JKA-Tampere,FIN) 14



|                                      |
|--------------------------------------|
| 1. SIMOLA TEEMU (JKA-TAMPERE,FIN)    |
| 2. HÄRKÖNEN JARNO (OKS,FIN)          |
| 3. VÄLIMÄKI RISTO (JKA LEMPÄÄLÄ,FIN) |
| 4. SURA JUHA-PEKKA (FT-JUNDOKAN,FIN) |
|                                      |
|                                      |
|                                      |

|           |  |  |  |
|-----------|--|--|--|
| Referees: |  |  |  |
|           |  |  |  |

# Tawastia Open Karate 2/2024

Liivuoentie 24, Hmeenlinna, FINLAND

|             |                        |         |            |             |                                   |                |       |
|-------------|------------------------|---------|------------|-------------|-----------------------------------|----------------|-------|
| Court Nr.   | 1                      | Pool    | 1          | Date        | 2024-10-06                        | Field Position | -9951 |
| <b>RED</b>  |                        |         |            | <b>BLUE</b> |                                   |                |       |
| NOC         | HRKNEN JARNO (OKS,FIN) |         |            | NOC         | SURA JUHA-PEKKA (FT-JUNDOKAN,FIN) |                |       |
| Category    | Kumite, miehet, +75kg  |         |            |             |                                   |                |       |
| 3 Points    | 2 Points               | 1 Point | Score      | 1 Point     | 2 Points                          | 3 Points       |       |
|             |                        |         | 9 : 3      |             |                                   |                |       |
| Penatlity   |                        |         |            | Penatlity   |                                   |                |       |
| C1: C1, C2: |                        |         | <b>9:3</b> | C1: C2, C2: |                                   |                |       |
| WINNER      |                        |         | Total      |             |                                   |                |       |

PTS

## Decision of Superiority

| Judge 1 | Judge 2 | Judge 3 | Judge 4 | Judge 5 | Judge 6 | Judge 7 | Referee |
|---------|---------|---------|---------|---------|---------|---------|---------|
|         |         |         |         |         |         |         |         |

Name \_\_\_\_\_

Signature \_\_\_\_\_



# Tawastia Open Karate 2/2024

Liivuoentie 24, Hmeenlinna, FINLAND

|            |                                |         |            |             |                              |                |       |
|------------|--------------------------------|---------|------------|-------------|------------------------------|----------------|-------|
| Court Nr.  | 1                              | Pool    | 1          | Date        | 2024-10-06                   | Field Position | -9950 |
| <b>RED</b> |                                |         |            | <b>BLUE</b> |                              |                |       |
| NOC        | SIMOLA TEEMU (JKA-TAMPERE,FIN) |         |            | NOC         | VLIMKI RISTO (JKA LEMPL,FIN) |                |       |
| Category   | Kumite, miehet, +75kg          |         |            |             |                              |                |       |
| 3 Points   | 2 Points                       | 1 Point | Score      | 1 Point     | 2 Points                     | 3 Points       |       |
|            |                                |         | 7 : 0      |             |                              |                |       |
| Penatlity  |                                |         |            | Penatlity   |                              |                |       |
| C1: , C2:  |                                |         | <b>7:0</b> | C1: C1, C2: |                              |                |       |
| WINNER     |                                |         | Total      |             |                              |                |       |

PTS

## Decision of Superiority

|         |         |         |         |         |         |         |         |
|---------|---------|---------|---------|---------|---------|---------|---------|
| Judge 1 | Judge 2 | Judge 3 | Judge 4 | Judge 5 | Judge 6 | Judge 7 | Referee |
|         |         |         |         |         |         |         |         |

Name

Signature

\_\_\_\_\_  
\_\_\_\_\_



# Tawastia Open Karate 2/2024

Liivuoentie 24, Hmeenlinna, FINLAND

|             |                        |         |             |             |                                |                |       |
|-------------|------------------------|---------|-------------|-------------|--------------------------------|----------------|-------|
| Court Nr.   | 1                      | Pool    | 1           | Date        | 2024-10-06                     | Field Position | -9949 |
| <b>RED</b>  |                        |         |             | <b>BLUE</b> |                                |                |       |
| NOC         | HRKNEN JARNO (OKS,FIN) |         |             | NOC         | SIMOLA TEEMU (JKA-TAMPERE,FIN) |                |       |
| Category    | Kumite, miehet, +75kg  |         |             |             |                                |                |       |
| 3 Points    | 2 Points               | 1 Point | Score       | 1 Point     | 2 Points                       | 3 Points       |       |
|             |                        |         | 6 : 12      |             |                                |                |       |
| Penatlity   |                        |         |             | Penatlity   |                                |                |       |
| C1: C3, C2: |                        |         | <b>6:12</b> | C1: C2, C2: |                                |                |       |
|             |                        |         | Total       | WINNER      |                                |                |       |

PTS

## Decision of Superiority

|         |         |         |         |         |         |         |         |
|---------|---------|---------|---------|---------|---------|---------|---------|
| Judge 1 | Judge 2 | Judge 3 | Judge 4 | Judge 5 | Judge 6 | Judge 7 | Referee |
|         |         |         |         |         |         |         |         |

Name

Signature

\_\_\_\_\_  
\_\_\_\_\_



# Tawastia Open Karate 2/2024

Liivuoentie 24, Hmeenlinna, FINLAND

|             |                              |         |            |             |                                   |                |       |
|-------------|------------------------------|---------|------------|-------------|-----------------------------------|----------------|-------|
| Court Nr.   | 1                            | Pool    | 1          | Date        | 2024-10-06                        | Field Position | -9948 |
| <b>RED</b>  |                              |         |            | <b>BLUE</b> |                                   |                |       |
| NOC         | VLIMKI RISTO (JKA LEMPL,FIN) |         |            | NOC         | SURA JUHA-PEKKA (FT-JUNDOKAN,FIN) |                |       |
| Category    | Kumite, miehet, +75kg        |         |            |             |                                   |                |       |
| 3 Points    | 2 Points                     | 1 Point | Score      | 1 Point     | 2 Points                          | 3 Points       |       |
|             |                              |         | 4 : 3      |             |                                   |                |       |
| Penatlity   |                              |         |            | Penatlity   |                                   |                |       |
| C1: C2, C2: |                              |         | <b>4:3</b> | C1: , C2:   |                                   |                |       |
| WINNER      |                              |         | Total      |             |                                   |                |       |

PTS

## Decision of Superiority

| Judge 1 | Judge 2 | Judge 3 | Judge 4 | Judge 5 | Judge 6 | Judge 7 | Referee |
|---------|---------|---------|---------|---------|---------|---------|---------|
|         |         |         |         |         |         |         |         |

Name

Signature

\_\_\_\_\_  
\_\_\_\_\_



# Tawastia Open Karate 2/2024

Liivuoentie 24, Hmeenlinna, FINLAND

|            |                        |         |            |             |                              |                |       |
|------------|------------------------|---------|------------|-------------|------------------------------|----------------|-------|
| Court Nr.  | 1                      | Pool    | 1          | Date        | 2024-10-06                   | Field Position | -9947 |
| <b>RED</b> |                        |         |            | <b>BLUE</b> |                              |                |       |
| NOC        | HRKNEN JARNO (OKS,FIN) |         |            | NOC         | VLIMKI RISTO (JKA LEMPL,FIN) |                |       |
| Category   | Kumite, miehet, +75kg  |         |            |             |                              |                |       |
| 3 Points   | 2 Points               | 1 Point | Score      | 1 Point     | 2 Points                     | 3 Points       |       |
|            |                        |         | 6 : 2      |             |                              |                |       |
| Penatlity  |                        |         |            | Penatlity   |                              |                |       |
| C1: , C2:  |                        |         | <b>6:2</b> | C1: , C2:   |                              |                |       |
| WINNER     |                        |         | Total      |             |                              |                |       |

PTS

## Decision of Superiority

| Judge 1 | Judge 2 | Judge 3 | Judge 4 | Judge 5 | Judge 6 | Judge 7 | Referee |
|---------|---------|---------|---------|---------|---------|---------|---------|
|         |         |         |         |         |         |         |         |

Name

Signature

\_\_\_\_\_  
\_\_\_\_\_



# Tawastia Open Karate 2/2024

Liivuoentie 24, Hmeenlinna, FINLAND

|            |                                      |         |             |             |                                |                |       |
|------------|--------------------------------------|---------|-------------|-------------|--------------------------------|----------------|-------|
| Court Nr.  | 1                                    | Pool    | 1           | Date        | 2024-10-06                     | Field Position | -9946 |
| <b>RED</b> |                                      |         |             | <b>BLUE</b> |                                |                |       |
| NOC        | SURA JUHA-PEKKA<br>(FT-JUNDOKAN,FIN) |         |             | NOC         | SIMOLA TEEMU (JKA-TAMPERE,FIN) |                |       |
| Category   | Kumite, miehet, +75kg                |         |             |             |                                |                |       |
| 3 Points   | 2 Points                             | 1 Point | Score       | 1 Point     | 2 Points                       | 3 Points       |       |
|            |                                      |         | 5 : 14      |             |                                |                |       |
| Penatlity  |                                      |         |             | Penatlity   |                                |                |       |
| C1: , C2:  |                                      |         | <b>5:14</b> | C1: C1, C2: |                                |                |       |
|            |                                      |         | Total       | WINNER      |                                |                |       |

PTS

## Decision of Superiority

| Judge 1 | Judge 2 | Judge 3 | Judge 4 | Judge 5 | Judge 6 | Judge 7 | Referee |
|---------|---------|---------|---------|---------|---------|---------|---------|
|         |         |         |         |         |         |         |         |

Name





Signature

\_\_\_\_\_  
\_\_\_\_\_



## Tawastia Open Karate 2/2024 - 2024-10-05

## Official Results

| Kumite, miehet, +75kg |                 |                                     |   |               |
|-----------------------|-----------------|-------------------------------------|---|---------------|
| 1                     | SIMOLA TEEMU    | JAPAN KARATE ASSOCIATION TAMPERE RY |  | FIN - FINLAND |
| 2                     | HÄRKÖNEN JARNO  | OUTOKUMMUN KARATESEURA RY           |  | FIN - FINLAND |
| 3                     | VÄLIMÄKI RISTO  | LEMPÄÄLÄN SHOTOKAN KARATE           |  | FIN - FINLAND |
| 4                     | SURA JUHA-PEKKA | FORSSAN-TAMMELAN JUNDOKAN RY        |  | FIN - FINLAND |



KUMITE, MIEHET, -75KG  
YHDISTETTY

Tawastia Open Karate 2/2024

**ENTRIES BY WEIGHT CATEGORY**  
**Kumite, miehet, -75kg yhdistetty**

As of 6 OCT 2024

| Country Code | ID | Gender | Name                   | Seeding |
|--------------|----|--------|------------------------|---------|
| FIN          |    | M      | Banauliker Kartik-Otto |         |
| FIN          |    | M      | Hnninen Aarni          |         |
| FIN          |    | M      | Hnninen Niilo          |         |
| FIN          |    | M      | Kamamoto Keishiro      |         |
| FIN          |    | M      | Peltola Veikko         |         |

# Kumite, miehet, -75kg yhdistetty

Tawastia Open Karate 2/2024, Liivuoventie 24, Hämeenlinna, FIN

2024-10-05

Tatami  
3 16:15

Pool  
1/1

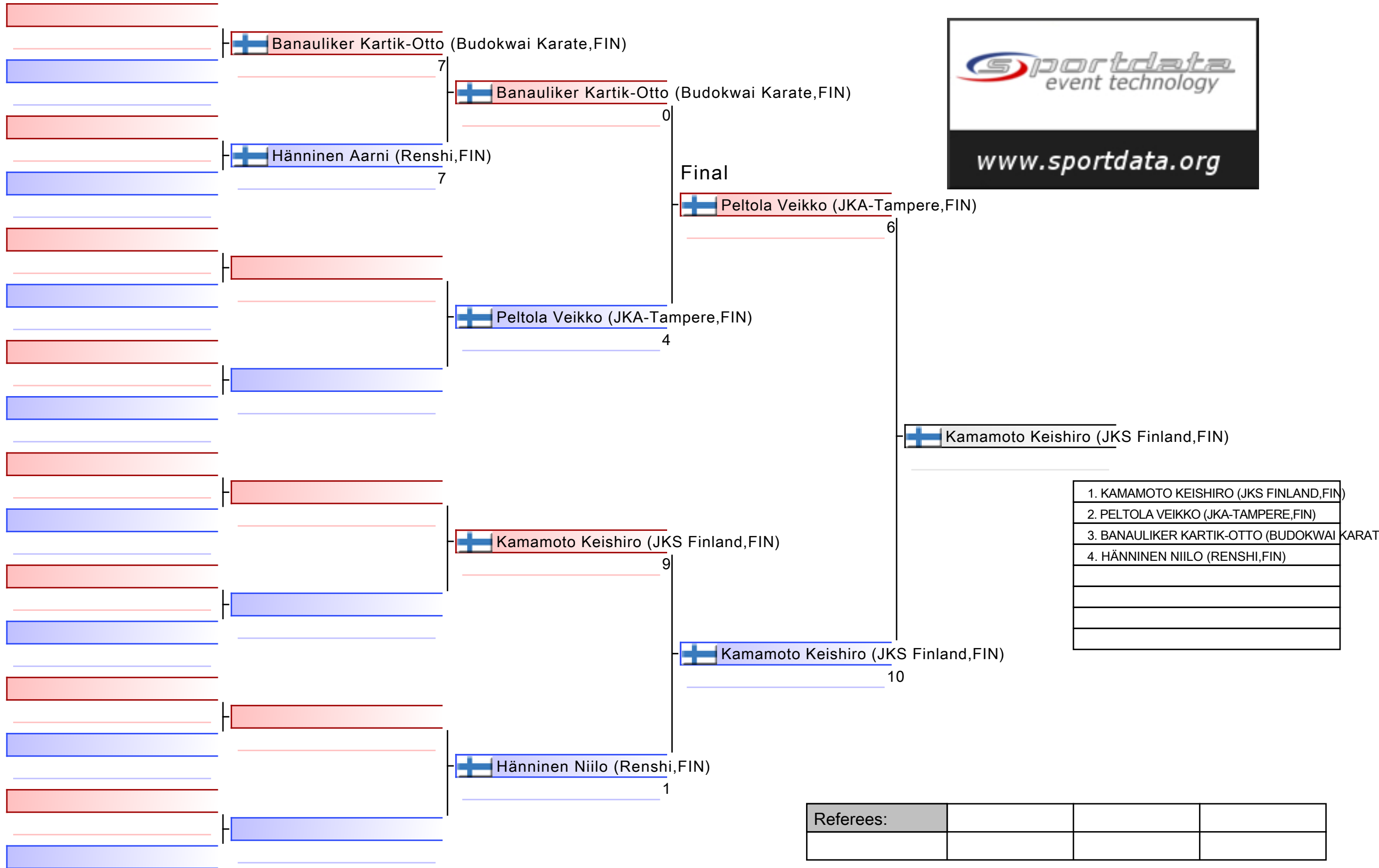

# Kumite, miehet, -75kg yhdistetty

Tawastia Open Karate 2/2024

2024-10-05

Tatami  
3 16:15

Pool  
1

(c)sportdata GmbH & Co KG 2000-2024 (2024-10-06 10:03) v 10.2.0 build 1 (2024-09-26 10:14 CET) License: Online\_Event\_ID-8546\_TawastiaOpenKarate2024 (expire 2024-10-20)

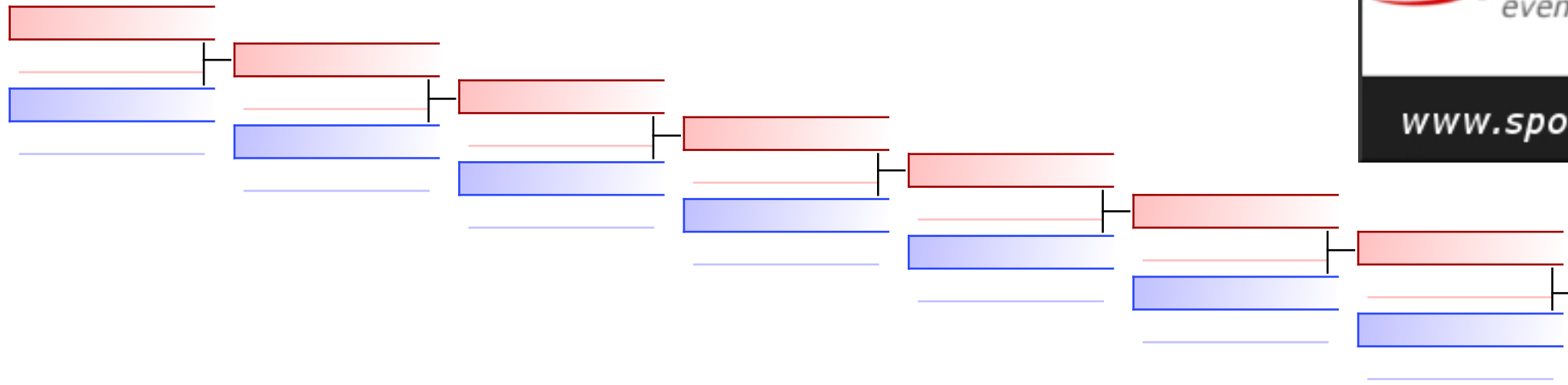

## REPECHAGE: (1)

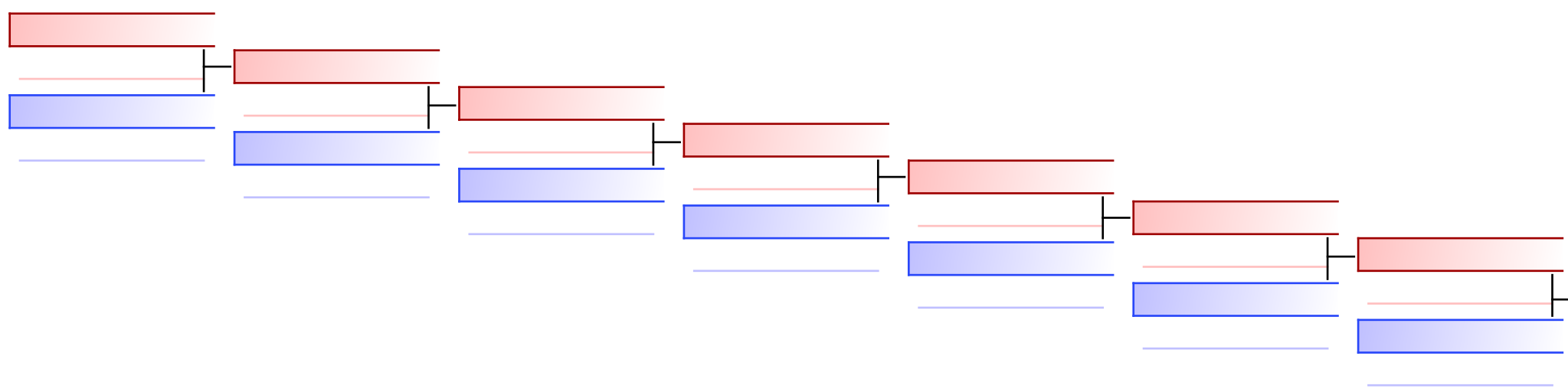

|                                 |   |
|---------------------------------|---|
| Banauliker Kartik-Otto (Budokw) | 1 |
| Hänninen Niilo (Renshi,FIN)     | 0 |

|           |  |  |  |  |  |  |  |
|-----------|--|--|--|--|--|--|--|
| Referees: |  |  |  |  |  |  |  |
|-----------|--|--|--|--|--|--|--|

# Tawastia Open Karate 2/2024

Liivuoventie 24, Hmeenlinna, FINLAND

|             |   |         |            |             |                            |                |    |
|-------------|---|---------|------------|-------------|----------------------------|----------------|----|
| Court Nr.   | 1   | Pool    | 1          | Date        | 2024-10-06                 | Field Position | 57 |
| <b>RED</b>  |   |         |            | <b>BLUE</b> |                            |                |    |
| NOC         | BANAULIKER KARTIK-OTTO<br>(BUDOKWAI KARATE,FIN) |         |            | NOC         | HNNINEN AARNI (RENSHI,FIN) |                |    |
| Category    | Kumite, miehet, -75kg yhdistetty                |         |            |             |                            |                |    |
| 3 Points    | 2 Points  | 1 Point | Score      | 1 Point     | 2 Points                   | 3 Points       |    |
|             |   |         | 7 : 7      |             |                            |                |    |
| Penatlity   |   |         |            | Penatlity   |                            |                |    |
| C1: C3, C2: |   |         | <b>7:7</b> | C1: , C2:   |                            |                |    |
| WINNER      |   |         | Total      |             |                            |                |    |

SEN

## Decision of Superiority

| Judge 1 | Judge 2 | Judge 3 | Judge 4 | Judge 5 | Judge 6 | Judge 7 | Referee |
|---------|---------|---------|---------|---------|---------|---------|---------|
|         |         |         |         |         |         |         |         |

Name

Signature

\_\_\_\_\_  
\_\_\_\_\_



# Tawastia Open Karate 2/2024

Liivuoventie 24, Hmeenlinna, FINLAND

|            |   |         |            |             |                                     |                |    |
|------------|---|---------|------------|-------------|-------------------------------------|----------------|----|
| Court Nr.  | 1   | Pool    | 1          | Date        | 2024-10-06                          | Field Position | 61 |
| <b>RED</b> |   |         |            | <b>BLUE</b> |                                     |                |    |
| NOC        | BANAULIKER KARTIK-OTTO<br>(BUDOKWAI KARATE,FIN) |         |            | NOC         | PELTOLA VEIKKO<br>(JKA-TAMPERE,FIN) |                |    |
| Category   | Kumite, miehet, -75kg yhdistetty                |         |            |             |                                     |                |    |
| 3 Points   | 2 Points  | 1 Point | Score      | 1 Point     | 2 Points                            | 3 Points       |    |
|            |   |         | 0 : 4      |             |                                     |                |    |
| Penatlity  |   |         |            | Penatlity   |                                     |                |    |
| C1: , C2:  |   |         | <b>0:4</b> | C1: C1, C2: |                                     |                |    |
|            |   |         | Total      | WINNER      |                                     |                |    |

PTS

## Decision of Superiority

|         |         |         |         |         |         |         |         |
|---------|---------|---------|---------|---------|---------|---------|---------|
| Judge 1 | Judge 2 | Judge 3 | Judge 4 | Judge 5 | Judge 6 | Judge 7 | Referee |
|         |         |         |         |         |         |         |         |

Name

Signature

\_\_\_\_\_  
\_\_\_\_\_



# Tawastia Open Karate 2/2024

Liivuoventie 24, Hmeenlinna, FINLAND

|             |                                     |         |            |             |                            |                |    |
|-------------|-------------------------------------|---------|------------|-------------|----------------------------|----------------|----|
| Court Nr.   | 1                                   | Pool    | 1          | Date        | 2024-10-06                 | Field Position | 62 |
| <b>RED</b>  |                                     |         |            | <b>BLUE</b> |                            |                |    |
| NOC         | KAMAMOTO KEISHIRO (JKS FINLAND,FIN) |         |            | NOC         | HNNINEN NIILO (RENSHI,FIN) |                |    |
| Category    | Kumite, miehet, -75kg yhdistetty    |         |            |             |                            |                |    |
| 3 Points    | 2 Points                            | 1 Point | Score      | 1 Point     | 2 Points                   | 3 Points       |    |
|             |                                     |         | 9 : 1      |             |                            |                |    |
| Penatlity   |                                     |         |            | Penatlity   |                            |                |    |
| C1: C1, C2: |                                     |         | <b>9:1</b> | C1: , C2:   |                            |                |    |
| WINNER      |                                     |         | Total      |             |                            |                |    |

PTS

## Decision of Superiority

| Judge 1 | Judge 2 | Judge 3 | Judge 4 | Judge 5 | Judge 6 | Judge 7 | Referee |
|---------|---------|---------|---------|---------|---------|---------|---------|
|         |         |         |         |         |         |         |         |

Name

Signature

\_\_\_\_\_  
\_\_\_\_\_



# Tawastia Open Karate 2/2024

Liivuoentie 24, Hmeenlinna, FINLAND

|            |                                  |         |             |             |                                     |                |    |
|------------|----------------------------------|---------|-------------|-------------|-------------------------------------|----------------|----|
| Court Nr.  | 1                                | Pool    | 1           | Date        | 2024-10-06                          | Field Position | 63 |
| <b>RED</b> |                                  |         |             | <b>BLUE</b> |                                     |                |    |
| NOC        | PELTOLA VEIKKO (JKA-TAMPERE,FIN) |         |             | NOC         | KAMAMOTO KEISHIRO (JKS FINLAND,FIN) |                |    |
| Category   | Kumite, miehet, -75kg yhdistetty |         |             |             |                                     |                |    |
| 3 Points   | 2 Points                         | 1 Point | Score       | 1 Point     | 2 Points                            | 3 Points       |    |
|            |                                  |         | 6 : 10      |             |                                     |                |    |
| Penatlity  |                                  |         |             | Penatlity   |                                     |                |    |
| C1: , C2:  |                                  |         | <b>6:10</b> | C1: C1, C2: |                                     |                |    |
|            |                                  |         | Total       | WINNER      |                                     |                |    |

PTS

## Decision of Superiority

|         |         |         |         |         |         |         |         |
|---------|---------|---------|---------|---------|---------|---------|---------|
| Judge 1 | Judge 2 | Judge 3 | Judge 4 | Judge 5 | Judge 6 | Judge 7 | Referee |
|         |         |         |         |         |         |         |         |

Name

Signature

\_\_\_\_\_  
\_\_\_\_\_











## Tawastia Open Karate 2/2024 - 2024-10-05

## Official Results

| Kumite, miehet, -75kg yhdistetty |                        |  |   |               |  |
|----------------------------------|------------------------|--|---|---------------|--|
| 1                                | KAMAMOTO KEISHIRO      | JKS FINLAND -<br>SHOTOKAN KARATE<br>HELSINKI |  | FIN - FINLAND |  |
| 2                                | PELTOLA VEIKKO         | JAPAN KARATE<br>ASSOCIATION<br>TAMPERE RY    |  | FIN - FINLAND |  |
| 3                                | BANAULIKER KARTIK-OTTO | BUDOKWAI RY<br>KARATE                        |  | FIN - FINLAND |  |
| 4                                | HÄNNINEN NIILLO        | RENSHIN-KAN RY                               |  | FIN - FINLAND |  |

KUMITE, MIEHET, -84KG, +35-V  
YHDISTETTY

Tawastia Open Karate 2/2024

**ENTRIES BY WEIGHT CATEGORY**  
Kumite, miehet, -84kg, +35-v yhdistetty

As of 6 OCT 2024

| Country Code | ID | Gender | Name         | Seeding |
|--------------|----|--------|--------------|---------|
| FIN          |    | M      | Luukka Eki   |         |
| FIN          |    | M      | Turunen Timo |         |

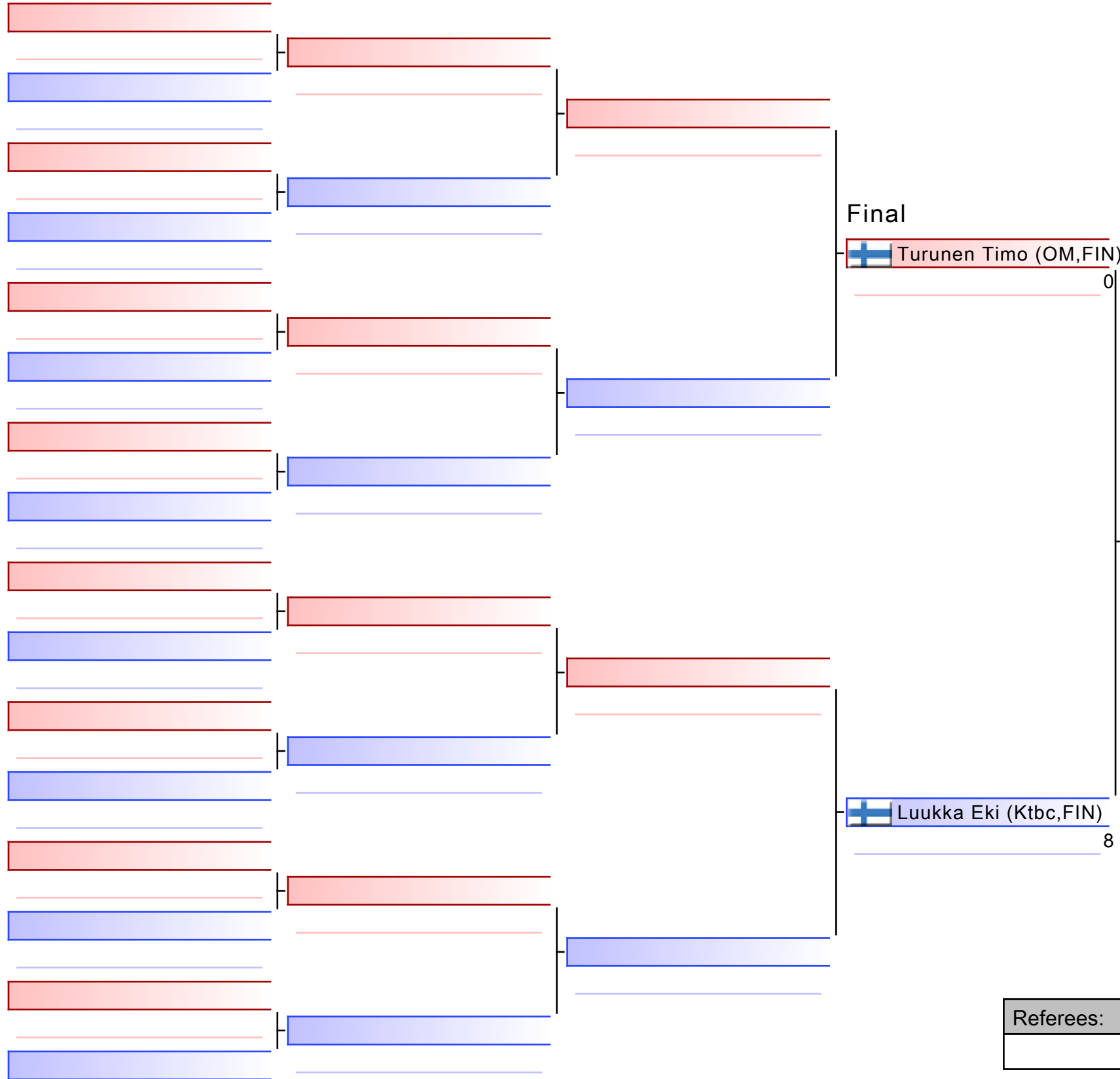

Luukka Eki (Ktbc,FIN)

|                          |
|--------------------------|
| 1. LUUKKA EKI (KTBC,FIN) |
| 2. TURUNEN TIMO (OM,FIN) |
|                          |
|                          |
|                          |
|                          |
|                          |

|           |  |  |  |
|-----------|--|--|--|
| Referees: |  |  |  |
|           |  |  |  |

# Tawastia Open Karate 2/2024

Liivuoentie 24, Hmeenlinna, FINLAND

|             |   |         |            |             |                       |                |    |
|-------------|---|---------|------------|-------------|-----------------------|----------------|----|
| Court Nr.   | 1                                       | Pool    | 1          | Date        | 2024-10-06            | Field Position | 63 |
| <b>RED</b>  |   |         |            | <b>BLUE</b> |                       |                |    |
| NOC         | TURUNEN TIMO (OM,FIN)                   |         |            | NOC         | LUUKKA EKI (KTBC,FIN) |                |    |
| Category    | Kumite, miehet, -84kg, +35-v yhdistetty |         |            |             |                       |                |    |
| 3 Points    | 2 Points                                | 1 Point | Score      | 1 Point     | 2 Points              | 3 Points       |    |
|             |   |         | 0 : 8      |             |                       |                |    |
| Penatlity   |   |         |            | Penatlity   |                       |                |    |
| C1: C1, C2: |   |         | <b>0:8</b> | C1: , C2:   |                       |                |    |
|             |   |         | Total      | WINNER      |                       |                |    |

PTS

## Decision of Superiority

| Judge 1 | Judge 2 | Judge 3 | Judge 4 | Judge 5 | Judge 6 | Judge 7 | Referee |
|---------|---------|---------|---------|---------|---------|---------|---------|
|         |         |         |         |         |         |         |         |



Name

Signature

\_\_\_\_\_  
\_\_\_\_\_



Official Results

| Kumite, miehet, -84kg, +35-v yhdistetty |              |                       |   |               |
|---|--------------|-----------------------|---|---------------|
| 1                                       | LUUKKA EKI   | KOTKA THAIBOXING CLUB |  | FIN - FINLAND |
| 2                                       | TURUNEN TIMO | SPORTSKARATE KUOPIO   |  | FIN - FINLAND |

# KUMITE, MIEHET, U21, -75 KG



Tawastia Open Karate 2/2024

**ENTRIES BY WEIGHT CATEGORY**  
**Kumite, miehet, U21, -75 kg**

As of 6 OCT 2024

| Country Code | ID | Gender | Name                   | Seeding |
|--------------|----|--------|------------------------|---------|
| FIN          |    | M      | Banauliker Kartik-Otto |         |
| FIN          |    | M      | Hnninen Aarni          |         |
| FIN          |    | M      | Hnninen Niilo          |         |

# Kumite, miehet, U21, -75 kg - Round Robin (each against each)

Tawastia Open Karate 2/2024, Liivourentie 24, Hämeenlinna, FIN













2024-10-05

Tatami

3 15:45

Pool

1/1

- 1  Hänninen Aarni (Renshi,FIN) 6
-  Hänninen Aarni (Renshi,FIN)
- 2  Banauliker Kartik-Otto (Budokwai Karate,FIN) 5
-  Hänninen Aarni (Renshi,FIN)
- 3  Hänninen Aarni (Renshi,FIN) 6
-  Hänninen Aarni (Renshi,FIN)
- 4  Hänninen Niilo (Renshi,FIN) 2
-  Banauliker Kartik-Otto (Budokwai Karate,FIN)
- 5  Banauliker Kartik-Otto (Budokwai Karate,FIN) 5
-  Banauliker Kartik-Otto (Budokwai Karate,FIN)
- 6  Hänninen Niilo (Renshi,FIN) 1
-  Hänninen Niilo (Renshi,FIN)



|   |
|---|
| 1. HÄNNINEN AARNI (RENSHI,FIN)                  |
| 2. BANAUЛИKER KARTIK-OTTO (BUDOKWAI KARATE,FIN) |
| 3. HÄNNINEN NIILLO (RENSHI,FIN)                 |
|   |
|   |
|   |
|   |

|           |  |  |  |
|-----------|--|--|--|
| Referees: |  |  |  |
|           |  |  |  |

# Tawastia Open Karate 2/2024

Liivuoentie 24, Hmeenlinna, FINLAND

|            |                             |         |            |             |  |                |       |
|------------|-----------------------------|---------|------------|-------------|--|----------------|-------|
| Court Nr.  | 1                           | Pool    | 1          | Date        | 2024-10-06                                   | Field Position | -9951 |
| <b>RED</b> |                             |         |            | <b>BLUE</b> |  |                |       |
| NOC        | HNNINEN AARNI (RENSHI,FIN)  |         |            | NOC         | BANAULIKER KARTIK-OTTO (BUDOKWAI KARATE,FIN) |                |       |
| Category   | Kumite, miehet, U21, -75 kg |         |            |             |  |                |       |
| 3 Points   | 2 Points                    | 1 Point | Score      | 1 Point     | 2 Points                                     | 3 Points       |       |
|            |                             |         | 6 : 5      |             |  |                |       |
| Penatlity  |                             |         |            | Penatlity   |  |                |       |
| C1: , C2:  |                             |         | <b>6:5</b> | C1: C1, C2: |  |                |       |
| WINNER     |                             |         | Total      |             |  |                |       |

PTS

## Decision of Superiority

| Judge 1 | Judge 2 | Judge 3 | Judge 4 | Judge 5 | Judge 6 | Judge 7 | Referee |
|---------|---------|---------|---------|---------|---------|---------|---------|
|         |         |         |         |         |         |         |         |

Name

Signature

\_\_\_\_\_  
\_\_\_\_\_



# Tawastia Open Karate 2/2024

Liivuoentie 24, Hmeenlinna, FINLAND

|             |                             |         |            |             |                            |                |       |
|-------------|-----------------------------|---------|------------|-------------|----------------------------|----------------|-------|
| Court Nr.   | 1                           | Pool    | 1          | Date        | 2024-10-06                 | Field Position | -9950 |
| <b>RED</b>  |                             |         |            | <b>BLUE</b> |                            |                |       |
| NOC         | HNNINEN AARNI (RENSHI,FIN)  |         |            | NOC         | HNNINEN NIILO (RENSHI,FIN) |                |       |
| Category    | Kumite, miehet, U21, -75 kg |         |            |             |                            |                |       |
| 3 Points    | 2 Points                    | 1 Point | Score      | 1 Point     | 2 Points                   | 3 Points       |       |
|             |                             |         | 6 : 2      |             |                            |                |       |
| Penatlity   |                             |         |            | Penatlity   |                            |                |       |
| C1: C1, C2: |                             |         | <b>6:2</b> | C1: , C2:   |                            |                |       |
| WINNER      |                             |         | Total      |             |                            |                |       |

PTS

## Decision of Superiority

| Judge 1 | Judge 2 | Judge 3 | Judge 4 | Judge 5 | Judge 6 | Judge 7 | Referee |
|---------|---------|---------|---------|---------|---------|---------|---------|
|         |         |         |         |         |         |         |         |

Name

Signature

\_\_\_\_\_  
\_\_\_\_\_



# Tawastia Open Karate 2/2024

Liivuoentie 24, Hmeenlinna, FINLAND

|             |   |         |            |             |                            |                |       |
|-------------|---|---------|------------|-------------|----------------------------|----------------|-------|
| Court Nr.   | 1   | Pool    | 1          | Date        | 2024-10-06                 | Field Position | -9949 |
| <b>RED</b>  |   |         |            | <b>BLUE</b> |                            |                |       |
| NOC         | BANAULIKER KARTIK-OTTO<br>(BUDOKWAI KARATE,FIN) |         |            | NOC         | HNNINEN NIILO (RENSHI,FIN) |                |       |
| Category    | Kumite, miehet, U21, -75 kg                     |         |            |             |                            |                |       |
| 3 Points    | 2 Points  | 1 Point | Score      | 1 Point     | 2 Points                   | 3 Points       |       |
|             |   |         | 5 : 1      |             |                            |                |       |
| Penatlity   |   |         |            | Penatlity   |                            |                |       |
| C1: C2, C2: |   |         | <b>5:1</b> | C1: , C2:   |                            |                |       |
| WINNER      |   |         | Total      |             |                            |                |       |

PTS

## Decision of Superiority

| Judge 1 | Judge 2 | Judge 3 | Judge 4 | Judge 5 | Judge 6 | Judge 7 | Referee |
|---------|---------|---------|---------|---------|---------|---------|---------|
|         |         |         |         |         |         |         |         |

Name



Signature

\_\_\_\_\_  
\_\_\_\_\_



Tawastia Open Karate 2/2024 - 2024-10-05

Official Results

| Kumite, miehet, U21, -75 kg |                        |                       |   |               |
|-----------------------------|------------------------|-----------------------|---|---------------|
| 1                           | HÄNNINEN AARNI         | RENSHIN-KAN RY        |  | FIN - FINLAND |
| 2                           | BANAULIKER KARTIK-OTTO | BUDOKWAI RY<br>KARATE |  | FIN - FINLAND |
| 3                           | HÄNNINEN NIILLO        | RENSHIN-KAN RY        |  | FIN - FINLAND |

# KUMITE, MIEHET, U21, -84 KG

Tawastia Open Karate 2/2024

**ENTRIES BY WEIGHT CATEGORY**  
**Kumite, miehet, U21, -84 kg**

As of 6 OCT 2024

| Country Code | ID | Gender | Name            | Seeding |
|--------------|----|--------|-----------------|---------|
| FIN          |    | M      | Mantere Jimi    |         |
| FIN          |    | M      | Nuhanovic Alsad |         |
| FIN          |    | M      | Paukkola Nooa   |         |



# Kumite, miehet, U21, -84 kg - Round Robin (each against each)

Tawastia Open Karate 2/2024, Liivourentie 24, Hämeenlinna, FIN









2024-10-05

Tatami

3 16:00

Pool

1/1

|   |  |   |  |
|---|--|---|--|
| 1 |  Nuhanovic Alsad (JKA-Tampere,FIN) | 0 |  Mantere Jimi (HKS,FIN)     |
| 2 |  Mantere Jimi (HKS,FIN)            | 3 |  |
| 3 |  Nuhanovic Alsad (JKA-Tampere,FIN) | 0 |  Paukkola Nooa (LK-FIN,FIN) |
| 4 |  Paukkola Nooa (LK-FIN,FIN)        | 1 |  |
| 5 |  Mantere Jimi (HKS,FIN)            | 1 |  Paukkola Nooa (LK-FIN,FIN) |
| 6 |  Paukkola Nooa (LK-FIN,FIN)        | 1 |  |



|                                      |
|--------------------------------------|
| 1. PAUKKOLA NOOA (LK-FIN,FIN)        |
| 2. MANTERE JIMI (HKS,FIN)            |
| 3. NUHANOVIC ALSAD (JKA-TAMPERE,FIN) |
|                                      |
|                                      |
|                                      |
|                                      |

|           |  |  |  |
|-----------|--|--|--|
| Referees: |  |  |  |
|           |  |  |  |

# Tawastia Open Karate 2/2024

Liivuoentie 24, Hmeenlinna, FINLAND

|            |                                      |         |            |             |                        |                |       |
|------------|--------------------------------------|---------|------------|-------------|------------------------|----------------|-------|
| Court Nr.  | 1                                    | Pool    | 1          | Date        | 2024-10-06             | Field Position | -9951 |
| <b>RED</b> |                                      |         |            | <b>BLUE</b> |                        |                |       |
| NOC        | NUHANOVIC ALSAD<br>(JKA-TAMPERE,FIN) |         |            | NOC         | MANTERE JIMI (HKS,FIN) |                |       |
| Category   | Kumite, miehet, U21, -84 kg          |         |            |             |                        |                |       |
| 3 Points   | 2 Points                             | 1 Point | Score      | 1 Point     | 2 Points               | 3 Points       |       |
|            |                                      |         | 0 : 3      |             |                        |                |       |
| Penatlity  |                                      |         |            | Penatlity   |                        |                |       |
| C1: , C2:  |                                      |         | <b>0:3</b> | C1: C1, C2: |                        |                |       |
|            |                                      |         | Total      | WINNER      |                        |                |       |

PTS

## Decision of Superiority

| Judge 1 | Judge 2 | Judge 3 | Judge 4 | Judge 5 | Judge 6 | Judge 7 | Referee |
|---------|---------|---------|---------|---------|---------|---------|---------|
|         |         |         |         |         |         |         |         |

Name

Signature

\_\_\_\_\_  
\_\_\_\_\_



# Tawastia Open Karate 2/2024

Liivuoentie 24, Hmeenlinna, FINLAND

|             |                                      |         |            |             |                            |                |       |
|-------------|--------------------------------------|---------|------------|-------------|----------------------------|----------------|-------|
| Court Nr.   | 1                                    | Pool    | 1          | Date        | 2024-10-06                 | Field Position | -9950 |
| <b>RED</b>  |                                      |         |            | <b>BLUE</b> |                            |                |       |
| NOC         | NUHANOVIC ALSAD<br>(JKA-TAMPERE,FIN) |         |            | NOC         | PAUKKOLA NOOA (LK-FIN,FIN) |                |       |
| Category    | Kumite, miehet, U21, -84 kg          |         |            |             |                            |                |       |
| 3 Points    | 2 Points                             | 1 Point | Score      | 1 Point     | 2 Points                   | 3 Points       |       |
|             |                                      |         | 0 : 1      |             |                            |                |       |
| Penatlity   |                                      |         |            | Penatlity   |                            |                |       |
| C1: C1, C2: |                                      |         | <b>0:1</b> | C1: C1, C2: |                            |                |       |
|             |                                      |         | Total      | WINNER      |                            |                |       |

PTS

## Decision of Superiority

| Judge 1 | Judge 2 | Judge 3 | Judge 4 | Judge 5 | Judge 6 | Judge 7 | Referee |
|---------|---------|---------|---------|---------|---------|---------|---------|
|         |         |         |         |         |         |         |         |

Name

Signature

\_\_\_\_\_  
\_\_\_\_\_



# Tawastia Open Karate 2/2024

Liivuoentie 24, Hmeenlinna, FINLAND

|            |                             |         |            |             |                            |                |       |
|------------|-----------------------------|---------|------------|-------------|----------------------------|----------------|-------|
| Court Nr.  | 1                           | Pool    | 1          | Date        | 2024-10-06                 | Field Position | -9949 |
| <b>RED</b> |                             |         |            | <b>BLUE</b> |                            |                |       |
| NOC        | MANTERE JIMI (HKS,FIN)      |         |            | NOC         | PAUKKOLA NOOA (LK-FIN,FIN) |                |       |
| Category   | Kumite, miehet, U21, -84 kg |         |            |             |                            |                |       |
| 3 Points   | 2 Points                    | 1 Point | Score      | 1 Point     | 2 Points                   | 3 Points       |       |
|            |                             |         | 1 : 1      |             |                            |                |       |
| Penatlity  |                             |         |            | Penatlity   |                            |                |       |
| C1: , C2:  |                             |         | <b>1:1</b> | C1: C1, C2: |                            |                |       |
|            |                             |         | Total      | WINNER      |                            |                |       |

SEN

## Decision of Superiority

| Judge 1 | Judge 2 | Judge 3 | Judge 4 | Judge 5 | Judge 6 | Judge 7 | Referee |
|---------|---------|---------|---------|---------|---------|---------|---------|
|         |         |         |         |         |         |         |         |

Name



Signature

\_\_\_\_\_  
\_\_\_\_\_



## Tawastia Open Karate 2/2024 - 2024-10-05

## Official Results

| Kumite, miehet, U21, -84 kg |                 |   |   |               |
|-----------------------------|-----------------|---|---|---------------|
| 1                           | PAUKKOLA NOOA   | LAHDEN KARATE                             |  | FIN - FINLAND |
| 2                           | MANTERE JIMI    | HÄMEENLINNAN<br>KARATESEURA               |  | FIN - FINLAND |
| 3                           | NUHANOVIC ALSAD | JAPAN KARATE<br>ASSOCIATION<br>TAMPERE RY |  | FIN - FINLAND |

# KUMITE, MIEHET, AVOIN

Tawastia Open Karate 2/2024

**ENTRIES BY WEIGHT CATEGORY**  
**Kumite, miehet, avoin**

As of 6 OCT 2024

| Country Code | ID | Gender | Name              | Seeding |
|--------------|----|--------|-------------------|---------|
| FIN          |    | M      | Kamamoto Keishiro |         |
| FIN          |    | M      | Paukkola Nooa     |         |
| FIN          |    | M      | Simola Teemu      |         |
| FIN          |    | M      | Sura Juha-Pekka   |         |
| FIN          |    | M      | Vink Jeffrey      |         |

# Kumite, miehet, avoin

Tawastia Open Karate 2/2024, Liivuoventie 24, Hämeenlinna, FIN

2024-10-05

Tatami  
3 17:25

Pool  
1/1

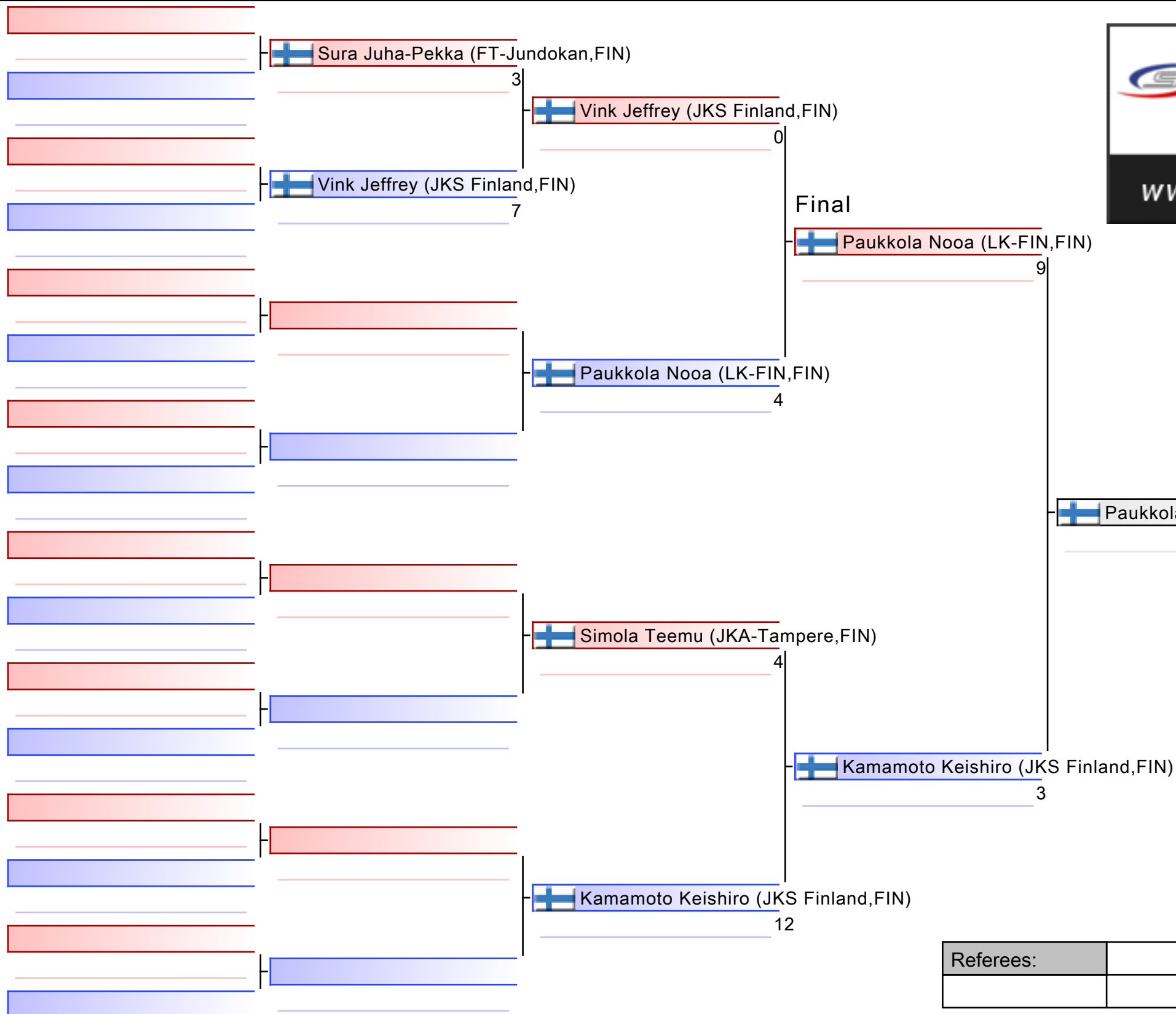

|  |
|--|
| 1. PAUKKOLA NOOA (LK-FIN,FIN)          |
| 2. KAMAMOTO KEISHIRO (JKS FINLAND,FIN) |
| 3. VINK JEFFREY (JKS FINLAND,FIN)      |
| 4. SIMOLA TEEMU (JKA-TAMPERE,FIN)      |
| 5. SURA JUHA-PEKKA (FT-JUNDOKAN,FIN)   |
|  |
|  |

|           |  |  |  |
|-----------|--|--|--|
| Referees: |  |  |  |
|           |  |  |  |



# Kumite, miehet, avoin

Tawastia Open Karate 2/2024

2024-10-05

Tatami

3 17:25

Pool

1

(c)sportdata GmbH & Co KG 2000-2024 (2024-10-06 10:03) v 10.2.0 build 1 (2024-09-26 10:14 CET) License: Online\_Event\_ID-8546\_TawastiaOpenKarate2024 (expire 2024-10-20)

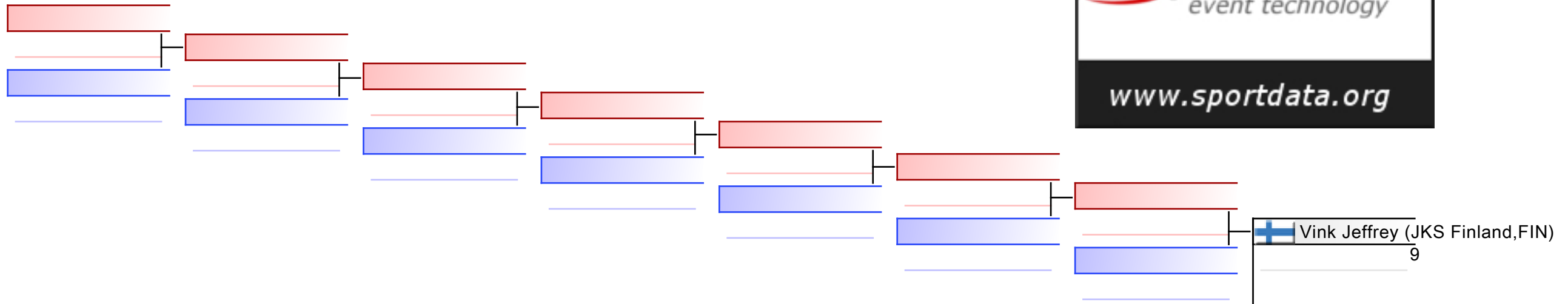

## REPECHAGE: (1)

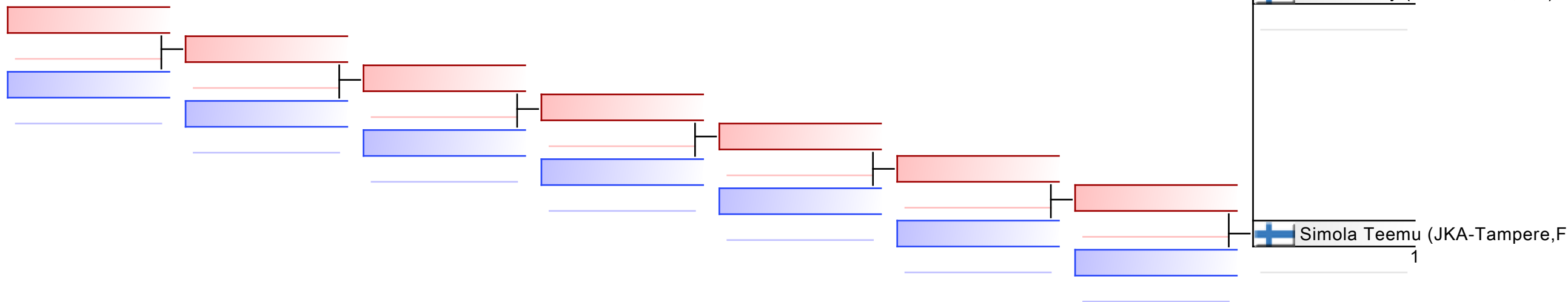

|           |  |  |  |  |  |  |  |
|-----------|--|--|--|--|--|--|--|
| Referees: |  |  |  |  |  |  |  |
|-----------|--|--|--|--|--|--|--|

# Tawastia Open Karate 2/2024

Liivuoentie 24, Hmeenlinna, FINLAND

|             |                                      |         |            |             |                                |                |    |
|-------------|--------------------------------------|---------|------------|-------------|--------------------------------|----------------|----|
| Court Nr.   | 1                                    | Pool    | 1          | Date        | 2024-10-06                     | Field Position | 57 |
| <b>RED</b>  |                                      |         |            | <b>BLUE</b> |                                |                |    |
| NOC         | SURA JUHA-PEKKA<br>(FT-JUNDOKAN,FIN) |         |            | NOC         | VINK JEFFREY (JKS FINLAND,FIN) |                |    |
| Category    | Kumite, miehet, avoin                |         |            |             |                                |                |    |
| 3 Points    | 2 Points                             | 1 Point | Score      | 1 Point     | 2 Points                       | 3 Points       |    |
|             |                                      |         | 3 : 7      |             |                                |                |    |
| Penatlity   |                                      |         |            | Penatlity   |                                |                |    |
| C1: HC, C2: |                                      |         | <b>3:7</b> | C1: , C2:   |                                |                |    |
|             |                                      |         | Total      | WINNER      |                                |                |    |

PTS

## Decision of Superiority

| Judge 1 | Judge 2 | Judge 3 | Judge 4 | Judge 5 | Judge 6 | Judge 7 | Referee |
|---------|---------|---------|---------|---------|---------|---------|---------|
|         |         |         |         |         |         |         |         |

Name

Signature

\_\_\_\_\_  
\_\_\_\_\_



# Tawastia Open Karate 2/2024

Liivuoentie 24, Hmeenlinna, FINLAND

|             |                                |         |            |             |                            |                |    |
|-------------|--------------------------------|---------|------------|-------------|----------------------------|----------------|----|
| Court Nr.   | 1                              | Pool    | 1          | Date        | 2024-10-06                 | Field Position | 61 |
| <b>RED</b>  |                                |         |            | <b>BLUE</b> |                            |                |    |
| NOC         | VINK JEFFREY (JKS FINLAND,FIN) |         |            | NOC         | PAUKKOLA NOOA (LK-FIN,FIN) |                |    |
| Category    | Kumite, miehet, avoin          |         |            |             |                            |                |    |
| 3 Points    | 2 Points                       | 1 Point | Score      | 1 Point     | 2 Points                   | 3 Points       |    |
|             |                                |         | 0 : 4      |             |                            |                |    |
| Penatlity   |                                |         |            | Penatlity   |                            |                |    |
| C1: HC, C2: |                                |         | <b>0:4</b> | C1: , C2:   |                            |                |    |
|             |                                |         | Total      | WINNER      |                            |                |    |

PTS

## Decision of Superiority

| Judge 1 | Judge 2 | Judge 3 | Judge 4 | Judge 5 | Judge 6 | Judge 7 | Referee |
|---------|---------|---------|---------|---------|---------|---------|---------|
|         |         |         |         |         |         |         |         |

Name

Signature

\_\_\_\_\_  
\_\_\_\_\_



# Tawastia Open Karate 2/2024

Liivuoentie 24, Hmeenlinna, FINLAND

|             |                                |         |        |             |                                     |                |    |
|-------------|--------------------------------|---------|--------|-------------|-------------------------------------|----------------|----|
| Court Nr.   | 1                              | Pool    | 1      | Date        | 2024-10-06                          | Field Position | 62 |
| <b>RED</b>  |                                |         |        | <b>BLUE</b> |                                     |                |    |
| NOC         | SIMOLA TEEMU (JKA-TAMPERE,FIN) |         |        | NOC         | KAMAMOTO KEISHIRO (JKS FINLAND,FIN) |                |    |
| Category    | Kumite, miehet, avoin          |         |        |             |                                     |                |    |
| 3 Points    | 2 Points                       | 1 Point | Score  | 1 Point     | 2 Points                            | 3 Points       |    |
|             |                                |         | 4 : 12 |             |                                     |                |    |
| Penatlity   |                                |         |        | Penatlity   |                                     |                |    |
| C1: C1, C2: |                                |         |        | <b>4:12</b> | C1: C2, C2:                         |                |    |
|             |                                |         |        | Total       | WINNER                              |                |    |

PTS

## Decision of Superiority

|         |         |         |         |         |         |         |         |
|---------|---------|---------|---------|---------|---------|---------|---------|
| Judge 1 | Judge 2 | Judge 3 | Judge 4 | Judge 5 | Judge 6 | Judge 7 | Referee |
|         |         |         |         |         |         |         |         |

Name

Signature

\_\_\_\_\_  
\_\_\_\_\_



# Tawastia Open Karate 2/2024

Liivuoentie 24, Hmeenlinna, FINLAND

|             |                            |         |            |             |                                     |                |    |
|-------------|----------------------------|---------|------------|-------------|-------------------------------------|----------------|----|
| Court Nr.   | 1                          | Pool    | 1          | Date        | 2024-10-06                          | Field Position | 63 |
| <b>RED</b>  |                            |         |            | <b>BLUE</b> |                                     |                |    |
| NOC         | PAUKKOLA NOOA (LK-FIN,FIN) |         |            | NOC         | KAMAMOTO KEISHIRO (JKS FINLAND,FIN) |                |    |
| Category    | Kumite, miehet, avoin      |         |            |             |                                     |                |    |
| 3 Points    | 2 Points                   | 1 Point | Score      | 1 Point     | 2 Points                            | 3 Points       |    |
|             |                            |         | 9 : 3      |             |                                     |                |    |
| Penatlity   |                            |         |            | Penatlity   |                                     |                |    |
| C1: C1, C2: |                            |         | <b>9:3</b> | C1: C1, C2: |                                     |                |    |
| WINNER      |                            |         | Total      |             |                                     |                |    |

PTS

## Decision of Superiority

| Judge 1 | Judge 2 | Judge 3 | Judge 4 | Judge 5 | Judge 6 | Judge 7 | Referee |
|---------|---------|---------|---------|---------|---------|---------|---------|
|         |         |         |         |         |         |         |         |

Name \_\_\_\_\_

Signature \_\_\_\_\_





## Tawastia Open Karate 2/2024 - 2024-10-05

## Official Results

| Kumite, miehet, avoin |                   |  |   |               |
|-----------------------|-------------------|--|---|---------------|
| 1                     | PAUKKOLA NOOA     | LAHDEN KARATE                                |  | FIN - FINLAND |
| 2                     | KAMAMOTO KEISHIRO | JKS FINLAND -<br>SHOTOKAN KARATE<br>HELSINKI |  | FIN - FINLAND |
| 3                     | VINK JEFFREY      | JKS FINLAND -<br>SHOTOKAN KARATE<br>HELSINKI |  | FIN - FINLAND |
| 4                     | SIMOLA TEEMU      | JAPAN KARATE<br>ASSOCIATION<br>TAMPERE RY    |  | FIN - FINLAND |
| 5                     | SURA JUHA-PEKKA   | FORSSAN-<br>TAMMELAN<br>JUNDOKAN RY          |  | FIN - FINLAND |

KUMITE, NAISSET, U21, -68KG  
YHDISTETTY



Tawastia Open Karate 2/2024

**ENTRIES BY WEIGHT CATEGORY**  
**Kumite, naiset, U21, -68kg yhdistetty**

As of 6 OCT 2024

| Country Code | ID | Gender | Name           | Seeding |
|--------------|----|--------|----------------|---------|
| FIN          |    | F      | Koivula Sofia  |         |
| FIN          |    | F      | Saadaoui Sonya |         |

# Kumite, naiset, U21, -68kg yhdistetty

Tawastia Open Karate 2/2024, Liivourentie 24, Hämeenlinna, FIN

2024-10-05

Tatami

2 17:55

Pool

1/1

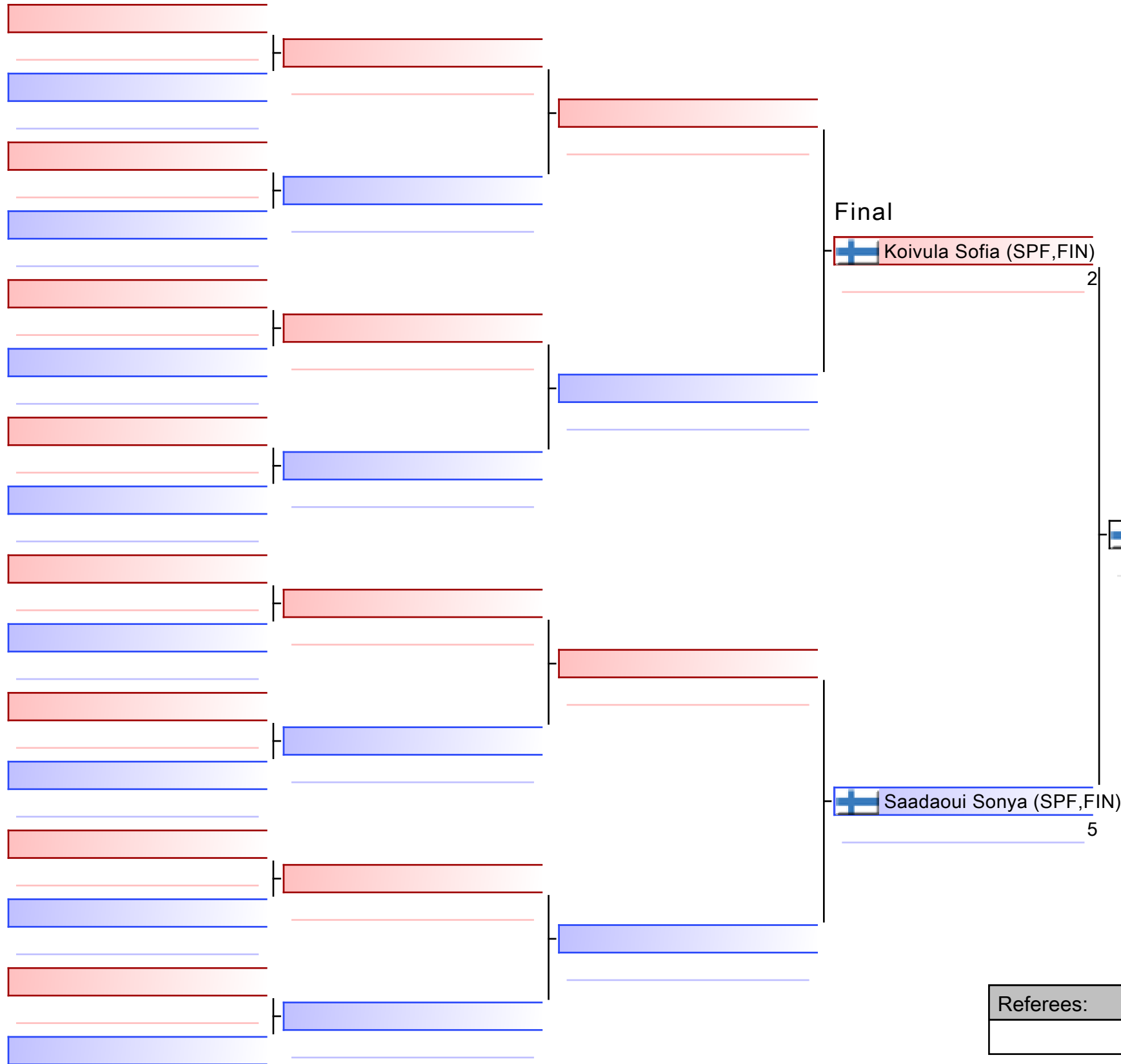

🇫🇮 Saadaoui Sonya (SPF,FIN)

|                             |
|-----------------------------|
| 1. SAADAQUI SONYA (SPF,FIN) |
| 2. KOIVULA SOFIA (SPF,FIN)  |
|                             |
|                             |
|                             |
|                             |
|                             |

|           |  |  |  |
|-----------|--|--|--|
| Referees: |  |  |  |
|           |  |  |  |

# Tawastia Open Karate 2/2024

Liivuoentie 24, Hmeenlinna, FINLAND

|             |                                       |         |            |             |                          |                |    |
|-------------|---------------------------------------|---------|------------|-------------|--------------------------|----------------|----|
| Court Nr.   | 1                                     | Pool    | 1          | Date        | 2024-10-06               | Field Position | 63 |
| <b>RED</b>  |                                       |         |            | <b>BLUE</b> |                          |                |    |
| NOC         | KOIVULA SOFIA (SPF,FIN)               |         |            | NOC         | SAADAQUI SONYA (SPF,FIN) |                |    |
| Category    | Kumite, naiset, U21, -68kg yhdistetty |         |            |             |                          |                |    |
| 3 Points    | 2 Points                              | 1 Point | Score      | 1 Point     | 2 Points                 | 3 Points       |    |
|             |                                       |         | 2 : 5      |             |                          |                |    |
| Penatlity   |                                       |         |            | Penatlity   |                          |                |    |
| C1: C1, C2: |                                       |         | <b>2:5</b> | C1: C1, C2: |                          |                |    |
|             |                                       |         | Total      | WINNER      |                          |                |    |

PTS

## Decision of Superiority

|         |         |         |         |         |         |         |         |
|---------|---------|---------|---------|---------|---------|---------|---------|
| Judge 1 | Judge 2 | Judge 3 | Judge 4 | Judge 5 | Judge 6 | Judge 7 | Referee |
|         |         |         |         |         |         |         |         |

Name



Signature

\_\_\_\_\_  
\_\_\_\_\_



Tawastia Open Karate 2/2024 - 2024-10-05

Official Results

| Kumite, naiset, U21, -68kg yhdistetty |                |                 |   |               |
|---------------------------------------|----------------|-----------------|---|---------------|
| 1                                     | SAADAOUI SONYA | SPORTSKARATE.FI |  | FIN - FINLAND |
| 2                                     | KOIVULA SOFIA  | SPORTSKARATE.FI |  | FIN - FINLAND |

# KUMITE, NAISSET, AVOIN

Tawastia Open Karate 2/2024

**ENTRIES BY WEIGHT CATEGORY**  
**Kumite, naiset, avoin**

As of 6 OCT 2024

| Country Code | ID | Gender | Name           | Seeding |
|--------------|----|--------|----------------|---------|
| FIN          |    | F      | Saadaoui Sonya |         |
| FIN          |    | F      | Yamate Sakino  |         |

# Kumite, naiset, avoin

Tawastia Open Karate 2/2024, Liivuoventie 24, Hämeenlinna, FIN

2024-10-05

Tatami  
2 18:15

Pool  
1/1

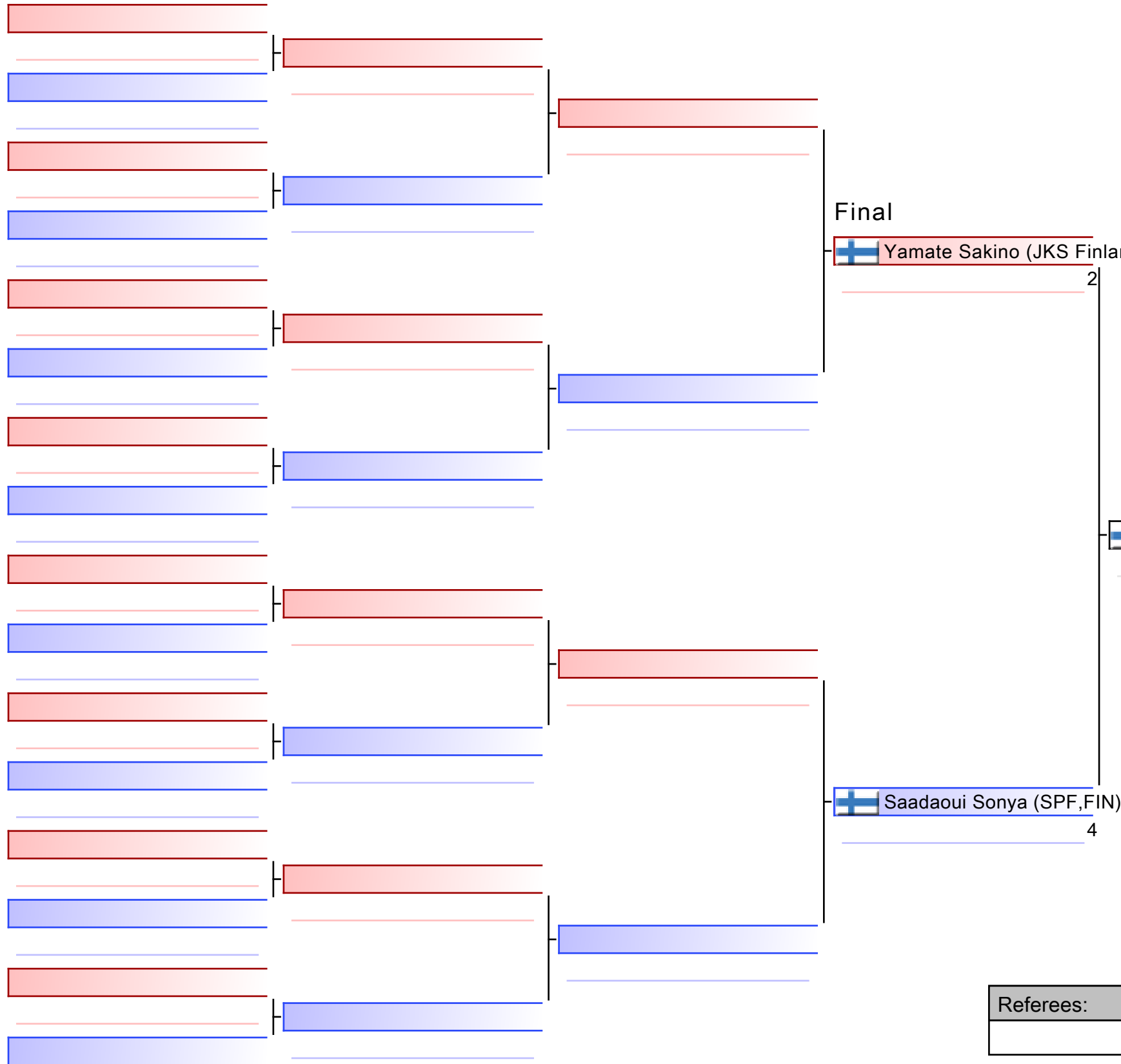

Final

Yamate Sakino (JKS Finland,FIN)

2

Saadaoui Sonya (SPF,FIN)

Saadaoui Sonya (SPF,FIN)

4

- |                                    |
|------------------------------------|
| 1. SAADAQUI SONYA (SPF,FIN)        |
| 2. YAMATE SAKINO (JKS FINLAND,FIN) |
|                                    |
|                                    |
|                                    |
|                                    |
|                                    |

|           |  |  |  |
|-----------|--|--|--|
| Referees: |  |  |  |
|           |  |  |  |

# Tawastia Open Karate 2/2024

Liivuoentie 24, Hmeenlinna, FINLAND

|            |                                 |         |            |             |                          |                |    |
|------------|---------------------------------|---------|------------|-------------|--------------------------|----------------|----|
| Court Nr.  | 1                               | Pool    | 1          | Date        | 2024-10-06               | Field Position | 63 |
| <b>RED</b> |                                 |         |            | <b>BLUE</b> |                          |                |    |
| NOC        | YAMATE SAKINO (JKS FINLAND,FIN) |         |            | NOC         | SAADAQUI SONYA (SPF,FIN) |                |    |
| Category   | Kumite, naiset, avoin           |         |            |             |                          |                |    |
| 3 Points   | 2 Points                        | 1 Point | Score      | 1 Point     | 2 Points                 | 3 Points       |    |
|            |                                 |         | 2 : 4      |             |                          |                |    |
| Penatlity  |                                 |         |            | Penatlity   |                          |                |    |
| C1: , C2:  |                                 |         | <b>2:4</b> | C1: , C2:   |                          |                |    |
|            |                                 |         | Total      | WINNER      |                          |                |    |

PTS

## Decision of Superiority

| Judge 1 | Judge 2 | Judge 3 | Judge 4 | Judge 5 | Judge 6 | Judge 7 | Referee |
|---------|---------|---------|---------|---------|---------|---------|---------|
|         |         |         |         |         |         |         |         |

Name

Signature



\_\_\_\_\_  
\_\_\_\_\_





Tawastia Open Karate 2/2024 - 2024-10-05

Official Results

| Kumite, naiset, avoin |                |  |   |               |
|-----------------------|----------------|--|---|---------------|
| 1                     | SAADAOUI SONYA | SPORTSKARATE.FI                              |  | FIN - FINLAND |
| 2                     | YAMATE SAKINO  | JKS FINLAND -<br>SHOTOKAN KARATE<br>HELSINKI |  | FIN - FINLAND |

# KUMITE, POJAT, U10

Tawastia Open Karate 2/2024

**ENTRIES BY WEIGHT CATEGORY**  
**Kumite, pojat, U10**

As of 6 OCT 2024

| Country Code | ID | Gender | Name              | Seeding |
|--------------|----|--------|-------------------|---------|
| FIN          |    | M      | Grosu Nicolas     |         |
| FIN          |    | M      | Larkin Chael      |         |
| FIN          |    | M      | Lunin Adrian      |         |
| FIN          |    | M      | Luukka Erno       |         |
| FIN          |    | M      | Ravyse Nathan     |         |
| FIN          |    | M      | Zafar Ahmed Hasan |         |

# Kumite, pojat, U10

Tawastia Open Karate 2/2024, Liivourentie 24, Hämeenlinna, FIN

2024-10-05

Tatami  
1 11:45

Pool  
1/1

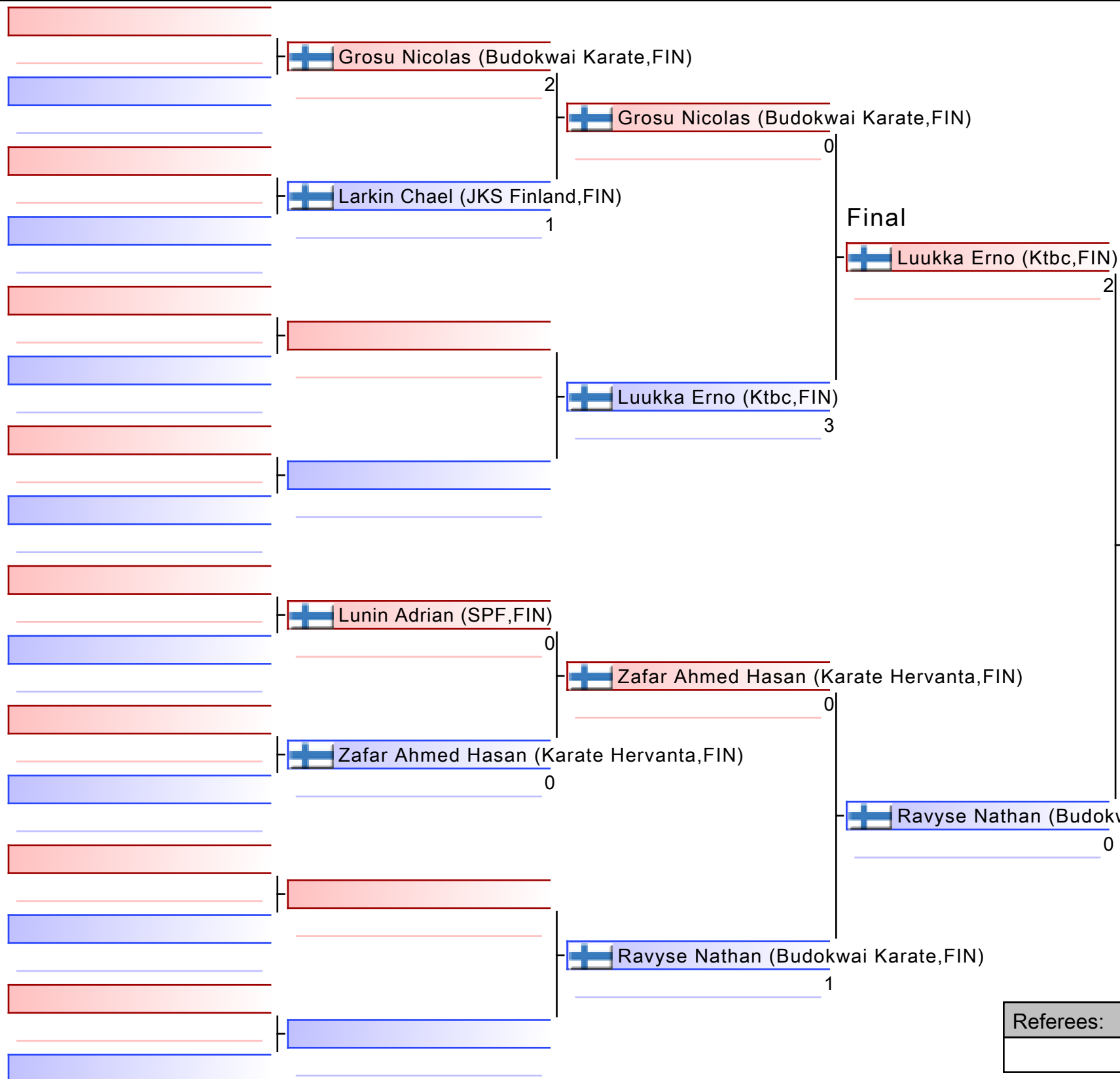



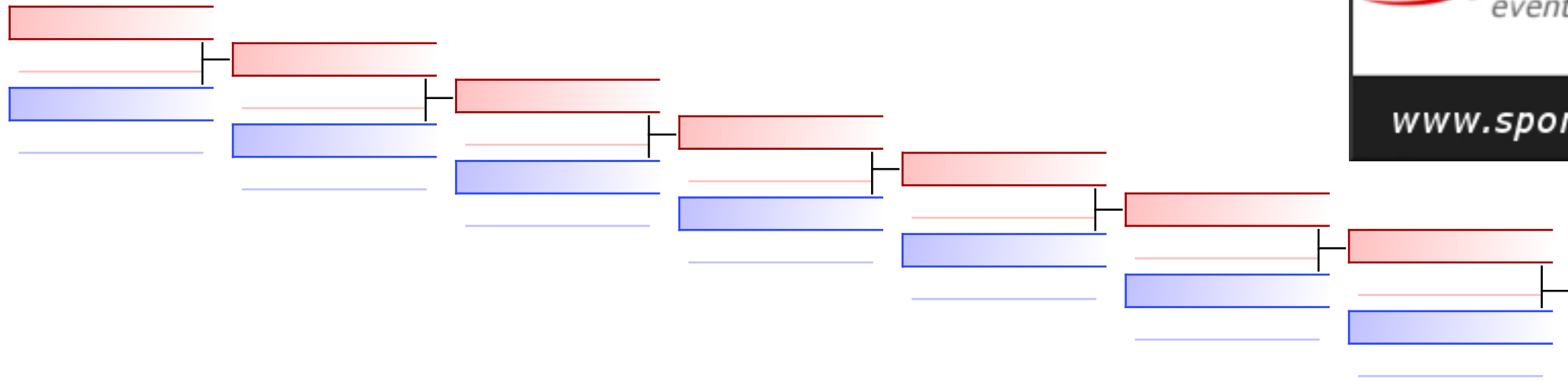

|  |
|--|
| 1. LUUKKA ERNO (KTBC,FIN)                  |
| 2. RAVYSE NATHAN (BUDOKWAI KARATE,FIN)     |
| 3. ZAFAR AHMED HASAN (KARATE HERVANTA,FIN) |
| 4. GROSU NICOLAS (BUDOKWAI KARATE,FIN)     |
|  |
|  |
|  |

|           |  |  |  |
|-----------|--|--|--|
| Referees: |  |  |  |
|           |  |  |  |

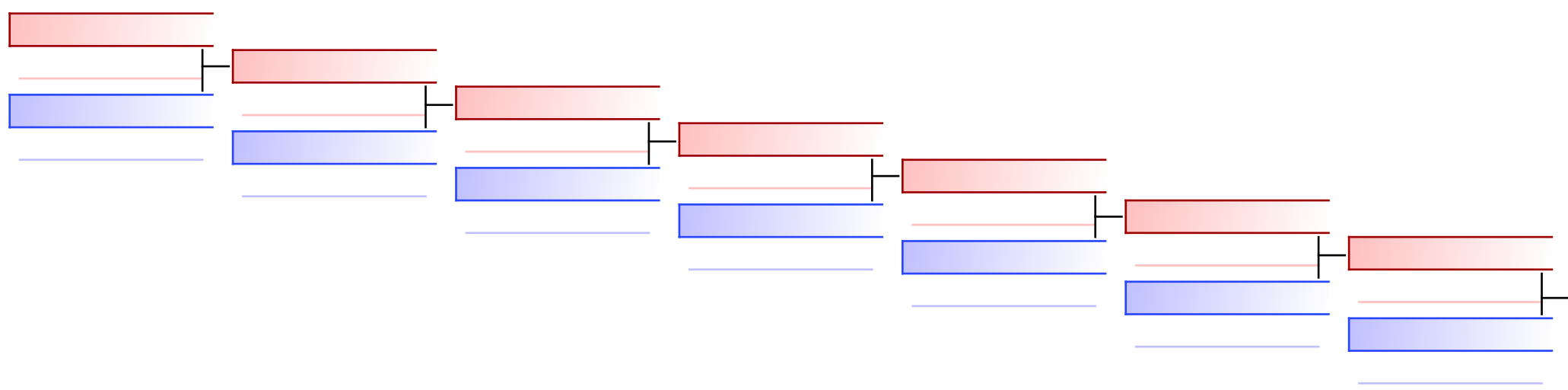

REPECHAGE: (1)



-  Grosu Nicolas (Budokwai Karate) 0
-  Zafar Ahmed Hasan (Karate He) 1
-  Zafar Ahmed Hasan (Karate He) 2

|           |  |  |  |  |  |  |  |
|-----------|--|--|--|--|--|--|--|
| Referees: |  |  |  |  |  |  |  |
|-----------|--|--|--|--|--|--|--|

# Tawastia Open Karate 2/2024

Liivuoentie 24, Hmeenlinna, FINLAND

|             |                                     |         |            |             |                                |                |    |
|-------------|-------------------------------------|---------|------------|-------------|--------------------------------|----------------|----|
| Court Nr.   | 1                                   | Pool    | 1          | Date        | 2024-10-06                     | Field Position | 57 |
| <b>RED</b>  |                                     |         |            | <b>BLUE</b> |                                |                |    |
| NOC         | GROSU NICOLAS (BUDOKWAI KARATE,FIN) |         |            | NOC         | LARKIN CHAEL (JKS FINLAND,FIN) |                |    |
| Category    | Kumite, pojat, U10                  |         |            |             |                                |                |    |
| 3 Points    | 2 Points                            | 1 Point | Score      | 1 Point     | 2 Points                       | 3 Points       |    |
|             |                                     |         | 2 : 1      |             |                                |                |    |
| Penatlity   |                                     |         |            | Penatlity   |                                |                |    |
| C1: C3, C2: |                                     |         | <b>2:1</b> | C1: C1, C2: |                                |                |    |
| WINNER      |                                     |         | Total      |             |                                |                |    |

PTS

## Decision of Superiority

| Judge 1 | Judge 2 | Judge 3 | Judge 4 | Judge 5 | Judge 6 | Judge 7 | Referee |
|---------|---------|---------|---------|---------|---------|---------|---------|
|         |         |         |         |         |         |         |         |

Name \_\_\_\_\_

Signature \_\_\_\_\_



# Tawastia Open Karate 2/2024

Liivuoentie 24, Hmeenlinna, FINLAND

|            |                        |         |            |             |   |                |    |
|------------|------------------------|---------|------------|-------------|---|----------------|----|
| Court Nr.  | 1                      | Pool    | 1          | Date        | 2024-10-06                              | Field Position | 59 |
| <b>RED</b> |                        |         |            | <b>BLUE</b> |   |                |    |
| NOC        | LUNIN ADRIAN (SPF,FIN) |         |            | NOC         | ZAFAR AHMED HASAN (KARATE HERVANTA,FIN) |                |    |
| Category   | Kumite, pojat, U10     |         |            |             |   |                |    |
| 3 Points   | 2 Points               | 1 Point | Score      | 1 Point     | 2 Points                                | 3 Points       |    |
|            |                        |         | 0 : 0      |             |   |                |    |
| Penatlity  |                        |         |            | Penatlity   |   |                |    |
| C1: , C2:  |                        |         | <b>0:0</b> | C1: , C2:   |   |                |    |
|            |                        |         | Total      | WINNER      |   |                |    |

KI

## Decision of Superiority

| Judge 1 | Judge 2 | Judge 3 | Judge 4 | Judge 5 | Judge 6 | Judge 7 | Referee |
|---------|---------|---------|---------|---------|---------|---------|---------|
|         |         |         |         |         |         |         |         |

Name

Signature

\_\_\_\_\_  
\_\_\_\_\_



# Tawastia Open Karate 2/2024

Liivuoentie 24, Hmeenlinna, FINLAND

|             |                                     |         |            |             |                        |                |    |
|-------------|-------------------------------------|---------|------------|-------------|------------------------|----------------|----|
| Court Nr.   | 1                                   | Pool    | 1          | Date        | 2024-10-06             | Field Position | 61 |
| <b>RED</b>  |                                     |         |            | <b>BLUE</b> |                        |                |    |
| NOC         | GROSU NICOLAS (BUDOKWAI KARATE,FIN) |         |            | NOC         | LUUKKA ERNO (KTBC,FIN) |                |    |
| Category    | Kumite, pojat, U10                  |         |            |             |                        |                |    |
| 3 Points    | 2 Points                            | 1 Point | Score      | 1 Point     | 2 Points               | 3 Points       |    |
|             |                                     |         | 0 : 3      |             |                        |                |    |
| Penatlity   |                                     |         |            | Penatlity   |                        |                |    |
| C1: C2, C2: |                                     |         | <b>0:3</b> | C1: , C2:   |                        |                |    |
|             |                                     |         | Total      | WINNER      |                        |                |    |

PTS

## Decision of Superiority

| Judge 1 | Judge 2 | Judge 3 | Judge 4 | Judge 5 | Judge 6 | Judge 7 | Referee |
|---------|---------|---------|---------|---------|---------|---------|---------|
|         |         |         |         |         |         |         |         |

Name

Signature

\_\_\_\_\_  
\_\_\_\_\_





# Tawastia Open Karate 2/2024

Liivuoentie 24, Hmeenlinna, FINLAND

|            |   |         |            |             |                                     |                |    |
|------------|---|---------|------------|-------------|-------------------------------------|----------------|----|
| Court Nr.  | 1                                       | Pool    | 1          | Date        | 2024-10-06                          | Field Position | 62 |
| <b>RED</b> |   |         |            | <b>BLUE</b> |                                     |                |    |
| NOC        | ZAFAR AHMED HASAN (KARATE HERVANTA,FIN) |         |            | NOC         | RAVYSE NATHAN (BUDOKWAI KARATE,FIN) |                |    |
| Category   | Kumite, pojat, U10                      |         |            |             |                                     |                |    |
| 3 Points   | 2 Points                                | 1 Point | Score      | 1 Point     | 2 Points                            | 3 Points       |    |
|            |   |         | 0 : 1      |             |                                     |                |    |
| Penatlity  |   |         |            | Penatlity   |                                     |                |    |
| C1: , C2:  |   |         | <b>0:1</b> | C1: C1, C2: |                                     |                |    |
|            |   |         | Total      | WINNER      |                                     |                |    |

PTS

## Decision of Superiority

| Judge 1 | Judge 2 | Judge 3 | Judge 4 | Judge 5 | Judge 6 | Judge 7 | Referee |
|---------|---------|---------|---------|---------|---------|---------|---------|
|         |         |         |         |         |         |         |         |

Name

Signature

\_\_\_\_\_  
\_\_\_\_\_



# Tawastia Open Karate 2/2024

Liivuoentie 24, Hmeenlinna, FINLAND

|            |                        |         |            |             |                                     |                |    |
|------------|------------------------|---------|------------|-------------|-------------------------------------|----------------|----|
| Court Nr.  | 1                      | Pool    | 1          | Date        | 2024-10-06                          | Field Position | 63 |
| <b>RED</b> |                        |         |            | <b>BLUE</b> |                                     |                |    |
| NOC        | LUUKKA ERNO (KTBC,FIN) |         |            | NOC         | RAVYSE NATHAN (BUDOKWAI KARATE,FIN) |                |    |
| Category   | Kumite, pojat, U10     |         |            |             |                                     |                |    |
| 3 Points   | 2 Points               | 1 Point | Score      | 1 Point     | 2 Points                            | 3 Points       |    |
|            |                        |         | 2 : 0      |             |                                     |                |    |
| Penatlity  |                        |         |            | Penatlity   |                                     |                |    |
| C1: , C2:  |                        |         | <b>2:0</b> | C1: , C2:   |                                     |                |    |
| WINNER     |                        |         | Total      |             |                                     |                |    |

PTS

## Decision of Superiority

| Judge 1 | Judge 2 | Judge 3 | Judge 4 | Judge 5 | Judge 6 | Judge 7 | Referee |
|---------|---------|---------|---------|---------|---------|---------|---------|
|         |         |         |         |         |         |         |         |





Name \_\_\_\_\_

Signature \_\_\_\_\_





## Official Results

| Kumite, pojat, U10 |                   |                       |   |               |
|--------------------|-------------------|-----------------------|---|---------------|
| 1                  | LUUKKA ERNO       | KOTKA THAIBOXING CLUB |  | FIN - FINLAND |
| 2                  | RAVYSE NATHAN     | BUDOKWAI RY KARATE    |  | FIN - FINLAND |
| 3                  | ZAFAR AHMED HASAN | SHOTOKAN HERVANTA RY  |  | FIN - FINLAND |
| 4                  | GROSU NICOLAS     | BUDOKWAI RY KARATE    |  | FIN - FINLAND |

# KUMITE, POJAT, U12, +42 KG

Tawastia Open Karate 2/2024

**ENTRIES BY WEIGHT CATEGORY**  
**Kumite, pojat, U12, +42 kg**

As of 6 OCT 2024

| Country Code | ID | Gender | Name            | Seeding |
|--------------|----|--------|-----------------|---------|
| FIN          |    | M      | Heikkil Eliel   |         |
| FIN          |    | M      | Kullberg Adam   |         |
| FIN          |    | M      | Palukuru Ronith |         |
| FIN          |    | M      | Valve Verner    |         |
| FIN          |    | M      | Zia Ahmed Hamza |         |

# Kumite, pojat, U12, +42 kg

Tawastia Open Karate 2/2024, Liivuoentie 24, Hämeenlinna, FIN

2024-10-05

Tatami  
2 15:00

Pool  
1/1

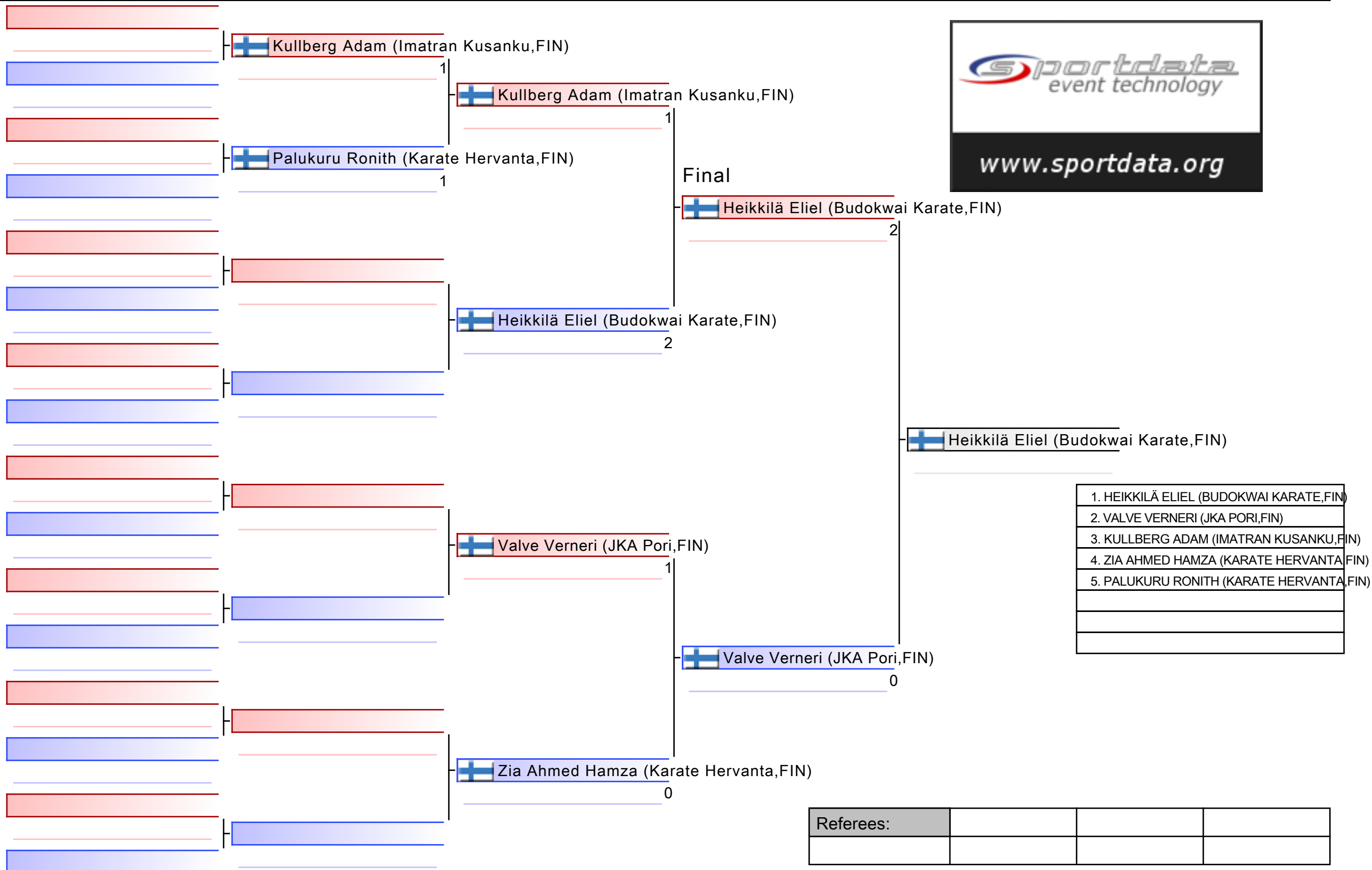

|  |
|--|
| 1. HEIKKILÄ ELIEL (BUDOKWAI KARATE,FIN)  |
| 2. VALVE VERNERI (JKA PORI,FIN)          |
| 3. KULLBERG ADAM (IMATRAN KUSANKU,FIN)   |
| 4. ZIA AHMED HAMZA (KARATE HERVANTA,FIN) |
| 5. PALUKURU RONITH (KARATE HERVANTA,FIN) |
|  |
|  |

|           |  |  |  |
|-----------|--|--|--|
| Referees: |  |  |  |
|           |  |  |  |

Kumite, pojat, U12, +42 kg

Tawastia Open Karate 2/2024

2024-10-05

Tatami  
2 15:00

Pool  
1

(c)sportdata GmbH & Co KG 2000-2024 (2024-10-06 10:03) v 10.2.0 build 1 (2024-09-26 10:14 CET) License: Online\_Event\_ID-8546\_TawastiaOpenKarate2024 (expire 2024-10-20)

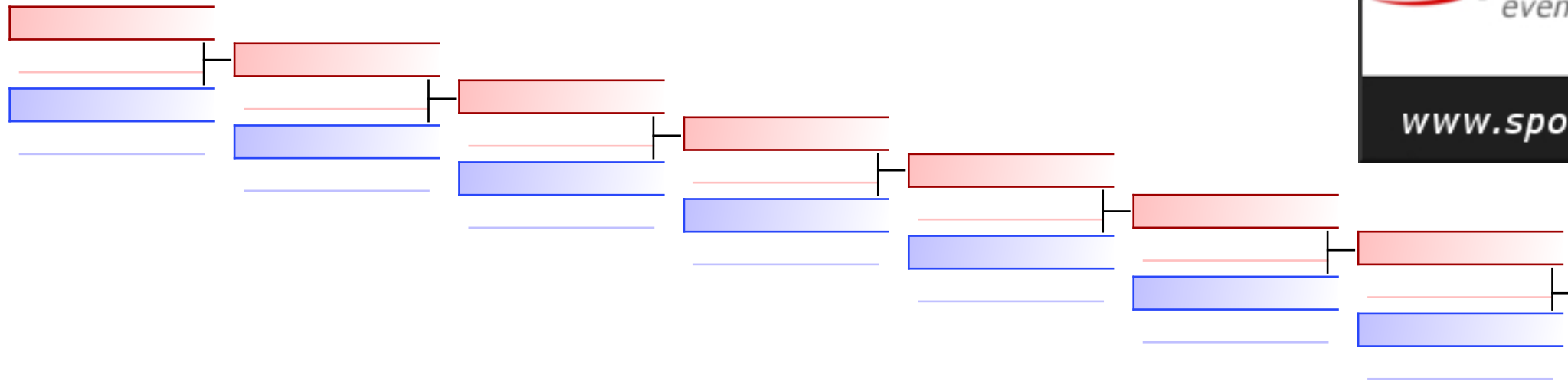

REPECHAGE: (1)

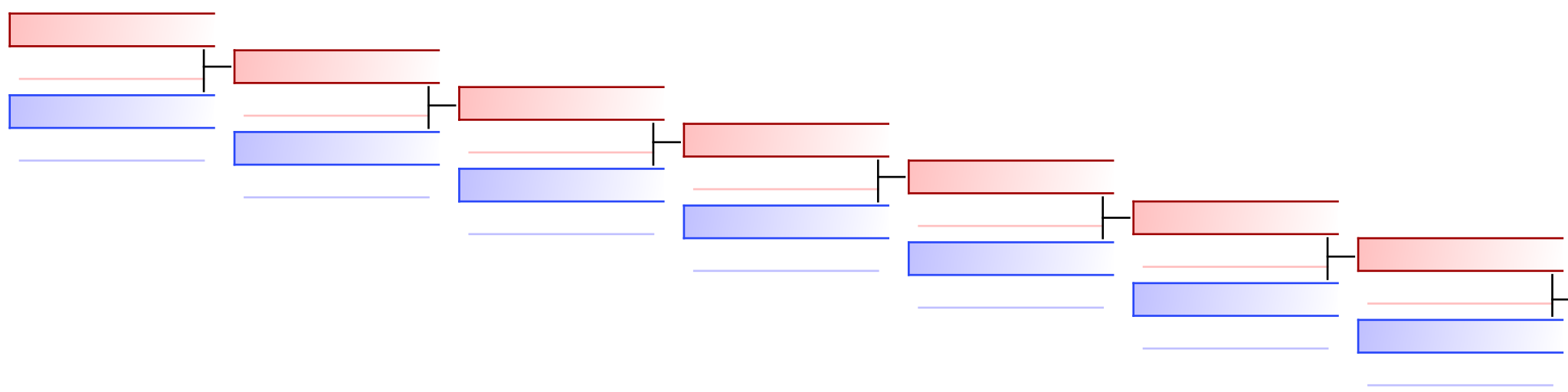

Kullberg Adam (Imatran Kusank)  
3

Kullberg Adam (Imatran Kusank)

Zia Ahmed Hamza (Karate Herv)  
1

|           |  |  |  |  |  |  |  |
|-----------|--|--|--|--|--|--|--|
| Referees: |  |  |  |  |  |  |  |
|-----------|--|--|--|--|--|--|--|



# Tawastia Open Karate 2/2024

Liivuoentie 24, Hmeenlinna, FINLAND

|            |                                     |         |            |             |                                       |                |    |
|------------|-------------------------------------|---------|------------|-------------|---------------------------------------|----------------|----|
| Court Nr.  | 1                                   | Pool    | 1          | Date        | 2024-10-06                            | Field Position | 57 |
| <b>RED</b> |                                     |         |            | <b>BLUE</b> |                                       |                |    |
| NOC        | KULLBERG ADAM (IMATRAN KUSANKU,FIN) |         |            | NOC         | PALUKURU RONITH (KARATE HERVANTA,FIN) |                |    |
| Category   | Kumite, pojat, U12, +42 kg          |         |            |             |                                       |                |    |
| 3 Points   | 2 Points                            | 1 Point | Score      | 1 Point     | 2 Points                              | 3 Points       |    |
|            |                                     |         | 1 : 1      |             |                                       |                |    |
| Penatlity  |                                     |         |            | Penatlity   |                                       |                |    |
| C1: , C2:  |                                     |         | <b>1:1</b> | C1: , C2:   |                                       |                |    |
| WINNER     |                                     |         | Total      |             |                                       |                |    |

SEN

## Decision of Superiority

| Judge 1 | Judge 2 | Judge 3 | Judge 4 | Judge 5 | Judge 6 | Judge 7 | Referee |
|---------|---------|---------|---------|---------|---------|---------|---------|
|         |         |         |         |         |         |         |         |

Name \_\_\_\_\_

Signature \_\_\_\_\_



# Tawastia Open Karate 2/2024

Liivuoentie 24, Hmeenlinna, FINLAND

|            |                                     |         |            |             |                                     |                |    |
|------------|-------------------------------------|---------|------------|-------------|-------------------------------------|----------------|----|
| Court Nr.  | 1                                   | Pool    | 1          | Date        | 2024-10-06                          | Field Position | 61 |
| <b>RED</b> |                                     |         |            | <b>BLUE</b> |                                     |                |    |
| NOC        | KULLBERG ADAM (IMATRAN KUSANKU,FIN) |         |            | NOC         | HEIKKIL ELIEL (BUDOKWAI KARATE,FIN) |                |    |
| Category   | Kumite, pojat, U12, +42 kg          |         |            |             |                                     |                |    |
| 3 Points   | 2 Points                            | 1 Point | Score      | 1 Point     | 2 Points                            | 3 Points       |    |
|            |                                     |         | 1 : 2      |             |                                     |                |    |
| Penatlity  |                                     |         |            | Penatlity   |                                     |                |    |
| C1: , C2:  |                                     |         | <b>1:2</b> | C1: C2, C2: |                                     |                |    |
|            |                                     |         | Total      | WINNER      |                                     |                |    |

PTS

## Decision of Superiority

| Judge 1 | Judge 2 | Judge 3 | Judge 4 | Judge 5 | Judge 6 | Judge 7 | Referee |
|---------|---------|---------|---------|---------|---------|---------|---------|
|         |         |         |         |         |         |         |         |

Name \_\_\_\_\_

Signature \_\_\_\_\_



# Tawastia Open Karate 2/2024

Liivuoentie 24, Hmeenlinna, FINLAND

|             |                              |         |            |             |                                       |                |    |
|-------------|------------------------------|---------|------------|-------------|---------------------------------------|----------------|----|
| Court Nr.   | 1                            | Pool    | 1          | Date        | 2024-10-06                            | Field Position | 62 |
| <b>RED</b>  |                              |         |            | <b>BLUE</b> |                                       |                |    |
| NOC         | VALVE VERNERI (JKA PORI,FIN) |         |            | NOC         | ZIA AHMED HAMZA (KARATE HERVANTA,FIN) |                |    |
| Category    | Kumite, pojat, U12, +42 kg   |         |            |             |                                       |                |    |
| 3 Points    | 2 Points                     | 1 Point | Score      | 1 Point     | 2 Points                              | 3 Points       |    |
|             |                              |         | 1 : 0      |             |                                       |                |    |
| Penatlity   |                              |         |            | Penatlity   |                                       |                |    |
| C1: C2, C2: |                              |         | <b>1:0</b> | C1: , C2:   |                                       |                |    |
| WINNER      |                              |         | Total      |             |                                       |                |    |

PTS

## Decision of Superiority

| Judge 1 | Judge 2 | Judge 3 | Judge 4 | Judge 5 | Judge 6 | Judge 7 | Referee |
|---------|---------|---------|---------|---------|---------|---------|---------|
|         |         |         |         |         |         |         |         |

Name

Signature

\_\_\_\_\_  
\_\_\_\_\_



# Tawastia Open Karate 2/2024

Liivuoentie 24, Hmeenlinna, FINLAND

|            |                                     |         |            |             |                              |                |    |
|------------|-------------------------------------|---------|------------|-------------|------------------------------|----------------|----|
| Court Nr.  | 1                                   | Pool    | 1          | Date        | 2024-10-06                   | Field Position | 63 |
| <b>RED</b> |                                     |         |            | <b>BLUE</b> |                              |                |    |
| NOC        | HEIKKIL ELIEL (BUDOKWAI KARATE,FIN) |         |            | NOC         | VALVE VERNERI (JKA PORI,FIN) |                |    |
| Category   | Kumite, pojat, U12, +42 kg          |         |            |             |                              |                |    |
| 3 Points   | 2 Points                            | 1 Point | Score      | 1 Point     | 2 Points                     | 3 Points       |    |
|            |                                     |         | 2 : 0      |             |                              |                |    |
| Penatlity  |                                     |         |            | Penatlity   |                              |                |    |
| C1: , C2:  |                                     |         | <b>2:0</b> | C1: , C2:   |                              |                |    |
| WINNER     |                                     |         | Total      |             |                              |                |    |

PTS

## Decision of Superiority

| Judge 1 | Judge 2 | Judge 3 | Judge 4 | Judge 5 | Judge 6 | Judge 7 | Referee |
|---------|---------|---------|---------|---------|---------|---------|---------|
|         |         |         |         |         |         |         |         |

Name

Signature





\_\_\_\_\_  
\_\_\_\_\_





## Tawastia Open Karate 2/2024 - 2024-10-05

## Official Results

| Kumite, pojat, U12, +42 kg |                 |                                    |   |               |
|----------------------------|-----------------|------------------------------------|---|---------------|
| 1                          | HEIKKILÄ ELIEL  | BUDOKWAI RY<br>KARATE              |  | FIN - FINLAND |
| 2                          | VALVE VERNERI   | PORIN SHOTOKAN                     |  | FIN - FINLAND |
| 3                          | KULLBERG ADAM   | BUDOSEURA<br>IMATRAN KUSANKU<br>RY |  | FIN - FINLAND |
| 4                          | ZIA AHMED HAMZA | SHOTOKAN<br>HERVANTA RY            |  | FIN - FINLAND |
| 5                          | PALUKURU RONITH | SHOTOKAN<br>HERVANTA RY            |  | FIN - FINLAND |

# KUMITE, POJAT, U12, -35 KG

Tawastia Open Karate 2/2024

**ENTRIES BY WEIGHT CATEGORY**  
**Kumite, pojat, U12, -35 kg**

As of 6 OCT 2024

| Country Code | ID | Gender | Name               | Seeding |
|--------------|----|--------|--------------------|---------|
| FIN          |    | M      | Lakka Teuvo        |         |
| FIN          |    | M      | Leisti Pennueng    |         |
| FIN          |    | M      | Rawat Ritish Singh |         |



# Kumite, pojat, U12, -35 kg - Round Robin (each against each)

Tawastia Open Karate 2/2024, Liiviuorentie 24, Hämeenlinna, FIN













2024-10-05

Tatami

2 14:05

Pool

1/1

- 1  Rawat Ritish Singh (Karate Hervanta,FIN) 0 -  Leisti Pennueng (Ktbc,FIN)
- 2  Leisti Pennueng (Ktbc,FIN) 5 -  Leisti Pennueng (Ktbc,FIN)
- 3  Rawat Ritish Singh (Karate Hervanta,FIN) 0 -  Lakka Teuvo (Karate Hervanta,FIN)
- 4  Lakka Teuvo (Karate Hervanta,FIN) 0 -  Lakka Teuvo (Karate Hervanta,FIN)
- 5  Leisti Pennueng (Ktbc,FIN) 3 -  Leisti Pennueng (Ktbc,FIN)
- 6  Lakka Teuvo (Karate Hervanta,FIN) 0 -  Lakka Teuvo (Karate Hervanta,FIN)



|   |
|---|
| 1. LEISTI PENNUENG (KTBC,FIN)               |
| 2. LAKKA TEUVO (KARATE HERVANTA,FIN)        |
| 3. RAWAT RITISH SINGH (KARATE HERVANTA,FIN) |
|   |
|   |
|   |
|   |

|           |  |  |  |
|-----------|--|--|--|
| Referees: |  |  |  |
|           |  |  |  |

# Tawastia Open Karate 2/2024

Liivuoentie 24, Hmeenlinna, FINLAND

|             |  |         |            |             |                            |                |       |
|-------------|--|---------|------------|-------------|----------------------------|----------------|-------|
| Court Nr.   | 1  | Pool    | 1          | Date        | 2024-10-06                 | Field Position | -9951 |
| <b>RED</b>  |  |         |            | <b>BLUE</b> |                            |                |       |
| NOC         | RAWAT RITISH SINGH (KARATE HERVANTA,FIN) |         |            | NOC         | LEISTI PENNUENG (KTBC,FIN) |                |       |
| Category    | Kumite, pojat, U12, -35 kg               |         |            |             |                            |                |       |
| 3 Points    | 2 Points                                 | 1 Point | Score      | 1 Point     | 2 Points                   | 3 Points       |       |
|             |  |         | 0 : 5      |             |                            |                |       |
| Penatlity   |  |         |            | Penatlity   |                            |                |       |
| C1: C1, C2: |  |         | <b>0:5</b> | C1: C3, C2: |                            |                |       |
|             |  |         | Total      | WINNER      |                            |                |       |

PTS

## Decision of Superiority

| Judge 1 | Judge 2 | Judge 3 | Judge 4 | Judge 5 | Judge 6 | Judge 7 | Referee |
|---------|---------|---------|---------|---------|---------|---------|---------|
|         |         |         |         |         |         |         |         |

Name

Signature

\_\_\_\_\_  
\_\_\_\_\_



# Tawastia Open Karate 2/2024

Liivuoentie 24, Hmeenlinna, FINLAND

|            |  |         |            |             |                                   |                |       |
|------------|--|---------|------------|-------------|-----------------------------------|----------------|-------|
| Court Nr.  | 1  | Pool    | 1          | Date        | 2024-10-06                        | Field Position | -9950 |
| <b>RED</b> |  |         |            | <b>BLUE</b> |                                   |                |       |
| NOC        | RAWAT RITISH SINGH (KARATE HERVANTA,FIN) |         |            | NOC         | LAKKA TEUVO (KARATE HERVANTA,FIN) |                |       |
| Category   | Kumite, pojat, U12, -35 kg               |         |            |             |                                   |                |       |
| 3 Points   | 2 Points                                 | 1 Point | Score      | 1 Point     | 2 Points                          | 3 Points       |       |
|            |  |         | 0 : 0      |             |                                   |                |       |
| Penatlity  |  |         |            | Penatlity   |                                   |                |       |
| C1: , C2:  |  |         | <b>0:0</b> | C1: C2, C2: |                                   |                |       |
|            |  |         | Total      | WINNER      |                                   |                |       |

HT

## Decision of Superiority

| Judge 1 | Judge 2 | Judge 3 | Judge 4 | Judge 5 | Judge 6 | Judge 7 | Referee |
|---------|---------|---------|---------|---------|---------|---------|---------|
|         |         |         |         |         |         |         |         |

Name \_\_\_\_\_

Signature \_\_\_\_\_



# Tawastia Open Karate 2/2024

Liivuoentie 24, Hmeenlinna, FINLAND

|             |                            |         |            |             |                                   |                |       |
|-------------|----------------------------|---------|------------|-------------|-----------------------------------|----------------|-------|
| Court Nr.   | 1                          | Pool    | 1          | Date        | 2024-10-06                        | Field Position | -9949 |
| <b>RED</b>  |                            |         |            | <b>BLUE</b> |                                   |                |       |
| NOC         | LEISTI PENNUENG (KTBC,FIN) |         |            | NOC         | LAKKA TEUVO (KARATE HERVANTA,FIN) |                |       |
| Category    | Kumite, pojat, U12, -35 kg |         |            |             |                                   |                |       |
| 3 Points    | 2 Points                   | 1 Point | Score      | 1 Point     | 2 Points                          | 3 Points       |       |
|             |                            |         | 3 : 0      |             |                                   |                |       |
| Penatlity   |                            |         |            | Penatlity   |                                   |                |       |
| C1: HC, C2: |                            |         | <b>3:0</b> | C1: C3, C2: |                                   |                |       |
| WINNER      |                            |         | Total      |             |                                   |                |       |

PTS

## Decision of Superiority

| Judge 1 | Judge 2 | Judge 3 | Judge 4 | Judge 5 | Judge 6 | Judge 7 | Referee |
|---------|---------|---------|---------|---------|---------|---------|---------|
|         |         |         |         |         |         |         |         |

Name



Signature

\_\_\_\_\_  
\_\_\_\_\_



## Tawastia Open Karate 2/2024 - 2024-10-05

## Official Results

| Kumite, pojat, U12, -35 kg |                    |                       |   |               |
|----------------------------|--------------------|-----------------------|---|---------------|
| 1                          | LEISTI PENNUENG    | KOTKA THAIBOXING CLUB |  | FIN - FINLAND |
| 2                          | LAKKA TEUVO        | SHOTOKAN HERVANTA RY  |  | FIN - FINLAND |
| 3                          | RAWAT RITISH SINGH | SHOTOKAN HERVANTA RY  |  | FIN - FINLAND |

# KUMITE, POJAT, U12, -42 KG

Tawastia Open Karate 2/2024

**ENTRIES BY WEIGHT CATEGORY**

**Kumite, pojat, U12, -42 kg**

As of 6 OCT 2024

| Country Code | ID | Gender | Name             | Seeding |
|--------------|----|--------|------------------|---------|
| FIN          |    | M      | Anttila Paolo    |         |
| FIN          |    | M      | Hannu Aarre      |         |
| FIN          |    | M      | Hietava Anton    |         |
| FIN          |    | M      | Lilja Dani       |         |
| FIN          |    | M      | Luukka Erkko     |         |
| FIN          |    | M      | Pihlajisto Pauli |         |
| FIN          |    | M      | Raiskinmki Aatos |         |
| FIN          |    | M      | Ralli Alexi      |         |
| FIN          |    | M      | Roihupalo Leo    |         |
| FIN          |    | M      | Siivonen Kimi    |         |
| FIN          |    | M      | Tejesvi Shashank |         |

# Kumite, pojat, U12, -42 kg

Tawastia Open Karate 2/2024, Liivourentie 24, Hämeenlinna, FIN

2024-10-05

Tatami  
2 14:20

Pool  
1/1

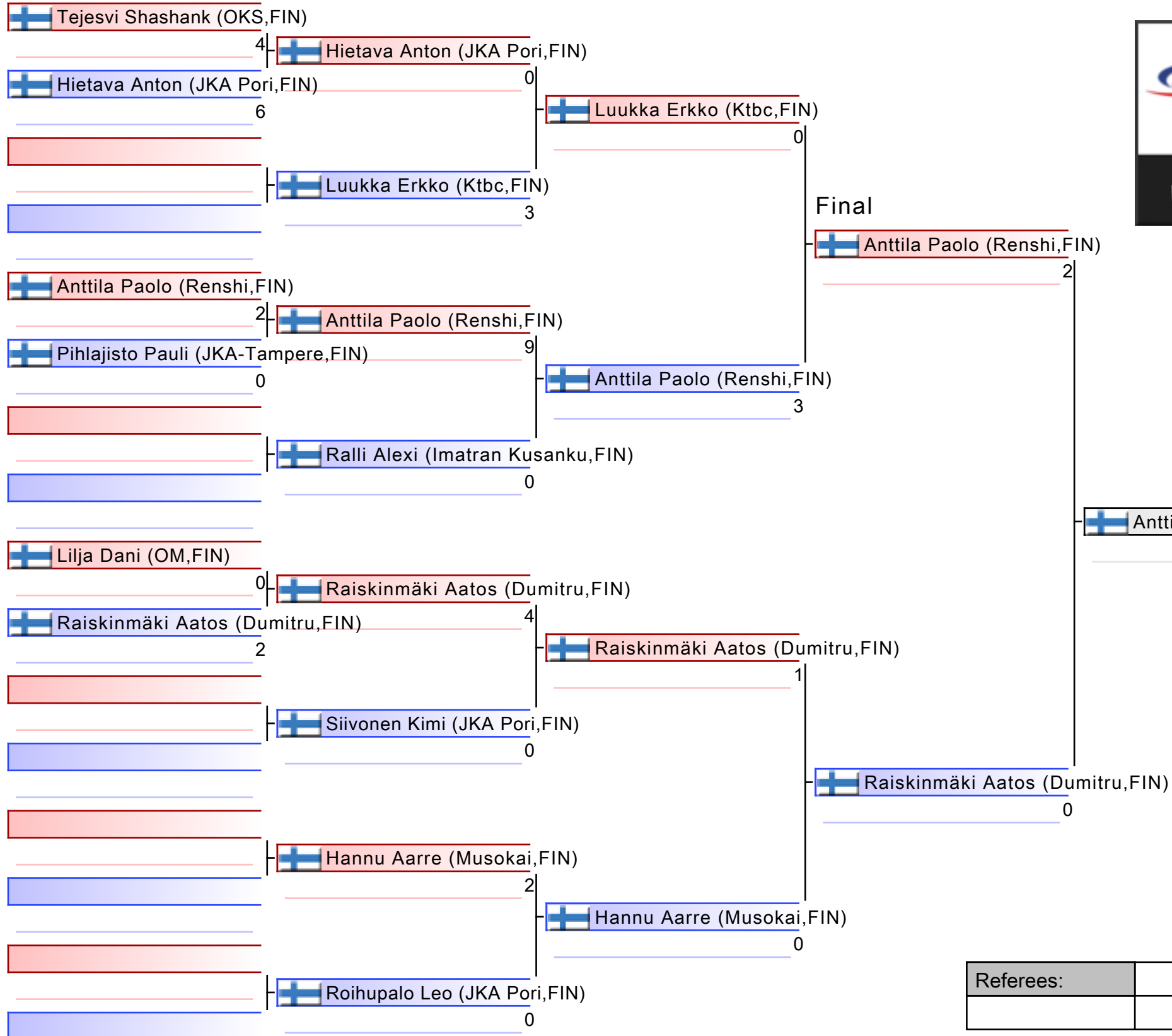

|                                       |
|---------------------------------------|
| 1. ANTILA PAOLO (RENSHI,FIN)          |
| 2. RAISKINMÄKI AATOS (DUMITRU,FIN)    |
| 3. LILJA DANI (OM,FIN)                |
| 4. LUUKKA ERKKO (KTBC,FIN)            |
| 5. RALLI ALEXI (IMATRAN KUSANKU,FIN)  |
| 5. HANNU AARRE (MUSOKAI,FIN)          |
| 7. PIHLAJISTO PAULI (JKA-TAMPERE,FIN) |
| 7. SIIVONEN KIMI (JKA PORI,FIN)       |

|           |  |  |  |
|-----------|--|--|--|
| Referees: |  |  |  |
|           |  |  |  |



Kumite, pojat, U12, -42 kg

Tawastia Open Karate 2/2024

2024-10-05

Tatami  
2 14:20

Pool  
1

(c)sportdata GmbH & Co KG 2000-2024 (2024-10-06 10:03) v 10.2.0 build 1 (2024-09-26 10:14 CET) License: Online\_Event\_ID-8546\_TawastiaOpenKarate2024 (expire 2024-10-20)

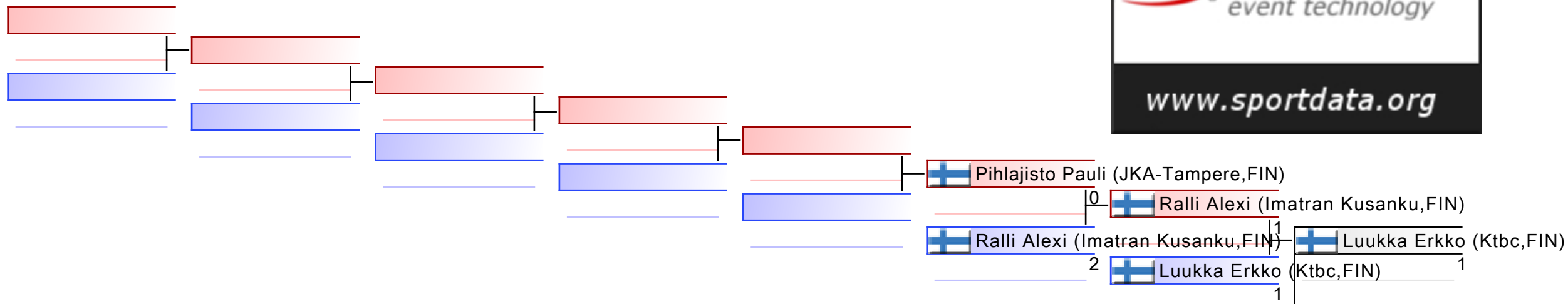

REPECHAGE: (1)

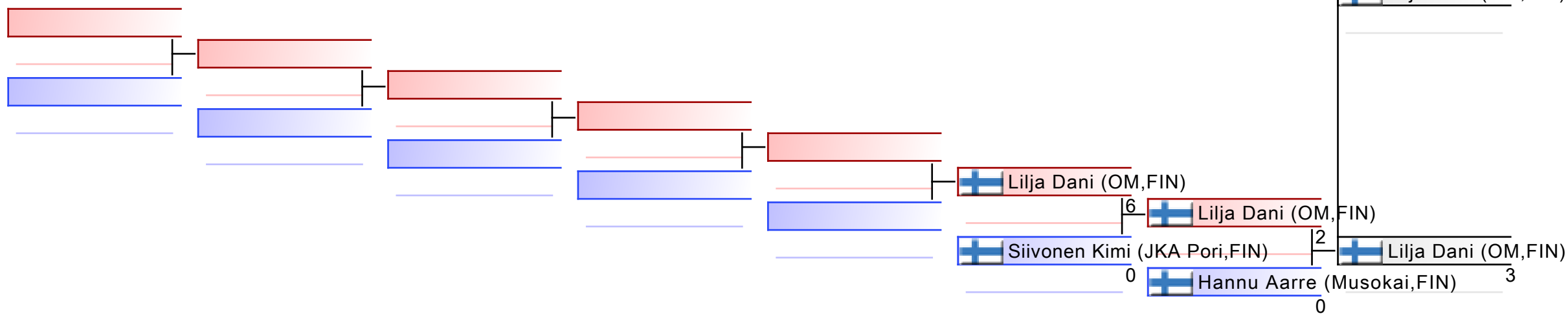

|           |  |  |  |  |  |  |  |
|-----------|--|--|--|--|--|--|--|
| Referees: |  |  |  |  |  |  |  |
|-----------|--|--|--|--|--|--|--|

# Tawastia Open Karate 2/2024

Liivuoentie 24, Hmeenlinna, FINLAND

|             |                            |         |            |             |                              |                |    |
|-------------|----------------------------|---------|------------|-------------|------------------------------|----------------|----|
| Court Nr.   | 1                          | Pool    | 1          | Date        | 2024-10-06                   | Field Position | 49 |
| <b>RED</b>  |                            |         |            | <b>BLUE</b> |                              |                |    |
| NOC         | TEJESVI SHASHANK (OKS,FIN) |         |            | NOC         | HIETAVA ANTON (JKA PORI,FIN) |                |    |
| Category    | Kumite, pojat, U12, -42 kg |         |            |             |                              |                |    |
| 3 Points    | 2 Points                   | 1 Point | Score      | 1 Point     | 2 Points                     | 3 Points       |    |
|             |                            |         | 4 : 6      |             |                              |                |    |
| Penatlity   |                            |         |            | Penatlity   |                              |                |    |
| C1: C1, C2: |                            |         | <b>4:6</b> | C1: HC, C2: |                              |                |    |
|             |                            |         | Total      | WINNER      |                              |                |    |

PTS

## Decision of Superiority

| Judge 1 | Judge 2 | Judge 3 | Judge 4 | Judge 5 | Judge 6 | Judge 7 | Referee |
|---------|---------|---------|---------|---------|---------|---------|---------|
|         |         |         |         |         |         |         |         |

Name \_\_\_\_\_

Signature \_\_\_\_\_



# Tawastia Open Karate 2/2024

Liivuoventie 24, Hmeenlinna, FINLAND

|             |                            |         |       |             |                                    |                |    |
|-------------|----------------------------|---------|-------|-------------|------------------------------------|----------------|----|
| Court Nr.   | 1                          | Pool    | 1     | Date        | 2024-10-06                         | Field Position | 51 |
| <b>RED</b>  |                            |         |       | <b>BLUE</b> |                                    |                |    |
| NOC         | ANTTILA PAOLO (RENSHI,FIN) |         |       | NOC         | PIHLAJISTO PAULI (JKA-TAMPERE,FIN) |                |    |
| Category    | Kumite, pojat, U12, -42 kg |         |       |             |                                    |                |    |
| 3 Points    | 2 Points                   | 1 Point | Score | 1 Point     | 2 Points                           | 3 Points       |    |
|             |                            |         | 2 : 0 |             |                                    |                |    |
| Penatlity   |                            |         |       | Penatlity   |                                    |                |    |
| C1: HC, C2: |                            |         |       | <b>2:0</b>  | C1: C2, C2:                        |                |    |
| WINNER      |                            |         |       | Total       |                                    |                |    |

PTS

## Decision of Superiority

| Judge 1 | Judge 2 | Judge 3 | Judge 4 | Judge 5 | Judge 6 | Judge 7 | Referee |
|---------|---------|---------|---------|---------|---------|---------|---------|
|         |         |         |         |         |         |         |         |

Name

Signature

\_\_\_\_\_  
\_\_\_\_\_



# Tawastia Open Karate 2/2024

Liivuoventie 24, Hmeenlinna, FINLAND

|             |                            |         |            |             |                                |                |    |
|-------------|----------------------------|---------|------------|-------------|--------------------------------|----------------|----|
| Court Nr.   | 1                          | Pool    | 1          | Date        | 2024-10-06                     | Field Position | 53 |
| <b>RED</b>  |                            |         |            | <b>BLUE</b> |                                |                |    |
| NOC         | LILJA DANI (OM,FIN)        |         |            | NOC         | RAISKINMKI AATOS (DUMITRU,FIN) |                |    |
| Category    | Kumite, pojat, U12, -42 kg |         |            |             |                                |                |    |
| 3 Points    | 2 Points                   | 1 Point | Score      | 1 Point     | 2 Points                       | 3 Points       |    |
|             |                            |         | 0 : 2      |             |                                |                |    |
| Penatlity   |                            |         |            | Penatlity   |                                |                |    |
| C1: C1, C2: |                            |         | <b>0:2</b> | C1: , C2:   |                                |                |    |
|             |                            |         | Total      | WINNER      |                                |                |    |

PTS

## Decision of Superiority

| Judge 1 | Judge 2 | Judge 3 | Judge 4 | Judge 5 | Judge 6 | Judge 7 | Referee |
|---------|---------|---------|---------|---------|---------|---------|---------|
|         |         |         |         |         |         |         |         |

Name

Signature

\_\_\_\_\_  
\_\_\_\_\_



# Tawastia Open Karate 2/2024

Liivuoentie 24, Hmeenlinna, FINLAND

|             |                              |         |            |             |                         |                |    |
|-------------|------------------------------|---------|------------|-------------|-------------------------|----------------|----|
| Court Nr.   | 1                            | Pool    | 1          | Date        | 2024-10-06              | Field Position | 57 |
| <b>RED</b>  |                              |         |            | <b>BLUE</b> |                         |                |    |
| NOC         | HIETAVA ANTON (JKA PORI,FIN) |         |            | NOC         | LUUKKA ERKKO (KTBC,FIN) |                |    |
| Category    | Kumite, pojat, U12, -42 kg   |         |            |             |                         |                |    |
| 3 Points    | 2 Points                     | 1 Point | Score      | 1 Point     | 2 Points                | 3 Points       |    |
|             |                              |         | 0 : 3      |             |                         |                |    |
| Penatlity   |                              |         |            | Penatlity   |                         |                |    |
| C1: C3, C2: |                              |         | <b>0:3</b> | C1: C1, C2: |                         |                |    |
|             |                              |         | Total      | WINNER      |                         |                |    |

PTS

## Decision of Superiority

| Judge 1 | Judge 2 | Judge 3 | Judge 4 | Judge 5 | Judge 6 | Judge 7 | Referee |
|---------|---------|---------|---------|---------|---------|---------|---------|
|         |         |         |         |         |         |         |         |

Name

Signature

\_\_\_\_\_  
\_\_\_\_\_



# Tawastia Open Karate 2/2024

Liivuoentie 24, Hmeenlinna, FINLAND

|            |                            |         |            |             |                                   |                |    |
|------------|----------------------------|---------|------------|-------------|-----------------------------------|----------------|----|
| Court Nr.  | 1                          | Pool    | 1          | Date        | 2024-10-06                        | Field Position | 58 |
| <b>RED</b> |                            |         |            | <b>BLUE</b> |                                   |                |    |
| NOC        | ANTTILA PAOLO (RENSHI,FIN) |         |            | NOC         | RALLI ALEXI (IMATRAN KUSANKU,FIN) |                |    |
| Category   | Kumite, pojat, U12, -42 kg |         |            |             |                                   |                |    |
| 3 Points   | 2 Points                   | 1 Point | Score      | 1 Point     | 2 Points                          | 3 Points       |    |
|            |                            |         | 9 : 0      |             |                                   |                |    |
| Penatlity  |                            |         |            | Penatlity   |                                   |                |    |
| C1: , C2:  |                            |         | <b>9:0</b> | C1: , C2:   |                                   |                |    |
| WINNER     |                            |         | Total      |             |                                   |                |    |

PTS

## Decision of Superiority

| Judge 1 | Judge 2 | Judge 3 | Judge 4 | Judge 5 | Judge 6 | Judge 7 | Referee |
|---------|---------|---------|---------|---------|---------|---------|---------|
|         |         |         |         |         |         |         |         |

Name

Signature

\_\_\_\_\_  
\_\_\_\_\_



# Tawastia Open Karate 2/2024

Liivuoentie 24, Hmeenlinna, FINLAND

|            |                                |         |            |             |                              |                |    |
|------------|--------------------------------|---------|------------|-------------|------------------------------|----------------|----|
| Court Nr.  | 1                              | Pool    | 1          | Date        | 2024-10-06                   | Field Position | 59 |
| <b>RED</b> |                                |         |            | <b>BLUE</b> |                              |                |    |
| NOC        | RAISKINMKI AATOS (DUMITRU,FIN) |         |            | NOC         | SIIVONEN KIMI (JKA PORI,FIN) |                |    |
| Category   | Kumite, pojat, U12, -42 kg     |         |            |             |                              |                |    |
| 3 Points   | 2 Points                       | 1 Point | Score      | 1 Point     | 2 Points                     | 3 Points       |    |
|            |                                |         | 4 : 0      |             |                              |                |    |
| Penatlity  |                                |         |            | Penatlity   |                              |                |    |
| C1: , C2:  |                                |         | <b>4:0</b> | C1: C3, C2: |                              |                |    |
| WINNER     |                                |         | Total      |             |                              |                |    |

PTS

## Decision of Superiority

| Judge 1 | Judge 2 | Judge 3 | Judge 4 | Judge 5 | Judge 6 | Judge 7 | Referee |
|---------|---------|---------|---------|---------|---------|---------|---------|
|         |         |         |         |         |         |         |         |

Name \_\_\_\_\_

Signature \_\_\_\_\_



# Tawastia Open Karate 2/2024

Liivuoentie 24, Hmeenlinna, FINLAND

|             |                            |         |            |             |                              |                |    |
|-------------|----------------------------|---------|------------|-------------|------------------------------|----------------|----|
| Court Nr.   | 1                          | Pool    | 1          | Date        | 2024-10-06                   | Field Position | 60 |
| <b>RED</b>  |                            |         |            | <b>BLUE</b> |                              |                |    |
| NOC         | HANNU AARRE (MUSOKAI,FIN)  |         |            | NOC         | ROIHUPALO LEO (JKA PORI,FIN) |                |    |
| Category    | Kumite, pojat, U12, -42 kg |         |            |             |                              |                |    |
| 3 Points    | 2 Points                   | 1 Point | Score      | 1 Point     | 2 Points                     | 3 Points       |    |
|             |                            |         | 2 : 0      |             |                              |                |    |
| Penatlity   |                            |         |            | Penatlity   |                              |                |    |
| C1: C1, C2: |                            |         | <b>2:0</b> | C1: C1, C2: |                              |                |    |
| WINNER      |                            |         | Total      |             |                              |                |    |

PTS

## Decision of Superiority

| Judge 1 | Judge 2 | Judge 3 | Judge 4 | Judge 5 | Judge 6 | Judge 7 | Referee |
|---------|---------|---------|---------|---------|---------|---------|---------|
|         |         |         |         |         |         |         |         |

Name

Signature

\_\_\_\_\_  
\_\_\_\_\_





# Tawastia Open Karate 2/2024

Liivuoentie 24, Hmeenlinna, FINLAND

|            |                            |         |            |             |                            |                |    |
|------------|----------------------------|---------|------------|-------------|----------------------------|----------------|----|
| Court Nr.  | 1                          | Pool    | 1          | Date        | 2024-10-06                 | Field Position | 61 |
| <b>RED</b> |                            |         |            | <b>BLUE</b> |                            |                |    |
| NOC        | LUUKKA ERKKO (KTBC,FIN)    |         |            | NOC         | ANTTILA PAOLO (RENSHI,FIN) |                |    |
| Category   | Kumite, pojat, U12, -42 kg |         |            |             |                            |                |    |
| 3 Points   | 2 Points                   | 1 Point | Score      | 1 Point     | 2 Points                   | 3 Points       |    |
|            |                            |         | 0 : 3      |             |                            |                |    |
| Penatlity  |                            |         |            | Penatlity   |                            |                |    |
| C1: , C2:  |                            |         | <b>0:3</b> | C1: HC, C2: |                            |                |    |
|            |                            |         | Total      | WINNER      |                            |                |    |

PTS

## Decision of Superiority

| Judge 1 | Judge 2 | Judge 3 | Judge 4 | Judge 5 | Judge 6 | Judge 7 | Referee |
|---------|---------|---------|---------|---------|---------|---------|---------|
|         |         |         |         |         |         |         |         |

Name

Signature

\_\_\_\_\_  
\_\_\_\_\_



# Tawastia Open Karate 2/2024

Liivuoventie 24, Hmeenlinna, FINLAND

|            |                                |         |            |             |                           |                |    |
|------------|--------------------------------|---------|------------|-------------|---------------------------|----------------|----|
| Court Nr.  | 1                              | Pool    | 1          | Date        | 2024-10-06                | Field Position | 62 |
| <b>RED</b> |                                |         |            | <b>BLUE</b> |                           |                |    |
| NOC        | RAISKINMKI AATOS (DUMITRU,FIN) |         |            | NOC         | HANNU AARRE (MUSOKAI,FIN) |                |    |
| Category   | Kumite, pojat, U12, -42 kg     |         |            |             |                           |                |    |
| 3 Points   | 2 Points                       | 1 Point | Score      | 1 Point     | 2 Points                  | 3 Points       |    |
|            |                                |         | 1 : 0      |             |                           |                |    |
| Penatlity  |                                |         |            | Penatlity   |                           |                |    |
| C1: , C2:  |                                |         | <b>1:0</b> | C1: , C2:   |                           |                |    |
| WINNER     |                                |         | Total      |             |                           |                |    |

PTS

## Decision of Superiority

| Judge 1 | Judge 2 | Judge 3 | Judge 4 | Judge 5 | Judge 6 | Judge 7 | Referee |
|---------|---------|---------|---------|---------|---------|---------|---------|
|         |         |         |         |         |         |         |         |

Name

Signature

\_\_\_\_\_  
\_\_\_\_\_



# Tawastia Open Karate 2/2024

Liivuoentie 24, Hmeenlinna, FINLAND

|             |                            |         |            |             |                                |                |    |
|-------------|----------------------------|---------|------------|-------------|--------------------------------|----------------|----|
| Court Nr.   | 1                          | Pool    | 1          | Date        | 2024-10-06                     | Field Position | 63 |
| <b>RED</b>  |                            |         |            | <b>BLUE</b> |                                |                |    |
| NOC         | ANTTILA PAOLO (RENSHI,FIN) |         |            | NOC         | RAISKINMKI AATOS (DUMITRU,FIN) |                |    |
| Category    | Kumite, pojat, U12, -42 kg |         |            |             |                                |                |    |
| 3 Points    | 2 Points                   | 1 Point | Score      | 1 Point     | 2 Points                       | 3 Points       |    |
|             |                            |         | 2 : 0      |             |                                |                |    |
| Penatlity   |                            |         |            | Penatlity   |                                |                |    |
| C1: C1, C2: |                            |         | <b>2:0</b> | C1: , C2:   |                                |                |    |
| WINNER      |                            |         | Total      |             |                                |                |    |

PTS

## Decision of Superiority

| Judge 1 | Judge 2 | Judge 3 | Judge 4 | Judge 5 | Judge 6 | Judge 7 | Referee |
|---------|---------|---------|---------|---------|---------|---------|---------|
|         |         |         |         |         |         |         |         |

Name

Signature

\_\_\_\_\_  
\_\_\_\_\_



# Tawastia Open Karate 2/2024

Liivuoventie 24, Hmeenlinna, FINLAND

|            |                                   |         |            |             |                         |                |   |
|------------|-----------------------------------|---------|------------|-------------|-------------------------|----------------|---|
| Court Nr.  | 1                                 | Pool    | 1          | Date        | 2024-10-06              | Field Position | 0 |
| <b>RED</b> |                                   |         |            | <b>BLUE</b> |                         |                |   |
| NOC        | RALLI ALEXI (IMATRAN KUSANKU,FIN) |         |            | NOC         | LUUKKA ERKKO (KTBC,FIN) |                |   |
| Category   | Kumite, pojat, U12, -42 kg        |         |            |             |                         |                |   |
| 3 Points   | 2 Points                          | 1 Point | Score      | 1 Point     | 2 Points                | 3 Points       |   |
|            |                                   |         | 1 : 1      |             |                         |                |   |
| Penatlity  |                                   |         |            | Penatlity   |                         |                |   |
| C1: , C2:  |                                   |         | <b>1:1</b> | C1: C2, C2: |                         |                |   |
|            |                                   |         | Total      | WINNER      |                         |                |   |

HT

## Decision of Superiority

| Judge 1 | Judge 2 | Judge 3 | Judge 4 | Judge 5 | Judge 6 | Judge 7 | Referee |
|---------|---------|---------|---------|---------|---------|---------|---------|
|         |         |         |         |         |         |         |         |

Name

Signature

\_\_\_\_\_  
\_\_\_\_\_



# Tawastia Open Karate 2/2024

Liivuoentie 24, Hmeenlinna, FINLAND

|            |                                    |         |       |             |                                   |                |   |
|------------|------------------------------------|---------|-------|-------------|-----------------------------------|----------------|---|
| Court Nr.  | 1                                  | Pool    | 1     | Date        | 2024-10-06                        | Field Position | 2 |
| <b>RED</b> |                                    |         |       | <b>BLUE</b> |                                   |                |   |
| NOC        | PIHLAJISTO PAULI (JKA-TAMPERE,FIN) |         |       | NOC         | RALLI ALEXI (IMATRAN KUSANKU,FIN) |                |   |
| Category   | Kumite, pojat, U12, -42 kg         |         |       |             |                                   |                |   |
| 3 Points   | 2 Points                           | 1 Point | Score | 1 Point     | 2 Points                          | 3 Points       |   |
|            |                                    |         | :     |             |                                   |                |   |
| Penatlity  |                                    |         |       | Penatlity   |                                   |                |   |
|            |                                    |         |       |             |                                   |                |   |
|            |                                    |         | Total |             |                                   |                |   |

## Decision of Superiority

|         |         |         |         |         |         |         |         |
|---------|---------|---------|---------|---------|---------|---------|---------|
| Judge 1 | Judge 2 | Judge 3 | Judge 4 | Judge 5 | Judge 6 | Judge 7 | Referee |
|         |         |         |         |         |         |         |         |

Name \_\_\_\_\_

Signature \_\_\_\_\_



# Tawastia Open Karate 2/2024

Liivuoentie 24, Hmeenlinna, FINLAND

|             |                            |         |            |             |                           |                |   |
|-------------|----------------------------|---------|------------|-------------|---------------------------|----------------|---|
| Court Nr.   | 2                          | Pool    | 2          | Date        | 2024-10-06                | Field Position | 0 |
| <b>RED</b>  |                            |         |            | <b>BLUE</b> |                           |                |   |
| NOC         | LILJA DANI (OM,FIN)        |         |            | NOC         | HANNU AARRE (MUSOKAI,FIN) |                |   |
| Category    | Kumite, pojat, U12, -42 kg |         |            |             |                           |                |   |
| 3 Points    | 2 Points                   | 1 Point | Score      | 1 Point     | 2 Points                  | 3 Points       |   |
|             |                            |         | 2 : 0      |             |                           |                |   |
| Penatlity   |                            |         |            | Penatlity   |                           |                |   |
| C1: C1, C2: |                            |         | <b>2:0</b> | C1: , C2:   |                           |                |   |
| WINNER      |                            |         | Total      |             |                           |                |   |

PTS

## Decision of Superiority

| Judge 1 | Judge 2 | Judge 3 | Judge 4 | Judge 5 | Judge 6 | Judge 7 | Referee |
|---------|---------|---------|---------|---------|---------|---------|---------|
|         |         |         |         |         |         |         |         |

Name \_\_\_\_\_

Signature \_\_\_\_\_



# Tawastia Open Karate 2/2024

Liivuoentie 24, Hmeenlinna, FINLAND

|            |                            |         |            |             |                              |                |   |
|------------|----------------------------|---------|------------|-------------|------------------------------|----------------|---|
| Court Nr.  | 2                          | Pool    | 2          | Date        | 2024-10-06                   | Field Position | 2 |
| <b>RED</b> |                            |         |            | <b>BLUE</b> |                              |                |   |
| NOC        | LILJA DANI (OM,FIN)        |         |            | NOC         | SIIVONEN KIMI (JKA PORI,FIN) |                |   |
| Category   | Kumite, pojat, U12, -42 kg |         |            |             |                              |                |   |
| 3 Points   | 2 Points                   | 1 Point | Score      | 1 Point     | 2 Points                     | 3 Points       |   |
|            |                            |         | 6 : 0      |             |                              |                |   |
| Penatlity  |                            |         |            | Penatlity   |                              |                |   |
| C1: , C2:  |                            |         | <b>6:0</b> | C1: , C2:   |                              |                |   |
| WINNER     |                            |         | Total      |             |                              |                |   |

PTS

## Decision of Superiority

| Judge 1 | Judge 2 | Judge 3 | Judge 4 | Judge 5 | Judge 6 | Judge 7 | Referee |
|---------|---------|---------|---------|---------|---------|---------|---------|
|         |         |         |         |         |         |         |         |

Name \_\_\_\_\_

Signature \_\_\_\_\_



## Tawastia Open Karate 2/2024 - 2024-10-05

## Official Results

| Kumite, pojat, U12, -42 kg |                   |                                     |   |               |
|----------------------------|-------------------|-------------------------------------|---|---------------|
| 1                          | ANTTILA PAOLO     | RENSHIN-KAN RY                      |  | FIN - FINLAND |
| 2                          | RAISKINMAKI AATOS | KARATE COMBAT ACADEMY               |  | FIN - FINLAND |
| 3                          | LILJA DANI        | SPORTSKARATE KUOPIO                 |  | FIN - FINLAND |
| 4                          | LUUKKA ERKKO      | KOTKA THAIBOXING CLUB               |  | FIN - FINLAND |
| 5                          | RALLI ALEXI       | BUDOSEURA IMATRAN KUSANKU RY        |  | FIN - FINLAND |
| 5                          | HANNU AARRE       | BUDOSEURA OULUN MUSOKAI RY          |  | FIN - FINLAND |
| 7                          | PIHLAJISTO PAULI  | JAPAN KARATE ASSOCIATION TAMPERE RY |  | FIN - FINLAND |
| 7                          | SIIVONEN KIMI     | PORIN SHOTOKAN                      |  | FIN - FINLAND |



# KUMITE, POJAT, U14, +55 KG

Tawastia Open Karate 2/2024

**ENTRIES BY WEIGHT CATEGORY**  
**Kumite, pojat, U14, +55 kg**

As of 6 OCT 2024

| Country Code | ID | Gender | Name             | Seeding |
|--------------|----|--------|------------------|---------|
| FIN          |    | M      | Lehto Eemeli     |         |
| FIN          |    | M      | Nummijrvi Luukas |         |
| FIN          |    | M      | Takala Anton     |         |
| FIN          |    | M      | Tameh Abdulkarim |         |

# Kumite, pojat, U14, +55 kg - Round Robin (each against each)

Tawastia Open Karate 2/2024, Liivuoentie 24, Hämeenlinna, FIN



















2024-10-05

Tatami

3 11:10

Pool

1/1

|    |  |   |  |
|----|--|---|--|
| 1  |  Nummijärvi Luukas (JKA Pori,FIN)  | 0 |  Takala Anton (OKS,FIN)             |
| 2  |  Takala Anton (OKS,FIN)            | 3 |  |
| 3  |  Lehto Eemeli (LK-FIN,FIN)         | 1 |  Tameh Abdulkarim (OM,FIN)          |
| 4  |  Tameh Abdulkarim (OM,FIN)         | 3 |  |
| 5  |  Nummijärvi Luukas (JKA Pori,FIN)  | 0 |  Nummijärvi Luukas (JKA Pori,FIN)   |
| 6  |  Lehto Eemeli (LK-FIN,FIN)         | 0 |  |
| 7  |  Tameh Abdulkarim (OM,FIN)         | 0 |  Takala Anton (OKS,FIN)             |
| 8  |  Takala Anton (OKS,FIN)            | 8 |  |
| 9  |  Nummijärvi Luukas (JKA Pori,FIN) | 2 |  Nummijärvi Luukas (JKA Pori,FIN) |
| 10 |  Tameh Abdulkarim (OM,FIN)       | 0 |  |
| 11 |  Takala Anton (OKS,FIN)          | 8 |  Takala Anton (OKS,FIN)           |
| 12 |  Lehto Eemeli (LK-FIN,FIN)       | 0 |  |



|                                     |
|-------------------------------------|
| 1. TAKALA ANTON (OKS,FIN)           |
| 2. NUMMIJÄRVI LUUKAS (JKA PORI,FIN) |
| 3. TAMEH ABDULKARIM (OM,FIN)        |
| 4. LEHTO EEMELI (LK-FIN,FIN)        |
|                                     |
|                                     |
|                                     |

|           |  |  |  |
|-----------|--|--|--|
| Referees: |  |  |  |
|           |  |  |  |

# Tawastia Open Karate 2/2024

Liivuoentie 24, Hmeenlinna, FINLAND

|             |                                 |         |            |             |                        |                |       |
|-------------|---------------------------------|---------|------------|-------------|------------------------|----------------|-------|
| Court Nr.   | 1                               | Pool    | 1          | Date        | 2024-10-06             | Field Position | -9951 |
| <b>RED</b>  |                                 |         |            | <b>BLUE</b> |                        |                |       |
| NOC         | NUMMIJRVI LUUKAS (JKA PORI,FIN) |         |            | NOC         | TAKALA ANTON (OKS,FIN) |                |       |
| Category    | Kumite, pojat, U14, +55 kg      |         |            |             |                        |                |       |
| 3 Points    | 2 Points                        | 1 Point | Score      | 1 Point     | 2 Points               | 3 Points       |       |
|             |                                 |         | 0 : 3      |             |                        |                |       |
| Penatlity   |                                 |         |            | Penatlity   |                        |                |       |
| C1: C2, C2: |                                 |         | <b>0:3</b> | C1: HC, C2: |                        |                |       |
|             |                                 |         | Total      | WINNER      |                        |                |       |

PTS

## Decision of Superiority

| Judge 1 | Judge 2 | Judge 3 | Judge 4 | Judge 5 | Judge 6 | Judge 7 | Referee |
|---------|---------|---------|---------|---------|---------|---------|---------|
|         |         |         |         |         |         |         |         |

Name

Signature

\_\_\_\_\_  
\_\_\_\_\_



# Tawastia Open Karate 2/2024

Liivuoentie 24, Hmeenlinna, FINLAND

|            |                            |         |            |             |                           |                |       |
|------------|----------------------------|---------|------------|-------------|---------------------------|----------------|-------|
| Court Nr.  | 1                          | Pool    | 1          | Date        | 2024-10-06                | Field Position | -9950 |
| <b>RED</b> |                            |         |            | <b>BLUE</b> |                           |                |       |
| NOC        | LEHTO EEMELI (LK-FIN,FIN)  |         |            | NOC         | TAMEH ABDULKARIM (OM,FIN) |                |       |
| Category   | Kumite, pojat, U14, +55 kg |         |            |             |                           |                |       |
| 3 Points   | 2 Points                   | 1 Point | Score      | 1 Point     | 2 Points                  | 3 Points       |       |
|            |                            |         | 1 : 3      |             |                           |                |       |
| Penatlity  |                            |         |            | Penatlity   |                           |                |       |
| C1: , C2:  |                            |         | <b>1:3</b> | C1: C1, C2: |                           |                |       |
|            |                            |         | Total      | WINNER      |                           |                |       |

PTS

## Decision of Superiority

| Judge 1 | Judge 2 | Judge 3 | Judge 4 | Judge 5 | Judge 6 | Judge 7 | Referee |
|---------|---------|---------|---------|---------|---------|---------|---------|
|         |         |         |         |         |         |         |         |

Name

Signature

\_\_\_\_\_  
\_\_\_\_\_



# Tawastia Open Karate 2/2024

Liivuoentie 24, Hmeenlinna, FINLAND

|             |                                 |         |            |             |                           |                |       |
|-------------|---------------------------------|---------|------------|-------------|---------------------------|----------------|-------|
| Court Nr.   | 1                               | Pool    | 1          | Date        | 2024-10-06                | Field Position | -9949 |
| <b>RED</b>  |                                 |         |            | <b>BLUE</b> |                           |                |       |
| NOC         | NUMMIJRVI LUUKAS (JKA PORI,FIN) |         |            | NOC         | LEHTO EEMELI (LK-FIN,FIN) |                |       |
| Category    | Kumite, pojat, U14, +55 kg      |         |            |             |                           |                |       |
| 3 Points    | 2 Points                        | 1 Point | Score      | 1 Point     | 2 Points                  | 3 Points       |       |
|             |                                 |         | 0 : 0      |             |                           |                |       |
| Penatlity   |                                 |         |            | Penatlity   |                           |                |       |
| C1: HC, C2: |                                 |         | <b>0:0</b> | C1: H, C2:  |                           |                |       |
| WINNER      |                                 |         | Total      |             |                           |                |       |

HA

## Decision of Superiority

| Judge 1 | Judge 2 | Judge 3 | Judge 4 | Judge 5 | Judge 6 | Judge 7 | Referee |
|---------|---------|---------|---------|---------|---------|---------|---------|
|         |         |         |         |         |         |         |         |

Name \_\_\_\_\_

Signature \_\_\_\_\_



# Tawastia Open Karate 2/2024

Liivuoentie 24, Hmeenlinna, FINLAND

|            |                            |         |            |             |                        |                |       |
|------------|----------------------------|---------|------------|-------------|------------------------|----------------|-------|
| Court Nr.  | 1                          | Pool    | 1          | Date        | 2024-10-06             | Field Position | -9948 |
| <b>RED</b> |                            |         |            | <b>BLUE</b> |                        |                |       |
| NOC        | TAMEH ABDULKARIM (OM,FIN)  |         |            | NOC         | TAKALA ANTON (OKS,FIN) |                |       |
| Category   | Kumite, pojat, U14, +55 kg |         |            |             |                        |                |       |
| 3 Points   | 2 Points                   | 1 Point | Score      | 1 Point     | 2 Points               | 3 Points       |       |
|            |                            |         | 0 : 8      |             |                        |                |       |
| Penatlity  |                            |         |            | Penatlity   |                        |                |       |
| C1: , C2:  |                            |         | <b>0:8</b> | C1: , C2:   |                        |                |       |
|            |                            |         | Total      | WINNER      |                        |                |       |

PTS

## Decision of Superiority

|         |         |         |         |         |         |         |         |
|---------|---------|---------|---------|---------|---------|---------|---------|
| Judge 1 | Judge 2 | Judge 3 | Judge 4 | Judge 5 | Judge 6 | Judge 7 | Referee |
|         |         |         |         |         |         |         |         |

Name

Signature

\_\_\_\_\_  
\_\_\_\_\_



# Tawastia Open Karate 2/2024

Liivuoentie 24, Hmeenlinna, FINLAND

|             |                                 |         |            |             |                           |                |       |
|-------------|---------------------------------|---------|------------|-------------|---------------------------|----------------|-------|
| Court Nr.   | 1                               | Pool    | 1          | Date        | 2024-10-06                | Field Position | -9947 |
| <b>RED</b>  |                                 |         |            | <b>BLUE</b> |                           |                |       |
| NOC         | NUMMIJRVI LUUKAS (JKA PORI,FIN) |         |            | NOC         | TAMEH ABDULKARIM (OM,FIN) |                |       |
| Category    | Kumite, pojat, U14, +55 kg      |         |            |             |                           |                |       |
| 3 Points    | 2 Points                        | 1 Point | Score      | 1 Point     | 2 Points                  | 3 Points       |       |
|             |                                 |         | 2 : 0      |             |                           |                |       |
| Penatlity   |                                 |         |            | Penatlity   |                           |                |       |
| C1: HC, C2: |                                 |         | <b>2:0</b> | C1: , C2:   |                           |                |       |
| WINNER      |                                 |         | Total      |             |                           |                |       |

PTS

## Decision of Superiority

| Judge 1 | Judge 2 | Judge 3 | Judge 4 | Judge 5 | Judge 6 | Judge 7 | Referee |
|---------|---------|---------|---------|---------|---------|---------|---------|
|         |         |         |         |         |         |         |         |

Name

Signature

\_\_\_\_\_  
\_\_\_\_\_





# Tawastia Open Karate 2/2024

Liivuoventie 24, Hmeenlinna, FINLAND

|            |                            |         |            |             |                           |                |       |
|------------|----------------------------|---------|------------|-------------|---------------------------|----------------|-------|
| Court Nr.  | 1                          | Pool    | 1          | Date        | 2024-10-06                | Field Position | -9946 |
| <b>RED</b> |                            |         |            | <b>BLUE</b> |                           |                |       |
| NOC        | TAKALA ANTON (OKS,FIN)     |         |            | NOC         | LEHTO EEMELI (LK-FIN,FIN) |                |       |
| Category   | Kumite, pojat, U14, +55 kg |         |            |             |                           |                |       |
| 3 Points   | 2 Points                   | 1 Point | Score      | 1 Point     | 2 Points                  | 3 Points       |       |
|            |                            |         | 8 : 0      |             |                           |                |       |
| Penatlity  |                            |         |            | Penatlity   |                           |                |       |
| C1: , C2:  |                            |         | <b>8:0</b> | C1: , C2:   |                           |                |       |
| WINNER     |                            |         | Total      |             |                           |                |       |

KI

## Decision of Superiority

| Judge 1 | Judge 2 | Judge 3 | Judge 4 | Judge 5 | Judge 6 | Judge 7 | Referee |
|---------|---------|---------|---------|---------|---------|---------|---------|
|         |         |         |         |         |         |         |         |

Name





Signature

\_\_\_\_\_  
\_\_\_\_\_



## Tawastia Open Karate 2/2024 - 2024-10-05

## Official Results

| Kumite, pojat, U14, +55 kg |                   |                        |   |               |
|----------------------------|-------------------|------------------------|---|---------------|
| 1                          | TAKALA ANTON      | OULUN<br>KARATESEURA   |  | FIN - FINLAND |
| 2                          | NUMMIJÄRVI LUUKAS | PORIN SHOTOKAN         |  | FIN - FINLAND |
| 3                          | TAMEH ABDULKARIM  | SPORTSKARATE<br>KUOPIO |  | FIN - FINLAND |
| 4                          | LEHTO EEMELI      | LAHDEN KARATE          |  | FIN - FINLAND |

# KUMITE, POJAT, U14, -40KG

Tawastia Open Karate 2/2024

**ENTRIES BY WEIGHT CATEGORY**

**Kumite, pojat, U14, -40kg**

As of 6 OCT 2024

| Country Code | ID | Gender | Name              | Seeding |
|--------------|----|--------|-------------------|---------|
| FIN          |    | M      | Ruottinen Roope   |         |
| FIN          |    | M      | Tsegenes Dimitris |         |

Kumite, pojat, U14, -40kg

Tawastia Open Karate 2/2024, Liivüorentie 24, Hämeenlinna, FIN

2024-10-05

Tatami  
3 10:00

Pool  
1/1

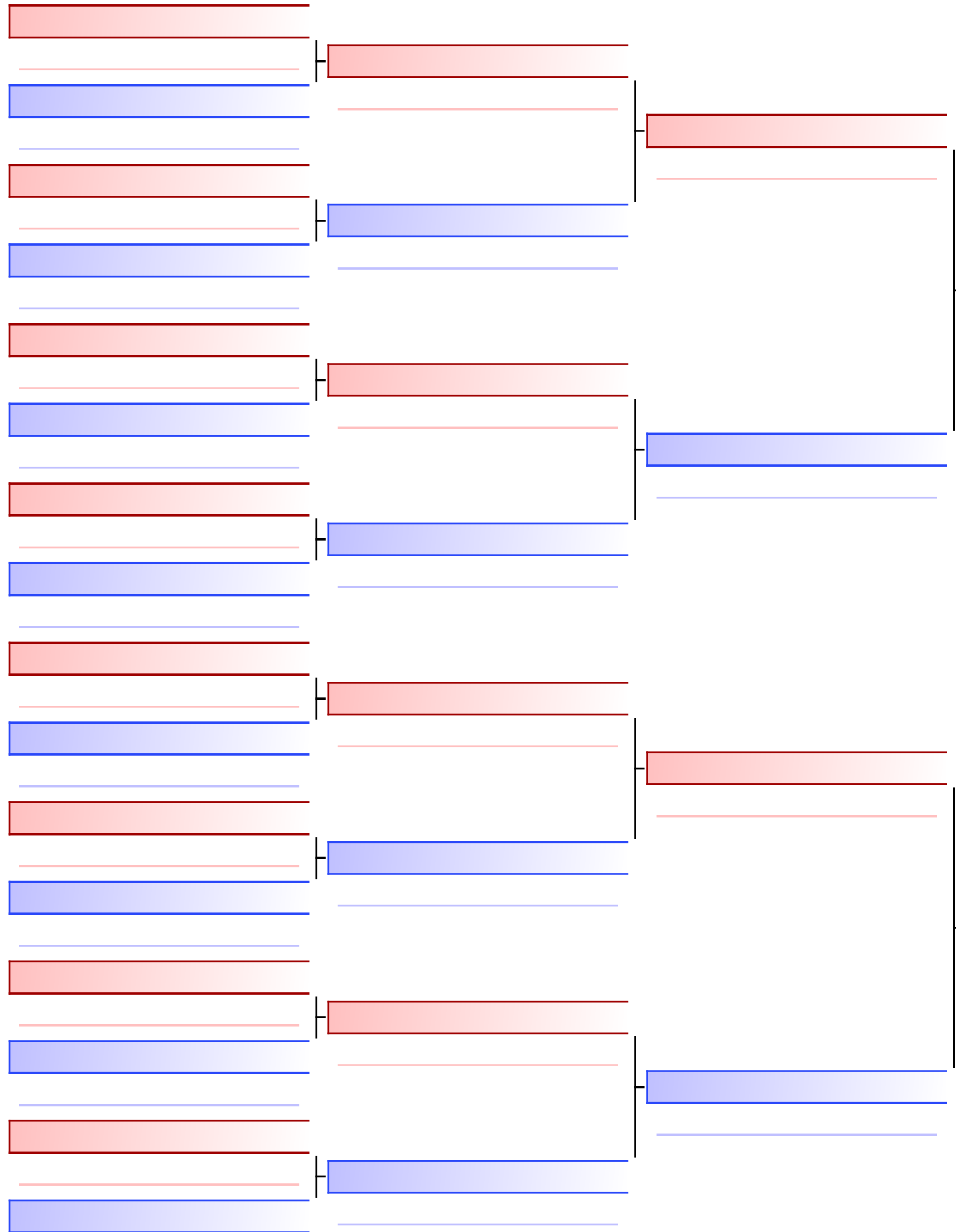

Final

Tsegenes Dimitris (Karate Hervanta,FIN)

0

Ruottinen Roope (Imatran Kusanku,FIN)

1. RUOTTINEN ROOPE (IMATRAN KUSANKU,FIN)

2. TSEGENES DIMITRIS (KARATE HERVANTA,FIN)

Ruottinen Roope (Imatran Kusanku,FIN)

2

|           |  |  |  |
|-----------|--|--|--|
| Referees: |  |  |  |
|           |  |  |  |

# Tawastia Open Karate 2/2024

Liivuoentie 24, Hmeenlinna, FINLAND

|             |   |         |            |             |                                       |                |    |
|-------------|---|---------|------------|-------------|---------------------------------------|----------------|----|
| Court Nr.   | 1                                       | Pool    | 1          | Date        | 2024-10-06                            | Field Position | 63 |
| <b>RED</b>  |   |         |            | <b>BLUE</b> |                                       |                |    |
| NOC         | TSEGENES DIMITRIS (KARATE HERVANTA,FIN) |         |            | NOC         | RUOTTINEN ROOPE (IMATRAN KUSANKU,FIN) |                |    |
| Category    | Kumite, pojat, U14, -40kg               |         |            |             |                                       |                |    |
| 3 Points    | 2 Points                                | 1 Point | Score      | 1 Point     | 2 Points                              | 3 Points       |    |
|             |   |         | 0 : 2      |             |                                       |                |    |
| Penatlity   |   |         |            | Penatlity   |                                       |                |    |
| C1: C1, C2: |   |         | <b>0:2</b> | C1: C2, C2: |                                       |                |    |
|             |   |         | Total      | WINNER      |                                       |                |    |

PTS

## Decision of Superiority

| Judge 1 | Judge 2 | Judge 3 | Judge 4 | Judge 5 | Judge 6 | Judge 7 | Referee |
|---------|---------|---------|---------|---------|---------|---------|---------|
|         |         |         |         |         |         |         |         |

Name



Signature

\_\_\_\_\_  
\_\_\_\_\_



Tawastia Open Karate 2/2024 - 2024-10-05

Official Results

| Kumite, pojat, U14, -40kg |                   |                                    |   |               |
|---------------------------|-------------------|------------------------------------|---|---------------|
| 1                         | RUOTTINEN ROOPE   | BUDOSEURA<br>IMATRAN KUSANKU<br>RY |  | FIN - FINLAND |
| 2                         | TSEGENES DIMITRIS | SHOTOKAN<br>HERVANTA RY            |  | FIN - FINLAND |

# KUMITE, POJAT, U14, -45 KG



Tawastia Open Karate 2/2024

**ENTRIES BY WEIGHT CATEGORY**  
**Kumite, pojat, U14, -45 kg**

As of 6 OCT 2024

| Country Code | ID | Gender | Name              | Seeding |
|--------------|----|--------|-------------------|---------|
| FIN          |    | M      | Kalliomki Viljami |         |
| FIN          |    | M      | Koskinen Sulo     |         |
| FIN          |    | M      | Mahmood Zohaib    |         |
| FIN          |    | M      | Raiskinmki Aaron  |         |
| FIN          |    | M      | Sipp Emil         |         |
| FIN          |    | M      | Tameh Abdulkarim  |         |

# Kumite, pojat, U14, -45 kg

Tawastia Open Karate 2/2024, Liivourentie 24, Hämeenlinna, FIN

2024-10-05

Tatami  
3 10:05

Pool  
1/1

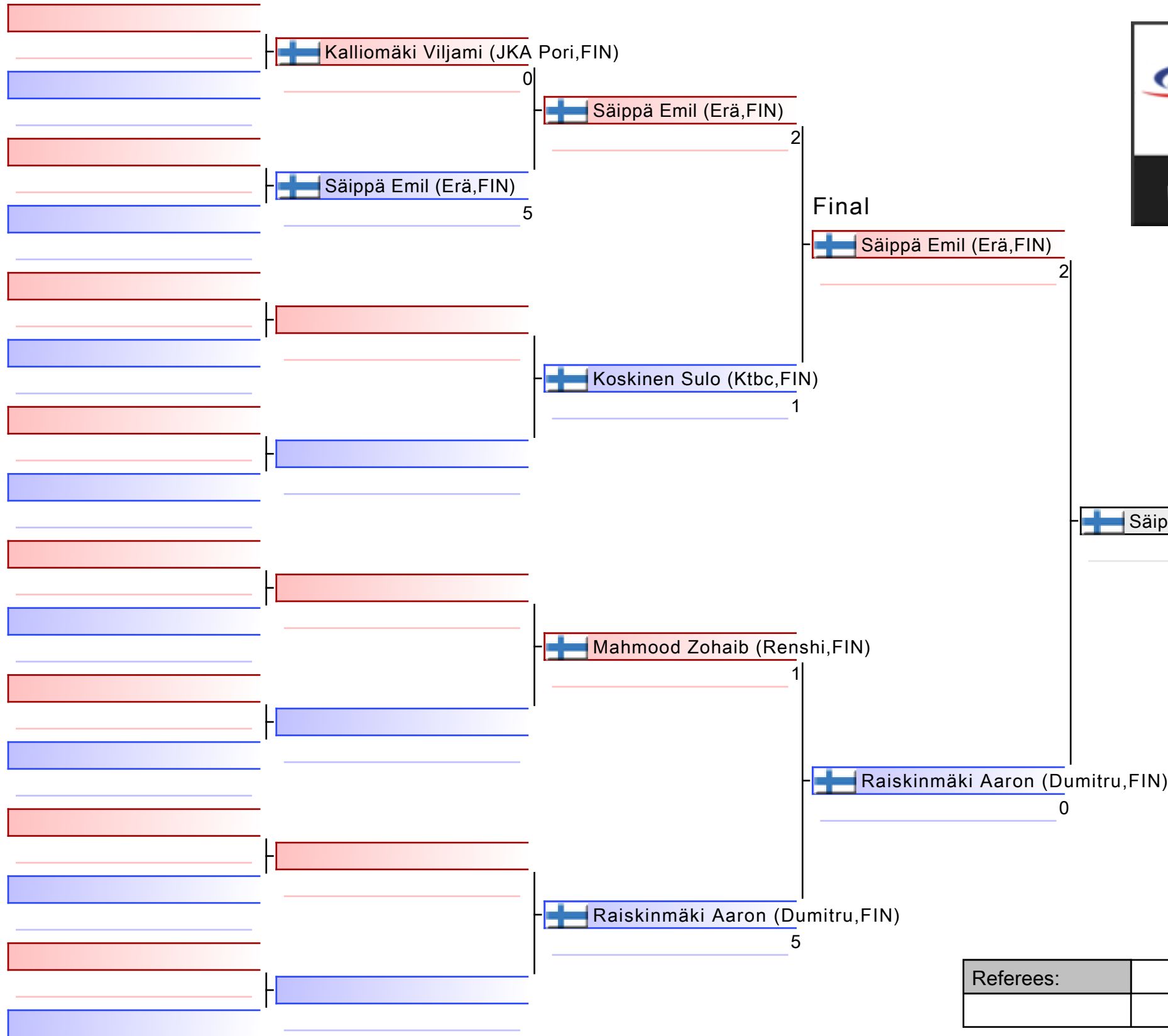

|                                      |
|--------------------------------------|
| 1. SÄIPPÄ EMIL (ERÄ,FIN)             |
| 2. RAISKINMÄKI AARON (DUMITRU,FIN)   |
| 5. KALLIOMÄKI VILJAMI (JKA PORI,FIN) |
|                                      |
|                                      |
|                                      |
|                                      |

|           |  |  |  |
|-----------|--|--|--|
| Referees: |  |  |  |
|           |  |  |  |

Kumite, pojat, U14, -45 kg

Tawastia Open Karate 2/2024

2024-10-05

Tatami

3 10:05

Pool

1

(c)sportdata GmbH & Co KG 2000-2024 (2024-10-06 10:03) v 10.2.0 build 1 (2024-09-26 10:14 CET) License: Online\_Event\_ID-8546\_TawastiaOpenKarate2024 (expire 2024-10-20)

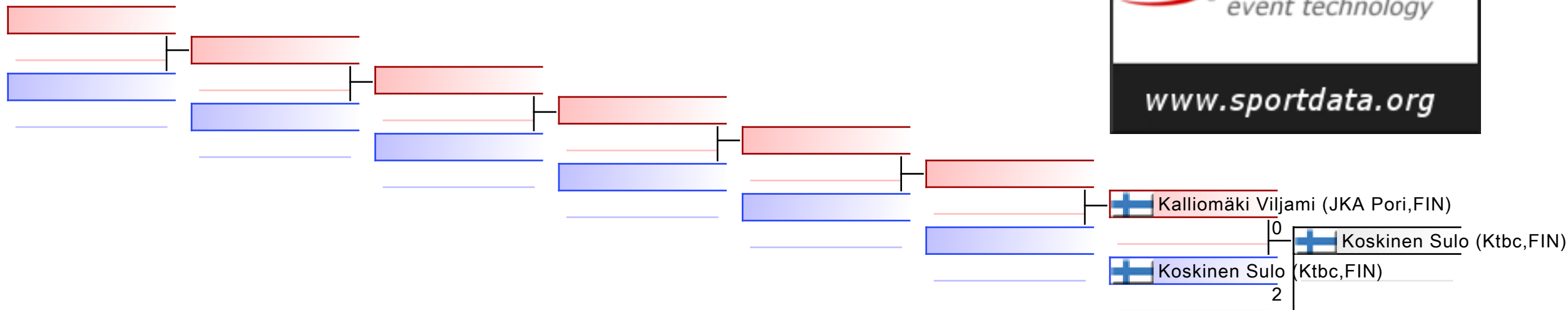

REPECHAGE: (1)

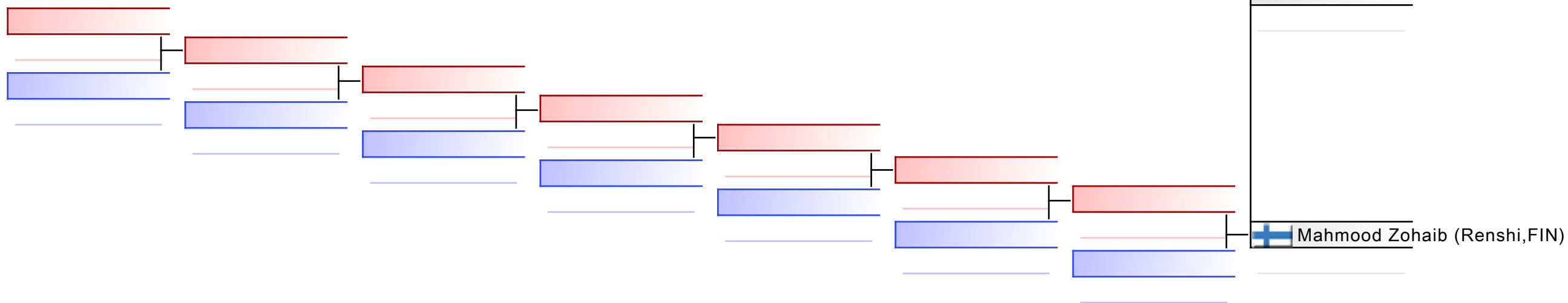

|           |  |  |  |  |  |  |  |
|-----------|--|--|--|--|--|--|--|
| Referees: |  |  |  |  |  |  |  |
|-----------|--|--|--|--|--|--|--|

# Tawastia Open Karate 2/2024

Liivuoventie 24, Hmeenlinna, FINLAND

|            |                                  |         |            |             |                    |                |    |
|------------|----------------------------------|---------|------------|-------------|--------------------|----------------|----|
| Court Nr.  | 1                                | Pool    | 1          | Date        | 2024-10-06         | Field Position | 57 |
| <b>RED</b> |                                  |         |            | <b>BLUE</b> |                    |                |    |
| NOC        | KALLIOMKI VILJAMI (JKA PORI,FIN) |         |            | NOC         | SIPP EMIL (ER,FIN) |                |    |
| Category   | Kumite, pojat, U14, -45 kg       |         |            |             |                    |                |    |
| 3 Points   | 2 Points                         | 1 Point | Score      | 1 Point     | 2 Points           | 3 Points       |    |
|            |                                  |         | 0 : 5      |             |                    |                |    |
| Penatlity  |                                  |         |            | Penatlity   |                    |                |    |
| C1: , C2:  |                                  |         | <b>0:5</b> | C1: C2, C2: |                    |                |    |
|            |                                  |         | Total      | WINNER      |                    |                |    |

PTS

## Decision of Superiority

| Judge 1 | Judge 2 | Judge 3 | Judge 4 | Judge 5 | Judge 6 | Judge 7 | Referee |
|---------|---------|---------|---------|---------|---------|---------|---------|
|         |         |         |         |         |         |         |         |

Name

Signature

\_\_\_\_\_  
\_\_\_\_\_



# Tawastia Open Karate 2/2024

Liivuoentie 24, Hmeenlinna, FINLAND

|             |                            |         |            |             |                          |                |    |
|-------------|----------------------------|---------|------------|-------------|--------------------------|----------------|----|
| Court Nr.   | 1                          | Pool    | 1          | Date        | 2024-10-06               | Field Position | 61 |
| <b>RED</b>  |                            |         |            | <b>BLUE</b> |                          |                |    |
| NOC         | SIPP EMIL (ER,FIN)         |         |            | NOC         | KOSKINEN SULO (KTBC,FIN) |                |    |
| Category    | Kumite, pojat, U14, -45 kg |         |            |             |                          |                |    |
| 3 Points    | 2 Points                   | 1 Point | Score      | 1 Point     | 2 Points                 | 3 Points       |    |
|             |                            |         | 2 : 1      |             |                          |                |    |
| Penatlity   |                            |         |            | Penatlity   |                          |                |    |
| C1: C2, C2: |                            |         | <b>2:1</b> | C1: C2, C2: |                          |                |    |
| WINNER      |                            |         | Total      |             |                          |                |    |

PTS

## Decision of Superiority

| Judge 1 | Judge 2 | Judge 3 | Judge 4 | Judge 5 | Judge 6 | Judge 7 | Referee |
|---------|---------|---------|---------|---------|---------|---------|---------|
|         |         |         |         |         |         |         |         |

Name \_\_\_\_\_

Signature \_\_\_\_\_



# Tawastia Open Karate 2/2024

Liivuoentie 24, Hmeenlinna, FINLAND

|             |                             |         |            |             |                                |                |    |
|-------------|-----------------------------|---------|------------|-------------|--------------------------------|----------------|----|
| Court Nr.   | 1                           | Pool    | 1          | Date        | 2024-10-06                     | Field Position | 62 |
| <b>RED</b>  |                             |         |            | <b>BLUE</b> |                                |                |    |
| NOC         | MAHMOOD ZOHAIB (RENSHI,FIN) |         |            | NOC         | RAISKINMKI AARON (DUMITRU,FIN) |                |    |
| Category    | Kumite, pojat, U14, -45 kg  |         |            |             |                                |                |    |
| 3 Points    | 2 Points                    | 1 Point | Score      | 1 Point     | 2 Points                       | 3 Points       |    |
|             |                             |         | 1 : 5      |             |                                |                |    |
| Penatlity   |                             |         |            | Penatlity   |                                |                |    |
| C1: C1, C2: |                             |         | <b>1:5</b> | C1: C3, C2: |                                |                |    |
|             |                             |         | Total      | WINNER      |                                |                |    |

PTS

## Decision of Superiority

|         |         |         |         |         |         |         |         |
|---------|---------|---------|---------|---------|---------|---------|---------|
| Judge 1 | Judge 2 | Judge 3 | Judge 4 | Judge 5 | Judge 6 | Judge 7 | Referee |
|         |         |         |         |         |         |         |         |

Name

Signature

\_\_\_\_\_  
\_\_\_\_\_



# Tawastia Open Karate 2/2024

Liivuoentie 24, Hmeenlinna, FINLAND

|             |                            |         |            |             |                                |                |    |
|-------------|----------------------------|---------|------------|-------------|--------------------------------|----------------|----|
| Court Nr.   | 1                          | Pool    | 1          | Date        | 2024-10-06                     | Field Position | 63 |
| <b>RED</b>  |                            |         |            | <b>BLUE</b> |                                |                |    |
| NOC         | SIPP EMIL (ER,FIN)         |         |            | NOC         | RAISKINMKI AARON (DUMITRU,FIN) |                |    |
| Category    | Kumite, pojat, U14, -45 kg |         |            |             |                                |                |    |
| 3 Points    | 2 Points                   | 1 Point | Score      | 1 Point     | 2 Points                       | 3 Points       |    |
|             |                            |         | 2 : 0      |             |                                |                |    |
| Penatlity   |                            |         |            | Penatlity   |                                |                |    |
| C1: C1, C2: |                            |         | <b>2:0</b> | C1: C2, C2: |                                |                |    |
| WINNER      |                            |         | Total      |             |                                |                |    |

PTS

## Decision of Superiority

| Judge 1 | Judge 2 | Judge 3 | Judge 4 | Judge 5 | Judge 6 | Judge 7 | Referee |
|---------|---------|---------|---------|---------|---------|---------|---------|
|         |         |         |         |         |         |         |         |

Name \_\_\_\_\_

Signature \_\_\_\_\_



# Tawastia Open Karate 2/2024

Liivuoventie 24, Hmeenlinna, FINLAND

|            |                                  |         |       |             |                          |                |   |
|------------|----------------------------------|---------|-------|-------------|--------------------------|----------------|---|
| Court Nr.  | 1                                | Pool    | 1     | Date        | 2024-10-06               | Field Position | 0 |
| <b>RED</b> |                                  |         |       | <b>BLUE</b> |                          |                |   |
| NOC        | KALLIOMKI VILJAMI (JKA PORI,FIN) |         |       | NOC         | KOSKINEN SULO (KTBC,FIN) |                |   |
| Category   | Kumite, pojat, U14, -45 kg       |         |       |             |                          |                |   |
| 3 Points   | 2 Points                         | 1 Point | Score | 1 Point     | 2 Points                 | 3 Points       |   |
|            |                                  |         | :     |             |                          |                |   |
| Penatlity  |                                  |         |       | Penatlity   |                          |                |   |
|            |                                  |         |       |             |                          |                |   |
|            |                                  |         | Total |             |                          |                |   |

## Decision of Superiority

| Judge 1 | Judge 2 | Judge 3 | Judge 4 | Judge 5 | Judge 6 | Judge 7 | Referee |
|---------|---------|---------|---------|---------|---------|---------|---------|
|         |         |         |         |         |         |         |         |

Name \_\_\_\_\_  
 Signature \_\_\_\_\_





# Tawastia Open Karate 2/2024

Liivuoventie 24, Hmeenlinna, FINLAND

|            |                            |         |       |             |                             |                |    |
|------------|----------------------------|---------|-------|-------------|-----------------------------|----------------|----|
| Court Nr.  | 1                          | Pool    | 1     | Date        | 2024-10-06                  | Field Position | 99 |
| <b>RED</b> |                            |         |       | <b>BLUE</b> |                             |                |    |
| NOC        | KOSKINEN SULO (KTBC,FIN)   |         |       | NOC         | MAHMOOD ZOHAIB (RENSHI,FIN) |                |    |
| Category   | Kumite, pojat, U14, -45 kg |         |       |             |                             |                |    |
| 3 Points   | 2 Points                   | 1 Point | Score | 1 Point     | 2 Points                    | 3 Points       |    |
|            |                            |         | :     |             |                             |                |    |
| Penatlity  |                            |         |       | Penatlity   |                             |                |    |
|            |                            |         |       |             |                             |                |    |
|            |                            |         | Total |             |                             |                |    |

## Decision of Superiority

| Judge 1 | Judge 2 | Judge 3 | Judge 4 | Judge 5 | Judge 6 | Judge 7 | Referee |
|---------|---------|---------|---------|---------|---------|---------|---------|
|         |         |         |         |         |         |         |         |



Name \_\_\_\_\_

Signature \_\_\_\_\_



Tawastia Open Karate 2/2024 - 2024-10-05

Official Results

| Kumite, pojat, U14, -45 kg |                    |                          |   |               |
|----------------------------|--------------------|--------------------------|---|---------------|
| 1                          | SÄIPPÄ EMIL        | TAPANILAN ERÄ            |  | FIN - FINLAND |
| 2                          | RAISKINMAKI AARON  | KARATE COMBAT<br>ACADEMY |  | FIN - FINLAND |
| 5                          | KALLIOMÄKI VILJAMI | PORIN SHOTOKAN           |  | FIN - FINLAND |

# KUMITE, POJAT, U14, -50 KG

Tawastia Open Karate 2/2024

**ENTRIES BY WEIGHT CATEGORY**

**Kumite, pojat, U14, -50 kg**

As of 6 OCT 2024

| Country Code | ID | Gender | Name            | Seeding |
|--------------|----|--------|-----------------|---------|
| FIN          |    | M      | Huuskonen Kosti |         |
| FIN          |    | M      | Kella Kasper    |         |
| FIN          |    | M      | Larkin Takehiro |         |
| FIN          |    | M      | Mattinen Nuutti |         |
| FIN          |    | M      | Salmensuu Toivo |         |

# Kumite, pojat, U14, -50 kg

Tawastia Open Karate 2/2024, Liivourentie 24, Hämeenlinna, FIN

2024-10-05

Tatami

3 10:30

Pool

1/1

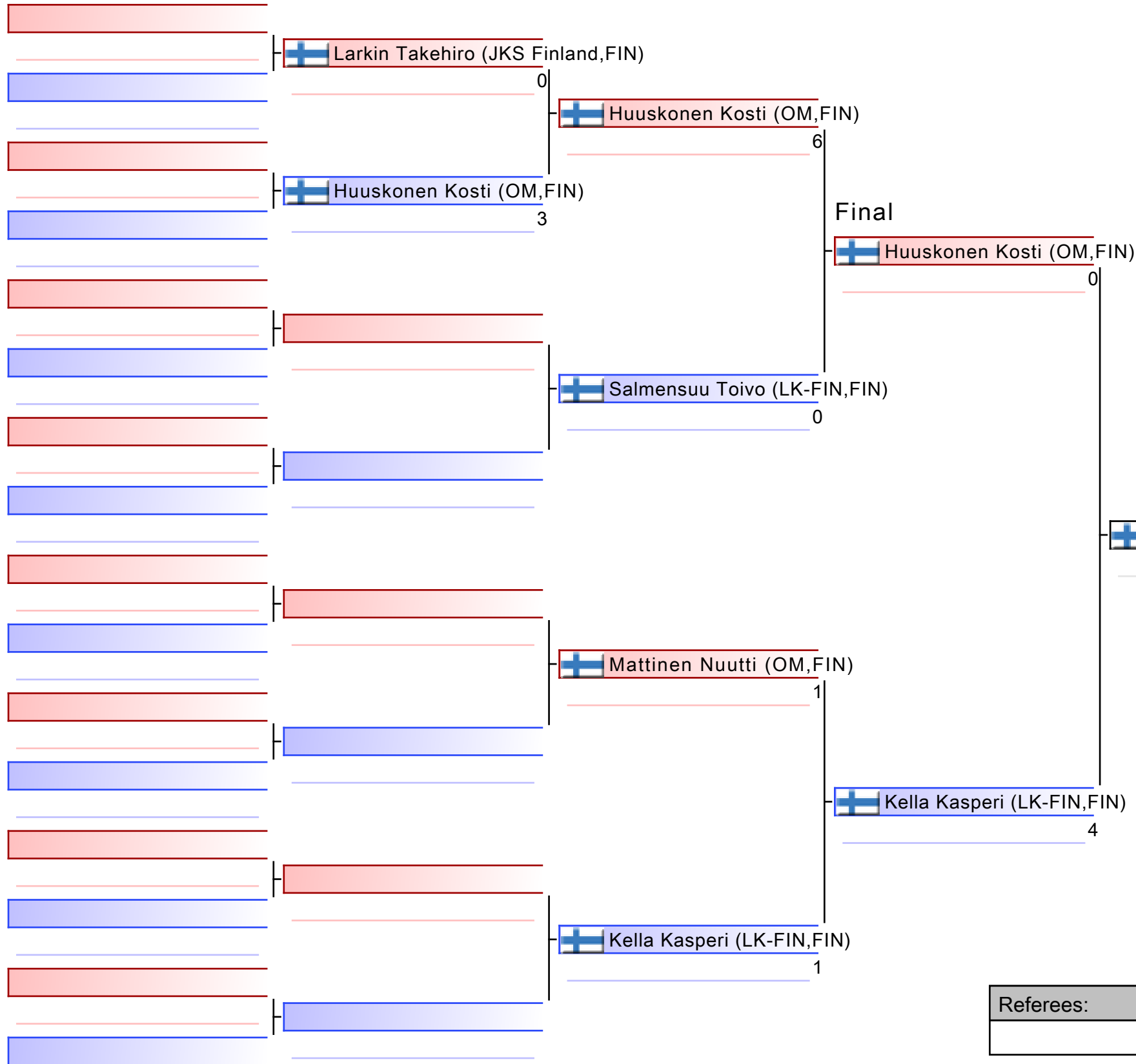

|                                      |
|--------------------------------------|
| 1. KELLA KASPERI (LK-FIN,FIN)        |
| 2. HUUSKONEN KOSTI (OM,FIN)          |
| 3. MATTINEN NUUTTI (OM,FIN)          |
| 4. LARKIN TAKEHIRO (JKS FINLAND,FIN) |
| 5. SALMENSUU TOIVO (LK-FIN,FIN)      |
|                                      |
|                                      |

|           |  |  |  |
|-----------|--|--|--|
| Referees: |  |  |  |
|           |  |  |  |

# Kumite, pojat, U14, -50 kg

Tawastia Open Karate 2/2024

2024-10-05

Tatami  
3 10:30

Pool  
1

(c)sportdata GmbH & Co KG 2000-2024 (2024-10-06 10:03) v 10.2.0 build 1 (2024-09-26 10:14 CET) License: Online\_Event\_ID-8546\_TawastiaOpenKarate2024 (expire 2024-10-20)

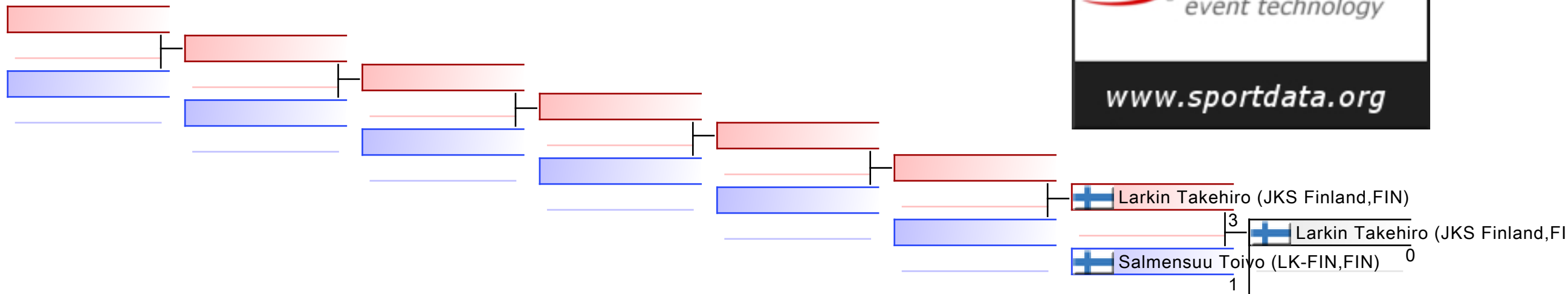

## REPECHAGE: (1)

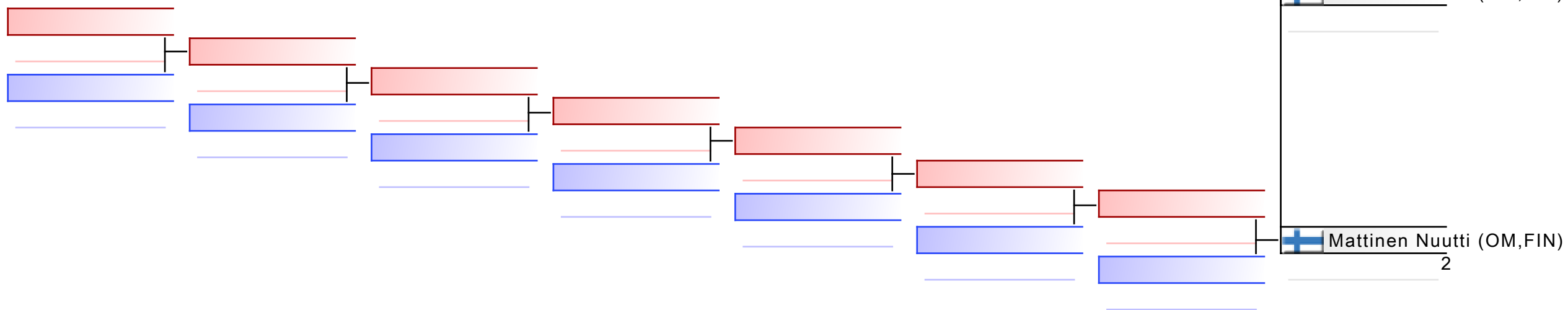

|           |  |  |  |  |  |  |  |
|-----------|--|--|--|--|--|--|--|
| Referees: |  |  |  |  |  |  |  |
|-----------|--|--|--|--|--|--|--|

# Tawastia Open Karate 2/2024

Liivuoventie 24, Hmeenlinna, FINLAND

|             |                                   |         |            |             |                          |                |    |
|-------------|-----------------------------------|---------|------------|-------------|--------------------------|----------------|----|
| Court Nr.   | 1                                 | Pool    | 1          | Date        | 2024-10-06               | Field Position | 57 |
| <b>RED</b>  |                                   |         |            | <b>BLUE</b> |                          |                |    |
| NOC         | LARKIN TAKEHIRO (JKS FINLAND,FIN) |         |            | NOC         | HUUSKONEN KOSTI (OM,FIN) |                |    |
| Category    | Kumite, pojat, U14, -50 kg        |         |            |             |                          |                |    |
| 3 Points    | 2 Points                          | 1 Point | Score      | 1 Point     | 2 Points                 | 3 Points       |    |
|             |                                   |         | 0 : 3      |             |                          |                |    |
| Penatlity   |                                   |         |            | Penatlity   |                          |                |    |
| C1: C1, C2: |                                   |         | <b>0:3</b> | C1: , C2:   |                          |                |    |
|             |                                   |         | Total      | WINNER      |                          |                |    |

PTS

## Decision of Superiority

| Judge 1 | Judge 2 | Judge 3 | Judge 4 | Judge 5 | Judge 6 | Judge 7 | Referee |
|---------|---------|---------|---------|---------|---------|---------|---------|
|         |         |         |         |         |         |         |         |

Name

Signature

\_\_\_\_\_  
\_\_\_\_\_



# Tawastia Open Karate 2/2024

Liivuoentie 24, Hmeenlinna, FINLAND

|             |                            |         |            |             |                              |                |    |
|-------------|----------------------------|---------|------------|-------------|------------------------------|----------------|----|
| Court Nr.   | 1                          | Pool    | 1          | Date        | 2024-10-06                   | Field Position | 61 |
| <b>RED</b>  |                            |         |            | <b>BLUE</b> |                              |                |    |
| NOC         | HUUSKONEN KOSTI (OM,FIN)   |         |            | NOC         | SALMENSUU TOIVO (LK-FIN,FIN) |                |    |
| Category    | Kumite, pojat, U14, -50 kg |         |            |             |                              |                |    |
| 3 Points    | 2 Points                   | 1 Point | Score      | 1 Point     | 2 Points                     | 3 Points       |    |
|             |                            |         | 6 : 0      |             |                              |                |    |
| Penatlity   |                            |         |            | Penatlity   |                              |                |    |
| C1: C1, C2: |                            |         | <b>6:0</b> | C1: C1, C2: |                              |                |    |
| WINNER      |                            |         | Total      |             |                              |                |    |

PTS

## Decision of Superiority

| Judge 1 | Judge 2 | Judge 3 | Judge 4 | Judge 5 | Judge 6 | Judge 7 | Referee |
|---------|---------|---------|---------|---------|---------|---------|---------|
|         |         |         |         |         |         |         |         |

Name

Signature

\_\_\_\_\_  
\_\_\_\_\_





# Tawastia Open Karate 2/2024

Liivuoentie 24, Hmeenlinna, FINLAND

|             |                            |         |            |             |                            |                |    |
|-------------|----------------------------|---------|------------|-------------|----------------------------|----------------|----|
| Court Nr.   | 1                          | Pool    | 1          | Date        | 2024-10-06                 | Field Position | 62 |
| <b>RED</b>  |                            |         |            | <b>BLUE</b> |                            |                |    |
| NOC         | MATTINEN NUUTTI (OM,FIN)   |         |            | NOC         | KELLA KASPERI (LK-FIN,FIN) |                |    |
| Category    | Kumite, pojat, U14, -50 kg |         |            |             |                            |                |    |
| 3 Points    | 2 Points                   | 1 Point | Score      | 1 Point     | 2 Points                   | 3 Points       |    |
|             |                            |         | 1 : 1      |             |                            |                |    |
| Penatlity   |                            |         |            | Penatlity   |                            |                |    |
| C1: C2, C2: |                            |         | <b>1:1</b> | C1: C1, C2: |                            |                |    |
|             |                            |         | Total      | WINNER      |                            |                |    |

SEN

## Decision of Superiority

| Judge 1 | Judge 2 | Judge 3 | Judge 4 | Judge 5 | Judge 6 | Judge 7 | Referee |
|---------|---------|---------|---------|---------|---------|---------|---------|
|         |         |         |         |         |         |         |         |

Name

Signature

\_\_\_\_\_  
\_\_\_\_\_



# Tawastia Open Karate 2/2024

Liivuoentie 24, Hmeenlinna, FINLAND

|            |                            |         |            |             |                            |                |    |
|------------|----------------------------|---------|------------|-------------|----------------------------|----------------|----|
| Court Nr.  | 1                          | Pool    | 1          | Date        | 2024-10-06                 | Field Position | 63 |
| <b>RED</b> |                            |         |            | <b>BLUE</b> |                            |                |    |
| NOC        | HUUSKONEN KOSTI (OM,FIN)   |         |            | NOC         | KELLA KASPERI (LK-FIN,FIN) |                |    |
| Category   | Kumite, pojat, U14, -50 kg |         |            |             |                            |                |    |
| 3 Points   | 2 Points                   | 1 Point | Score      | 1 Point     | 2 Points                   | 3 Points       |    |
|            |                            |         | 0 : 4      |             |                            |                |    |
| Penatlity  |                            |         |            | Penatlity   |                            |                |    |
| C1: , C2:  |                            |         | <b>0:4</b> | C1: C2, C2: |                            |                |    |
|            |                            |         | Total      | WINNER      |                            |                |    |

PTS

## Decision of Superiority

| Judge 1 | Judge 2 | Judge 3 | Judge 4 | Judge 5 | Judge 6 | Judge 7 | Referee |
|---------|---------|---------|---------|---------|---------|---------|---------|
|         |         |         |         |         |         |         |         |

Name

Signature

\_\_\_\_\_  
\_\_\_\_\_



# Tawastia Open Karate 2/2024

Liivuoventie 24, Hmeenlinna, FINLAND

|            |                                   |         |       |             |                              |                |   |
|------------|-----------------------------------|---------|-------|-------------|------------------------------|----------------|---|
| Court Nr.  | 1                                 | Pool    | 1     | Date        | 2024-10-06                   | Field Position | 0 |
| <b>RED</b> |                                   |         |       | <b>BLUE</b> |                              |                |   |
| NOC        | LARKIN TAKEHIRO (JKS FINLAND,FIN) |         |       | NOC         | SALMENSUU TOIVO (LK-FIN,FIN) |                |   |
| Category   | Kumite, pojat, U14, -50 kg        |         |       |             |                              |                |   |
| 3 Points   | 2 Points                          | 1 Point | Score | 1 Point     | 2 Points                     | 3 Points       |   |
|            |                                   |         | :     |             |                              |                |   |
| Penatlity  |                                   |         |       | Penatlity   |                              |                |   |
|            |                                   |         |       |             |                              |                |   |
|            |                                   |         | Total |             |                              |                |   |

## Decision of Superiority

|         |         |         |         |         |         |         |         |
|---------|---------|---------|---------|---------|---------|---------|---------|
| Judge 1 | Judge 2 | Judge 3 | Judge 4 | Judge 5 | Judge 6 | Judge 7 | Referee |
|         |         |         |         |         |         |         |         |

Name

Signature





\_\_\_\_\_

\_\_\_\_\_



## Tawastia Open Karate 2/2024 - 2024-10-05

## Official Results

| Kumite, pojat, U14, -50 kg |                 |  |   |               |
|----------------------------|-----------------|--|---|---------------|
| 1                          | KELLA KASPERI   | LAHDEN KARATE                                |  | FIN - FINLAND |
| 2                          | HUUSKONEN KOSTI | SPORTSKARATE<br>KUOPIO                       |  | FIN - FINLAND |
| 3                          | MATTINEN NUUTTI | SPORTSKARATE<br>KUOPIO                       |  | FIN - FINLAND |
| 4                          | LARKIN TAKEHIRO | JKS FINLAND -<br>SHOTOKAN KARATE<br>HELSINKI |  | FIN - FINLAND |
| 5                          | SALMENSUU TOIVO | LAHDEN KARATE                                |  | FIN - FINLAND |

# KUMITE, POJAT, U14, -55 KG

Tawastia Open Karate 2/2024

**ENTRIES BY WEIGHT CATEGORY**

**Kumite, pojat, U14, -55 kg**

As of 6 OCT 2024

| Country Code | ID | Gender | Name               | Seeding |
|--------------|----|--------|--------------------|---------|
| FIN          |    | M      | Hannu Eero         |         |
| FIN          |    | M      | NOROUZI Arash Leon |         |
| FIN          |    | M      | Wolff Arn          |         |

# Kumite, pojat, U14, -55 kg - Round Robin (each against each)

Tawastia Open Karate 2/2024, Liivuoentie 24, Hämeenlinna, FIN









2024-10-05

Tatami

3 10:50

Pool

1/1

|   |   |   |  |
|---|---|---|--|
| 1 |  Hannu Eero (OKS,FIN)                 | 2 |  Hannu Eero (OKS,FIN) |
| 2 |  NOROUZI Arash Leon (JKS Finland,FIN) | 2 |  |
| 3 |  Hannu Eero (OKS,FIN)                 | 0 |  Wolff Arn (Erä,FIN)  |
| 4 |  Wolff Arn (Erä,FIN)                  | 4 |  |
| 5 |  NOROUZI Arash Leon (JKS Finland,FIN) | 0 |  Wolff Arn (Erä,FIN)  |
| 6 |  Wolff Arn (Erä,FIN)                  | 6 |  |



|   |
|---|
| 1. WOLFF ARN (ERÄ,FIN)                  |
| 2. HANNU EERO (OKS,FIN)                 |
| 3. NOROUZI ARASH LEON (JKS FINLAND,FIN) |
|   |
|   |
|   |
|   |

|           |  |  |  |
|-----------|--|--|--|
| Referees: |  |  |  |
|           |  |  |  |

# Tawastia Open Karate 2/2024

Liivuoentie 24, Hmeenlinna, FINLAND

|            |                            |         |            |             |                                      |                |       |
|------------|----------------------------|---------|------------|-------------|--------------------------------------|----------------|-------|
| Court Nr.  | 1                          | Pool    | 1          | Date        | 2024-10-06                           | Field Position | -9951 |
| <b>RED</b> |                            |         |            | <b>BLUE</b> |                                      |                |       |
| NOC        | HANNU EERO (OKS,FIN)       |         |            | NOC         | NOROUZI ARASH LEON (JKS FINLAND,FIN) |                |       |
| Category   | Kumite, pojat, U14, -55 kg |         |            |             |                                      |                |       |
| 3 Points   | 2 Points                   | 1 Point | Score      | 1 Point     | 2 Points                             | 3 Points       |       |
|            |                            |         | 2 : 2      |             |                                      |                |       |
| Penatlity  |                            |         |            | Penatlity   |                                      |                |       |
| C1: , C2:  |                            |         | <b>2:2</b> | C1: C1, C2: |                                      |                |       |
| WINNER     |                            |         | Total      |             |                                      |                |       |

SEN

## Decision of Superiority

| Judge 1 | Judge 2 | Judge 3 | Judge 4 | Judge 5 | Judge 6 | Judge 7 | Referee |
|---------|---------|---------|---------|---------|---------|---------|---------|
|         |         |         |         |         |         |         |         |

Name

Signature

\_\_\_\_\_  
\_\_\_\_\_





# Tawastia Open Karate 2/2024

Liivuoentie 24, Hmeenlinna, FINLAND

|            |                            |         |            |             |                    |                |       |
|------------|----------------------------|---------|------------|-------------|--------------------|----------------|-------|
| Court Nr.  | 1                          | Pool    | 1          | Date        | 2024-10-06         | Field Position | -9950 |
| <b>RED</b> |                            |         |            | <b>BLUE</b> |                    |                |       |
| NOC        | HANNU EERO (OKS,FIN)       |         |            | NOC         | WOLFF ARN (ER,FIN) |                |       |
| Category   | Kumite, pojat, U14, -55 kg |         |            |             |                    |                |       |
| 3 Points   | 2 Points                   | 1 Point | Score      | 1 Point     | 2 Points           | 3 Points       |       |
|            |                            |         | 0 : 4      |             |                    |                |       |
| Penatlity  |                            |         |            | Penatlity   |                    |                |       |
| C1: , C2:  |                            |         | <b>0:4</b> | C1: C1, C2: |                    |                |       |
|            |                            |         | Total      | WINNER      |                    |                |       |

PTS

## Decision of Superiority

| Judge 1 | Judge 2 | Judge 3 | Judge 4 | Judge 5 | Judge 6 | Judge 7 | Referee |
|---------|---------|---------|---------|---------|---------|---------|---------|
|         |         |         |         |         |         |         |         |

Name

Signature

\_\_\_\_\_  
\_\_\_\_\_



# Tawastia Open Karate 2/2024

Liivuoentie 24, Hmeenlinna, FINLAND

|            |                                      |         |            |             |                    |                |       |
|------------|--------------------------------------|---------|------------|-------------|--------------------|----------------|-------|
| Court Nr.  | 1                                    | Pool    | 1          | Date        | 2024-10-06         | Field Position | -9949 |
| <b>RED</b> |                                      |         |            | <b>BLUE</b> |                    |                |       |
| NOC        | NOROUZI ARASH LEON (JKS FINLAND,FIN) |         |            | NOC         | WOLFF ARN (ER,FIN) |                |       |
| Category   | Kumite, pojat, U14, -55 kg           |         |            |             |                    |                |       |
| 3 Points   | 2 Points                             | 1 Point | Score      | 1 Point     | 2 Points           | 3 Points       |       |
|            |                                      |         | 0 : 6      |             |                    |                |       |
| Penatlity  |                                      |         |            | Penatlity   |                    |                |       |
| C1: , C2:  |                                      |         | <b>0:6</b> | C1: , C2:   |                    |                |       |
|            |                                      |         | Total      | WINNER      |                    |                |       |

PTS

## Decision of Superiority

| Judge 1 | Judge 2 | Judge 3 | Judge 4 | Judge 5 | Judge 6 | Judge 7 | Referee |
|---------|---------|---------|---------|---------|---------|---------|---------|
|         |         |         |         |         |         |         |         |



Name \_\_\_\_\_

Signature \_\_\_\_\_



## Tawastia Open Karate 2/2024 - 2024-10-05

## Official Results

| Kumite, pojat, U14, -55 kg |                    |  |   |               |
|----------------------------|--------------------|--|---|---------------|
| 1                          | WOLFF ARN          | TAPANILAN ERÄ                                |  | FIN - FINLAND |
| 2                          | HANNU EERO         | OULUN<br>KARATESEURA                         |  | FIN - FINLAND |
| 3                          | NOROUZI ARASH LEON | JKS FINLAND -<br>SHOTOKAN KARATE<br>HELSINKI |  | FIN - FINLAND |

# KUMITE, POJAT, U16, +70 KG

Tawastia Open Karate 2/2024

**ENTRIES BY WEIGHT CATEGORY**  
**Kumite, pojat, U16, +70 kg**

As of 6 OCT 2024

| Country Code | ID | Gender | Name            | Seeding |
|--------------|----|--------|-----------------|---------|
| FIN          |    | M      | Algahawi Yakoot |         |
| FIN          |    | M      | Forsten Niklas  |         |
| FIN          |    | M      | Huuskonen Veeti |         |
| FIN          |    | M      | Kivikoski Jere  |         |
| FIN          |    | M      | Pienimki Roope  |         |

# Kumite, pojat, U16, +70 kg

Tawastia Open Karate 2/2024, Liivuoentie 24, Hämeenlinna, FIN

2024-10-05

Tatami  
3 14:55

Pool  
1/1

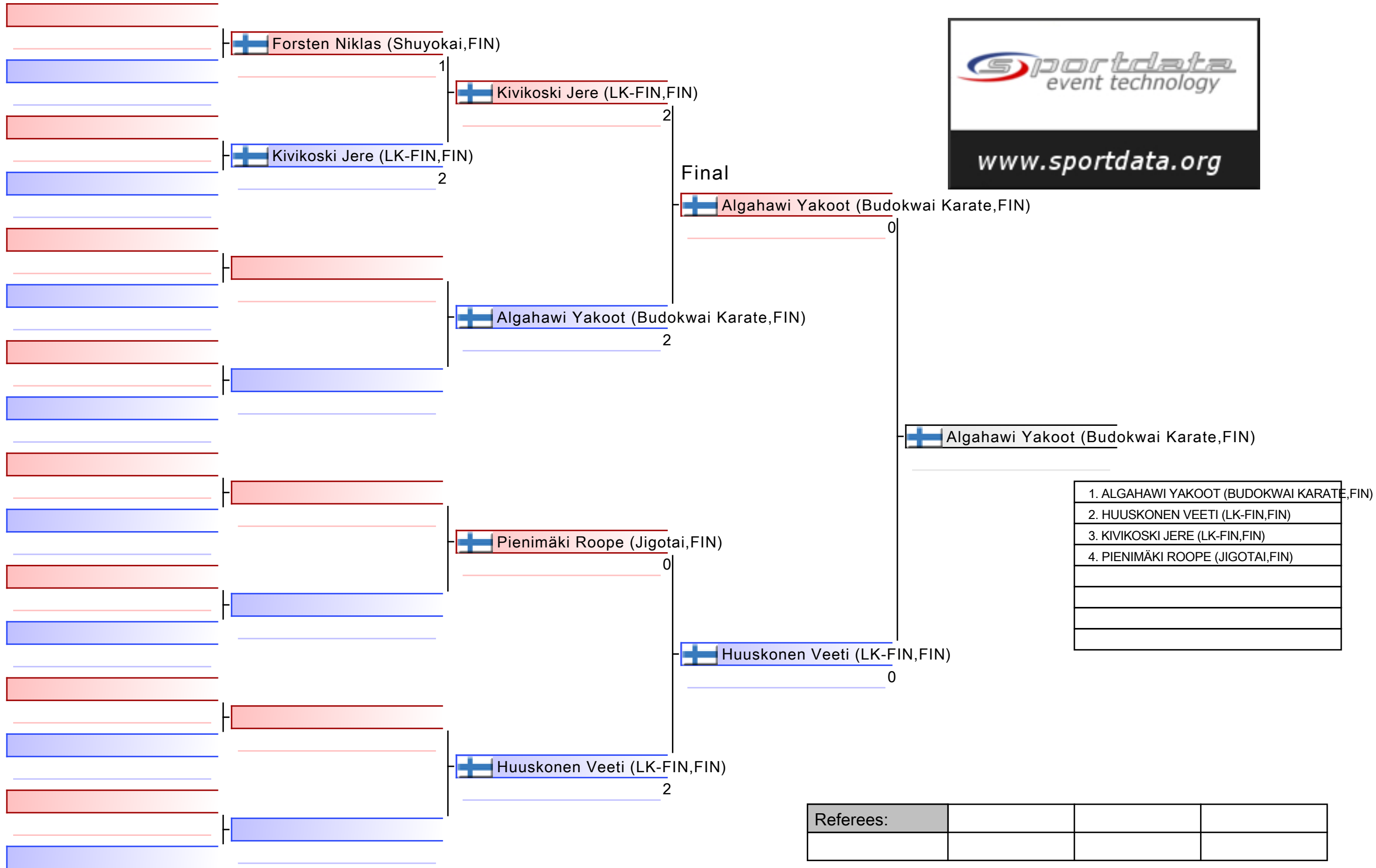

|           |  |  |  |
|-----------|--|--|--|
| Referees: |  |  |  |
|           |  |  |  |

Kumite, pojat, U16, +70 kg

Tawastia Open Karate 2/2024

2024-10-05

Tatami  
3 14:55

Pool  
1

(c)sportdata GmbH & Co KG 2000-2024 (2024-10-06 10:03) v 10.2.0 build 1 (2024-09-26 10:14 CET) License: Online\_Event\_ID-8546\_TawastiaOpenKarate22024 (expire 2024-10-20)



www.sportdata.org

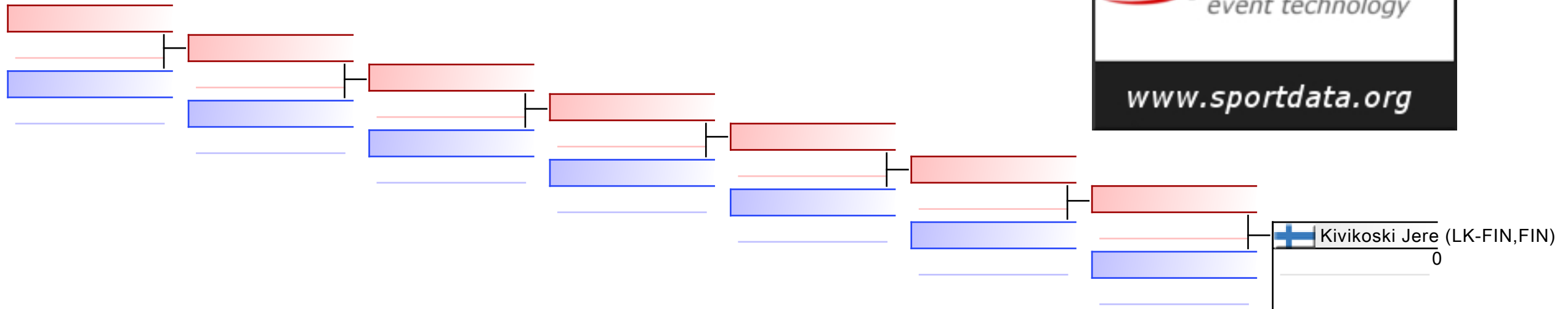

REPECHAGE: (1)

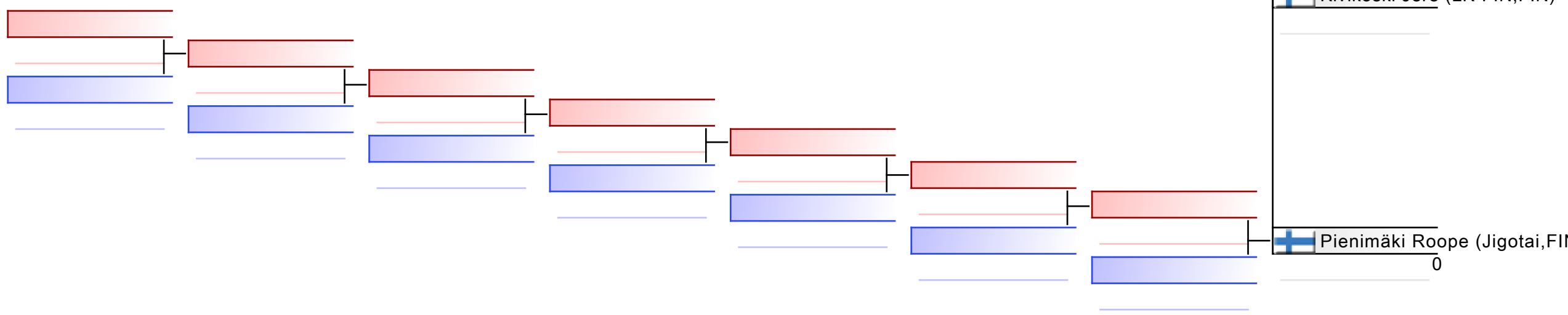

|           |  |  |  |  |  |  |  |
|-----------|--|--|--|--|--|--|--|
| Referees: |  |  |  |  |  |  |  |
|-----------|--|--|--|--|--|--|--|

# Tawastia Open Karate 2/2024

Liivuoentie 24, Hmeenlinna, FINLAND

|            |                               |         |            |             |                             |                |    |
|------------|-------------------------------|---------|------------|-------------|-----------------------------|----------------|----|
| Court Nr.  | 1                             | Pool    | 1          | Date        | 2024-10-06                  | Field Position | 57 |
| <b>RED</b> |                               |         |            | <b>BLUE</b> |                             |                |    |
| NOC        | FORSTEN NIKLAS (SHUYOKAI,FIN) |         |            | NOC         | KIVIKOSKI JERE (LK-FIN,FIN) |                |    |
| Category   | Kumite, pojat, U16, +70 kg    |         |            |             |                             |                |    |
| 3 Points   | 2 Points                      | 1 Point | Score      | 1 Point     | 2 Points                    | 3 Points       |    |
|            |                               |         | 1 : 2      |             |                             |                |    |
| Penatlity  |                               |         |            | Penatlity   |                             |                |    |
| C1: , C2:  |                               |         | <b>1:2</b> | C1: , C2:   |                             |                |    |
|            |                               |         | Total      | WINNER      |                             |                |    |

PTS

## Decision of Superiority

| Judge 1 | Judge 2 | Judge 3 | Judge 4 | Judge 5 | Judge 6 | Judge 7 | Referee |
|---------|---------|---------|---------|---------|---------|---------|---------|
|         |         |         |         |         |         |         |         |

Name

Signature

\_\_\_\_\_  
\_\_\_\_\_





# Tawastia Open Karate 2/2024

Liivuoentie 24, Hmeenlinna, FINLAND

|             |                             |         |            |             |                                       |                |    |
|-------------|-----------------------------|---------|------------|-------------|---------------------------------------|----------------|----|
| Court Nr.   | 1                           | Pool    | 1          | Date        | 2024-10-06                            | Field Position | 61 |
| <b>RED</b>  |                             |         |            | <b>BLUE</b> |                                       |                |    |
| NOC         | KIVIKOSKI JERE (LK-FIN,FIN) |         |            | NOC         | ALGAHAWI YAKOOT (BUDOKWAI KARATE,FIN) |                |    |
| Category    | Kumite, pojat, U16, +70 kg  |         |            |             |                                       |                |    |
| 3 Points    | 2 Points                    | 1 Point | Score      | 1 Point     | 2 Points                              | 3 Points       |    |
|             |                             |         | 2 : 2      |             |                                       |                |    |
| Penatlity   |                             |         |            | Penatlity   |                                       |                |    |
| C1: HC, C2: |                             |         | <b>2:2</b> | C1: , C2:   |                                       |                |    |
|             |                             |         | Total      | WINNER      |                                       |                |    |

HT

## Decision of Superiority

| Judge 1 | Judge 2 | Judge 3 | Judge 4 | Judge 5 | Judge 6 | Judge 7 | Referee |
|---------|---------|---------|---------|---------|---------|---------|---------|
|         |         |         |         |         |         |         |         |

Name

Signature

\_\_\_\_\_  
\_\_\_\_\_



# Tawastia Open Karate 2/2024

Liivuoentie 24, Hmeenlinna, FINLAND

|             |                              |         |            |             |                              |                |    |
|-------------|------------------------------|---------|------------|-------------|------------------------------|----------------|----|
| Court Nr.   | 1                            | Pool    | 1          | Date        | 2024-10-06                   | Field Position | 62 |
| <b>RED</b>  |                              |         |            | <b>BLUE</b> |                              |                |    |
| NOC         | PIENIMKI ROOPE (JIGOTAI,FIN) |         |            | NOC         | HUUSKONEN VEETI (LK-FIN,FIN) |                |    |
| Category    | Kumite, pojat, U16, +70 kg   |         |            |             |                              |                |    |
| 3 Points    | 2 Points                     | 1 Point | Score      | 1 Point     | 2 Points                     | 3 Points       |    |
|             |                              |         | 0 : 2      |             |                              |                |    |
| Penatlity   |                              |         |            | Penatlity   |                              |                |    |
| C1: C2, C2: |                              |         | <b>0:2</b> | C1: C1, C2: |                              |                |    |
|             |                              |         | Total      | WINNER      |                              |                |    |

PTS

## Decision of Superiority

|         |         |         |         |         |         |         |         |
|---------|---------|---------|---------|---------|---------|---------|---------|
| Judge 1 | Judge 2 | Judge 3 | Judge 4 | Judge 5 | Judge 6 | Judge 7 | Referee |
|         |         |         |         |         |         |         |         |

Name

Signature

\_\_\_\_\_  
\_\_\_\_\_



# Tawastia Open Karate 2/2024

Liivuoentie 24, Hmeenlinna, FINLAND

|            |                                       |         |            |             |                              |                |    |
|------------|---------------------------------------|---------|------------|-------------|------------------------------|----------------|----|
| Court Nr.  | 1                                     | Pool    | 1          | Date        | 2024-10-06                   | Field Position | 63 |
| <b>RED</b> |                                       |         |            | <b>BLUE</b> |                              |                |    |
| NOC        | ALGAHAWI YAKOOT (BUDOKWAI KARATE,FIN) |         |            | NOC         | HUUSKONEN VEETI (LK-FIN,FIN) |                |    |
| Category   | Kumite, pojat, U16, +70 kg            |         |            |             |                              |                |    |
| 3 Points   | 2 Points                              | 1 Point | Score      | 1 Point     | 2 Points                     | 3 Points       |    |
|            |                                       |         | 0 : 0      |             |                              |                |    |
| Penatlity  |                                       |         |            | Penatlity   |                              |                |    |
| C1: , C2:  |                                       |         | <b>0:0</b> | C1: H, C2:  |                              |                |    |
| WINNER     |                                       |         | Total      |             |                              |                |    |

HA

## Decision of Superiority

| Judge 1 | Judge 2 | Judge 3 | Judge 4 | Judge 5 | Judge 6 | Judge 7 | Referee |
|---------|---------|---------|---------|---------|---------|---------|---------|
|         |         |         |         |         |         |         |         |

Name

Signature





\_\_\_\_\_  
\_\_\_\_\_





## Tawastia Open Karate 2/2024 - 2024-10-05

## Official Results

| Kumite, pojat, U16, +70 kg |                 |                       |   |               |
|----------------------------|-----------------|-----------------------|---|---------------|
| 1                          | ALGAHAWI YAKOOT | BUDOKWAI RY<br>KARATE |  | FIN - FINLAND |
| 2                          | HUUSKONEN VEETI | LAHDEN KARATE         |  | FIN - FINLAND |
| 3                          | KIVIKOSKI JERE  | LAHDEN KARATE         |  | FIN - FINLAND |
| 4                          | PIENIMÄKI ROOPE | JIGOTAI KARATE        |  | FIN - FINLAND |

# KUMITE, POJAT, U16, -52 KG

Tawastia Open Karate 2/2024

**ENTRIES BY WEIGHT CATEGORY**  
**Kumite, pojat, U16, -52 kg**

As of 6 OCT 2024

| Country Code | ID | Gender | Name            | Seeding |
|--------------|----|--------|-----------------|---------|
| FIN          |    | M      | Anttila Ken     |         |
| FIN          |    | M      | Kettunen Eemeli |         |
| FIN          |    | M      | Mattinen Nuutti |         |
| FIN          |    | M      | Muurinaho Luka  |         |
| FIN          |    | M      | Tarkkanen Otso  |         |

Kumite, pojat, U16, -52 kg

Tawastia Open Karate 2/2024, Liivourentie 24, Hämeenlinna, FIN

2024-10-05

Tatami  
3 13:00

Pool  
1/1

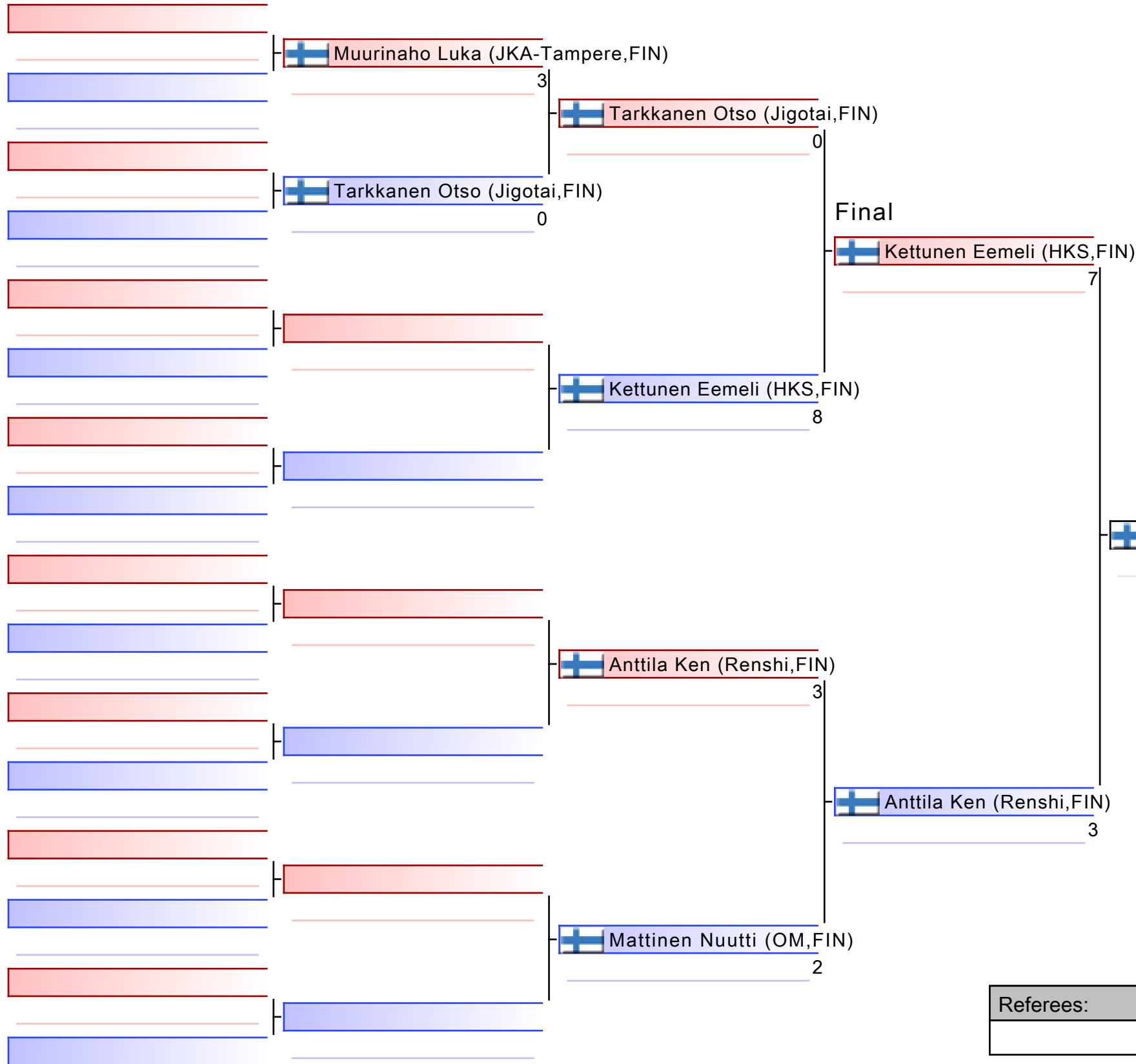

|                                 |
|---------------------------------|
| 1. KETTUNEN EEMELI (HKS,FIN)    |
| 2. ANTTILA KEN (RENSHI,FIN)     |
| 3. MATTINEN NUUTTI (OM,FIN)     |
| 4. TARKKANEN OTSO (JIGOTAI,FIN) |
|                                 |
|                                 |
|                                 |

|           |  |  |  |
|-----------|--|--|--|
| Referees: |  |  |  |
|           |  |  |  |



Kumite, pojat, U16, -52 kg

Tawastia Open Karate 2/2024

2024-10-05

Tatami  
3 13:00

Pool  
1

(c)sportdata GmbH & Co KG 2000-2024 (2024-10-06 10:03) v 10.2.0 build 1 (2024-09-26 10:14 CET) License: Online\_Event\_ID-8546\_TawastiaOpenKarate2024 (expire 2024-10-20)

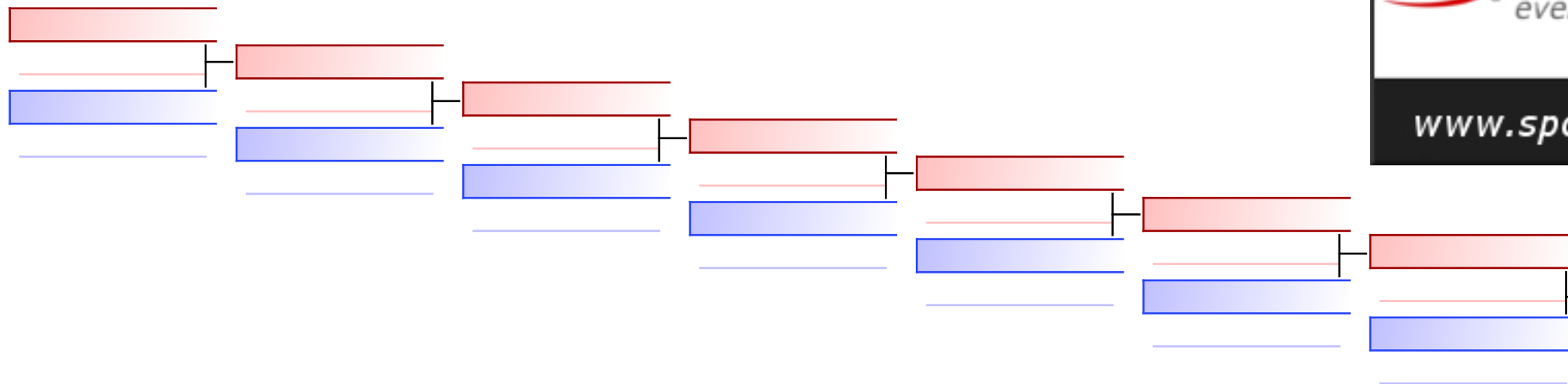

REPECHAGE: (1)

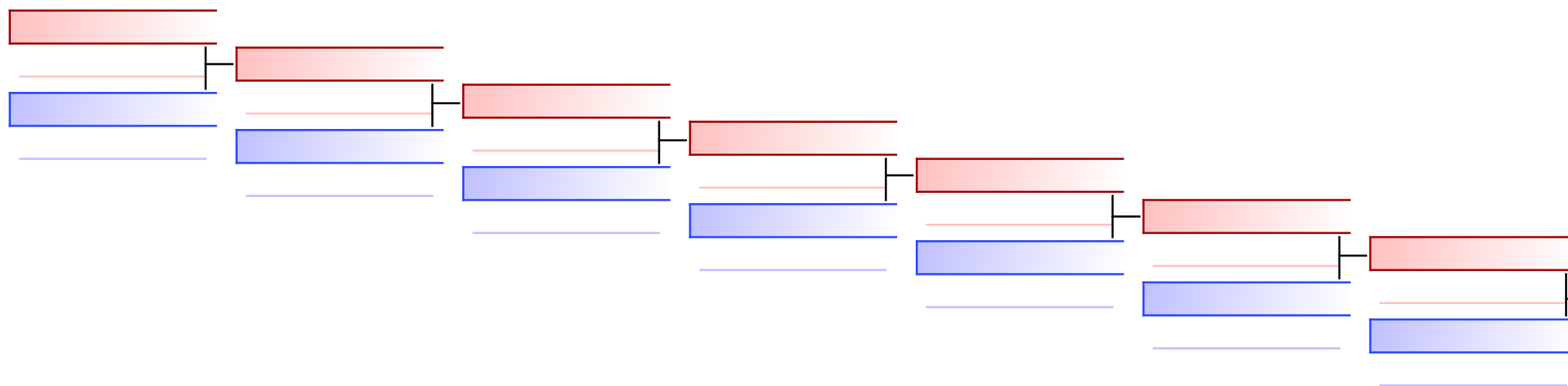

🇫🇮 Tarkkanen Otso (Jigotai,FIN)  
1

🇫🇮 Mattinen Nuutti (OM,FIN)

🇫🇮 Mattinen Nuutti (OM,FIN)  
9

|           |  |  |  |  |  |  |  |
|-----------|--|--|--|--|--|--|--|
| Referees: |  |  |  |  |  |  |  |
|-----------|--|--|--|--|--|--|--|

# Tawastia Open Karate 2/2024

Liivuoentie 24, Hmeenlinna, FINLAND

|            |                                  |         |       |             |                              |                |    |
|------------|----------------------------------|---------|-------|-------------|------------------------------|----------------|----|
| Court Nr.  | 1                                | Pool    | 1     | Date        | 2024-10-06                   | Field Position | 57 |
| <b>RED</b> |                                  |         |       | <b>BLUE</b> |                              |                |    |
| NOC        | MUURINAHO LUKA (JKA-TAMPERE,FIN) |         |       | NOC         | TARKKANEN OTSO (JIGOTAI,FIN) |                |    |
| Category   | Kumite, pojat, U16, -52 kg       |         |       |             |                              |                |    |
| 3 Points   | 2 Points                         | 1 Point | Score | 1 Point     | 2 Points                     | 3 Points       |    |
|            |                                  |         | 3 : 0 |             |                              |                |    |
| Penatlity  |                                  |         |       | Penatlity   |                              |                |    |
| C1: H, C2: |                                  |         |       | <b>3:0</b>  | C1: , C2:                    |                |    |
|            |                                  |         |       | Total       | WINNER                       |                |    |

HA

## Decision of Superiority

| Judge 1 | Judge 2 | Judge 3 | Judge 4 | Judge 5 | Judge 6 | Judge 7 | Referee |
|---------|---------|---------|---------|---------|---------|---------|---------|
|         |         |         |         |         |         |         |         |

Name \_\_\_\_\_

Signature \_\_\_\_\_



# Tawastia Open Karate 2/2024

Liivuoventie 24, Hmeenlinna, FINLAND

|           |                              |         |       |           |                           |                |    |
|-----------|------------------------------|---------|-------|-----------|---------------------------|----------------|----|
| Court Nr. | 1                            | Pool    | 1     | Date      | 2024-10-06                | Field Position | 61 |
| RED       |                              |         |       | BLUE      |                           |                |    |
| NOC       | TARKKANEN OTSO (JIGOTAI,FIN) |         |       | NOC       | KETTUNEN EEMELI (HKS,FIN) |                |    |
| Category  | Kumite, pojat, U16, -52 kg   |         |       |           |                           |                |    |
| 3 Points  | 2 Points                     | 1 Point | Score | 1 Point   | 2 Points                  | 3 Points       |    |
|           |                              |         | 0 : 8 |           |                           |                |    |
| Penatlity |                              |         |       | Penatlity |                           |                |    |
| C1: , C2: |                              |         |       | 0:8       | C1: C1, C2:               |                |    |
|           |                              |         |       | Total     | WINNER                    |                |    |

PTS

### Decision of Superiority

| Judge 1 | Judge 2 | Judge 3 | Judge 4 | Judge 5 | Judge 6 | Judge 7 | Referee |
|---------|---------|---------|---------|---------|---------|---------|---------|
|         |         |         |         |         |         |         |         |

Name \_\_\_\_\_

Signature \_\_\_\_\_



# Tawastia Open Karate 2/2024

Liivuoentie 24, Hmeenlinna, FINLAND

|             |                            |         |            |             |                          |                |    |
|-------------|----------------------------|---------|------------|-------------|--------------------------|----------------|----|
| Court Nr.   | 1                          | Pool    | 1          | Date        | 2024-10-06               | Field Position | 62 |
| <b>RED</b>  |                            |         |            | <b>BLUE</b> |                          |                |    |
| NOC         | ANTTILA KEN (RENSHI,FIN)   |         |            | NOC         | MATTINEN NUUTTI (OM,FIN) |                |    |
| Category    | Kumite, pojat, U16, -52 kg |         |            |             |                          |                |    |
| 3 Points    | 2 Points                   | 1 Point | Score      | 1 Point     | 2 Points                 | 3 Points       |    |
|             |                            |         | 3 : 2      |             |                          |                |    |
| Penatlity   |                            |         |            | Penatlity   |                          |                |    |
| C1: C1, C2: |                            |         | <b>3:2</b> | C1: , C2:   |                          |                |    |
| WINNER      |                            |         | Total      |             |                          |                |    |

PTS

## Decision of Superiority

| Judge 1 | Judge 2 | Judge 3 | Judge 4 | Judge 5 | Judge 6 | Judge 7 | Referee |
|---------|---------|---------|---------|---------|---------|---------|---------|
|         |         |         |         |         |         |         |         |

Name \_\_\_\_\_

Signature \_\_\_\_\_



# Tawastia Open Karate 2/2024

Liivuoentie 24, Hmeenlinna, FINLAND

|             |                            |         |            |             |                          |                |    |
|-------------|----------------------------|---------|------------|-------------|--------------------------|----------------|----|
| Court Nr.   | 1                          | Pool    | 1          | Date        | 2024-10-06               | Field Position | 63 |
| <b>RED</b>  |                            |         |            | <b>BLUE</b> |                          |                |    |
| NOC         | KETTUNEN EEMELI (HKS,FIN)  |         |            | NOC         | ANTTILA KEN (RENSHI,FIN) |                |    |
| Category    | Kumite, pojat, U16, -52 kg |         |            |             |                          |                |    |
| 3 Points    | 2 Points                   | 1 Point | Score      | 1 Point     | 2 Points                 | 3 Points       |    |
|             |                            |         | 7 : 3      |             |                          |                |    |
| Penatlity   |                            |         |            | Penatlity   |                          |                |    |
| C1: C1, C2: |                            |         | <b>7:3</b> | C1: C1, C2: |                          |                |    |
| WINNER      |                            |         | Total      |             |                          |                |    |

PTS

## Decision of Superiority

| Judge 1 | Judge 2 | Judge 3 | Judge 4 | Judge 5 | Judge 6 | Judge 7 | Referee |
|---------|---------|---------|---------|---------|---------|---------|---------|
|         |         |         |         |         |         |         |         |

Name





Signature

\_\_\_\_\_  
\_\_\_\_\_





## Official Results

| Kumite, pojat, U16, -52 kg |                 |                             |   |               |
|----------------------------|-----------------|-----------------------------|---|---------------|
| 1                          | KETTUNEN EEMELI | HÄMEENLINNAN<br>KARATESEURA |  | FIN - FINLAND |
| 2                          | ANTTILA KEN     | RENSHIN-KAN RY              |  | FIN - FINLAND |
| 3                          | MATTINEN NUUTTI | SPORTSKARATE<br>KUOPIO      |  | FIN - FINLAND |
| 4                          | TARKKANEN OTSO  | JIGOTAI KARATE              |  | FIN - FINLAND |

# KUMITE, POJAT, U16, -57 KG



Tawastia Open Karate 2/2024

**ENTRIES BY WEIGHT CATEGORY**  
**Kumite, pojat, U16, -57 kg**

As of 6 OCT 2024

| Country Code | ID | Gender | Name                  | Seeding |
|--------------|----|--------|-----------------------|---------|
| FIN          |    | M      | Hanhinen Onni         |         |
| FIN          |    | M      | Hirvonen Jesse        |         |
| FIN          |    | M      | Illanganthilake Ishan |         |
| FIN          |    | M      | Jrvenp Tatu           |         |
| FIN          |    | M      | Lauronen Leo          |         |
| FIN          |    | M      | Sandgren Joonas       |         |
| FIN          |    | M      | Simonen Tino          |         |
| FIN          |    | M      | Sil Voitto            |         |
| FIN          |    | M      | Tameh Mohammed        |         |
| FIN          |    | M      | Vaara Santeri         |         |
| FIN          |    | M      | Vyrynen Luukas        |         |

# Kumite, pojat, U16, -57 kg

Tawastia Open Karate 2/2024, Liiviuorentie 24, Hämeenlinna, FIN

2024-10-05

Tatami  
3 13:25

Pool  
1/1

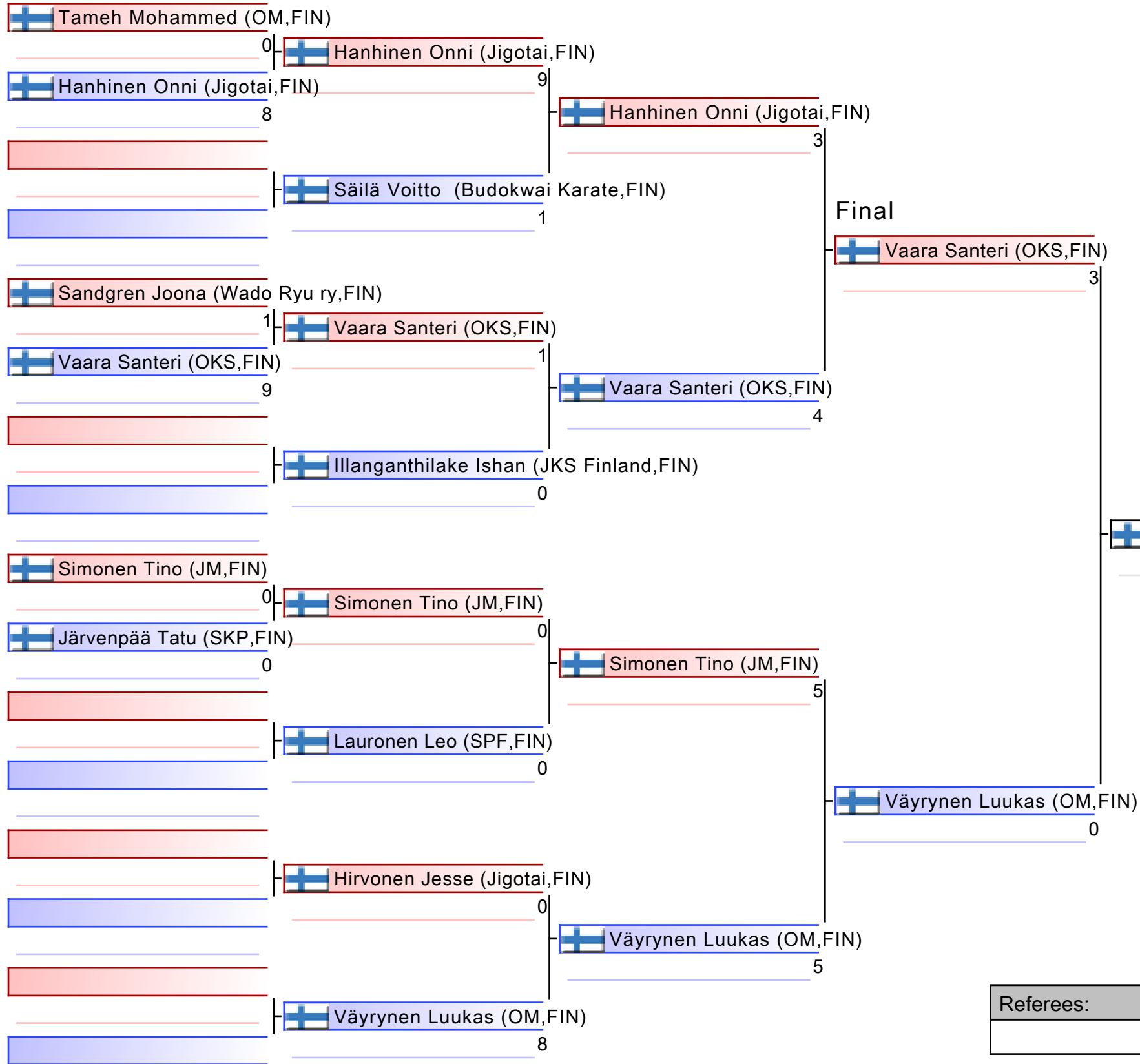

|  |
|--|
| 1. VAARA SANTERI (OKS,FIN)                 |
| 2. VÄYRYNEN LUUKAS (OM,FIN)                |
| 3. SIMONEN TINO (JM,FIN)                   |
| 4. ILLANGANTHILAKE ISHAN (JKS FINLAND,FIN) |
| 5. HIRVONEN JESSE (JIGOTAI,FIN)            |
| 5. HANHINEN ONNI (JIGOTAI,FIN)             |
| 7. SANDGREN JOONA (WADO RYU RY,FIN)        |

|           |  |  |  |
|-----------|--|--|--|
| Referees: |  |  |  |
|           |  |  |  |

# Kumite, pojat, U16, -57 kg

Tawastia Open Karate 2/2024

2024-10-05

Tatami  
3 13:25

Pool  
1

(c)sportdata GmbH & Co KG 2000-2024 (2024-10-06 10:03) v 10.2.0 build 1 (2024-09-26 10:14 CET) License: Online\_Event\_ID-8546\_TawastiaOpenKarate2024 (expire 2024-10-20)

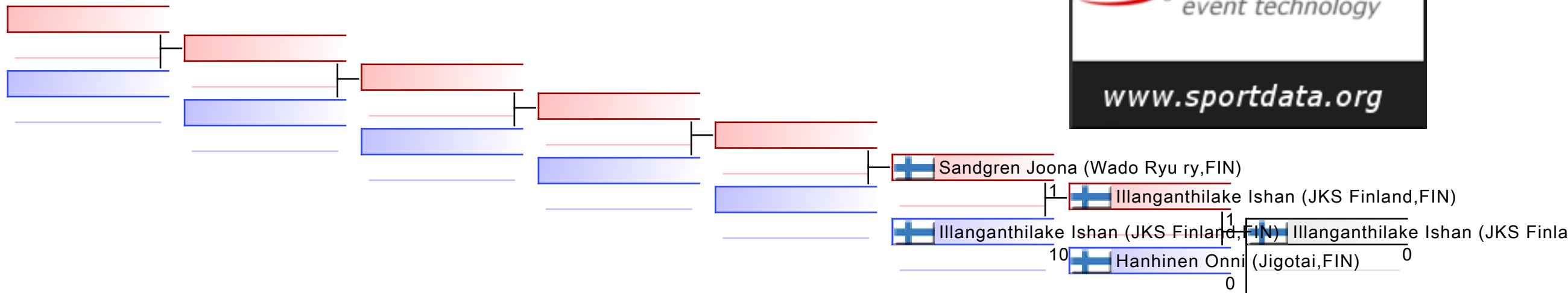

## REPECHAGE: (1)

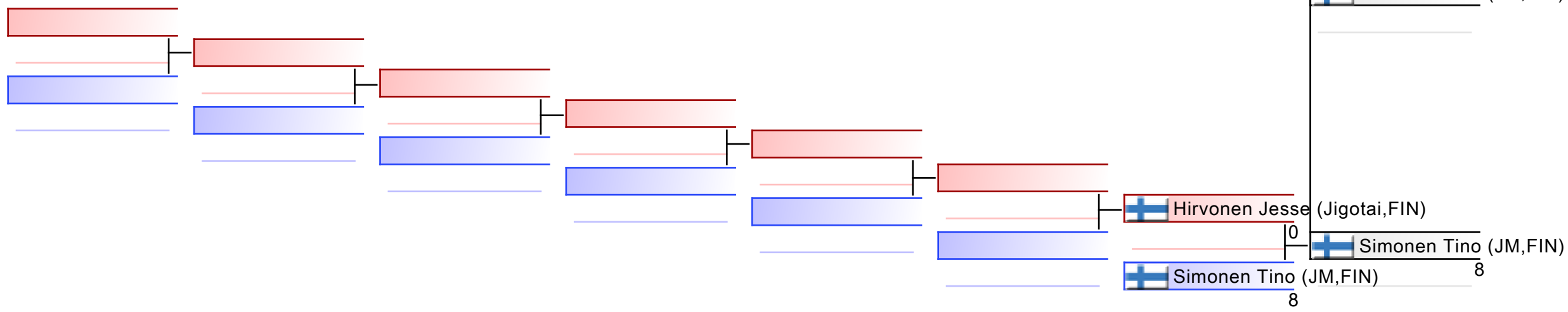

|           |  |  |  |  |  |  |  |
|-----------|--|--|--|--|--|--|--|
| Referees: |  |  |  |  |  |  |  |
|-----------|--|--|--|--|--|--|--|

# Tawastia Open Karate 2/2024

Liivuoentie 24, Hmeenlinna, FINLAND

|            |                            |         |            |             |                             |                |    |
|------------|----------------------------|---------|------------|-------------|-----------------------------|----------------|----|
| Court Nr.  | 1                          | Pool    | 1          | Date        | 2024-10-06                  | Field Position | 49 |
| <b>RED</b> |                            |         |            | <b>BLUE</b> |                             |                |    |
| NOC        | TAMEH MOHAMMED (OM,FIN)    |         |            | NOC         | HANHINEN ONNI (JIGOTAI,FIN) |                |    |
| Category   | Kumite, pojat, U16, -57 kg |         |            |             |                             |                |    |
| 3 Points   | 2 Points                   | 1 Point | Score      | 1 Point     | 2 Points                    | 3 Points       |    |
|            |                            |         | 0 : 8      |             |                             |                |    |
| Penatlity  |                            |         |            | Penatlity   |                             |                |    |
| C1: , C2:  |                            |         | <b>0:8</b> | C1: , C2:   |                             |                |    |
|            |                            |         | Total      | WINNER      |                             |                |    |

KI

## Decision of Superiority

| Judge 1 | Judge 2 | Judge 3 | Judge 4 | Judge 5 | Judge 6 | Judge 7 | Referee |
|---------|---------|---------|---------|---------|---------|---------|---------|
|         |         |         |         |         |         |         |         |

Name

Signature

\_\_\_\_\_  
\_\_\_\_\_



# Tawastia Open Karate 2/2024

Liivuoentie 24, Hmeenlinna, FINLAND

|            |                                  |         |            |             |                         |                |    |
|------------|----------------------------------|---------|------------|-------------|-------------------------|----------------|----|
| Court Nr.  | 1                                | Pool    | 1          | Date        | 2024-10-06              | Field Position | 51 |
| <b>RED</b> |                                  |         |            | <b>BLUE</b> |                         |                |    |
| NOC        | SANDGREN JOONA (WADO RYU RY,FIN) |         |            | NOC         | VAARA SANTERI (OKS,FIN) |                |    |
| Category   | Kumite, pojat, U16, -57 kg       |         |            |             |                         |                |    |
| 3 Points   | 2 Points                         | 1 Point | Score      | 1 Point     | 2 Points                | 3 Points       |    |
|            |                                  |         | 1 : 9      |             |                         |                |    |
| Penatlity  |                                  |         |            | Penatlity   |                         |                |    |
| C1: , C2:  |                                  |         | <b>1:9</b> | C1: C3, C2: |                         |                |    |
|            |                                  |         | Total      | WINNER      |                         |                |    |

PTS

## Decision of Superiority

| Judge 1 | Judge 2 | Judge 3 | Judge 4 | Judge 5 | Judge 6 | Judge 7 | Referee |
|---------|---------|---------|---------|---------|---------|---------|---------|
|         |         |         |         |         |         |         |         |

Name

Signature

\_\_\_\_\_  
\_\_\_\_\_



# Tawastia Open Karate 2/2024

Liivuoventie 24, Hmeenlinna, FINLAND

|            |                            |         |            |             |                       |                |    |
|------------|----------------------------|---------|------------|-------------|-----------------------|----------------|----|
| Court Nr.  | 1                          | Pool    | 1          | Date        | 2024-10-06            | Field Position | 53 |
| <b>RED</b> |                            |         |            | <b>BLUE</b> |                       |                |    |
| NOC        | SIMONEN TINO (JM,FIN)      |         |            | NOC         | JRVENP TATU (SKP,FIN) |                |    |
| Category   | Kumite, pojat, U16, -57 kg |         |            |             |                       |                |    |
| 3 Points   | 2 Points                   | 1 Point | Score      | 1 Point     | 2 Points              | 3 Points       |    |
|            |                            |         | 0 : 0      |             |                       |                |    |
| Penatlity  |                            |         |            | Penatlity   |                       |                |    |
| C1: , C2:  |                            |         | <b>0:0</b> | C1: , C2:   |                       |                |    |
| WINNER     |                            |         | Total      |             |                       |                |    |

HT

## Decision of Superiority

| Judge 1 | Judge 2 | Judge 3 | Judge 4 | Judge 5 | Judge 6 | Judge 7 | Referee |
|---------|---------|---------|---------|---------|---------|---------|---------|
|         |         |         |         |         |         |         |         |

Name

Signature

\_\_\_\_\_  
\_\_\_\_\_



# Tawastia Open Karate 2/2024

Liivuoentie 24, Hmeenlinna, FINLAND

|             |                             |         |            |             |                                  |                |    |
|-------------|-----------------------------|---------|------------|-------------|----------------------------------|----------------|----|
| Court Nr.   | 1                           | Pool    | 1          | Date        | 2024-10-06                       | Field Position | 57 |
| <b>RED</b>  |                             |         |            | <b>BLUE</b> |                                  |                |    |
| NOC         | HANHINEN ONNI (JIGOTAI,FIN) |         |            | NOC         | SIL VOITTO (BUDOKWAI KARATE,FIN) |                |    |
| Category    | Kumite, pojat, U16, -57 kg  |         |            |             |                                  |                |    |
| 3 Points    | 2 Points                    | 1 Point | Score      | 1 Point     | 2 Points                         | 3 Points       |    |
|             |                             |         | 9 : 1      |             |                                  |                |    |
| Penatlity   |                             |         |            | Penatlity   |                                  |                |    |
| C1: HC, C2: |                             |         | <b>9:1</b> | C1: , C2:   |                                  |                |    |
| WINNER      |                             |         | Total      |             |                                  |                |    |

PTS

## Decision of Superiority

| Judge 1 | Judge 2 | Judge 3 | Judge 4 | Judge 5 | Judge 6 | Judge 7 | Referee |
|---------|---------|---------|---------|---------|---------|---------|---------|
|         |         |         |         |         |         |         |         |

Name \_\_\_\_\_

Signature \_\_\_\_\_



# Tawastia Open Karate 2/2024

Liivuoentie 24, Hmeenlinna, FINLAND

|            |                            |         |            |             |   |                |    |
|------------|----------------------------|---------|------------|-------------|---|----------------|----|
| Court Nr.  | 1                          | Pool    | 1          | Date        | 2024-10-06                              | Field Position | 58 |
| <b>RED</b> |                            |         |            | <b>BLUE</b> |   |                |    |
| NOC        | VAARA SANTERI (OKS,FIN)    |         |            | NOC         | ILLANGANTHILAKE ISHAN (JKS FINLAND,FIN) |                |    |
| Category   | Kumite, pojat, U16, -57 kg |         |            |             |   |                |    |
| 3 Points   | 2 Points                   | 1 Point | Score      | 1 Point     | 2 Points                                | 3 Points       |    |
|            |                            |         | 1 : 0      |             |   |                |    |
| Penatlity  |                            |         |            | Penatlity   |   |                |    |
| C1: , C2:  |                            |         | <b>1:0</b> | C1: C2, C2: |   |                |    |
| WINNER     |                            |         | Total      |             |   |                |    |

PTS

## Decision of Superiority

| Judge 1 | Judge 2 | Judge 3 | Judge 4 | Judge 5 | Judge 6 | Judge 7 | Referee |
|---------|---------|---------|---------|---------|---------|---------|---------|
|         |         |         |         |         |         |         |         |

Name

Signature

\_\_\_\_\_  
\_\_\_\_\_





# Tawastia Open Karate 2/2024

Liivuoentie 24, Hmeenlinna, FINLAND

|             |                            |         |            |             |                        |                |    |
|-------------|----------------------------|---------|------------|-------------|------------------------|----------------|----|
| Court Nr.   | 1                          | Pool    | 1          | Date        | 2024-10-06             | Field Position | 59 |
| <b>RED</b>  |                            |         |            | <b>BLUE</b> |                        |                |    |
| NOC         | SIMONEN TINO (JM,FIN)      |         |            | NOC         | LAURONEN LEO (SPF,FIN) |                |    |
| Category    | Kumite, pojat, U16, -57 kg |         |            |             |                        |                |    |
| 3 Points    | 2 Points                   | 1 Point | Score      | 1 Point     | 2 Points               | 3 Points       |    |
|             |                            |         | 0 : 0      |             |                        |                |    |
| Penatlity   |                            |         |            | Penatlity   |                        |                |    |
| C1: C2, C2: |                            |         | <b>0:0</b> | C1: H, C2:  |                        |                |    |
| WINNER      |                            |         | Total      |             |                        |                |    |

HA

## Decision of Superiority

| Judge 1 | Judge 2 | Judge 3 | Judge 4 | Judge 5 | Judge 6 | Judge 7 | Referee |
|---------|---------|---------|---------|---------|---------|---------|---------|
|         |         |         |         |         |         |         |         |

Name

Signature

\_\_\_\_\_  
\_\_\_\_\_



# Tawastia Open Karate 2/2024

Liivuoentie 24, Hmeenlinna, FINLAND

|             |                              |         |            |             |                         |                |    |
|-------------|------------------------------|---------|------------|-------------|-------------------------|----------------|----|
| Court Nr.   | 1                            | Pool    | 1          | Date        | 2024-10-06              | Field Position | 60 |
| <b>RED</b>  |                              |         |            | <b>BLUE</b> |                         |                |    |
| NOC         | HIRVONEN JESSE (JIGOTAI,FIN) |         |            | NOC         | VYRYNEN LUUKAS (OM,FIN) |                |    |
| Category    | Kumite, pojat, U16, -57 kg   |         |            |             |                         |                |    |
| 3 Points    | 2 Points                     | 1 Point | Score      | 1 Point     | 2 Points                | 3 Points       |    |
|             |                              |         | 0 : 8      |             |                         |                |    |
| Penatlity   |                              |         |            | Penatlity   |                         |                |    |
| C1: C1, C2: |                              |         | <b>0:8</b> | C1: , C2:   |                         |                |    |
|             |                              |         | Total      |             |                         |                |    |

## Decision of Superiority

|         |         |         |         |         |         |         |         |
|---------|---------|---------|---------|---------|---------|---------|---------|
| Judge 1 | Judge 2 | Judge 3 | Judge 4 | Judge 5 | Judge 6 | Judge 7 | Referee |
|         |         |         |         |         |         |         |         |

Name

Signature

\_\_\_\_\_  
\_\_\_\_\_



# Tawastia Open Karate 2/2024

Liivuoentie 24, Hmeenlinna, FINLAND

|            |                             |         |            |             |                         |                |    |
|------------|-----------------------------|---------|------------|-------------|-------------------------|----------------|----|
| Court Nr.  | 1                           | Pool    | 1          | Date        | 2024-10-06              | Field Position | 61 |
| <b>RED</b> |                             |         |            | <b>BLUE</b> |                         |                |    |
| NOC        | HANHINEN ONNI (JIGOTAI,FIN) |         |            | NOC         | VAARA SANTERI (OKS,FIN) |                |    |
| Category   | Kumite, pojat, U16, -57 kg  |         |            |             |                         |                |    |
| 3 Points   | 2 Points                    | 1 Point | Score      | 1 Point     | 2 Points                | 3 Points       |    |
|            |                             |         | 3 : 4      |             |                         |                |    |
| Penatlity  |                             |         |            | Penatlity   |                         |                |    |
| C1: , C2:  |                             |         | <b>3:4</b> | C1: C2, C2: |                         |                |    |
|            |                             |         | Total      | WINNER      |                         |                |    |

PTS

## Decision of Superiority

| Judge 1 | Judge 2 | Judge 3 | Judge 4 | Judge 5 | Judge 6 | Judge 7 | Referee |
|---------|---------|---------|---------|---------|---------|---------|---------|
|         |         |         |         |         |         |         |         |

Name

Signature

\_\_\_\_\_  
\_\_\_\_\_



# Tawastia Open Karate 2/2024

Liivuoentie 24, Hmeenlinna, FINLAND

|             |                            |         |            |             |                         |                |    |
|-------------|----------------------------|---------|------------|-------------|-------------------------|----------------|----|
| Court Nr.   | 1                          | Pool    | 1          | Date        | 2024-10-06              | Field Position | 62 |
| <b>RED</b>  |                            |         |            | <b>BLUE</b> |                         |                |    |
| NOC         | SIMONEN TINO (JM,FIN)      |         |            | NOC         | VYRYNEN LUUKAS (OM,FIN) |                |    |
| Category    | Kumite, pojat, U16, -57 kg |         |            |             |                         |                |    |
| 3 Points    | 2 Points                   | 1 Point | Score      | 1 Point     | 2 Points                | 3 Points       |    |
|             |                            |         | 5 : 5      |             |                         |                |    |
| Penatlity   |                            |         |            | Penatlity   |                         |                |    |
| C1: C1, C2: |                            |         | <b>5:5</b> | C1: C2, C2: |                         |                |    |
|             |                            |         | Total      | WINNER      |                         |                |    |

HT

## Decision of Superiority

| Judge 1 | Judge 2 | Judge 3 | Judge 4 | Judge 5 | Judge 6 | Judge 7 | Referee |
|---------|---------|---------|---------|---------|---------|---------|---------|
|         |         |         |         |         |         |         |         |

Name

Signature

\_\_\_\_\_  
\_\_\_\_\_



# Tawastia Open Karate 2/2024

Liivuoentie 24, Hmeenlinna, FINLAND

|             |                            |         |            |             |                         |                |    |
|-------------|----------------------------|---------|------------|-------------|-------------------------|----------------|----|
| Court Nr.   | 1                          | Pool    | 1          | Date        | 2024-10-06              | Field Position | 63 |
| <b>RED</b>  |                            |         |            | <b>BLUE</b> |                         |                |    |
| NOC         | VAARA SANTERI (OKS,FIN)    |         |            | NOC         | VYRYNEN LUUKAS (OM,FIN) |                |    |
| Category    | Kumite, pojat, U16, -57 kg |         |            |             |                         |                |    |
| 3 Points    | 2 Points                   | 1 Point | Score      | 1 Point     | 2 Points                | 3 Points       |    |
|             |                            |         | 3 : 0      |             |                         |                |    |
| Penatlity   |                            |         |            | Penatlity   |                         |                |    |
| C1: HC, C2: |                            |         | <b>3:0</b> | C1: , C2:   |                         |                |    |
| WINNER      |                            |         | Total      |             |                         |                |    |

PTS

## Decision of Superiority

| Judge 1 | Judge 2 | Judge 3 | Judge 4 | Judge 5 | Judge 6 | Judge 7 | Referee |
|---------|---------|---------|---------|---------|---------|---------|---------|
|         |         |         |         |         |         |         |         |

Name \_\_\_\_\_

Signature \_\_\_\_\_



# Tawastia Open Karate 2/2024

Liivuoentie 24, Hmeenlinna, FINLAND

|             |   |         |            |             |                             |                |   |
|-------------|---|---------|------------|-------------|-----------------------------|----------------|---|
| Court Nr.   | 1                                       | Pool    | 1          | Date        | 2024-10-06                  | Field Position | 0 |
| <b>RED</b>  |   |         |            | <b>BLUE</b> |                             |                |   |
| NOC         | ILLANGANTHILAKE ISHAN (JKS FINLAND,FIN) |         |            | NOC         | HANHINEN ONNI (JIGOTAI,FIN) |                |   |
| Category    | Kumite, pojat, U16, -57 kg              |         |            |             |                             |                |   |
| 3 Points    | 2 Points                                | 1 Point | Score      | 1 Point     | 2 Points                    | 3 Points       |   |
|             |   |         | 1 : 0      |             |                             |                |   |
| Penatlity   |   |         |            | Penatlity   |                             |                |   |
| C1: C1, C2: |   |         | <b>1:0</b> | C1: , C2:   |                             |                |   |
| WINNER      |   |         | Total      |             |                             |                |   |

PTS

## Decision of Superiority

| Judge 1 | Judge 2 | Judge 3 | Judge 4 | Judge 5 | Judge 6 | Judge 7 | Referee |
|---------|---------|---------|---------|---------|---------|---------|---------|
|         |         |         |         |         |         |         |         |

Name

Signature

\_\_\_\_\_  
\_\_\_\_\_



# Tawastia Open Karate 2/2024

Liivuoentie 24, Hmeenlinna, FINLAND

|            |                                  |         |       |             |   |                |   |
|------------|----------------------------------|---------|-------|-------------|---|----------------|---|
| Court Nr.  | 1                                | Pool    | 1     | Date        | 2024-10-06                              | Field Position | 2 |
| <b>RED</b> |                                  |         |       | <b>BLUE</b> |   |                |   |
| NOC        | SANDGREN JOONA (WADO RYU RY,FIN) |         |       | NOC         | ILLANGANTHILAKE ISHAN (JKS FINLAND,FIN) |                |   |
| Category   | Kumite, pojat, U16, -57 kg       |         |       |             |   |                |   |
| 3 Points   | 2 Points                         | 1 Point | Score | 1 Point     | 2 Points                                | 3 Points       |   |
|            |                                  |         | :     |             |   |                |   |
| Penatlity  |                                  |         |       | Penatlity   |   |                |   |
|            |                                  |         |       |             |   |                |   |
|            |                                  |         | Total |             |   |                |   |

## Decision of Superiority

|         |         |         |         |         |         |         |         |
|---------|---------|---------|---------|---------|---------|---------|---------|
| Judge 1 | Judge 2 | Judge 3 | Judge 4 | Judge 5 | Judge 6 | Judge 7 | Referee |
|         |         |         |         |         |         |         |         |

Name

Signature

\_\_\_\_\_

\_\_\_\_\_



# Tawastia Open Karate 2/2024

Liivuoentie 24, Hmeenlinna, FINLAND

|             |                              |         |            |             |                       |                |   |
|-------------|------------------------------|---------|------------|-------------|-----------------------|----------------|---|
| Court Nr.   | 2                            | Pool    | 2          | Date        | 2024-10-06            | Field Position | 0 |
| <b>RED</b>  |                              |         |            | <b>BLUE</b> |                       |                |   |
| NOC         | HIRVONEN JESSE (JIGOTAI,FIN) |         |            | NOC         | SIMONEN TINO (JM,FIN) |                |   |
| Category    | Kumite, pojat, U16, -57 kg   |         |            |             |                       |                |   |
| 3 Points    | 2 Points                     | 1 Point | Score      | 1 Point     | 2 Points              | 3 Points       |   |
|             |                              |         | 0 : 8      |             |                       |                |   |
| Penatlity   |                              |         |            | Penatlity   |                       |                |   |
| C1: C1, C2: |                              |         | <b>0:8</b> | C1: , C2:   |                       |                |   |
|             |                              |         | Total      | WINNER      |                       |                |   |

PTS

## Decision of Superiority

| Judge 1 | Judge 2 | Judge 3 | Judge 4 | Judge 5 | Judge 6 | Judge 7 | Referee |
|---------|---------|---------|---------|---------|---------|---------|---------|
|         |         |         |         |         |         |         |         |

Name

Signature







\_\_\_\_\_  
\_\_\_\_\_





## Tawastia Open Karate 2/2024 - 2024-10-05

## Official Results

| Kumite, pojat, U16, -57 kg |                       |  |   |               |
|----------------------------|-----------------------|--|---|---------------|
| 1                          | VAARA SANTERI         | OULUN<br>KARATESEURA                         |  | FIN - FINLAND |
| 2                          | VÄYRYNEN LUUKAS       | SPORTSKARATE<br>KUOPIO                       |  | FIN - FINLAND |
| 3                          | SIMONEN TINO          | JOEN MAWASHI RY                              |  | FIN - FINLAND |
| 4                          | ILLANGANTHILAKE ISHAN | JKS FINLAND -<br>SHOTOKAN KARATE<br>HELSINKI |  | FIN - FINLAND |
| 5                          | HIRVONEN JESSE        | JIGOTAI KARATE                               |  | FIN - FINLAND |
| 5                          | HANHINEN ONNI         | JIGOTAI KARATE                               |  | FIN - FINLAND |
| 7                          | SANDGRÉN JOONA        | VANTAAN WADO RYU<br>RY                       |  | FIN - FINLAND |

# KUMITE, POJAT, U16, -63 KG

Tawastia Open Karate 2/2024

**ENTRIES BY WEIGHT CATEGORY**  
**Kumite, pojat, U16, -63 kg**

As of 6 OCT 2024

| Country Code | ID | Gender | Name             | Seeding |
|--------------|----|--------|------------------|---------|
| FIN          |    | M      | Gaetti Lucas     |         |
| FIN          |    | M      | Keltto Topias    |         |
| FIN          |    | M      | Kivimki Veikko   |         |
| FIN          |    | M      | Simonen Rene     |         |
| FIN          |    | M      | Takala Anton     |         |
| FIN          |    | M      | Vartiainen Juuso |         |

# Kumite, pojat, U16, -63 kg

Tawastia Open Karate 2/2024, Liivourentie 24, Hämeenlinna, FIN

2024-10-05

Tatami  
3 14:10

Pool  
1/1

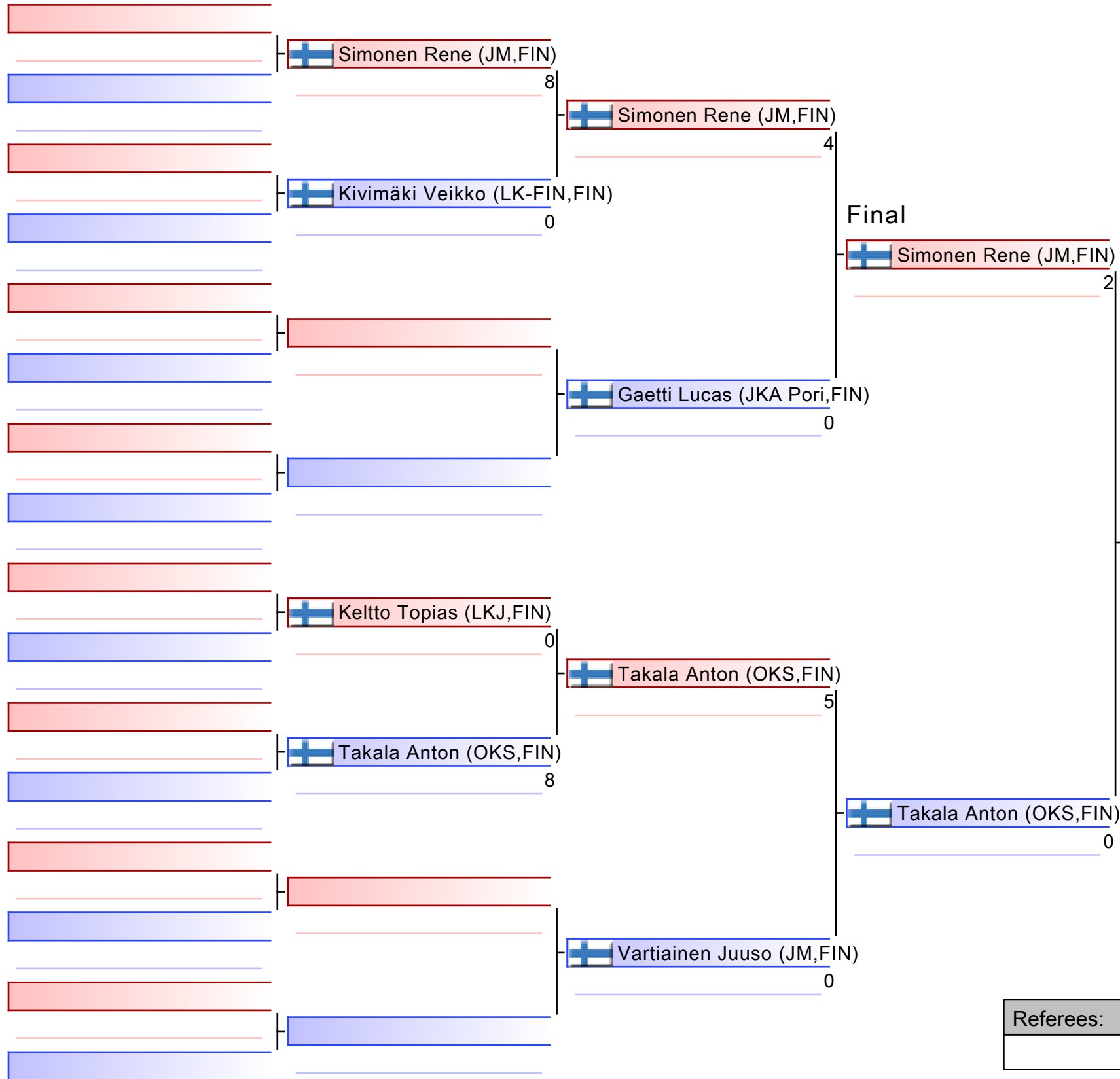

|                                 |
|---------------------------------|
| 1. SIMONEN RENE (JM,FIN)        |
| 2. TAKALA ANTON (OKS,FIN)       |
| 3. VARTIAINEN JUUSO (JM,FIN)    |
| 4. KIVIMÄKI VEIKKO (LK-FIN,FIN) |
| 5. GAETTI LUCAS (JKA PORI,FIN)  |
| 5. KELTTO TOPIAS (LKJ,FIN)      |
|                                 |
|                                 |

|           |  |  |  |
|-----------|--|--|--|
| Referees: |  |  |  |
|           |  |  |  |

# Kumite, pojat, U16, -63 kg

Tawastia Open Karate 2/2024

2024-10-05

Tatami  
3 14:10

Pool  
1

(c)sportdata GmbH & Co KG 2000-2024 (2024-10-06 10:03) v 10.2.0 build 1 (2024-09-26 10:14 CET) License: Online\_Event\_ID-8546\_TawastiaOpenKarate22024 (expire 2024-10-20)

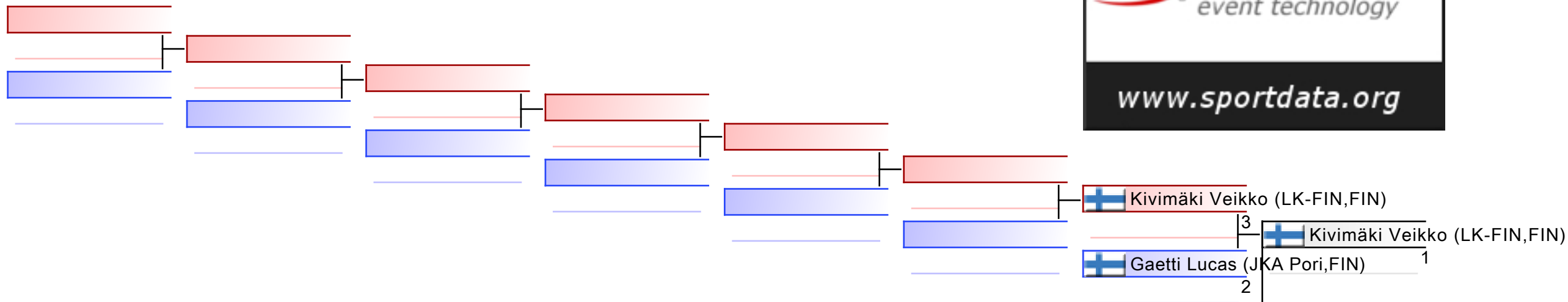

## REPECHAGE: (1)

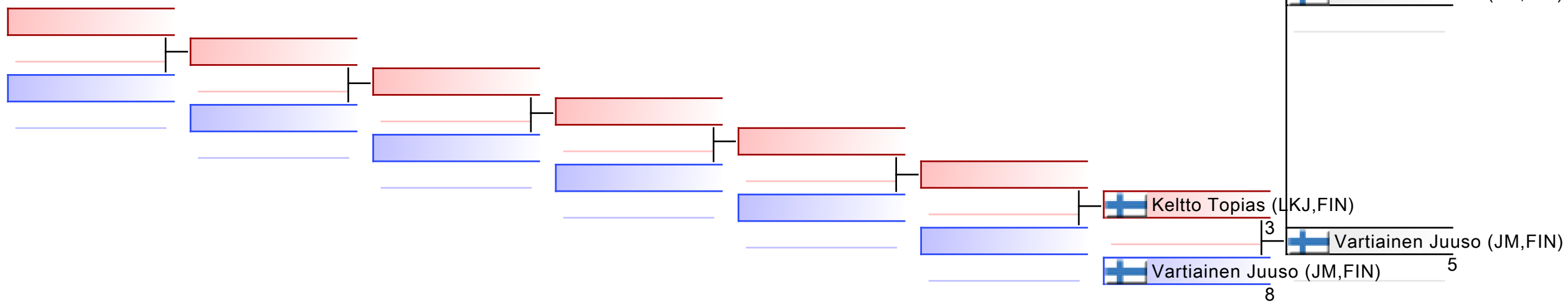

|           |  |  |  |  |  |  |  |
|-----------|--|--|--|--|--|--|--|
| Referees: |  |  |  |  |  |  |  |
|-----------|--|--|--|--|--|--|--|

# Tawastia Open Karate 2/2024

Liivuoentie 24, Hmeenlinna, FINLAND

|             |                            |         |            |             |                             |                |    |
|-------------|----------------------------|---------|------------|-------------|-----------------------------|----------------|----|
| Court Nr.   | 1                          | Pool    | 1          | Date        | 2024-10-06                  | Field Position | 57 |
| <b>RED</b>  |                            |         |            | <b>BLUE</b> |                             |                |    |
| NOC         | SIMONEN RENE (JM,FIN)      |         |            | NOC         | KIVIMKI VEIKKO (LK-FIN,FIN) |                |    |
| Category    | Kumite, pojat, U16, -63 kg |         |            |             |                             |                |    |
| 3 Points    | 2 Points                   | 1 Point | Score      | 1 Point     | 2 Points                    | 3 Points       |    |
|             |                            |         | 8 : 0      |             |                             |                |    |
| Penatlity   |                            |         |            | Penatlity   |                             |                |    |
| C1: C1, C2: |                            |         | <b>8:0</b> | C1: , C2:   |                             |                |    |
| WINNER      |                            |         | Total      |             |                             |                |    |

PTS

## Decision of Superiority

| Judge 1 | Judge 2 | Judge 3 | Judge 4 | Judge 5 | Judge 6 | Judge 7 | Referee |
|---------|---------|---------|---------|---------|---------|---------|---------|
|         |         |         |         |         |         |         |         |

Name

Signature

\_\_\_\_\_

\_\_\_\_\_



# Tawastia Open Karate 2/2024

Liivuoventie 24, Hmeenlinna, FINLAND

|            |                            |         |            |             |                        |                |    |
|------------|----------------------------|---------|------------|-------------|------------------------|----------------|----|
| Court Nr.  | 1                          | Pool    | 1          | Date        | 2024-10-06             | Field Position | 59 |
| <b>RED</b> |                            |         |            | <b>BLUE</b> |                        |                |    |
| NOC        | KELTTO TOPIAS (LKJ,FIN)    |         |            | NOC         | TAKALA ANTON (OKS,FIN) |                |    |
| Category   | Kumite, pojat, U16, -63 kg |         |            |             |                        |                |    |
| 3 Points   | 2 Points                   | 1 Point | Score      | 1 Point     | 2 Points               | 3 Points       |    |
|            |                            |         | 0 : 8      |             |                        |                |    |
| Penatlity  |                            |         |            | Penatlity   |                        |                |    |
| C1: , C2:  |                            |         | <b>0:8</b> | C1: , C2:   |                        |                |    |
|            |                            |         | Total      | WINNER      |                        |                |    |

KI

## Decision of Superiority

| Judge 1 | Judge 2 | Judge 3 | Judge 4 | Judge 5 | Judge 6 | Judge 7 | Referee |
|---------|---------|---------|---------|---------|---------|---------|---------|
|         |         |         |         |         |         |         |         |

Name

Signature

\_\_\_\_\_  
\_\_\_\_\_



# Tawastia Open Karate 2/2024

Liivuoentie 24, Hmeenlinna, FINLAND

|             |                            |         |            |             |                             |                |    |
|-------------|----------------------------|---------|------------|-------------|-----------------------------|----------------|----|
| Court Nr.   | 1                          | Pool    | 1          | Date        | 2024-10-06                  | Field Position | 61 |
| <b>RED</b>  |                            |         |            | <b>BLUE</b> |                             |                |    |
| NOC         | SIMONEN RENE (JM,FIN)      |         |            | NOC         | GAETTI LUCAS (JKA PORI,FIN) |                |    |
| Category    | Kumite, pojat, U16, -63 kg |         |            |             |                             |                |    |
| 3 Points    | 2 Points                   | 1 Point | Score      | 1 Point     | 2 Points                    | 3 Points       |    |
|             |                            |         | 4 : 0      |             |                             |                |    |
| Penatlity   |                            |         |            | Penatlity   |                             |                |    |
| C1: C2, C2: |                            |         | <b>4:0</b> | C1: C2, C2: |                             |                |    |
| WINNER      |                            |         | Total      |             |                             |                |    |

PTS

## Decision of Superiority

| Judge 1 | Judge 2 | Judge 3 | Judge 4 | Judge 5 | Judge 6 | Judge 7 | Referee |
|---------|---------|---------|---------|---------|---------|---------|---------|
|         |         |         |         |         |         |         |         |

Name \_\_\_\_\_

Signature \_\_\_\_\_





# Tawastia Open Karate 2/2024

Liivuoentie 24, Hmeenlinna, FINLAND

|             |                            |         |            |             |                           |                |    |
|-------------|----------------------------|---------|------------|-------------|---------------------------|----------------|----|
| Court Nr.   | 1                          | Pool    | 1          | Date        | 2024-10-06                | Field Position | 62 |
| <b>RED</b>  |                            |         |            | <b>BLUE</b> |                           |                |    |
| NOC         | TAKALA ANTON (OKS,FIN)     |         |            | NOC         | VARTIAINEN JUUSO (JM,FIN) |                |    |
| Category    | Kumite, pojat, U16, -63 kg |         |            |             |                           |                |    |
| 3 Points    | 2 Points                   | 1 Point | Score      | 1 Point     | 2 Points                  | 3 Points       |    |
|             |                            |         | 5 : 0      |             |                           |                |    |
| Penatlity   |                            |         |            | Penatlity   |                           |                |    |
| C1: C2, C2: |                            |         | <b>5:0</b> | C1: , C2:   |                           |                |    |
| WINNER      |                            |         | Total      |             |                           |                |    |

PTS

## Decision of Superiority

| Judge 1 | Judge 2 | Judge 3 | Judge 4 | Judge 5 | Judge 6 | Judge 7 | Referee |
|---------|---------|---------|---------|---------|---------|---------|---------|
|         |         |         |         |         |         |         |         |

Name \_\_\_\_\_

Signature \_\_\_\_\_



# Tawastia Open Karate 2/2024

Liivuoentie 24, Hmeenlinna, FINLAND

|             |                            |         |            |             |                        |                |    |
|-------------|----------------------------|---------|------------|-------------|------------------------|----------------|----|
| Court Nr.   | 1                          | Pool    | 1          | Date        | 2024-10-06             | Field Position | 63 |
| <b>RED</b>  |                            |         |            | <b>BLUE</b> |                        |                |    |
| NOC         | SIMONEN RENE (JM,FIN)      |         |            | NOC         | TAKALA ANTON (OKS,FIN) |                |    |
| Category    | Kumite, pojat, U16, -63 kg |         |            |             |                        |                |    |
| 3 Points    | 2 Points                   | 1 Point | Score      | 1 Point     | 2 Points               | 3 Points       |    |
|             |                            |         | 2 : 0      |             |                        |                |    |
| Penatlity   |                            |         |            | Penatlity   |                        |                |    |
| C1: HC, C2: |                            |         | <b>2:0</b> | C1: , C2:   |                        |                |    |
| WINNER      |                            |         | Total      |             |                        |                |    |

PTS

## Decision of Superiority

| Judge 1 | Judge 2 | Judge 3 | Judge 4 | Judge 5 | Judge 6 | Judge 7 | Referee |
|---------|---------|---------|---------|---------|---------|---------|---------|
|         |         |         |         |         |         |         |         |

Name \_\_\_\_\_

Signature \_\_\_\_\_



# Tawastia Open Karate 2/2024

Liivuoventie 24, Hmeenlinna, FINLAND

|            |                             |         |       |             |                             |                |   |
|------------|-----------------------------|---------|-------|-------------|-----------------------------|----------------|---|
| Court Nr.  | 1                           | Pool    | 1     | Date        | 2024-10-06                  | Field Position | 0 |
| <b>RED</b> |                             |         |       | <b>BLUE</b> |                             |                |   |
| NOC        | KIVIMKI VEIKKO (LK-FIN,FIN) |         |       | NOC         | GAETTI LUCAS (JKA PORI,FIN) |                |   |
| Category   | Kumite, pojat, U16, -63 kg  |         |       |             |                             |                |   |
| 3 Points   | 2 Points                    | 1 Point | Score | 1 Point     | 2 Points                    | 3 Points       |   |
|            |                             |         | :     |             |                             |                |   |
| Penatlity  |                             |         |       | Penatlity   |                             |                |   |
|            |                             |         |       |             |                             |                |   |
|            |                             |         | Total |             |                             |                |   |

## Decision of Superiority

|         |         |         |         |         |         |         |         |
|---------|---------|---------|---------|---------|---------|---------|---------|
| Judge 1 | Judge 2 | Judge 3 | Judge 4 | Judge 5 | Judge 6 | Judge 7 | Referee |
|         |         |         |         |         |         |         |         |

Name

Signature

\_\_\_\_\_

\_\_\_\_\_



# Tawastia Open Karate 2/2024

Liivuoentie 24, Hmeenlinna, FINLAND

|             |                            |         |            |             |                           |                |   |
|-------------|----------------------------|---------|------------|-------------|---------------------------|----------------|---|
| Court Nr.   | 2                          | Pool    | 2          | Date        | 2024-10-06                | Field Position | 0 |
| <b>RED</b>  |                            |         |            | <b>BLUE</b> |                           |                |   |
| NOC         | KELTTO TOPIAS (LKJ,FIN)    |         |            | NOC         | VARTIAINEN JUUSO (JM,FIN) |                |   |
| Category    | Kumite, pojat, U16, -63 kg |         |            |             |                           |                |   |
| 3 Points    | 2 Points                   | 1 Point | Score      | 1 Point     | 2 Points                  | 3 Points       |   |
|             |                            |         | 3 : 8      |             |                           |                |   |
| Penatlity   |                            |         |            | Penatlity   |                           |                |   |
| C1: C3, C2: |                            |         | <b>3:8</b> | C1: C3, C2: |                           |                |   |
|             |                            |         | Total      | WINNER      |                           |                |   |

KI

## Decision of Superiority

| Judge 1 | Judge 2 | Judge 3 | Judge 4 | Judge 5 | Judge 6 | Judge 7 | Referee |
|---------|---------|---------|---------|---------|---------|---------|---------|
|         |         |         |         |         |         |         |         |

Name







Signature

\_\_\_\_\_  
\_\_\_\_\_



## Tawastia Open Karate 2/2024 - 2024-10-05

## Official Results

| Kumite, pojat, U16, -63 kg |                  |                              |   |               |
|----------------------------|------------------|------------------------------|---|---------------|
| 1                          | SIMONEN RENE     | JOEN MAWASHI RY              |  | FIN - FINLAND |
| 2                          | TAKALA ANTON     | OULUN<br>KARATESEURA         |  | FIN - FINLAND |
| 3                          | VARTIAINEN JUUSO | JOEN MAWASHI RY              |  | FIN - FINLAND |
| 4                          | KIVIMÄKI VEIKKO  | LAHDEN KARATE                |  | FIN - FINLAND |
| 5                          | GAETTI LUCAS     | PORIN SHOTOKAN               |  | FIN - FINLAND |
| 5                          | KELTTO TOPIAS    | LAKEUDEN KARATE-<br>JUTSU RY |  | FIN - FINLAND |

# KUMITE, POJAT, U16, -70 KG

Tawastia Open Karate 2/2024

**ENTRIES BY WEIGHT CATEGORY**  
**Kumite, pojat, U16, -70 kg**

As of 6 OCT 2024

| Country Code | ID | Gender | Name              | Seeding |
|--------------|----|--------|-------------------|---------|
| FIN          |    | M      | Hokka Mikko       |         |
| FIN          |    | M      | Honkanen Santtu   |         |
| FIN          |    | M      | Lhetkangas Luka   |         |
| FIN          |    | M      | Pylvnen Anton     |         |
| FIN          |    | M      | Tkachenko Timofei |         |

# Kumite, pojat, U16, -70 kg - Round Robin (each against each)

Tawastia Open Karate 2/2024, Liivuaarentie 24, Hämeenlinna, FIN



















2024-10-05

Tatami

3 14:35

Pool

1/1

|    |  |   |   |
|----|--|---|---|
| 1  |  Pylvänen Anton (Jigotai,FIN)      | 1 |  Hokka Mikko (Renshi,FIN)      |
| 2  |  Hokka Mikko (Renshi,FIN)          | 1 |   |
| 3  |  Lähetkangas Luka (OKS,FIN)        | 4 |  Lähetkangas Luka (OKS,FIN)    |
| 4  |  Tkachenko Timofei (Jigotai,FIN)   | 0 |   |
| 5  |  Pylvänen Anton (Jigotai,FIN)      | 1 |  Pylvänen Anton (Jigotai,FIN)  |
| 6  |  Lähetkangas Luka (OKS,FIN)        | 0 |   |
| 7  |  Tkachenko Timofei (Jigotai,FIN)   | 0 |  Hokka Mikko (Renshi,FIN)      |
| 8  |  Hokka Mikko (Renshi,FIN)          | 1 |   |
| 9  |  Pylvänen Anton (Jigotai,FIN)     | 4 |  Pylvänen Anton (Jigotai,FIN) |
| 10 |  Tkachenko Timofei (Jigotai,FIN) | 0 |   |
| 11 |  Hokka Mikko (Renshi,FIN)        | 0 |  Lähetkangas Luka (OKS,FIN)  |
| 12 |  Lähetkangas Luka (OKS,FIN)      | 1 |   |



|                                    |
|------------------------------------|
| 1. PYLVÄNEN ANTON (JIGOTAI,FIN)    |
| 2. LÄHETKANGAS LUKA (OKS,FIN)      |
| 3. HOKKA MIKKO (RENSHI,FIN)        |
| 4. TKACHENKO TIMOFEI (JIGOTAI,FIN) |
|                                    |
|                                    |
|                                    |

|           |  |  |  |
|-----------|--|--|--|
| Referees: |  |  |  |
|           |  |  |  |



# Tawastia Open Karate 2/2024

Liivuoentie 24, Hmeenlinna, FINLAND

|            |                             |         |            |             |                          |                |       |
|------------|-----------------------------|---------|------------|-------------|--------------------------|----------------|-------|
| Court Nr.  | 1                           | Pool    | 1          | Date        | 2024-10-06               | Field Position | -9968 |
| <b>RED</b> |                             |         |            | <b>BLUE</b> |                          |                |       |
| NOC        | PYLVNEN ANTON (JIGOTAI,FIN) |         |            | NOC         | HOKKA MIKKO (RENSHI,FIN) |                |       |
| Category   | Kumite, pojat, U16, -70 kg  |         |            |             |                          |                |       |
| 3 Points   | 2 Points                    | 1 Point | Score      | 1 Point     | 2 Points                 | 3 Points       |       |
|            |                             |         | 1 : 1      |             |                          |                |       |
| Penatlity  |                             |         |            | Penatlity   |                          |                |       |
| C1: , C2:  |                             |         | <b>1:1</b> | C1: C1, C2: |                          |                |       |
|            |                             |         | Total      | WINNER      |                          |                |       |

SEN

## Decision of Superiority

| Judge 1 | Judge 2 | Judge 3 | Judge 4 | Judge 5 | Judge 6 | Judge 7 | Referee |
|---------|---------|---------|---------|---------|---------|---------|---------|
|         |         |         |         |         |         |         |         |

Name

Signature

\_\_\_\_\_  
\_\_\_\_\_



# Tawastia Open Karate 2/2024

Liivuoentie 24, Hmeenlinna, FINLAND

|            |                            |         |            |             |                                 |                |       |
|------------|----------------------------|---------|------------|-------------|---------------------------------|----------------|-------|
| Court Nr.  | 1                          | Pool    | 1          | Date        | 2024-10-06                      | Field Position | -9967 |
| <b>RED</b> |                            |         |            | <b>BLUE</b> |                                 |                |       |
| NOC        | LHETKANGAS LUKA (OKS,FIN)  |         |            | NOC         | TKACHENKO TIMOFEI (JIGOTAI,FIN) |                |       |
| Category   | Kumite, pojat, U16, -70 kg |         |            |             |                                 |                |       |
| 3 Points   | 2 Points                   | 1 Point | Score      | 1 Point     | 2 Points                        | 3 Points       |       |
|            |                            |         | 4 : 0      |             |                                 |                |       |
| Penatlity  |                            |         |            | Penatlity   |                                 |                |       |
| C1: , C2:  |                            |         | <b>4:0</b> | C1: C1, C2: |                                 |                |       |
| WINNER     |                            |         | Total      |             |                                 |                |       |

PTS

## Decision of Superiority

| Judge 1 | Judge 2 | Judge 3 | Judge 4 | Judge 5 | Judge 6 | Judge 7 | Referee |
|---------|---------|---------|---------|---------|---------|---------|---------|
|         |         |         |         |         |         |         |         |

Name

Signature

\_\_\_\_\_  
\_\_\_\_\_



# Tawastia Open Karate 2/2024

Liivuoentie 24, Hmeenlinna, FINLAND

|             |                             |         |            |             |                           |                |       |
|-------------|-----------------------------|---------|------------|-------------|---------------------------|----------------|-------|
| Court Nr.   | 1                           | Pool    | 1          | Date        | 2024-10-06                | Field Position | -9966 |
| <b>RED</b>  |                             |         |            | <b>BLUE</b> |                           |                |       |
| NOC         | PYLVNEN ANTON (JIGOTAI,FIN) |         |            | NOC         | LHETKANGAS LUKA (OKS,FIN) |                |       |
| Category    | Kumite, pojat, U16, -70 kg  |         |            |             |                           |                |       |
| 3 Points    | 2 Points                    | 1 Point | Score      | 1 Point     | 2 Points                  | 3 Points       |       |
|             |                             |         | 1 : 0      |             |                           |                |       |
| Penatlity   |                             |         |            | Penatlity   |                           |                |       |
| C1: C1, C2: |                             |         | <b>1:0</b> | C1: C1, C2: |                           |                |       |
| WINNER      |                             |         | Total      |             |                           |                |       |

PTS

## Decision of Superiority

| Judge 1 | Judge 2 | Judge 3 | Judge 4 | Judge 5 | Judge 6 | Judge 7 | Referee |
|---------|---------|---------|---------|---------|---------|---------|---------|
|         |         |         |         |         |         |         |         |

Name \_\_\_\_\_

Signature \_\_\_\_\_



# Tawastia Open Karate 2/2024

Liivuoventie 24, Hmeenlinna, FINLAND

|            |                                 |         |            |             |                          |                |       |
|------------|---------------------------------|---------|------------|-------------|--------------------------|----------------|-------|
| Court Nr.  | 1                               | Pool    | 1          | Date        | 2024-10-06               | Field Position | -9965 |
| <b>RED</b> |                                 |         |            | <b>BLUE</b> |                          |                |       |
| NOC        | TKACHENKO TIMOFEI (JIGOTAI,FIN) |         |            | NOC         | HOKKA MIKKO (RENSHI,FIN) |                |       |
| Category   | Kumite, pojat, U16, -70 kg      |         |            |             |                          |                |       |
| 3 Points   | 2 Points                        | 1 Point | Score      | 1 Point     | 2 Points                 | 3 Points       |       |
|            |                                 |         | 0 : 1      |             |                          |                |       |
| Penatlity  |                                 |         |            | Penatlity   |                          |                |       |
| C1: , C2:  |                                 |         | <b>0:1</b> | C1: , C2:   |                          |                |       |
|            |                                 |         | Total      | WINNER      |                          |                |       |

PTS

## Decision of Superiority

| Judge 1 | Judge 2 | Judge 3 | Judge 4 | Judge 5 | Judge 6 | Judge 7 | Referee |
|---------|---------|---------|---------|---------|---------|---------|---------|
|         |         |         |         |         |         |         |         |

Name

Signature

\_\_\_\_\_  
\_\_\_\_\_



# Tawastia Open Karate 2/2024

Liivuoentie 24, Hmeenlinna, FINLAND

|            |                             |         |            |             |                                 |                |       |
|------------|-----------------------------|---------|------------|-------------|---------------------------------|----------------|-------|
| Court Nr.  | 1                           | Pool    | 1          | Date        | 2024-10-06                      | Field Position | -9964 |
| <b>RED</b> |                             |         |            | <b>BLUE</b> |                                 |                |       |
| NOC        | PYLVNEN ANTON (JIGOTAI,FIN) |         |            | NOC         | TKACHENKO TIMOFEI (JIGOTAI,FIN) |                |       |
| Category   | Kumite, pojat, U16, -70 kg  |         |            |             |                                 |                |       |
| 3 Points   | 2 Points                    | 1 Point | Score      | 1 Point     | 2 Points                        | 3 Points       |       |
|            |                             |         | 4 : 0      |             |                                 |                |       |
| Penatlity  |                             |         |            | Penatlity   |                                 |                |       |
| C1: , C2:  |                             |         | <b>4:0</b> | C1: HC, C2: |                                 |                |       |
| WINNER     |                             |         | Total      |             |                                 |                |       |

PTS

## Decision of Superiority

|         |         |         |         |         |         |         |         |
|---------|---------|---------|---------|---------|---------|---------|---------|
| Judge 1 | Judge 2 | Judge 3 | Judge 4 | Judge 5 | Judge 6 | Judge 7 | Referee |
|         |         |         |         |         |         |         |         |

Name

Signature

\_\_\_\_\_  
\_\_\_\_\_



# Tawastia Open Karate 2/2024

Liivuoentie 24, Hmeenlinna, FINLAND

|             |                            |         |            |             |                           |                |       |
|-------------|----------------------------|---------|------------|-------------|---------------------------|----------------|-------|
| Court Nr.   | 1                          | Pool    | 1          | Date        | 2024-10-06                | Field Position | -9963 |
| <b>RED</b>  |                            |         |            | <b>BLUE</b> |                           |                |       |
| NOC         | HOKKA MIKKO (RENSHI,FIN)   |         |            | NOC         | LHETKANGAS LUKA (OKS,FIN) |                |       |
| Category    | Kumite, pojat, U16, -70 kg |         |            |             |                           |                |       |
| 3 Points    | 2 Points                   | 1 Point | Score      | 1 Point     | 2 Points                  | 3 Points       |       |
|             |                            |         | 0 : 1      |             |                           |                |       |
| Penatlity   |                            |         |            | Penatlity   |                           |                |       |
| C1: C2, C2: |                            |         | <b>0:1</b> | C1: , C2:   |                           |                |       |
|             |                            |         | Total      | WINNER      |                           |                |       |

PTS

## Decision of Superiority

| Judge 1 | Judge 2 | Judge 3 | Judge 4 | Judge 5 | Judge 6 | Judge 7 | Referee |
|---------|---------|---------|---------|---------|---------|---------|---------|
|         |         |         |         |         |         |         |         |

Name

Signature

\_\_\_\_\_  
\_\_\_\_\_



# Tawastia Open Karate 2/2024

Liivuoventie 24, Hmeenlinna, FINLAND

|            |                            |         |       |             |                           |                |       |
|------------|----------------------------|---------|-------|-------------|---------------------------|----------------|-------|
| Court Nr.  | 1                          | Pool    | 1     | Date        | 2024-10-06                | Field Position | -9960 |
| <b>RED</b> |                            |         |       | <b>BLUE</b> |                           |                |       |
| NOC        | HOKKA MIKKO (RENSHI,FIN)   |         |       | NOC         | LHETKANGAS LUKA (OKS,FIN) |                |       |
| Category   | Kumite, pojat, U16, -70 kg |         |       |             |                           |                |       |
| 3 Points   | 2 Points                   | 1 Point | Score | 1 Point     | 2 Points                  | 3 Points       |       |
|            |                            |         | :     |             |                           |                |       |
| Penatlity  |                            |         |       | Penatlity   |                           |                |       |
|            |                            |         |       |             |                           |                |       |
|            |                            |         | Total |             |                           |                |       |

## Decision of Superiority

|         |         |         |         |         |         |         |         |
|---------|---------|---------|---------|---------|---------|---------|---------|
| Judge 1 | Judge 2 | Judge 3 | Judge 4 | Judge 5 | Judge 6 | Judge 7 | Referee |
|         |         |         |         |         |         |         |         |

Name

Signature

\_\_\_\_\_

\_\_\_\_\_



# Tawastia Open Karate 2/2024

Liivuoventie 24, Hmeenlinna, FINLAND

|            |                             |         |       |             |                          |                |       |
|------------|-----------------------------|---------|-------|-------------|--------------------------|----------------|-------|
| Court Nr.  | 1                           | Pool    | 1     | Date        | 2024-10-06               | Field Position | -9959 |
| <b>RED</b> |                             |         |       | <b>BLUE</b> |                          |                |       |
| NOC        | PYLVNEN ANTON (JIGOTAI,FIN) |         |       | NOC         | HOKKA MIKKO (RENSHI,FIN) |                |       |
| Category   | Kumite, pojat, U16, -70 kg  |         |       |             |                          |                |       |
| 3 Points   | 2 Points                    | 1 Point | Score | 1 Point     | 2 Points                 | 3 Points       |       |
|            |                             |         | :     |             |                          |                |       |
| Penatlity  |                             |         |       | Penatlity   |                          |                |       |
|            |                             |         |       |             |                          |                |       |
|            |                             |         | Total |             |                          |                |       |

## Decision of Superiority

|         |         |         |         |         |         |         |         |
|---------|---------|---------|---------|---------|---------|---------|---------|
| Judge 1 | Judge 2 | Judge 3 | Judge 4 | Judge 5 | Judge 6 | Judge 7 | Referee |
|         |         |         |         |         |         |         |         |

Name

Signature

\_\_\_\_\_  
\_\_\_\_\_





# Tawastia Open Karate 2/2024

Liivuoentie 24, Hmeenlinna, FINLAND

|            |                             |         |       |             |                           |                |       |
|------------|-----------------------------|---------|-------|-------------|---------------------------|----------------|-------|
| Court Nr.  | 1                           | Pool    | 1     | Date        | 2024-10-06                | Field Position | -9958 |
| <b>RED</b> |                             |         |       | <b>BLUE</b> |                           |                |       |
| NOC        | PYLVNEN ANTON (JIGOTAI,FIN) |         |       | NOC         | LHETKANGAS LUKA (OKS,FIN) |                |       |
| Category   | Kumite, pojat, U16, -70 kg  |         |       |             |                           |                |       |
| 3 Points   | 2 Points                    | 1 Point | Score | 1 Point     | 2 Points                  | 3 Points       |       |
|            |                             |         | :     |             |                           |                |       |
| Penatlity  |                             |         |       | Penatlity   |                           |                |       |
|            |                             |         |       |             |                           |                |       |
|            |                             |         | Total |             |                           |                |       |

## Decision of Superiority

|         |         |         |         |         |         |         |         |
|---------|---------|---------|---------|---------|---------|---------|---------|
| Judge 1 | Judge 2 | Judge 3 | Judge 4 | Judge 5 | Judge 6 | Judge 7 | Referee |
|         |         |         |         |         |         |         |         |

Name





Signature

\_\_\_\_\_  
\_\_\_\_\_



## Tawastia Open Karate 2/2024 - 2024-10-05

## Official Results

| Kumite, pojat, U16, -70 kg |                   |                      |   |               |
|----------------------------|-------------------|----------------------|---|---------------|
| 1                          | PYLVÄNEN ANTON    | JIGOTAI KARATE       |  | FIN - FINLAND |
| 2                          | LÄHETKANGAS LUKA  | OULUN<br>KARATESEURA |  | FIN - FINLAND |
| 3                          | HOKKA MIKKO       | RENSHIN-KAN RY       |  | FIN - FINLAND |
| 4                          | TKACHENKO TIMOFEI | JIGOTAI KARATE       |  | FIN - FINLAND |

KUMITE, POJAT, U18, +68 KG  
YHDISTETTY

Tawastia Open Karate 2/2024

**ENTRIES BY WEIGHT CATEGORY**  
**Kumite, pojat, U18, +68 kg yhdistetty**

As of 6 OCT 2024

| Country Code | ID | Gender | Name         | Seeding |
|--------------|----|--------|--------------|---------|
| FIN          |    | M      | Kreus Petrus |         |
| FIN          |    | M      | Mantere Jimi |         |

# Kumite, pojat, U18, +68 kg yhdistetty

Tawastia Open Karate 2/2024, Liivourentie 24, Hämeenlinna, FIN

2024-10-05

Tatami  
3 15:40

Pool  
1/1

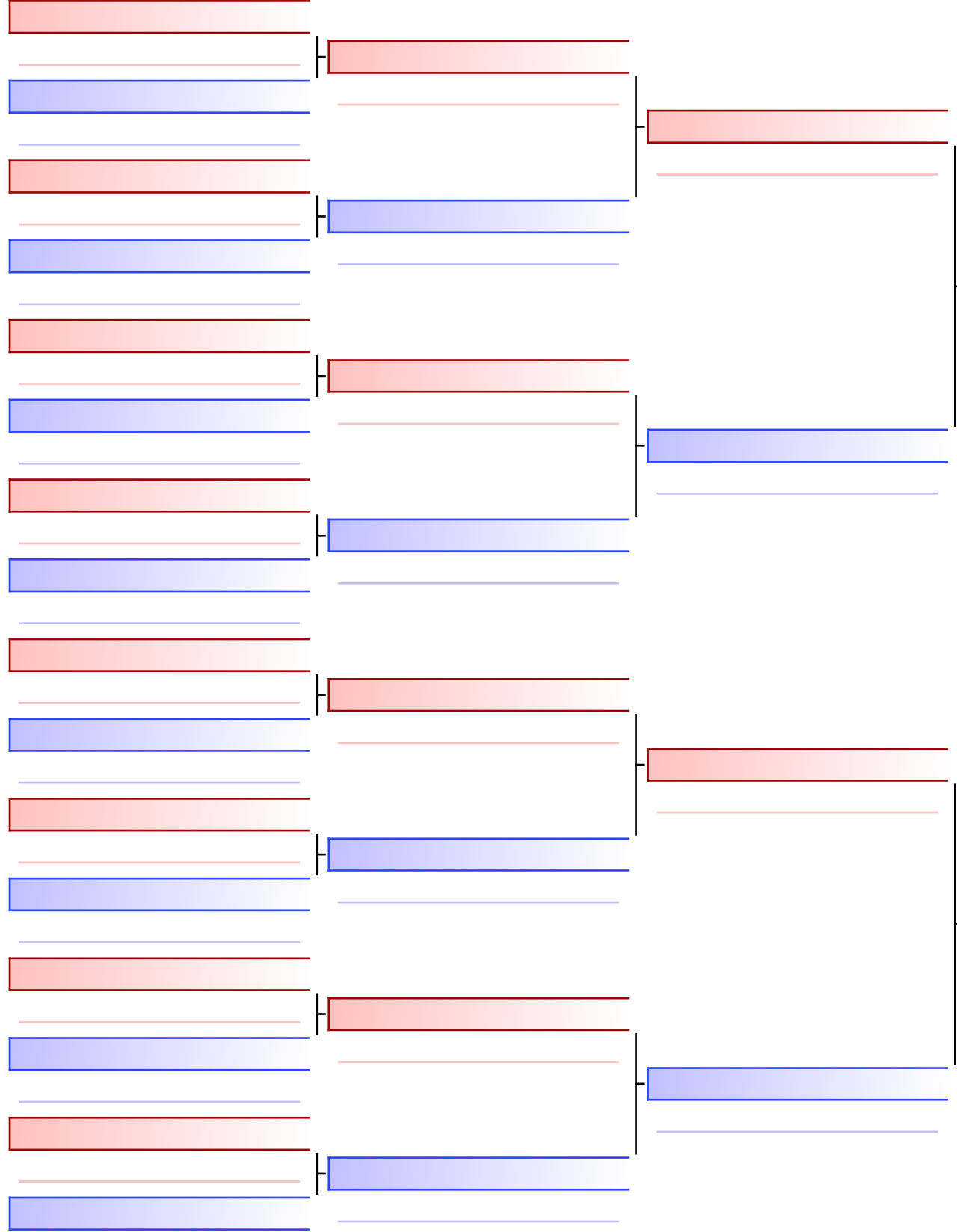

Final

Mantere Jimi (HKS,FIN)

0

Mantere Jimi (HKS,FIN)

Kreus Petrus (JKA-Tampere,FIN)

0

|                                   |
|-----------------------------------|
| 1. MANTERE JIMI (HKS,FIN)         |
| 2. KREUS PETRUS (JKA-TAMPERE,FIN) |
|                                   |
|                                   |
|                                   |
|                                   |
|                                   |

|           |  |  |  |
|-----------|--|--|--|
| Referees: |  |  |  |
|           |  |  |  |

# Tawastia Open Karate 2/2024

Liivuoentie 24, Hmeenlinna, FINLAND

|            |                                       |         |            |             |                                |                |    |
|------------|---------------------------------------|---------|------------|-------------|--------------------------------|----------------|----|
| Court Nr.  | 1                                     | Pool    | 1          | Date        | 2024-10-06                     | Field Position | 63 |
| <b>RED</b> |                                       |         |            | <b>BLUE</b> |                                |                |    |
| NOC        | MANTERE JIMI (HKS,FIN)                |         |            | NOC         | KREUS PETRUS (JKA-TAMPERE,FIN) |                |    |
| Category   | Kumite, pojat, U18, +68 kg yhdistetty |         |            |             |                                |                |    |
| 3 Points   | 2 Points                              | 1 Point | Score      | 1 Point     | 2 Points                       | 3 Points       |    |
|            |                                       |         | 0 : 0      |             |                                |                |    |
| Penatlity  |                                       |         |            | Penatlity   |                                |                |    |
| C1: , C2:  |                                       |         | <b>0:0</b> | C1: C1, C2: |                                |                |    |
| WINNER     |                                       |         | Total      |             |                                |                |    |

HT

## Decision of Superiority

| Judge 1 | Judge 2 | Judge 3 | Judge 4 | Judge 5 | Judge 6 | Judge 7 | Referee |
|---------|---------|---------|---------|---------|---------|---------|---------|
|         |         |         |         |         |         |         |         |



Name \_\_\_\_\_

Signature \_\_\_\_\_



Tawastia Open Karate 2/2024 - 2024-10-05

Official Results

| Kumite, pojat, U18, +68 kg yhdistetty |              |   |   |               |
|---------------------------------------|--------------|---|---|---------------|
| 1                                     | MANTERE JIMI | HÄMEENLINNAN<br>KARATESEURA               |  | FIN - FINLAND |
| 2                                     | KREUS PETRUS | JAPAN KARATE<br>ASSOCIATION<br>TAMPERE RY |  | FIN - FINLAND |

# KUMITE, POJAT, U18, -55 KG



Tawastia Open Karate 2/2024

**ENTRIES BY WEIGHT CATEGORY**  
**Kumite, pojat, U18, -55 kg**

As of 6 OCT 2024

| Country Code | ID | Gender | Name            | Seeding |
|--------------|----|--------|-----------------|---------|
| FIN          |    | M      | Kettunen Eemeli |         |
| FIN          |    | M      | Simonen Tino    |         |

# Kumite, pojat, U18, -55 kg

Tawastia Open Karate 2/2024, Liivuoventie 24, Hämeenlinna, FIN

2024-10-05

Tatami  
3 15:15

Pool  
1/1

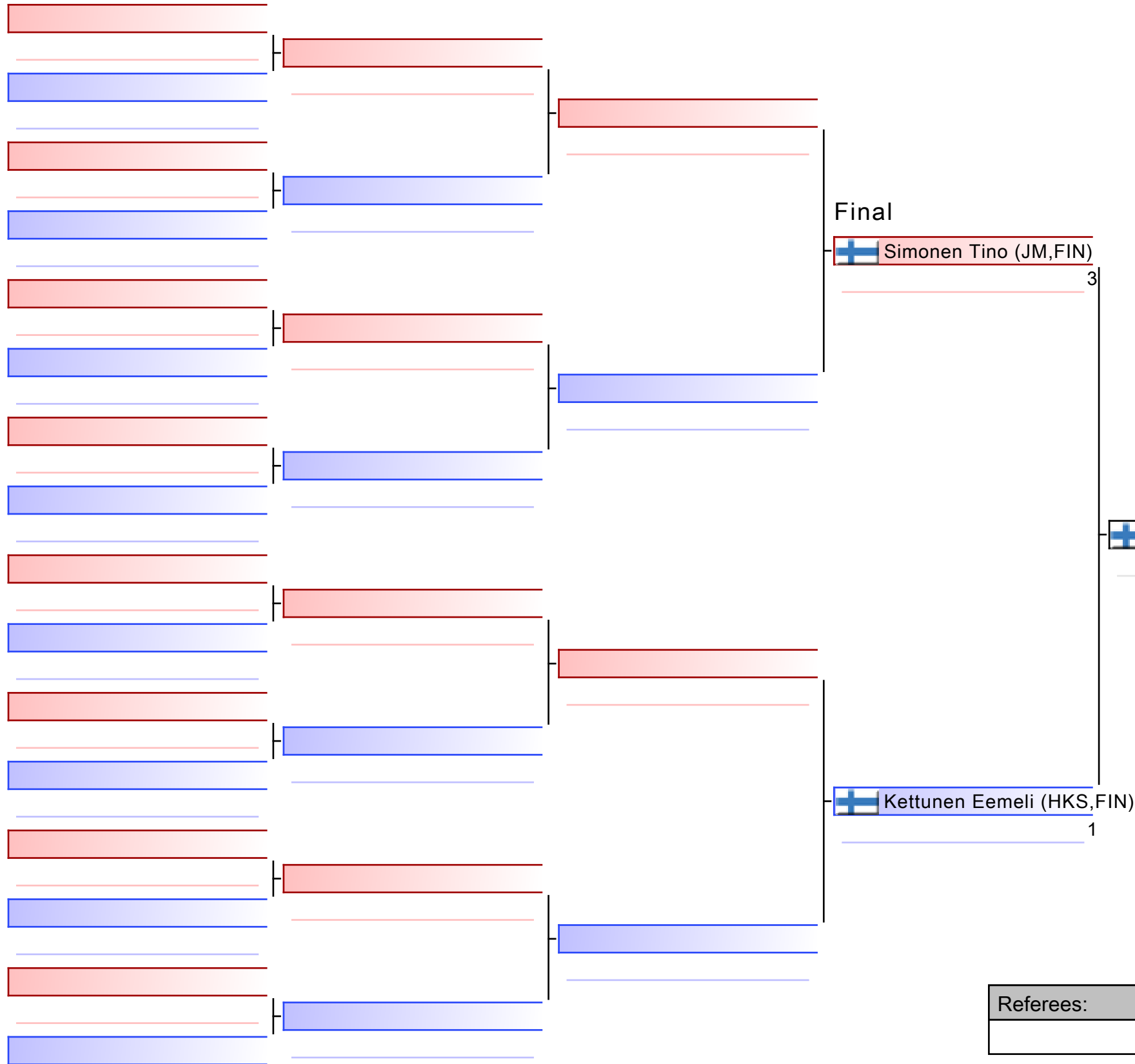

Final

Simonen Tino (JM,FIN)

3

Simonen Tino (JM,FIN)

Kettunen Eemeli (HKS,FIN)

1

|                              |
|------------------------------|
| 1. SIMONEN TINO (JM,FIN)     |
| 2. KETTUNEN EEMELI (HKS,FIN) |
|                              |
|                              |
|                              |
|                              |
|                              |
|                              |

|           |  |  |  |
|-----------|--|--|--|
| Referees: |  |  |  |
|           |  |  |  |

# Tawastia Open Karate 2/2024

Liivuoentie 24, Hmeenlinna, FINLAND

|             |                            |         |            |             |                           |                |    |
|-------------|----------------------------|---------|------------|-------------|---------------------------|----------------|----|
| Court Nr.   | 1                          | Pool    | 1          | Date        | 2024-10-06                | Field Position | 63 |
| <b>RED</b>  |                            |         |            | <b>BLUE</b> |                           |                |    |
| NOC         | SIMONEN TINO (JM,FIN)      |         |            | NOC         | KETTUNEN EEMELI (HKS,FIN) |                |    |
| Category    | Kumite, pojat, U18, -55 kg |         |            |             |                           |                |    |
| 3 Points    | 2 Points                   | 1 Point | Score      | 1 Point     | 2 Points                  | 3 Points       |    |
|             |                            |         | 3 : 1      |             |                           |                |    |
| Penatlity   |                            |         |            | Penatlity   |                           |                |    |
| C1: C1, C2: |                            |         | <b>3:1</b> | C1: C3, C2: |                           |                |    |
| WINNER      |                            |         | Total      |             |                           |                |    |

PTS

## Decision of Superiority

| Judge 1 | Judge 2 | Judge 3 | Judge 4 | Judge 5 | Judge 6 | Judge 7 | Referee |
|---------|---------|---------|---------|---------|---------|---------|---------|
|         |         |         |         |         |         |         |         |

Name



Signature

\_\_\_\_\_  
\_\_\_\_\_



Tawastia Open Karate 2/2024 - 2024-10-05

Official Results

| Kumite, pojat, U18, -55 kg |                 |                             |   |               |
|----------------------------|-----------------|-----------------------------|---|---------------|
| 1                          | SIMONEN TINO    | JOEN MAWASHI RY             |  | FIN - FINLAND |
| 2                          | KETTUNEN EEMELI | HAMEENLINNAN<br>KARATESEURA |  | FIN - FINLAND |

# KUMITE, POJAT, U18, -61 KG

Tawastia Open Karate 2/2024

**ENTRIES BY WEIGHT CATEGORY**  
**Kumite, pojat, U18, -61 kg**

As of 6 OCT 2024

| Country Code | ID | Gender | Name           | Seeding |
|--------------|----|--------|----------------|---------|
| FIN          |    | M      | Jrvenp Tatu    |         |
| FIN          |    | M      | Simonen Rene   |         |
| FIN          |    | M      | Vainela Juho   |         |
| FIN          |    | M      | Vyrynen Luukas |         |

# Kumite, pojat, U18, -61 kg - Round Robin (each against each)

Tawastia Open Karate 2/2024, Liivuoentie 24, Hämeenlinna, FIN

2024-10-05

Tatami  
3 15:20

Pool  
1/1

|    |                             |    |                             |
|----|-----------------------------|----|-----------------------------|
| 1  | Väyrynen Luukas (OM,FIN)    | 10 | Väyrynen Luukas (OM,FIN)    |
| 2  | Vainela Juho (JKA Pori,FIN) | 0  |                             |
| 3  | Simonen Rene (JM,FIN)       | 8  | Simonen Rene (JM,FIN)       |
| 4  | Järvenpää Tatu (SKP,FIN)    | 0  |                             |
| 5  | Väyrynen Luukas (OM,FIN)    | 4  | Simonen Rene (JM,FIN)       |
| 6  | Simonen Rene (JM,FIN)       | 5  |                             |
| 7  | Järvenpää Tatu (SKP,FIN)    | 0  | Vainela Juho (JKA Pori,FIN) |
| 8  | Vainela Juho (JKA Pori,FIN) | 8  |                             |
| 9  | Väyrynen Luukas (OM,FIN)    | 8  | Väyrynen Luukas (OM,FIN)    |
| 10 | Järvenpää Tatu (SKP,FIN)    | 0  |                             |
| 11 | Vainela Juho (JKA Pori,FIN) | 0  | Simonen Rene (JM,FIN)       |
| 12 | Simonen Rene (JM,FIN)       | 10 |                             |



|                                |
|--------------------------------|
| 1. SIMONEN RENE (JM,FIN)       |
| 2. VÄYRYNEN LUUKAS (OM,FIN)    |
| 3. VAINELA JUHO (JKA PORI,FIN) |
| 4. JÄRVENPÄÄ TATU (SKP,FIN)    |
|                                |
|                                |
|                                |

|           |  |  |  |
|-----------|--|--|--|
| Referees: |  |  |  |
|           |  |  |  |

# Tawastia Open Karate 2/2024

Liivuoentie 24, Hmeenlinna, FINLAND

|            |                            |         |             |             |                             |                |       |
|------------|----------------------------|---------|-------------|-------------|-----------------------------|----------------|-------|
| Court Nr.  | 1                          | Pool    | 1           | Date        | 2024-10-06                  | Field Position | -9951 |
| <b>RED</b> |                            |         |             | <b>BLUE</b> |                             |                |       |
| NOC        | VYRYNEN LUUKAS (OM,FIN)    |         |             | NOC         | VAINELA JUHO (JKA PORI,FIN) |                |       |
| Category   | Kumite, pojat, U18, -61 kg |         |             |             |                             |                |       |
| 3 Points   | 2 Points                   | 1 Point | Score       | 1 Point     | 2 Points                    | 3 Points       |       |
|            |                            |         | 10 : 0      |             |                             |                |       |
| Penatlity  |                            |         |             | Penatlity   |                             |                |       |
| C1: , C2:  |                            |         | <b>10:0</b> | C1: C2, C2: |                             |                |       |
| WINNER     |                            |         | Total       |             |                             |                |       |

PTS

## Decision of Superiority

| Judge 1 | Judge 2 | Judge 3 | Judge 4 | Judge 5 | Judge 6 | Judge 7 | Referee |
|---------|---------|---------|---------|---------|---------|---------|---------|
|         |         |         |         |         |         |         |         |

Name

Signature

\_\_\_\_\_  
\_\_\_\_\_





# Tawastia Open Karate 2/2024

Liivuoentie 24, Hmeenlinna, FINLAND

|             |                            |         |            |             |                       |                |       |
|-------------|----------------------------|---------|------------|-------------|-----------------------|----------------|-------|
| Court Nr.   | 1                          | Pool    | 1          | Date        | 2024-10-06            | Field Position | -9950 |
| <b>RED</b>  |                            |         |            | <b>BLUE</b> |                       |                |       |
| NOC         | SIMONEN RENE (JM,FIN)      |         |            | NOC         | JRVENP TATU (SKP,FIN) |                |       |
| Category    | Kumite, pojat, U18, -61 kg |         |            |             |                       |                |       |
| 3 Points    | 2 Points                   | 1 Point | Score      | 1 Point     | 2 Points              | 3 Points       |       |
|             |                            |         | 8 : 0      |             |                       |                |       |
| Penatlity   |                            |         |            | Penatlity   |                       |                |       |
| C1: C1, C2: |                            |         | <b>8:0</b> | C1: C1, C2: |                       |                |       |
| WINNER      |                            |         | Total      |             |                       |                |       |

KI

## Decision of Superiority

| Judge 1 | Judge 2 | Judge 3 | Judge 4 | Judge 5 | Judge 6 | Judge 7 | Referee |
|---------|---------|---------|---------|---------|---------|---------|---------|
|         |         |         |         |         |         |         |         |

Name

Signature

\_\_\_\_\_  
\_\_\_\_\_



# Tawastia Open Karate 2/2024

Liivuoentie 24, Hmeenlinna, FINLAND

|             |                            |         |            |             |                       |                |       |
|-------------|----------------------------|---------|------------|-------------|-----------------------|----------------|-------|
| Court Nr.   | 1                          | Pool    | 1          | Date        | 2024-10-06            | Field Position | -9949 |
| <b>RED</b>  |                            |         |            | <b>BLUE</b> |                       |                |       |
| NOC         | VYRYNEN LUUKAS (OM,FIN)    |         |            | NOC         | SIMONEN RENE (JM,FIN) |                |       |
| Category    | Kumite, pojat, U18, -61 kg |         |            |             |                       |                |       |
| 3 Points    | 2 Points                   | 1 Point | Score      | 1 Point     | 2 Points              | 3 Points       |       |
|             |                            |         | 4 : 5      |             |                       |                |       |
| Penatlity   |                            |         |            | Penatlity   |                       |                |       |
| C1: C2, C2: |                            |         | <b>4:5</b> | C1: C2, C2: |                       |                |       |
|             |                            |         | Total      | WINNER      |                       |                |       |

PTS

## Decision of Superiority

| Judge 1 | Judge 2 | Judge 3 | Judge 4 | Judge 5 | Judge 6 | Judge 7 | Referee |
|---------|---------|---------|---------|---------|---------|---------|---------|
|         |         |         |         |         |         |         |         |

Name

Signature

\_\_\_\_\_  
\_\_\_\_\_



# Tawastia Open Karate 2/2024

Liivuoventie 24, Hmeenlinna, FINLAND

|            |                            |         |            |             |                             |                |       |
|------------|----------------------------|---------|------------|-------------|-----------------------------|----------------|-------|
| Court Nr.  | 1                          | Pool    | 1          | Date        | 2024-10-06                  | Field Position | -9948 |
| <b>RED</b> |                            |         |            | <b>BLUE</b> |                             |                |       |
| NOC        | JRVENP TATU (SKP,FIN)      |         |            | NOC         | VAINELA JUHO (JKA PORI,FIN) |                |       |
| Category   | Kumite, pojat, U18, -61 kg |         |            |             |                             |                |       |
| 3 Points   | 2 Points                   | 1 Point | Score      | 1 Point     | 2 Points                    | 3 Points       |       |
|            |                            |         | 0 : 8      |             |                             |                |       |
| Penatlity  |                            |         |            | Penatlity   |                             |                |       |
| C1: , C2:  |                            |         | <b>0:8</b> | C1: , C2:   |                             |                |       |
|            |                            |         | Total      | WINNER      |                             |                |       |

KI

## Decision of Superiority

| Judge 1 | Judge 2 | Judge 3 | Judge 4 | Judge 5 | Judge 6 | Judge 7 | Referee |
|---------|---------|---------|---------|---------|---------|---------|---------|
|         |         |         |         |         |         |         |         |

Name

Signature

\_\_\_\_\_  
\_\_\_\_\_



# Tawastia Open Karate 2/2024

Liivuoentie 24, Hmeenlinna, FINLAND

|            |                            |         |            |             |                       |                |       |
|------------|----------------------------|---------|------------|-------------|-----------------------|----------------|-------|
| Court Nr.  | 1                          | Pool    | 1          | Date        | 2024-10-06            | Field Position | -9947 |
| <b>RED</b> |                            |         |            | <b>BLUE</b> |                       |                |       |
| NOC        | VYRYNEN LUUKAS (OM,FIN)    |         |            | NOC         | JRVENP TATU (SKP,FIN) |                |       |
| Category   | Kumite, pojat, U18, -61 kg |         |            |             |                       |                |       |
| 3 Points   | 2 Points                   | 1 Point | Score      | 1 Point     | 2 Points              | 3 Points       |       |
|            |                            |         | 8 : 0      |             |                       |                |       |
| Penatlity  |                            |         |            | Penatlity   |                       |                |       |
| C1: , C2:  |                            |         | <b>8:0</b> | C1: C1, C2: |                       |                |       |
| WINNER     |                            |         | Total      |             |                       |                |       |

KI

## Decision of Superiority

| Judge 1 | Judge 2 | Judge 3 | Judge 4 | Judge 5 | Judge 6 | Judge 7 | Referee |
|---------|---------|---------|---------|---------|---------|---------|---------|
|         |         |         |         |         |         |         |         |

Name

Signature

\_\_\_\_\_  
\_\_\_\_\_



# Tawastia Open Karate 2/2024

Liivuoentie 24, Hmeenlinna, FINLAND

|             |                             |         |             |             |                       |                |       |
|-------------|-----------------------------|---------|-------------|-------------|-----------------------|----------------|-------|
| Court Nr.   | 1                           | Pool    | 1           | Date        | 2024-10-06            | Field Position | -9946 |
| <b>RED</b>  |                             |         |             | <b>BLUE</b> |                       |                |       |
| NOC         | VAINELA JUHO (JKA PORI,FIN) |         |             | NOC         | SIMONEN RENE (JM,FIN) |                |       |
| Category    | Kumite, pojat, U18, -61 kg  |         |             |             |                       |                |       |
| 3 Points    | 2 Points                    | 1 Point | Score       | 1 Point     | 2 Points              | 3 Points       |       |
|             |                             |         | 0 : 10      |             |                       |                |       |
| Penatlity   |                             |         |             | Penatlity   |                       |                |       |
| C1: C2, C2: |                             |         | <b>0:10</b> | C1: C1, C2: |                       |                |       |
|             |                             |         | Total       | WINNER      |                       |                |       |

PTS

## Decision of Superiority

| Judge 1 | Judge 2 | Judge 3 | Judge 4 | Judge 5 | Judge 6 | Judge 7 | Referee |
|---------|---------|---------|---------|---------|---------|---------|---------|
|         |         |         |         |         |         |         |         |

Name





Signature

\_\_\_\_\_  
\_\_\_\_\_



## Tawastia Open Karate 2/2024 - 2024-10-05

## Official Results

| Kumite, pojat, U18, -61 kg |                 |                        |   |               |
|----------------------------|-----------------|------------------------|---|---------------|
| 1                          | SIMONEN RENE    | JOEN MAWASHI RY        |  | FIN - FINLAND |
| 2                          | VÄYRYNEN LUUKAS | SPORTSKARATE<br>KUOPIO |  | FIN - FINLAND |
| 3                          | VAINELA JUHO    | PORIN SHOTOKAN         |  | FIN - FINLAND |
| 4                          | JÄRVENPÄÄ TATU  | SPORTSKARATE<br>PORI   |  | FIN - FINLAND |

# KUMITE, TYTÖT, U10 YHDISTETTY

Tawastia Open Karate 2/2024

**ENTRIES BY WEIGHT CATEGORY**  
**Kumite, tytt, U10 yhdistetty**

As of 6 OCT 2024

| Country Code | ID | Gender | Name            | Seeding |
|--------------|----|--------|-----------------|---------|
| FIN          |    | F      | Abdelmoaty Sara |         |
| FIN          |    | F      | Batikeru Laasya |         |
| FIN          |    | F      | Chudina Alisa   |         |
| FIN          |    | F      | Hakala Heli     |         |
| FIN          |    | F      | Keskimki Fanni  |         |
| FIN          |    | F      | Luoma-ij Ellah  |         |
| FIN          |    | F      | Lhetkangas Emma |         |
| FIN          |    | F      | MAKSYMUK ULIANA |         |
| FIN          |    | F      | Ruottinen Iina  |         |
| FIN          |    | F      | Yakivets Ieva   |         |



# Kumite, tytöt, U10 yhdistetty

Tawastia Open Karate 2/2024, Liivuoventie 24, Hämeenlinna, FIN

2024-10-05

Tatami  
1 11:10

Pool  
1/1

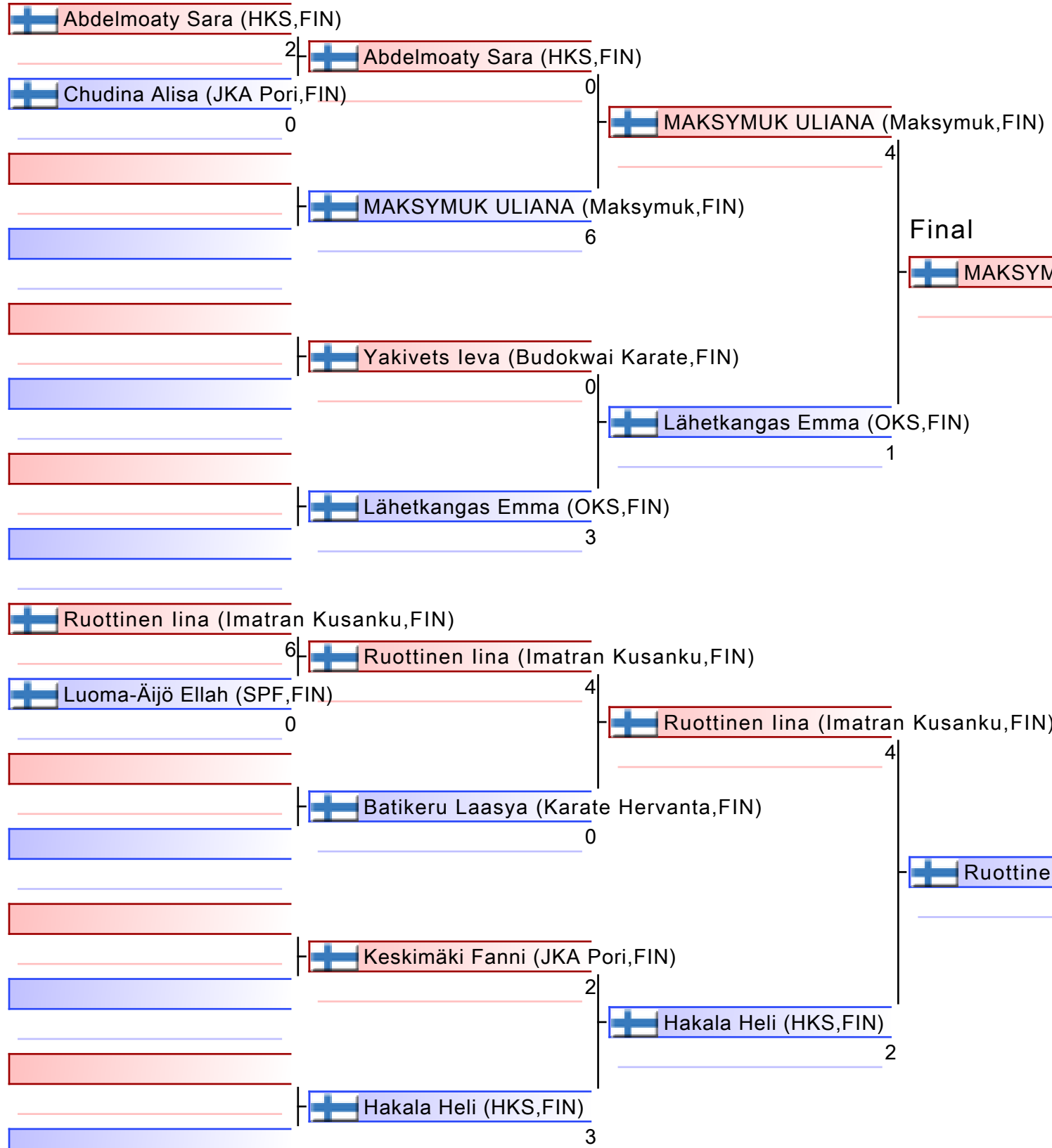

- |  |
|--|
| 1. RUOTTINEN IINA (IMATRAN KUSANKU,FIN)  |
| 2. MAKSYMUK ULIANA (MAKSYMUK,FIN)        |
| 3. LÄHETKANGAS EMMA (OKS,FIN)            |
| 4. HAKALA HELI (HKS,FIN)                 |
| 5. ABDELMOATY SARA (HKS,FIN)             |
| 5. BATIKERU LAASYA (KARATE HERVANTA,FIN) |
| 7. LUOMA-ÄIJÖ ELLAH (SPF,FIN)            |
|  |

|           |  |  |  |
|-----------|--|--|--|
| Referees: |  |  |  |
|           |  |  |  |

# Kumite, tytöt, U10 yhdistetty

Tawastia Open Karate 2/2024

2024-10-05

Tatami  
1 11:10

Pool  
1

(c)sportdata GmbH & Co KG 2000-2024 (2024-10-06 10:03) v 10.2.0 build 1 (2024-09-26 10:14 CET) License: Online\_Event\_ID-8546\_TawastiaOpenKarate2024 (expire 2024-10-20)

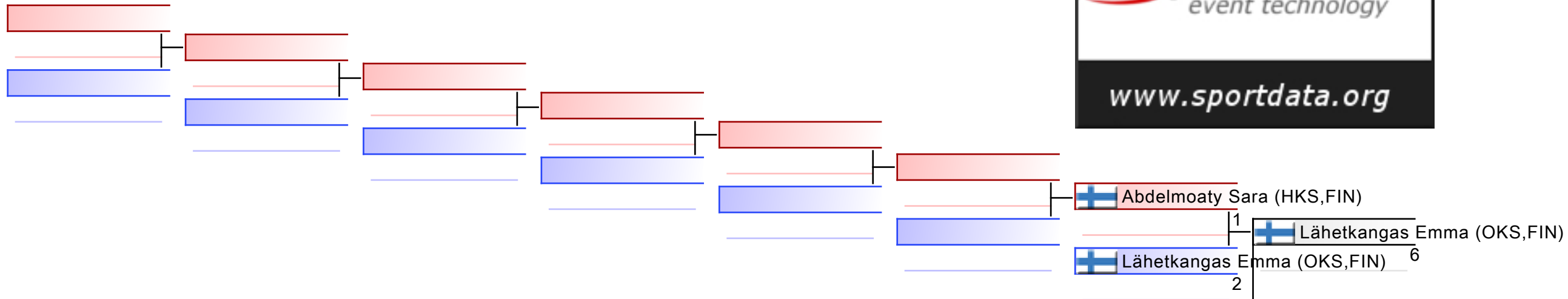

## REPECHAGE: (1)

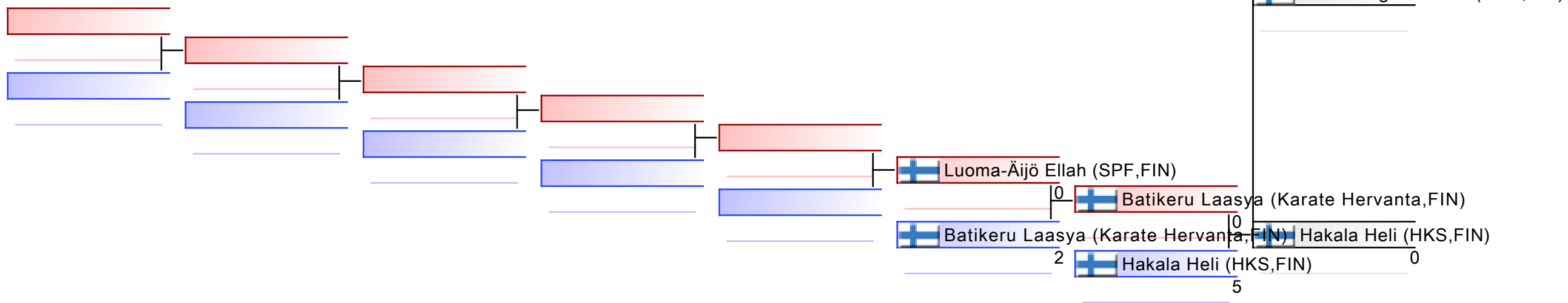

|           |  |  |  |  |  |  |  |
|-----------|--|--|--|--|--|--|--|
| Referees: |  |  |  |  |  |  |  |
|-----------|--|--|--|--|--|--|--|

# Tawastia Open Karate 2/2024

Liivuoentie 24, Hmeenlinna, FINLAND

|             |                              |         |            |             |                              |                |    |
|-------------|------------------------------|---------|------------|-------------|------------------------------|----------------|----|
| Court Nr.   | 1                            | Pool    | 1          | Date        | 2024-10-06                   | Field Position | 49 |
| <b>RED</b>  |                              |         |            | <b>BLUE</b> |                              |                |    |
| NOC         | ABDELMOATY SARA (HKS,FIN)    |         |            | NOC         | CHUDINA ALISA (JKA PORI,FIN) |                |    |
| Category    | Kumite, tytt, U10 yhdistetty |         |            |             |                              |                |    |
| 3 Points    | 2 Points                     | 1 Point | Score      | 1 Point     | 2 Points                     | 3 Points       |    |
|             |                              |         | 2 : 0      |             |                              |                |    |
| Penatlity   |                              |         |            | Penatlity   |                              |                |    |
| C1: C1, C2: |                              |         | <b>2:0</b> | C1: , C2:   |                              |                |    |
| WINNER      |                              |         | Total      |             |                              |                |    |

PTS

## Decision of Superiority

| Judge 1 | Judge 2 | Judge 3 | Judge 4 | Judge 5 | Judge 6 | Judge 7 | Referee |
|---------|---------|---------|---------|---------|---------|---------|---------|
|         |         |         |         |         |         |         |         |

Name \_\_\_\_\_

Signature \_\_\_\_\_



# Tawastia Open Karate 2/2024

Liivuoentie 24, Hmeenlinna, FINLAND

|            |                                      |         |            |             |                          |                |    |
|------------|--------------------------------------|---------|------------|-------------|--------------------------|----------------|----|
| Court Nr.  | 1                                    | Pool    | 1          | Date        | 2024-10-06               | Field Position | 53 |
| <b>RED</b> |                                      |         |            | <b>BLUE</b> |                          |                |    |
| NOC        | RUOTTINEN IINA (IMATRAN KUSANKU,FIN) |         |            | NOC         | LUOMA-IJ ELLAH (SPF,FIN) |                |    |
| Category   | Kumite, tytt, U10 yhdistetty         |         |            |             |                          |                |    |
| 3 Points   | 2 Points                             | 1 Point | Score      | 1 Point     | 2 Points                 | 3 Points       |    |
|            |                                      |         | 6 : 0      |             |                          |                |    |
| Penatlity  |                                      |         |            | Penatlity   |                          |                |    |
| C1: , C2:  |                                      |         | <b>6:0</b> | C1: , C2:   |                          |                |    |
| WINNER     |                                      |         | Total      |             |                          |                |    |

PTS

## Decision of Superiority

| Judge 1 | Judge 2 | Judge 3 | Judge 4 | Judge 5 | Judge 6 | Judge 7 | Referee |
|---------|---------|---------|---------|---------|---------|---------|---------|
|         |         |         |         |         |         |         |         |

Name \_\_\_\_\_

Signature \_\_\_\_\_



# Tawastia Open Karate 2/2024

Liivuoentie 24, Hmeenlinna, FINLAND

|             |                              |         |            |             |                                |                |    |
|-------------|------------------------------|---------|------------|-------------|--------------------------------|----------------|----|
| Court Nr.   | 1                            | Pool    | 1          | Date        | 2024-10-06                     | Field Position | 57 |
| <b>RED</b>  |                              |         |            | <b>BLUE</b> |                                |                |    |
| NOC         | ABDELMOATY SARA (HKS,FIN)    |         |            | NOC         | MAKSYMUK ULIANA (MAKSYMUK,FIN) |                |    |
| Category    | Kumite, tytt, U10 yhdistetty |         |            |             |                                |                |    |
| 3 Points    | 2 Points                     | 1 Point | Score      | 1 Point     | 2 Points                       | 3 Points       |    |
|             |                              |         | 0 : 6      |             |                                |                |    |
| Penatlity   |                              |         |            | Penatlity   |                                |                |    |
| C1: C1, C2: |                              |         | <b>0:6</b> | C1: , C2:   |                                |                |    |
|             |                              |         | Total      | WINNER      |                                |                |    |

PTS

## Decision of Superiority

| Judge 1 | Judge 2 | Judge 3 | Judge 4 | Judge 5 | Judge 6 | Judge 7 | Referee |
|---------|---------|---------|---------|---------|---------|---------|---------|
|         |         |         |         |         |         |         |         |

Name

Signature

\_\_\_\_\_  
\_\_\_\_\_



# Tawastia Open Karate 2/2024

Liivuoentie 24, Hmeenlinna, FINLAND

|             |                                     |         |            |             |                           |                |    |
|-------------|-------------------------------------|---------|------------|-------------|---------------------------|----------------|----|
| Court Nr.   | 1                                   | Pool    | 1          | Date        | 2024-10-06                | Field Position | 58 |
| <b>RED</b>  |                                     |         |            | <b>BLUE</b> |                           |                |    |
| NOC         | YAKIVETS IEVA (BUDOKWAI KARATE,FIN) |         |            | NOC         | LHETKANGAS EMMA (OKS,FIN) |                |    |
| Category    | Kumite, tytt, U10 yhdistetty        |         |            |             |                           |                |    |
| 3 Points    | 2 Points                            | 1 Point | Score      | 1 Point     | 2 Points                  | 3 Points       |    |
|             |                                     |         | 0 : 3      |             |                           |                |    |
| Penatlity   |                                     |         |            | Penatlity   |                           |                |    |
| C1: C1, C2: |                                     |         | <b>0:3</b> | C1: , C2:   |                           |                |    |
|             |                                     |         | Total      | WINNER      |                           |                |    |

PTS

## Decision of Superiority

| Judge 1 | Judge 2 | Judge 3 | Judge 4 | Judge 5 | Judge 6 | Judge 7 | Referee |
|---------|---------|---------|---------|---------|---------|---------|---------|
|         |         |         |         |         |         |         |         |

Name

Signature

\_\_\_\_\_  
\_\_\_\_\_



# Tawastia Open Karate 2/2024

Liivuoentie 24, Hmeenlinna, FINLAND

|            |                                      |         |            |             |                                       |                |    |
|------------|--------------------------------------|---------|------------|-------------|---------------------------------------|----------------|----|
| Court Nr.  | 1                                    | Pool    | 1          | Date        | 2024-10-06                            | Field Position | 59 |
| <b>RED</b> |                                      |         |            | <b>BLUE</b> |                                       |                |    |
| NOC        | RUOTTINEN IINA (IMATRAN KUSANKU,FIN) |         |            | NOC         | BATIKERU LAASYA (KARATE HERVANTA,FIN) |                |    |
| Category   | Kumite, tytt, U10 yhdistetty         |         |            |             |                                       |                |    |
| 3 Points   | 2 Points                             | 1 Point | Score      | 1 Point     | 2 Points                              | 3 Points       |    |
|            |                                      |         | 4 : 0      |             |                                       |                |    |
| Penatlity  |                                      |         |            | Penatlity   |                                       |                |    |
| C1: , C2:  |                                      |         | <b>4:0</b> | C1: , C2:   |                                       |                |    |
| WINNER     |                                      |         | Total      |             |                                       |                |    |

PTS

## Decision of Superiority

| Judge 1 | Judge 2 | Judge 3 | Judge 4 | Judge 5 | Judge 6 | Judge 7 | Referee |
|---------|---------|---------|---------|---------|---------|---------|---------|
|         |         |         |         |         |         |         |         |

Name

Signature

\_\_\_\_\_  
\_\_\_\_\_



# Tawastia Open Karate 2/2024

Liivuoentie 24, Hmeenlinna, FINLAND

|            |                               |         |            |             |                       |                |    |
|------------|-------------------------------|---------|------------|-------------|-----------------------|----------------|----|
| Court Nr.  | 1                             | Pool    | 1          | Date        | 2024-10-06            | Field Position | 60 |
| <b>RED</b> |                               |         |            | <b>BLUE</b> |                       |                |    |
| NOC        | KESKIMKI FANNI (JKA PORI,FIN) |         |            | NOC         | HAKALA HELI (HKS,FIN) |                |    |
| Category   | Kumite, tytt, U10 yhdistetty  |         |            |             |                       |                |    |
| 3 Points   | 2 Points                      | 1 Point | Score      | 1 Point     | 2 Points              | 3 Points       |    |
|            |                               |         | 2 : 3      |             |                       |                |    |
| Penatlity  |                               |         |            | Penatlity   |                       |                |    |
| C1: , C2:  |                               |         | <b>2:3</b> | C1: HC, C2: |                       |                |    |
|            |                               |         | Total      | WINNER      |                       |                |    |

PTS

## Decision of Superiority

| Judge 1 | Judge 2 | Judge 3 | Judge 4 | Judge 5 | Judge 6 | Judge 7 | Referee |
|---------|---------|---------|---------|---------|---------|---------|---------|
|         |         |         |         |         |         |         |         |

Name

Signature

\_\_\_\_\_  
\_\_\_\_\_





# Tawastia Open Karate 2/2024

Liivuoentie 24, Hmeenlinna, FINLAND

|             |                                |         |            |             |                           |                |    |
|-------------|--------------------------------|---------|------------|-------------|---------------------------|----------------|----|
| Court Nr.   | 1                              | Pool    | 1          | Date        | 2024-10-06                | Field Position | 61 |
| <b>RED</b>  |                                |         |            | <b>BLUE</b> |                           |                |    |
| NOC         | MAKSYMUK ULIANA (MAKSYMUK,FIN) |         |            | NOC         | LHETKANGAS EMMA (OKS,FIN) |                |    |
| Category    | Kumite, tytt, U10 yhdistetty   |         |            |             |                           |                |    |
| 3 Points    | 2 Points                       | 1 Point | Score      | 1 Point     | 2 Points                  | 3 Points       |    |
|             |                                |         | 4 : 1      |             |                           |                |    |
| Penatlity   |                                |         |            | Penatlity   |                           |                |    |
| C1: C1, C2: |                                |         | <b>4:1</b> | C1: , C2:   |                           |                |    |
| WINNER      |                                |         | Total      |             |                           |                |    |

PTS

## Decision of Superiority

| Judge 1 | Judge 2 | Judge 3 | Judge 4 | Judge 5 | Judge 6 | Judge 7 | Referee |
|---------|---------|---------|---------|---------|---------|---------|---------|
|         |         |         |         |         |         |         |         |

Name

Signature

\_\_\_\_\_  
\_\_\_\_\_



# Tawastia Open Karate 2/2024

Liivuorentie 24, Hmeenlinna, FINLAND

|            |                                      |         |            |             |                       |                |    |
|------------|--------------------------------------|---------|------------|-------------|-----------------------|----------------|----|
| Court Nr.  | 1                                    | Pool    | 1          | Date        | 2024-10-06            | Field Position | 62 |
| <b>RED</b> |                                      |         |            | <b>BLUE</b> |                       |                |    |
| NOC        | RUOTTINEN IINA (IMATRAN KUSANKU,FIN) |         |            | NOC         | HAKALA HELI (HKS,FIN) |                |    |
| Category   | Kumite, tytt, U10 yhdistetty         |         |            |             |                       |                |    |
| 3 Points   | 2 Points                             | 1 Point | Score      | 1 Point     | 2 Points              | 3 Points       |    |
|            |                                      |         | 4 : 2      |             |                       |                |    |
| Penatlity  |                                      |         |            | Penatlity   |                       |                |    |
| C1: , C2:  |                                      |         | <b>4:2</b> | C1: , C2:   |                       |                |    |
| WINNER     |                                      |         | Total      |             |                       |                |    |

PTS

## Decision of Superiority

| Judge 1 | Judge 2 | Judge 3 | Judge 4 | Judge 5 | Judge 6 | Judge 7 | Referee |
|---------|---------|---------|---------|---------|---------|---------|---------|
|         |         |         |         |         |         |         |         |

Name \_\_\_\_\_

Signature \_\_\_\_\_



# Tawastia Open Karate 2/2024

Liivuoentie 24, Hmeenlinna, FINLAND

|            |                                |         |            |             |                                      |                |    |
|------------|--------------------------------|---------|------------|-------------|--------------------------------------|----------------|----|
| Court Nr.  | 1                              | Pool    | 1          | Date        | 2024-10-06                           | Field Position | 63 |
| <b>RED</b> |                                |         |            | <b>BLUE</b> |                                      |                |    |
| NOC        | MAKSYMUK ULIANA (MAKSYMUK,FIN) |         |            | NOC         | RUOTTINEN IINA (IMATRAN KUSANKU,FIN) |                |    |
| Category   | Kumite, tytt, U10 yhdistetty   |         |            |             |                                      |                |    |
| 3 Points   | 2 Points                       | 1 Point | Score      | 1 Point     | 2 Points                             | 3 Points       |    |
|            |                                |         | 0 : 0      |             |                                      |                |    |
| Penatlity  |                                |         |            | Penatlity   |                                      |                |    |
| C1: , C2:  |                                |         | <b>0:0</b> | C1: , C2:   |                                      |                |    |
|            |                                |         | Total      | WINNER      |                                      |                |    |

HT

## Decision of Superiority

| Judge 1 | Judge 2 | Judge 3 | Judge 4 | Judge 5 | Judge 6 | Judge 7 | Referee |
|---------|---------|---------|---------|---------|---------|---------|---------|
|         |         |         |         |         |         |         |         |

Name

Signature

\_\_\_\_\_  
\_\_\_\_\_



# Tawastia Open Karate 2/2024

Liivuoentie 24, Hmeenlinna, FINLAND

|            |                              |         |            |             |                           |                |   |
|------------|------------------------------|---------|------------|-------------|---------------------------|----------------|---|
| Court Nr.  | 1                            | Pool    | 1          | Date        | 2024-10-06                | Field Position | 0 |
| <b>RED</b> |                              |         |            | <b>BLUE</b> |                           |                |   |
| NOC        | ABDELMOATY SARA (HKS,FIN)    |         |            | NOC         | LHETKANGAS EMMA (OKS,FIN) |                |   |
| Category   | Kumite, tytt, U10 yhdistetty |         |            |             |                           |                |   |
| 3 Points   | 2 Points                     | 1 Point | Score      | 1 Point     | 2 Points                  | 3 Points       |   |
|            |                              |         | 1 : 2      |             |                           |                |   |
| Penatlity  |                              |         |            | Penatlity   |                           |                |   |
| C1: , C2:  |                              |         | <b>1:2</b> | C1: , C2:   |                           |                |   |
|            |                              |         | Total      | WINNER      |                           |                |   |

PTS

## Decision of Superiority

| Judge 1 | Judge 2 | Judge 3 | Judge 4 | Judge 5 | Judge 6 | Judge 7 | Referee |
|---------|---------|---------|---------|---------|---------|---------|---------|
|         |         |         |         |         |         |         |         |

Name

Signature

\_\_\_\_\_  
\_\_\_\_\_



# Tawastia Open Karate 2/2024

Liivuoentie 24, Hmeenlinna, FINLAND

|             |                                       |         |            |             |                       |                |   |
|-------------|---------------------------------------|---------|------------|-------------|-----------------------|----------------|---|
| Court Nr.   | 2                                     | Pool    | 2          | Date        | 2024-10-06            | Field Position | 0 |
| <b>RED</b>  |                                       |         |            | <b>BLUE</b> |                       |                |   |
| NOC         | BATIKERU LAASYA (KARATE HERVANTA,FIN) |         |            | NOC         | HAKALA HELI (HKS,FIN) |                |   |
| Category    | Kumite, tytt, U10 yhdistetty          |         |            |             |                       |                |   |
| 3 Points    | 2 Points                              | 1 Point | Score      | 1 Point     | 2 Points              | 3 Points       |   |
|             |                                       |         | 0 : 5      |             |                       |                |   |
| Penatlity   |                                       |         |            | Penatlity   |                       |                |   |
| C1: HC, C2: |                                       |         | <b>0:5</b> | C1: , C2:   |                       |                |   |
|             |                                       |         | Total      | WINNER      |                       |                |   |

PTS

## Decision of Superiority

| Judge 1 | Judge 2 | Judge 3 | Judge 4 | Judge 5 | Judge 6 | Judge 7 | Referee |
|---------|---------|---------|---------|---------|---------|---------|---------|
|         |         |         |         |         |         |         |         |

Name

Signature

\_\_\_\_\_  
\_\_\_\_\_



# Tawastia Open Karate 2/2024

Liivuoentie 24, Hmeenlinna, FINLAND

|            |                              |         |       |             |                                       |                |   |
|------------|------------------------------|---------|-------|-------------|---------------------------------------|----------------|---|
| Court Nr.  | 2                            | Pool    | 2     | Date        | 2024-10-06                            | Field Position | 2 |
| <b>RED</b> |                              |         |       | <b>BLUE</b> |                                       |                |   |
| NOC        | LUOMA-IJ ELLAH (SPF,FIN)     |         |       | NOC         | BATIKERU LAASYA (KARATE HERVANTA,FIN) |                |   |
| Category   | Kumite, tytt, U10 yhdistetty |         |       |             |                                       |                |   |
| 3 Points   | 2 Points                     | 1 Point | Score | 1 Point     | 2 Points                              | 3 Points       |   |
|            |                              |         | :     |             |                                       |                |   |
| Penatlity  |                              |         |       | Penatlity   |                                       |                |   |
|            |                              |         |       |             |                                       |                |   |
|            |                              |         | Total |             |                                       |                |   |

## Decision of Superiority

|         |         |         |         |         |         |         |         |
|---------|---------|---------|---------|---------|---------|---------|---------|
| Judge 1 | Judge 2 | Judge 3 | Judge 4 | Judge 5 | Judge 6 | Judge 7 | Referee |
|         |         |         |         |         |         |         |         |

Name

Signature

\_\_\_\_\_

\_\_\_\_\_



## Tawastia Open Karate 2/2024 - 2024-10-05

## Official Results

| Kumite, tytöt, U10 yhdistetty |                  |                                    |   |               |  |
|-------------------------------|------------------|------------------------------------|---|---------------|--|
| 1                             | RUOTTINEN IINA   | BUDOSEURA<br>IMATRAN KUSANKU<br>RY |  | FIN - FINLAND |  |
| 2                             | MAKSYMUK ULIANA  | MAKSYMUK                           |  | FIN - FINLAND |  |
| 3                             | LÄHETKANGAS EMMA | OULUN<br>KARATESEURA               |  | FIN - FINLAND |  |
| 4                             | HAKALA HELI      | HÄMEENLINNAN<br>KARATESEURA        |  | FIN - FINLAND |  |
| 5                             | ABDELMOATY SARA  | HÄMEENLINNAN<br>KARATESEURA        |  | FIN - FINLAND |  |
| 5                             | BATIKERU LAASYA  | SHOTOKAN<br>HERVANTA RY            |  | FIN - FINLAND |  |
| 7                             | LUOMA-ÄIJÖ ELLAH | SPORTSKARATE.FI                    |  | FIN - FINLAND |  |

# KUMITE, TYTÖT, U12, +40 KG



Tawastia Open Karate 2/2024

**ENTRIES BY WEIGHT CATEGORY**  
**Kumite, tytt, U12, +40 kg**

As of 6 OCT 2024

| Country Code | ID | Gender | Name              | Seeding |
|--------------|----|--------|-------------------|---------|
| FIN          |    | F      | Ebdul Eziz Eva    |         |
| FIN          |    | F      | Heinnen Vanessa   |         |
| FIN          |    | F      | Koskela Jasmin    |         |
| FIN          |    | F      | Lehtiniemi Erin   |         |
| FIN          |    | F      | MAKSYMUK POLINA   |         |
| FIN          |    | F      | Nuhanovic Amina   |         |
| FIN          |    | F      | Savolainen Elli   |         |
| FIN          |    | F      | Veneranta Cecilia |         |

# Kumite, tytöt, U12, +40 kg

Tawastia Open Karate 2/2024, Liivuaarentie 24, Hämeenlinna, FIN

2024-10-05

Tatami  
2 15:45

Pool  
1/1

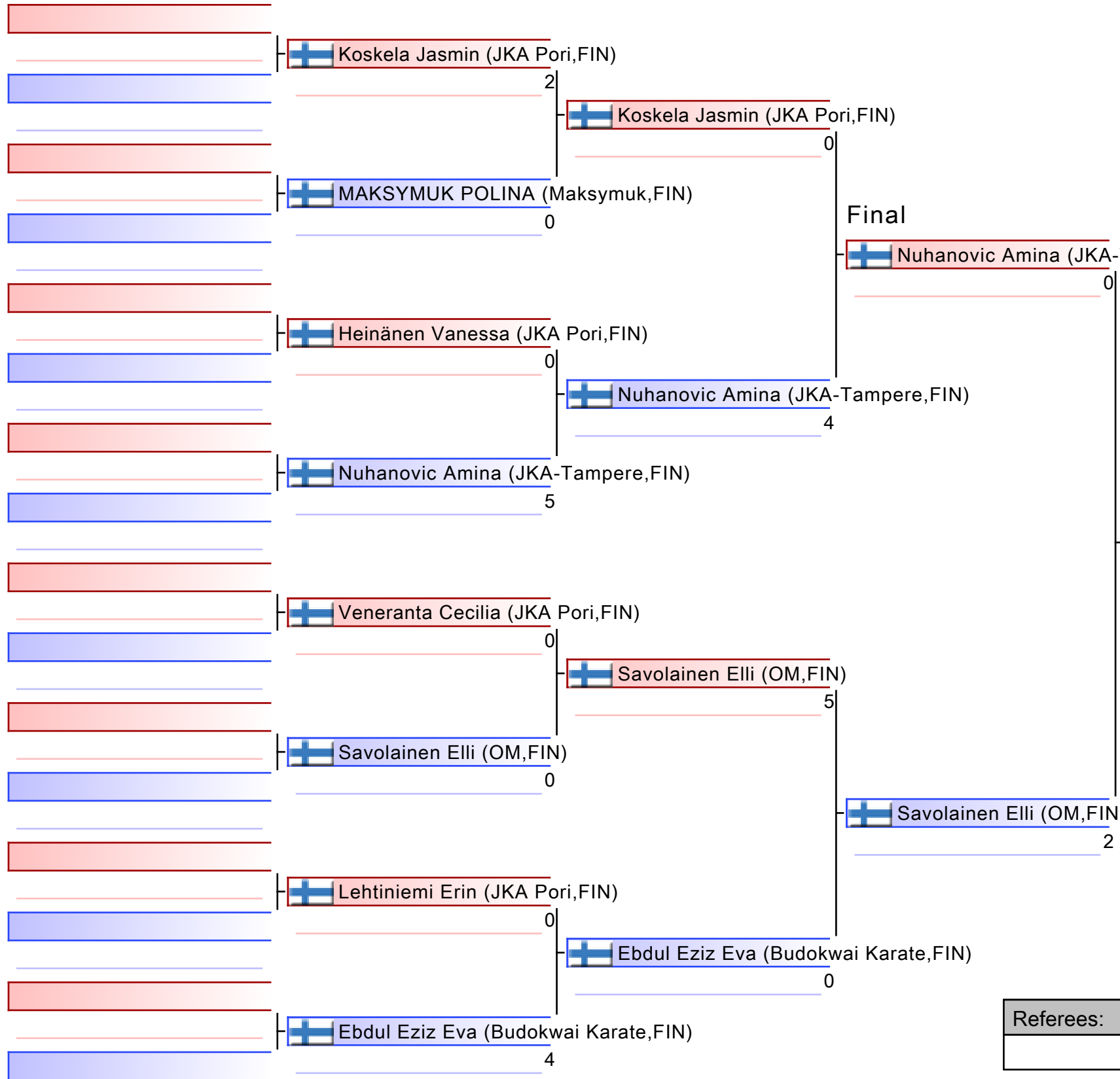

Savolainen Elli (OM,FIN)

|   |
|---|
| 1. SAVOLAINEN ELLI (OM,FIN)             |
| 2. NUHANOVIC AMINA (JKA-TAMPERE,FIN)    |
| 3. KOSKELA JASMIN (JKA PORI,FIN)        |
| 4. EBDUL EZIZ EVA (BUDOKWAI KARATE,FIN) |
| 5. HEINÄNEN VANESSA (JKA PORI,FIN)      |
| 5. VENERANTA CECILIA (JKA PORI,FIN)     |
|   |
|   |

|           |  |  |  |
|-----------|--|--|--|
| Referees: |  |  |  |
|           |  |  |  |

# Kumite, tytöt, U12, +40 kg

Tawastia Open Karate 2/2024

2024-10-05

Tatami  
2 15:45

Pool  
1

(c)sportdata GmbH & Co KG 2000-2024 (2024-10-06 10:03) v 10.2.0 build 1 (2024-09-26 10:14 CET) License: Online\_Event\_ID-8546\_TawastiaOpenKarate2024 (expire 2024-10-20)

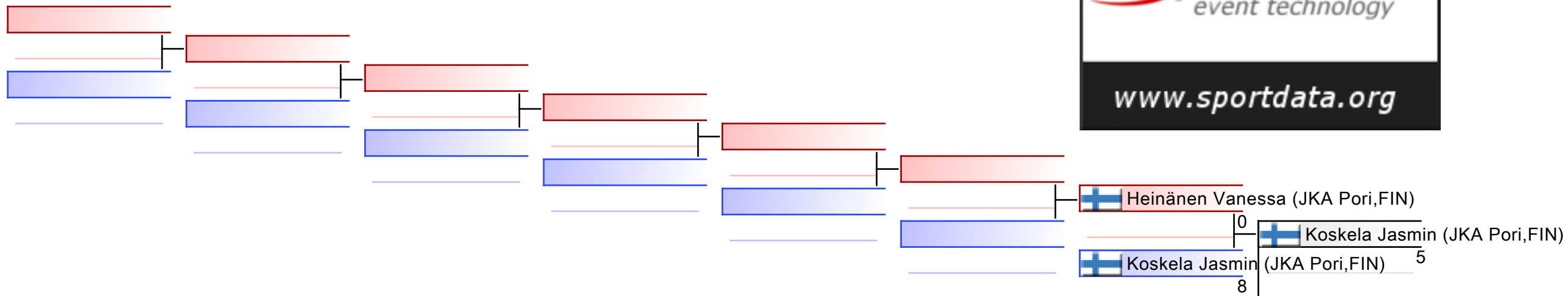

## REPECHAGE: (1)

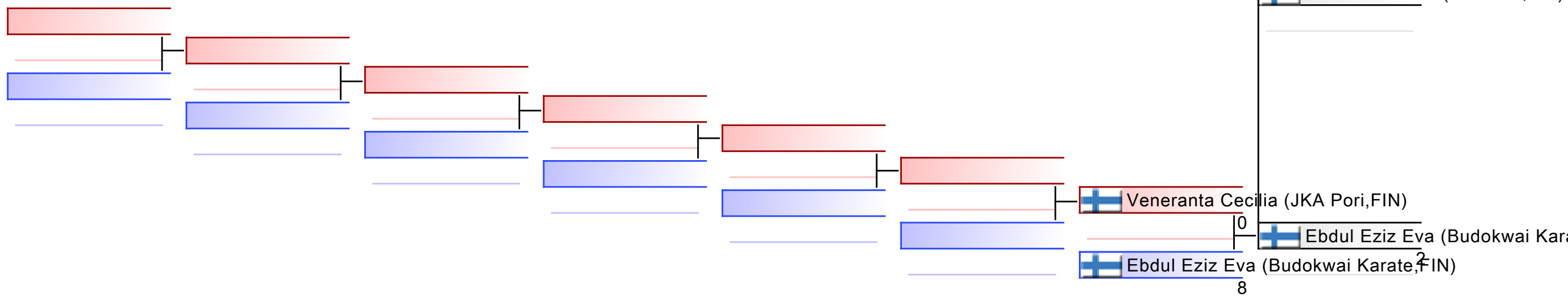

|           |  |  |  |  |  |  |  |
|-----------|--|--|--|--|--|--|--|
| Referees: |  |  |  |  |  |  |  |
|-----------|--|--|--|--|--|--|--|

# Tawastia Open Karate 2/2024

Liivuoentie 24, Hmeenlinna, FINLAND

|             |                               |         |       |             |                                |                |    |
|-------------|-------------------------------|---------|-------|-------------|--------------------------------|----------------|----|
| Court Nr.   | 1                             | Pool    | 1     | Date        | 2024-10-06                     | Field Position | 57 |
| <b>RED</b>  |                               |         |       | <b>BLUE</b> |                                |                |    |
| NOC         | KOSKELA JASMIN (JKA PORI,FIN) |         |       | NOC         | MAKSYMUK POLINA (MAKSYMUK,FIN) |                |    |
| Category    | Kumite, tytt, U12, +40 kg     |         |       |             |                                |                |    |
| 3 Points    | 2 Points                      | 1 Point | Score | 1 Point     | 2 Points                       | 3 Points       |    |
|             |                               |         | 2 : 0 |             |                                |                |    |
| Penatlity   |                               |         |       | Penatlity   |                                |                |    |
| C1: C1, C2: |                               |         |       | <b>2:0</b>  | C1: , C2:                      |                |    |
| WINNER      |                               |         |       | Total       |                                |                |    |

PTS

## Decision of Superiority

| Judge 1 | Judge 2 | Judge 3 | Judge 4 | Judge 5 | Judge 6 | Judge 7 | Referee |
|---------|---------|---------|---------|---------|---------|---------|---------|
|         |         |         |         |         |         |         |         |

Name \_\_\_\_\_

Signature \_\_\_\_\_



# Tawastia Open Karate 2/2024

Liivuoentie 24, Hmeenlinna, FINLAND

|            |                                |         |            |             |                                   |                |    |
|------------|--------------------------------|---------|------------|-------------|-----------------------------------|----------------|----|
| Court Nr.  | 1                              | Pool    | 1          | Date        | 2024-10-06                        | Field Position | 58 |
| <b>RED</b> |                                |         |            | <b>BLUE</b> |                                   |                |    |
| NOC        | HEINNEN VANESSA (JKA PORI,FIN) |         |            | NOC         | NUHANOVIC AMINA (JKA-TAMPERE,FIN) |                |    |
| Category   | Kumite, tytt, U12, +40 kg      |         |            |             |                                   |                |    |
| 3 Points   | 2 Points                       | 1 Point | Score      | 1 Point     | 2 Points                          | 3 Points       |    |
|            |                                |         | 0 : 5      |             |                                   |                |    |
| Penatlity  |                                |         |            | Penatlity   |                                   |                |    |
| C1: , C2:  |                                |         | <b>0:5</b> | C1: , C2:   |                                   |                |    |
|            |                                |         | Total      | WINNER      |                                   |                |    |

PTS

## Decision of Superiority

| Judge 1 | Judge 2 | Judge 3 | Judge 4 | Judge 5 | Judge 6 | Judge 7 | Referee |
|---------|---------|---------|---------|---------|---------|---------|---------|
|         |         |         |         |         |         |         |         |

Name

Signature

\_\_\_\_\_

\_\_\_\_\_



# Tawastia Open Karate 2/2024

Liivuoentie 24, Hmeenlinna, FINLAND

|            |                                  |         |            |             |                          |                |    |
|------------|----------------------------------|---------|------------|-------------|--------------------------|----------------|----|
| Court Nr.  | 1                                | Pool    | 1          | Date        | 2024-10-06               | Field Position | 59 |
| <b>RED</b> |                                  |         |            | <b>BLUE</b> |                          |                |    |
| NOC        | VENERANTA CECILIA (JKA PORI,FIN) |         |            | NOC         | SAVOLAINEN ELLI (OM,FIN) |                |    |
| Category   | Kumite, tytt, U12, +40 kg        |         |            |             |                          |                |    |
| 3 Points   | 2 Points                         | 1 Point | Score      | 1 Point     | 2 Points                 | 3 Points       |    |
|            |                                  |         | 0 : 0      |             |                          |                |    |
| Penatlity  |                                  |         |            | Penatlity   |                          |                |    |
| C1: , C2:  |                                  |         | <b>0:0</b> | C1: , C2:   |                          |                |    |
|            |                                  |         | Total      | WINNER      |                          |                |    |

PTS

## Decision of Superiority

| Judge 1 | Judge 2 | Judge 3 | Judge 4 | Judge 5 | Judge 6 | Judge 7 | Referee |
|---------|---------|---------|---------|---------|---------|---------|---------|
|         |         |         |         |         |         |         |         |

Name

Signature

\_\_\_\_\_  
\_\_\_\_\_



# Tawastia Open Karate 2/2024

Liivuoentie 24, Hmeenlinna, FINLAND

|            |                                |         |            |             |                                      |                |    |
|------------|--------------------------------|---------|------------|-------------|--------------------------------------|----------------|----|
| Court Nr.  | 1                              | Pool    | 1          | Date        | 2024-10-06                           | Field Position | 60 |
| <b>RED</b> |                                |         |            | <b>BLUE</b> |                                      |                |    |
| NOC        | LEHTINIEMI ERIN (JKA PORI,FIN) |         |            | NOC         | EBDUL EZIZ EVA (BUDOKWAI KARATE,FIN) |                |    |
| Category   | Kumite, tytt, U12, +40 kg      |         |            |             |                                      |                |    |
| 3 Points   | 2 Points                       | 1 Point | Score      | 1 Point     | 2 Points                             | 3 Points       |    |
|            |                                |         | 0 : 4      |             |                                      |                |    |
| Penatlity  |                                |         |            | Penatlity   |                                      |                |    |
| C1: , C2:  |                                |         | <b>0:4</b> | C1: , C2:   |                                      |                |    |
|            |                                |         | Total      | WINNER      |                                      |                |    |

PTS

## Decision of Superiority

| Judge 1 | Judge 2 | Judge 3 | Judge 4 | Judge 5 | Judge 6 | Judge 7 | Referee |
|---------|---------|---------|---------|---------|---------|---------|---------|
|         |         |         |         |         |         |         |         |

Name

Signature

\_\_\_\_\_  
\_\_\_\_\_



# Tawastia Open Karate 2/2024

Liivuoentie 24, Hmeenlinna, FINLAND

|            |                               |         |            |             |                                   |                |    |
|------------|-------------------------------|---------|------------|-------------|-----------------------------------|----------------|----|
| Court Nr.  | 1                             | Pool    | 1          | Date        | 2024-10-06                        | Field Position | 61 |
| <b>RED</b> |                               |         |            | <b>BLUE</b> |                                   |                |    |
| NOC        | KOSKELA JASMIN (JKA PORI,FIN) |         |            | NOC         | NUHANOVIC AMINA (JKA-TAMPERE,FIN) |                |    |
| Category   | Kumite, tytt, U12, +40 kg     |         |            |             |                                   |                |    |
| 3 Points   | 2 Points                      | 1 Point | Score      | 1 Point     | 2 Points                          | 3 Points       |    |
|            |                               |         | 0 : 4      |             |                                   |                |    |
| Penatlity  |                               |         |            | Penatlity   |                                   |                |    |
| C1: , C2:  |                               |         | <b>0:4</b> | C1: , C2:   |                                   |                |    |
|            |                               |         | Total      | WINNER      |                                   |                |    |

PTS

## Decision of Superiority

| Judge 1 | Judge 2 | Judge 3 | Judge 4 | Judge 5 | Judge 6 | Judge 7 | Referee |
|---------|---------|---------|---------|---------|---------|---------|---------|
|         |         |         |         |         |         |         |         |

Name

Signature

\_\_\_\_\_  
\_\_\_\_\_





# Tawastia Open Karate 2/2024

Liivuoentie 24, Hmeenlinna, FINLAND

|             |                           |         |            |             |                                      |                |    |
|-------------|---------------------------|---------|------------|-------------|--------------------------------------|----------------|----|
| Court Nr.   | 1                         | Pool    | 1          | Date        | 2024-10-06                           | Field Position | 62 |
| <b>RED</b>  |                           |         |            | <b>BLUE</b> |                                      |                |    |
| NOC         | SAVOLAINEN ELLI (OM,FIN)  |         |            | NOC         | EBDUL EZIZ EVA (BUDOKWAI KARATE,FIN) |                |    |
| Category    | Kumite, tytt, U12, +40 kg |         |            |             |                                      |                |    |
| 3 Points    | 2 Points                  | 1 Point | Score      | 1 Point     | 2 Points                             | 3 Points       |    |
|             |                           |         | 5 : 0      |             |                                      |                |    |
| Penatlity   |                           |         |            | Penatlity   |                                      |                |    |
| C1: C2, C2: |                           |         | <b>5:0</b> | C1: C1, C2: |                                      |                |    |
| WINNER      |                           |         | Total      |             |                                      |                |    |

PTS

## Decision of Superiority

|         |         |         |         |         |         |         |         |
|---------|---------|---------|---------|---------|---------|---------|---------|
| Judge 1 | Judge 2 | Judge 3 | Judge 4 | Judge 5 | Judge 6 | Judge 7 | Referee |
|         |         |         |         |         |         |         |         |

Name

Signature

\_\_\_\_\_  
\_\_\_\_\_



# Tawastia Open Karate 2/2024

Liivuoentie 24, Hmeenlinna, FINLAND

|             |                                      |         |            |             |                          |                |    |
|-------------|--------------------------------------|---------|------------|-------------|--------------------------|----------------|----|
| Court Nr.   | 1                                    | Pool    | 1          | Date        | 2024-10-06               | Field Position | 63 |
| <b>RED</b>  |                                      |         |            | <b>BLUE</b> |                          |                |    |
| NOC         | NUHANOVIC AMINA<br>(JKA-TAMPERE,FIN) |         |            | NOC         | SAVOLAINEN ELLI (OM,FIN) |                |    |
| Category    | Kumite, tytt, U12, +40 kg            |         |            |             |                          |                |    |
| 3 Points    | 2 Points                             | 1 Point | Score      | 1 Point     | 2 Points                 | 3 Points       |    |
|             |                                      |         | 0 : 2      |             |                          |                |    |
| Penatlity   |                                      |         |            | Penatlity   |                          |                |    |
| C1: C1, C2: |                                      |         | <b>0:2</b> | C1: , C2:   |                          |                |    |
|             |                                      |         | Total      | WINNER      |                          |                |    |

PTS

## Decision of Superiority

| Judge 1 | Judge 2 | Judge 3 | Judge 4 | Judge 5 | Judge 6 | Judge 7 | Referee |
|---------|---------|---------|---------|---------|---------|---------|---------|
|         |         |         |         |         |         |         |         |

Name

Signature

\_\_\_\_\_  
\_\_\_\_\_



# Tawastia Open Karate 2/2024

Liivuoentie 24, Hmeenlinna, FINLAND

|            |                                |         |       |             |                               |                |   |
|------------|--------------------------------|---------|-------|-------------|-------------------------------|----------------|---|
| Court Nr.  | 1                              | Pool    | 1     | Date        | 2024-10-06                    | Field Position | 0 |
| <b>RED</b> |                                |         |       | <b>BLUE</b> |                               |                |   |
| NOC        | HEINNEN VANESSA (JKA PORI,FIN) |         |       | NOC         | KOSKELA JASMIN (JKA PORI,FIN) |                |   |
| Category   | Kumite, tytt, U12, +40 kg      |         |       |             |                               |                |   |
| 3 Points   | 2 Points                       | 1 Point | Score | 1 Point     | 2 Points                      | 3 Points       |   |
|            |                                |         | :     |             |                               |                |   |
| Penatlity  |                                |         |       | Penatlity   |                               |                |   |
|            |                                |         |       |             |                               |                |   |
|            |                                |         | Total |             |                               |                |   |

## Decision of Superiority

|         |         |         |         |         |         |         |         |
|---------|---------|---------|---------|---------|---------|---------|---------|
| Judge 1 | Judge 2 | Judge 3 | Judge 4 | Judge 5 | Judge 6 | Judge 7 | Referee |
|         |         |         |         |         |         |         |         |

Name

Signature

\_\_\_\_\_

\_\_\_\_\_



# Tawastia Open Karate 2/2024

Liivuoentie 24, Hmeenlinna, FINLAND

|            |                                  |         |            |             |                                      |                |   |
|------------|----------------------------------|---------|------------|-------------|--------------------------------------|----------------|---|
| Court Nr.  | 2                                | Pool    | 2          | Date        | 2024-10-06                           | Field Position | 0 |
| <b>RED</b> |                                  |         |            | <b>BLUE</b> |                                      |                |   |
| NOC        | VENERANTA CECILIA (JKA PORI,FIN) |         |            | NOC         | EBDUL EZIZ EVA (BUDOKWAI KARATE,FIN) |                |   |
| Category   | Kumite, tytt, U12, +40 kg        |         |            |             |                                      |                |   |
| 3 Points   | 2 Points                         | 1 Point | Score      | 1 Point     | 2 Points                             | 3 Points       |   |
|            |                                  |         | 0 : 8      |             |                                      |                |   |
| Penatlity  |                                  |         |            | Penatlity   |                                      |                |   |
| C1: , C2:  |                                  |         | <b>0:8</b> | C1: , C2:   |                                      |                |   |
|            |                                  |         | Total      | WINNER      |                                      |                |   |

PTS

## Decision of Superiority

| Judge 1 | Judge 2 | Judge 3 | Judge 4 | Judge 5 | Judge 6 | Judge 7 | Referee |
|---------|---------|---------|---------|---------|---------|---------|---------|
|         |         |         |         |         |         |         |         |

Name







Signature

\_\_\_\_\_  
\_\_\_\_\_



## Tawastia Open Karate 2/2024 - 2024-10-05

## Official Results

| Kumite, tytöt, U12, +40 kg |                   |   |   |               |  |
|----------------------------|-------------------|---|---|---------------|--|
| 1                          | SAVOLAINEN ELLI   | SPORTSKARATE<br>KUOPIO                    |  | FIN - FINLAND |  |
| 2                          | NUHANOVIC AMINA   | JAPAN KARATE<br>ASSOCIATION<br>TAMPERE RY |  | FIN - FINLAND |  |
| 3                          | KOSKELA JASMIN    | PORIN SHOTOKAN                            |  | FIN - FINLAND |  |
| 4                          | EBDUL EZIZ EVA    | BUDOKWAI RY<br>KARATE                     |  | FIN - FINLAND |  |
| 5                          | HEINÄNEN VANESSA  | PORIN SHOTOKAN                            |  | FIN - FINLAND |  |
| 5                          | VENERANTA CECILIA | PORIN SHOTOKAN                            |  | FIN - FINLAND |  |

# KUMITE, TYTÖT, U12, -34 KG

Tawastia Open Karate 2/2024

**ENTRIES BY WEIGHT CATEGORY**

**Kumite, tytt, U12, -34 kg**

As of 6 OCT 2024

| Country Code | ID | Gender | Name        | Seeding |
|--------------|----|--------|-------------|---------|
| FIN          |    | F      | Anbar Hiba  |         |
| FIN          |    | F      | Arun Isha   |         |
| FIN          |    | F      | Nyknen Tara |         |

# Kumite, tytöt, U12, -34 kg - Round Robin (each against each)

Tawastia Open Karate 2/2024, Liivüorentie 24, Hämeenlinna, FIN









2024-10-05

Tatami

2 15:15

Pool

1/1

|   |   |   |  |
|---|---|---|--|
| 1 |  Anbar Hiba (Karate Hervanta,FIN) | 8 |  Anbar Hiba (Karate Hervanta,FIN) |
| 2 |  Nykänen Tara (Nykänen,FIN)       | 0 |  |
| 3 |  Anbar Hiba (Karate Hervanta,FIN) | 0 |  Arun Iisha (Karate Hervanta,FIN) |
| 4 |  Arun Iisha (Karate Hervanta,FIN) | 8 |  |
| 5 |  Nykänen Tara (Nykänen,FIN)       | 0 |  Arun Iisha (Karate Hervanta,FIN) |
| 6 |  Arun Iisha (Karate Hervanta,FIN) | 8 |  |



|                                     |
|-------------------------------------|
| 1. ARUN IISHA (KARATE HERVANTA,FIN) |
| 2. ANBAR HIBA (KARATE HERVANTA,FIN) |
| 3. NYKÄNEN TARA (NYKÄNEN,FIN)       |
|                                     |
|                                     |
|                                     |
|                                     |

|           |  |  |  |
|-----------|--|--|--|
| Referees: |  |  |  |
|           |  |  |  |



# Tawastia Open Karate 2/2024

Liivuoentie 24, Hmeenlinna, FINLAND

|             |                                  |         |            |             |                          |                |       |
|-------------|----------------------------------|---------|------------|-------------|--------------------------|----------------|-------|
| Court Nr.   | 1                                | Pool    | 1          | Date        | 2024-10-06               | Field Position | -9951 |
| <b>RED</b>  |                                  |         |            | <b>BLUE</b> |                          |                |       |
| NOC         | ANBAR HIBA (KARATE HERVANTA,FIN) |         |            | NOC         | NYKNEN TARA (NYKNEN,FIN) |                |       |
| Category    | Kumite, tytt, U12, -34 kg        |         |            |             |                          |                |       |
| 3 Points    | 2 Points                         | 1 Point | Score      | 1 Point     | 2 Points                 | 3 Points       |       |
|             |                                  |         | 8 : 0      |             |                          |                |       |
| Penatlity   |                                  |         |            | Penatlity   |                          |                |       |
| C1: C1, C2: |                                  |         | <b>8:0</b> | C1: C3, C2: |                          |                |       |
| WINNER      |                                  |         | Total      |             |                          |                |       |

KI

## Decision of Superiority

| Judge 1 | Judge 2 | Judge 3 | Judge 4 | Judge 5 | Judge 6 | Judge 7 | Referee |
|---------|---------|---------|---------|---------|---------|---------|---------|
|         |         |         |         |         |         |         |         |

Name

Signature

\_\_\_\_\_  
\_\_\_\_\_



# Tawastia Open Karate 2/2024

Liivuoentie 24, Hmeenlinna, FINLAND

|            |                                  |         |            |             |                                  |                |       |
|------------|----------------------------------|---------|------------|-------------|----------------------------------|----------------|-------|
| Court Nr.  | 1                                | Pool    | 1          | Date        | 2024-10-06                       | Field Position | -9950 |
| <b>RED</b> |                                  |         |            | <b>BLUE</b> |                                  |                |       |
| NOC        | ANBAR HIBA (KARATE HERVANTA,FIN) |         |            | NOC         | ARUN IISHA (KARATE HERVANTA,FIN) |                |       |
| Category   | Kumite, tytt, U12, -34 kg        |         |            |             |                                  |                |       |
| 3 Points   | 2 Points                         | 1 Point | Score      | 1 Point     | 2 Points                         | 3 Points       |       |
|            |                                  |         | 0 : 8      |             |                                  |                |       |
| Penatlity  |                                  |         |            | Penatlity   |                                  |                |       |
| C1: , C2:  |                                  |         | <b>0:8</b> | C1: , C2:   |                                  |                |       |
|            |                                  |         | Total      | WINNER      |                                  |                |       |

PTS

## Decision of Superiority

|         |         |         |         |         |         |         |         |
|---------|---------|---------|---------|---------|---------|---------|---------|
| Judge 1 | Judge 2 | Judge 3 | Judge 4 | Judge 5 | Judge 6 | Judge 7 | Referee |
|         |         |         |         |         |         |         |         |

Name

Signature

\_\_\_\_\_  
\_\_\_\_\_



# Tawastia Open Karate 2/2024

Liivuoentie 24, Hmeenlinna, FINLAND

|            |                           |         |            |             |                                  |                |       |
|------------|---------------------------|---------|------------|-------------|----------------------------------|----------------|-------|
| Court Nr.  | 1                         | Pool    | 1          | Date        | 2024-10-06                       | Field Position | -9949 |
| <b>RED</b> |                           |         |            | <b>BLUE</b> |                                  |                |       |
| NOC        | NYKNEN TARA (NYKNEN,FIN)  |         |            | NOC         | ARUN IISHA (KARATE HERVANTA,FIN) |                |       |
| Category   | Kumite, tytt, U12, -34 kg |         |            |             |                                  |                |       |
| 3 Points   | 2 Points                  | 1 Point | Score      | 1 Point     | 2 Points                         | 3 Points       |       |
|            |                           |         | 0 : 8      |             |                                  |                |       |
| Penatlity  |                           |         |            | Penatlity   |                                  |                |       |
| C1: , C2:  |                           |         | <b>0:8</b> | C1: , C2:   |                                  |                |       |
|            |                           |         | Total      | WINNER      |                                  |                |       |

KI

## Decision of Superiority

| Judge 1 | Judge 2 | Judge 3 | Judge 4 | Judge 5 | Judge 6 | Judge 7 | Referee |
|---------|---------|---------|---------|---------|---------|---------|---------|
|         |         |         |         |         |         |         |         |



Name \_\_\_\_\_

Signature \_\_\_\_\_



Tawastia Open Karate 2/2024 - 2024-10-05

Official Results

| Kumite, tytöt, U12, -34 kg |              |                         |   |               |
|----------------------------|--------------|-------------------------|---|---------------|
| 1                          | ARUN IISHA   | SHOTOKAN<br>HERVANTA RY |  | FIN - FINLAND |
| 2                          | ANBAR HIBA   | SHOTOKAN<br>HERVANTA RY |  | FIN - FINLAND |
| 3                          | NYKÄNEN TARA | NYKÄNEN                 |  | FIN - FINLAND |

# KUMITE, TYTÖT, U12, -40 KG

Tawastia Open Karate 2/2024

**ENTRIES BY WEIGHT CATEGORY**  
**Kumite, tytt, U12, -40 kg**

As of 6 OCT 2024

| Country Code | ID | Gender | Name            | Seeding |
|--------------|----|--------|-----------------|---------|
| FIN          |    | F      | Hakala Hanna    |         |
| FIN          |    | F      | Heino Lilya     |         |
| FIN          |    | F      | Lindroos Emilia |         |
| FIN          |    | F      | Sankari Nelli   |         |



















# Kumite, tytöt, U12, -40 kg - Round Robin (each against each)

Tawastia Open Karate 2/2024, Liivuorentie 24, Hämeenlinna, FIN

2024-10-05

Tatami  
2 15:25

Pool  
1/1

|    |   |   |  |
|----|---|---|--|
| 1  |  Sankari Nelli (JKA Pori,FIN)     | 0 |  Hakala Hanna (HKS,FIN)         |
| 2  |  Hakala Hanna (HKS,FIN)           | 8 |  |
| 3  |  Lindroos Emilia (JKA Pori,FIN)   | 0 |  Heino Lilya (Erä,FIN)          |
| 4  |  Heino Lilya (Erä,FIN)            | 4 |  |
| 5  |  Sankari Nelli (JKA Pori,FIN)     | 0 |  Lindroos Emilia (JKA Pori,FIN) |
| 6  |  Lindroos Emilia (JKA Pori,FIN)   | 1 |  |
| 7  |  Heino Lilya (Erä,FIN)            | 4 |  Heino Lilya (Erä,FIN)          |
| 8  |  Hakala Hanna (HKS,FIN)           | 0 |  |
| 9  |  Sankari Nelli (JKA Pori,FIN)    | 0 |  Heino Lilya (Erä,FIN)        |
| 10 |  Heino Lilya (Erä,FIN)          | 2 |  |
| 11 |  Hakala Hanna (HKS,FIN)         | 1 |  Hakala Hanna (HKS,FIN)       |
| 12 |  Lindroos Emilia (JKA Pori,FIN) | 0 |  |



|                                   |
|-----------------------------------|
| 1. HEINO LILYA (ERÄ,FIN)          |
| 2. HAKALA HANNA (HKS,FIN)         |
| 3. LINDROOS EMILIA (JKA PORI,FIN) |
| 4. SANKARI NELLI (JKA PORI,FIN)   |
|                                   |
|                                   |
|                                   |

|           |  |  |  |
|-----------|--|--|--|
| Referees: |  |  |  |
|           |  |  |  |

# Tawastia Open Karate 2/2024

Liivuoentie 24, Hmeenlinna, FINLAND

|             |                              |         |            |             |                        |                |       |
|-------------|------------------------------|---------|------------|-------------|------------------------|----------------|-------|
| Court Nr.   | 1                            | Pool    | 1          | Date        | 2024-10-06             | Field Position | -9951 |
| <b>RED</b>  |                              |         |            | <b>BLUE</b> |                        |                |       |
| NOC         | SANKARI NELLI (JKA PORI,FIN) |         |            | NOC         | HAKALA HANNA (HKS,FIN) |                |       |
| Category    | Kumite, tytt, U12, -40 kg    |         |            |             |                        |                |       |
| 3 Points    | 2 Points                     | 1 Point | Score      | 1 Point     | 2 Points               | 3 Points       |       |
|             |                              |         | 0 : 8      |             |                        |                |       |
| Penatlity   |                              |         |            | Penatlity   |                        |                |       |
| C1: C1, C2: |                              |         | <b>0:8</b> | C1: C1, C2: |                        |                |       |
|             |                              |         | Total      | WINNER      |                        |                |       |

PTS

## Decision of Superiority

| Judge 1 | Judge 2 | Judge 3 | Judge 4 | Judge 5 | Judge 6 | Judge 7 | Referee |
|---------|---------|---------|---------|---------|---------|---------|---------|
|         |         |         |         |         |         |         |         |

Name

Signature

\_\_\_\_\_  
\_\_\_\_\_





# Tawastia Open Karate 2/2024

Liivuoentie 24, Hmeenlinna, FINLAND

|            |                                |         |            |             |                      |                |       |
|------------|--------------------------------|---------|------------|-------------|----------------------|----------------|-------|
| Court Nr.  | 1                              | Pool    | 1          | Date        | 2024-10-06           | Field Position | -9950 |
| <b>RED</b> |                                |         |            | <b>BLUE</b> |                      |                |       |
| NOC        | LINDROOS EMILIA (JKA PORI,FIN) |         |            | NOC         | HEINO LILYA (ER,FIN) |                |       |
| Category   | Kumite, tytt, U12, -40 kg      |         |            |             |                      |                |       |
| 3 Points   | 2 Points                       | 1 Point | Score      | 1 Point     | 2 Points             | 3 Points       |       |
|            |                                |         | 0 : 4      |             |                      |                |       |
| Penatlity  |                                |         |            | Penatlity   |                      |                |       |
| C1: , C2:  |                                |         | <b>0:4</b> | C1: , C2:   |                      |                |       |
|            |                                |         | Total      | WINNER      |                      |                |       |

PTS

## Decision of Superiority

| Judge 1 | Judge 2 | Judge 3 | Judge 4 | Judge 5 | Judge 6 | Judge 7 | Referee |
|---------|---------|---------|---------|---------|---------|---------|---------|
|         |         |         |         |         |         |         |         |

Name

Signature

\_\_\_\_\_  
\_\_\_\_\_



# Tawastia Open Karate 2/2024

Liivuoentie 24, Hmeenlinna, FINLAND

|             |                              |         |            |             |                                |                |       |
|-------------|------------------------------|---------|------------|-------------|--------------------------------|----------------|-------|
| Court Nr.   | 1                            | Pool    | 1          | Date        | 2024-10-06                     | Field Position | -9949 |
| <b>RED</b>  |                              |         |            | <b>BLUE</b> |                                |                |       |
| NOC         | SANKARI NELLI (JKA PORI,FIN) |         |            | NOC         | LINDROOS EMILIA (JKA PORI,FIN) |                |       |
| Category    | Kumite, tytt, U12, -40 kg    |         |            |             |                                |                |       |
| 3 Points    | 2 Points                     | 1 Point | Score      | 1 Point     | 2 Points                       | 3 Points       |       |
|             |                              |         | 0 : 1      |             |                                |                |       |
| Penatlity   |                              |         |            | Penatlity   |                                |                |       |
| C1: C1, C2: |                              |         | <b>0:1</b> | C1: , C2:   |                                |                |       |
|             |                              |         | Total      | WINNER      |                                |                |       |

PTS

## Decision of Superiority

| Judge 1 | Judge 2 | Judge 3 | Judge 4 | Judge 5 | Judge 6 | Judge 7 | Referee |
|---------|---------|---------|---------|---------|---------|---------|---------|
|         |         |         |         |         |         |         |         |

Name \_\_\_\_\_

Signature \_\_\_\_\_



# Tawastia Open Karate 2/2024

Liivuoentie 24, Hmeenlinna, FINLAND

|            |                           |         |            |             |                        |                |       |
|------------|---------------------------|---------|------------|-------------|------------------------|----------------|-------|
| Court Nr.  | 1                         | Pool    | 1          | Date        | 2024-10-06             | Field Position | -9948 |
| <b>RED</b> |                           |         |            | <b>BLUE</b> |                        |                |       |
| NOC        | HEINO LILYA (ER,FIN)      |         |            | NOC         | HAKALA HANNA (HKS,FIN) |                |       |
| Category   | Kumite, tytt, U12, -40 kg |         |            |             |                        |                |       |
| 3 Points   | 2 Points                  | 1 Point | Score      | 1 Point     | 2 Points               | 3 Points       |       |
|            |                           |         | 4 : 0      |             |                        |                |       |
| Penatlity  |                           |         |            | Penatlity   |                        |                |       |
| C1: , C2:  |                           |         | <b>4:0</b> | C1: , C2:   |                        |                |       |
| WINNER     |                           |         | Total      |             |                        |                |       |

PTS

## Decision of Superiority

| Judge 1 | Judge 2 | Judge 3 | Judge 4 | Judge 5 | Judge 6 | Judge 7 | Referee |
|---------|---------|---------|---------|---------|---------|---------|---------|
|         |         |         |         |         |         |         |         |

Name

Signature

\_\_\_\_\_

\_\_\_\_\_



# Tawastia Open Karate 2/2024

Liivuoentie 24, Hmeenlinna, FINLAND

|            |                              |         |            |             |                      |                |       |
|------------|------------------------------|---------|------------|-------------|----------------------|----------------|-------|
| Court Nr.  | 1                            | Pool    | 1          | Date        | 2024-10-06           | Field Position | -9947 |
| <b>RED</b> |                              |         |            | <b>BLUE</b> |                      |                |       |
| NOC        | SANKARI NELLI (JKA PORI,FIN) |         |            | NOC         | HEINO LILYA (ER,FIN) |                |       |
| Category   | Kumite, tytt, U12, -40 kg    |         |            |             |                      |                |       |
| 3 Points   | 2 Points                     | 1 Point | Score      | 1 Point     | 2 Points             | 3 Points       |       |
|            |                              |         | 0 : 2      |             |                      |                |       |
| Penatlity  |                              |         |            | Penatlity   |                      |                |       |
| C1: , C2:  |                              |         | <b>0:2</b> | C1: C1, C2: |                      |                |       |
|            |                              |         | Total      | WINNER      |                      |                |       |

PTS

## Decision of Superiority

| Judge 1 | Judge 2 | Judge 3 | Judge 4 | Judge 5 | Judge 6 | Judge 7 | Referee |
|---------|---------|---------|---------|---------|---------|---------|---------|
|         |         |         |         |         |         |         |         |

Name

Signature

\_\_\_\_\_  
\_\_\_\_\_



# Tawastia Open Karate 2/2024

Liivuoentie 24, Hmeenlinna, FINLAND

|            |                           |         |             |             |                                |                |       |
|------------|---------------------------|---------|-------------|-------------|--------------------------------|----------------|-------|
| Court Nr.  | 1                         | Pool    | 1           | Date        | 2024-10-06                     | Field Position | -9946 |
| <b>RED</b> |                           |         |             | <b>BLUE</b> |                                |                |       |
| NOC        | HAKALA HANNA (HKS,FIN)    |         |             | NOC         | LINDROOS EMILIA (JKA PORI,FIN) |                |       |
| Category   | Kumite, tytt, U12, -40 kg |         |             |             |                                |                |       |
| 3 Points   | 2 Points                  | 1 Point | Score       | 1 Point     | 2 Points                       | 3 Points       |       |
|            |                           |         | 10 : 0      |             |                                |                |       |
| Penatlity  |                           |         |             | Penatlity   |                                |                |       |
| C1: , C2:  |                           |         | <b>10:0</b> | C1: , C2:   |                                |                |       |
| WINNER     |                           |         | Total       |             |                                |                |       |

PTS

## Decision of Superiority

| Judge 1 | Judge 2 | Judge 3 | Judge 4 | Judge 5 | Judge 6 | Judge 7 | Referee |
|---------|---------|---------|---------|---------|---------|---------|---------|
|         |         |         |         |         |         |         |         |

Name





Signature

\_\_\_\_\_  
\_\_\_\_\_



## Tawastia Open Karate 2/2024 - 2024-10-05

## Official Results

| Kumite, tytöt, U12, -40 kg |                 |                             |   |               |
|----------------------------|-----------------|-----------------------------|---|---------------|
| 1                          | HEINO LILYA     | TAPANILAN ERÄ               |  | FIN - FINLAND |
| 2                          | HAKALA HANNA    | HÄMEENLINNAN<br>KARATESEURA |  | FIN - FINLAND |
| 3                          | LINDROOS EMILIA | PORIN SHOTOKAN              |  | FIN - FINLAND |
| 4                          | SANKARI NELLI   | PORIN SHOTOKAN              |  | FIN - FINLAND |

# KUMITE, TYTÖT, U14, +52 KG

Tawastia Open Karate 2/2024

**ENTRIES BY WEIGHT CATEGORY**  
**Kumite, tytt, U14, +52 kg**

As of 6 OCT 2024

| Country Code | ID | Gender | Name                | Seeding |
|--------------|----|--------|---------------------|---------|
| FIN          |    | F      | Coman Anastasia     |         |
| FIN          |    | F      | Hameeda Ahmed Aisha |         |
| FIN          |    | F      | Kontio Venla        |         |
| FIN          |    | F      | Pohjalainen Aura    |         |



# Kumite, tytöt, U14, +52 kg - Round Robin (each against each)

Tawastia Open Karate 2/2024, Liivuoentie 24, Hämeenlinna, FIN



















2024-10-05

Tatami

3 12:10

Pool

1/1

|    |  |   |  |
|----|--|---|--|
| 1  |  Kontio Venla (Erä,FIN)                      | 3 |  Kontio Venla (Erä,FIN)                   |
| 2  |  Hameeda Ahmed Aisha (Karate Hervanta,FIN)   | 0 |  |
| 3  |  Pohjalainen Aura (Imatran Kusanku,FIN)      | 1 |  Pohjalainen Aura (Imatran Kusanku,FIN)   |
| 4  |  Coman Anastasia (JKA-Tampere,FIN)           | 1 |  |
| 5  |  Kontio Venla (Erä,FIN)                      | 1 |  Kontio Venla (Erä,FIN)                   |
| 6  |  Pohjalainen Aura (Imatran Kusanku,FIN)      | 0 |  |
| 7  |  Coman Anastasia (JKA-Tampere,FIN)           | 0 |  Coman Anastasia (JKA-Tampere,FIN)        |
| 8  |  Hameeda Ahmed Aisha (Karate Hervanta,FIN)   | 0 |  |
| 9  |  Kontio Venla (Erä,FIN)                    | 1 |  Kontio Venla (Erä,FIN)                 |
| 10 |  Coman Anastasia (JKA-Tampere,FIN)         | 0 |  |
| 11 |  Hameeda Ahmed Aisha (Karate Hervanta,FIN) | 0 |  Pohjalainen Aura (Imatran Kusanku,FIN) |
| 12 |  Pohjalainen Aura (Imatran Kusanku,FIN)    | 1 |  |



|  |
|--|
| 1. KONTIO VENLA (ERÄ,FIN)                    |
| 2. POHJALAINEN AURA (IMATRAN KUSANKU,FIN)    |
| 3. COMAN ANASTASIA (JKA-TAMPERE,FIN)         |
| 4. HAMEEDA AHMED AISHA (KARATE HERVANTA,FIN) |
|  |
|  |
|  |

|           |  |  |  |
|-----------|--|--|--|
| Referees: |  |  |  |
|           |  |  |  |

# Tawastia Open Karate 2/2024

Liivuoentie 24, Hmeenlinna, FINLAND

|             |                           |         |            |             |   |                |       |
|-------------|---------------------------|---------|------------|-------------|---|----------------|-------|
| Court Nr.   | 1                         | Pool    | 1          | Date        | 2024-10-06                                | Field Position | -9951 |
| <b>RED</b>  |                           |         |            | <b>BLUE</b> |   |                |       |
| NOC         | KONTIO VENLA (ER,FIN)     |         |            | NOC         | HAMEEDA AHMED AISHA (KARATE HERVANTA,FIN) |                |       |
| Category    | Kumite, tytt, U14, +52 kg |         |            |             |   |                |       |
| 3 Points    | 2 Points                  | 1 Point | Score      | 1 Point     | 2 Points                                  | 3 Points       |       |
|             |                           |         | 3 : 0      |             |   |                |       |
| Penatlity   |                           |         |            | Penatlity   |   |                |       |
| C1: C1, C2: |                           |         | <b>3:0</b> | C1: , C2:   |   |                |       |
| WINNER      |                           |         | Total      |             |   |                |       |

PTS

## Decision of Superiority

| Judge 1 | Judge 2 | Judge 3 | Judge 4 | Judge 5 | Judge 6 | Judge 7 | Referee |
|---------|---------|---------|---------|---------|---------|---------|---------|
|         |         |         |         |         |         |         |         |

Name

Signature

\_\_\_\_\_  
\_\_\_\_\_



# Tawastia Open Karate 2/2024

Liivuoentie 24, Hmeenlinna, FINLAND

|             |  |         |            |             |                                   |                |       |
|-------------|--|---------|------------|-------------|-----------------------------------|----------------|-------|
| Court Nr.   | 1                                      | Pool    | 1          | Date        | 2024-10-06                        | Field Position | -9950 |
| <b>RED</b>  |  |         |            | <b>BLUE</b> |                                   |                |       |
| NOC         | POHJALAINEN AURA (IMATRAN KUSANKU,FIN) |         |            | NOC         | COMAN ANASTASIA (JKA-TAMPERE,FIN) |                |       |
| Category    | Kumite, tytt, U14, +52 kg              |         |            |             |                                   |                |       |
| 3 Points    | 2 Points                               | 1 Point | Score      | 1 Point     | 2 Points                          | 3 Points       |       |
|             |  |         | 1 : 1      |             |                                   |                |       |
| Penatlity   |  |         |            | Penatlity   |                                   |                |       |
| C1: C2, C2: |  |         | <b>1:1</b> | C1: , C2:   |                                   |                |       |
| WINNER      |  |         | Total      |             |                                   |                |       |

SEN

## Decision of Superiority

| Judge 1 | Judge 2 | Judge 3 | Judge 4 | Judge 5 | Judge 6 | Judge 7 | Referee |
|---------|---------|---------|---------|---------|---------|---------|---------|
|         |         |         |         |         |         |         |         |

Name

Signature

\_\_\_\_\_  
\_\_\_\_\_



# Tawastia Open Karate 2/2024

Liivuoentie 24, Hmeenlinna, FINLAND

|             |                           |         |            |             |  |                |       |
|-------------|---------------------------|---------|------------|-------------|--|----------------|-------|
| Court Nr.   | 1                         | Pool    | 1          | Date        | 2024-10-06                             | Field Position | -9949 |
| <b>RED</b>  |                           |         |            | <b>BLUE</b> |  |                |       |
| NOC         | KONTIO VENLA (ER,FIN)     |         |            | NOC         | POHJALAINEN AURA (IMATRAN KUSANKU,FIN) |                |       |
| Category    | Kumite, tytt, U14, +52 kg |         |            |             |  |                |       |
| 3 Points    | 2 Points                  | 1 Point | Score      | 1 Point     | 2 Points                               | 3 Points       |       |
|             |                           |         | 1 : 0      |             |  |                |       |
| Penatlity   |                           |         |            | Penatlity   |  |                |       |
| C1: C2, C2: |                           |         | <b>1:0</b> | C1: , C2:   |  |                |       |
| WINNER      |                           |         | Total      |             |  |                |       |

PTS

## Decision of Superiority

| Judge 1 | Judge 2 | Judge 3 | Judge 4 | Judge 5 | Judge 6 | Judge 7 | Referee |
|---------|---------|---------|---------|---------|---------|---------|---------|
|         |         |         |         |         |         |         |         |

Name

Signature

\_\_\_\_\_  
\_\_\_\_\_



# Tawastia Open Karate 2/2024

Liivuoventie 24, Hmeenlinna, FINLAND

|           |                                      |         |       |             |  |                |       |
|-----------|--------------------------------------|---------|-------|-------------|--|----------------|-------|
| Court Nr. | 1                                    | Pool    | 1     | Date        | 2024-10-06                                   | Field Position | -9948 |
| RED       |                                      |         |       | BLUE        |  |                |       |
| NOC       | COMAN ANASTASIA<br>(JKA-TAMPERE,FIN) |         |       | NOC         | HAMEEDA AHMED AISHA (KARATE<br>HERVANTA,FIN) |                |       |
| Category  | Kumite, tytt, U14, +52 kg            |         |       |             |  |                |       |
| 3 Points  | 2 Points                             | 1 Point | Score | 1 Point     | 2 Points                                     | 3 Points       |       |
|           |                                      |         | 0 : 0 |             |  |                |       |
| Penatlity |                                      |         |       | Penatlity   |  |                |       |
| C1: , C2: |                                      |         | 0:0   | C1: C1, C2: |  |                |       |
| WINNER    |                                      |         | Total |             |  |                |       |

HT

## Decision of Superiority

| Judge 1 | Judge 2 | Judge 3 | Judge 4 | Judge 5 | Judge 6 | Judge 7 | Referee |
|---------|---------|---------|---------|---------|---------|---------|---------|
|         |         |         |         |         |         |         |         |

Name \_\_\_\_\_

Signature \_\_\_\_\_



# Tawastia Open Karate 2/2024

Liivuoentie 24, Hmeenlinna, FINLAND

|            |                           |         |            |             |                                   |                |       |
|------------|---------------------------|---------|------------|-------------|-----------------------------------|----------------|-------|
| Court Nr.  | 1                         | Pool    | 1          | Date        | 2024-10-06                        | Field Position | -9947 |
| <b>RED</b> |                           |         |            | <b>BLUE</b> |                                   |                |       |
| NOC        | KONTIO VENLA (ER,FIN)     |         |            | NOC         | COMAN ANASTASIA (JKA-TAMPERE,FIN) |                |       |
| Category   | Kumite, tytt, U14, +52 kg |         |            |             |                                   |                |       |
| 3 Points   | 2 Points                  | 1 Point | Score      | 1 Point     | 2 Points                          | 3 Points       |       |
|            |                           |         | 1 : 0      |             |                                   |                |       |
| Penatlity  |                           |         |            | Penatlity   |                                   |                |       |
| C1: , C2:  |                           |         | <b>1:0</b> | C1: , C2:   |                                   |                |       |
| WINNER     |                           |         | Total      |             |                                   |                |       |

PTS

## Decision of Superiority

| Judge 1 | Judge 2 | Judge 3 | Judge 4 | Judge 5 | Judge 6 | Judge 7 | Referee |
|---------|---------|---------|---------|---------|---------|---------|---------|
|         |         |         |         |         |         |         |         |

Name

Signature

\_\_\_\_\_

\_\_\_\_\_



# Tawastia Open Karate 2/2024

Liivuoentie 24, Hmeenlinna, FINLAND

|             |   |         |            |             |  |                |       |
|-------------|---|---------|------------|-------------|--|----------------|-------|
| Court Nr.   | 1   | Pool    | 1          | Date        | 2024-10-06                             | Field Position | -9946 |
| <b>RED</b>  |   |         |            | <b>BLUE</b> |  |                |       |
| NOC         | HAMEEDA AHMED AISHA (KARATE HERVANTA,FIN) |         |            | NOC         | POHJALAINEN AURA (IMATRAN KUSANKU,FIN) |                |       |
| Category    | Kumite, tytt, U14, +52 kg                 |         |            |             |  |                |       |
| 3 Points    | 2 Points                                  | 1 Point | Score      | 1 Point     | 2 Points                               | 3 Points       |       |
|             |   |         | 0 : 1      |             |  |                |       |
| Penatlity   |   |         |            | Penatlity   |  |                |       |
| C1: C3, C2: |   |         | <b>0:1</b> | C1: C2, C2: |  |                |       |
|             |   |         | Total      | WINNER      |  |                |       |

PTS

## Decision of Superiority

|         |         |         |         |         |         |         |         |
|---------|---------|---------|---------|---------|---------|---------|---------|
| Judge 1 | Judge 2 | Judge 3 | Judge 4 | Judge 5 | Judge 6 | Judge 7 | Referee |
|         |         |         |         |         |         |         |         |

Name





Signature

\_\_\_\_\_  
\_\_\_\_\_



## Tawastia Open Karate 2/2024 - 2024-10-05

## Official Results

| Kumite, tytöt, U14, +52 kg |                     |   |   |               |
|----------------------------|---------------------|---|---|---------------|
| 1                          | KONTIO VENLA        | TAPANILAN ERÄ                             |  | FIN - FINLAND |
| 2                          | POHJALAINEN AURA    | BUDOSEURA<br>IMATRAN KUSANKU<br>RY        |  | FIN - FINLAND |
| 3                          | COMAN ANASTASIA     | JAPAN KARATE<br>ASSOCIATION<br>TAMPERE RY |  | FIN - FINLAND |
| 4                          | HAMEEDA AHMED AISHA | SHOTOKAN<br>HERVANTA RY                   |  | FIN - FINLAND |



# KUMITE, TYTÖT, U14, -42 KG

Tawastia Open Karate 2/2024

**ENTRIES BY WEIGHT CATEGORY**  
**Kumite, tytt, U14, -42 kg**

As of 6 OCT 2024

| Country Code | ID | Gender | Name             | Seeding |
|--------------|----|--------|------------------|---------|
| FIN          |    | F      | Anttila Isabella |         |
| FIN          |    | F      | Riimala Seela    |         |

# Kumite, tytöt, U14, -42 kg

Tawastia Open Karate 2/2024, Liivuoventie 24, Hämeenlinna, FIN

2024-10-05

Tatami  
3 11:20

Pool  
1/1

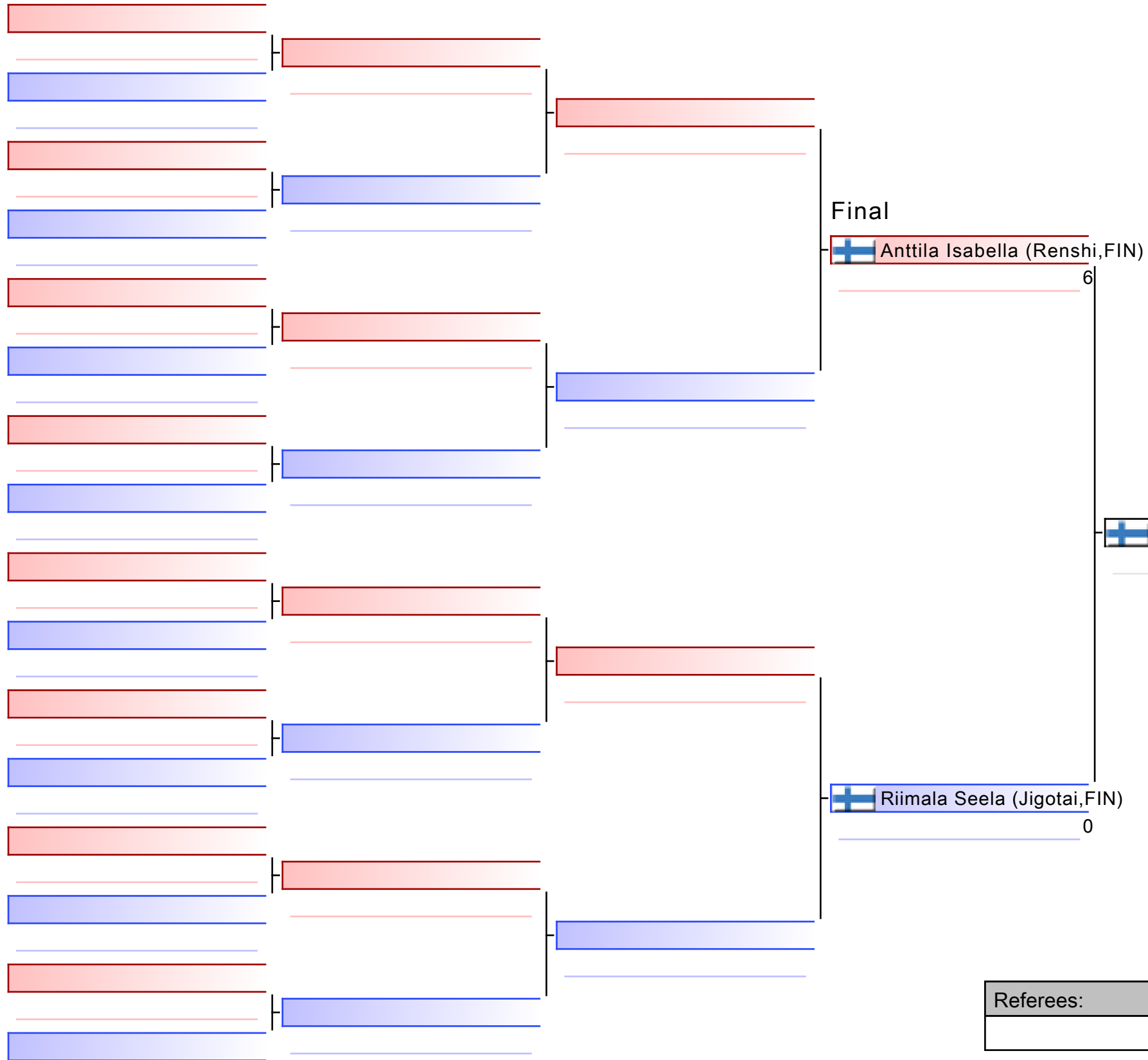

Anttila Isabella (Renshi, FIN)

|                                 |
|---------------------------------|
| 1. ANTILA ISABELLA (RENSHI,FIN) |
| 2. RIIMALA SEELA (JIGOTAI,FIN)  |
|                                 |
|                                 |
|                                 |
|                                 |
|                                 |

|           |  |  |  |
|-----------|--|--|--|
| Referees: |  |  |  |
|           |  |  |  |

# Tawastia Open Karate 2/2024

Liivuoventie 24, Hmeenlinna, FINLAND

|             |                               |         |            |             |                             |                |    |
|-------------|-------------------------------|---------|------------|-------------|-----------------------------|----------------|----|
| Court Nr.   | 1                             | Pool    | 1          | Date        | 2024-10-06                  | Field Position | 63 |
| <b>RED</b>  |                               |         |            | <b>BLUE</b> |                             |                |    |
| NOC         | ANTTILA ISABELLA (RENSHI,FIN) |         |            | NOC         | RIIMALA SEELA (JIGOTAI,FIN) |                |    |
| Category    | Kumite, tytt, U14, -42 kg     |         |            |             |                             |                |    |
| 3 Points    | 2 Points                      | 1 Point | Score      | 1 Point     | 2 Points                    | 3 Points       |    |
|             |                               |         | 6 : 0      |             |                             |                |    |
| Penatlity   |                               |         |            | Penatlity   |                             |                |    |
| C1: C1, C2: |                               |         | <b>6:0</b> | C1: , C2:   |                             |                |    |
| WINNER      |                               |         | Total      |             |                             |                |    |

PTS

## Decision of Superiority

| Judge 1 | Judge 2 | Judge 3 | Judge 4 | Judge 5 | Judge 6 | Judge 7 | Referee |
|---------|---------|---------|---------|---------|---------|---------|---------|
|         |         |         |         |         |         |         |         |

Name



Signature

\_\_\_\_\_  
\_\_\_\_\_



Tawastia Open Karate 2/2024 - 2024-10-05

Official Results

| Kumite, tytöt, U14, -42 kg |                  |                |   |               |
|----------------------------|------------------|----------------|---|---------------|
| 1                          | ANTTILA ISABELLA | RENSHIN-KAN RY |  | FIN - FINLAND |
| 2                          | RIIMALA SEELA    | JIGOTAI KARATE |  | FIN - FINLAND |

# KUMITE, TYTÖT, U14, -47 KG

Tawastia Open Karate 2/2024

**ENTRIES BY WEIGHT CATEGORY**  
**Kumite, tytt, U14, -47 kg**

As of 6 OCT 2024

| Country Code | ID | Gender | Name            | Seeding |
|--------------|----|--------|-----------------|---------|
| FIN          |    | F      | Antinkaapo Nea  |         |
| FIN          |    | F      | Heino Daisy     |         |
| FIN          |    | F      | Hyvnen Lila     |         |
| FIN          |    | F      | Keskinen Emilia |         |
| FIN          |    | F      | Pyhnen Iida     |         |
| FIN          |    | F      | Sember Vivi     |         |

# Kumite, tytöt, U14, -47 kg

Tawastia Open Karate 2/2024, Liivourentie 24, Hämeenlinna, FIN

2024-10-05

Tatami  
3 11:40

Pool  
1/1

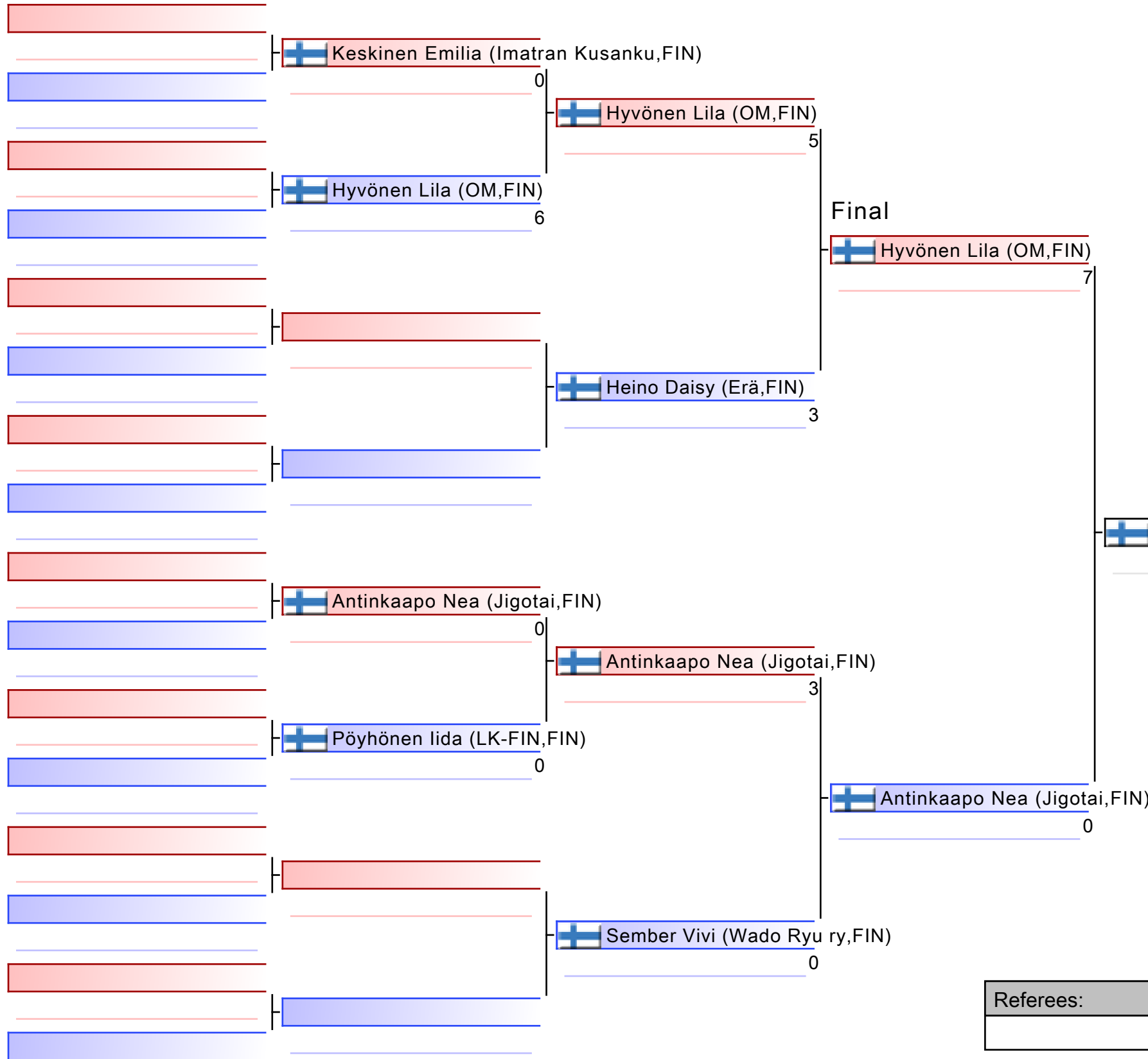

|  |
|--|
| 1. HYVÖNEN LILA (OM,FIN)                 |
| 2. ANTINKAAPO NEA (JIGOTAI,FIN)          |
| 3. HEINO DAISY (ERÄ,FIN)                 |
| 4. PÖYHÖNEN IIDA (LK-FIN,FIN)            |
| 5. KESKINEN EMILIA (IMATRAN KUSANKU,FIN) |
| 5. SEMBER VIVI (WADO RYU RY,FIN)         |
|  |
|  |

|           |  |  |  |
|-----------|--|--|--|
| Referees: |  |  |  |
|           |  |  |  |



# Kumite, tytöt, U14, -47 kg

Tawastia Open Karate 2/2024

2024-10-05

Tatami  
3 11:40

Pool  
1

(c)sportdata GmbH & Co KG 2000-2024 (2024-10-06 10:03) v 10.2.0 build 1 (2024-09-26 10:14 CET) License: Online\_Event\_ID-8546\_TawastiaOpenKarate22024 (expire 2024-10-20)

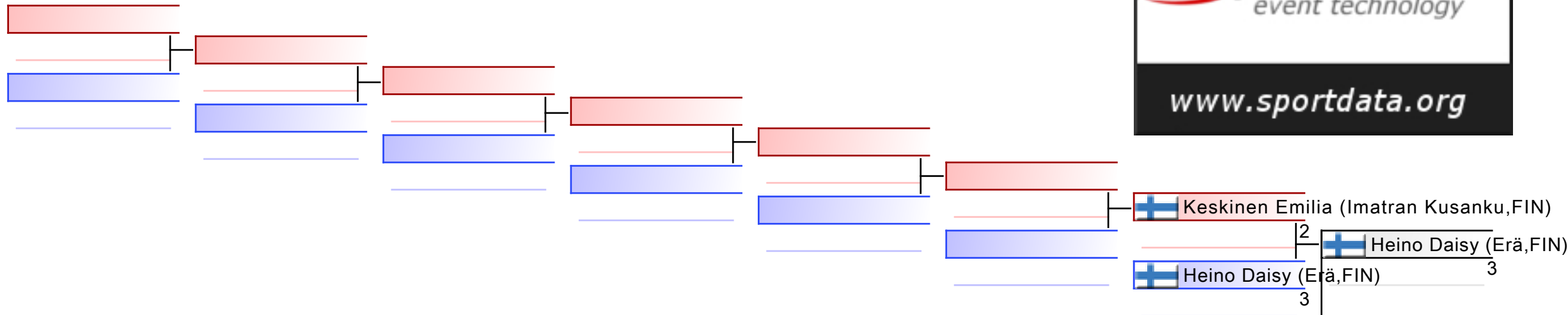

## REPECHAGE: (1)

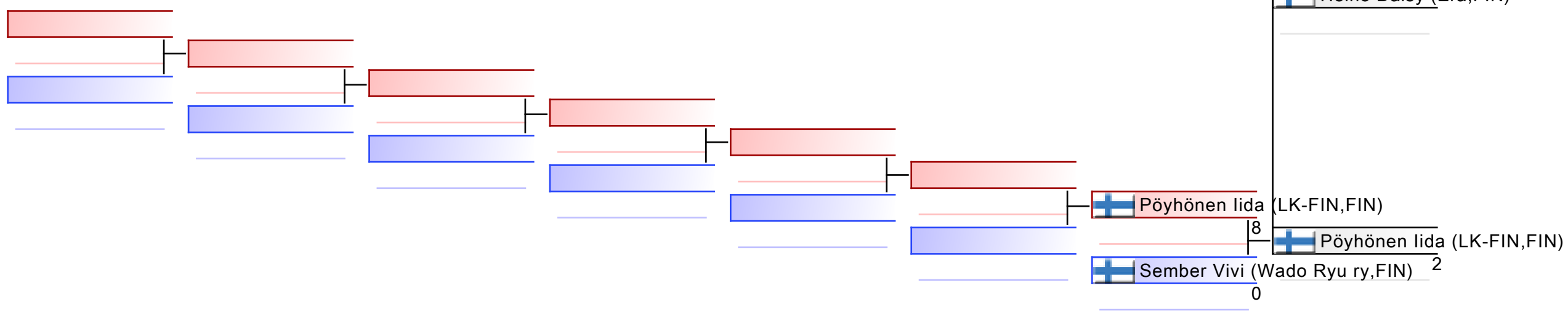

|           |  |  |  |  |  |  |  |
|-----------|--|--|--|--|--|--|--|
| Referees: |  |  |  |  |  |  |  |
|-----------|--|--|--|--|--|--|--|

# Tawastia Open Karate 2/2024

Liivuoentie 24, Hmeenlinna, FINLAND

|            |                                       |         |            |             |                      |                |    |
|------------|---------------------------------------|---------|------------|-------------|----------------------|----------------|----|
| Court Nr.  | 1                                     | Pool    | 1          | Date        | 2024-10-06           | Field Position | 57 |
| <b>RED</b> |                                       |         |            | <b>BLUE</b> |                      |                |    |
| NOC        | KESKINEN EMILIA (IMATRAN KUSANKU,FIN) |         |            | NOC         | HYVNEN LILA (OM,FIN) |                |    |
| Category   | Kumite, tytt, U14, -47 kg             |         |            |             |                      |                |    |
| 3 Points   | 2 Points                              | 1 Point | Score      | 1 Point     | 2 Points             | 3 Points       |    |
|            |                                       |         | 0 : 6      |             |                      |                |    |
| Penatlity  |                                       |         |            | Penatlity   |                      |                |    |
| C1: , C2:  |                                       |         | <b>0:6</b> | C1: , C2:   |                      |                |    |
|            |                                       |         | Total      | WINNER      |                      |                |    |

PTS

## Decision of Superiority

| Judge 1 | Judge 2 | Judge 3 | Judge 4 | Judge 5 | Judge 6 | Judge 7 | Referee |
|---------|---------|---------|---------|---------|---------|---------|---------|
|         |         |         |         |         |         |         |         |

Name

Signature

\_\_\_\_\_  
\_\_\_\_\_



# Tawastia Open Karate 2/2024

Liivuoentie 24, Hmeenlinna, FINLAND

|            |                              |         |            |             |                          |                |    |
|------------|------------------------------|---------|------------|-------------|--------------------------|----------------|----|
| Court Nr.  | 1                            | Pool    | 1          | Date        | 2024-10-06               | Field Position | 59 |
| <b>RED</b> |                              |         |            | <b>BLUE</b> |                          |                |    |
| NOC        | ANTINKAAPO NEA (JIGOTAI,FIN) |         |            | NOC         | PYHNEN IIDA (LK-FIN,FIN) |                |    |
| Category   | Kumite, tytt, U14, -47 kg    |         |            |             |                          |                |    |
| 3 Points   | 2 Points                     | 1 Point | Score      | 1 Point     | 2 Points                 | 3 Points       |    |
|            |                              |         | 0 : 0      |             |                          |                |    |
| Penatlity  |                              |         |            | Penatlity   |                          |                |    |
| C1: , C2:  |                              |         | <b>0:0</b> | C1: , C2:   |                          |                |    |
| WINNER     |                              |         | Total      |             |                          |                |    |

HT

## Decision of Superiority

| Judge 1 | Judge 2 | Judge 3 | Judge 4 | Judge 5 | Judge 6 | Judge 7 | Referee |
|---------|---------|---------|---------|---------|---------|---------|---------|
|         |         |         |         |         |         |         |         |

Name

Signature

\_\_\_\_\_  
\_\_\_\_\_



# Tawastia Open Karate 2/2024

Liivuoentie 24, Hmeenlinna, FINLAND

|             |                           |         |            |             |                      |                |    |
|-------------|---------------------------|---------|------------|-------------|----------------------|----------------|----|
| Court Nr.   | 1                         | Pool    | 1          | Date        | 2024-10-06           | Field Position | 61 |
| <b>RED</b>  |                           |         |            | <b>BLUE</b> |                      |                |    |
| NOC         | HYVNEN LILA (OM,FIN)      |         |            | NOC         | HEINO DAISY (ER,FIN) |                |    |
| Category    | Kumite, tytt, U14, -47 kg |         |            |             |                      |                |    |
| 3 Points    | 2 Points                  | 1 Point | Score      | 1 Point     | 2 Points             | 3 Points       |    |
|             |                           |         | 5 : 3      |             |                      |                |    |
| Penatlity   |                           |         |            | Penatlity   |                      |                |    |
| C1: C2, C2: |                           |         | <b>5:3</b> | C1: , C2:   |                      |                |    |
| WINNER      |                           |         | Total      |             |                      |                |    |

PTS

## Decision of Superiority

| Judge 1 | Judge 2 | Judge 3 | Judge 4 | Judge 5 | Judge 6 | Judge 7 | Referee |
|---------|---------|---------|---------|---------|---------|---------|---------|
|         |         |         |         |         |         |         |         |

Name \_\_\_\_\_

Signature \_\_\_\_\_



# Tawastia Open Karate 2/2024

Liivuoentie 24, Hmeenlinna, FINLAND

|             |                              |         |            |             |                               |                |    |
|-------------|------------------------------|---------|------------|-------------|-------------------------------|----------------|----|
| Court Nr.   | 1                            | Pool    | 1          | Date        | 2024-10-06                    | Field Position | 62 |
| <b>RED</b>  |                              |         |            | <b>BLUE</b> |                               |                |    |
| NOC         | ANTINKAAPO NEA (JIGOTAI,FIN) |         |            | NOC         | SEMBER VIVI (WADO RYU RY,FIN) |                |    |
| Category    | Kumite, tytt, U14, -47 kg    |         |            |             |                               |                |    |
| 3 Points    | 2 Points                     | 1 Point | Score      | 1 Point     | 2 Points                      | 3 Points       |    |
|             |                              |         | 3 : 0      |             |                               |                |    |
| Penatlity   |                              |         |            | Penatlity   |                               |                |    |
| C1: C2, C2: |                              |         | <b>3:0</b> | C1: C1, C2: |                               |                |    |
| WINNER      |                              |         | Total      |             |                               |                |    |

PTS

## Decision of Superiority

| Judge 1 | Judge 2 | Judge 3 | Judge 4 | Judge 5 | Judge 6 | Judge 7 | Referee |
|---------|---------|---------|---------|---------|---------|---------|---------|
|         |         |         |         |         |         |         |         |

Name \_\_\_\_\_

Signature \_\_\_\_\_



# Tawastia Open Karate 2/2024

Liivuoentie 24, Hmeenlinna, FINLAND

|            |                           |         |            |             |                              |                |    |
|------------|---------------------------|---------|------------|-------------|------------------------------|----------------|----|
| Court Nr.  | 1                         | Pool    | 1          | Date        | 2024-10-06                   | Field Position | 63 |
| <b>RED</b> |                           |         |            | <b>BLUE</b> |                              |                |    |
| NOC        | HYVNEN LILA (OM,FIN)      |         |            | NOC         | ANTINKAAPO NEA (JIGOTAI,FIN) |                |    |
| Category   | Kumite, tytt, U14, -47 kg |         |            |             |                              |                |    |
| 3 Points   | 2 Points                  | 1 Point | Score      | 1 Point     | 2 Points                     | 3 Points       |    |
|            |                           |         | 7 : 0      |             |                              |                |    |
| Penatlity  |                           |         |            | Penatlity   |                              |                |    |
| C1: , C2:  |                           |         | <b>7:0</b> | C1: , C2:   |                              |                |    |
| WINNER     |                           |         | Total      |             |                              |                |    |

PTS

## Decision of Superiority

| Judge 1 | Judge 2 | Judge 3 | Judge 4 | Judge 5 | Judge 6 | Judge 7 | Referee |
|---------|---------|---------|---------|---------|---------|---------|---------|
|         |         |         |         |         |         |         |         |

Name

Signature

\_\_\_\_\_  
\_\_\_\_\_



# Tawastia Open Karate 2/2024

Liivuoentie 24, Hmeenlinna, FINLAND

|            |                                       |         |       |             |                      |                |   |
|------------|---------------------------------------|---------|-------|-------------|----------------------|----------------|---|
| Court Nr.  | 1                                     | Pool    | 1     | Date        | 2024-10-06           | Field Position | 0 |
| <b>RED</b> |                                       |         |       | <b>BLUE</b> |                      |                |   |
| NOC        | KESKINEN EMILIA (IMATRAN KUSANKU,FIN) |         |       | NOC         | HEINO DAISY (ER,FIN) |                |   |
| Category   | Kumite, tytt, U14, -47 kg             |         |       |             |                      |                |   |
| 3 Points   | 2 Points                              | 1 Point | Score | 1 Point     | 2 Points             | 3 Points       |   |
|            |                                       |         | :     |             |                      |                |   |
| Penatlity  |                                       |         |       | Penatlity   |                      |                |   |
|            |                                       |         |       |             |                      |                |   |
|            |                                       |         | Total |             |                      |                |   |

## Decision of Superiority

| Judge 1 | Judge 2 | Judge 3 | Judge 4 | Judge 5 | Judge 6 | Judge 7 | Referee |
|---------|---------|---------|---------|---------|---------|---------|---------|
|         |         |         |         |         |         |         |         |

Name \_\_\_\_\_

Signature \_\_\_\_\_



# Tawastia Open Karate 2/2024

Liivuoentie 24, Hmeenlinna, FINLAND

|            |                           |         |            |             |                               |                |   |
|------------|---------------------------|---------|------------|-------------|-------------------------------|----------------|---|
| Court Nr.  | 2                         | Pool    | 2          | Date        | 2024-10-06                    | Field Position | 0 |
| <b>RED</b> |                           |         |            | <b>BLUE</b> |                               |                |   |
| NOC        | PYHNEN IIDA (LK-FIN,FIN)  |         |            | NOC         | SEMBER VIVI (WADO RYU RY,FIN) |                |   |
| Category   | Kumite, tytt, U14, -47 kg |         |            |             |                               |                |   |
| 3 Points   | 2 Points                  | 1 Point | Score      | 1 Point     | 2 Points                      | 3 Points       |   |
|            |                           |         | 8 : 0      |             |                               |                |   |
| Penatlity  |                           |         |            | Penatlity   |                               |                |   |
| C1: , C2:  |                           |         | <b>8:0</b> | C1: , C2:   |                               |                |   |
| WINNER     |                           |         | Total      |             |                               |                |   |

PTS

## Decision of Superiority

| Judge 1 | Judge 2 | Judge 3 | Judge 4 | Judge 5 | Judge 6 | Judge 7 | Referee |
|---------|---------|---------|---------|---------|---------|---------|---------|
|         |         |         |         |         |         |         |         |

Name

Signature







\_\_\_\_\_  
\_\_\_\_\_





## Tawastia Open Karate 2/2024 - 2024-10-05

## Official Results

| Kumite, tytöt, U14, -47 kg |                 |                                     |   |               |  |
|----------------------------|-----------------|-------------------------------------|---|---------------|--|
| 1                          | HYVÖNEN LILA    | SPORTSKARATE<br>KUOPIO              |  | FIN - FINLAND |  |
| 2                          | ANTINKAAPO NEA  | JIGOTAI KARATE                      |  | FIN - FINLAND |  |
| 3                          | HEINO DAISY     | TAPANILAN ERÄ                       |  | FIN - FINLAND |  |
| 4                          | PÖYHÖNEN IIDA   | LAHDEN KARATE                       |  | FIN - FINLAND |  |
| 5                          | KESKINEN EMILIA | BUDOSEURA<br>IMATTRAN KUSANKU<br>RY |  | FIN - FINLAND |  |
| 5                          | SEMBER VIVI     | VANTAAN WADO RYU<br>RY              |  | FIN - FINLAND |  |

# KUMITE, TYTÖT, U14, -52 KG

Tawastia Open Karate 2/2024

**ENTRIES BY WEIGHT CATEGORY**  
**Kumite, tytt, U14, -52 kg**

As of 6 OCT 2024

| Country Code | ID | Gender | Name              | Seeding |
|--------------|----|--------|-------------------|---------|
| FIN          |    | F      | Leisti Charuphat  |         |
| FIN          |    | F      | Niemi Tova        |         |
| FIN          |    | F      | Stefanski Vanessa |         |

# Kumite, tytöt, U14, -52 kg - Round Robin (each against each)

Tawastia Open Karate 2/2024, Liivuorentie 24, Hämeenlinna, FIN









2024-10-05

Tatami

3 12:00

Pool

1/1

- 1  Leisti Charuphat (Ktbc,FIN)
  - 2  Stefanski Vanessa (LK-FIN,FIN)
- 2  Stefanski Vanessa (LK-FIN,FIN)
  - 5
- 3  Leisti Charuphat (Ktbc,FIN)
  - 6  Leisti Charuphat (Ktbc,FIN)
- 4  Niemi Tova (Erä,FIN)
  - 2
- 5  Stefanski Vanessa (LK-FIN,FIN)
  - 2  Stefanski Vanessa (LK-FIN,FIN)
- 6  Niemi Tova (Erä,FIN)
  - 2



|                                   |
|-----------------------------------|
| 1. STEFANSKI VANESSA (LK-FIN,FIN) |
| 2. LEISTI CHARUPHAT (KTBC,FIN)    |
| 3. NIEMI TOVA (ERÄ,FIN)           |
|                                   |
|                                   |
|                                   |
|                                   |

|           |  |  |  |
|-----------|--|--|--|
| Referees: |  |  |  |
|           |  |  |  |

# Tawastia Open Karate 2/2024

Liivuoentie 24, Hmeenlinna, FINLAND

|            |                             |         |            |             |                                |                |       |
|------------|-----------------------------|---------|------------|-------------|--------------------------------|----------------|-------|
| Court Nr.  | 1                           | Pool    | 1          | Date        | 2024-10-06                     | Field Position | -9951 |
| <b>RED</b> |                             |         |            | <b>BLUE</b> |                                |                |       |
| NOC        | LEISTI CHARUPHAT (KTBC,FIN) |         |            | NOC         | STEFANSKI VANESSA (LK-FIN,FIN) |                |       |
| Category   | Kumite, tytt, U14, -52 kg   |         |            |             |                                |                |       |
| 3 Points   | 2 Points                    | 1 Point | Score      | 1 Point     | 2 Points                       | 3 Points       |       |
|            |                             |         | 2 : 5      |             |                                |                |       |
| Penatlity  |                             |         |            | Penatlity   |                                |                |       |
| C1: , C2:  |                             |         | <b>2:5</b> | C1: , C2:   |                                |                |       |
|            |                             |         | Total      | WINNER      |                                |                |       |

PTS

## Decision of Superiority

| Judge 1 | Judge 2 | Judge 3 | Judge 4 | Judge 5 | Judge 6 | Judge 7 | Referee |
|---------|---------|---------|---------|---------|---------|---------|---------|
|         |         |         |         |         |         |         |         |

Name

Signature

\_\_\_\_\_  
\_\_\_\_\_



# Tawastia Open Karate 2/2024

Liivuoentie 24, Hmeenlinna, FINLAND

|             |                             |         |            |             |                     |                |       |
|-------------|-----------------------------|---------|------------|-------------|---------------------|----------------|-------|
| Court Nr.   | 1                           | Pool    | 1          | Date        | 2024-10-06          | Field Position | -9950 |
| <b>RED</b>  |                             |         |            | <b>BLUE</b> |                     |                |       |
| NOC         | LEISTI CHARUPHAT (KTBC,FIN) |         |            | NOC         | NIEMI TOVA (ER,FIN) |                |       |
| Category    | Kumite, tytt, U14, -52 kg   |         |            |             |                     |                |       |
| 3 Points    | 2 Points                    | 1 Point | Score      | 1 Point     | 2 Points            | 3 Points       |       |
|             |                             |         | 6 : 2      |             |                     |                |       |
| Penatlity   |                             |         |            | Penatlity   |                     |                |       |
| C1: C1, C2: |                             |         | <b>6:2</b> | C1: HC, C2: |                     |                |       |
| WINNER      |                             |         | Total      |             |                     |                |       |

PTS

## Decision of Superiority

| Judge 1 | Judge 2 | Judge 3 | Judge 4 | Judge 5 | Judge 6 | Judge 7 | Referee |
|---------|---------|---------|---------|---------|---------|---------|---------|
|         |         |         |         |         |         |         |         |

Name

Signature

\_\_\_\_\_  
\_\_\_\_\_



# Tawastia Open Karate 2/2024

Liivuoentie 24, Hmeenlinna, FINLAND

|            |                                |         |            |             |                     |                |       |
|------------|--------------------------------|---------|------------|-------------|---------------------|----------------|-------|
| Court Nr.  | 1                              | Pool    | 1          | Date        | 2024-10-06          | Field Position | -9949 |
| <b>RED</b> |                                |         |            | <b>BLUE</b> |                     |                |       |
| NOC        | STEFANSKI VANESSA (LK-FIN,FIN) |         |            | NOC         | NIEMI TOVA (ER,FIN) |                |       |
| Category   | Kumite, tytt, U14, -52 kg      |         |            |             |                     |                |       |
| 3 Points   | 2 Points                       | 1 Point | Score      | 1 Point     | 2 Points            | 3 Points       |       |
|            |                                |         | 2 : 2      |             |                     |                |       |
| Penatlity  |                                |         |            | Penatlity   |                     |                |       |
| C1: , C2:  |                                |         | <b>2:2</b> | C1: , C2:   |                     |                |       |
| WINNER     |                                |         | Total      |             |                     |                |       |

SEN

## Decision of Superiority

| Judge 1 | Judge 2 | Judge 3 | Judge 4 | Judge 5 | Judge 6 | Judge 7 | Referee |
|---------|---------|---------|---------|---------|---------|---------|---------|
|         |         |         |         |         |         |         |         |

Name



Signature

\_\_\_\_\_  
\_\_\_\_\_



## Tawastia Open Karate 2/2024 - 2024-10-05

## Official Results

| Kumite, tytöt, U14, -52 kg |                   |                       |   |               |
|----------------------------|-------------------|-----------------------|---|---------------|
| 1                          | STEFANSKI VANESSA | LAHDEN KARATE         |  | FIN - FINLAND |
| 2                          | LEISTI CHARUPHAT  | KOTKA THAIBOXING CLUB |  | FIN - FINLAND |
| 3                          | NIEMI TOVA        | TAPANILAN ERÄ         |  | FIN - FINLAND |



KUMITE, TYTÖT, U16, +54 KG  
YHDISTETTY

Tawastia Open Karate 2/2024

**ENTRIES BY WEIGHT CATEGORY**  
**Kumite, tytt, U16, +54 kg yhdistetty**

As of 6 OCT 2024

| Country Code | ID | Gender | Name           | Seeding |
|--------------|----|--------|----------------|---------|
| FIN          |    | F      | Bryssy Mae     |         |
| FIN          |    | F      | Jokinen Helmi  |         |
| FIN          |    | F      | Korpela Siiri  |         |
| FIN          |    | F      | Mertamo Amanda |         |
| FIN          |    | F      | Pelkonen Aune  |         |

# Kumite, tytöt, U16, +54 kg yhdistetty

Tawastia Open Karate 2/2024, Liivuoventie 24, Hämeenlinna, FIN

2024-10-05

Tatami  
2 16:45

Pool  
1/1

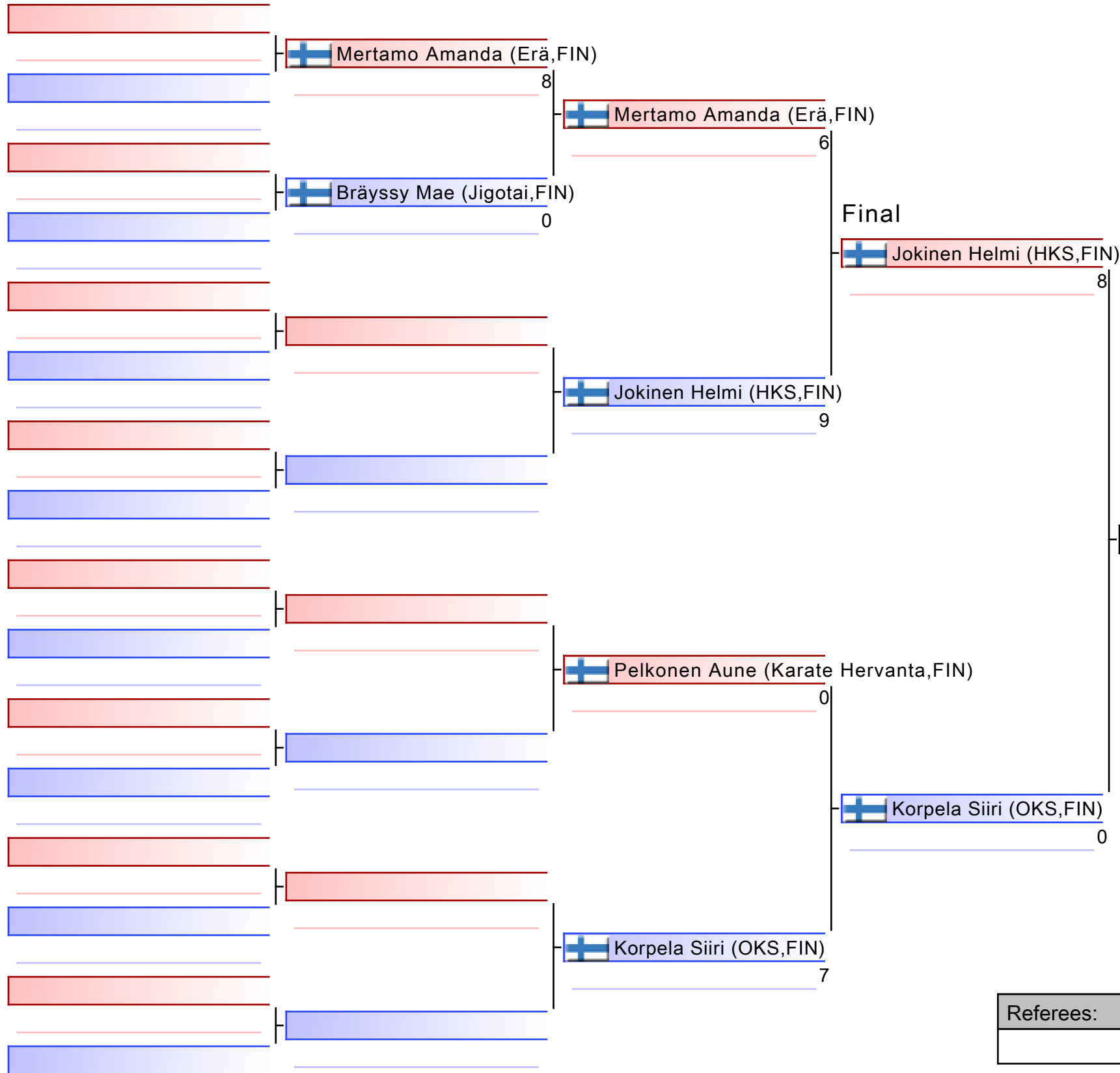

|  |
|--|
| 1. JOKINEN HELMI (HKS,FIN)             |
| 2. KORPELA SIIRI (OKS,FIN)             |
| 3. MERTAMO AMANDA (ERÄ,FIN)            |
| 4. PELKONEN AUNE (KARATE HERVANTA,FIN) |
|  |
|  |
|  |

|           |  |  |  |
|-----------|--|--|--|
| Referees: |  |  |  |
|           |  |  |  |

# Kumite, tytöt, U16, +54 kg yhdistetty

Tawastia Open Karate 2/2024

2024-10-05

Tatami  
2 16:45

Pool  
1

(c)sportdata GmbH & Co KG 2000-2024 (2024-10-06 10:03) v 10.2.0 build 1 (2024-09-26 10:14 CET) License: Online\_Event\_ID-8546\_TawastiaOpenKarate2024 (expire 2024-10-20)

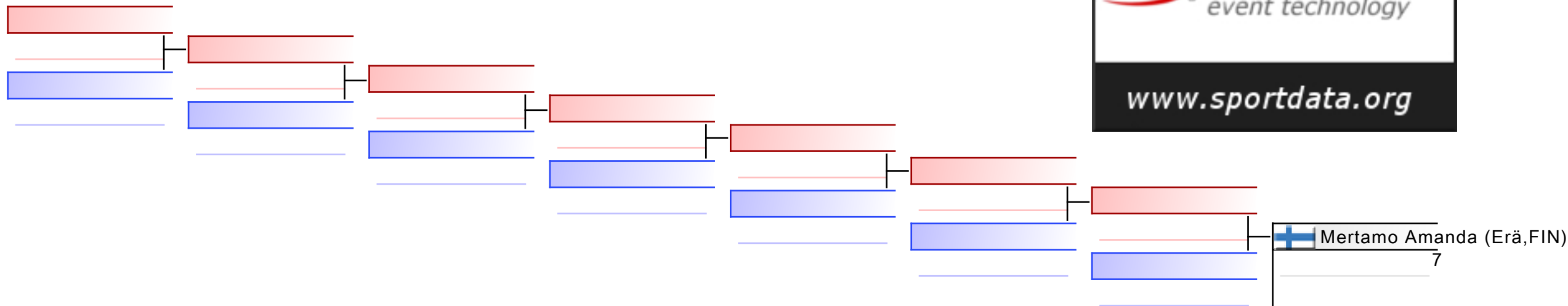

## REPECHAGE: (1)

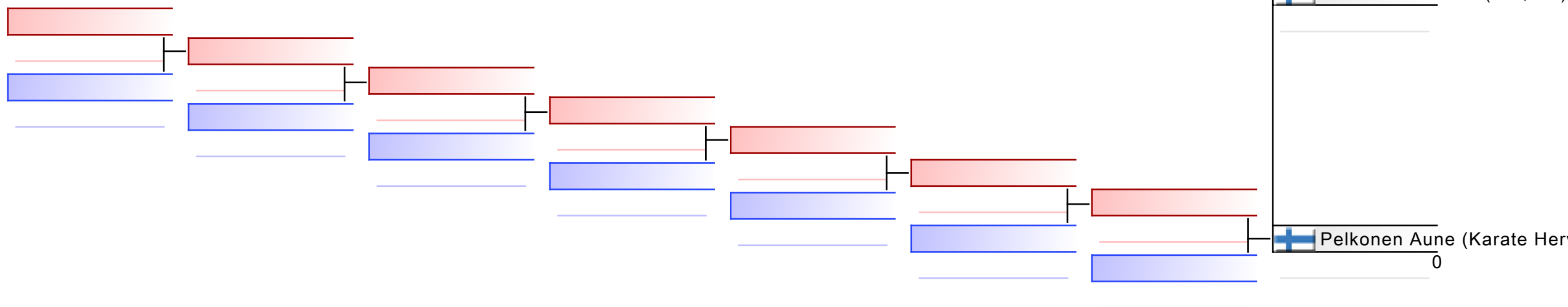

|           |  |  |  |  |  |  |  |
|-----------|--|--|--|--|--|--|--|
| Referees: |  |  |  |  |  |  |  |
|-----------|--|--|--|--|--|--|--|

# Tawastia Open Karate 2/2024

Liivuoentie 24, Hmeenlinna, FINLAND

|            |                                      |         |            |             |                          |                |    |
|------------|--------------------------------------|---------|------------|-------------|--------------------------|----------------|----|
| Court Nr.  | 1                                    | Pool    | 1          | Date        | 2024-10-06               | Field Position | 57 |
| <b>RED</b> |                                      |         |            | <b>BLUE</b> |                          |                |    |
| NOC        | MERTAMO AMANDA (ER,FIN)              |         |            | NOC         | BRYSSY MAE (JIGOTAI,FIN) |                |    |
| Category   | Kumite, tytt, U16, +54 kg yhdistetty |         |            |             |                          |                |    |
| 3 Points   | 2 Points                             | 1 Point | Score      | 1 Point     | 2 Points                 | 3 Points       |    |
|            |                                      |         | 8 : 0      |             |                          |                |    |
| Penatlity  |                                      |         |            | Penatlity   |                          |                |    |
| C1: , C2:  |                                      |         | <b>8:0</b> | C1: , C2:   |                          |                |    |
| WINNER     |                                      |         | Total      |             |                          |                |    |

PTS

## Decision of Superiority

| Judge 1 | Judge 2 | Judge 3 | Judge 4 | Judge 5 | Judge 6 | Judge 7 | Referee |
|---------|---------|---------|---------|---------|---------|---------|---------|
|         |         |         |         |         |         |         |         |

Name

Signature

\_\_\_\_\_  
\_\_\_\_\_



# Tawastia Open Karate 2/2024

Liivuoentie 24, Hmeenlinna, FINLAND

|            |                                      |         |            |             |                         |                |    |
|------------|--------------------------------------|---------|------------|-------------|-------------------------|----------------|----|
| Court Nr.  | 1                                    | Pool    | 1          | Date        | 2024-10-06              | Field Position | 61 |
| <b>RED</b> |                                      |         |            | <b>BLUE</b> |                         |                |    |
| NOC        | MERTAMO AMANDA (ER,FIN)              |         |            | NOC         | JOKINEN HELMI (HKS,FIN) |                |    |
| Category   | Kumite, tytt, U16, +54 kg yhdistetty |         |            |             |                         |                |    |
| 3 Points   | 2 Points                             | 1 Point | Score      | 1 Point     | 2 Points                | 3 Points       |    |
|            |                                      |         | 6 : 9      |             |                         |                |    |
| Penatlity  |                                      |         |            | Penatlity   |                         |                |    |
| C1: , C2:  |                                      |         | <b>6:9</b> | C1: C1, C2: |                         |                |    |
|            |                                      |         | Total      | WINNER      |                         |                |    |

PTS

## Decision of Superiority

| Judge 1 | Judge 2 | Judge 3 | Judge 4 | Judge 5 | Judge 6 | Judge 7 | Referee |
|---------|---------|---------|---------|---------|---------|---------|---------|
|         |         |         |         |         |         |         |         |

Name

Signature

\_\_\_\_\_  
\_\_\_\_\_



# Tawastia Open Karate 2/2024

Liivuoventie 24, Hmeenlinna, FINLAND

|             |                                      |         |            |             |                         |                |    |
|-------------|--------------------------------------|---------|------------|-------------|-------------------------|----------------|----|
| Court Nr.   | 1                                    | Pool    | 1          | Date        | 2024-10-06              | Field Position | 62 |
| <b>RED</b>  |                                      |         |            | <b>BLUE</b> |                         |                |    |
| NOC         | PELKONEN AUNE (KARATE HERVANTA,FIN)  |         |            | NOC         | KORPELA SIIRI (OKS,FIN) |                |    |
| Category    | Kumite, tytt, U16, +54 kg yhdistetty |         |            |             |                         |                |    |
| 3 Points    | 2 Points                             | 1 Point | Score      | 1 Point     | 2 Points                | 3 Points       |    |
|             |                                      |         | 0 : 7      |             |                         |                |    |
| Penatlity   |                                      |         |            | Penatlity   |                         |                |    |
| C1: C3, C2: |                                      |         | <b>0:7</b> | C1: HC, C2: |                         |                |    |
|             |                                      |         | Total      | WINNER      |                         |                |    |

PTS

## Decision of Superiority

| Judge 1 | Judge 2 | Judge 3 | Judge 4 | Judge 5 | Judge 6 | Judge 7 | Referee |
|---------|---------|---------|---------|---------|---------|---------|---------|
|         |         |         |         |         |         |         |         |

Name

Signature

\_\_\_\_\_  
\_\_\_\_\_



# Tawastia Open Karate 2/2024

Liivuoentie 24, Hmeenlinna, FINLAND

|             |                                      |         |            |             |                         |                |    |
|-------------|--------------------------------------|---------|------------|-------------|-------------------------|----------------|----|
| Court Nr.   | 1                                    | Pool    | 1          | Date        | 2024-10-06              | Field Position | 63 |
| <b>RED</b>  |                                      |         |            | <b>BLUE</b> |                         |                |    |
| NOC         | JOKINEN HELMI (HKS,FIN)              |         |            | NOC         | KORPELA SIIRI (OKS,FIN) |                |    |
| Category    | Kumite, tytt, U16, +54 kg yhdistetty |         |            |             |                         |                |    |
| 3 Points    | 2 Points                             | 1 Point | Score      | 1 Point     | 2 Points                | 3 Points       |    |
|             |                                      |         | 8 : 0      |             |                         |                |    |
| Penatlity   |                                      |         |            | Penatlity   |                         |                |    |
| C1: C2, C2: |                                      |         | <b>8:0</b> | C1: , C2:   |                         |                |    |
| WINNER      |                                      |         | Total      |             |                         |                |    |

PTS

## Decision of Superiority

| Judge 1 | Judge 2 | Judge 3 | Judge 4 | Judge 5 | Judge 6 | Judge 7 | Referee |
|---------|---------|---------|---------|---------|---------|---------|---------|
|         |         |         |         |         |         |         |         |

Name

Signature





\_\_\_\_\_  
\_\_\_\_\_







## Official Results

| Kumite, tytöt, U16, +54 kg yhdistetty |                |                             |   |               |
|---------------------------------------|----------------|-----------------------------|---|---------------|
| 1                                     | JOKINEN HELMI  | HÄMEENLINNAN<br>KARATESEURA |  | FIN - FINLAND |
| 2                                     | KORPELA SIIRI  | OULUN<br>KARATESEURA        |  | FIN - FINLAND |
| 3                                     | MERTAMO AMANDA | TAPANILAN ERÄ               |  | FIN - FINLAND |
| 4                                     | PELKONEN AUNE  | SHOTOKAN<br>HERVANTA RY     |  | FIN - FINLAND |

# KUMITE, TYTÖT, U16, -47 KG

Tawastia Open Karate 2/2024

**ENTRIES BY WEIGHT CATEGORY**  
**Kumite, tytt, U16, -47 kg**

As of 6 OCT 2024

| Country Code | ID | Gender | Name            | Seeding |
|--------------|----|--------|-----------------|---------|
| FIN          |    | F      | Hannu Alva      |         |
| FIN          |    | F      | Itkonen Janika  |         |
| FIN          |    | F      | Kentt Hilda     |         |
| FIN          |    | F      | Mustafina Sofia |         |
| FIN          |    | F      | Nuhanovic Haska |         |

# Kumite, tytöt, U16, -47 kg

Tawastia Open Karate 2/2024, Liivourentie 24, Hämeenlinna, FIN

2024-10-05

Tatami  
2 16:05

Pool  
1/1

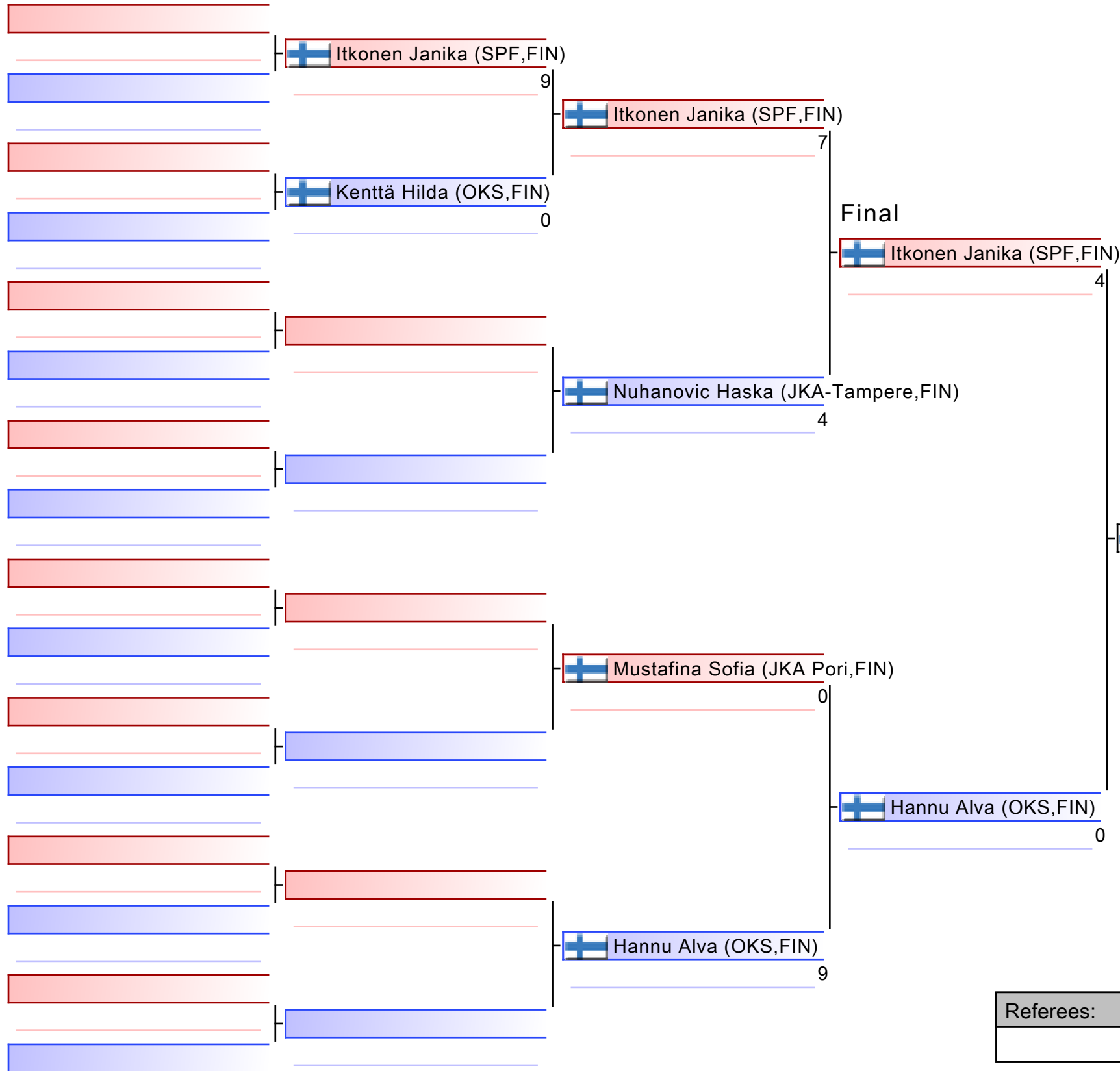

Itkonen Janika (SPF, FIN)

|                                      |
|--------------------------------------|
| 1. ITKONEN JANIKA (SPF,FIN)          |
| 2. HANNU ALVA (OKS,FIN)              |
| 3. NUHANOVIC HASKA (JKA-TAMPERE,FIN) |
| 4. MUSTAFINA SOFIA (JKA PORI,FIN)    |
| 5. KENTTÄ HILDA (OKS,FIN)            |
|                                      |
|                                      |

|           |  |  |  |
|-----------|--|--|--|
| Referees: |  |  |  |
|           |  |  |  |

# Kumite, tytöt, U16, -47 kg

Tawastia Open Karate 2/2024

2024-10-05

Tatami  
2 16:05

Pool  
1

(c)sportdata GmbH & Co KG 2000-2024 (2024-10-06 10:03) v 10.2.0 build 1 (2024-09-26 10:14 CET) License: Online\_Event\_ID-8546\_TawastiaOpenKarate2024 (expire 2024-10-20)

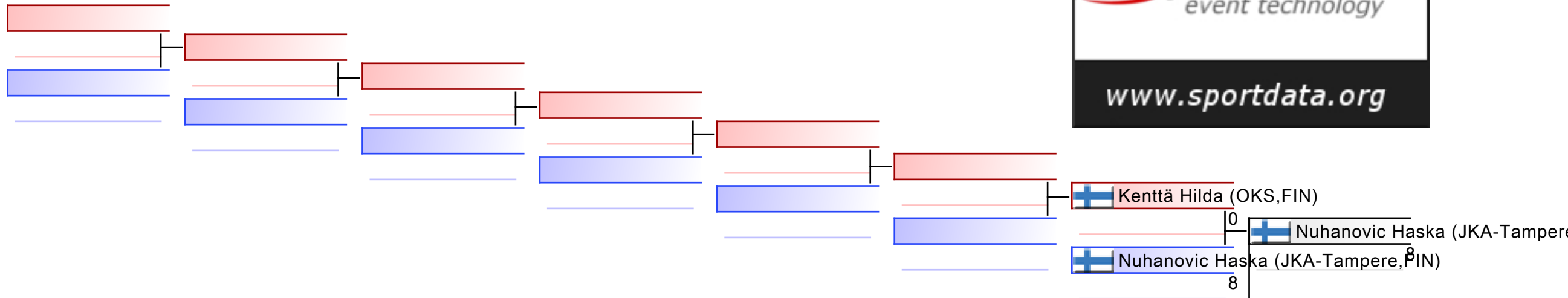

## REPECHAGE: (1)

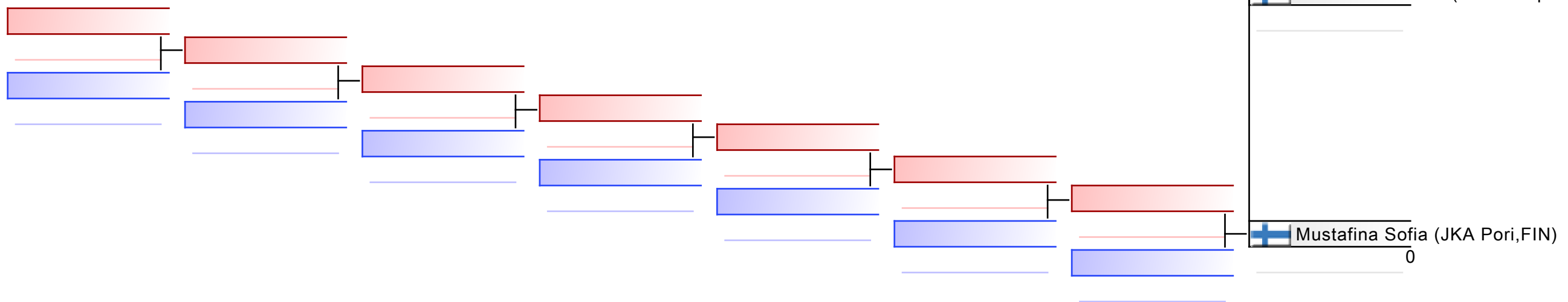

|           |  |  |  |  |  |  |  |
|-----------|--|--|--|--|--|--|--|
| Referees: |  |  |  |  |  |  |  |
|-----------|--|--|--|--|--|--|--|

# Tawastia Open Karate 2/2024

Liivuoentie 24, Hmeenlinna, FINLAND

|             |                           |         |            |             |                       |                |    |
|-------------|---------------------------|---------|------------|-------------|-----------------------|----------------|----|
| Court Nr.   | 1                         | Pool    | 1          | Date        | 2024-10-06            | Field Position | 57 |
| <b>RED</b>  |                           |         |            | <b>BLUE</b> |                       |                |    |
| NOC         | ITKONEN JANIKA (SPF,FIN)  |         |            | NOC         | KENTT HILDA (OKS,FIN) |                |    |
| Category    | Kumite, tytt, U16, -47 kg |         |            |             |                       |                |    |
| 3 Points    | 2 Points                  | 1 Point | Score      | 1 Point     | 2 Points              | 3 Points       |    |
|             |                           |         | 9 : 0      |             |                       |                |    |
| Penatlity   |                           |         |            | Penatlity   |                       |                |    |
| C1: C1, C2: |                           |         | <b>9:0</b> | C1: , C2:   |                       |                |    |
| WINNER      |                           |         | Total      |             |                       |                |    |

PTS

## Decision of Superiority

| Judge 1 | Judge 2 | Judge 3 | Judge 4 | Judge 5 | Judge 6 | Judge 7 | Referee |
|---------|---------|---------|---------|---------|---------|---------|---------|
|         |         |         |         |         |         |         |         |

Name

Signature

\_\_\_\_\_  
\_\_\_\_\_



# Tawastia Open Karate 2/2024

Liivuoentie 24, Hmeenlinna, FINLAND

|             |                           |         |            |             |                                   |                |    |
|-------------|---------------------------|---------|------------|-------------|-----------------------------------|----------------|----|
| Court Nr.   | 1                         | Pool    | 1          | Date        | 2024-10-06                        | Field Position | 61 |
| <b>RED</b>  |                           |         |            | <b>BLUE</b> |                                   |                |    |
| NOC         | ITKONEN JANIKA (SPF,FIN)  |         |            | NOC         | NUHANOVIC HASKA (JKA-TAMPERE,FIN) |                |    |
| Category    | Kumite, tytt, U16, -47 kg |         |            |             |                                   |                |    |
| 3 Points    | 2 Points                  | 1 Point | Score      | 1 Point     | 2 Points                          | 3 Points       |    |
|             |                           |         | 7 : 4      |             |                                   |                |    |
| Penatlity   |                           |         |            | Penatlity   |                                   |                |    |
| C1: C3, C2: |                           |         | <b>7:4</b> | C1: , C2:   |                                   |                |    |
| WINNER      |                           |         | Total      |             |                                   |                |    |

PTS

## Decision of Superiority

| Judge 1 | Judge 2 | Judge 3 | Judge 4 | Judge 5 | Judge 6 | Judge 7 | Referee |
|---------|---------|---------|---------|---------|---------|---------|---------|
|         |         |         |         |         |         |         |         |

Name

Signature

\_\_\_\_\_  
\_\_\_\_\_





# Tawastia Open Karate 2/2024

Liivuoentie 24, Hmeenlinna, FINLAND

|            |                                |         |            |             |                      |                |    |
|------------|--------------------------------|---------|------------|-------------|----------------------|----------------|----|
| Court Nr.  | 1                              | Pool    | 1          | Date        | 2024-10-06           | Field Position | 62 |
| <b>RED</b> |                                |         |            | <b>BLUE</b> |                      |                |    |
| NOC        | MUSTAFINA SOFIA (JKA PORI,FIN) |         |            | NOC         | HANNU ALVA (OKS,FIN) |                |    |
| Category   | Kumite, tytt, U16, -47 kg      |         |            |             |                      |                |    |
| 3 Points   | 2 Points                       | 1 Point | Score      | 1 Point     | 2 Points             | 3 Points       |    |
|            |                                |         | 0 : 9      |             |                      |                |    |
| Penatlity  |                                |         |            | Penatlity   |                      |                |    |
| C1: , C2:  |                                |         | <b>0:9</b> | C1: , C2:   |                      |                |    |
|            |                                |         | Total      | WINNER      |                      |                |    |

PTS

## Decision of Superiority

|         |         |         |         |         |         |         |         |
|---------|---------|---------|---------|---------|---------|---------|---------|
| Judge 1 | Judge 2 | Judge 3 | Judge 4 | Judge 5 | Judge 6 | Judge 7 | Referee |
|         |         |         |         |         |         |         |         |

Name

Signature

\_\_\_\_\_  
\_\_\_\_\_



# Tawastia Open Karate 2/2024

Liivuoentie 24, Hmeenlinna, FINLAND

|             |                           |         |            |             |                      |                |    |
|-------------|---------------------------|---------|------------|-------------|----------------------|----------------|----|
| Court Nr.   | 1                         | Pool    | 1          | Date        | 2024-10-06           | Field Position | 63 |
| <b>RED</b>  |                           |         |            | <b>BLUE</b> |                      |                |    |
| NOC         | ITKONEN JANIKA (SPF,FIN)  |         |            | NOC         | HANNU ALVA (OKS,FIN) |                |    |
| Category    | Kumite, tytt, U16, -47 kg |         |            |             |                      |                |    |
| 3 Points    | 2 Points                  | 1 Point | Score      | 1 Point     | 2 Points             | 3 Points       |    |
|             |                           |         | 4 : 0      |             |                      |                |    |
| Penatlity   |                           |         |            | Penatlity   |                      |                |    |
| C1: C1, C2: |                           |         | <b>4:0</b> | C1: C1, C2: |                      |                |    |
| WINNER      |                           |         | Total      |             |                      |                |    |

PTS

## Decision of Superiority

| Judge 1 | Judge 2 | Judge 3 | Judge 4 | Judge 5 | Judge 6 | Judge 7 | Referee |
|---------|---------|---------|---------|---------|---------|---------|---------|
|         |         |         |         |         |         |         |         |

Name

Signature

\_\_\_\_\_  
\_\_\_\_\_



# Tawastia Open Karate 2/2024

Liivuoentie 24, Hmeenlinna, FINLAND

|            |                           |         |       |             |                                   |                |   |
|------------|---------------------------|---------|-------|-------------|-----------------------------------|----------------|---|
| Court Nr.  | 1                         | Pool    | 1     | Date        | 2024-10-06                        | Field Position | 0 |
| <b>RED</b> |                           |         |       | <b>BLUE</b> |                                   |                |   |
| NOC        | KENTT HILDA (OKS,FIN)     |         |       | NOC         | NUHANOVIC HASKA (JKA-TAMPERE,FIN) |                |   |
| Category   | Kumite, tytt, U16, -47 kg |         |       |             |                                   |                |   |
| 3 Points   | 2 Points                  | 1 Point | Score | 1 Point     | 2 Points                          | 3 Points       |   |
|            |                           |         | :     |             |                                   |                |   |
| Penatlity  |                           |         |       | Penatlity   |                                   |                |   |
|            |                           |         |       |             |                                   |                |   |
|            |                           |         | Total |             |                                   |                |   |

## Decision of Superiority

|         |         |         |         |         |         |         |         |
|---------|---------|---------|---------|---------|---------|---------|---------|
| Judge 1 | Judge 2 | Judge 3 | Judge 4 | Judge 5 | Judge 6 | Judge 7 | Referee |
|         |         |         |         |         |         |         |         |

Name

Signature





\_\_\_\_\_

\_\_\_\_\_



## Tawastia Open Karate 2/2024 - 2024-10-05

## Official Results

| Kumite, tytöt, U16, -47 kg |                 |   |   |               |
|----------------------------|-----------------|---|---|---------------|
| 1                          | IITKONEN JANIKA | SPORTSKARATE.FI                           |  | FIN - FINLAND |
| 2                          | HANNU ALVA      | OULUN<br>KARATESEURA                      |  | FIN - FINLAND |
| 3                          | NUHANOVIC HASKA | JAPAN KARATE<br>ASSOCIATION<br>TAMPERE RY |  | FIN - FINLAND |
| 4                          | MUSTAFINA SOFIA | PORIN SHOTOKAN                            |  | FIN - FINLAND |
| 5                          | KENTTÄ HILDA    | OULUN<br>KARATESEURA                      |  | FIN - FINLAND |

# KUMITE, TYTÖT, U16, -54 KG

Tawastia Open Karate 2/2024

**ENTRIES BY WEIGHT CATEGORY**

**Kumite, tytt, U16, -54 kg**

As of 6 OCT 2024

| Country Code | ID | Gender | Name              | Seeding |
|--------------|----|--------|-------------------|---------|
| FIN          |    | F      | Chepelev Sofia    |         |
| FIN          |    | F      | Lehtinen Eleanor  |         |
| FIN          |    | F      | Stefanski Vanessa |         |
| FIN          |    | F      | Syrjnen Lily      |         |



















# Kumite, tytöt, U16, -54 kg - Round Robin (each against each)

Tawastia Open Karate 2/2024, Liivuorentie 24, Hämeenlinna, FIN

2024-10-05

Tatami  
2 16:25

Pool  
1/1

|    |   |    |  |
|----|---|----|--|
| 1  |  Stefanski Vanessa (LK-FIN,FIN)   | 8  |  Stefanski Vanessa (LK-FIN,FIN)   |
| 2  |  Syrjänen Lily (JKA Pori,FIN)     | 0  |  |
| 3  |  Chepelev Sofia (SPF,FIN)         | 8  |  Chepelev Sofia (SPF,FIN)         |
| 4  |  Lehtinen Eleanor (Erä,FIN)       | 0  |  |
| 5  |  Stefanski Vanessa (LK-FIN,FIN)   | 7  |  Chepelev Sofia (SPF,FIN)         |
| 6  |  Chepelev Sofia (SPF,FIN)         | 12 |  |
| 7  |  Lehtinen Eleanor (Erä,FIN)       | 8  |  Lehtinen Eleanor (Erä,FIN)       |
| 8  |  Syrjänen Lily (JKA Pori,FIN)     | 0  |  |
| 9  |  Stefanski Vanessa (LK-FIN,FIN) | 8  |  Stefanski Vanessa (LK-FIN,FIN) |
| 10 |  Lehtinen Eleanor (Erä,FIN)     | 0  |  |
| 11 |  Syrjänen Lily (JKA Pori,FIN)   | 0  |  Chepelev Sofia (SPF,FIN)       |
| 12 |  Chepelev Sofia (SPF,FIN)       | 8  |  |



|                                   |
|-----------------------------------|
| 1. CHEPELEV SOFIA (SPF,FIN)       |
| 2. STEFANSKI VANESSA (LK-FIN,FIN) |
| 3. LEHTINEN ELEANOR (ERÄ,FIN)     |
| 4. SYRJÄNEN LILY (JKA PORI,FIN)   |
|                                   |
|                                   |
|                                   |

|           |  |  |  |
|-----------|--|--|--|
| Referees: |  |  |  |
|           |  |  |  |

# Tawastia Open Karate 2/2024

Liivuoentie 24, Hmeenlinna, FINLAND

|            |                                |         |            |             |                             |                |       |
|------------|--------------------------------|---------|------------|-------------|-----------------------------|----------------|-------|
| Court Nr.  | 1                              | Pool    | 1          | Date        | 2024-10-06                  | Field Position | -9951 |
| <b>RED</b> |                                |         |            | <b>BLUE</b> |                             |                |       |
| NOC        | STEFANSKI VANESSA (LK-FIN,FIN) |         |            | NOC         | SYRJNEN LILY (JKA PORI,FIN) |                |       |
| Category   | Kumite, tytt, U16, -54 kg      |         |            |             |                             |                |       |
| 3 Points   | 2 Points                       | 1 Point | Score      | 1 Point     | 2 Points                    | 3 Points       |       |
|            |                                |         | 8 : 0      |             |                             |                |       |
| Penatlity  |                                |         |            | Penatlity   |                             |                |       |
| C1: , C2:  |                                |         | <b>8:0</b> | C1: , C2:   |                             |                |       |
| WINNER     |                                |         | Total      |             |                             |                |       |

PTS

## Decision of Superiority

| Judge 1 | Judge 2 | Judge 3 | Judge 4 | Judge 5 | Judge 6 | Judge 7 | Referee |
|---------|---------|---------|---------|---------|---------|---------|---------|
|         |         |         |         |         |         |         |         |

Name

Signature

\_\_\_\_\_

\_\_\_\_\_





# Tawastia Open Karate 2/2024

Liivuoentie 24, Hmeenlinna, FINLAND

|             |                           |         |            |             |                           |                |       |
|-------------|---------------------------|---------|------------|-------------|---------------------------|----------------|-------|
| Court Nr.   | 1                         | Pool    | 1          | Date        | 2024-10-06                | Field Position | -9950 |
| <b>RED</b>  |                           |         |            | <b>BLUE</b> |                           |                |       |
| NOC         | CHEPELEV SOFIA (SPF,FIN)  |         |            | NOC         | LEHTINEN ELEANOR (ER,FIN) |                |       |
| Category    | Kumite, tytt, U16, -54 kg |         |            |             |                           |                |       |
| 3 Points    | 2 Points                  | 1 Point | Score      | 1 Point     | 2 Points                  | 3 Points       |       |
|             |                           |         | 8 : 0      |             |                           |                |       |
| Penatlity   |                           |         |            | Penatlity   |                           |                |       |
| C1: C1, C2: |                           |         | <b>8:0</b> | C1: C1, C2: |                           |                |       |
| WINNER      |                           |         | Total      |             |                           |                |       |

PTS

## Decision of Superiority

| Judge 1 | Judge 2 | Judge 3 | Judge 4 | Judge 5 | Judge 6 | Judge 7 | Referee |
|---------|---------|---------|---------|---------|---------|---------|---------|
|         |         |         |         |         |         |         |         |

Name

Signature

\_\_\_\_\_  
\_\_\_\_\_



# Tawastia Open Karate 2/2024

Liivuoentie 24, Hmeenlinna, FINLAND

|            |                                |         |             |             |                          |                |       |
|------------|--------------------------------|---------|-------------|-------------|--------------------------|----------------|-------|
| Court Nr.  | 1                              | Pool    | 1           | Date        | 2024-10-06               | Field Position | -9949 |
| <b>RED</b> |                                |         |             | <b>BLUE</b> |                          |                |       |
| NOC        | STEFANSKI VANESSA (LK-FIN,FIN) |         |             | NOC         | CHEPELEV SOFIA (SPF,FIN) |                |       |
| Category   | Kumite, tytt, U16, -54 kg      |         |             |             |                          |                |       |
| 3 Points   | 2 Points                       | 1 Point | Score       | 1 Point     | 2 Points                 | 3 Points       |       |
|            |                                |         | 7 : 12      |             |                          |                |       |
| Penatlity  |                                |         |             | Penatlity   |                          |                |       |
| C1: , C2:  |                                |         | <b>7:12</b> | C1: , C2:   |                          |                |       |
|            |                                |         | Total       | WINNER      |                          |                |       |

PTS

## Decision of Superiority

| Judge 1 | Judge 2 | Judge 3 | Judge 4 | Judge 5 | Judge 6 | Judge 7 | Referee |
|---------|---------|---------|---------|---------|---------|---------|---------|
|         |         |         |         |         |         |         |         |

Name

Signature

\_\_\_\_\_  
\_\_\_\_\_



# Tawastia Open Karate 2/2024

Liivuoentie 24, Hmeenlinna, FINLAND

|            |                           |         |            |             |                             |                |       |
|------------|---------------------------|---------|------------|-------------|-----------------------------|----------------|-------|
| Court Nr.  | 1                         | Pool    | 1          | Date        | 2024-10-06                  | Field Position | -9948 |
| <b>RED</b> |                           |         |            | <b>BLUE</b> |                             |                |       |
| NOC        | LEHTINEN ELEANOR (ER,FIN) |         |            | NOC         | SYRJNEN LILY (JKA PORI,FIN) |                |       |
| Category   | Kumite, tytt, U16, -54 kg |         |            |             |                             |                |       |
| 3 Points   | 2 Points                  | 1 Point | Score      | 1 Point     | 2 Points                    | 3 Points       |       |
|            |                           |         | 8 : 0      |             |                             |                |       |
| Penatlity  |                           |         |            | Penatlity   |                             |                |       |
| C1: , C2:  |                           |         | <b>8:0</b> | C1: , C2:   |                             |                |       |
| WINNER     |                           |         | Total      |             |                             |                |       |

KI

## Decision of Superiority

| Judge 1 | Judge 2 | Judge 3 | Judge 4 | Judge 5 | Judge 6 | Judge 7 | Referee |
|---------|---------|---------|---------|---------|---------|---------|---------|
|         |         |         |         |         |         |         |         |

Name

Signature

\_\_\_\_\_  
\_\_\_\_\_



# Tawastia Open Karate 2/2024

Liivuoentie 24, Hmeenlinna, FINLAND

|            |                                |         |            |             |                           |                |       |
|------------|--------------------------------|---------|------------|-------------|---------------------------|----------------|-------|
| Court Nr.  | 1                              | Pool    | 1          | Date        | 2024-10-06                | Field Position | -9947 |
| <b>RED</b> |                                |         |            | <b>BLUE</b> |                           |                |       |
| NOC        | STEFANSKI VANESSA (LK-FIN,FIN) |         |            | NOC         | LEHTINEN ELEANOR (ER,FIN) |                |       |
| Category   | Kumite, tytt, U16, -54 kg      |         |            |             |                           |                |       |
| 3 Points   | 2 Points                       | 1 Point | Score      | 1 Point     | 2 Points                  | 3 Points       |       |
|            |                                |         | 8 : 0      |             |                           |                |       |
| Penatlity  |                                |         |            | Penatlity   |                           |                |       |
| C1: , C2:  |                                |         | <b>8:0</b> | C1: , C2:   |                           |                |       |
| WINNER     |                                |         | Total      |             |                           |                |       |

PTS

## Decision of Superiority

| Judge 1 | Judge 2 | Judge 3 | Judge 4 | Judge 5 | Judge 6 | Judge 7 | Referee |
|---------|---------|---------|---------|---------|---------|---------|---------|
|         |         |         |         |         |         |         |         |

Name

Signature

\_\_\_\_\_  
\_\_\_\_\_



# Tawastia Open Karate 2/2024

Liivuoentie 24, Hmeenlinna, FINLAND

|            |                             |         |            |             |                          |                |       |
|------------|-----------------------------|---------|------------|-------------|--------------------------|----------------|-------|
| Court Nr.  | 1                           | Pool    | 1          | Date        | 2024-10-06               | Field Position | -9946 |
| <b>RED</b> |                             |         |            | <b>BLUE</b> |                          |                |       |
| NOC        | SYRJNEN LILY (JKA PORI,FIN) |         |            | NOC         | CHEPELEV SOFIA (SPF,FIN) |                |       |
| Category   | Kumite, tytt, U16, -54 kg   |         |            |             |                          |                |       |
| 3 Points   | 2 Points                    | 1 Point | Score      | 1 Point     | 2 Points                 | 3 Points       |       |
|            |                             |         | 0 : 8      |             |                          |                |       |
| Penatlity  |                             |         |            | Penatlity   |                          |                |       |
| C1: , C2:  |                             |         | <b>0:8</b> | C1: , C2:   |                          |                |       |
|            |                             |         | Total      | WINNER      |                          |                |       |

KI

## Decision of Superiority

| Judge 1 | Judge 2 | Judge 3 | Judge 4 | Judge 5 | Judge 6 | Judge 7 | Referee |
|---------|---------|---------|---------|---------|---------|---------|---------|
|         |         |         |         |         |         |         |         |

Name





Signature

\_\_\_\_\_  
\_\_\_\_\_



Tawastia Open Karate 2/2024 - 2024-10-05

Official Results

| Kumite, tytöt, U16, -54 kg |                   |                 |   |               |
|----------------------------|-------------------|-----------------|---|---------------|
| 1                          | CHEPELEV SOFIA    | SPORTSKARATE.FI |  | FIN - FINLAND |
| 2                          | STEFANSKI VANESSA | LAHDEN KARATE   |  | FIN - FINLAND |
| 3                          | LEHTINEN ELEANOR  | TAPANILAN ERÄ   |  | FIN - FINLAND |
| 4                          | SYRJÄNEN LILY     | PORIN SHOTOKAN  |  | FIN - FINLAND |

KUMITE, TYTÖT, U18, +53KG  
YHDISTETTY

Tawastia Open Karate 2/2024

**ENTRIES BY WEIGHT CATEGORY**  
**Kumite, tytt, U18, +53kg yhdistetty**

As of 6 OCT 2024

| Country Code | ID | Gender | Name            | Seeding |
|--------------|----|--------|-----------------|---------|
| FIN          |    | F      | Jokinen Helmi   |         |
| FIN          |    | F      | Koivula Sofia   |         |
| FIN          |    | F      | Meyke Alexandra |         |
| FIN          |    | F      | Saarnio Selja   |         |



# Kumite, tytöt, U18, +53kg yhdistetty - Round Robin (each against each)

Tawastia Open Karate 2/2024, Liivuoentie 24, Hämeenlinna, FIN



















2024-10-05

Tatami

2 17:30

Pool

1/1

|    |  |    |   |
|----|--|----|---|
| 1  |  Koivula Sofia (SPF,FIN)             | 10 |  Koivula Sofia (SPF,FIN)   |
| 2  |  Meyke Alexandra (JKS Finland,FIN)   | 1  |   |
| 3  |  Saarnio Selja (SPF,FIN)             | 12 |  Saarnio Selja (SPF,FIN)   |
| 4  |  Jokinen Helmi (HKS,FIN)             | 5  |   |
| 5  |  Koivula Sofia (SPF,FIN)             | 4  |  Koivula Sofia (SPF,FIN)   |
| 6  |  Saarnio Selja (SPF,FIN)             | 2  |   |
| 7  |  Jokinen Helmi (HKS,FIN)             | 4  |  Jokinen Helmi (HKS,FIN)   |
| 8  |  Meyke Alexandra (JKS Finland,FIN)   | 3  |   |
| 9  |  Koivula Sofia (SPF,FIN)           | 5  |  Koivula Sofia (SPF,FIN) |
| 10 |  Jokinen Helmi (HKS,FIN)           | 2  |   |
| 11 |  Meyke Alexandra (JKS Finland,FIN) | 3  |  Saarnio Selja (SPF,FIN) |
| 12 |  Saarnio Selja (SPF,FIN)           | 8  |   |



|                                      |
|--------------------------------------|
| 1. KOIVULA SOFIA (SPF,FIN)           |
| 2. SAARNIO SELJA (SPF,FIN)           |
| 3. JOKINEN HELMI (HKS,FIN)           |
| 4. MEYKE ALEXANDRA (JKS FINLAND,FIN) |
|                                      |
|                                      |
|                                      |

|           |  |  |  |
|-----------|--|--|--|
| Referees: |  |  |  |
|           |  |  |  |

# Tawastia Open Karate 2/2024

Liivuoentie 24, Hmeenlinna, FINLAND

|            |                                     |         |             |             |                                   |                |       |
|------------|-------------------------------------|---------|-------------|-------------|-----------------------------------|----------------|-------|
| Court Nr.  | 1                                   | Pool    | 1           | Date        | 2024-10-06                        | Field Position | -9951 |
| <b>RED</b> |                                     |         |             | <b>BLUE</b> |                                   |                |       |
| NOC        | KOIVULA SOFIA (SPF,FIN)             |         |             | NOC         | MEYKE ALEXANDRA (JKS FINLAND,FIN) |                |       |
| Category   | Kumite, tytt, U18, +53kg yhdistetty |         |             |             |                                   |                |       |
| 3 Points   | 2 Points                            | 1 Point | Score       | 1 Point     | 2 Points                          | 3 Points       |       |
|            |                                     |         | 10 : 1      |             |                                   |                |       |
| Penatlity  |                                     |         |             | Penatlity   |                                   |                |       |
| C1: , C2:  |                                     |         | <b>10:1</b> | C1: , C2:   |                                   |                |       |
| WINNER     |                                     |         | Total       |             |                                   |                |       |

PTS

## Decision of Superiority

|         |         |         |         |         |         |         |         |
|---------|---------|---------|---------|---------|---------|---------|---------|
| Judge 1 | Judge 2 | Judge 3 | Judge 4 | Judge 5 | Judge 6 | Judge 7 | Referee |
|         |         |         |         |         |         |         |         |

Name

Signature

\_\_\_\_\_  
\_\_\_\_\_



# Tawastia Open Karate 2/2024

Liivuoentie 24, Hmeenlinna, FINLAND

|            |                                     |         |             |             |                         |                |       |
|------------|-------------------------------------|---------|-------------|-------------|-------------------------|----------------|-------|
| Court Nr.  | 1                                   | Pool    | 1           | Date        | 2024-10-06              | Field Position | -9950 |
| <b>RED</b> |                                     |         |             | <b>BLUE</b> |                         |                |       |
| NOC        | SAARNIO SELJA (SPF,FIN)             |         |             | NOC         | JOKINEN HELMI (HKS,FIN) |                |       |
| Category   | Kumite, tytt, U18, +53kg yhdistetty |         |             |             |                         |                |       |
| 3 Points   | 2 Points                            | 1 Point | Score       | 1 Point     | 2 Points                | 3 Points       |       |
|            |                                     |         | 12 : 5      |             |                         |                |       |
| Penatlity  |                                     |         |             | Penatlity   |                         |                |       |
| C1: , C2:  |                                     |         | <b>12:5</b> | C1: C3, C2: |                         |                |       |
| WINNER     |                                     |         | Total       |             |                         |                |       |

PTS

## Decision of Superiority

| Judge 1 | Judge 2 | Judge 3 | Judge 4 | Judge 5 | Judge 6 | Judge 7 | Referee |
|---------|---------|---------|---------|---------|---------|---------|---------|
|         |         |         |         |         |         |         |         |

Name \_\_\_\_\_

Signature \_\_\_\_\_



# Tawastia Open Karate 2/2024

Liivuoentie 24, Hmeenlinna, FINLAND

|            |                                     |         |            |             |                         |                |       |
|------------|-------------------------------------|---------|------------|-------------|-------------------------|----------------|-------|
| Court Nr.  | 1                                   | Pool    | 1          | Date        | 2024-10-06              | Field Position | -9949 |
| <b>RED</b> |                                     |         |            | <b>BLUE</b> |                         |                |       |
| NOC        | KOIVULA SOFIA (SPF,FIN)             |         |            | NOC         | SAARNIO SELJA (SPF,FIN) |                |       |
| Category   | Kumite, tytt, U18, +53kg yhdistetty |         |            |             |                         |                |       |
| 3 Points   | 2 Points                            | 1 Point | Score      | 1 Point     | 2 Points                | 3 Points       |       |
|            |                                     |         | 4 : 2      |             |                         |                |       |
| Penatlity  |                                     |         |            | Penatlity   |                         |                |       |
| C1: , C2:  |                                     |         | <b>4:2</b> | C1: , C2:   |                         |                |       |
| WINNER     |                                     |         | Total      |             |                         |                |       |

PTS

## Decision of Superiority

|         |         |         |         |         |         |         |         |
|---------|---------|---------|---------|---------|---------|---------|---------|
| Judge 1 | Judge 2 | Judge 3 | Judge 4 | Judge 5 | Judge 6 | Judge 7 | Referee |
|         |         |         |         |         |         |         |         |

Name

Signature

\_\_\_\_\_  
\_\_\_\_\_



# Tawastia Open Karate 2/2024

Liivuoentie 24, Hmeenlinna, FINLAND

|            |                                     |         |            |             |                                   |                |       |
|------------|-------------------------------------|---------|------------|-------------|-----------------------------------|----------------|-------|
| Court Nr.  | 1                                   | Pool    | 1          | Date        | 2024-10-06                        | Field Position | -9948 |
| <b>RED</b> |                                     |         |            | <b>BLUE</b> |                                   |                |       |
| NOC        | JOKINEN HELMI (HKS,FIN)             |         |            | NOC         | MEYKE ALEXANDRA (JKS FINLAND,FIN) |                |       |
| Category   | Kumite, tytt, U18, +53kg yhdistetty |         |            |             |                                   |                |       |
| 3 Points   | 2 Points                            | 1 Point | Score      | 1 Point     | 2 Points                          | 3 Points       |       |
|            |                                     |         | 4 : 3      |             |                                   |                |       |
| Penatlity  |                                     |         |            | Penatlity   |                                   |                |       |
| C1: , C2:  |                                     |         | <b>4:3</b> | C1: , C2:   |                                   |                |       |
| WINNER     |                                     |         | Total      |             |                                   |                |       |

PTS

## Decision of Superiority

| Judge 1 | Judge 2 | Judge 3 | Judge 4 | Judge 5 | Judge 6 | Judge 7 | Referee |
|---------|---------|---------|---------|---------|---------|---------|---------|
|         |         |         |         |         |         |         |         |

Name

Signature

\_\_\_\_\_  
\_\_\_\_\_



# Tawastia Open Karate 2/2024

Liivuoentie 24, Hmeenlinna, FINLAND

|             |                                     |         |            |             |                         |                |       |
|-------------|-------------------------------------|---------|------------|-------------|-------------------------|----------------|-------|
| Court Nr.   | 1                                   | Pool    | 1          | Date        | 2024-10-06              | Field Position | -9947 |
| <b>RED</b>  |                                     |         |            | <b>BLUE</b> |                         |                |       |
| NOC         | KOIVULA SOFIA (SPF,FIN)             |         |            | NOC         | JOKINEN HELMI (HKS,FIN) |                |       |
| Category    | Kumite, tytt, U18, +53kg yhdistetty |         |            |             |                         |                |       |
| 3 Points    | 2 Points                            | 1 Point | Score      | 1 Point     | 2 Points                | 3 Points       |       |
|             |                                     |         | 5 : 2      |             |                         |                |       |
| Penatlity   |                                     |         |            | Penatlity   |                         |                |       |
| C1: C1, C2: |                                     |         | <b>5:2</b> | C1: C1, C2: |                         |                |       |
| WINNER      |                                     |         | Total      |             |                         |                |       |

PTS

## Decision of Superiority

| Judge 1 | Judge 2 | Judge 3 | Judge 4 | Judge 5 | Judge 6 | Judge 7 | Referee |
|---------|---------|---------|---------|---------|---------|---------|---------|
|         |         |         |         |         |         |         |         |

Name

Signature

\_\_\_\_\_  
\_\_\_\_\_



# Tawastia Open Karate 2/2024

Liivuoentie 24, Hmeenlinna, FINLAND

|            |                                     |         |       |             |                         |                |       |
|------------|-------------------------------------|---------|-------|-------------|-------------------------|----------------|-------|
| Court Nr.  | 1                                   | Pool    | 1     | Date        | 2024-10-06              | Field Position | -9946 |
| <b>RED</b> |                                     |         |       | <b>BLUE</b> |                         |                |       |
| NOC        | MEYKE ALEXANDRA (JKS FINLAND,FIN)   |         |       | NOC         | SAARNIO SELJA (SPF,FIN) |                |       |
| Category   | Kumite, tytt, U18, +53kg yhdistetty |         |       |             |                         |                |       |
| 3 Points   | 2 Points                            | 1 Point | Score | 1 Point     | 2 Points                | 3 Points       |       |
|            |                                     |         | 3 : 8 |             |                         |                |       |
| Penatlity  |                                     |         |       | Penatlity   |                         |                |       |
| C1: , C2:  |                                     |         |       | <b>3:8</b>  | C1: , C2:               |                |       |
|            |                                     |         |       | Total       | WINNER                  |                |       |

PTS

## Decision of Superiority

| Judge 1 | Judge 2 | Judge 3 | Judge 4 | Judge 5 | Judge 6 | Judge 7 | Referee |
|---------|---------|---------|---------|---------|---------|---------|---------|
|         |         |         |         |         |         |         |         |

Name





Signature

\_\_\_\_\_  
\_\_\_\_\_



## Tawastia Open Karate 2/2024 - 2024-10-05

## Official Results

| Kumite, tytöt, U18, +53kg yhdistetty |                 |  |   |               |
|--------------------------------------|-----------------|--|---|---------------|
| 1                                    | KOIVULA SOFIA   | SPORTSKARATE.FI                              |  | FIN - FINLAND |
| 2                                    | SAARNIO SELJA   | SPORTSKARATE.FI                              |  | FIN - FINLAND |
| 3                                    | JOKINEN HELMI   | HÄMEENLINNAN<br>KARATESEURA                  |  | FIN - FINLAND |
| 4                                    | MEYKE ALEXANDRA | JKS FINLAND -<br>SHOTOKAN KARATE<br>HELSINKI |  | FIN - FINLAND |



KUMITE, TYTÖT, U18, -53 KG  
YHDISTETTY

Tawastia Open Karate 2/2024

**ENTRIES BY WEIGHT CATEGORY**  
**Kumite, tytt, U18, -53 kg yhdistetty**

As of 6 OCT 2024

| Country Code | ID | Gender | Name           | Seeding |
|--------------|----|--------|----------------|---------|
| FIN          |    | F      | Alatalo Onerva |         |
| FIN          |    | F      | Chepelev Sofia |         |
| FIN          |    | F      | Itkonen Janika |         |
| FIN          |    | F      | Rissanen Iina  |         |

# Kumite, tytöt, U18, -53 kg yhdistetty - Round Robin (each against each)

Tawastia Open Karate 2/2024, Liivuaarentie 24, Hämeenlinna, FIN



















2024-10-05

Tatami

2 17:05

Pool

1/1

|    |   |   |  |
|----|---|---|--|
| 1  |  Chepelev Sofia (SPF,FIN)           | 6 |  Chepelev Sofia (SPF,FIN)         |
| 2  |  Alatalo Onerva (JKS Finland,FIN)   | 5 |  |
| 3  |  Itkonen Janika (SPF,FIN)           | 3 |  Itkonen Janika (SPF,FIN)         |
| 4  |  Rissanen Iina (OM,FIN)             | 0 |  |
| 5  |  Chepelev Sofia (SPF,FIN)           | 0 |  Itkonen Janika (SPF,FIN)         |
| 6  |  Itkonen Janika (SPF,FIN)           | 5 |  |
| 7  |  Rissanen Iina (OM,FIN)             | 2 |  Alatalo Onerva (JKS Finland,FIN) |
| 8  |  Alatalo Onerva (JKS Finland,FIN)   | 3 |  |
| 9  |  Chepelev Sofia (SPF,FIN)          | 2 |  Chepelev Sofia (SPF,FIN)       |
| 10 |  Rissanen Iina (OM,FIN)           | 1 |  |
| 11 |  Alatalo Onerva (JKS Finland,FIN) | 2 |  Itkonen Janika (SPF,FIN)       |
| 12 |  Itkonen Janika (SPF,FIN)         | 6 |  |



|                                     |
|-------------------------------------|
| 1. ITKONEN JANIKA (SPF,FIN)         |
| 2. CHEPELEV SOFIA (SPF,FIN)         |
| 3. ALATALO ONERVA (JKS FINLAND,FIN) |
| 4. RISSANEN IINA (OM,FIN)           |
|                                     |
|                                     |
|                                     |

|           |  |  |  |
|-----------|--|--|--|
| Referees: |  |  |  |
|           |  |  |  |

# Tawastia Open Karate 2/2024

Liivuoentie 24, Hmeenlinna, FINLAND

|             |                                      |         |            |             |                                  |                |       |
|-------------|--------------------------------------|---------|------------|-------------|----------------------------------|----------------|-------|
| Court Nr.   | 1                                    | Pool    | 1          | Date        | 2024-10-06                       | Field Position | -9951 |
| <b>RED</b>  |                                      |         |            | <b>BLUE</b> |                                  |                |       |
| NOC         | CHEPELEV SOFIA (SPF,FIN)             |         |            | NOC         | ALATALO ONERVA (JKS FINLAND,FIN) |                |       |
| Category    | Kumite, tytt, U18, -53 kg yhdistetty |         |            |             |                                  |                |       |
| 3 Points    | 2 Points                             | 1 Point | Score      | 1 Point     | 2 Points                         | 3 Points       |       |
|             |                                      |         | 6 : 5      |             |                                  |                |       |
| Penatlity   |                                      |         |            | Penatlity   |                                  |                |       |
| C1: C1, C2: |                                      |         | <b>6:5</b> | C1: HC, C2: |                                  |                |       |
| WINNER      |                                      |         | Total      |             |                                  |                |       |

PTS

## Decision of Superiority

|         |         |         |         |         |         |         |         |
|---------|---------|---------|---------|---------|---------|---------|---------|
| Judge 1 | Judge 2 | Judge 3 | Judge 4 | Judge 5 | Judge 6 | Judge 7 | Referee |
|         |         |         |         |         |         |         |         |

Name

Signature

\_\_\_\_\_  
\_\_\_\_\_



# Tawastia Open Karate 2/2024

Liivuoentie 24, Hmeenlinna, FINLAND

|            |                                      |         |            |             |                        |                |       |
|------------|--------------------------------------|---------|------------|-------------|------------------------|----------------|-------|
| Court Nr.  | 1                                    | Pool    | 1          | Date        | 2024-10-06             | Field Position | -9950 |
| <b>RED</b> |                                      |         |            | <b>BLUE</b> |                        |                |       |
| NOC        | ITKONEN JANIKA (SPF,FIN)             |         |            | NOC         | RISSANEN IINA (OM,FIN) |                |       |
| Category   | Kumite, tytt, U18, -53 kg yhdistetty |         |            |             |                        |                |       |
| 3 Points   | 2 Points                             | 1 Point | Score      | 1 Point     | 2 Points               | 3 Points       |       |
|            |                                      |         | 3 : 0      |             |                        |                |       |
| Penatlity  |                                      |         |            | Penatlity   |                        |                |       |
| C1: , C2:  |                                      |         | <b>3:0</b> | C1: C2, C2: |                        |                |       |
| WINNER     |                                      |         | Total      |             |                        |                |       |

PTS

## Decision of Superiority

| Judge 1 | Judge 2 | Judge 3 | Judge 4 | Judge 5 | Judge 6 | Judge 7 | Referee |
|---------|---------|---------|---------|---------|---------|---------|---------|
|         |         |         |         |         |         |         |         |

Name

Signature

\_\_\_\_\_  
\_\_\_\_\_



# Tawastia Open Karate 2/2024

Liivuoentie 24, Hmeenlinna, FINLAND

|            |                                      |         |            |             |                          |                |       |
|------------|--------------------------------------|---------|------------|-------------|--------------------------|----------------|-------|
| Court Nr.  | 1                                    | Pool    | 1          | Date        | 2024-10-06               | Field Position | -9949 |
| <b>RED</b> |                                      |         |            | <b>BLUE</b> |                          |                |       |
| NOC        | CHEPELEV SOFIA (SPF,FIN)             |         |            | NOC         | ITKONEN JANIKA (SPF,FIN) |                |       |
| Category   | Kumite, tytt, U18, -53 kg yhdistetty |         |            |             |                          |                |       |
| 3 Points   | 2 Points                             | 1 Point | Score      | 1 Point     | 2 Points                 | 3 Points       |       |
|            |                                      |         | 0 : 5      |             |                          |                |       |
| Penatlity  |                                      |         |            | Penatlity   |                          |                |       |
| C1: , C2:  |                                      |         | <b>0:5</b> | C1: , C2:   |                          |                |       |
|            |                                      |         | Total      | WINNER      |                          |                |       |

PTS

## Decision of Superiority

| Judge 1 | Judge 2 | Judge 3 | Judge 4 | Judge 5 | Judge 6 | Judge 7 | Referee |
|---------|---------|---------|---------|---------|---------|---------|---------|
|         |         |         |         |         |         |         |         |

Name

Signature

\_\_\_\_\_  
\_\_\_\_\_



# Tawastia Open Karate 2/2024

Liivuoentie 24, Hmeenlinna, FINLAND

|             |                                      |         |            |             |                                  |                |       |
|-------------|--------------------------------------|---------|------------|-------------|----------------------------------|----------------|-------|
| Court Nr.   | 1                                    | Pool    | 1          | Date        | 2024-10-06                       | Field Position | -9948 |
| <b>RED</b>  |                                      |         |            | <b>BLUE</b> |                                  |                |       |
| NOC         | RISSANEN IINA (OM,FIN)               |         |            | NOC         | ALATALO ONERVA (JKS FINLAND,FIN) |                |       |
| Category    | Kumite, tytt, U18, -53 kg yhdistetty |         |            |             |                                  |                |       |
| 3 Points    | 2 Points                             | 1 Point | Score      | 1 Point     | 2 Points                         | 3 Points       |       |
|             |                                      |         | 2 : 3      |             |                                  |                |       |
| Penatlity   |                                      |         |            | Penatlity   |                                  |                |       |
| C1: C1, C2: |                                      |         | <b>2:3</b> | C1: , C2:   |                                  |                |       |
|             |                                      |         | Total      | WINNER      |                                  |                |       |

PTS

## Decision of Superiority

| Judge 1 | Judge 2 | Judge 3 | Judge 4 | Judge 5 | Judge 6 | Judge 7 | Referee |
|---------|---------|---------|---------|---------|---------|---------|---------|
|         |         |         |         |         |         |         |         |

Name

Signature

\_\_\_\_\_  
\_\_\_\_\_



# Tawastia Open Karate 2/2024

Liivuoentie 24, Hmeenlinna, FINLAND

|            |                                      |         |            |             |                        |                |       |
|------------|--------------------------------------|---------|------------|-------------|------------------------|----------------|-------|
| Court Nr.  | 1                                    | Pool    | 1          | Date        | 2024-10-06             | Field Position | -9947 |
| <b>RED</b> |                                      |         |            | <b>BLUE</b> |                        |                |       |
| NOC        | CHEPELEV SOFIA (SPF,FIN)             |         |            | NOC         | RISSANEN IINA (OM,FIN) |                |       |
| Category   | Kumite, tytt, U18, -53 kg yhdistetty |         |            |             |                        |                |       |
| 3 Points   | 2 Points                             | 1 Point | Score      | 1 Point     | 2 Points               | 3 Points       |       |
|            |                                      |         | 2 : 1      |             |                        |                |       |
| Penatlity  |                                      |         |            | Penatlity   |                        |                |       |
| C1: , C2:  |                                      |         | <b>2:1</b> | C1: , C2:   |                        |                |       |
| WINNER     |                                      |         | Total      |             |                        |                |       |

PTS

## Decision of Superiority

| Judge 1 | Judge 2 | Judge 3 | Judge 4 | Judge 5 | Judge 6 | Judge 7 | Referee |
|---------|---------|---------|---------|---------|---------|---------|---------|
|         |         |         |         |         |         |         |         |

Name

Signature

\_\_\_\_\_  
\_\_\_\_\_





# Tawastia Open Karate 2/2024

Liivuoentie 24, Hmeenlinna, FINLAND

|             |                                      |         |            |             |                          |                |       |
|-------------|--------------------------------------|---------|------------|-------------|--------------------------|----------------|-------|
| Court Nr.   | 1                                    | Pool    | 1          | Date        | 2024-10-06               | Field Position | -9946 |
| <b>RED</b>  |                                      |         |            | <b>BLUE</b> |                          |                |       |
| NOC         | ALATALO ONERVA (JKS FINLAND,FIN)     |         |            | NOC         | ITKONEN JANIKA (SPF,FIN) |                |       |
| Category    | Kumite, tytt, U18, -53 kg yhdistetty |         |            |             |                          |                |       |
| 3 Points    | 2 Points                             | 1 Point | Score      | 1 Point     | 2 Points                 | 3 Points       |       |
|             |                                      |         | 2 : 6      |             |                          |                |       |
| Penatlity   |                                      |         |            | Penatlity   |                          |                |       |
| C1: C1, C2: |                                      |         | <b>2:6</b> | C1: , C2:   |                          |                |       |
|             |                                      |         | Total      | WINNER      |                          |                |       |

PTS

## Decision of Superiority

| Judge 1 | Judge 2 | Judge 3 | Judge 4 | Judge 5 | Judge 6 | Judge 7 | Referee |
|---------|---------|---------|---------|---------|---------|---------|---------|
|         |         |         |         |         |         |         |         |





Name

Signature

\_\_\_\_\_  
\_\_\_\_\_



## Official Results

| Kumite, tytöt, U18, -53 kg yhdistetty |                 |  |   |               |
|---------------------------------------|-----------------|--|---|---------------|
| 1                                     | IITKONEN JANIKA | SPORTSKARATE.FI                              |  | FIN - FINLAND |
| 2                                     | CHEPELEV SOFIA  | SPORTSKARATE.FI                              |  | FIN - FINLAND |
| 3                                     | ALATALO ONERVA  | JKS FINLAND -<br>SHOTOKAN KARATE<br>HELSINKI |  | FIN - FINLAND |
| 4                                     | RISSANEN IINA   | SPORTSKARATE<br>KUOPIO                       |  | FIN - FINLAND |

# TEKNIikka U10

Tawastia Open Karate 2/2024

**ENTRIES BY WEIGHT CATEGORY**  
**TEKNIikka U10**

As of 6 OCT 2024

| Country Code | ID | Gender | Name        | Seeding |
|--------------|----|--------|-------------|---------|
| FIN          |    | F      | Elpi Amelia |         |
| FIN          |    | F      | Haven Eevi  |         |
| FIN          |    | M      | Repo Leo    |         |

# TEKNIKKA U10 - Round Robin (each against each)

Tawastia Open Karate 2/2024, Liivuaurentie 24, Hämeenlinna, FIN









2024-10-05

Tatami

1 10:50

Pool

1/1

|   |  |   |
|---|--|---|
| 1 |  Haven Eevi (LK-FIN,FIN)   |   |
|   |  | 5    Haven Eevi (LK-FIN,FIN)   |
| 2 |  Elpiö Amelia (LK-FIN,FIN) |   |
|   |  | 4   |
| 3 |  Haven Eevi (LK-FIN,FIN)   |   |
|   |  | 7    Haven Eevi (LK-FIN,FIN)   |
| 4 |  Repo Leo (LK-FIN,FIN)     |   |
|   |  | 5   |
| 5 |  Elpiö Amelia (LK-FIN,FIN) |   |
|   |  | 5    Elpiö Amelia (LK-FIN,FIN) |
| 6 |  Repo Leo (LK-FIN,FIN)     |   |
|   |  | 3   |



|                              |
|------------------------------|
| 1. HAVEN EEVI (LK-FIN,FIN)   |
| 2. ELPIÖ AMELIA (LK-FIN,FIN) |
| 3. REPO LEO (LK-FIN,FIN)     |
|                              |
|                              |
|                              |
|                              |

|           |  |  |  |
|-----------|--|--|--|
| Referees: |  |  |  |
|           |  |  |  |

# Tawastia Open Karate 2/2024

Liivuoentie 24, Hmeenlinna, FINLAND

|            |                         |         |            |             |                          |                |       |
|------------|-------------------------|---------|------------|-------------|--------------------------|----------------|-------|
| Court Nr.  | 1                       | Pool    | 1          | Date        | 2024-10-06               | Field Position | -9951 |
| <b>RED</b> |                         |         |            | <b>BLUE</b> |                          |                |       |
| NOC        | HAVEN EEVI (LK-FIN,FIN) |         |            | NOC         | ELPI AMELIA (LK-FIN,FIN) |                |       |
| Category   | TEKNIikka U10           |         |            |             |                          |                |       |
| 3 Points   | 2 Points                | 1 Point | Score      | 1 Point     | 2 Points                 | 3 Points       |       |
|            |                         |         | 5 : 4      |             |                          |                |       |
| Penatlity  |                         |         |            | Penatlity   |                          |                |       |
| C1: , C2:  |                         |         | <b>5:4</b> | C1: , C2:   |                          |                |       |
| WINNER     |                         |         | Total      |             |                          |                |       |

PTS

## Decision of Superiority

| Judge 1 | Judge 2 | Judge 3 | Judge 4 | Judge 5 | Judge 6 | Judge 7 | Referee |
|---------|---------|---------|---------|---------|---------|---------|---------|
|         |         |         |         |         |         |         |         |

Name \_\_\_\_\_

Signature \_\_\_\_\_



# Tawastia Open Karate 2/2024

Liivuoentie 24, Hmeenlinna, FINLAND

|            |                         |         |            |             |                       |                |       |
|------------|-------------------------|---------|------------|-------------|-----------------------|----------------|-------|
| Court Nr.  | 1                       | Pool    | 1          | Date        | 2024-10-06            | Field Position | -9950 |
| <b>RED</b> |                         |         |            | <b>BLUE</b> |                       |                |       |
| NOC        | HAVEN EEVI (LK-FIN,FIN) |         |            | NOC         | REPO LEO (LK-FIN,FIN) |                |       |
| Category   | TEKNIikka U10           |         |            |             |                       |                |       |
| 3 Points   | 2 Points                | 1 Point | Score      | 1 Point     | 2 Points              | 3 Points       |       |
|            |                         |         | 7 : 5      |             |                       |                |       |
| Penatlity  |                         |         |            | Penatlity   |                       |                |       |
| C1: , C2:  |                         |         | <b>7:5</b> | C1: , C2:   |                       |                |       |
| WINNER     |                         |         | Total      |             |                       |                |       |

PTS

## Decision of Superiority

| Judge 1 | Judge 2 | Judge 3 | Judge 4 | Judge 5 | Judge 6 | Judge 7 | Referee |
|---------|---------|---------|---------|---------|---------|---------|---------|
|         |         |         |         |         |         |         |         |

Name \_\_\_\_\_

Signature \_\_\_\_\_



# Tawastia Open Karate 2/2024

Liivuoentie 24, Hmeenlinna, FINLAND

|            |                          |         |            |             |                       |                |       |
|------------|--------------------------|---------|------------|-------------|-----------------------|----------------|-------|
| Court Nr.  | 1                        | Pool    | 1          | Date        | 2024-10-06            | Field Position | -9949 |
| <b>RED</b> |                          |         |            | <b>BLUE</b> |                       |                |       |
| NOC        | ELPI AMELIA (LK-FIN,FIN) |         |            | NOC         | REPO LEO (LK-FIN,FIN) |                |       |
| Category   | TEKNIikka U10            |         |            |             |                       |                |       |
| 3 Points   | 2 Points                 | 1 Point | Score      | 1 Point     | 2 Points              | 3 Points       |       |
|            |                          |         | 5 : 3      |             |                       |                |       |
| Penatlity  |                          |         |            | Penatlity   |                       |                |       |
| C1: , C2:  |                          |         | <b>5:3</b> | C1: , C2:   |                       |                |       |
| WINNER     |                          |         | Total      |             |                       |                |       |

PTS

## Decision of Superiority

| Judge 1 | Judge 2 | Judge 3 | Judge 4 | Judge 5 | Judge 6 | Judge 7 | Referee |
|---------|---------|---------|---------|---------|---------|---------|---------|
|         |         |         |         |         |         |         |         |

Name \_\_\_\_\_



Signature \_\_\_\_\_





Tawastia Open Karate 2/2024 - 2024-10-05

Official Results

| TEKNIikka U10 |              |               |   |               |
|---------------|--------------|---------------|---|---------------|
| 1             | HAVEN EEVI   | LAHDEN KARATE |  | FIN - FINLAND |
| 2             | ELPIÖ AMELIA | LAHDEN KARATE |  | FIN - FINLAND |
| 3             | REPO LEO     | LAHDEN KARATE |  | FIN - FINLAND |

# TEKNIikka U14 YHDISTETTY

Tawastia Open Karate 2/2024

**ENTRIES BY WEIGHT CATEGORY**  
**TEKNIikka U14 yhdistetty**

As of 6 OCT 2024

| Country Code | ID | Gender | Name           | Seeding |
|--------------|----|--------|----------------|---------|
| FIN          |    | M      | Kekki Akseli   |         |
| FIN          |    | F      | Pirinen Mila   |         |
| FIN          |    | F      | Salminen Wenla |         |
| FIN          |    | F      | Sova Elina     |         |

# TEKNIikka U14 yhdistetty - Round Robin (each against each)

Tawastia Open Karate 2/2024, Liivourentie 24, Hämeenlinna, FIN



















2024-10-05

Tatami

1 10:55

Pool

1/1

|    |  |   |   |
|----|--|---|---|
| 1  |  Kekki Akseli (LK-FIN,FIN)     | 3 |  Sova Elina (HKS,FIN)        |
| 2  |  Sova Elina (HKS,FIN)          | 5 |   |
| 3  |  Salminen Wenla (LK-FIN,FIN)   | 3 |  Pirinen Mila (HKS,FIN)      |
| 4  |  Pirinen Mila (HKS,FIN)        | 5 |   |
| 5  |  Kekki Akseli (LK-FIN,FIN)     | 5 |  Salminen Wenla (LK-FIN,FIN) |
| 6  |  Salminen Wenla (LK-FIN,FIN)   | 8 |   |
| 7  |  Pirinen Mila (HKS,FIN)        | 9 |  Pirinen Mila (HKS,FIN)      |
| 8  |  Sova Elina (HKS,FIN)          | 8 |   |
| 9  |  Kekki Akseli (LK-FIN,FIN)    | 5 |  Pirinen Mila (HKS,FIN)    |
| 10 |  Pirinen Mila (HKS,FIN)      | 8 |   |
| 11 |  Sova Elina (HKS,FIN)        | 4 |  Sova Elina (HKS,FIN)      |
| 12 |  Salminen Wenla (LK-FIN,FIN) | 4 |   |



|                                |
|--------------------------------|
| 1. PIRINEN MILA (HKS,FIN)      |
| 2. SOVA ELINA (HKS,FIN)        |
| 3. SALMINEN WENLA (LK-FIN,FIN) |
| 4. KEKKI AKSELI (LK-FIN,FIN)   |
|                                |
|                                |
|                                |

|           |  |  |  |
|-----------|--|--|--|
| Referees: |  |  |  |
|           |  |  |  |

# Tawastia Open Karate 2/2024

Liivuoentie 24, Hmeenlinna, FINLAND

|            |                           |         |            |             |                      |                |       |
|------------|---------------------------|---------|------------|-------------|----------------------|----------------|-------|
| Court Nr.  | 1                         | Pool    | 1          | Date        | 2024-10-06           | Field Position | -9951 |
| <b>RED</b> |                           |         |            | <b>BLUE</b> |                      |                |       |
| NOC        | KEKKI AKSELI (LK-FIN,FIN) |         |            | NOC         | SOVA ELINA (HKS,FIN) |                |       |
| Category   | TEKNIikka U14 yhdistetty  |         |            |             |                      |                |       |
| 3 Points   | 2 Points                  | 1 Point | Score      | 1 Point     | 2 Points             | 3 Points       |       |
|            |                           |         | 3 : 5      |             |                      |                |       |
| Penatlity  |                           |         |            | Penatlity   |                      |                |       |
| C1: , C2:  |                           |         | <b>3:5</b> | C1: , C2:   |                      |                |       |
|            |                           |         | Total      | WINNER      |                      |                |       |

PTS

## Decision of Superiority

| Judge 1 | Judge 2 | Judge 3 | Judge 4 | Judge 5 | Judge 6 | Judge 7 | Referee |
|---------|---------|---------|---------|---------|---------|---------|---------|
|         |         |         |         |         |         |         |         |

Name

Signature

\_\_\_\_\_  
\_\_\_\_\_



# Tawastia Open Karate 2/2024

Liivuoentie 24, Hmeenlinna, FINLAND

|            |                             |         |            |             |                        |                |       |
|------------|-----------------------------|---------|------------|-------------|------------------------|----------------|-------|
| Court Nr.  | 1                           | Pool    | 1          | Date        | 2024-10-06             | Field Position | -9950 |
| <b>RED</b> |                             |         |            | <b>BLUE</b> |                        |                |       |
| NOC        | SALMINEN WENLA (LK-FIN,FIN) |         |            | NOC         | PIRINEN MILA (HKS,FIN) |                |       |
| Category   | TEKNIikka U14 yhdistetty    |         |            |             |                        |                |       |
| 3 Points   | 2 Points                    | 1 Point | Score      | 1 Point     | 2 Points               | 3 Points       |       |
|            |                             |         | 3 : 5      |             |                        |                |       |
| Penatlity  |                             |         |            | Penatlity   |                        |                |       |
| C1: , C2:  |                             |         | <b>3:5</b> | C1: , C2:   |                        |                |       |
|            |                             |         | Total      | WINNER      |                        |                |       |

PTS

## Decision of Superiority

| Judge 1 | Judge 2 | Judge 3 | Judge 4 | Judge 5 | Judge 6 | Judge 7 | Referee |
|---------|---------|---------|---------|---------|---------|---------|---------|
|         |         |         |         |         |         |         |         |

Name

Signature

\_\_\_\_\_  
\_\_\_\_\_



# Tawastia Open Karate 2/2024

Liivourentie 24, Hmeenlinna, FINLAND

|            |                           |         |            |             |                             |                |       |
|------------|---------------------------|---------|------------|-------------|-----------------------------|----------------|-------|
| Court Nr.  | 1                         | Pool    | 1          | Date        | 2024-10-06                  | Field Position | -9949 |
| <b>RED</b> |                           |         |            | <b>BLUE</b> |                             |                |       |
| NOC        | KEKKI AKSELI (LK-FIN,FIN) |         |            | NOC         | SALMINEN WENLA (LK-FIN,FIN) |                |       |
| Category   | TEKNIIKKA U14 yhdistetty  |         |            |             |                             |                |       |
| 3 Points   | 2 Points                  | 1 Point | Score      | 1 Point     | 2 Points                    | 3 Points       |       |
|            |                           |         | 5 : 8      |             |                             |                |       |
| Penatlity  |                           |         |            | Penatlity   |                             |                |       |
| C1: , C2:  |                           |         | <b>5:8</b> | C1: , C2:   |                             |                |       |
|            |                           |         | Total      | WINNER      |                             |                |       |

PTS

## Decision of Superiority

|         |         |         |         |         |         |         |         |
|---------|---------|---------|---------|---------|---------|---------|---------|
| Judge 1 | Judge 2 | Judge 3 | Judge 4 | Judge 5 | Judge 6 | Judge 7 | Referee |
|         |         |         |         |         |         |         |         |

Name

Signature

\_\_\_\_\_  
\_\_\_\_\_



# Tawastia Open Karate 2/2024

Liivuoentie 24, Hmeenlinna, FINLAND

|            |                          |         |            |             |                      |                |       |
|------------|--------------------------|---------|------------|-------------|----------------------|----------------|-------|
| Court Nr.  | 1                        | Pool    | 1          | Date        | 2024-10-06           | Field Position | -9948 |
| <b>RED</b> |                          |         |            | <b>BLUE</b> |                      |                |       |
| NOC        | PIRINEN MILA (HKS,FIN)   |         |            | NOC         | SOVA ELINA (HKS,FIN) |                |       |
| Category   | TEKNIikka U14 yhdistetty |         |            |             |                      |                |       |
| 3 Points   | 2 Points                 | 1 Point | Score      | 1 Point     | 2 Points             | 3 Points       |       |
|            |                          |         | 9 : 8      |             |                      |                |       |
| Penatlity  |                          |         |            | Penatlity   |                      |                |       |
| C1: , C2:  |                          |         | <b>9:8</b> | C1: , C2:   |                      |                |       |
| WINNER     |                          |         | Total      |             |                      |                |       |

PTS

## Decision of Superiority

| Judge 1 | Judge 2 | Judge 3 | Judge 4 | Judge 5 | Judge 6 | Judge 7 | Referee |
|---------|---------|---------|---------|---------|---------|---------|---------|
|         |         |         |         |         |         |         |         |

Name

Signature

\_\_\_\_\_  
\_\_\_\_\_





# Tawastia Open Karate 2/2024

Liivuoentie 24, Hmeenlinna, FINLAND

|            |                           |         |            |             |                        |                |       |
|------------|---------------------------|---------|------------|-------------|------------------------|----------------|-------|
| Court Nr.  | 1                         | Pool    | 1          | Date        | 2024-10-06             | Field Position | -9947 |
| <b>RED</b> |                           |         |            | <b>BLUE</b> |                        |                |       |
| NOC        | KEKKI AKSELI (LK-FIN,FIN) |         |            | NOC         | PIRINEN MILA (HKS,FIN) |                |       |
| Category   | TEKNIikka U14 yhdistetty  |         |            |             |                        |                |       |
| 3 Points   | 2 Points                  | 1 Point | Score      | 1 Point     | 2 Points               | 3 Points       |       |
|            |                           |         | 5 : 8      |             |                        |                |       |
| Penatlity  |                           |         |            | Penatlity   |                        |                |       |
| C1: , C2:  |                           |         | <b>5:8</b> | C1: , C2:   |                        |                |       |
|            |                           |         | Total      | WINNER      |                        |                |       |

PTS

## Decision of Superiority

| Judge 1 | Judge 2 | Judge 3 | Judge 4 | Judge 5 | Judge 6 | Judge 7 | Referee |
|---------|---------|---------|---------|---------|---------|---------|---------|
|         |         |         |         |         |         |         |         |

Name

Signature

\_\_\_\_\_  
\_\_\_\_\_



# Tawastia Open Karate 2/2024

Liivuoentie 24, Hmeenlinna, FINLAND

|            |                          |         |            |             |                             |                |       |
|------------|--------------------------|---------|------------|-------------|-----------------------------|----------------|-------|
| Court Nr.  | 1                        | Pool    | 1          | Date        | 2024-10-06                  | Field Position | -9946 |
| <b>RED</b> |                          |         |            | <b>BLUE</b> |                             |                |       |
| NOC        | SOVA ELINA (HKS,FIN)     |         |            | NOC         | SALMINEN WENLA (LK-FIN,FIN) |                |       |
| Category   | TEKNIikka U14 yhdistetty |         |            |             |                             |                |       |
| 3 Points   | 2 Points                 | 1 Point | Score      | 1 Point     | 2 Points                    | 3 Points       |       |
|            |                          |         | 4 : 4      |             |                             |                |       |
| Penatlity  |                          |         |            | Penatlity   |                             |                |       |
| C1: , C2:  |                          |         | <b>4:4</b> | C1: , C2:   |                             |                |       |
| WINNER     |                          |         | Total      |             |                             |                |       |

HT

## Decision of Superiority

| Judge 1 | Judge 2 | Judge 3 | Judge 4 | Judge 5 | Judge 6 | Judge 7 | Referee |
|---------|---------|---------|---------|---------|---------|---------|---------|
|         |         |         |         |         |         |         |         |





Name

Signature

\_\_\_\_\_  
\_\_\_\_\_



## Official Results

| TEKNIikka U14 yhdistetty |                |                             |   |               |
|--------------------------|----------------|-----------------------------|---|---------------|
| 1                        | PIRINEN MILA   | HÄMEENLINNAN<br>KARATESEURA |  | FIN - FINLAND |
| 2                        | SOVA ELINA     | HÄMEENLINNAN<br>KARATESEURA |  | FIN - FINLAND |
| 3                        | SALMINEN WENLA | LAHDEN KARATE               |  | FIN - FINLAND |
| 4                        | KEKKI AKSELI   | LAHDEN KARATE               |  | FIN - FINLAND |

# TEKNIikka U9 YHDISTETTY

Tawastia Open Karate 2/2024

**ENTRIES BY WEIGHT CATEGORY**  
**Tekniikka U9 yhdistetty**

As of 6 OCT 2024

| Country Code | ID | Gender | Name                | Seeding |
|--------------|----|--------|---------------------|---------|
| FIN          |    | F      | Abdelmoaty Jasmiina |         |
| FIN          |    | F      | Bhogadi Sreshta     |         |
| FIN          |    | F      | Hakala Helena       |         |

# Tekniikka U9 yhdistetty - Round Robin (each against each)

Tawastia Open Karate 2/2024, Liivuoentie 24, Hämeenlinna, FIN









2024-10-05

Tatami

1 10:45

Pool

1/1

- 1  Bhogadi Sreshta (Karate Hervanta,FIN)  
1  Abdelmoaty Jasmiina (HKS,FIN)
- 2  Abdelmoaty Jasmiina (HKS,FIN)  
3
- 3  Bhogadi Sreshta (Karate Hervanta,FIN)  
2  Hakala Helena (HKS,FIN)
- 4  Hakala Helena (HKS,FIN)  
3
- 5  Abdelmoaty Jasmiina (HKS,FIN)  
7  Abdelmoaty Jasmiina (HKS,FIN)
- 6  Hakala Helena (HKS,FIN)  
3



|  |
|--|
| 1. ABDELMOATY JASMIINA (HKS,FIN)         |
| 2. HAKALA HELENA (HKS,FIN)               |
| 3. BHOGADI SRESHTA (KARATE HERVANTA,FIN) |
|  |
|  |
|  |
|  |

|           |  |  |  |
|-----------|--|--|--|
| Referees: |  |  |  |
|           |  |  |  |

# Tawastia Open Karate 2/2024

Liivuoentie 24, Hmeenlinna, FINLAND

|            |  |         |            |             |                               |                |       |
|------------|--|---------|------------|-------------|-------------------------------|----------------|-------|
| Court Nr.  | 1                                      | Pool    | 1          | Date        | 2024-10-06                    | Field Position | -9951 |
| <b>RED</b> |  |         |            | <b>BLUE</b> |                               |                |       |
| NOC        | BHO GADI SRESHTA (KARATE HERVANTA,FIN) |         |            | NOC         | ABDELMOATY JASMIINA (HKS,FIN) |                |       |
| Category   | Tekniikka U9 yhdistetty                |         |            |             |                               |                |       |
| 3 Points   | 2 Points                               | 1 Point | Score      | 1 Point     | 2 Points                      | 3 Points       |       |
|            |  |         | 1 : 3      |             |                               |                |       |
| Penatlity  |  |         |            | Penatlity   |                               |                |       |
| C1: , C2:  |  |         | <b>1:3</b> | C1: , C2:   |                               |                |       |
|            |  |         | Total      | WINNER      |                               |                |       |

PTS

## Decision of Superiority

| Judge 1 | Judge 2 | Judge 3 | Judge 4 | Judge 5 | Judge 6 | Judge 7 | Referee |
|---------|---------|---------|---------|---------|---------|---------|---------|
|         |         |         |         |         |         |         |         |

Name

Signature

\_\_\_\_\_  
\_\_\_\_\_



# Tawastia Open Karate 2/2024

Liivuoentie 24, Hmeenlinna, FINLAND

|            |  |         |            |             |                         |                |       |
|------------|--|---------|------------|-------------|-------------------------|----------------|-------|
| Court Nr.  | 1                                      | Pool    | 1          | Date        | 2024-10-06              | Field Position | -9950 |
| <b>RED</b> |  |         |            | <b>BLUE</b> |                         |                |       |
| NOC        | BHO GADI SRESHTA (KARATE HERVANTA,FIN) |         |            | NOC         | HAKALA HELENA (HKS,FIN) |                |       |
| Category   | Tekniikka U9 yhdistetty                |         |            |             |                         |                |       |
| 3 Points   | 2 Points                               | 1 Point | Score      | 1 Point     | 2 Points                | 3 Points       |       |
|            |  |         | 2 : 3      |             |                         |                |       |
| Penatlity  |  |         |            | Penatlity   |                         |                |       |
| C1: , C2:  |  |         | <b>2:3</b> | C1: , C2:   |                         |                |       |
|            |  |         | Total      | WINNER      |                         |                |       |

PTS

## Decision of Superiority

| Judge 1 | Judge 2 | Judge 3 | Judge 4 | Judge 5 | Judge 6 | Judge 7 | Referee |
|---------|---------|---------|---------|---------|---------|---------|---------|
|         |         |         |         |         |         |         |         |

Name

Signature

\_\_\_\_\_  
\_\_\_\_\_





# Tawastia Open Karate 2/2024

Liivuoentie 24, Hmeenlinna, FINLAND

|            |                               |         |            |             |                         |                |       |
|------------|-------------------------------|---------|------------|-------------|-------------------------|----------------|-------|
| Court Nr.  | 1                             | Pool    | 1          | Date        | 2024-10-06              | Field Position | -9949 |
| <b>RED</b> |                               |         |            | <b>BLUE</b> |                         |                |       |
| NOC        | ABDELMOATY JASMIINA (HKS,FIN) |         |            | NOC         | HAKALA HELENA (HKS,FIN) |                |       |
| Category   | Tekniikka U9 yhdistetty       |         |            |             |                         |                |       |
| 3 Points   | 2 Points                      | 1 Point | Score      | 1 Point     | 2 Points                | 3 Points       |       |
|            |                               |         | 7 : 3      |             |                         |                |       |
| Penatlity  |                               |         |            | Penatlity   |                         |                |       |
| C1: , C2:  |                               |         | <b>7:3</b> | C1: , C2:   |                         |                |       |
| WINNER     |                               |         | Total      |             |                         |                |       |

PTS

## Decision of Superiority

| Judge 1 | Judge 2 | Judge 3 | Judge 4 | Judge 5 | Judge 6 | Judge 7 | Referee |
|---------|---------|---------|---------|---------|---------|---------|---------|
|         |         |         |         |         |         |         |         |

Name



Signature

\_\_\_\_\_  
\_\_\_\_\_







Tawastia Open Karate 2/2024 - 2024-10-05



Official Results



| Tekniikka U9 yhdistetty |                     |                             |   |               |  |
|-------------------------|---------------------|-----------------------------|---|---------------|--|
| 1                       | ABDELMOATY JASMIINA | HÄMEENLINNAN<br>KARATESEURA |  | FIN - FINLAND |  |
| 2                       | HAKALA HELENA       | HÄMEENLINNAN<br>KARATESEURA |  | FIN - FINLAND |  |
| 3                       | BHOGADI SRESHTA     | SHOTOKAN<br>HERVANTA RY     |  | FIN - FINLAND |  |



## Official Results



| KATA, MIEHET |                   |  |   |               |
|--------------|-------------------|--|---|---------------|
| 1            | KAMAMOTO KEISHIRO | JKS FINLAND - SHOTOKAN KARATE HELSINKI |  | FIN - FINLAND |
| 2            | OINONEN VILLE     | OUTOKUMMUN KARATESEURA RY              |  | FIN - FINLAND |
| 3            | TAKALA AKSELI     | OULUN KARATESEURA                      |  | FIN - FINLAND |
| 4            | HÄRKÖNEN JARNO    | OUTOKUMMUN KARATESEURA RY              |  | FIN - FINLAND |
| 5            | JÄRVINEN OTSO     | JAPAN KARATE ASSOCIATION TAMPERE RY    |  | FIN - FINLAND |
| 5            | BOKE ERKAN        | JKS FINLAND - SHOTOKAN KARATE HELSINKI |  | FIN - FINLAND |

| KATA, NAISET |                |  |   |               |
|--------------|----------------|--|---|---------------|
| 1            | LEHTINEN NEA   | LAHDEN KARATE                          |    | FIN - FINLAND |
| 2            | HINTIKKA MARIA | JAPAN KARATE ASSOCIATION TAMPERE RY    |    | FIN - FINLAND |
| 3            | ALATALO ONERVA | JKS FINLAND - SHOTOKAN KARATE HELSINKI |   | FIN - FINLAND |
| 4            | YAMATE SAKINO  | JKS FINLAND - SHOTOKAN KARATE HELSINKI |  | FIN - FINLAND |







| KUMITE, POJAT, VALKOISET JA KELTAISET U8 |                |                   |   |               |
|--|----------------|-------------------|---|---------------|
| 1  | TEJESVI VIVAAN | OULUN KARATESEURA |  | FIN - FINLAND |
| 2  | TEPPO VÄINÖ    | JIGOTAI KARATE    |  | FIN - FINLAND |
| 3  | TEPPO EINO     | JIGOTAI KARATE    |  | FIN - FINLAND |

| Kata, miehet, +35-vuotiaat |                    |  |   |               |
|----------------------------|--------------------|--|---|---------------|
| 1                          | OINONEN VILLE      | OUTOKUMMUN KARATESEURA RY              |  | FIN - FINLAND |
| 2                          | HÄRKÖNEN JARNO     | OUTOKUMMUN KARATESEURA RY              |  | FIN - FINLAND |
| 3                          | CASCI GIANGABRIELE | JKS FINLAND - SHOTOKAN KARATE HELSINKI |  | FIN - FINLAND |

| Kata, miehet, U21 |               |                          |   |               |
|-------------------|---------------|--------------------------|---|---------------|
| 1                 | TAKALA AKSELI | OULUN KARATESEURA        |  | FIN - FINLAND |
| 2                 | MANTERE JIMI  | HÄMEENLINNAN KARATESEURA |  | FIN - FINLAND |







| Kata, naiset, U21 |              |                                     |   |               |
|-------------------|--------------|-------------------------------------|---|---------------|
| 1                 | LEHTINEN NEA | LAHDEN KARATE                       |  | FIN - FINLAND |
| 2                 | LANTTA WIIVI | JAPAN KARATE ASSOCIATION TAMPERE RY |  | FIN - FINLAND |





## Official Results

| Kata, pojat, U12 |                  |                      |   |               |
|------------------|------------------|----------------------|---|---------------|
| 1                | TEJESVI SHASHANK | OULUN KARATESEURA    |  | FIN - FINLAND |
| 2                | PALUKURU RONITH  | SHOTOKAN HERVANTA RY |  | FIN - FINLAND |
| 3                | KANERVA NIILLO   | LAHDEN KARATE        |  | FIN - FINLAND |
| 4                | ROIHUPALO LEO    | PORIN SHOTOKAN       |  | FIN - FINLAND |
| 5                | SIIVONEN KIMI    | PORIN SHOTOKAN       |  | FIN - FINLAND |
| 5                | VALVE VERNERI    | PORIN SHOTOKAN       |  | FIN - FINLAND |



| Kata, pojat, U14 |                    |  |   |               |
|------------------|--------------------|--|---|---------------|
| 1                | KELLA KASPERI      | LAHDEN KARATE                          |    | FIN - FINLAND |
| 2                | HANNU EERO         | OULUN KARATESEURA                      |    | FIN - FINLAND |
| 3                | LARKIN TAKEHIRO    | JKS FINLAND - SHOTOKAN KARATE HELSINKI |    | FIN - FINLAND |
| 4                | SIHVONEN EEMIL     | LAHDEN KARATE                          |    | FIN - FINLAND |
| 5                | NOROUZI ARASH LEON | JKS FINLAND - SHOTOKAN KARATE HELSINKI |    | FIN - FINLAND |
| 5                | SÄIPPÄ EMIL        | TAPANILAN ERÄ                          |    | FIN - FINLAND |
| 7                | PULLIAINEN MATIAS  | HYVINKÄÄN SHOTOKAN KARATE RY           |   | FIN - FINLAND |
| 7                | KALLIOMÄKI VILJAMI | PORIN SHOTOKAN                         |  | FIN - FINLAND |





| Kata, pojat, U16 |                   |                   |   |               |
|------------------|-------------------|-------------------|---|---------------|
| 1                | HUUSKONEN VEETI   | LAHDEN KARATE     |  | FIN - FINLAND |
| 2                | KIVIKOSKI JERE    | LAHDEN KARATE     |  | FIN - FINLAND |
| 3                | LÄHETKANGAS LUKA  | OULUN KARATESEURA |  | FIN - FINLAND |
| 4                | KIVIMÄKI VEIKKO   | LAHDEN KARATE     |  | FIN - FINLAND |
| 5                | TKACHENKO TIMOFEI | JIGOTAI KARATE    |  | FIN - FINLAND |
| 5                | TARKKANEN OTSO    | JIGOTAI KARATE    |  | FIN - FINLAND |
| 7                | GAETTI LUCAS      | PORIN SHOTOKAN    |  | FIN - FINLAND |



| Kata, pojat, valk-kelt, U10 |                   |                      |   |               |
|-----------------------------|-------------------|----------------------|---|---------------|
| 1                           | HAAKANA SISU      | LAHDEN KARATE        |  | FIN - FINLAND |
| 2                           | JOUKAINEN JUSTUS  | LAHDEN KARATE        |  | FIN - FINLAND |
| 3                           | ZAFAR AHMED HASAN | SHOTOKAN HERVANTA RY |  | FIN - FINLAND |
| 4                           | CASTRÉN OSSI      | LAHDEN KARATE        |  | FIN - FINLAND |
| 5                           | REPO LEO          | LAHDEN KARATE        |  | FIN - FINLAND |
| 5                           | TUOMISALO RASMUS  | LAHDEN KARATE        |  | FIN - FINLAND |







| Kata, pojat, valk-kelt, U12 |                  |                      |   |               |
|-----------------------------|------------------|----------------------|---|---------------|
| 1                           | HIETAVA ANTON    | PORIN SHOTOKAN       |  | FIN - FINLAND |
| 2                           | VÄNTTINEN ALEKSI | LAHDEN KARATE        |  | FIN - FINLAND |
| 3                           | KEKKI AKSELI     | LAHDEN KARATE        |  | FIN - FINLAND |
| 4                           | ZIA AHMED HAMZA  | SHOTOKAN HERVANTA RY |  | FIN - FINLAND |







## Official Results

| Kata, pojat, valkoiset, U8 |                |                      |   |               |
|----------------------------|----------------|----------------------|---|---------------|
| 1                          | TEJESVI VIVAAN | OULUN<br>KARATESEURA |  | FIN - FINLAND |
| 2                          | TEPPO EINO     | JIGOTAI KARATE       |  | FIN - FINLAND |
| 3                          | TEPPO VÄINÖ    | JIGOTAI KARATE       |  | FIN - FINLAND |

| Kata, tytöt valk-kelt, U14 |                     |   |   |               |
|----------------------------|---------------------|---|---|---------------|
| 1                          | COMAN ANASTASIA     | JAPAN KARATE<br>ASSOCIATION<br>TAMPERE RY |  | FIN - FINLAND |
| 2                          | SOVA ELINA          | HÄMEENLINNAN<br>KARATESEURA               |  | FIN - FINLAND |
| 3                          | PIRINEN MILA        | HÄMEENLINNAN<br>KARATESEURA               |  | FIN - FINLAND |
| 4                          | HAMEEDA AHMED AISHA | SHOTOKAN<br>HERVANTA RY                   |  | FIN - FINLAND |





| Kata, tytöt, U10 |                 |                         |   |               |
|------------------|-----------------|-------------------------|---|---------------|
| 1                | MAKSYMUK ULIANA | MAKSYMUK                |  | FIN - FINLAND |
| 2                | KORHONEN MEERI  | KORHONEN                |  | FIN - FINLAND |
| 3                | BATIKERU LAASYA | SHOTOKAN<br>HERVANTA RY |  | FIN - FINLAND |







| Kata, tytöt, U12 |                   |   |   |               |
|------------------|-------------------|---|---|---------------|
| 1                | ARUN IISHA        | SHOTOKAN<br>HERVANTA RY                   |  | FIN - FINLAND |
| 2                | VENERANTA CECILIA | PORIN SHOTOKAN                            |  | FIN - FINLAND |
| 3                | KOSKELA JASMIN    | PORIN SHOTOKAN                            |  | FIN - FINLAND |
| 4                | ANBAR HIBA        | SHOTOKAN<br>HERVANTA RY                   |  | FIN - FINLAND |
| 5                | NUHANOVIC AMINA   | JAPAN KARATE<br>ASSOCIATION<br>TAMPERE RY |  | FIN - FINLAND |
| 5                | MAKSYMUK POLINA   | MAKSYMUK                                  |  | FIN - FINLAND |
| 7                | HEINO LILYA       | TAPANILAN ERÄ                             |  | FIN - FINLAND |
| 7                | NASKALI JATTA     | HÄMEENLINNAN<br>KARATESEURA               |  | FIN - FINLAND |

| Kata, tytöt, U14 |                   |  |   |               |
|------------------|-------------------|--|---|---------------|
| 1                | STEFANSKI VANESSA | LAHDEN KARATE                                |  | FIN - FINLAND |
| 2                | ALATALO VANAMO    | JKS FINLAND -<br>SHOTOKAN KARATE<br>HELSINKI |  | FIN - FINLAND |
| 3                | ORTIZ ANTONIA     | JKS FINLAND -<br>SHOTOKAN KARATE<br>HELSINKI |  | FIN - FINLAND |
| 4                | PÖYHÖNEN IIDA     | LAHDEN KARATE                                |  | FIN - FINLAND |
| 5                | RIIMALA SEELA     | JIGOTAI KARATE                               |  | FIN - FINLAND |
| 5                | HEINO DAISY       | TAPANILAN ERÄ                                |  | FIN - FINLAND |
| 7                | SEMBER VIVI       | VANTAAN WADO RYU<br>RY                       |  | FIN - FINLAND |

## Official Results



| Kata, tytöt, U16 |                |                                    |   |               |  |
|------------------|----------------|------------------------------------|---|---------------|--|
| 1                | WANIC MARIE    | SHUYOKAI<br>SHOTOKAN KARATE-<br>DO |  | FIN - FINLAND |  |
| 2                | KUUSI NIKA     | HÄMEENLINNAN<br>KARATESEURA        |  | FIN - FINLAND |  |
| 3                | HANNU ALVA     | OULUN<br>KARATESEURA               |  | FIN - FINLAND |  |
| 4                | TEMONEN HILMA  | LAHDEN KARATE                      |  | FIN - FINLAND |  |
| 5                | AHONEN VENLA   | LAHDEN KARATE                      |  | FIN - FINLAND |  |
| 5                | KORPELA SIIRI  | OULUN<br>KARATESEURA               |  | FIN - FINLAND |  |
| 7                | LINDSTRÖM MERI | LAHDEN KARATE                      |  | FIN - FINLAND |  |
| 7                | TAMMELA IITU   | HÄMEENLINNAN<br>KARATESEURA        |  | FIN - FINLAND |  |





| Kata, tytöt, U18 |                 |  |   |               |  |
|------------------|-----------------|--|---|---------------|--|
| 1                | HANNU ALVA      | OULUN<br>KARATESEURA                         |    | FIN - FINLAND |  |
| 2                | ALATALO ONERVA  | JKS FINLAND -<br>SHOTOKAN KARATE<br>HELSINKI |    | FIN - FINLAND |  |
| 3                | KUUSI NIKA      | HÄMEENLINNAN<br>KARATESEURA                  |   | FIN - FINLAND |  |
| 4                | MEYKE ALEXANDRA | JKS FINLAND -<br>SHOTOKAN KARATE<br>HELSINKI |  | FIN - FINLAND |  |
| 5                | TAMMELA IITU    | HÄMEENLINNAN<br>KARATESEURA                  |  | FIN - FINLAND |  |





| Kata, tytöt, keltaiset, U10 yhdistetty |                  |                             |   |               |  |
|--|------------------|-----------------------------|---|---------------|--|
| 1                                      | LÄHETKANGAS EMMA | OULUN<br>KARATESEURA        |  | FIN - FINLAND |  |
| 2                                      | BHOGADI SRESHTA  | SHOTOKAN<br>HERVANTA RY     |  | FIN - FINLAND |  |
| 3                                      | CHUDINA ALISA    | PORIN SHOTOKAN              |  | FIN - FINLAND |  |
| 4                                      | HAKALA HELENA    | HÄMEENLINNAN<br>KARATESEURA |  | FIN - FINLAND |  |
| 5                                      | ABDELMOATY SARA  | HÄMEENLINNAN<br>KARATESEURA |  | FIN - FINLAND |  |
| 5                                      | KESKIMÄKI FANNI  | PORIN SHOTOKAN              |  | FIN - FINLAND |  |



| Kumite, miehet, avoin |                   |  |   |               |  |
|-----------------------|-------------------|--|---|---------------|--|
| 1                     | PAUKKOLA NOOA     | LAHDEN KARATE                                |  | FIN - FINLAND |  |
| 2                     | KAMAMOTO KEISHIRO | JKS FINLAND -<br>SHOTOKAN KARATE<br>HELSINKI |  | FIN - FINLAND |  |
| 3                     | VINK JEFFREY      | JKS FINLAND -<br>SHOTOKAN KARATE<br>HELSINKI |  | FIN - FINLAND |  |
| 4                     | SIMOLA TEEMU      | JAPAN KARATE<br>ASSOCIATION<br>TAMPERE RY    |  | FIN - FINLAND |  |
| 5                     | SURA JUHA-PEKKA   | FORSSAN-<br>TAMMELAN<br>JUNDOKAN RY          |  | FIN - FINLAND |  |



## Official Results



| Kumite, miehet, +35-vuotiaat, +84 kg |                |                              |   |               |
|--------------------------------------|----------------|------------------------------|---|---------------|
| 1                                    | VÄLIMÄKI RISTO | LEMPÄÄLÄN<br>SHOTOKAN KARATE |  | FIN - FINLAND |
| 2                                    | HÄRKÖNEN JARNO | OUTOKUMMUN<br>KARATESEURA RY |  | FIN - FINLAND |



| Kumite, miehet, +75kg |                 |   |   |               |
|-----------------------|-----------------|---|---|---------------|
| 1                     | SIMOLA TEEMU    | JAPAN KARATE<br>ASSOCIATION<br>TAMPERE RY |  | FIN - FINLAND |
| 2                     | HÄRKÖNEN JARNO  | OUTOKUMMUN<br>KARATESEURA RY              |  | FIN - FINLAND |
| 3                     | VÄLIMÄKI RISTO  | LEMPÄÄLÄN<br>SHOTOKAN KARATE              |  | FIN - FINLAND |
| 4                     | SURA JUHA-PEKKA | FORSSAN-<br>TAMMELAN<br>JUNDOKAN RY       |  | FIN - FINLAND |

| Kumite, miehet, -75kg yhdistetty |                        |  |   |               |
|----------------------------------|------------------------|--|---|---------------|
| 1                                | KAMAMOTO KEISHIRO      | JKS FINLAND -<br>SHOTOKAN KARATE<br>HELSINKI |    | FIN - FINLAND |
| 2                                | PELTOLA VEIKKO         | JAPAN KARATE<br>ASSOCIATION<br>TAMPERE RY    |    | FIN - FINLAND |
| 3                                | BANAULIKER KARTIK-OTTO | BUDOKWAI RY<br>KARATE                        |  | FIN - FINLAND |
| 4                                | HÄNNINEN NIILLO        | RENSHIN-KAN RY                               |  | FIN - FINLAND |

| Kumite, miehet, -84kg, +35-v yhdistetty |              |                          |   |               |
|---|--------------|--------------------------|---|---------------|
| 1                                       | LUUKKA EKI   | KOTKA THAIBOXING<br>CLUB |  | FIN - FINLAND |
| 2                                       | TURUNEN TIMO | SPORTSKARATE<br>KUOPIO   |  | FIN - FINLAND |

| Kumite, miehet, U21, -75 kg |                        |                       |   |               |
|-----------------------------|------------------------|-----------------------|---|---------------|
| 1                           | HÄNNINEN AARNI         | RENSHIN-KAN RY        |  | FIN - FINLAND |
| 2                           | BANAULIKER KARTIK-OTTO | BUDOKWAI RY<br>KARATE |  | FIN - FINLAND |
| 3                           | HÄNNINEN NIILLO        | RENSHIN-KAN RY        |  | FIN - FINLAND |

| Kumite, miehet, U21, -84 kg |                 |   |   |               |
|-----------------------------|-----------------|---|---|---------------|
| 1                           | PAUKKOLA NOOA   | LAHDEN KARATE                             |  | FIN - FINLAND |
| 2                           | MANTERE JIMI    | HÄMEENLINNAN<br>KARATESEURA               |  | FIN - FINLAND |
| 3                           | NUHANOVIC ALSAD | JAPAN KARATE<br>ASSOCIATION<br>TAMPERE RY |  | FIN - FINLAND |





| Kumite, naiset, avoin |                |  |   |               |
|-----------------------|----------------|--|---|---------------|
| 1                     | SAADAQUI SONYA | SPORTSKARATE.FI                              |  | FIN - FINLAND |
| 2                     | YAMATE SAKINO  | JKS FINLAND -<br>SHOTOKAN KARATE<br>HELSINKI |  | FIN - FINLAND |

## Official Results

**Kumite, naiset, U21, -68kg yhdistetty**

|   |                |                 |   |               |  |
|---|----------------|-----------------|---|---------------|--|
| 1 | SAADAOUI SONYA | SPORTSKARATE.FI |  | FIN - FINLAND |  |
| 2 | KOIVULA SOFIA  | SPORTSKARATE.FI |  | FIN - FINLAND |  |

**Kumite, pojat, U10**

|   |                   |                       |   |               |  |
|---|-------------------|-----------------------|---|---------------|--|
| 1 | LUUKKA ERNO       | KOTKA THAIBOXING CLUB |  | FIN - FINLAND |  |
| 2 | RAVYSE NATHAN     | BUDOKWAI RY KARATE    |  | FIN - FINLAND |  |
| 3 | ZAFAR AHMED HASAN | SHOTOKAN HERVANTA RY  |  | FIN - FINLAND |  |
| 4 | GROSU NICOLAS     | BUDOKWAI RY KARATE    |  | FIN - FINLAND |  |

**Kumite, pojat, U12, +42 kg**

|   |                 |                              |   |               |  |
|---|-----------------|------------------------------|---|---------------|--|
| 1 | HEIKKILÄ ELIEL  | BUDOKWAI RY KARATE           |  | FIN - FINLAND |  |
| 2 | VALVE VERNERI   | PORIN SHOTOKAN               |  | FIN - FINLAND |  |
| 3 | KULLBERG ADAM   | BUDOSEURA IMATRAN KUSANKU RY |  | FIN - FINLAND |  |
| 4 | ZIA AHMED HAMZA | SHOTOKAN HERVANTA RY         |  | FIN - FINLAND |  |
| 5 | PALUKURU RONITH | SHOTOKAN HERVANTA RY         |  | FIN - FINLAND |  |

**Kumite, pojat, U12, -35 kg**

|   |                    |                       |   |               |  |
|---|--------------------|-----------------------|---|---------------|--|
| 1 | LEISTI PENNUENG    | KOTKA THAIBOXING CLUB |  | FIN - FINLAND |  |
| 2 | LAKKA TEUVO        | SHOTOKAN HERVANTA RY  |  | FIN - FINLAND |  |
| 3 | RAWAT RITISH SINGH | SHOTOKAN HERVANTA RY  |  | FIN - FINLAND |  |

**Kumite, pojat, U12, -42 kg**

|   |                   |                                     |   |               |  |
|---|-------------------|-------------------------------------|---|---------------|--|
| 1 | ANTTILA PAOLO     | RENSHIN-KAN RY                      |  | FIN - FINLAND |  |
| 2 | RAISKINMÄKI AATOS | KARATE COMBAT ACADEMY               |  | FIN - FINLAND |  |
| 3 | LILJA DANI        | SPORTSKARATE KUOPIO                 |  | FIN - FINLAND |  |
| 4 | LUUKKA ERKKO      | KOTKA THAIBOXING CLUB               |  | FIN - FINLAND |  |
| 5 | RALLI ALEXI       | BUDOSEURA IMATRAN KUSANKU RY        |  | FIN - FINLAND |  |
| 5 | HANNU AARRE       | BUDOSEURA OULUN MUSOKAI RY          |  | FIN - FINLAND |  |
| 7 | PIHLAJISTO PAULI  | JAPAN KARATE ASSOCIATION TAMPERE RY |  | FIN - FINLAND |  |
| 7 | SIIVONEN KIMI     | PORIN SHOTOKAN                      |  | FIN - FINLAND |  |

**Kumite, pojat, U14, +55 kg**

|   |                   |                   |   |               |  |
|---|-------------------|-------------------|---|---------------|--|
| 1 | TAKALA ANTON      | OULUN KARATESEURA |  | FIN - FINLAND |  |
| 2 | NUMMIJÄRVI LUUKAS | PORIN SHOTOKAN    |  | FIN - FINLAND |  |





## Official Results

|   |                  |                        |   |               |  |
|---|------------------|------------------------|---|---------------|--|
| 3 | TAMEH ABDULKARIM | SPORTSKARATE<br>KUOPIO |  | FIN - FINLAND |  |
| 4 | LEHTO EEMELI     | LAHDEN KARATE          |  | FIN - FINLAND |  |

## Kumite, pojat, U14, -40kg

|   |                   |                                    |   |               |  |
|---|-------------------|------------------------------------|---|---------------|--|
| 1 | RUOTTINEN ROOPE   | BUDOSEURA<br>IMATRAN KUSANKU<br>RY |  | FIN - FINLAND |  |
| 2 | TSEGENES DIMITRIS | SHOTOKAN<br>HERVANTA RY            |  | FIN - FINLAND |  |



## Kumite, pojat, U14, -45 kg

|   |                    |                          |   |               |  |
|---|--------------------|--------------------------|---|---------------|--|
| 1 | SÄIPPÄ EMIL        | TAPANILAN ERÄ            |  | FIN - FINLAND |  |
| 2 | RAISKINMÄKI AARON  | KARATE COMBAT<br>ACADEMY |  | FIN - FINLAND |  |
| 5 | KALLIOMÄKI VILJAMI | PORIN SHOTOKAN           |  | FIN - FINLAND |  |

## Kumite, pojat, U14, -50 kg

|   |                 |  |   |               |  |
|---|-----------------|--|---|---------------|--|
| 1 | KELLA KASPERI   | LAHDEN KARATE                                |    | FIN - FINLAND |  |
| 2 | HUUSKONEN KOSTI | SPORTSKARATE<br>KUOPIO                       |    | FIN - FINLAND |  |
| 3 | MATTINEN NUUTTI | SPORTSKARATE<br>KUOPIO                       |    | FIN - FINLAND |  |
| 4 | LARKIN TAKEHIRO | JKS FINLAND -<br>SHOTOKAN KARATE<br>HELSINKI |  | FIN - FINLAND |  |
| 5 | SALMENSUU TOIVO | LAHDEN KARATE                                |  | FIN - FINLAND |  |

## Kumite, pojat, U14, -55 kg

|   |                    |  |   |               |  |
|---|--------------------|--|---|---------------|--|
| 1 | WOLFF ARN          | TAPANILAN ERÄ                                |  | FIN - FINLAND |  |
| 2 | HANNU EERO         | OULUN<br>KARATESEURA                         |  | FIN - FINLAND |  |
| 3 | NOROUZI ARASH LEON | JKS FINLAND -<br>SHOTOKAN KARATE<br>HELSINKI |  | FIN - FINLAND |  |

## Kumite, pojat, U16, +70 kg

|   |                 |                       |   |               |  |
|---|-----------------|-----------------------|---|---------------|--|
| 1 | ALGAHAWI YAKOOT | BUDOKWAI RY<br>KARATE |  | FIN - FINLAND |  |
| 2 | HUUSKONEN VEETI | LAHDEN KARATE         |  | FIN - FINLAND |  |
| 3 | KIVIKOSKI JERE  | LAHDEN KARATE         |  | FIN - FINLAND |  |
| 4 | PIENIMÄKI ROOPE | JIGOTAI KARATE        |  | FIN - FINLAND |  |







## Kumite, pojat, U16, -52 kg

|   |                 |                             |   |               |  |
|---|-----------------|-----------------------------|---|---------------|--|
| 1 | KETTUNEN EEMELI | HAMEENLINNAN<br>KARATESEURA |  | FIN - FINLAND |  |
| 2 | ANTTILA KEN     | RENSHIN-KAN RY              |  | FIN - FINLAND |  |
| 3 | MATTINEN NUUTTI | SPORTSKARATE<br>KUOPIO      |  | FIN - FINLAND |  |
| 4 | TARKKANEN OTSO  | JIGOTAI KARATE              |  | FIN - FINLAND |  |







## Kumite, pojat, U16, -57 kg

|   |               |                      |   |               |  |
|---|---------------|----------------------|---|---------------|--|
| 1 | VAARA SANTERI | OULUN<br>KARATESEURA |  | FIN - FINLAND |  |
|---|---------------|----------------------|---|---------------|--|

## Official Results

|   |                       |  |   |               |  |
|---|-----------------------|--|---|---------------|--|
| 2 | VÄYRYNEN LUUKAS       | SPORTSKARATE<br>KUOPIO                       |  | FIN - FINLAND |  |
| 3 | SIMONEN TINO          | JOEN MAWASHI RY                              |  | FIN - FINLAND |  |
| 4 | ILLANGANTHILAKE ISHAN | JKS FINLAND -<br>SHOTOKAN KARATE<br>HELSINKI |  | FIN - FINLAND |  |
| 5 | HIRVONEN JESSE        | JIGOTAI KARATE                               |  | FIN - FINLAND |  |
| 5 | HANHINEN ONNI         | JIGOTAI KARATE                               |  | FIN - FINLAND |  |
| 7 | SANDGREN JOONA        | VANTAAN WADO RYU<br>RY                       |  | FIN - FINLAND |  |



## Kumite, pojat, U16, -63 kg

|   |                  |                              |   |               |  |
|---|------------------|------------------------------|---|---------------|--|
| 1 | SIMONEN RENE     | JOEN MAWASHI RY              |  | FIN - FINLAND |  |
| 2 | TAKALA ANTON     | OULUN<br>KARATESEURA         |  | FIN - FINLAND |  |
| 3 | VARTIAINEN JUUSO | JOEN MAWASHI RY              |  | FIN - FINLAND |  |
| 4 | KIVIMÄKI VEIKKO  | LAHDEN KARATE                |  | FIN - FINLAND |  |
| 5 | GAETTI LUCAS     | PORIN SHOTOKAN               |  | FIN - FINLAND |  |
| 5 | KELTTO TOPIAS    | LAKEUDEN KARATE-<br>JUTSU RY |  | FIN - FINLAND |  |



## Kumite, pojat, U16, -70 kg

|   |                   |                      |   |               |  |
|---|-------------------|----------------------|---|---------------|--|
| 1 | PYLVÄNEN ANTON    | JIGOTAI KARATE       |  | FIN - FINLAND |  |
| 2 | LÄHETKANGAS LUKA  | OULUN<br>KARATESEURA |  | FIN - FINLAND |  |
| 3 | HOKKA MIKKO       | RENSHIN-KAN RY       |  | FIN - FINLAND |  |
| 4 | TKACHENKO TIMOFEI | JIGOTAI KARATE       |  | FIN - FINLAND |  |

## Kumite, pojat, U18, +68 kg yhdistetty

|   |              |   |   |               |  |
|---|--------------|---|---|---------------|--|
| 1 | MANTERE JIMI | HÄMEENLINNAN<br>KARATESEURA               |  | FIN - FINLAND |  |
| 2 | KREUS PETRUS | JAPAN KARATE<br>ASSOCIATION<br>TAMPERE RY |  | FIN - FINLAND |  |

## Kumite, pojat, U18, -55 kg

|   |                 |                             |   |               |  |
|---|-----------------|-----------------------------|---|---------------|--|
| 1 | SIMONEN TINO    | JOEN MAWASHI RY             |  | FIN - FINLAND |  |
| 2 | KETTUNEN EEMELI | HÄMEENLINNAN<br>KARATESEURA |  | FIN - FINLAND |  |





## Kumite, pojat, U18, -61 kg

|   |                 |                        |   |               |  |
|---|-----------------|------------------------|---|---------------|--|
| 1 | SIMONEN RENE    | JOEN MAWASHI RY        |  | FIN - FINLAND |  |
| 2 | VÄYRYNEN LUUKAS | SPORTSKARATE<br>KUOPIO |  | FIN - FINLAND |  |
| 3 | VAINELA JUHO    | PORIN SHOTOKAN         |  | FIN - FINLAND |  |
| 4 | JÄRVENPÄÄ TATU  | SPORTSKARATE<br>PORI   |  | FIN - FINLAND |  |







## Kumite, tytöt, U10 yhdistetty

|   |                 |                                    |   |               |  |
|---|-----------------|------------------------------------|---|---------------|--|
| 1 | RUOTTINEN IINA  | BUDOSEURA<br>IMATRAN KUSANKU<br>RY |  | FIN - FINLAND |  |
| 2 | MAKSYMUK ULIANA | MAKSYMUK                           |  | FIN - FINLAND |  |

## Official Results

|   |                  |                             |   |               |  |
|---|------------------|-----------------------------|---|---------------|--|
| 3 | LÄHETKANGAS EMMA | OULUN<br>KARATESEURA        |  | FIN - FINLAND |  |
| 4 | HAKALA HELI      | HÄMEENLINNAN<br>KARATESEURA |  | FIN - FINLAND |  |
| 5 | ABDELMOATY SARA  | HÄMEENLINNAN<br>KARATESEURA |  | FIN - FINLAND |  |
| 5 | BATIKERU LAASYA  | SHOTOKAN<br>HERVANTA RY     |  | FIN - FINLAND |  |
| 7 | LUOMA-ÄIJÖ ELLAH | SPORTSKARATE.FI             |  | FIN - FINLAND |  |

## Kumite, tytöt, U12, +40 kg

|   |                   |   |   |               |  |
|---|-------------------|---|---|---------------|--|
| 1 | SAVOLAINEN ELLI   | SPORTSKARATE<br>KUOPIO                    |  | FIN - FINLAND |  |
| 2 | NUHANOVIC AMINA   | JAPAN KARATE<br>ASSOCIATION<br>TAMPERE RY |  | FIN - FINLAND |  |
| 3 | KOSKELA JASMIN    | PORIN SHOTOKAN                            |  | FIN - FINLAND |  |
| 4 | EBDUL EZIZ EVA    | BUDOKWAI RY<br>KARATE                     |  | FIN - FINLAND |  |
| 5 | HEINÄNEN VANESSA  | PORIN SHOTOKAN                            |  | FIN - FINLAND |  |
| 5 | VENERANTA CECILIA | PORIN SHOTOKAN                            |  | FIN - FINLAND |  |





## Kumite, tytöt, U12, -34 kg

|   |              |                         |   |               |  |
|---|--------------|-------------------------|---|---------------|--|
| 1 | ARUN IISHA   | SHOTOKAN<br>HERVANTA RY |  | FIN - FINLAND |  |
| 2 | ANBAR HIBA   | SHOTOKAN<br>HERVANTA RY |  | FIN - FINLAND |  |
| 3 | NYKÄNEN TARA | NYKÄNEN                 |  | FIN - FINLAND |  |



## Kumite, tytöt, U12, -40 kg

|   |                 |                             |   |               |  |
|---|-----------------|-----------------------------|---|---------------|--|
| 1 | HEINO LILYA     | TAPANILAN ERÄ               |  | FIN - FINLAND |  |
| 2 | HAKALA HANNA    | HÄMEENLINNAN<br>KARATESEURA |  | FIN - FINLAND |  |
| 3 | LINDROOS EMILIA | PORIN SHOTOKAN              |  | FIN - FINLAND |  |
| 4 | SANKARI NELLI   | PORIN SHOTOKAN              |  | FIN - FINLAND |  |



## Kumite, tytöt, U14, +52 kg

|   |                     |   |   |               |  |
|---|---------------------|---|---|---------------|--|
| 1 | KONTIO VENLA        | TAPANILAN ERÄ                             |  | FIN - FINLAND |  |
| 2 | POHJALAINEN AURA    | BUDOSEURA<br>IMATRAN KUSANKU<br>RY        |  | FIN - FINLAND |  |
| 3 | COMAN ANASTASIA     | JAPAN KARATE<br>ASSOCIATION<br>TAMPERE RY |  | FIN - FINLAND |  |
| 4 | HAMEEDA AHMED AISHA | SHOTOKAN<br>HERVANTA RY                   |  | FIN - FINLAND |  |





## Kumite, tytöt, U14, -42 kg

|   |                  |                |   |               |  |
|---|------------------|----------------|---|---------------|--|
| 1 | ANTTILA ISABELLA | RENSHIN-KAN RY |  | FIN - FINLAND |  |
| 2 | RIIMALA SEELA    | JIGOTAI KARATE |  | FIN - FINLAND |  |

## Kumite, tytöt, U14, -47 kg

|   |                |                        |   |               |  |
|---|----------------|------------------------|---|---------------|--|
| 1 | HYVÖNEN LILA   | SPORTSKARATE<br>KUOPIO |  | FIN - FINLAND |  |
| 2 | ANTINKAAPO NEA | JIGOTAI KARATE         |  | FIN - FINLAND |  |

## Official Results

|   |                 |                                    |   |               |  |
|---|-----------------|------------------------------------|---|---------------|--|
| 3 | HEINO DAISY     | TAPANILAN ERÄ                      |  | FIN - FINLAND |  |
| 4 | PÖYHÖNEN IIDA   | LAHDEN KARATE                      |  | FIN - FINLAND |  |
| 5 | KESKINEN EMILIA | BUDOSEURA<br>IMATRAN KUSANKU<br>RY |  | FIN - FINLAND |  |
| 5 | SEMBER VIVI     | VANTAAN WADO RYU<br>RY             |  | FIN - FINLAND |  |





## Kumite, tytöt, U14, -52 kg

|   |                   |                          |   |               |  |
|---|-------------------|--------------------------|---|---------------|--|
| 1 | STEFANSKI VANESSA | LAHDEN KARATE            |  | FIN - FINLAND |  |
| 2 | LEISTI CHARUPHAT  | KOTKA THAIBOXING<br>CLUB |  | FIN - FINLAND |  |
| 3 | NIEMI TOVA        | TAPANILAN ERÄ            |  | FIN - FINLAND |  |

## Kumite, tytöt, U16, +54 kg yhdistetty

|   |                |                             |   |               |  |
|---|----------------|-----------------------------|---|---------------|--|
| 1 | JOKINEN HELMI  | HÄMEENLINNAN<br>KARATESEURA |  | FIN - FINLAND |  |
| 2 | KORPELA SIIRI  | OULUN<br>KARATESEURA        |  | FIN - FINLAND |  |
| 3 | MERTAMO AMANDA | TAPANILAN ERÄ               |  | FIN - FINLAND |  |
| 4 | PELKONEN AUNE  | SHOTOKAN<br>HERVANTA RY     |  | FIN - FINLAND |  |





## Kumite, tytöt, U16, -47 kg

|   |                 |   |   |               |  |
|---|-----------------|---|---|---------------|--|
| 1 | ITKONEN JANIKA  | SPORTSKARATE.FI                           |  | FIN - FINLAND |  |
| 2 | HANNU ALVA      | OULUN<br>KARATESEURA                      |  | FIN - FINLAND |  |
| 3 | NUHANOVIC HASKA | JAPAN KARATE<br>ASSOCIATION<br>TAMPERE RY |  | FIN - FINLAND |  |
| 4 | MUSTAFINA SOFIA | PORIN SHOTOKAN                            |  | FIN - FINLAND |  |
| 5 | KENTTÄ HILDA    | OULUN<br>KARATESEURA                      |  | FIN - FINLAND |  |



## Kumite, tytöt, U16, -54 kg

|   |                   |                 |   |               |  |
|---|-------------------|-----------------|---|---------------|--|
| 1 | CHEPELEV SOFIA    | SPORTSKARATE.FI |  | FIN - FINLAND |  |
| 2 | STEFANSKI VANESSA | LAHDEN KARATE   |  | FIN - FINLAND |  |
| 3 | LEHTINEN ELEANOR  | TAPANILAN ERÄ   |  | FIN - FINLAND |  |
| 4 | SYRJÄNEN LILY     | PORIN SHOTOKAN  |  | FIN - FINLAND |  |



## Kumite, tytöt, U18, +53kg yhdistetty

|   |                 |  |   |               |  |
|---|-----------------|--|---|---------------|--|
| 1 | KOIVULA SOFIA   | SPORTSKARATE.FI                              |  | FIN - FINLAND |  |
| 2 | SAARNIO SELJA   | SPORTSKARATE.FI                              |  | FIN - FINLAND |  |
| 3 | JOKINEN HELMI   | HÄMEENLINNAN<br>KARATESEURA                  |  | FIN - FINLAND |  |
| 4 | MEYKE ALEXANDRA | JKS FINLAND -<br>SHOTOKAN KARATE<br>HELSINKI |  | FIN - FINLAND |  |



## Kumite, tytöt, U18, -53 kg yhdistetty

|   |                |                 |   |               |  |
|---|----------------|-----------------|---|---------------|--|
| 1 | ITKONEN JANIKA | SPORTSKARATE.FI |  | FIN - FINLAND |  |
| 2 | CHEPELEV SOFIA | SPORTSKARATE.FI |  | FIN - FINLAND |  |

## Official Results

|   |                |  |   |               |  |
|---|----------------|--|---|---------------|--|
| 3 | ALATALO ONERVA | JKS FINLAND -<br>SHOTOKAN KARATE<br>HELSINKI |  | FIN - FINLAND |  |
| 4 | RISSANEN IINA  | SPORTSKARATE<br>KUOPIO                       |  | FIN - FINLAND |  |

**TEKNIikka U10**

|   |              |               |   |               |  |
|---|--------------|---------------|---|---------------|--|
| 1 | HAVEN EEVI   | LAHDEN KARATE |  | FIN - FINLAND |  |
| 2 | ELPIÖ AMELIA | LAHDEN KARATE |  | FIN - FINLAND |  |
| 3 | REPO LEO     | LAHDEN KARATE |  | FIN - FINLAND |  |

**TEKNIikka U14 yhdistetty**























|   |                |                             |   |               |  |
|---|----------------|-----------------------------|---|---------------|--|
| 1 | PIRINEN MILA   | HÄMEENLINNAN<br>KARATESEURA |  | FIN - FINLAND |  |
| 2 | SOVA ELINA     | HÄMEENLINNAN<br>KARATESEURA |  | FIN - FINLAND |  |
| 3 | SALMINEN WENLA | LAHDEN KARATE               |  | FIN - FINLAND |  |
| 4 | KEKKI AKSELI   | LAHDEN KARATE               |  | FIN - FINLAND |  |

**Tekniikka U9 yhdistetty**

|   |                     |                             |   |               |  |
|---|---------------------|-----------------------------|---|---------------|--|
| 1 | ABDELMOATY JASMIINA | HÄMEENLINNAN<br>KARATESEURA |    | FIN - FINLAND |  |
| 2 | HAKALA HELENA       | HÄMEENLINNAN<br>KARATESEURA |   | FIN - FINLAND |  |
| 3 | BHOGADI SRESHTA     | SHOTOKAN<br>HERVANTA RY     |  | FIN - FINLAND |  |

## Tawastia Open Karate 2/2024 - 2024-10-05

## Medals - Club

| Rank | Club  | 1. Place | 2. Place | 3. Place |
|------|---|----------|----------|----------|
| 1    |  LAHDEN KARATE, FIN                          | 11       | 6        | 5        |
| 2    |  OULUN KARATESEURA, FIN                      | 8        | 6        | 4        |
| 3    |  SPORTSKARATE.FI, FIN                        | 6        | 3        | 0        |
| 4    |  HÄMEENLINNAN KARATESEURA, FIN               | 5        | 8        | 3        |
| 5    |  TAPANILAN ERÄ, FIN                          | 4        | 0        | 4        |
| 6    |  RENSHIN-KAN RY, FIN                         | 3        | 1        | 2        |
| 7    |  KOTKA THAIBOXING CLUB, FIN                  | 3        | 1        | 0        |
| 8    |  JOEN MAWASHI RY, FIN                        | 3        | 0        | 2        |
| 9    |  SHOTOKAN HERVANTA RY, FIN                   | 2        | 5        | 5        |
| 10   |  JAPAN KARATE ASSOCIATION TAMPERE RY, FIN    | 2        | 5        | 3        |
| 11   |  JKS FINLAND - SHOTOKAN KARATE HELSINKI, FIN | 2        | 4        | 7        |
| 12   |  SPORTSKARATE KUOPIO, FIN                    | 2        | 4        | 4        |
| 13   |  BUDOKWAI RY KARATE, FIN                     | 2        | 2        | 1        |
| 14   |  BUDOSEURA IMATRAN KUSANKU RY, FIN           | 2        | 1        | 1        |
| 15   |  JIGOTAI KARATE, FIN                         | 1        | 4        | 2        |
| 16   |  OUTOKUMMUN KARATESEURA RY, FIN              | 1        | 4        | 0        |
| 17   |  PORIN SHOTOKAN, FIN                         | 1        | 3        | 5        |
| 18   |  MAKSYMUK, FIN                               | 1        | 1        | 0        |
| 19   |  LEMPÄÄLÄN SHOTOKAN KARATE, FIN             | 1        | 0        | 1        |
| 20   |  SHUYOKAI SHOTOKAN KARATE-DO, FIN          | 1        | 0        | 0        |
| 21   |  KARATE COMBAT ACADEMY, FIN                | 0        | 2        | 0        |
| 22   |  KORHONEN, FIN                             | 0        | 1        | 0        |
| 23   |  NYKÄNEN, FIN                              | 0        | 0        | 1        |