

RESULTS BOOK

KARATEN SM KILPAILUT 2024

2024.04.06 - 2024.04.06

ASIKKALANTIE 14, 17200 VÄÄKSY

FINLAND, FIN

WWW.SPORTDATA.ORG



TABLE OF CONTENTS

NUMBER OF ENTRIES	3
ENTRYLIST	4
ENRYLIST BY WEIGHT CATEGORY	13
STATISTICS	24
JOUKKUE, KATA, NAISSET	26
JOUKKUE, KUMITE, U16, POJAT	31
JOUKKUE, KUMITE, U18, POJAT	36
KATA MIEHET +40V	211
KATA SOVELLETTU	216
KATA, MIEHET	40
KATA, NAISSET	45
KATA, U14, POJAT	201
KATA, U14, TYTÖT	206
KATA, U16, POJAT	50
KATA, U16, TYTÖT	55
KATA, U18, TYTÖT	60
KATA, U21, MIEHET	65
KATA, U21, NAISSET	69
KUMITE MIEHET 35-50V +75KG	224
KUMITE, MIEHET +35V, -75KG YHDISTETTY	74
KUMITE, MIEHET, +84KG	78
KUMITE, MIEHET, -67KG YHDISTETTY	220
KUMITE, MIEHET, -75KG	82
KUMITE, MIEHET, -84KG	86
KUMITE, MIEHET, AVOIN	90
KUMITE, NAISSET, +68KG	94
KUMITE, NAISSET, -68KG	98
KUMITE, NAISSET, AVOIN	102
KUMITE, U14, POJAT -45KG YHDISTETTY	106

KUMITE, U14, POJAT -55KG YHDISTETTY	111
KUMITE, U14, POJAT, +55KG	116
KUMITE, U14, TYTÖT, +47KG	120
KUMITE, U14, TYTÖT, -42KG	125
KUMITE, U14, TYTÖT, -47KG	129
KUMITE, U16, POJAT +63KG YHDISTETTY	133
KUMITE, U16, POJAT, -52KG	138
KUMITE, U16, POJAT, -57KG	143
KUMITE, U16, POJAT, -63KG	148
KUMITE, U16, TYTÖT -54KG YHDISTETTY	152
KUMITE, U16, TYTÖT, +54KG	157
KUMITE, U18, POJAT -68KG YHDISTETTY	162
KUMITE, U18, POJAT, +76KG	167
KUMITE, U18, POJAT, -76KG	171
KUMITE, U18, TYTÖT +59KG YHDISTETTY	175
KUMITE, U18, TYTÖT -59KG YHDISTETTY	180
KUMITE, U21, MIEHET, +67KG YHDISTETTY	185
KUMITE, U21, MIEHET, -67KG YHDISTETTY	189
KUMITE, U21, NAISET +55KG	193
KUMITE, U21, NAISET, -55KG	197
U12 POJAT KATA	228
U12 POJAT KUMITE +42KG	233
U12 POJAT KUMITE -35KG	237
U12 POJAT KUMITE -42KG	241
U12 TYTÖT KATA	246
U12 TYTÖT KUMITE AVOIN	251
OFFICIAL RESULTS	256
MEDAL STANDING	265

KARATEN SM KILPAILUT 2024

FINLAND
Asikkalantie 14, 17200 Vääksy

2024.04.06 - 2024.04.06

Participation List (by Club/Team)

#	Code	Club	Male	Female	Total Entries	Total Athletes
1	+	FIN Budokwai ry Karate(Budokwai Karate)	5	0	5	4
2	+	FIN Budoseura Imatran Kusanku ry(Imatran Kusanku)	3	2	5	5
3	+	FIN Budoseura Oulun Musokai Ry(Musokai)	4	6	10	5
4	+	FIN Euran karateseura[20](EKS[20])	0	2	2	1
5	+	FIN Hyvinkään Shotokan karate ry(Vesa)	2	0	2	2
6	+	FIN Hämeenlinnan Karateseura(HKS)	6	5	11	7
7	+	FIN JKS Finland - Shotokan Karate Helsinki(JKS Finland)	5	5	10	8
8	+	FIN Japan Karate Association Tampere ry(JKA-Tampere)	4	7	11	10
9	+	FIN Japan Karate Association Tampere ry[1](JKA-Tampere[1])	1	0	1	1
10	+	FIN Jigotai Karate[2](Jigotai[2])	12	2	14	7
11	+	FIN Joen Mawashi ry[3](JM[3])	7	1	8	8
12	+	FIN Kotka thaiboxing club(Ktbc)	5	2	7	6
13	+	FIN Lahden Karate[2](LK-FIN[2])	17	20	37	24
14	+	FIN Lakeuden Karate-Jutsu Ry[1](LKJ[1])	3	0	3	3
15	+	FIN Lempäälän Shotokan Karate[2](JKA Lempäälä[2])	0	2	2	1
16	+	FIN Mäntsälän Karate(Mäntsälän Karate)	1	0	1	1
17	+	FIN Oulun Karateseura(OKS)	14	4	18	9
18	+	FIN Outokummun Karateseura ry[7](OKS[7])	3	0	3	1
19	+	FIN Parkanon Kampailuseura ry.(Pnokamp)	0	2	2	1
20	+	FIN Renshin-Kan ry(Renshi)	10	4	14	9
21	+	FIN Seigokan Tampere[4](Seigokan[4])	2	2	4	4
22	+	FIN Shuyokai Shotokan Karate-Do(Shuyokai)	1	4	5	5
23	+	FIN Sportskarate Kuopio(OM[2])	13	7	20	15
24	+	FIN Sportskarate Pori[9](SKP[9])	1	0	1	1
25	+	FIN Sportskarate.fi(SPF)	5	15	20	17
26	+	FIN Tapanilan Erä[1](Erä[1])	3	10	13	8
27	+	FIN Vantaan Wado Ryu ry(Wado Ryu ry)	2	0	2	1
28	+	FIN kushin-kan (kushin-kan)	1	0	1	1
Totals:			130	102	232	165

KARATEN SM KILPAILUT 2024

FINLAND
Asikkalantie 14, 17200 Vääksy

2024.04.06 - 2024.04.06

ENTRY LIST BY CLUB

FINLAND

Budokwai ry Karate(Budokwai Karate)

ID	Sex	Family Name	Given Name	Category
1	Male	Algahawi	Yakoot	KUMITE, U16, POJAT +63KG yhdistetty
2	Male	Banauliker	Kartik-Otto	KUMITE, U21, MIEHET, +67KG yhdistetty
3	Male	Banauliker	Kartik-Otto	KUMITE, MIEHET, -75KG
4	Male	Heikkilä	Eliel	U12 pojat kumite +42kg
5	Male	Karma	Emil	KUMITE, U14, POJAT -45KG yhdistetty

Entries: 5

Budoseura Imatran Kusanku ry(Imatran Kusanku)

ID	Sex	Family Name	Given Name	Category
6	Female	Keskinen	Emilia	u12 tytöt kumite avoin
7	Male	Kullberg	Adam	U12 pojat kumite +42kg
8	Male	Ralli	Alexi	U12 pojat kumite -35kg
9	Male	Ruottinen	Roope	KUMITE, U14, POJAT -45KG yhdistetty
10	Female	Vesikko	Minea	u12 tytöt kumite avoin

Entries: 5

Budoseura Oulun Musokai Ry(Musokai)

ID	Sex	Family Name	Given Name	Category
11	Male	Hannu	Aarre	U12 pojat kata
12	Male	Hannu	Aarre	U12 pojat kumite -35kg
13	Female	Hannu	Alva	KATA, U16, TYTÖT
14	Female	Hannu	Alva	KUMITE, U16, TYTÖT -54KG yhdistetty
15	Male	Hannu	Eero	Kata, U14, pojat
16	Male	Hannu	Eero	KUMITE, U14, POJAT -55KG yhdistetty
17	Female	Ollikainen	Saara	Kata, U14, tytöt
18	Female	Ollikainen	Saara	KUMITE, U14, TYTÖT, +47kg
19	Female	Sihvonen	Ella	KATA, NAISSET
20	Female	Sihvonen	Ella	KATA, U21, NAISSET

Entries: 10

Euran karateseura(EKS)

ID	Sex	Family Name	Given Name	Category
21	Female	Keinänen	Titta	KUMITE, NAISSET, +68KG
22	Female	Keinänen	Titta	KUMITE, NAISSET, AVOIN

Entries: 2

Hyvinkään Shotokan karate ry(Vesa)

ID	Sex	Family Name	Given Name	Category
23	Male	Heiska	Oskari	KATA, U16, POJAT
24	Male	Tuominen	Vesa	Kata miehet +40v

Entries: 2

KARATEN SM KILPAILUT 2024

FINLAND
Asikkalantie 14, 17200 Vääksy

2024.04.06 - 2024.04.06

ENTRY LIST BY CLUB

 Hämeenlinnan Karateseura(HKS)					
ID	Sex	Family Name	Given Name	Category	
25	Female	Jokinen	Helmi	KUMITE, U16, TYTÖT, +54KG	
26	Female	Jokinen	Helmi	KUMITE, U18, TYTÖT +59KG yhdistetty	
27	Male	Kettunen	Eemeli	KUMITE, U16, POJAT, -52KG	
28	Male	Kivistö	Hugo	U12 pojat kumite -35kg	
29	Female	Kuusi	Nika	KATA, U16, TYTÖT	
30	Female	Kuusi	Nika	KATA, U18, TYTÖT	
31	Male	Mantere	Jimi	KUMITE, MIEHET, -84KG	
32	Male	Mantere	Jimi	KUMITE, U18, POJAT, +76KG	
33	Male	Mantere	Niko	KUMITE, MIEHET, AVOIN	
34	Male	Mantere	Niko	KUMITE, MIEHET, -84KG	
35	Female	Tammela	Iitu	KATA, U16, TYTÖT	

Entries: 11

 Japan Karate Association Tampere ry(JKA-Tampere)					
ID	Sex	Family Name	Given Name	Category	
36	Female	Heiskanen	Iines	JOUKKUE, KATA, NAISET	
37	Female	Heiskanen	Iines	KATA, U18, TYTÖT	
38	Female	Hintikka	Maria	JOUKKUE, KATA, NAISET	
39	Female	Hintikka	Maria	KATA, NAISET	
40	Male	Järvinen	Otso	KATA, MIEHET	
41	Male	Kreus	Petrus	JOUKKUE, KUMITE, U18, POJAT	
42	Male	Kreus	Petrus	KUMITE, U18, POJAT, -76KG	
43	Female	Lantta	Wiivi	JOUKKUE, KATA, NAISET	
44	Female	Lantta	Wiivi	KATA, U21, NAISET	
45	Male	Mantere	Jimi	JOUKKUE, KUMITE, U18, POJAT	
46	Male	Nuhanovic	Alsad	KUMITE, U18, POJAT, -76KG	
47	Male	Nuhanovic	Alsad	JOUKKUE, KUMITE, U18, POJAT	
48	Female	Nuhanovic	Amina	u12 tytöt kumite avoin	
49	Female	Nuhanovic	Haska	KUMITE, U14, TYTÖT, -47KG	
50	Female	Paattimäki	Aliisa	KUMITE, U18, TYTÖT -59KG yhdistetty	
51	Male	Muurinaho	Luka	KUMITE, U14, POJAT -55KG yhdistetty	

Entries: 16

 Jigotai Karate(Jigotai)					
ID	Sex	Family Name	Given Name	Category	
52	Female	Antinkaapo	Nea	KUMITE, U14, TYTÖT, -42KG	
53	Female	Antinkaapo	Nea	Kata, U14, tytöt	
54	Male	Hanhinen	Onni	KUMITE, U16, POJAT, -52KG	
55	Male	Hanhinen	Onni	JOUKKUE, KUMITE, U16, POJAT	
56	Male	Hirvonen	Jesse	JOUKKUE, KUMITE, U16, POJAT	
57	Male	Hirvonen	Jesse	KATA, U16, POJAT	
58	Male	Hirvonen	Jesse	KUMITE, U16, POJAT, -57KG	
59	Male	Pienimäki	Roope	KUMITE, U16, POJAT +63KG yhdistetty	
60	Male	Pienimäki	Roope	JOUKKUE, KUMITE, U16, POJAT	
61	Male	Pienimäki	Roope	KATA, U16, POJAT	
62	Male	Pylvänen	Anton	KUMITE, U16, POJAT +63KG yhdistetty	

KARATEN SM KILPAILUT 2024

FINLAND
Asikkalantie 14, 17200 Vääksy

2024.04.06 - 2024.04.06

ENTRY LIST BY CLUB

 Jigotai Karate(Jigotai)					
ID	Sex	Family Name	Given Name	Category	
63	Male	Pylvänen	Anton	JOUKKUE, KUMITE, U16, POJAT	
64	Male	Tarkkanen	Otso	JOUKKUE, KUMITE, U16, POJAT	
65	Male	Tarkkanen	Otso	KATA, U16, POJAT	
66	Male	Tarkkanen	Otso	KUMITE, U16, POJAT, -52KG	
67	Male	Tkachenko	Timofei	KUMITE, U16, POJAT, -52KG	
68	Male	Tkachenko	Timofei	JOUKKUE, KUMITE, U16, POJAT	
69	Male	Tkachenko	Timofei	KATA, U16, POJAT	

Entries: 18

 JKS Finland - Shotokan Karate Helsinki(JKS Finland)					
ID	Sex	Family Name	Given Name	Category	
70	Female	Alatalo	Onerva	KATA, U18, TYTÖT	
71	Female	Alatalo	Vanamo	Kata, U14, tytöt	
72	Male	Casci	Giangabriele	Kata miehet +40v	
73	FIN2013	Kulovuori	Björn	KUMITE, MIEHET, -84KG	
74	Male	Larkin	Takehiro	U12 pojat kata	
75	Male	Larkin	Takehiro	U12 pojat kumite -42kg	
76	Female	Meyke	Alexandra	KATA, U18, TYTÖT	
77	Female	Meyke	Alexandra	KUMITE, U18, TYTÖT +59KG yhdistetty	
78	Female	Ortiz	Antonia	Kata, U14, tytöt	
79	Male	Vink	Jeffrey	KUMITE, MIEHET, AVOIN	

Entries: 10

 Joen Mawashi ry(JM)					
ID	Sex	Family Name	Given Name	Category	
80	Male	Järvenpää	Tatu	JOUKKUE, KUMITE, U16, POJAT	
81	Male	Matero	Jimi	KUMITE, U18, POJAT -68KG yhdistetty	
82	Male	Matero	Luka	KUMITE, U16, POJAT, -57KG	
83	Female	Monti	Sofia	KUMITE, U14, TYTÖT, +47kg	
84	Male	Simonen	Rene	KUMITE, U16, POJAT, -63KG	
85	Male	Simonen	Rene	JOUKKUE, KUMITE, U16, POJAT	
86	Male	Simonen	Tino	JOUKKUE, KUMITE, U16, POJAT	
87	Male	Simonen	Tino	KUMITE, U16, POJAT, -57KG	
88	Male	Tolvanen	Mido	KUMITE, U18, POJAT -68KG yhdistetty	
89	Male	Vartiainen	Juuso	KUMITE, U14, POJAT, +55kg	

Entries: 10

 Kotka thaiboxing club(Ktbc)					
ID	Sex	Family Name	Given Name	Category	
90	Female	Leisti	Charuphat	KUMITE, U14, TYTÖT, -47KG	
91	Male	Luukka	Eki	KUMITE, MIEHET +35v, -75KG yhdistetty	
92	Male	Luukka	Eki	KUMITE, MIEHET, -75KG	
93	Female	Luukka	Erin	KUMITE, U16, TYTÖT -54KG yhdistetty	
94	Male	Luukka	Erkko	U12 pojat kumite -42kg	
95	Male	Lämsä	Luka	KUMITE, U14, POJAT -55KG yhdistetty	

KARATEN SM KILPAILUT 2024

FINLAND
Asikkalantie 14, 17200 Vääksy

2024.04.06 - 2024.04.06

ENTRY LIST BY CLUB

 Kotka thaiboxing club(Ktbc)					
ID	Sex	Family Name	Given Name	Category	
96	Male	Tikkanen	Elias	KUMITE, U16, POJAT, -52KG	

Entries: 7

 kushin-kan (kushin-kan)					
ID	Sex	Family Name	Given Name	Category	
97	Male	Rasila	Petri	Kumite miehet 35-50v +75kg	

Entries: 1

 Lahden Karate(LK-FIN)					
ID	Sex	Family Name	Given Name	Category	
98	Female	Ahonen	Venla	KATA, U16, TYTÖT	
99	Female	Asiala	Erin	U12 tytöt kata	
100	Male	Bonden	Matias	U12 pojat kata	
101	Male	Bonden	Matias	U12 pojat kumite -42kg	
102	Female	Haven	Sara	Kata, U14, tytöt	
103	Male	Huuskonen	Veeti	KATA, U16, POJAT	
104	Male	Huuskonen	Veeti	KUMITE, U16, POJAT +63KG yhdistetty	
105	Female	Kallio	Sara	JOUKKUE, KATA, NAISSET	
106	Female	Kallio	Sara	KATA, U16, TYTÖT	
107	Male	Kella	Kasper	Kata, U14, pojat	
108	Male	Kella	Kasper	KUMITE, U14, POJAT -45KG yhdistetty	
109	Female	Kinnunen	Anni	Kata, U14, tytöt	
110	Male	Kivikoski	Jere	Kata, U14, pojat	
111	Male	Kivimäki	Veikko	KATA, U16, POJAT	
112	Female	Koponen	Kiia	KUMITE, U21, NAISSET +55kg	
113	Female	Koponen	Kiia	KUMITE, NAISSET, -68KG	
114	Female	Koponen	Kiia	KUMITE, NAISSET, AVOIN	
115	Male	Lehtinen	Jesse	KUMITE, U21, MIEHET, -67KG yhdistetty	
116	Male	Lehtinen	Jesse	KATA, U21, MIEHET	
117	Male	Lehtinen	Jesse	Kumite, miehet, -67kg yhdistetty	
118	Female	Lehtinen	Nea	KATA, NAISSET	
119	Female	Lehtinen	Nea	JOUKKUE, KATA, NAISSET	
120	Female	Lehtinen	Nea	KATA, U21, NAISSET	
121	Male	Lehtinen	Tuomas	Kata sovellettu	
122	Male	Lehto	Eemeli	U12 pojat kumite +42kg	
123	Male	Lehto	Eemeli	U12 pojat kata	
124	Female	Lindström	Meri	Kata, U14, tytöt	
125	Male	Mäenpää	Jaakko	Kata sovellettu	
126	Female	Mänty	Bess	JOUKKUE, KATA, NAISSET	
127	Female	Mänty	Bess	KATA, NAISSET	
128	Female	Pöllänen	Hilma	U12 tytöt kata	
129	Female	Pöyhönen	Iida	U12 tytöt kata	
130	Female	Pöyhönen	Iida	u12 tytöt kumite avoin	
131	Male	Saario	Leevi	Kumite, miehet, -67kg yhdistetty	
132	Male	Saario	Leevi	KUMITE, U21, MIEHET, -67KG yhdistetty	
133	Female	Stefanski	Vanessa	KUMITE, U14, TYTÖT, +47kg	

KARATEN SM KILPAILUT 2024

FINLAND
Asikkalantie 14, 17200 Vääksy

2024.04.06 - 2024.04.06

ENTRY LIST BY CLUB

 Lahden Karate(LK-FIN)					
ID	Sex	Family Name	Given Name	Category	
134	Female	Stefanski	Vanessa	Kata, U14, tytöt	
135	Female	Vuorinen	Alma	Kata, U14, tytöt	
136	Female	Vuorinen	Elin	Kata, U14, tytöt	

Entries: 39

 Lakeuden Karate-Jutsu Ry(LKJ)					
ID	Sex	Family Name	Given Name	Category	
137	Male	Keltto	Matias	KUMITE, U21, MIEHET, +67KG yhdistetty	
138	Male	Keltto	Topias	KUMITE, U14, POJAT -55KG yhdistetty	
139	Male	Nurmesniemi	Lauri	KUMITE, U18, POJAT -68KG yhdistetty	

Entries: 3

 Lempäälän Shotokan Karate(JKA Lempäälä)					
ID	Sex	Family Name	Given Name	Category	
140	Female	Seppälä	Saana	KUMITE, NAISET, -68KG	
141	Female	Seppälä	Saana	KUMITE, NAISET, AVOIN	

Entries: 2

 Mäntsälän Karate(Mäntsälän Karate)					
ID	Sex	Family Name	Given Name	Category	
142	Male	Vesterinen	Max	KUMITE, U14, POJAT -55KG yhdistetty	

Entries: 1

 Oulun Karataseura(OKS)					
ID	Sex	Family Name	Given Name	Category	
143	Male	Hannu	Eero	JOUKKUE, KUMITE, U14, POJAT	
144	Female	Kenttä	Hilda	KUMITE, U16, TYTÖT -54KG yhdistetty	
145	Female	Kenttä	Hilda	KATA, U16, TYTÖT	
146	Male	Khalifa	Miidu	KUMITE, MIEHET, +84KG	
147	Male	Khalifa	Miidu	KUMITE, MIEHET, AVOIN	
148	Female	Korpela	Siiri	Kata, U14, tytöt	
149	Female	Korpela	Siiri	KUMITE, U14, TYTÖT, +47kg	
150	Male	Lähetkangas	Luka	JOUKKUE, KUMITE, U14, POJAT	
151	Male	Lähetkangas	Luka	Kata, U14, pojat	
152	Male	Lähetkangas	Luka	KUMITE, U14, POJAT, +55kg	
153	Male	Lähetkangas	Luka	JOUKKUE, KUMITE, U16, POJAT	
154	Male	Takala	Akseli	KATA, U21, MIEHET	
155	Male	Takala	Akseli	KATA, MIEHET	
156	Male	Takala	Anton	Kata, U14, pojat	
157	Male	Takala	Anton	KUMITE, U14, POJAT, +55kg	
158	Male	Takala	Anton	JOUKKUE, KUMITE, U16, POJAT	
159	Male	Takala	Anton	JOUKKUE, KUMITE, U14, POJAT	
160	Male	Tejesvi	Shashank	U12 pojat kumite -35kg	
161	Male	Tejesvi	Shashank	U12 pojat kata	
162	Male	Vaara	Santeri	JOUKKUE, KUMITE, U16, POJAT	

KARATEN SM KILPAILUT 2024

FINLAND
Asikkalantie 14, 17200 Vääksy

2024.04.06 - 2024.04.06

ENTRY LIST BY CLUB

 Oulun Karateseura(OKS)					
ID	Sex	Family Name	Given Name	Category	
163	Male	Vaara	Santeri	KATA, U16, POJAT	
164	Male	Vaara	Santeri	KUMITE, U16, POJAT, -57KG	

Entries: 22

 Outokummun Karateseura ry(OKS)					
ID	Sex	Family Name	Given Name	Category	
165	Male	Härkönen	Jarno	KATA, MIEHET	
166	Male	Härkönen	Jarno	Kata miehet +40v	
167	Male	Härkönen	Jarno	Kumite miehet 35-50v +75kg	

Entries: 3

 Parkanon Kampailuseura ry.(Pnokamp)					
ID	Sex	Family Name	Given Name	Category	
168	Female	Myllymäki	Maiju	KATA, U18, TYTÖT	
169	Female	Myllymäki	Maiju	KATA, U21, NAISET	

Entries: 2

 Renshin-Kan ry(Renshi)					
ID	Sex	Family Name	Given Name	Category	
170	Female	Anttila	Isabella	KUMITE, U14, TYTÖT, -42KG	
171	Male	Anttila	Ken	KUMITE, U14, POJAT -45KG yhdistetty	
172	Male	Anttila	Paolo	U12 pojat kumite -42kg	
173	Male	Hänninen	Aarni	JOUKKUE, KUMITE, U18, POJAT	
174	Male	Hänninen	Aarni	KUMITE, U18, POJAT, -76KG	
175	Male	Hänninen	Aarni	KUMITE, U21, MIEHET, +67KG yhdistetty	
176	Male	Hänninen	Niilo	KUMITE, U18, POJAT, -76KG	
177	Male	Hänninen	Niilo	JOUKKUE, KUMITE, U18, POJAT	
178	Male	Lintelä	Jami	JOUKKUE, KUMITE, U18, POJAT	
179	Male	Lintelä	Jami	KUMITE, U18, POJAT, +76KG	
180	Male	Mahmood	Zohaib	U12 pojat kumite -42kg	
181	Male	Nurmi	Lalli	KUMITE, MIEHET, +84KG	
182	Male	Nurmi	Lalli	KUMITE, MIEHET, AVOIN	
183	Female	SIITARINEN	OLIVIA	KUMITE, NAISET, AVOIN	
184	Female	SIITARINEN	OLIVIA	KUMITE, U21, NAISET +55kg	
185	Female	SIITARINEN	OLIVIA	KUMITE, NAISET, +68KG	

Entries: 16

 Seigokan Tampere(Seigokan)					
ID	Sex	Family Name	Given Name	Category	
186	Male	Ihanus	Matias	KUMITE, U16, POJAT, -57KG	
187	Male	Marttila	Lauri	KUMITE, U18, POJAT -68KG yhdistetty	
188	Female	Silen	Venla	KUMITE, U16, TYTÖT, +54KG	
189	Female	Väliahdet	Olga	KUMITE, U18, TYTÖT +59KG yhdistetty	

Entries: 4

KARATEN SM KILPAILUT 2024

FINLAND
Asikkalantie 14, 17200 Vääksy

2024.04.06 - 2024.04.06

ENTRY LIST BY CLUB

 Shuyokai Shotokan Karate-Do(Shuyokai)					
ID	Sex	Family Name	Given Name	Category	
190	Female	Rasoli	Arezo	KUMITE, U21, NAISSET +55kg	
191	Female	Rasoli	Asma	U12 tytöt kata	
192	Female	Rasoli	Fatima	KUMITE, U21, NAISSET, -55KG	
193	Female	Wanic	Marie	Kata, U14, tytöt	
194	Male	Wanic	Mark	U12 pojat kata	

Entries: 5

 Sportskarate Kuopio(OM)					
ID	Sex	Family Name	Given Name	Category	
195	Male	Huuskonen	Kosti	KUMITE, U14, POJAT -45KG yhdistetty	
196	Female	Hyvönen	Lila	KUMITE, U14, TYTÖT, -47KG	
197	Female	Katzman	Ester	KUMITE, U14, TYTÖT, -47KG	
198	Male	Lilja	Dani	U12 pojat kumite -42kg	
199	Male	Mattinen	Nuutti	KUMITE, U14, POJAT -45KG yhdistetty	
200	Male	Mattinen	Nuutti	KUMITE, U16, POJAT, -52KG	
201	Male	Ramula	Tuukka	KUMITE, U18, POJAT -68KG yhdistetty	
202	Male	Rekola	Tuomas	KUMITE, U21, MIEHET, -67KG yhdistetty	
203	Female	Rissanen	Iina	KUMITE, U16, TYTÖT -54KG yhdistetty	
204	Female	Rissanen	Iina	KUMITE, U18, TYTÖT -59KG yhdistetty	
205	Female	Savolainen	Elli	u12 tytöt kumite avoin	
206	Female	Savolainen	Meeri	KUMITE, U21, NAISSET, -55KG	
207	Female	Savolainen	Meeri	KUMITE, U18, TYTÖT -59KG yhdistetty	
208	Male	Tameh	Abdulkarim	U12 pojat kumite +42kg	
209	Male	Tameh	Mohammed	KUMITE, U14, POJAT, +55kg	
210	Male	Toivanen	Petri	KUMITE, MIEHET +35v, -75KG yhdistetty	
211	Male	Toivanen	Petri	KUMITE, MIEHET, -75KG	
212	Male	Tuononen	Niko	KUMITE, U16, POJAT, -63KG	
213	Male	Väyrynen	Luukas	KUMITE, U16, POJAT, -57KG	
214	Male	Väyrynen	Luukas	KUMITE, U18, POJAT -68KG yhdistetty	

Entries: 20

 Sportskarate Pori(SKP)					
ID	Sex	Family Name	Given Name	Category	
215	Male	Järvenpää	Tatu	KUMITE, U16, POJAT, -57KG	

Entries: 1

 Sportskarate.fi(SPF)					
ID	Sex	Family Name	Given Name	Category	
216	Female	Chepelev	Sofia	KUMITE, U16, TYTÖT -54KG yhdistetty	
217	Female	Chepelev	Sofia	JOUKKUE, KUMITE, U16, TYTÖT	
218	Male	Eronen	Alex	KUMITE, U16, POJAT +63KG yhdistetty	
219	Male	Honkanen	Santtu	JOUKKUE, KUMITE, U16, POJAT	
220	Male	Honkanen	Santtu	KUMITE, U16, POJAT, -63KG	
221	Female	Itkonen	Janika	KUMITE, U18, TYTÖT -59KG yhdistetty	
222	Female	Itkonen	Janika	KUMITE, U16, TYTÖT -54KG yhdistetty	

KARATEN SM KILPAILUT 2024

FINLAND
Asikkalantie 14, 17200 Vääksy

2024.04.06 - 2024.04.06

ENTRY LIST BY CLUB

 Sportskarate.fi(SPF)					
ID	Sex	Family Name	Given Name	Category	
223	Female	Itkonen	Janika	JOUKKUE, KUMITE, U16, TYTÖT	
224	Female	Keskiivari	Mari	JOUKKUE, KATA, NAISSET	
225	Female	Koivula	Sofia	KUMITE, U18, TYTÖT -59KG yhdistetty	
226	Female	Koivula	Sofia	JOUKKUE, KUMITE, U18, TYTÖT	
227	Female	Korpela	Maria	JOUKKUE, KUMITE, NAISSET	
228	Female	Korpela	Maria	KUMITE, NAISSET, +68KG	
229	Female	Kylmänen	Jenna	JOUKKUE, KATA, NAISSET	
230	Female	Lafghani	Hanan	JOUKKUE, KUMITE, U18, TYTÖT	
231	Female	Lafghani	Hanan	KUMITE, U18, TYTÖT +59KG yhdistetty	
232	Male	Lauronen	Leo	KUMITE, U16, POJAT, -52KG	
233	Male	Lauronen	Leo	JOUKKUE, KUMITE, U16, POJAT	
234	Female	Lehto	Ida	KUMITE, U16, TYTÖT, +54KG	
235	Female	Lehto	Ida	JOUKKUE, KUMITE, U16, TYTÖT	
236	Female	Marttila	Noora	JOUKKUE, KATA, NAISSET	
237	Female	Nikander	Saimi	JOUKKUE, KUMITE, NAISSET	
238	Female	Nikander	Saimi	KUMITE, U21, NAISSET, -55KG	
239	Male	Saadaoui	Sami	JOUKKUE, KUMITE, U16, POJAT	
240	Male	Saadaoui	Sami	KUMITE, U16, POJAT, -57KG	
241	Female	Saadaoui	Sonya	KUMITE, U18, TYTÖT +59KG yhdistetty	
242	Female	Saadaoui	Sonya	JOUKKUE, KUMITE, U18, TYTÖT	
243	Female	Saadaoui	Sonya	KUMITE, U21, NAISSET +55kg	
244	Female	Saarnio	Selja	KUMITE, U16, TYTÖT, +54KG	
245	Female	Voutilainen	Sonja	JOUKKUE, KUMITE, NAISSET	

Entries: 30

 Tapanilan Erä(Erä)					
ID	Sex	Family Name	Given Name	Category	
246	Female	Heino	Daisy	KUMITE, U14, TYTÖT, -42KG	
247	Female	Heino	Daisy	Kata, U14, tytöt	
248	Female	Heino	Lilya	U12 tytöt kata	
249	Female	Heino	Lilya	u12 tytöt kumite avoin	
250	Female	Hohti	Hertta	KUMITE, U14, TYTÖT, +47kg	
251	Female	Lehtinen	Eleanor	KUMITE, U16, TYTÖT -54KG yhdistetty	
252	Female	Mertamo	Amanda	KUMITE, U16, TYTÖT, +54KG	
253	Female	Mertamo	Amanda	KUMITE, U18, TYTÖT +59KG yhdistetty	
254	Female	Salme	Kristiina	KUMITE, U18, TYTÖT -59KG yhdistetty	
255	Female	Salme	Kristiina	KUMITE, U21, NAISSET, -55KG	
256	Male	Säippä	Emil	U12 pojat kata	
257	Male	Säippä	Emil	U12 pojat kumite -42kg	
258	Male	Wolff	Arn	KUMITE, U14, POJAT -55KG yhdistetty	

Entries: 13

 Vantaan Wado Ryu ry(Wado Ryu ry)					
ID	Sex	Family Name	Given Name	Category	
259	Male	Sandgren	Joona	KUMITE, U16, POJAT, -52KG	
260	Male	Sandgren	Joona	KATA, U16, POJAT	

KARATEN SM KILPAILUT 2024

FINLAND
Asikkalantie 14, 17200 Vääksy

2024.04.06 - 2024.04.06

ENTRY LIST BY CLUB

Entries: **2**

Total Entries: **260**

KARATEN SM KILPAILUT 2024

FINLAND
Asikkalantie 14, 17200 Vääksy

2024.04.06 - 2024.04.06

ENTRY LIST

JOUKKUE, KATA, NAISET				
CODE	Sex	Family Name	Given Name	Club / Team / NOC
FIN	Female	Heiskanen	Iines	Japan Karate Association Tampere ry(JKA-Tampere)
FIN	Female	Hintikka	Maria	Japan Karate Association Tampere ry(JKA-Tampere)
FIN	Female	Kallio	Sara	Lahden Karate(LK-FIN)
FIN	Female	Keskiivari	Mari	Sportskarate.fi(SPF)
FIN	Female	Kylmänen	Jenna	Sportskarate.fi(SPF)
FIN	Female	Lantta	Wiivi	Japan Karate Association Tampere ry(JKA-Tampere)
FIN	Female	Lehtinen	Nea	Lahden Karate(LK-FIN)
FIN	Female	Marttila	Noora	Sportskarate.fi(SPF)
FIN	Female	Mänty	Bess	Lahden Karate(LK-FIN)

Entries: 9

JOUKKUE, KUMITE, NAISET				
CODE	Sex	Family Name	Given Name	Club / Team / NOC
FIN	Female	Korpela	Maria	Sportskarate.fi(SPF)
FIN	Female	Nikander	Saimi	Sportskarate.fi(SPF)
FIN	Female	Voutilainen	Sonja	Sportskarate.fi(SPF)

Entries: 3

JOUKKUE, KUMITE, U14, POJAT				
CODE	Sex	Family Name	Given Name	Club / Team / NOC
FIN	Male	Hannu	Eero	Oulun Karataseura(OKS)
FIN	Male	Lähetkangas	Luka	Oulun Karataseura(OKS)
FIN	Male	Takala	Anton	Oulun Karataseura(OKS)

Entries: 3

JOUKKUE, KUMITE, U16, POJAT				
CODE	Sex	Family Name	Given Name	Club / Team / NOC
FIN	Male	Hanhinen	Onni	Jigotai Karate(Jigotai)
FIN	Male	Hirvonen	Jesse	Jigotai Karate(Jigotai)
FIN	Male	Honkanen	Santtu	Sportskarate.fi(SPF)
FIN	Male	Järvenpää	Tatu	Joens Mawashi ry(JM)
FIN	Male	Lauronen	Leo	Sportskarate.fi(SPF)
FIN	Male	Lähetkangas	Luka	Oulun Karataseura(OKS)
FIN	Male	Pienimäki	Roope	Jigotai Karate(Jigotai)
FIN	Male	Pylvänen	Anton	Jigotai Karate(Jigotai)
FIN	Male	Saadaoui	Sami	Sportskarate.fi(SPF)
FIN	Male	Simonen	Rene	Joens Mawashi ry(JM)
FIN	Male	Simonen	Tino	Joens Mawashi ry(JM)
FIN	Male	Takala	Anton	Oulun Karataseura(OKS)
FIN	Male	Tarkkanen	Otso	Jigotai Karate(Jigotai)
FIN	Male	Tkachenko	Timofei	Jigotai Karate(Jigotai)
FIN	Male	Vaara	Santeri	Oulun Karataseura(OKS)

Entries: 15

KARATEN SM KILPAILUT 2024

FINLAND
Asikkalantie 14, 17200 Vääksy

2024.04.06 - 2024.04.06

ENTRY LIST

JOUKKUE, KUMITE, U16, TYTÖT				
CODE	Sex	Family Name	Given Name	Club / Team / NOC
FIN	Female	Chepelev	Sofia	Sportskarate.fi(SPF)
FIN	Female	Itkonen	Janika	Sportskarate.fi(SPF)
FIN	Female	Lehto	Ida	Sportskarate.fi(SPF)

Entries: 3

JOUKKUE, KUMITE, U18, POJAT				
CODE	Sex	Family Name	Given Name	Club / Team / NOC
FIN	Male	Hänninen	Aarni	Renshin-Kan ry(Renshi)
FIN	Male	Hänninen	Niilo	Renshin-Kan ry(Renshi)
FIN	Male	Kreus	Petrus	Japan Karate Association Tampere ry(JKA-Tampere)
FIN	Male	Lintelä	Jami	Renshin-Kan ry(Renshi)
FIN	Male	Mantere	Jimi	Japan Karate Association Tampere ry(JKA-Tampere)
FIN	Male	Nuhanovic	Alsad	Japan Karate Association Tampere ry(JKA-Tampere)

Entries: 6

JOUKKUE, KUMITE, U18, TYTÖT				
CODE	Sex	Family Name	Given Name	Club / Team / NOC
FIN	Female	Koivula	Sofia	Sportskarate.fi(SPF)
FIN	Female	Lafghani	Hanan	Sportskarate.fi(SPF)
FIN	Female	Saadaoui	Sonya	Sportskarate.fi(SPF)

Entries: 3

Kata miehet +40v				
CODE	Sex	Family Name	Given Name	Club / Team / NOC
FIN	Male	Casci	Giangabriele	JKS Finland - Shotokan Karate Helsinki(JKS Finland)
FIN	Male	Härkönen	Jarno	Outokummun Karateseura ry(OKS)
FIN	Male	Tuominen	Vesa	Hyvinkään Shotokan karate ry(Vesa)

Entries: 3

Kata sovellettu				
CODE	Sex	Family Name	Given Name	Club / Team / NOC
FIN	Male	Lehtinen	Tuomas	Lahden Karate(LK-FIN)
FIN	Male	Mäenpää	Jaakko	Lahden Karate(LK-FIN)

Entries: 2

KATA, MIEHET				
CODE	Sex	Family Name	Given Name	Club / Team / NOC
FIN	Male	Härkönen	Jarno	Outokummun Karateseura ry(OKS)
FIN	Male	Järvinen	Otso	Japan Karate Association Tampere ry(JKA-Tampere)
FIN	Male	Takala	Akseli	Oulun Karateseura(OKS)

Entries: 3

KARATEN SM KILPAILUT 2024

FINLAND
Asikkalantie 14, 17200 Vääksy

2024.04.06 - 2024.04.06

ENTRY LIST

KATA, NAISET				
CODE	Sex	Family Name	Given Name	Club / Team / NOC
FIN	Female	Hintikka	Maria	Japan Karate Association Tampere ry(JKA-Tampere)
FIN	Female	Lehtinen	Nea	Lahden Karate(LK-FIN)
FIN	Female	Mänty	Bess	Lahden Karate(LK-FIN)
FIN	Female	Sihvonen	Ella	Budoseura Oulun Musokai Ry(Musokai)

Entries: 4

Kata, U14, pojat				
CODE	Sex	Family Name	Given Name	Club / Team / NOC
FIN	Male	Hannu	Eero	Budoseura Oulun Musokai Ry(Musokai)
FIN	Male	Kella	Kasper	Lahden Karate(LK-FIN)
FIN	Male	Kivikoski	Jere	Lahden Karate(LK-FIN)
FIN	Male	Lähetkangas	Luka	Oulun Karateseura(OKS)
FIN	Male	Takala	Anton	Oulun Karateseura(OKS)

Entries: 5

Kata, U14, tytöt				
CODE	Sex	Family Name	Given Name	Club / Team / NOC
FIN	Female	Alatalo	Vanamo	JKS Finland - Shotokan Karate Helsinki(JKS Finland)
FIN	Female	Antinkaapo	Nea	Jigotai Karate(Jigotai)
FIN	Female	Haven	Sara	Lahden Karate(LK-FIN)
FIN	Female	Heino	Daisy	Tapanilan Erä(Erä)
FIN	Female	Kinnunen	Anni	Lahden Karate(LK-FIN)
FIN	Female	Korpela	Siiri	Oulun Karateseura(OKS)
FIN	Female	Lindström	Meri	Lahden Karate(LK-FIN)
FIN	Female	Ollikainen	Saara	Budoseura Oulun Musokai Ry(Musokai)
FIN	Female	Ortiz	Antonia	JKS Finland - Shotokan Karate Helsinki(JKS Finland)
FIN	Female	Stefanski	Vanessa	Lahden Karate(LK-FIN)
FIN	Female	Vuorinen	Alma	Lahden Karate(LK-FIN)
FIN	Female	Vuorinen	Elin	Lahden Karate(LK-FIN)
FIN	Female	Wanic	Marie	Shuyokai Shotokan Karate-Do(Shuyokai)

Entries: 13

KATA, U16, POJAT				
CODE	Sex	Family Name	Given Name	Club / Team / NOC
FIN	Male	Heiska	Oskari	Hyvinkään Shotokan karate ry(Vesa)
FIN	Male	Hirvonen	Jesse	Jigotai Karate(Jigotai)
FIN	Male	Huuskonen	Veeti	Lahden Karate(LK-FIN)
FIN	Male	Kivimäki	Veikko	Lahden Karate(LK-FIN)
FIN	Male	Pienimäki	Roope	Jigotai Karate(Jigotai)
FIN	Male	Sandgren	Joonas	Vantaan Wado Ryu ry(Wado Ryu ry)
FIN	Male	Tarkkanen	Otso	Jigotai Karate(Jigotai)
FIN	Male	Tkachenko	Timofei	Jigotai Karate(Jigotai)
FIN	Male	Vaara	Santeri	Oulun Karateseura(OKS)

Entries: 9

KARATEN SM KILPAILUT 2024

FINLAND
Asikkalantie 14, 17200 Vääksy

2024.04.06 - 2024.04.06

ENTRY LIST

KATA, U16, TYTÖT				
CODE	Sex	Family Name	Given Name	Club / Team / NOC
FIN	Female	Ahonen	Venla	Lahden Karate(LK-FIN)
FIN	Female	Hannu	Alva	Budoseura Oulun Musokai Ry(Musokai)
FIN	Female	Kallio	Sara	Lahden Karate(LK-FIN)
FIN	Female	Kenttä	Hilda	Oulun Karateseura(OKS)
FIN	Female	Kuusi	Nika	Hämeenlinnan Karateseura(HKS)
FIN	Female	Tammela	Iitu	Hämeenlinnan Karateseura(HKS)

Entries: 6

KATA, U18, TYTÖT				
CODE	Sex	Family Name	Given Name	Club / Team / NOC
FIN	Female	Alatalo	Onerva	JKS Finland - Shotokan Karate Helsinki(JKS Finland)
FIN	Female	Heiskanen	Iina	Japan Karate Association Tampere ry(JKA-Tampere)
FIN	Female	Kuusi	Nika	Hämeenlinnan Karateseura(HKS)
FIN	Female	Meyke	Alexandra	JKS Finland - Shotokan Karate Helsinki(JKS Finland)
FIN	Female	Myllymäki	Maiju	Parkanon Kampailuseura ry.(Pnokamp)

Entries: 5

KATA, U21, MIEHET				
CODE	Sex	Family Name	Given Name	Club / Team / NOC
FIN	Male	Lehtinen	Jesse	Lahden Karate(LK-FIN)
FIN	Male	Takala	Akseli	Oulun Karateseura(OKS)

Entries: 2

KATA, U21, NAISET				
CODE	Sex	Family Name	Given Name	Club / Team / NOC
FIN	Female	Lantta	Wiivi	Japan Karate Association Tampere ry(JKA-Tampere)
FIN	Female	Lehtinen	Nea	Lahden Karate(LK-FIN)
FIN	Female	Myllymäki	Maiju	Parkanon Kampailuseura ry.(Pnokamp)
FIN	Female	Sihvonen	Ella	Budoseura Oulun Musokai Ry(Musokai)

Entries: 4

Kumite miehet 35-50v +75kg				
CODE	Sex	Family Name	Given Name	Club / Team / NOC
FIN	Male	Härkönen	Jarno	Outokummun Karateseura ry(OKS)
FIN	Male	Rasila	Petri	kushin-kan (kushin-kan)

Entries: 2

KUMITE, MIEHET +35v, -75KG yhdistetty				
CODE	Sex	Family Name	Given Name	Club / Team / NOC
FIN	Male	Luukka	Eki	Kotka thaiboxing club(Ktbc)
FIN	Male	Toivanen	Petri	Sportkarate Kuopio(OM)

Entries: 2

KARATEN SM KILPAILUT 2024

FINLAND
Asikkalantie 14, 17200 Vääksy

2024.04.06 - 2024.04.06

ENTRY LIST

KUMITE, MIEHET, +84KG					
CODE	Sex	Family Name	Given Name	Club / Team / NOC	
FIN	Male	Khalifa	Miidu	Oulun Karateseura(OKS)	
FIN	Male	Nurmi	Lalli	Renshin-Kan ry(Renshi)	

Entries: 2

Kumite, miehet, -67kg yhdistetty					
CODE	Sex	Family Name	Given Name	Club / Team / NOC	
FIN	Male	Lehtinen	Jesse	Lahden Karate(LK-FIN)	
FIN	Male	Saario	Leevi	Lahden Karate(LK-FIN)	

Entries: 2

KUMITE, MIEHET, -75KG					
CODE	Sex	Family Name	Given Name	Club / Team / NOC	
FIN	Male	Banauliker	Kartik-Otto	Budokwai ry Karate(Budokwai Karate)	
FIN	Male	Luukka	Eki	Kotka thaiboxing club(Ktbc)	
FIN	Male	Toivanen	Petri	Sportskarate Kuopio(OM)	

Entries: 3

KUMITE, MIEHET, -84KG					
CODE	Sex	Family Name	Given Name	Club / Team / NOC	
FIN	Male	Kulovuori	Björn	JKS Finland - Shotokan Karate Helsinki(JKS Finland)	
FIN	Male	Mantere	Jimi	Hämeenlinnan Karateseura(HKS)	
FIN	Male	Mantere	Niko	Hämeenlinnan Karateseura(HKS)	

Entries: 3

KUMITE, MIEHET, AVOIN					
CODE	Sex	Family Name	Given Name	Club / Team / NOC	
FIN	Male	Khalifa	Miidu	Oulun Karateseura(OKS)	
FIN	Male	Mantere	Niko	Hämeenlinnan Karateseura(HKS)	
FIN	Male	Nurmi	Lalli	Renshin-Kan ry(Renshi)	
FIN	Male	Vink	Jeffrey	JKS Finland - Shotokan Karate Helsinki(JKS Finland)	

Entries: 4

KUMITE, NAISET, +68KG					
CODE	Sex	Family Name	Given Name	Club / Team / NOC	
FIN	Female	Keinänen	Titta	Euran karateseura(EKS)	
FIN	Female	Korpela	Maria	Sportskarate.fi(SPF)	
FIN	Female	SIITARINEN	OLIVIA	Renshin-Kan ry(Renshi)	

Entries: 3

KUMITE, NAISET, -68KG					
CODE	Sex	Family Name	Given Name	Club / Team / NOC	
FIN	Female	Koponen	Kiia	Lahden Karate(LK-FIN)	
FIN	Female	Seppälä	Saana	Lempäälän Shotokan Karate(JKA Lempäälä)	

Entries: 2

KARATEN SM KILPAILUT 2024

FINLAND
Asikkalantie 14, 17200 Vääksy

2024.04.06 - 2024.04.06

ENTRY LIST

KUMITE, NAISET, AVOIN				
CODE	Sex	Family Name	Given Name	Club / Team / NOC
FIN	Female	Keinänen	Titta	Euran karateseura(EKS)
FIN	Female	Koponen	Kiia	Lahden Karate(LK-FIN)
FIN	Female	Seppälä	Saana	Lempäälän Shotokan Karate(JKA Lempäälä)
FIN	Female	SIITARINEN	OLIVIA	Renshin-Kan ry(Renshi)

Entries: 4

KUMITE, U14, POJAT -45KG yhdistetty				
CODE	Sex	Family Name	Given Name	Club / Team / NOC
FIN	Male	Anttila	Ken	Renshin-Kan ry(Renshi)
FIN	Male	Huuskonen	Kosti	Sportskarate Kuopio(OM)
FIN	Male	Karma	Emil	Budokwai ry Karate(Budokwai Karate)
FIN	Male	Kella	Kasper	Lahden Karate(LK-FIN)
FIN	Male	Mattinen	Nuutti	Sportskarate Kuopio(OM)
FIN	Male	Ruottinen	Roope	Budoseura Imatran Kusanku ry(Imatran Kusanku)

Entries: 6

KUMITE, U14, POJAT -55KG yhdistetty				
CODE	Sex	Family Name	Given Name	Club / Team / NOC
FIN	Male	Hannu	Eero	Budoseura Oulun Musokai Ry(Musokai)
FIN	Male	Keltto	Topias	Lakeuden Karate-Jutsu Ry(LKJ)
FIN	Male	Lämsä	Luka	Kotka thaiboxing club(Ktbc)
FIN	Male	Muurinaho	Luka	Japan Karate Association Tampere ry(JKA-Tampere)
FIN	Male	Vesterinen	Max	Mäntsälän Karate(Mäntsälän Karate)
FIN	Male	Wolff	Arn	Tapanilan Erä(Erä)

Entries: 6

KUMITE, U14, POJAT, +55kg				
CODE	Sex	Family Name	Given Name	Club / Team / NOC
FIN	Male	Lähetkangas	Luka	Oulun Karateseura(OKS)
FIN	Male	Takala	Anton	Oulun Karateseura(OKS)
FIN	Male	Tameh	Mohammed	Sportskarate Kuopio(OM)
FIN	Male	Vartiainen	Juuso	Joen Mawashi ry(JM)

Entries: 4

KUMITE, U14, TYTÖT, +47kg				
CODE	Sex	Family Name	Given Name	Club / Team / NOC
FIN	Female	Hohti	Hertta	Tapanilan Erä(Erä)
FIN	Female	Korpela	Siiri	Oulun Karateseura(OKS)
FIN	Female	Monti	Sofia	Joen Mawashi ry(JM)
FIN	Female	Ollikainen	Saara	Budoseura Oulun Musokai Ry(Musokai)
FIN	Female	Stefanski	Vanessa	Lahden Karate(LK-FIN)

Entries: 5

KUMITE, U14, TYTÖT, -42KG				
CODE	Sex	Family Name	Given Name	Club / Team / NOC
FIN	Female	Antinkaapo	Nea	Jigotai Karate(Jigotai)

KARATEN SM KILPAILUT 2024

FINLAND
Asikkalantie 14, 17200 Vääksy

2024.04.06 - 2024.04.06

ENTRY LIST

KUMITE, U14, TYTÖT, -42KG				
CODE	Sex	Family Name	Given Name	Club / Team / NOC
FIN	Female	Anttila	Isabella	Renshin-Kan ry(Renshi)
FIN	Female	Heino	Daisy	Tapanilan Erä(Erä)

Entries: 3

KUMITE, U14, TYTÖT, -47KG				
CODE	Sex	Family Name	Given Name	Club / Team / NOC
FIN	Female	Hyvönen	Lila	Sportskarate Kuopio(OM)
FIN	Female	Katzman	Ester	Sportskarate Kuopio(OM)
FIN	Female	Leisti	Charuphat	Kotka thaiboxing club(Ktbc)
FIN	Female	Nuhanovic	Haska	Japan Karate Association Tampere ry(JKA-Tampere)

Entries: 4

KUMITE, U16, POJAT +63KG yhdistetty				
CODE	Sex	Family Name	Given Name	Club / Team / NOC
FIN	Male	Algahawi	Yakoot	Budokwai ry Karate(Budokwai Karate)
FIN	Male	Eronen	Alex	Sportskarate.fi(SPF)
FIN	Male	Huuskonen	Veeti	Lahden Karate(LK-FIN)
FIN	Male	Pienimäki	Roope	Jigotai Karate(Jigotai)
FIN	Male	Pylvänen	Anton	Jigotai Karate(Jigotai)

Entries: 5

KUMITE, U16, POJAT, -52KG				
CODE	Sex	Family Name	Given Name	Club / Team / NOC
FIN	Male	Hanhinen	Onni	Jigotai Karate(Jigotai)
FIN	Male	Kettunen	Eemeli	Hämeenlinnan Karateseura(HKS)
FIN	Male	Lauronen	Leo	Sportskarate.fi(SPF)
FIN	Male	Mattinen	Nuutti	Sportskarate Kuopio(OM)
FIN	Male	Sandgren	Joona	Vantaan Wado Ryu ry(Wado Ryu ry)
FIN	Male	Tarkkanen	Otso	Jigotai Karate(Jigotai)
FIN	Male	Tikkanen	Elias	Kotka thaiboxing club(Ktbc)
FIN	Male	Tkachenko	Timofei	Jigotai Karate(Jigotai)

Entries: 8

KUMITE, U16, POJAT, -57KG				
CODE	Sex	Family Name	Given Name	Club / Team / NOC
FIN	Male	Hirvonen	Jesse	Jigotai Karate(Jigotai)
FIN	Male	Ihanus	Matias	Seigokan Tampere(Seigokan)
FIN	Male	Järvenpää	Tatu	Sportskarate Pori(SKP)
FIN	Male	Matero	Luka	Joen Mawashi ry(JM)
FIN	Male	Saadaoui	Sami	Sportskarate.fi(SPF)
FIN	Male	Simonen	Tino	Joen Mawashi ry(JM)
FIN	Male	Vaara	Santeri	Oulun Karateseura(OKS)
FIN	Male	Väyrynen	Luukas	Sportskarate Kuopio(OM)

Entries: 8

KARATEN SM KILPAILUT 2024

FINLAND
Asikkalantie 14, 17200 Vääksy

2024.04.06 - 2024.04.06

ENTRY LIST

KUMITE, U16, POJAT, -63KG				
CODE	Sex	Family Name	Given Name	Club / Team / NOC
FIN	Male	Honkanen	Santtu	Sportskarate.fi(SPF)
FIN	Male	Simonen	Rene	Joen Mawashi ry(JM)
FIN	Male	Tuononen	Niko	Sportskarate Kuopio(OM)

Entries: 3

KUMITE, U16, TYTÖT -54KG yhdistetty				
CODE	Sex	Family Name	Given Name	Club / Team / NOC
FIN	Female	Chepelev	Sofia	Sportskarate.fi(SPF)
FIN	Female	Hannu	Alva	Budoseura Oulun Musokai Ry(Musokai)
FIN	Female	Itkonen	Janika	Sportskarate.fi(SPF)
FIN	Female	Kenttä	Hilda	Oulun Karateseura(OKS)
FIN	Female	Lehtinen	Eleanor	Tapanilan Erä(Erä)
FIN	Female	Luukka	Erin	Kotka thaiboxing club(Ktbc)
FIN	Female	Rissanen	Iina	Sportskarate Kuopio(OM)

Entries: 7

KUMITE, U16, TYTÖT, +54KG				
CODE	Sex	Family Name	Given Name	Club / Team / NOC
FIN	Female	Jokinen	Helmi	Hämeenlinnan Karateseura(HKS)
FIN	Female	Lehto	Ida	Sportskarate.fi(SPF)
FIN	Female	Mertamo	Amanda	Tapanilan Erä(Erä)
FIN	Female	Saarnio	Selja	Sportskarate.fi(SPF)
FIN	Female	Silen	Venla	Seigokan Tampere(Seigokan)

Entries: 5

KUMITE, U18, POJAT -68KG yhdistetty				
CODE	Sex	Family Name	Given Name	Club / Team / NOC
FIN	Male	Marttila	Lauri	Seigokan Tampere(Seigokan)
FIN	Male	Matero	Jimi	Joen Mawashi ry(JM)
FIN	Male	Nurmesniemi	Lauri	Lakeuden Karate-Jutsu Ry(LKJ)
FIN	Male	Ramula	Tuukka	Sportskarate Kuopio(OM)
FIN	Male	Tolvanen	Mido	Joen Mawashi ry(JM)
FIN	Male	Väyrynen	Luukas	Sportskarate Kuopio(OM)

Entries: 6

KUMITE, U18, POJAT, +76KG				
CODE	Sex	Family Name	Given Name	Club / Team / NOC
FIN	Male	Lintelä	Jami	Renshin-Kan ry(Renshi)
FIN	Male	Mantere	Jimi	Hämeenlinnan Karateseura(HKS)

Entries: 2

KUMITE, U18, POJAT, -76KG				
CODE	Sex	Family Name	Given Name	Club / Team / NOC
FIN	Male	Hänninen	Aarni	Renshin-Kan ry(Renshi)
FIN	Male	Hänninen	Niilo	Renshin-Kan ry(Renshi)
FIN	Male	Kreus	Petrus	Japan Karate Association Tampere ry(JKA-Tampere)

KARATEN SM KILPAILUT 2024

FINLAND
Asikkalantie 14, 17200 Vääksy

2024.04.06 - 2024.04.06

ENTRY LIST

KUMITE, U18, POJAT, -76KG				
CODE	Sex	Family Name	Given Name	Club / Team / NOC
FIN	Male	Nuhanovic	Alsad	Japan Karate Association Tampere ry(JKA-Tampere)

Entries: 4

KUMITE, U18, TYTÖT +59KG yhdistetty				
CODE	Sex	Family Name	Given Name	Club / Team / NOC
FIN	Female	Jokinen	Helmi	Hämeenlinnan Karateseura(HKS)
FIN	Female	Lafghani	Hanan	Sportskarate.fi(SPF)
FIN	Female	Mertamo	Amanda	Tapanilan Erä(Erä)
FIN	Female	Meyke	Alexandra	JKS Finland - Shotokan Karate Helsinki(JKS Finland)
FIN	Female	Saadaoui	Sonya	Sportskarate.fi(SPF)
FIN	Female	Väliahdet	Olga	Seigokan Tampere(Seigokan)

Entries: 6

KUMITE, U18, TYTÖT -59KG yhdistetty				
CODE	Sex	Family Name	Given Name	Club / Team / NOC
FIN	Female	Itkonen	Janika	Sportskarate.fi(SPF)
FIN	Female	Koivula	Sofia	Sportskarate.fi(SPF)
FIN	Female	Paattimäki	Aliisa	Japan Karate Association Tampere ry(JKA-Tampere)
FIN	Female	Rissanen	Iina	Sportskarate Kuopio(OM)
FIN	Female	Salme	Kristiina	Tapanilan Erä(Erä)
FIN	Female	Savolainen	Meeri	Sportskarate Kuopio(OM)

Entries: 6

KUMITE, U21, MIEHET, +67KG yhdistetty				
CODE	Sex	Family Name	Given Name	Club / Team / NOC
FIN	Male	Banauliker	Kartik-Otto	Budokwai ry Karate(Budokwai Karate)
FIN	Male	Hänninen	Aarni	Renshin-Kan ry(Renshi)
FIN	Male	Kelto	Matias	Lakeuden Karate-Jutsu Ry(LKJ)

Entries: 3

KUMITE, U21, MIEHET, -67KG yhdistetty				
CODE	Sex	Family Name	Given Name	Club / Team / NOC
FIN	Male	Lehtinen	Jesse	Lahden Karate(LK-FIN)
FIN	Male	Rekola	Tuomas	Sportskarate Kuopio(OM)
FIN	Male	Saario	Leevi	Lahden Karate(LK-FIN)

Entries: 3

KUMITE, U21, NAISET +55kg				
CODE	Sex	Family Name	Given Name	Club / Team / NOC
FIN	Female	Koponen	Kiia	Lahden Karate(LK-FIN)
FIN	Female	Rasoli	Arezo	Shuyokai Shotokan Karate-Do(Shuyokai)
FIN	Female	Saadaoui	Sonya	Sportskarate.fi(SPF)
FIN	Female	SIITARINEN	OLIVIA	Renshin-Kan ry(Renshi)

Entries: 4

KARATEN SM KILPAILUT 2024

FINLAND
Asikkalantie 14, 17200 Vääksy

2024.04.06 - 2024.04.06

ENTRY LIST

KUMITE, U21, NAISET, -55KG				
CODE	Sex	Family Name	Given Name	Club / Team / NOC
FIN	Female	Nikander	Saimi	Sportskarate.fi(SPF)
FIN	Female	Rasoli	Fatima	Shuyokai Shotokan Karate-Do(Shuyokai)
FIN	Female	Salme	Kristiina	Tapanilan Erä(Erä)
FIN	Female	Savolainen	Meeri	Sportskarate Kuopio(OM)

Entries: 4

U12 pojat kata				
CODE	Sex	Family Name	Given Name	Club / Team / NOC
FIN	Male	Bonden	Matias	Lahden Karate(LK-FIN)
FIN	Male	Hannu	Aarre	Budoseura Oulun Musokai Ry(Musokai)
FIN	Male	Larkin	Takehiro	JKS Finland - Shotokan Karate Helsinki(JKS Finland)
FIN	Male	Lehto	Eemeli	Lahden Karate(LK-FIN)
FIN	Male	Säippä	Emil	Tapanilan Erä(Erä)
FIN	Male	Tejesvi	Shashank	Oulun Karataseura(OKS)
FIN	Male	Wanic	Mark	Shuyokai Shotokan Karate-Do(Shuyokai)

Entries: 7

U12 pojat kumite +42kg				
CODE	Sex	Family Name	Given Name	Club / Team / NOC
FIN	Male	Heikkilä	Eliei	Budokwai ry Karate(Budokwai Karate)
FIN	Male	Kullberg	Adam	Budoseura Imatran Kusanku ry(Imatran Kusanku)
FIN	Male	Lehto	Eemeli	Lahden Karate(LK-FIN)
FIN	Male	Tameh	Abdulkarim	Sportskarate Kuopio(OM)

Entries: 4

U12 pojat kumite -35kg				
CODE	Sex	Family Name	Given Name	Club / Team / NOC
FIN	Male	Hannu	Aarre	Budoseura Oulun Musokai Ry(Musokai)
FIN	Male	Kivistö	Hugo	Hämeenlinnan Karataseura(HKS)
FIN	Male	Ralli	Alexi	Budoseura Imatran Kusanku ry(Imatran Kusanku)
FIN	Male	Tejesvi	Shashank	Oulun Karataseura(OKS)

Entries: 4

U12 pojat kumite -42kg				
CODE	Sex	Family Name	Given Name	Club / Team / NOC
FIN	Male	Anttila	Paolo	Renshin-Kan ry(Renshi)
FIN	Male	Bonden	Matias	Lahden Karate(LK-FIN)
FIN	Male	Larkin	Takehiro	JKS Finland - Shotokan Karate Helsinki(JKS Finland)
FIN	Male	Lilja	Dani	Sportskarate Kuopio(OM)
FIN	Male	Luukka	Erkko	Kotka thaiboxing club(Ktbc)
FIN	Male	Mahmood	Zohaib	Renshin-Kan ry(Renshi)
FIN	Male	Säippä	Emil	Tapanilan Erä(Erä)

Entries: 7

KARATEN SM KILPAILUT 2024

FINLAND
Asikkalantie 14, 17200 Vääksy

2024.04.06 - 2024.04.06

ENTRY LIST

U12 tytöt kata

CODE	Sex	Family Name	Given Name	Club / Team / NOC
FIN	Female	Asiala	Erin	Lahden Karate(LK-FIN)
FIN	Female	Heino	Lilya	Tapanilan Erä(Erä)
FIN	Female	Pöllänen	Hilma	Lahden Karate(LK-FIN)
FIN	Female	Pöyhönen	Iida	Lahden Karate(LK-FIN)
FIN	Female	Rasoli	Asma	Shuyokai Shotokan Karate-Do(Shuyokai)

Entries: 5

u12 tytöt kumite avoin

CODE	Sex	Family Name	Given Name	Club / Team / NOC
FIN	Female	Heino	Lilya	Tapanilan Erä(Erä)
FIN	Female	Keskinen	Emilia	Budoseura Imatran Kusanku ry(Imatran Kusanku)
FIN	Female	Nuhanovic	Amina	Japan Karate Association Tampere ry(JKA-Tampere)
FIN	Female	Pöyhönen	Iida	Lahden Karate(LK-FIN)
FIN	Female	Savolainen	Elli	Sportskarate Kuopio(OM)
FIN	Female	Vesikko	Minea	Budoseura Imatran Kusanku ry(Imatran Kusanku)

Entries: 6

Total Entries:260

KARATEN SM KILPAILUT 2024

FINLAND
Asikkalantie 14, 17200 Vääksy

2024.04.06 - 2024.04.06

Statistics

Participating Countries: 1

Participating Regions: 0

Participating Team/Clubs: 28

	Competitors	Entries
Female	73	102
Male	92	130
Total	165	232

Entries per Category

	Entries	Teams
JOUKKUE, KATA, NAISET	-	3
JOUKKUE, KUMITE, NAISET	-	1
JOUKKUE, KUMITE, U14, POJAT	-	1
JOUKKUE, KUMITE, U16, POJAT	-	5
JOUKKUE, KUMITE, U16, TYTÖT	-	1
JOUKKUE, KUMITE, U18, POJAT	-	2
JOUKKUE, KUMITE, U18, TYTÖT	-	1
KATA, MIEHET	3	-
KATA, NAISET	4	-
KATA, U16, POJAT	9	-
KATA, U16, TYTÖT	6	-
KATA, U18, TYTÖT	5	-
KATA, U21, MIEHET	2	-
KATA, U21, NAISET	4	-
KUMITE, MIEHET +35v, -75KG yhdistetty	2	-
KUMITE, MIEHET, +84KG	2	-
KUMITE, MIEHET, -75KG	3	-
KUMITE, MIEHET, -84KG	3	-
KUMITE, MIEHET, AVOIN	4	-
KUMITE, NAISET, +68KG	3	-
KUMITE, NAISET, -68KG	2	-
KUMITE, NAISET, AVOIN	4	-
KUMITE, U14, POJAT -45KG yhdistetty	6	-
KUMITE, U14, POJAT -55KG yhdistetty	6	-
KUMITE, U14, POJAT, +55kg	4	-
KUMITE, U14, TYTÖT, +47kg	5	-
KUMITE, U14, TYTÖT, -42KG	3	-
KUMITE, U14, TYTÖT, -47KG	4	-
KUMITE, U16, POJAT +63KG yhdistetty	5	-
KUMITE, U16, POJAT, -52KG	8	-

KARATEN SM KILPAILUT 2024

FINLAND
Asikkalantie 14, 17200 Vääksy

2024.04.06 - 2024.04.06

Statistics

KUMITE, U16, POJAT, -57KG	8	-
KUMITE, U16, POJAT, -63KG	3	-
KUMITE, U16, TYTÖT -54KG yhdistetty	7	-
KUMITE, U16, TYTÖT, +54KG	5	-
KUMITE, U18, POJAT -68KG yhdistetty	6	-
KUMITE, U18, POJAT, +76KG	2	-
KUMITE, U18, POJAT, -76KG	4	-
KUMITE, U18, TYTÖT +59KG yhdistetty	6	-
KUMITE, U18, TYTÖT -59KG yhdistetty	6	-
KUMITE, U21, MIEHET, +67KG yhdistetty	3	-
KUMITE, U21, MIEHET, -67KG yhdistetty	3	-
KUMITE, U21, NAISET +55kg	4	-
KUMITE, U21, NAISET, -55KG	4	-
Kata miehet +40v	3	-
Kata sovellettu	2	-
Kata, U14, pojat	5	-
Kata, U14, tytöt	13	-
Kumite miehet 35-50v +75kg	2	-
Kumite, miehet, -67kg yhdistetty	2	-
U12 pojat kata	7	-
U12 pojat kumite +42kg	4	-
U12 pojat kumite -35kg	4	-
U12 pojat kumite -42kg	7	-
U12 tytöt kata	5	-
u12 tytöt kumite avoin	6	-
Totals:	218	14

JOUKKUE, KATA, NAISSET

KARATEN SM KILPAILUT 2024
ENTRIES BY WEIGHT CATEGORY
JOUKKUE, KATA, NAISET
As of 7 APR 2024

NOC Code	Gender	Name	Seeding
FIN	F	Heiskanen lines	
FIN	F	Hintikka Maria	
FIN	F	Kallio Sara	
FIN	F	Keskiivari Mari	
FIN	F	Kylmänen Jenna	
FIN	F	Lantta Wiivi	
FIN	F	Lehtinen Nea	
FIN	F	Marttila Noora	
FIN	F	Mänty Bess	

JOUKKUE, KATA, NAISET

KARATEN SM KILPAILUT 2024, Asikkalantie 14, 17200 Vääksy, FIN

2024-04-06

Tatami
1 10:35

Pool
1/1

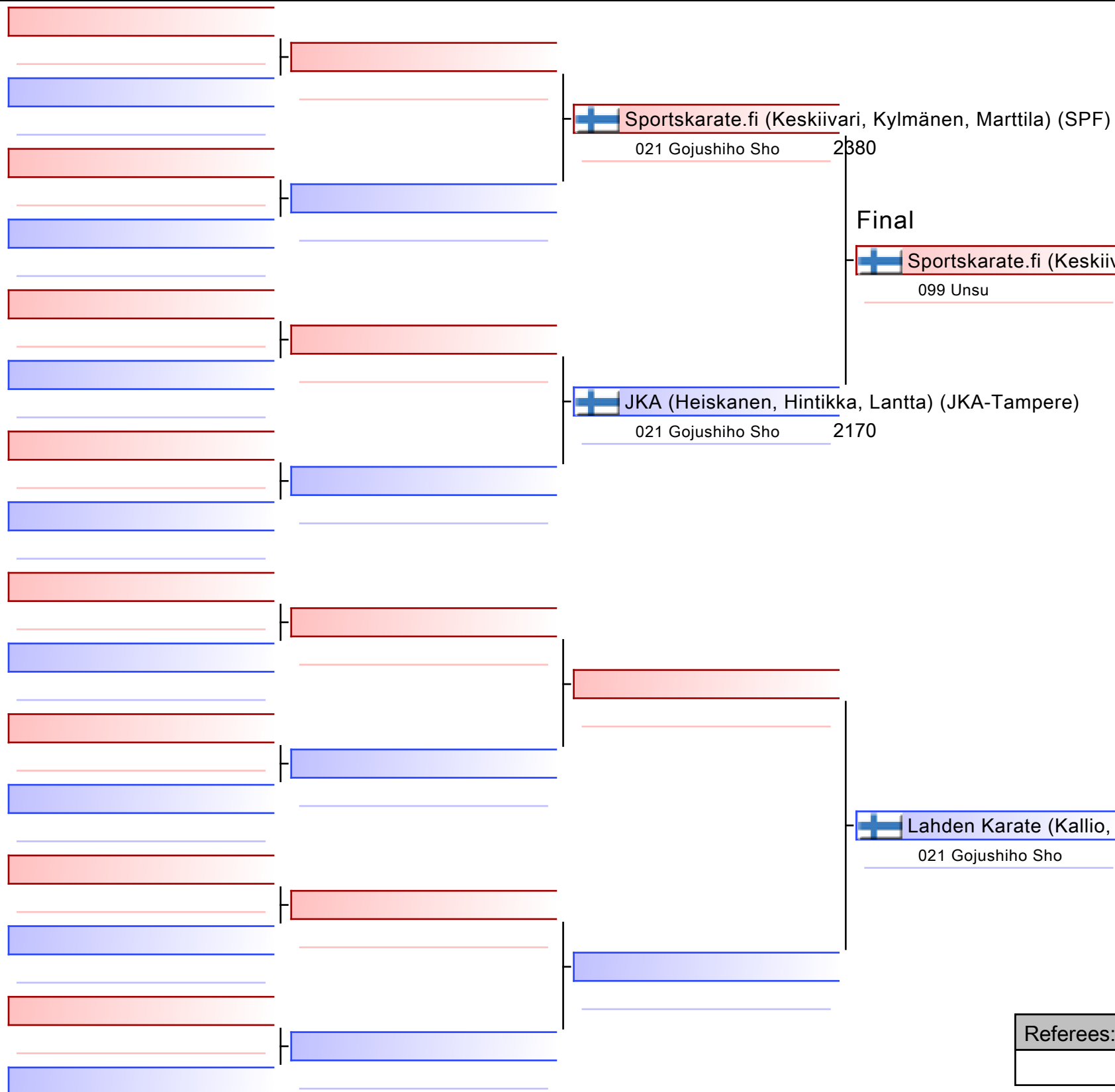

Sportskarate.fi (Keskiivari, Kylmänen, Marttila) (SPF)

1. SPORTSKARATE.FI (SPF)
2. LAHDEN KARATE (LK-FIN)
3. JKA (JKA-TAMPERE)

Referees:			

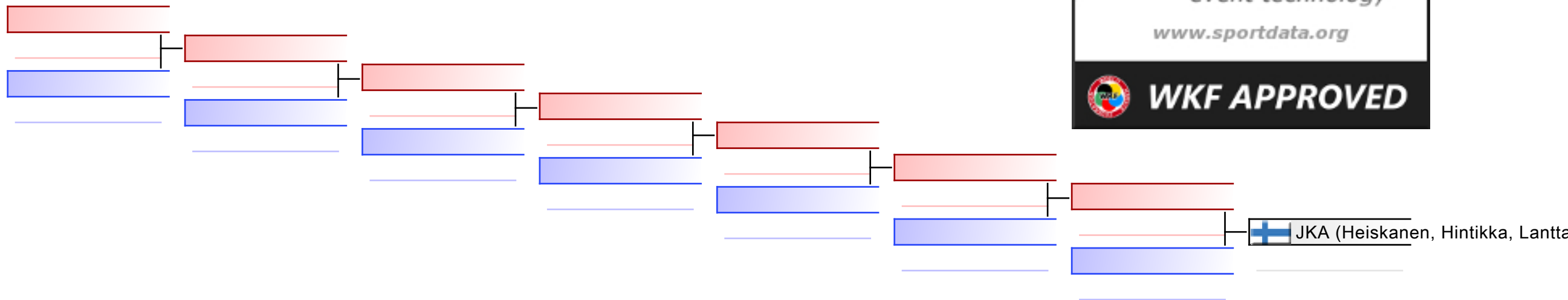

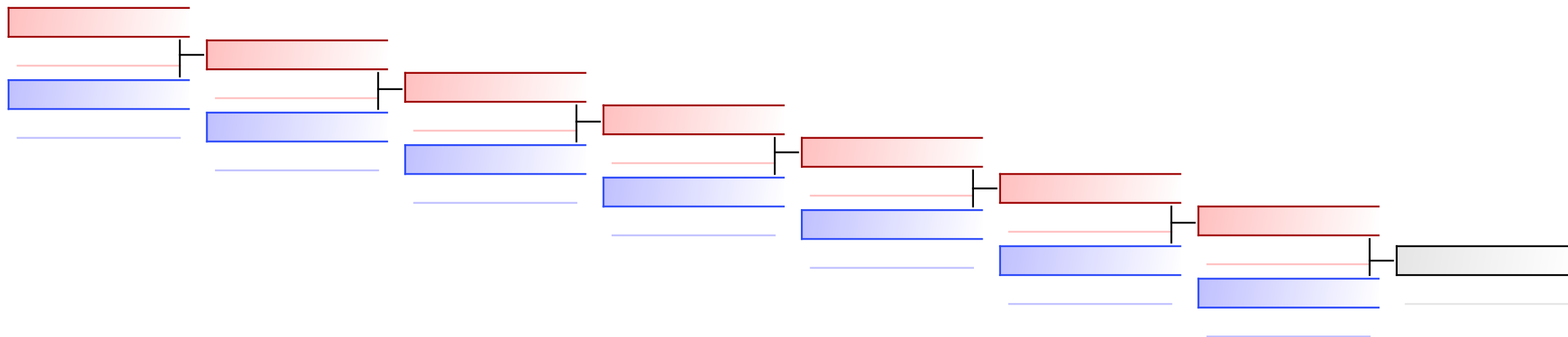

REPECHAGE: (1)



Referees:							
-----------	--	--	--	--	--	--	--

Official Results

JOUKKUE, KATA, NAISET					
1	SPORTSKARATE.FI - MARTTILA NOORA - KYLMÄNEN JENNA - KESKIIVARI MARI	SPORTSKARATE.FI		FIN - FINLAND	
2	LAHDEN KARATE - KALLIO SARA - LEHTINEN NEA - MÄNTY BESS	LAHDEN KARATE		FIN - FINLAND	
3	JKA - LANTTA WIIVI - HINTIKKA MARIA - HEISKANEN IINES	JAPAN KARATE ASSOCIATION TAMPERE RY		FIN - FINLAND	

JOUKKUE, KUMITE, U16, POJAT

KARATEN SM KILPAILUT 2024
ENTRIES BY WEIGHT CATEGORY
JOUKKUE, KUMITE, U16, POJAT
As of 7 APR 2024

NOC Code	Gender	Name	Seeding
FIN	M	Hanhinen Onni	
FIN	M	Hirvonen Jesse	
FIN	M	Honkanen Santtu	
FIN	M	Järvenpää Tatu	
FIN	M	Lauronen Leo	
FIN	M	Lähetkangas Luka	
FIN	M	Pienimäki Roope	
FIN	M	Pylvänen Anton	
FIN	M	Saadaoui Sami	
FIN	M	Simonen Rene	
FIN	M	Simonen Tino	
FIN	M	Takala Anton	
FIN	M	Tarkkanen Otso	
FIN	M	Tkachenko Timofei	
FIN	M	Vaara Santeri	

JOUKKUE, KUMITE, U16, POJAT

KARATEN SM KILPAILUT 2024, Asikkalantie 14, 17200 Vääksy, FIN

2024-04-06

Tatami

3 17:25

Pool

1/1

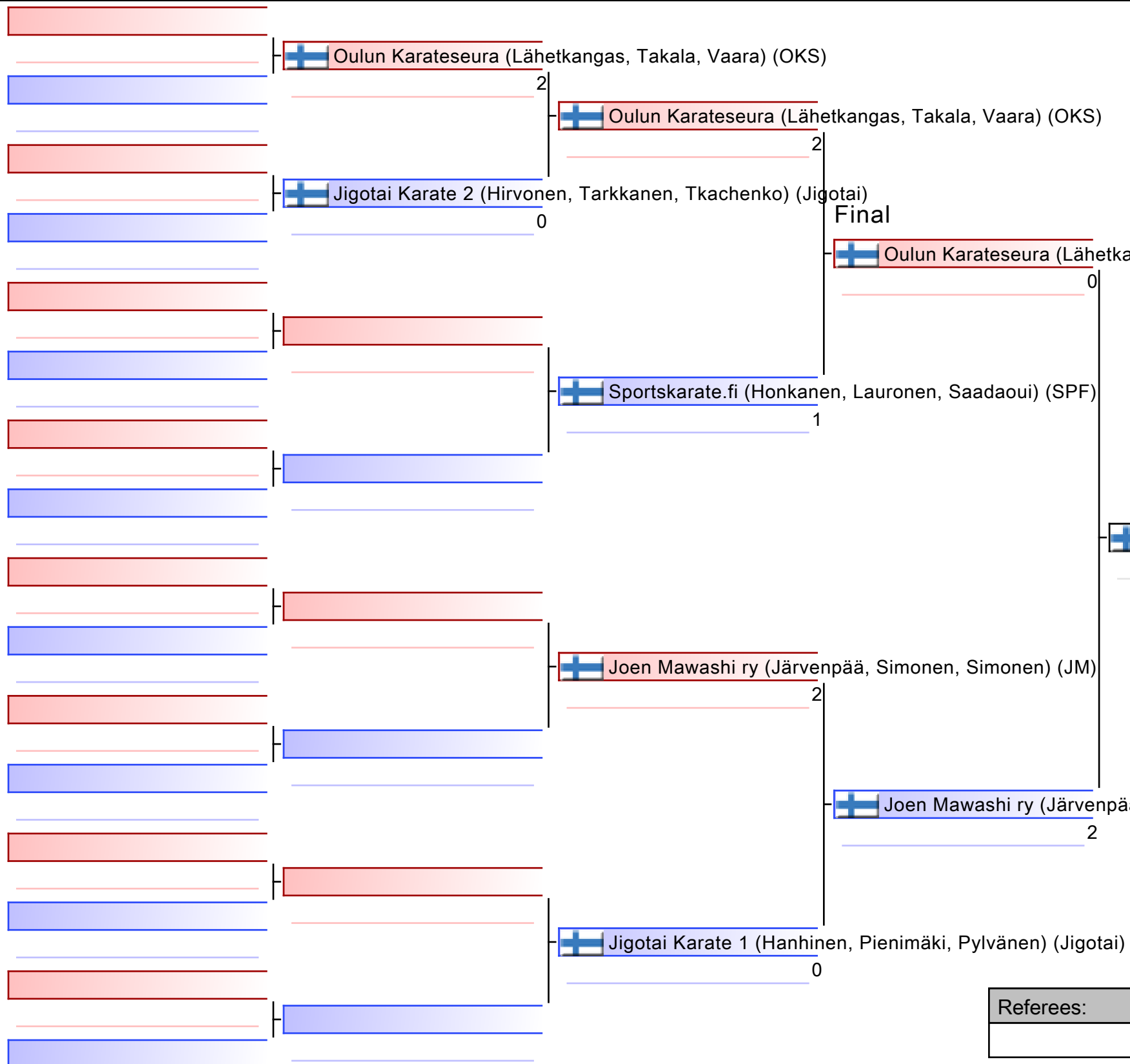

1. JOEN MAWASHI RY (JM)
2. OULUN KARATESEURA (OKS)
3. SPORTSKARATE.FI (SPF)
4. JIGOTAI KARATE 1 (JIGOTAI)
5. JIGOTAI KARATE 2 (JIGOTAI)

Referees:			

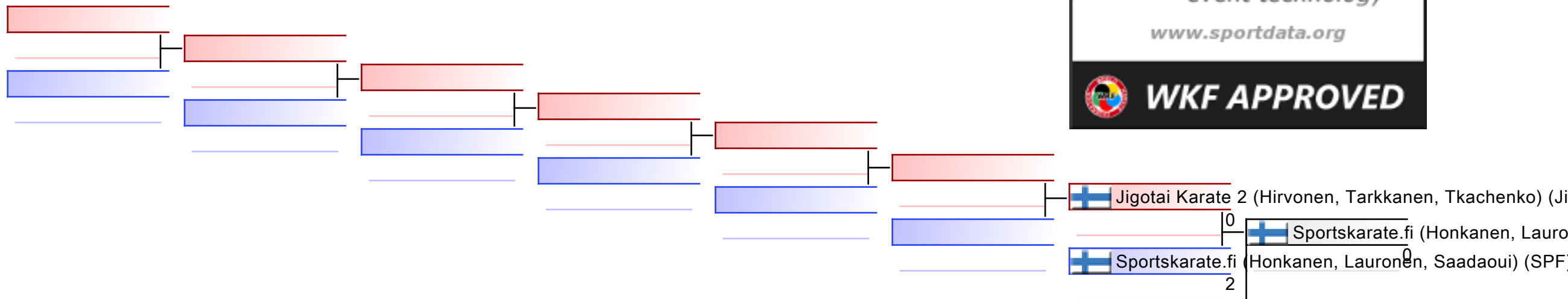



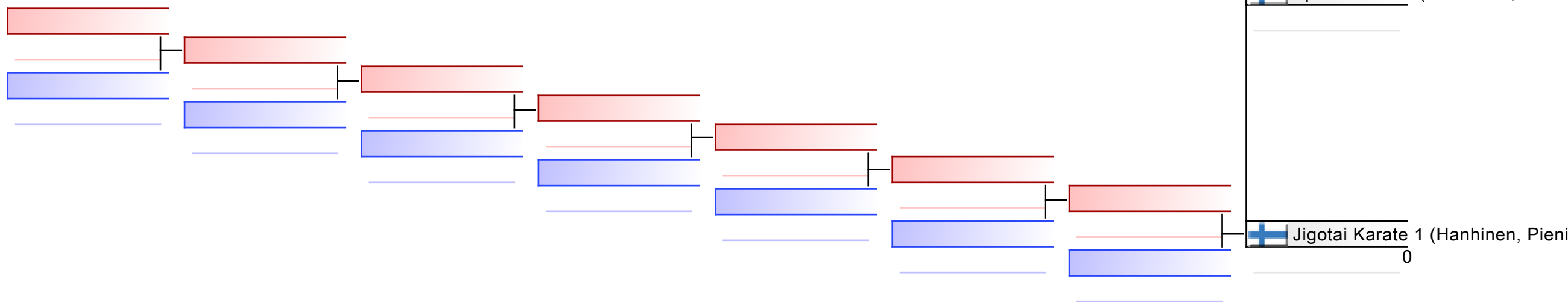

REPECHAGE: (1)



Referees:							
-----------	--	--	--	--	--	--	--

Official Results

JOUKKUE, KUMITE, U16, POJAT					
1	JOEN MAWASHI RY - JÄRVENPÄÄ TATU - SIMONEN RENE - SIMONEN TINO	JOEN MAWASHI RY		FIN - FINLAND	
2	OULUN KARATESEURA - LÄHETKANGAS LUKA - TAKALA ANTON - VAARA SANTERI	OULUN KARATESEURA		FIN - FINLAND	
3	SPORTSKARATE.FI - HONKANEN SANTTU - LAURONEN LEO - SAADAQUI SAMI	SPORTSKARATE.FI		FIN - FINLAND	
4	JIGOTAI KARATE 1 - PYLVÄNEN ANTON - PIENIMÄKI ROOPE - HANHINEN ONNI	JIGOTAI KARATE		FIN - FINLAND	
5	JIGOTAI KARATE 2 - HIRVONEN JESSE - TARKKANEN OTSO - TKACHENKO TIMOFEI	JIGOTAI KARATE		FIN - FINLAND	

JOUKKUE, KUMITE, U18, POJAT

KARATEN SM KILPAILUT 2024
ENTRIES BY WEIGHT CATEGORY
JOUKKUE, KUMITE, U18, POJAT
As of 7 APR 2024

NOC Code	Gender	Name	Seeding
FIN	M	Hänninen Aarni	
FIN	M	Hänninen Niilo	
FIN	M	Kreus Petrus	
FIN	M	Lintelä Jami	
FIN	M	Mantere Jimi	
FIN	M	Nuhanovic Alsad	

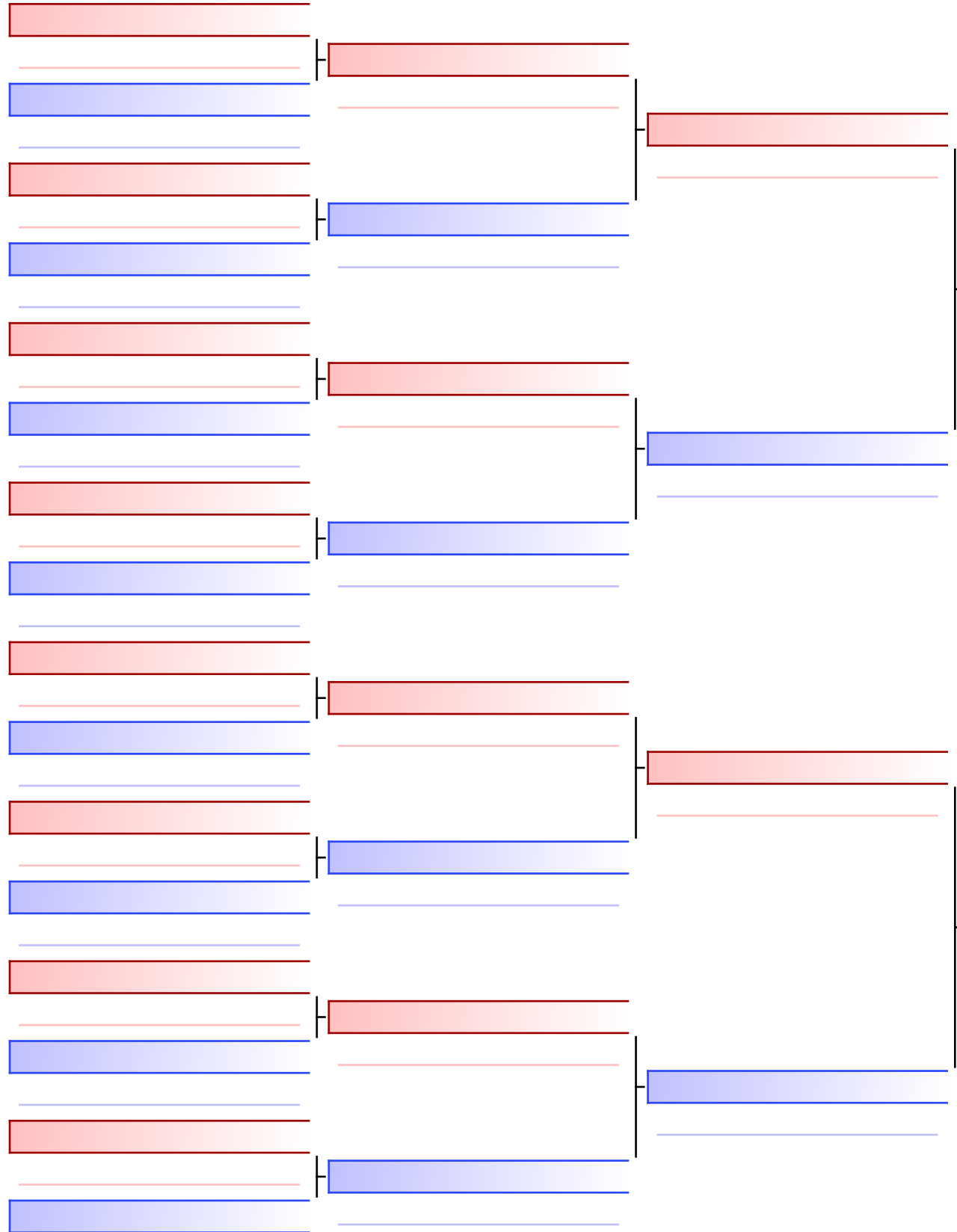

Final

Renshin-Kan ry (Hänninen, Hänninen, Lintelä) (Renshi)
2



JKA-HML (Kreus, Mantere, Nuhanovic) (JKA-Tampere)

JKA-HML (Kreus, Mantere, Nuhanovic) (JKA-Tampere)
7

1. JKA-HML (JKA-TAMPERE)
2. RENSHIN-KAN RY (RENSHI)

Referees:			

Official Results

JOUKKUE, KUMITE, U18, POJAT					
1	JKA-HML - NUHANOVIC ALSAD - KREUS PETRUS - MANTERE JIMI	JAPAN KARATE ASSOCIATION TAMPERE RY		FIN - FINLAND	
2	RENSHIN-KAN RY - HÄNNINEN AARNI - HÄNNINEN NIILLO - LINTELÄ JAMI	RENSHIN-KAN RY		FIN - FINLAND	

KATA, MIEHET

KARATEN SM KILPAILUT 2024
ENTRIES BY WEIGHT CATEGORY
KATA, MIEHET
As of 7 APR 2024

NOC Code	Gender	Name	Seeding
FIN	M	Härkönen Jarno	
FIN	M	Järvinen Otso	
FIN	M	Takala Akseli	

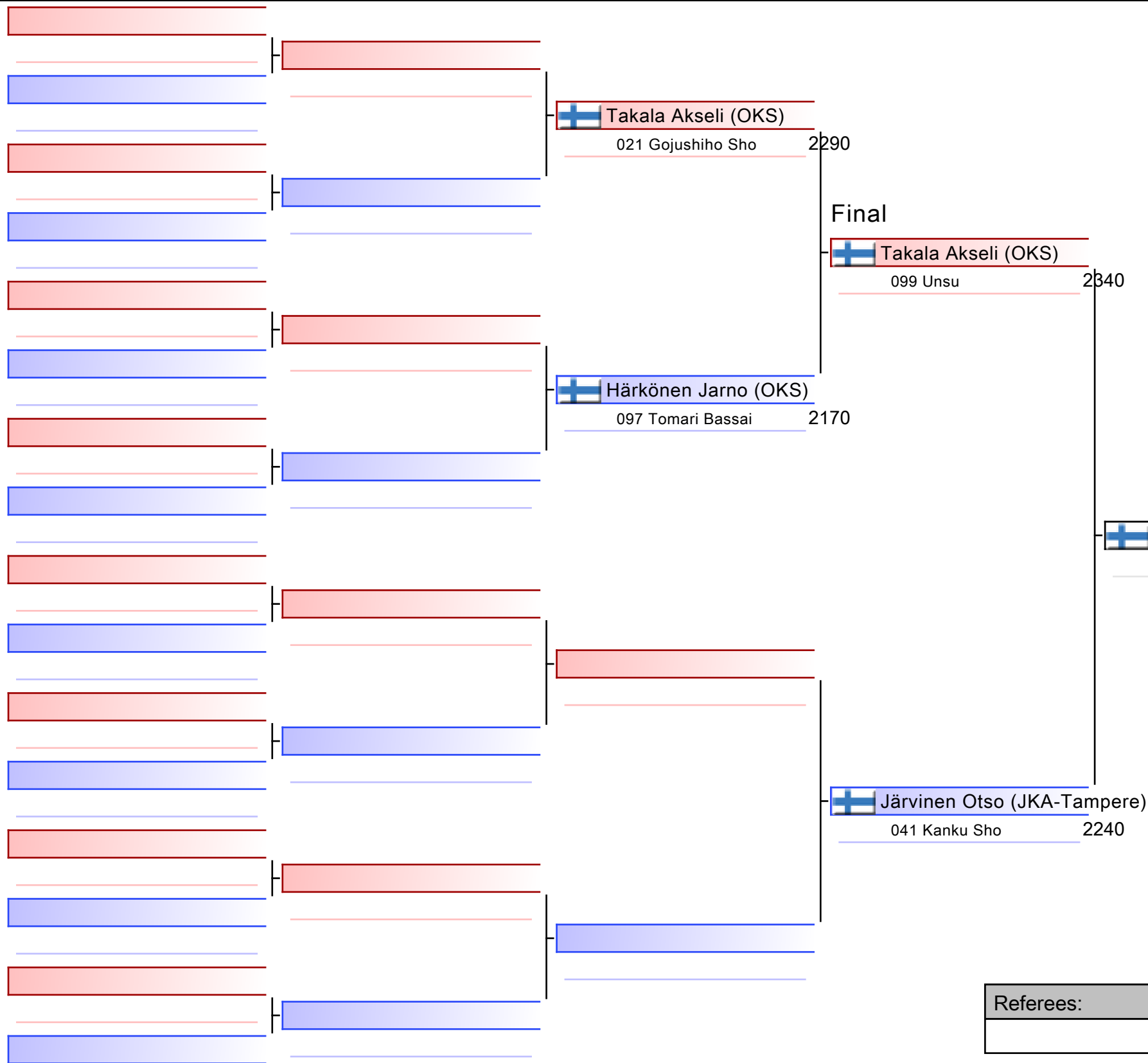

Takala Akseli (OKS)

1. TAKALA AKSELI (OKS)
2. JÄRVINEN OTSO (JKA-TAMPERE)
3. HÄRKÖNEN JARNO (OKS)

Referees:			

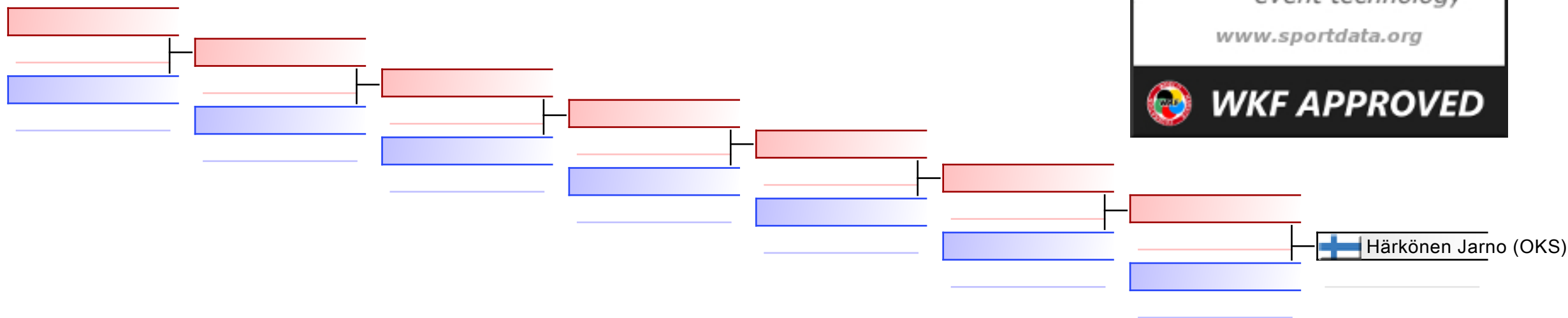

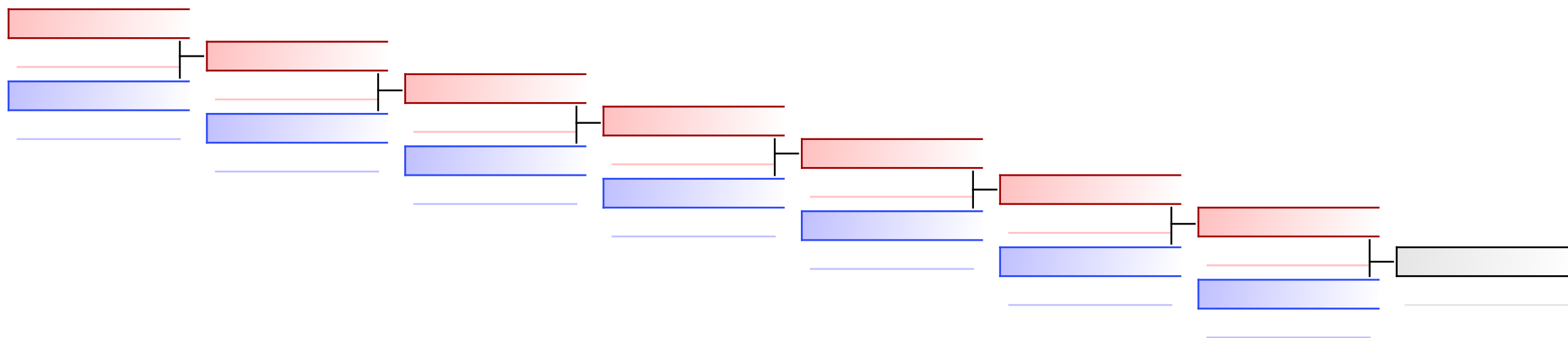

REPECHAGE: (1)



Referees:							
-----------	--	--	--	--	--	--	--

KARATEN SM KILPAILUT 2024 - 2024-04-06

Official Results

KATA, MIEHET				
1	TAKALA AKSELI	OULUN KARATESEURA		FIN - FINLAND
2	JÄRVINEN OTSO	JAPAN KARATE ASSOCIATION TAMPERE RY		FIN - FINLAND
3	HÄRKÖNEN JARNO	OUTOKUMMUN KARATESEURA RY		FIN - FINLAND

KATA, NAISSET

KARATEN SM KILPAILUT 2024
ENTRIES BY WEIGHT CATEGORY
KATA, NAISET
As of 7 APR 2024

NOC Code	Gender	Name	Seeding
FIN	F	Hintikka Maria	
FIN	F	Lehtinen Nea	
FIN	F	Mänty Bess	
FIN	F	Sihvonen Ella	

KATA, NAISET

KARATEN SM KILPAILUT 2024, Asikkalantie 14, 17200 Vääksy, FIN

2024-04-06

Tatami
1 19:00

Pool
1/1

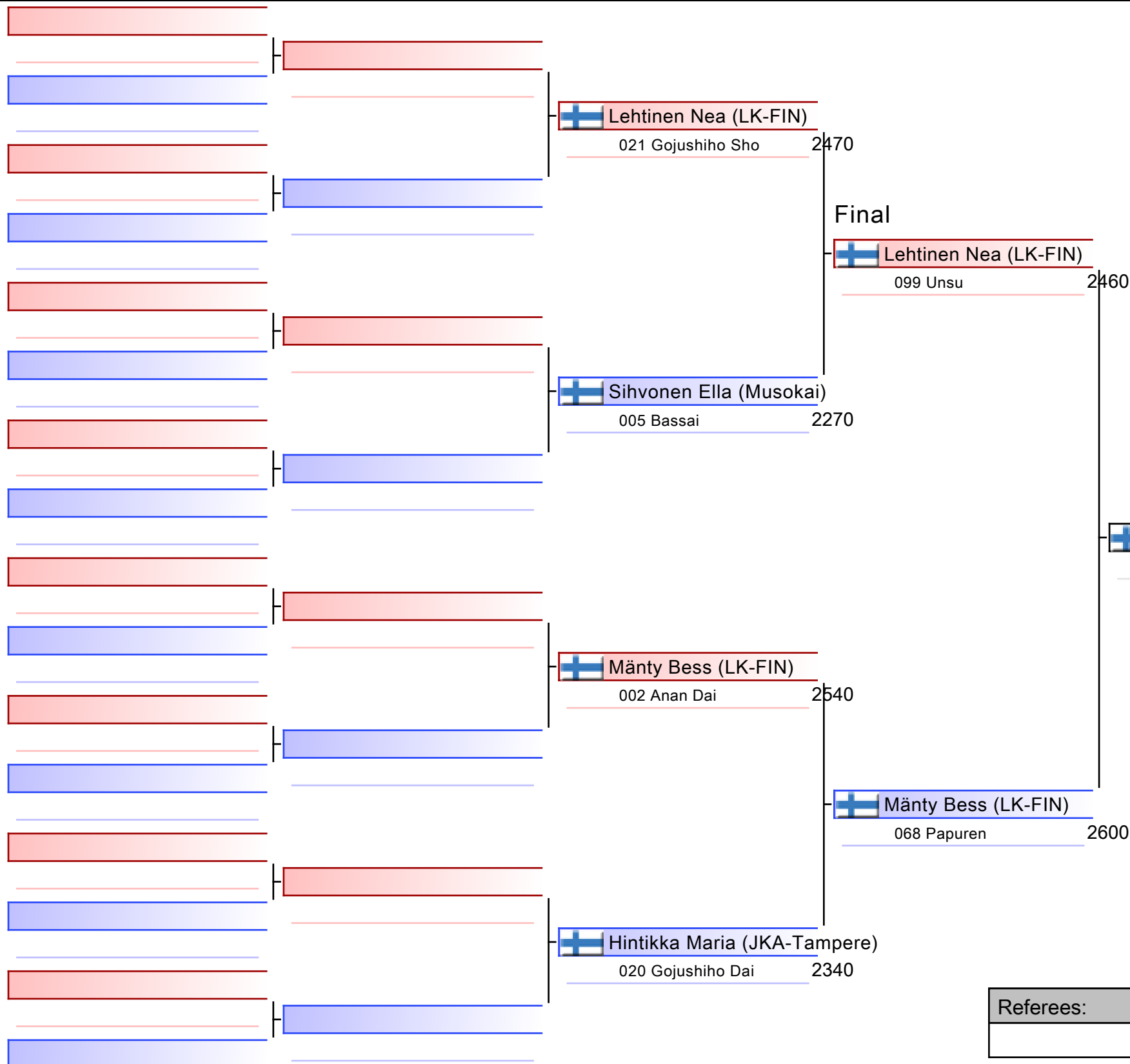



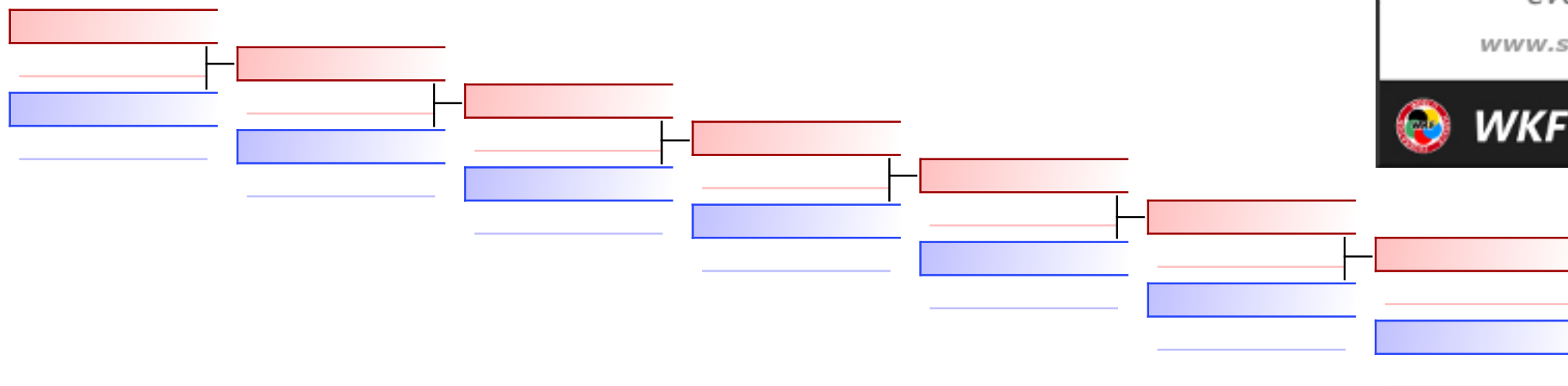

1. MÄNTY BESS (LK-FIN)
2. LEHTINEN NEA (LK-FIN)
3. HINTIKKA MARIA (JKA-TAMPERE)
4. SIHVONEN ELLA (MUSOKAI)

Referees:			

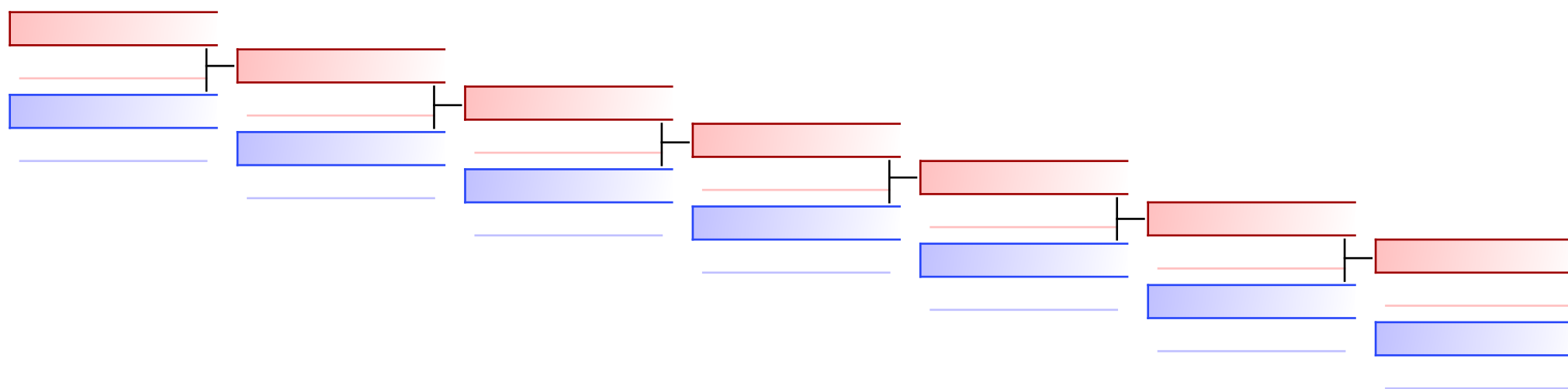





REPECHAGE: (1)



- 
Sihvonen Ella (Musokai)
 048 Kusanku 2210
- 
Hintikka Maria (JKA-Tampere)
- 
Hintikka Maria (JKA-Tampere)
 021 Gojushiho. 2390

Referees:							
-----------	--	--	--	--	--	--	--

Official Results

KATA, NAISET				
1	MÄNTY BESS	LAHDEN KARATE		FIN - FINLAND
2	LEHTINEN NEA	LAHDEN KARATE		FIN - FINLAND
3	HINTIKKA MARIA	JAPAN KARATE ASSOCIATION TAMPERE RY		FIN - FINLAND
4	SIHVONEN ELLA	BUDOSEURA OULUN MUSOKAI RY		FIN - FINLAND

KATA, U16, POJAT

KARATEN SM KILPAILUT 2024
ENTRIES BY WEIGHT CATEGORY
KATA, U16, POJAT
As of 7 APR 2024

NOC Code	Gender	Name	Seeding
FIN	M	Heiska Oskari	
FIN	M	Hirvonen Jesse	
FIN	M	Huuskonen Veeti	
FIN	M	Kivimäki Veikko	
FIN	M	Pienimäki Roope	
FIN	M	Sandgren Joonas	
FIN	M	Tarkkanen Otso	
FIN	M	Tkachenko Timofei	
FIN	M	Vaara Santeri	

KATA, U16, POJAT

KARATEN SM KILPAILUT 2024, Asikkalantie 14, 17200 Vääksy, FIN

2024-04-06

Tatami
2 10:15

Pool
1/1

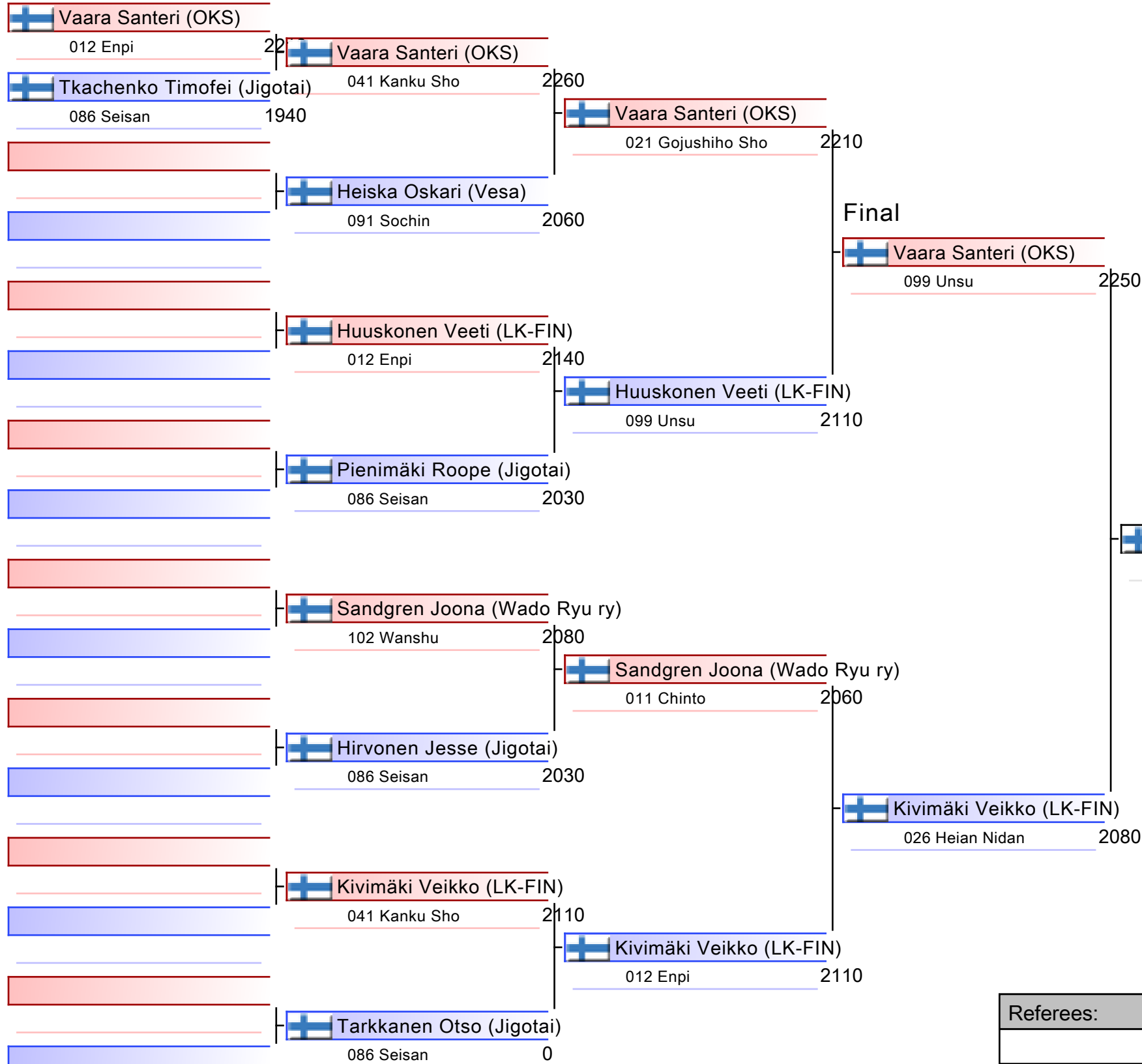

- | |
|---------------------------------|
| 1. VAARA SANTERI (OKS) |
| 2. KIVIMÄKI VEIKKO (LK-FIN) |
| 3. HUUSKONEN VEETI (LK-FIN) |
| 4. SANDGREN JOONA (WADO RYU RY) |
| 5. TARKKANEN OTSO (JIGOTAI) |
| 5. HEISKA OSKARI (VESA) |
| 7. TKACHENKO TIMOFEI (JIGOTAI) |
| |

Referees:			

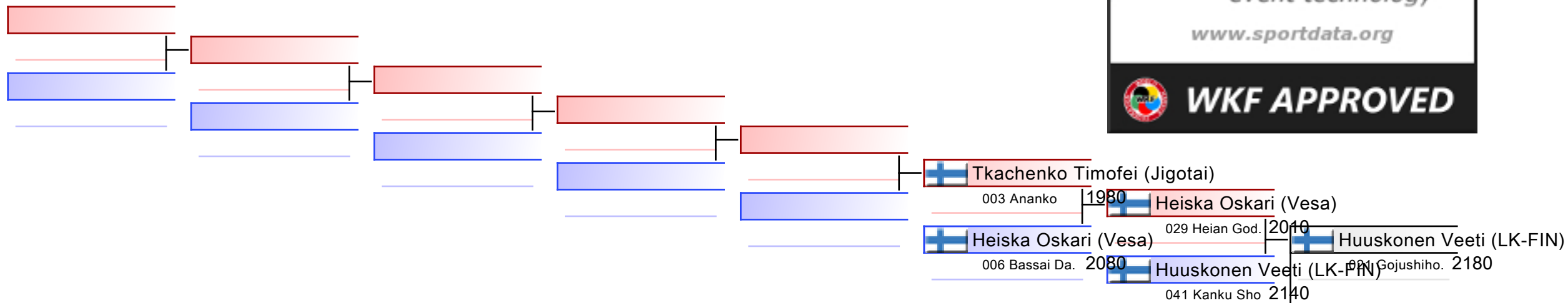

REPECHAGE: (1)

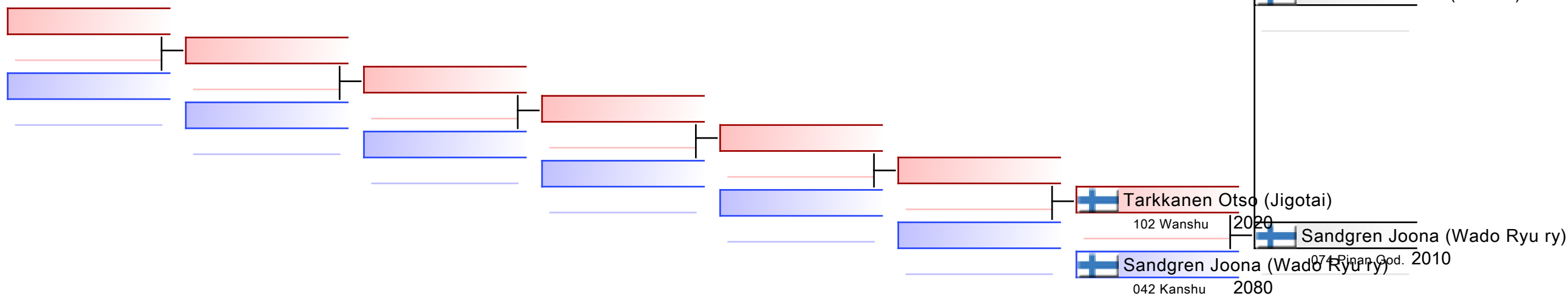

Referees:							
-----------	--	--	--	--	--	--	--

Official Results

KATA, U16, POJAT				
1	VAARA SANTERI	OULUN KARATESEURA		FIN - FINLAND
2	KIVIMÄKI VEIKKO	LAHDEN KARATE		FIN - FINLAND
3	HUUSKONEN VEETI	LAHDEN KARATE		FIN - FINLAND
4	SANDGREN JOONA	VANTAAN WADO RYU RY		FIN - FINLAND
5	TARKKANEN OTSO	JIGOTAI KARATE		FIN - FINLAND
5	HEISKA OSKARI	HYVINKÄÄN SHOTOKAN KARATE RY		FIN - FINLAND
7	TKACHENKO TIMOFEI	JIGOTAI KARATE		FIN - FINLAND

KATA, U16, TYTÖT

KARATEN SM KILPAILUT 2024
ENTRIES BY WEIGHT CATEGORY
KATA, U16, TYTÖT
As of 7 APR 2024

NOC Code	Gender	Name	Seeding
FIN	F	Ahonen Venla	
FIN	F	Hannu Alva	
FIN	F	Kallio Sara	
FIN	F	Kenttä Hilda	
FIN	F	Kuusi Nika	
FIN	F	Tammela Iitu	

KATA, U16, TYTÖT

KARATEN SM KILPAILUT 2024, Asikkalantie 14, 17200 Vääksy, FIN

2024-04-06

Tatami
1 10:45

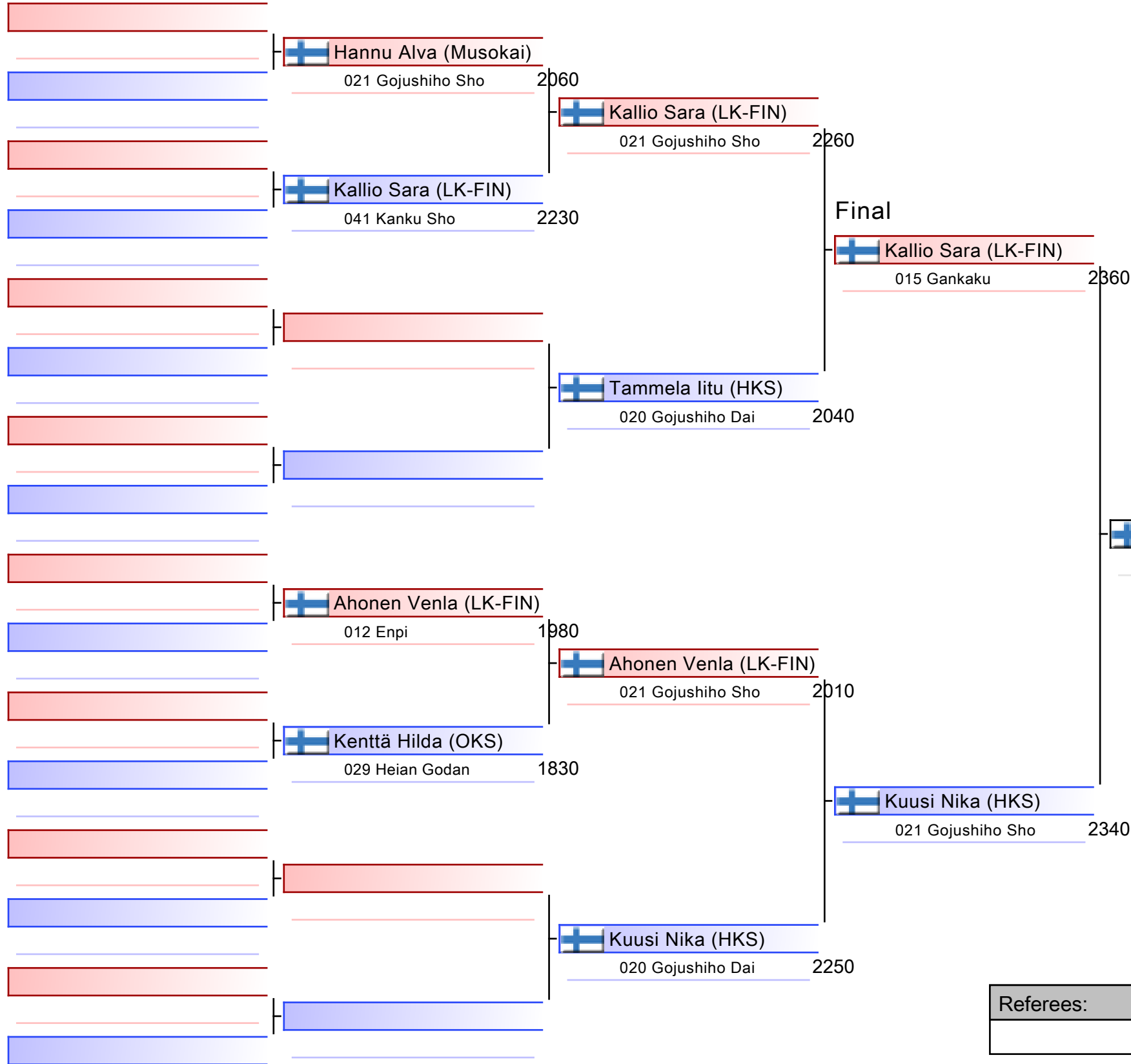

Pool
1/1

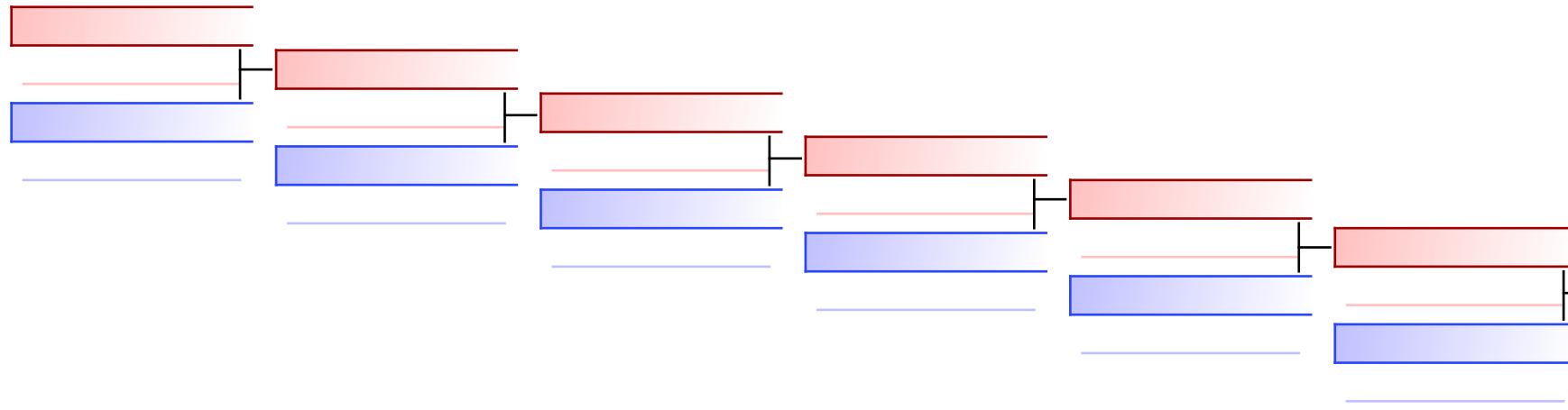

1. KALLIO SARA (LK-FIN)
2. KUUSI NIKA (HKS)
3. HANNU ALVA (MUSOKAI)
4. AHONEN VENLA (LK-FIN)
5. TAMMELA IITU (HKS)

Referees:			



 Hannu Alva (Musokai)
 041 Kanku Sho 2060
 Hannu Alva (Musokai)
 012 Enpi 2090
 Tammela Iitu (HKS)
 021 Gojushiho. 1940

REPECHAGE: (1)

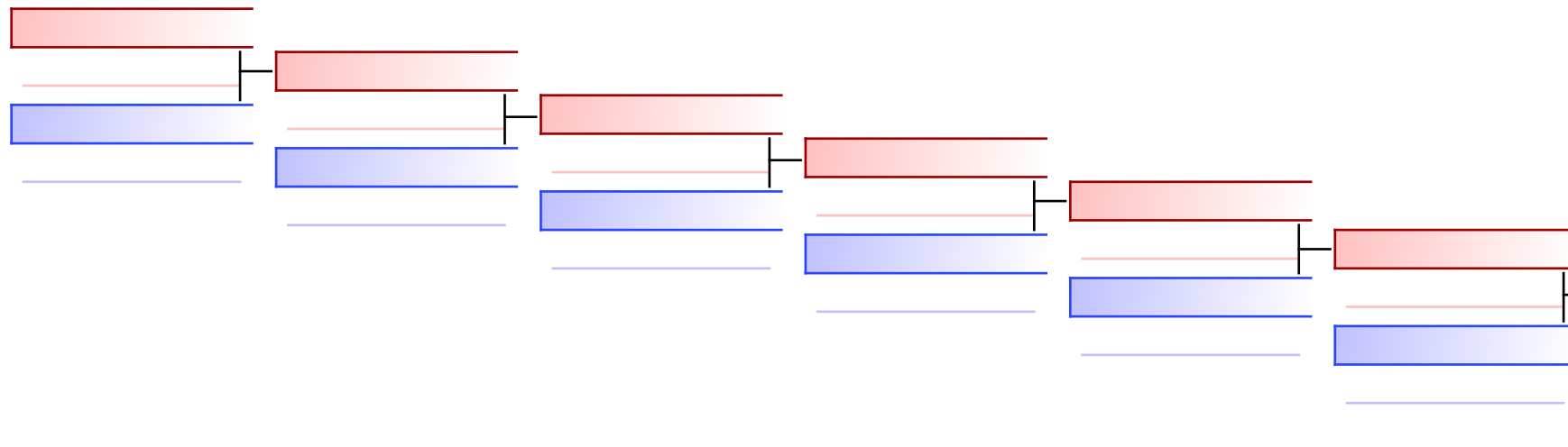





 Hannu Alva (Musokai)

 Ahonen Venla (LK-FIN)
 041 Kanku Sho 1960

Referees:							
-----------	--	--	--	--	--	--	--

Official Results

KATA, U16, TYTÖT				
1	KALLIO SARA	LAHDEN KARATE		FIN - FINLAND
2	KUUSI NIKA	HÄMEENLINNAN KARATESEURA		FIN - FINLAND
3	HANNU ALVA	BUDOSEURA OULUN MUSOKAI RY		FIN - FINLAND
4	AHONEN VENLA	LAHDEN KARATE		FIN - FINLAND
5	TAMMELA IITU	HÄMEENLINNAN KARATESEURA		FIN - FINLAND

KATA, U18, TYTÖT

KARATEN SM KILPAILUT 2024
ENTRIES BY WEIGHT CATEGORY
KATA, U18, TYTÖT
As of 7 APR 2024

NOC Code	Gender	Name	Seeding
FIN	F	Alatalo Onerva	
FIN	F	Heiskanen lines	
FIN	F	Kuusi Nika	
FIN	F	Meyke Alexandra	
FIN	F	Myllymäki Maiju	

KATA, U18, TYTÖT

KARATEN SM KILPAILUT 2024, Asikkalantie 14, 17200 Vääksy, FIN

2024-04-06

Tatami
1 11:30

Pool
1/1

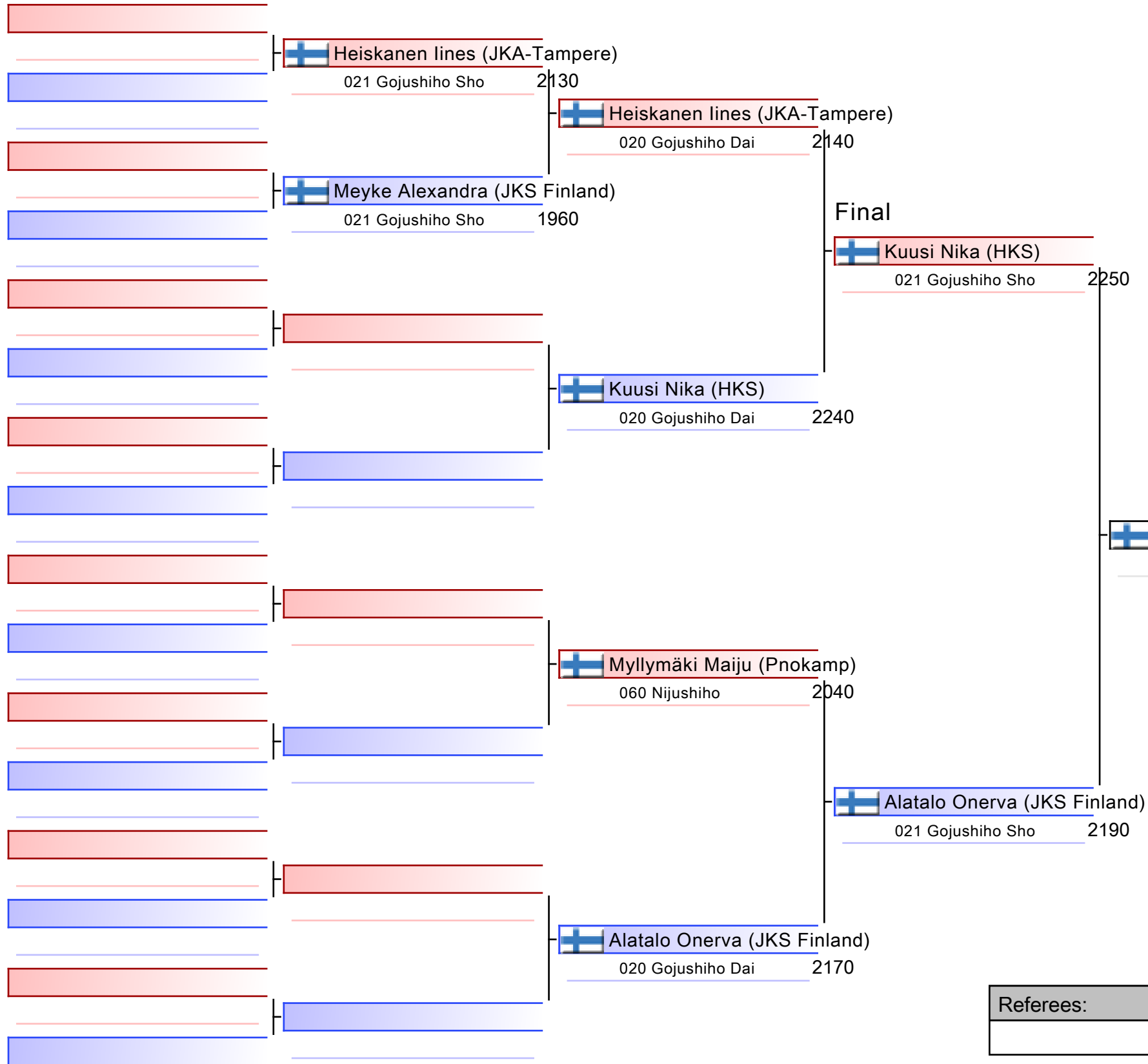

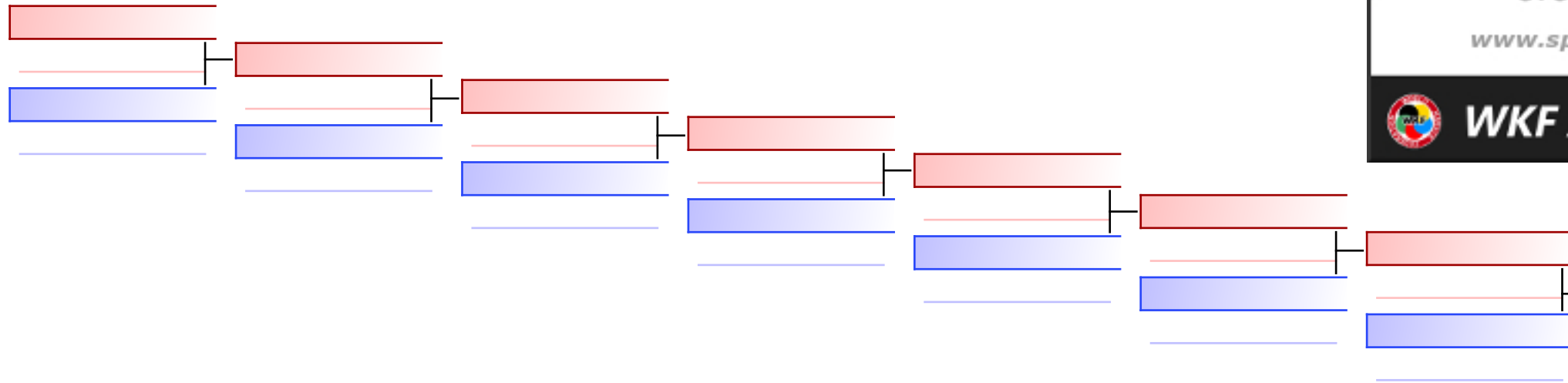

1. KUUSI NIKA (HKS)
2. ALATALO ONERVA (JKS FINLAND)

Referees:			

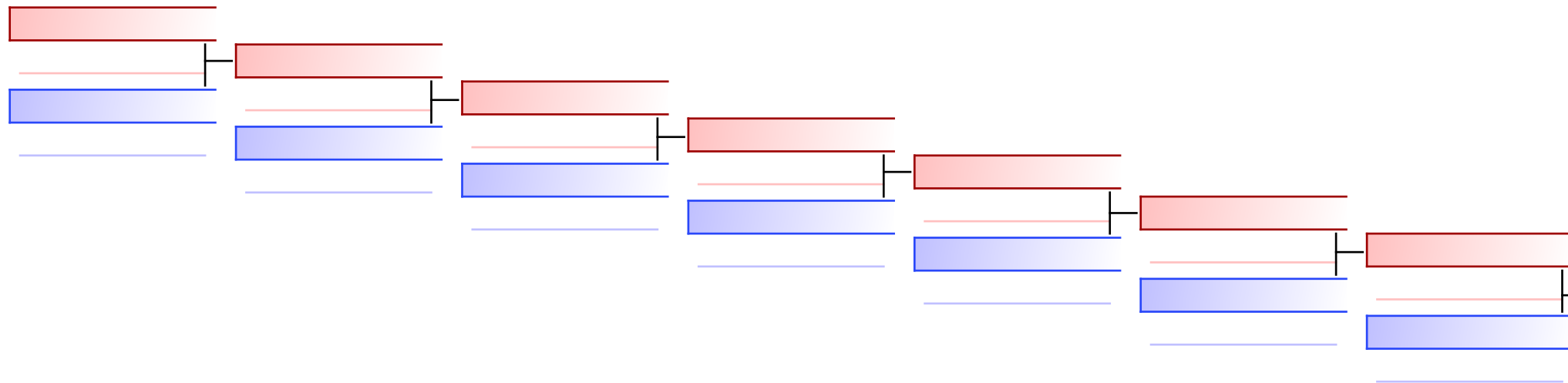

REPECHAGE: (1)





 Heiskanen lines (JKA-Tampere)
036 Jion 2170

 Myllymäki Maiju (Pnokamp)
020 Gojushiho. 2030

Referees:							
-----------	--	--	--	--	--	--	--

KARATEN SM KILPAILUT 2024 - 2024-04-06

Official Results

KATA, U18, TYTÖT				
1	KUUSI NIKA	HÄMEENLINNAN KARATESEURA		FIN - FINLAND
2	ALATALO ONERVA	JKS FINLAND - SHOTOKAN KARATE HELSINKI		FIN - FINLAND

KATA, U21, MIEHET

KARATEN SM KILPAILUT 2024
ENTRIES BY WEIGHT CATEGORY
KATA, U21, MIEHET
As of 7 APR 2024

NOC Code	Gender	Name	Seeding
FIN	M	Lehtinen Jesse	
FIN	M	Takala Akseli	

KATA, U21, MIEHET

KARATEN SM KILPAILUT 2024, Asikkalantie 14, 17200 Vääksy, FIN

2024-04-06

Tatami
1 19:20

Pool
1/1

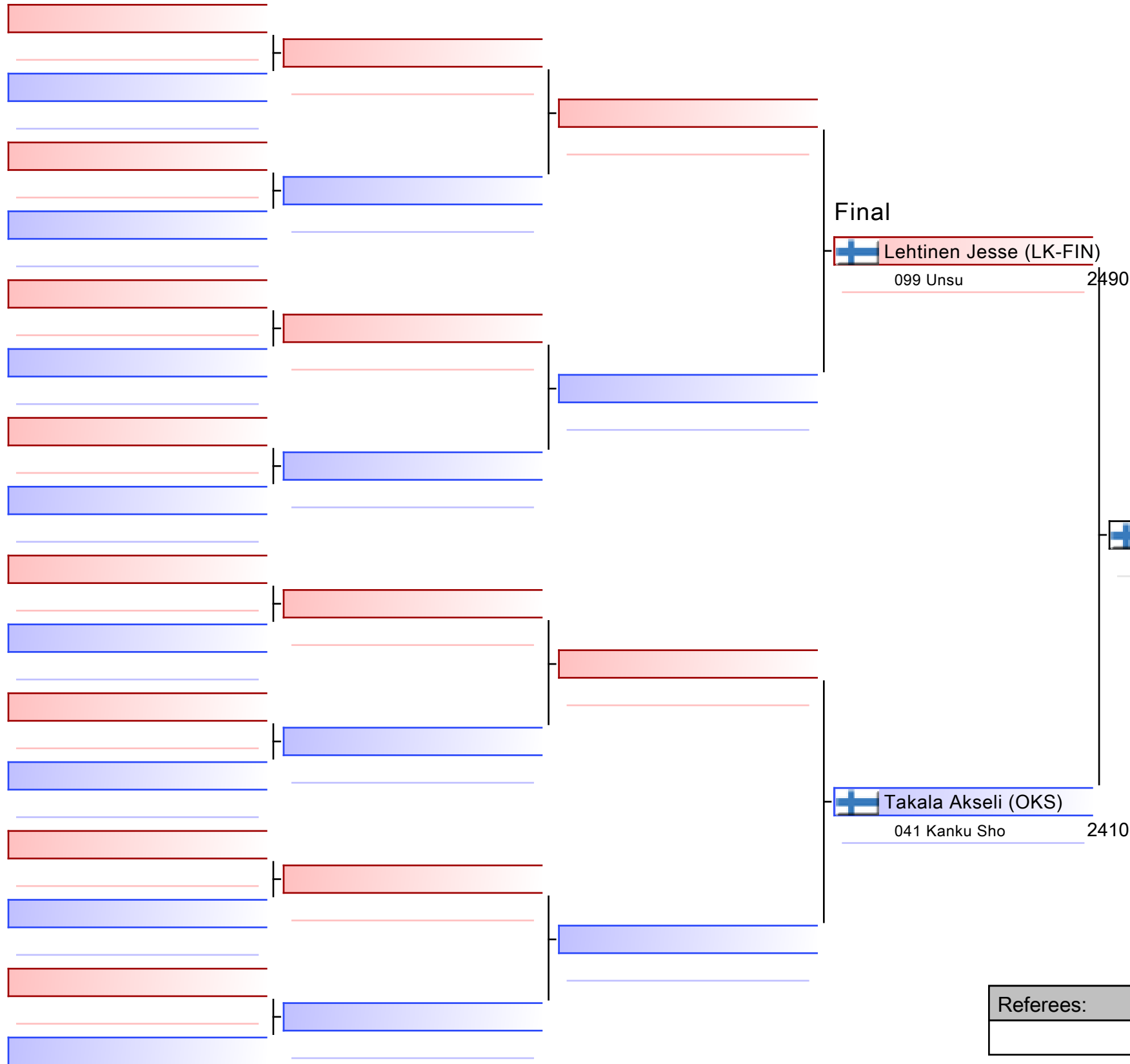



Lehtinen Jesse (LK-FIN)

1. LEHTINEN JESSE (LK-FIN)
2. TAKALA AKSELI (OKS)

Referees:			

KARATEN SM KILPAILUT 2024 - 2024-04-06

Official Results

KATA, U21, MIEHET				
1	LEHTINEN JESSE	LAHDEN KARATE		FIN - FINLAND
2	TAKALA AKSELI	OULUN KARATESEURA		FIN - FINLAND

KATA, U21, NAISSET

KARATEN SM KILPAILUT 2024
ENTRIES BY WEIGHT CATEGORY
KATA, U21, NAISET
As of 7 APR 2024

NOC Code	Gender	Name	Seeding
FIN	F	Lantta Wiivi	
FIN	F	Lehtinen Nea	
FIN	F	Myllymäki Maiju	
FIN	F	Sihvonen Ella	

KATA, U21, NAISET

KARATEN SM KILPAILUT 2024, Asikkalantie 14, 17200 Vääksy, FIN

2024-04-06

Tatami
1 12:00

Pool
1/1

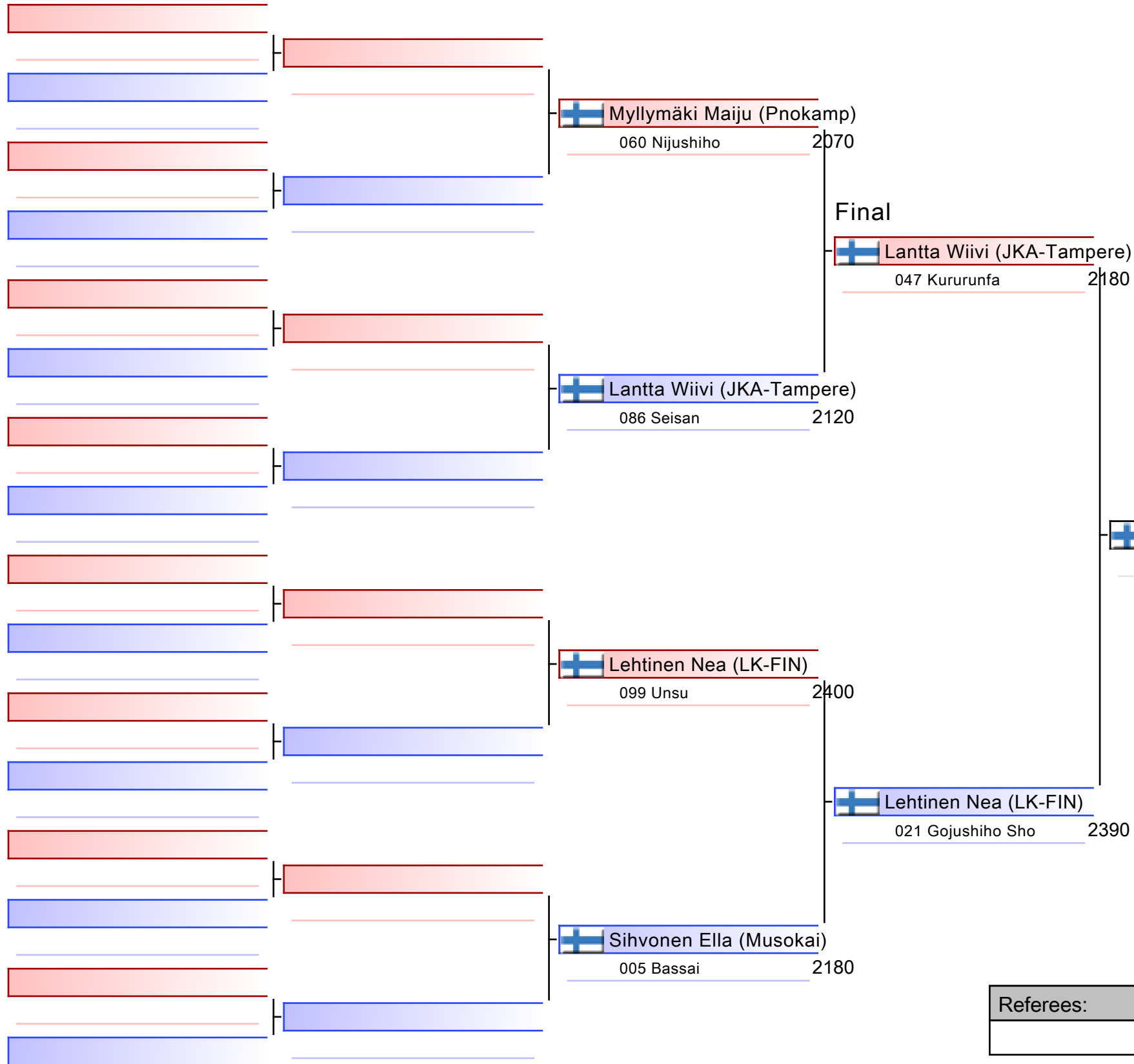

Lehtinen Nea (LK-FIN)

1. LEHTINEN NEA (LK-FIN)
2. LANTTA WIIVI (JKA-TAMPERE)
3. SIHVONEN ELLA (MUSOKAI)
4. MYLLYMÄKI MAIJU (PNOKAMP)

Referees:			

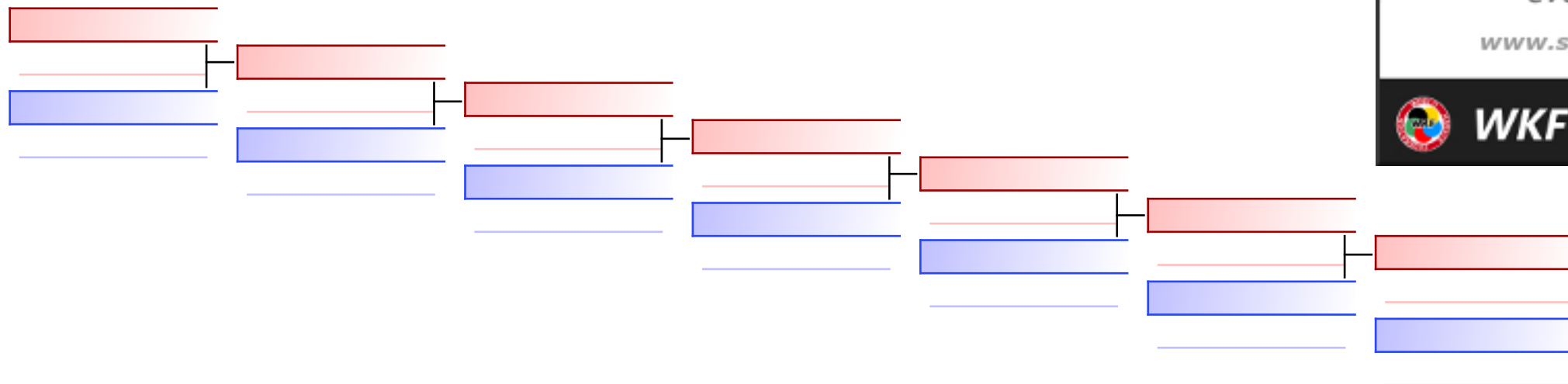

REPECHAGE: (1)

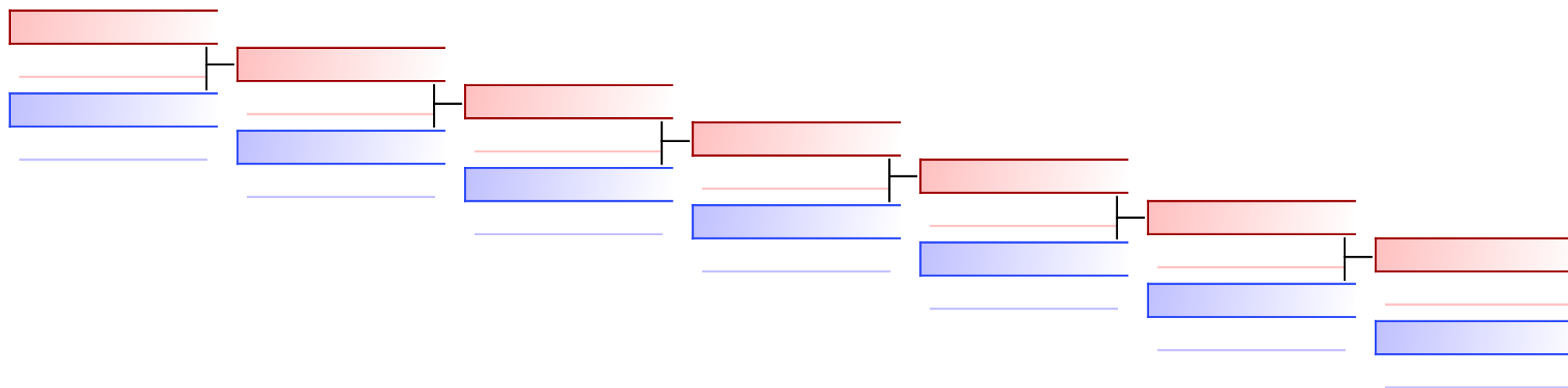





- Myllymäki Maiju (Pnokamp)
020 Gojushiho. 2130
- Sihvonen Ella (Musokai)
- Sihvonen Ella (Musokai)
048 Kusanku 2140

Referees:							
-----------	--	--	--	--	--	--	--

KARATEN SM KILPAILUT 2024 - 2024-04-06

Official Results

KATA, U21, NAISET				
1	LEHTINEN NEA	LAHDEN KARATE		FIN - FINLAND
2	LANTTA WIIVI	JAPAN KARATE ASSOCIATION TAMPERE RY		FIN - FINLAND
3	SIHVONEN ELLA	BUDOSEURA OULUN MUSOKAI RY		FIN - FINLAND
4	MYLLYMÄKI MAIJU	PARKANON KAMPPAILUSEURA RY.		FIN - FINLAND

KUMITE, MIEHET +35V, -75KG
YHDISTETTY

KARATEN SM KILPAILUT 2024
ENTRIES BY WEIGHT CATEGORY
KUMITE, MIEHET +35v, -75KG yhdistetty
As of 7 APR 2024

NOC Code	Gender	Name	Seeding
FIN	M	Luukka Eki	
FIN	M	Toivanen Petri	

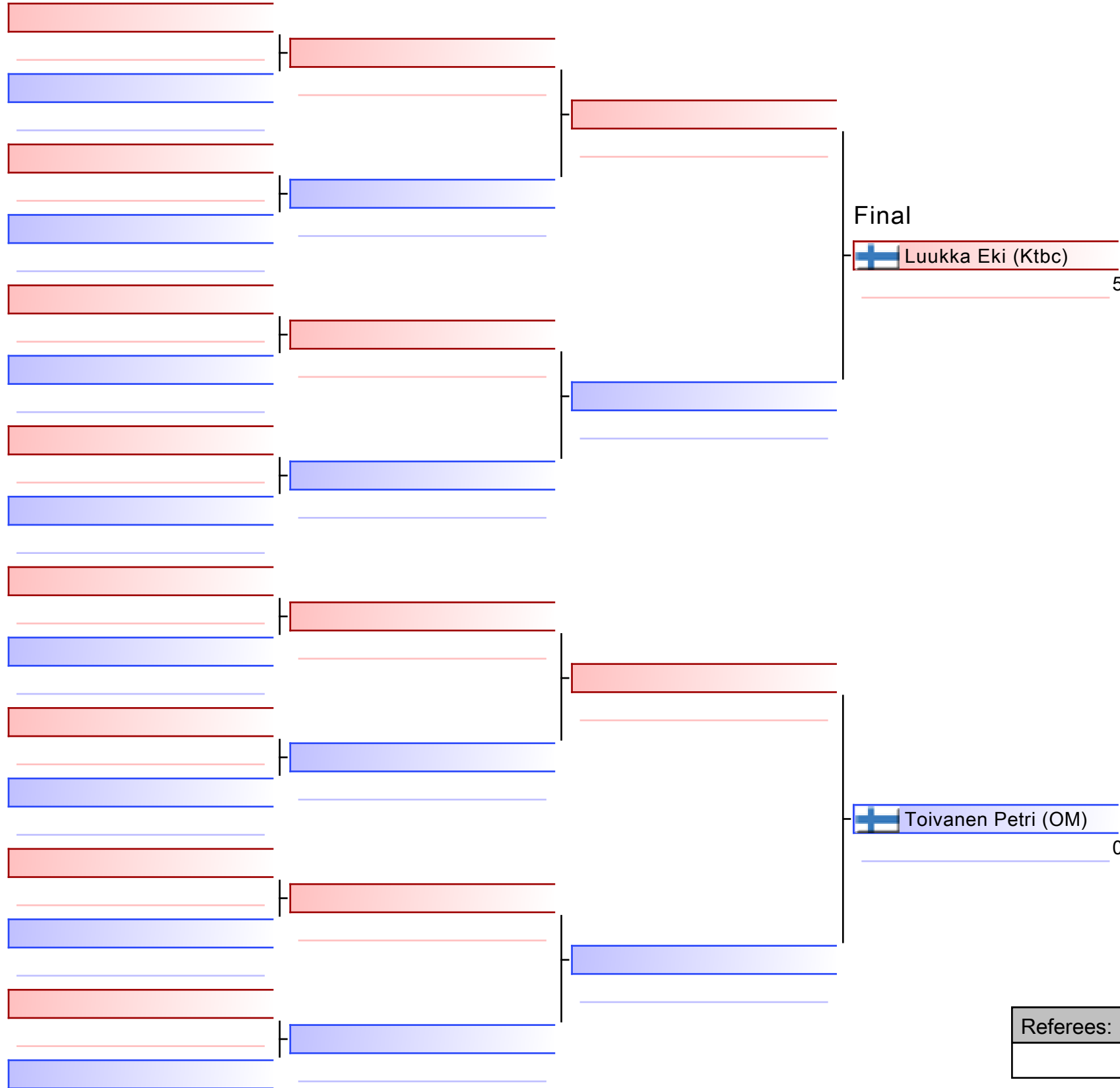



Luukka Eki (Ktbc)

1. LUUKKA EKI (KTBC)
2. TOIVANEN PETRI (OM)

Referees:			

Official Results

KUMITE, MIEHET +35v, -75KG yhdistetty				
1	LUUKKA EKI	KOTKA THAIBOXING CLUB		FIN - FINLAND
2	TOIVANEN PETRI	SPORTSKARATE KUOPIO		FIN - FINLAND

KUMITE, MIEHET, +84KG

KARATEN SM KILPAILUT 2024
ENTRIES BY WEIGHT CATEGORY
KUMITE, MIEHET, +84KG
As of 7 APR 2024

NOC Code	Gender	Name	Seeding
FIN	M	Khalifa Miidu	
FIN	M	Nurmi Lalli	

KUMITE, MIEHET, +84KG

KARATEN SM KILPAILUT 2024, Asikkalantie 14, 17200 Vääksy, FIN

2024-04-06

Tatami
2 16:10

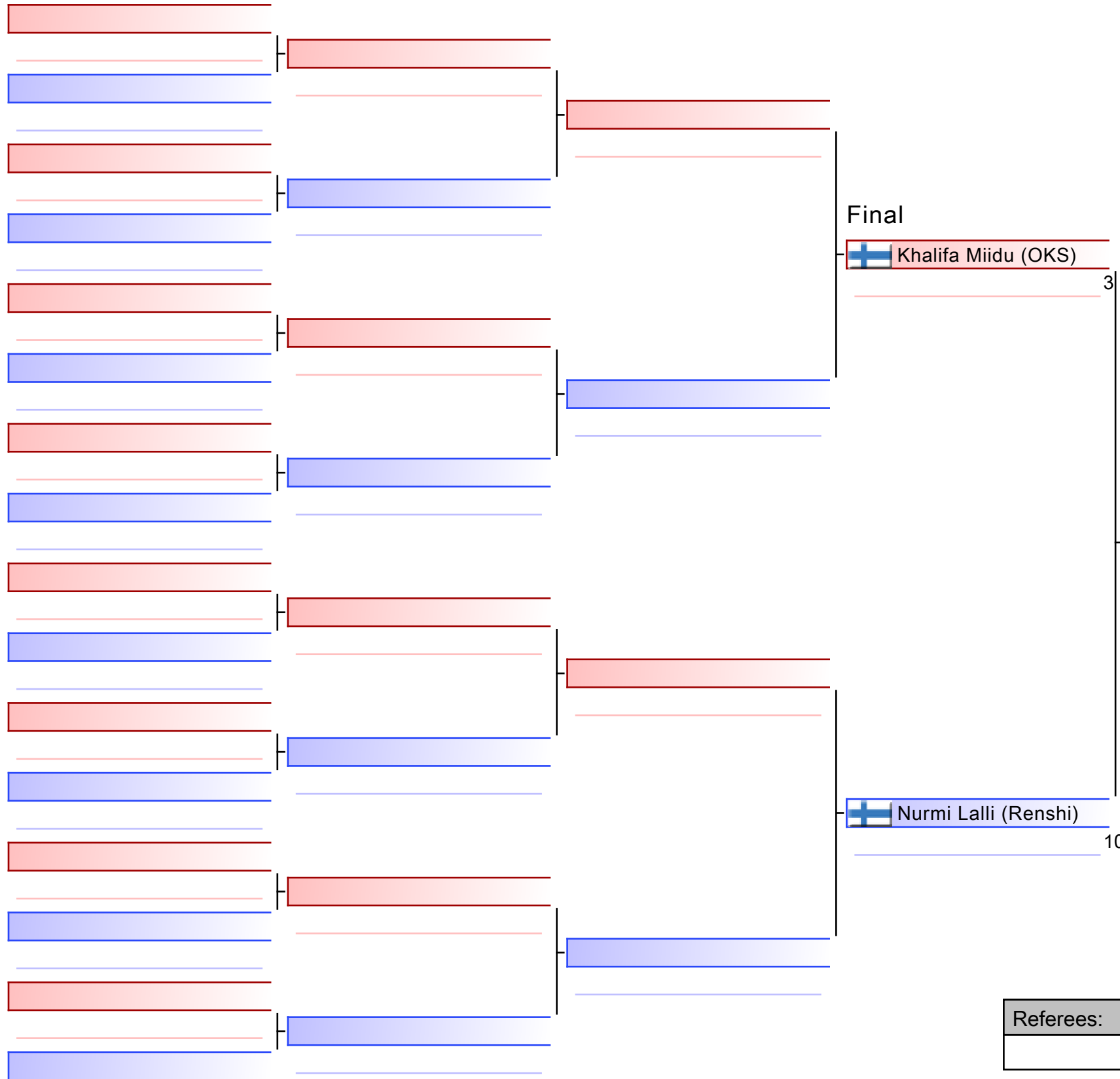

Pool
1/1



1. NURMI LALLI (RENSHI)
2. KHALIFA MIIDU (OKS)

Referees:			

Official Results

KUMITE, MIEHET, +84KG				
1	NURMI LALLI	RENSHIN-KAN RY		FIN - FINLAND
2	KHALIFA MIIDU	OULUN KARATESEURA		FIN - FINLAND

KUMITE, MIEHET, -75KG

KARATEN SM KILPAILUT 2024
ENTRIES BY WEIGHT CATEGORY
KUMITE, MIEHET, -75KG
As of 7 APR 2024

NOC Code	Gender	Name	Seeding
FIN	M	Banauliker Kartik-Otto	
FIN	M	Luukka Eki	
FIN	M	Toivanen Petri	

KUMITE, MIEHET, -75KG - Round Robin (each against each)

KARATEN SM KILPAILUT 2024, Asikkalantie 14, 17200 Vääksy, FIN









2024-04-06

Tatami

2 15:40

Pool

1/1



1	 Luukka Eki (Ktbc)	3	 Toivanen Petri (OM)
2	 Toivanen Petri (OM)	5	
3	 Luukka Eki (Ktbc)	2	 Banauliker Kartik-Otto (Budokwai Karate)
4	 Banauliker Kartik-Otto (Budokwai Karate)	2	
5	 Toivanen Petri (OM)	4	 Toivanen Petri (OM)
6	 Banauliker Kartik-Otto (Budokwai Karate)	3	



1. TOIVANEN PETRI (OM)
2. BANAU LIKER KARTIK-OTTO (BUDOKWAI KARATE)
3. LUUKKA EKI (KTBC)

Referees:			

Official Results

KUMITE, MIEHET, -75KG				
1	TOIVANEN PETRI	SPORTSKARATE KUOPIO		FIN - FINLAND
2	BANAULIKER KARTIK-OTTO	BUDOKWAI RY KARATE		FIN - FINLAND
3	LUUKKA EKI	KOTKA THAIBOXING CLUB		FIN - FINLAND

KUMITE, MIEHET, -84KG

KARATEN SM KILPAILUT 2024
ENTRIES BY WEIGHT CATEGORY
KUMITE, MIEHET, -84KG
As of 7 APR 2024

NOC Code	Gender	Name	Seeding
FIN	M	Kulovuori Björn	
FIN	M	Mantere Jimi	
FIN	M	Mantere Niko	









KUMITE, MIEHET, -84KG - Round Robin (each against each)

KARATEN SM KILPAILUT 2024, Asikkalantie 14, 17200 Vääksy, FIN

2024-04-06

Tatami
2 15:55

Pool
1/1



1	 Mantere Jimi (HKS)	0	 Mantere Niko (HKS)
2	 Mantere Niko (HKS)	3	
3	 Mantere Jimi (HKS)	1	 Kulovuori Björn (JKS Finland)
4	 Kulovuori Björn (JKS Finland)	9	
5	 Mantere Niko (HKS)	3	 Kulovuori Björn (JKS Finland)
6	 Kulovuori Björn (JKS Finland)	9	



1. KULOVUORI BJÖRN (JKS FINLAND)
2. MANTERE NIKO (HKS)
3. MANTERE JIMI (HKS)

Referees:			

Official Results

KUMITE, MIEHET, -84KG					
1	KULOVUORI BJÖRN	JKS FINLAND - SHOTOKAN KARATE HELSINKI		FIN - FINLAND	
2	MANTERE NIKO	HAMEENLINNAN KARATESEURA		FIN - FINLAND	
3	MANTERE JIMI	HAMEENLINNAN KARATESEURA		FIN - FINLAND	

KUMITE, MIEHET, AVOIN

KARATEN SM KILPAILUT 2024
ENTRIES BY WEIGHT CATEGORY
KUMITE, MIEHET, AVOIN
As of 7 APR 2024

NOC Code	Gender	Name	Seeding
FIN	M	Khalifa Miidu	
FIN	M	Mantere Niko	
FIN	M	Nurmi Lalli	
FIN	M	Vink Jeffrey	

KUMITE, MIEHET, AVOIN - Round Robin (each against each)

KARATEN SM KILPAILUT 2024, Asikkalantie 14, 17200 Vääksy, FIN



















2024-04-06

Tatami

2 16:15

Pool

1/1





1	 Vink Jeffrey (JKS Finland)	1	 Khalifa Miidu (OKS)
2	 Khalifa Miidu (OKS)	4	
3	 Nurmi Lalli (Renshi)	3	 Nurmi Lalli (Renshi)
4	 Mantere Niko (HKS)	2	
5	 Vink Jeffrey (JKS Finland)	0	 Nurmi Lalli (Renshi)
6	 Nurmi Lalli (Renshi)	1	
7	 Mantere Niko (HKS)	4	 Mantere Niko (HKS)
8	 Khalifa Miidu (OKS)	3	
9	 Vink Jeffrey (JKS Finland)	1	 Mantere Niko (HKS)
10	 Mantere Niko (HKS)	3	
11	 Khalifa Miidu (OKS)	2	 Nurmi Lalli (Renshi)
12	 Nurmi Lalli (Renshi)	6	



1. NURMI LALLI (RENSHI)
2. MANTERE NIKO (HKS)
3. KHALIFA MIIDU (OKS)
4. VINK JEFFREY (JKS FINLAND)

Referees:			

Official Results

KUMITE, MIEHET, AVOIN				
1	NURMI LALLI	RENSHIN-KAN RY		FIN - FINLAND
2	MANTERE NIKO	HAMEENLINNAN KARATESEURA		FIN - FINLAND
3	KHALIFA MIIDU	OULUN KARATESEURA		FIN - FINLAND
4	VINK JEFFREY	JKS FINLAND - SHOTOKAN KARATE HELSINKI		FIN - FINLAND

KUMITE, NAISSET, +68KG

KARATEN SM KILPAILUT 2024
ENTRIES BY WEIGHT CATEGORY
KUMITE, NAISSET, +68KG
As of 7 APR 2024

NOC Code	Gender	Name	Seeding
FIN	F	Keinänen Titta	
FIN	F	Korpela Maria	
FIN	F	SIITARINEN OLIVIA	









KUMITE, NAISET, +68KG - Round Robin (each against each)

KARATEN SM KILPAILUT 2024, Asikkalantie 14, 17200 Vääksy, FIN

2024-04-06

Tatami
1 17:45

Pool
1/1



1	 SIITARINEN OLIVIA (Renshi)	3	 Korpela Maria (SPF)
2	 Korpela Maria (SPF)	7	
3	 SIITARINEN OLIVIA (Renshi)	0	 Keinänen Titta (EKS)
4	 Keinänen Titta (EKS)	6	
5	 Korpela Maria (SPF)	0	 Keinänen Titta (EKS)
6	 Keinänen Titta (EKS)	3	



1. KEINÄNEN TITTA (EKS)
2. KORPELA MARIA (SPF)
3. SIITARINEN OLIVIA (RENSHI)

Referees:			

Official Results

KUMITE, NAISSET, +68KG				
1	KEINÄNEN TITTA	EURAN KARATESEURA		FIN - FINLAND
2	KORPELA MARIA	SPORTSKARATE.FI		FIN - FINLAND
3	SIITARINEN OLIVIA	RENSHIN-KAN RY		FIN - FINLAND

KUMITE, NAISSET, -68KG

KARATEN SM KILPAILUT 2024
ENTRIES BY WEIGHT CATEGORY
KUMITE, NAISSET, -68KG
As of 7 APR 2024

NOC Code	Gender	Name	Seeding
FIN	F	Koponen Kiia	
FIN	F	Seppälä Saana	

KUMITE, NAISET, -68KG

KARATEN SM KILPAILUT 2024, Asikkalantie 14, 17200 Vääksy, FIN

2024-04-06

Tatami
1 17:40

Pool
1/1

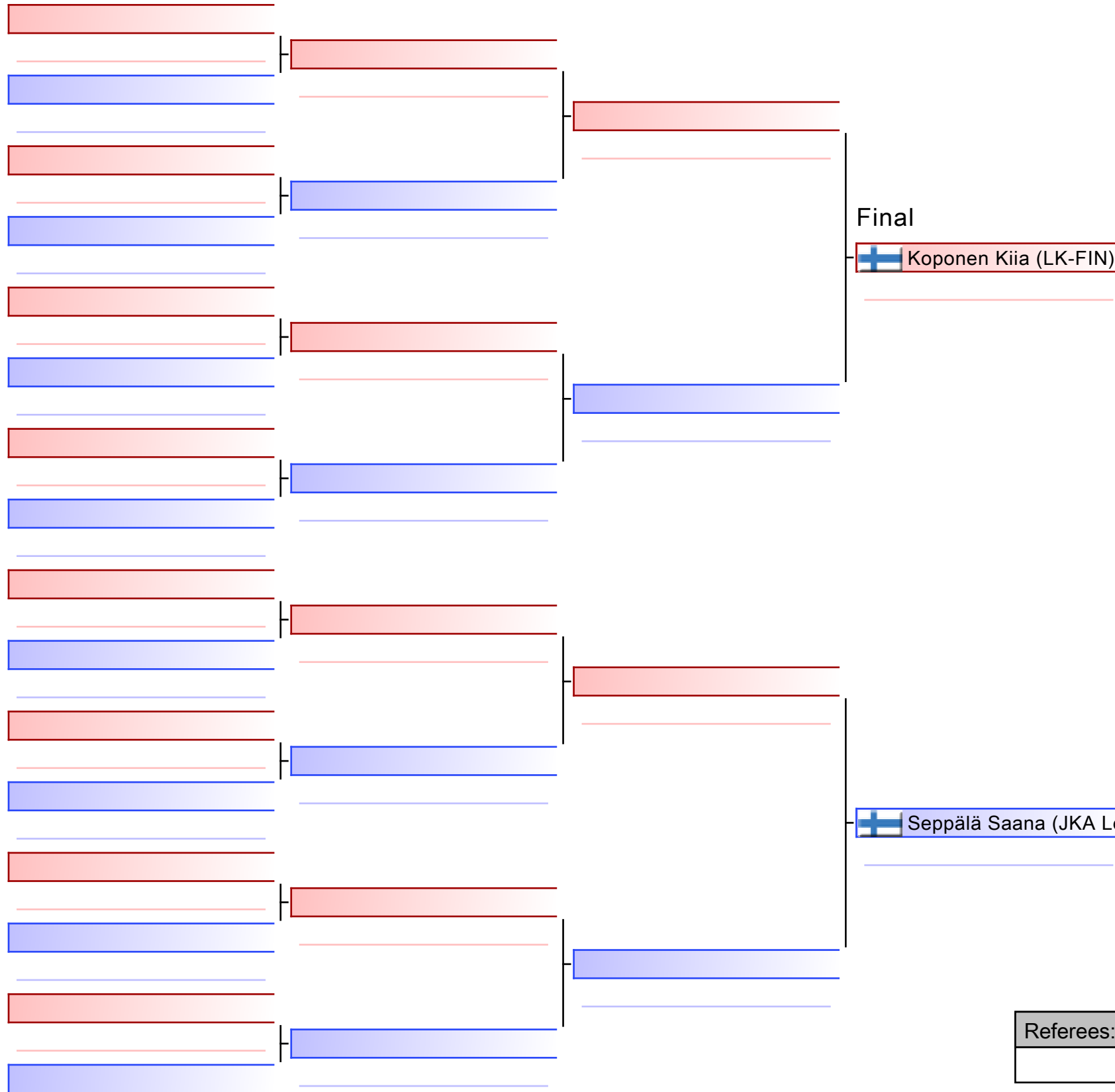

Final

Koponen Kiia (LK-FIN)

8

Koponen Kiia (LK-FIN)

Seppälä Saana (JKA Lempäälä)



0

- | |
|---------------------------------|
| 1. KOPONEN KIIA (LK-FIN) |
| 2. SEPPÄLÄ SAANA (JKA LEMPÄÄLÄ) |
| |
| |
| |
| |
| |
| |

Referees:			

KARATEN SM KILPAILUT 2024 - 2024-04-06

Official Results

KUMITE, NAISSET, -68KG				
1	KOPONEN KIIA	LAHDEN KARATE		FIN - FINLAND
2	SEPPÄLÄ SAANA	LEMPÄÄLÄN SHOTOKAN KARATE		FIN - FINLAND

KUMITE, NAISSET, AVOIN

KARATEN SM KILPAILUT 2024
ENTRIES BY WEIGHT CATEGORY
KUMITE, NAISSET, AVOIN
As of 7 APR 2024

NOC Code	Gender	Name	Seeding
FIN	F	Keinänen Titta	
FIN	F	Koponen Kiia	
FIN	F	Seppälä Saana	
FIN	F	SIITARINEN OLIVIA	

KUMITE, NAISET, AVOIN - Round Robin (each against each)

KARATEN SM KILPAILUT 2024, Asikkalantie 14, 17200 Vääksy, FIN



















2024-04-06

Tatami

1 18:10

Pool

1/1





1	 Seppälä Saana (JKA Lempäälä)	2	 SIITARINEN OLIVIA (Renshi)
2	 SIITARINEN OLIVIA (Renshi)	5	
3	 Koponen Kiia (LK-FIN)	4	 Keinänen Titta (EKS)
4	 Keinänen Titta (EKS)	4	
5	 Seppälä Saana (JKA Lempäälä)	0	 Koponen Kiia (LK-FIN)
6	 Koponen Kiia (LK-FIN)	10	
7	 Keinänen Titta (EKS)	1	 SIITARINEN OLIVIA (Renshi)
8	 SIITARINEN OLIVIA (Renshi)	6	
9	 Seppälä Saana (JKA Lempäälä)	2	 Keinänen Titta (EKS)
10	 Keinänen Titta (EKS)	10	
11	 SIITARINEN OLIVIA (Renshi)	0	 Koponen Kiia (LK-FIN)
12	 Koponen Kiia (LK-FIN)	1	



1. KEINÄNEN TITTA (EKS)
2. KOPONEN KIIA (LK-FIN)
3. SIITARINEN OLIVIA (RENSHI)
4. SEPPÄLÄ SAANA (JKA LEMPÄÄLÄ)

Referees:			

Official Results

KUMITE, NAISSET, AVOIN				
1	KEINÄNEN TITTA	EURAN KARATESEURA		FIN - FINLAND
2	KOPONEN KIIA	LAHDEN KARATE		FIN - FINLAND
3	SIITARINEN OLIVIA	RENSHIN-KAN RY		FIN - FINLAND
4	SEPPÄLÄ SAANA	LEMPÄÄLÄN SHOTOKAN KARATE		FIN - FINLAND

KUMITE, U14, POJAT -45KG
YHDISTETTY

KARATEN SM KILPAILUT 2024
ENTRIES BY WEIGHT CATEGORY
KUMITE, U14, POJAT -45KG yhdistetty
As of 7 APR 2024

NOC Code	Gender	Name	Seeding
FIN	M	Anttila Ken	
FIN	M	Huuskonen Kosti	
FIN	M	Karma Emil	
FIN	M	Kella Kasper	
FIN	M	Mattinen Nuutti	
FIN	M	Ruottinen Roope	

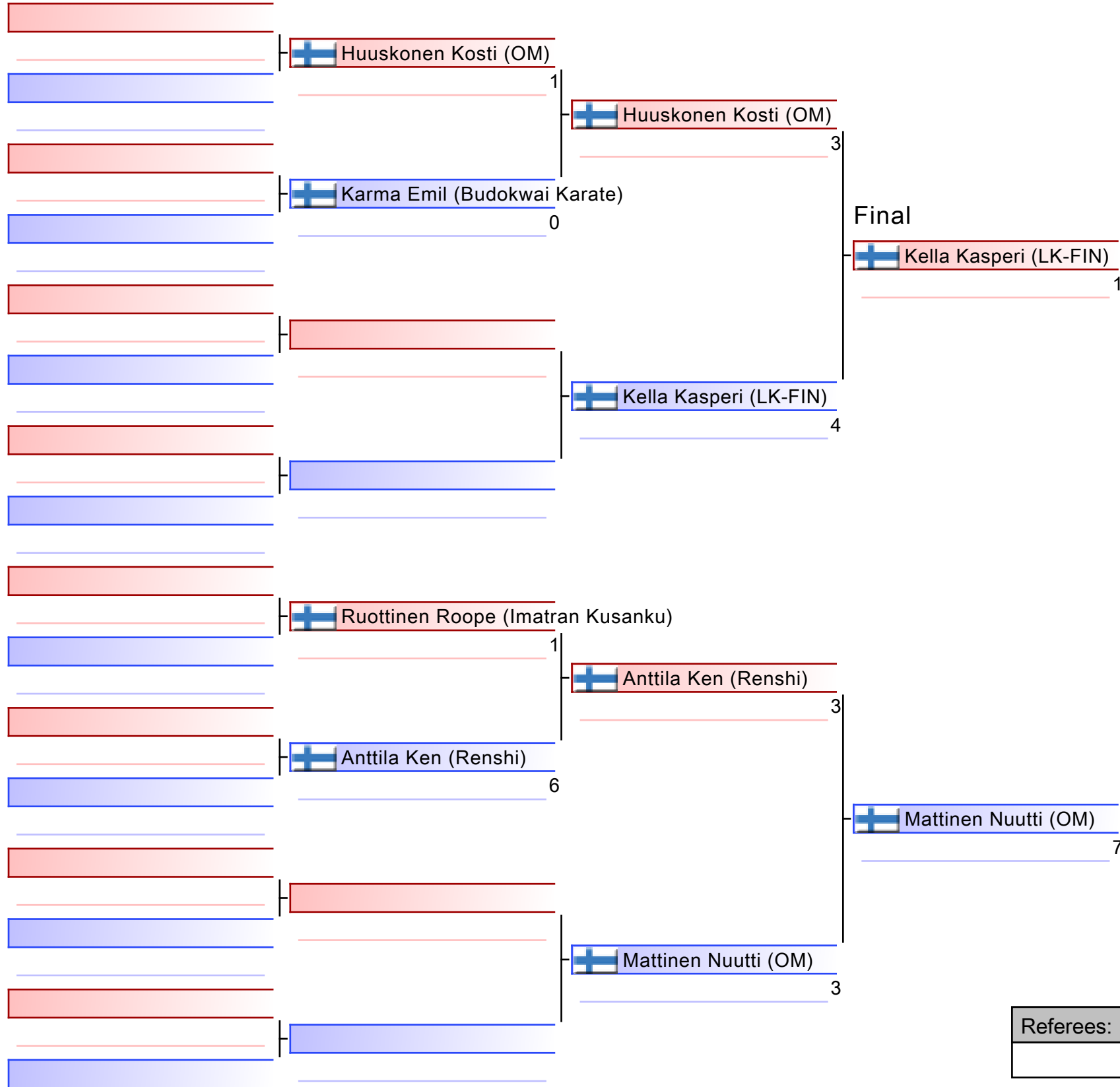

Mattinen Nuutti (OM)

1. MATTINEN NUUTTI (OM)
2. KELLA KASPERI (LK-FIN)
3. ANTTILA KEN (RENSHI)
4. HUUSKONEN KOSTI (OM)

Referees:			

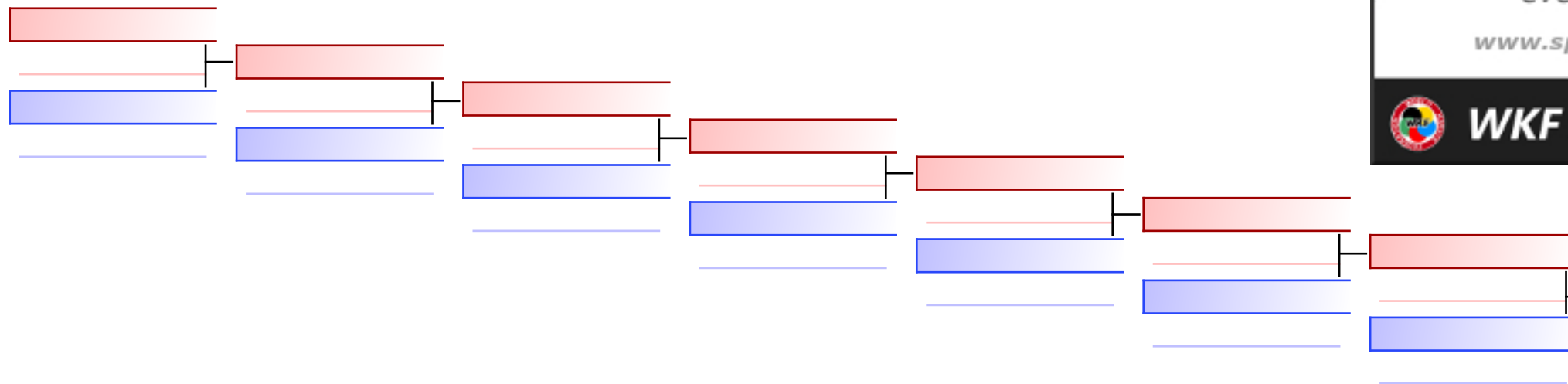

REPECHAGE: (1)

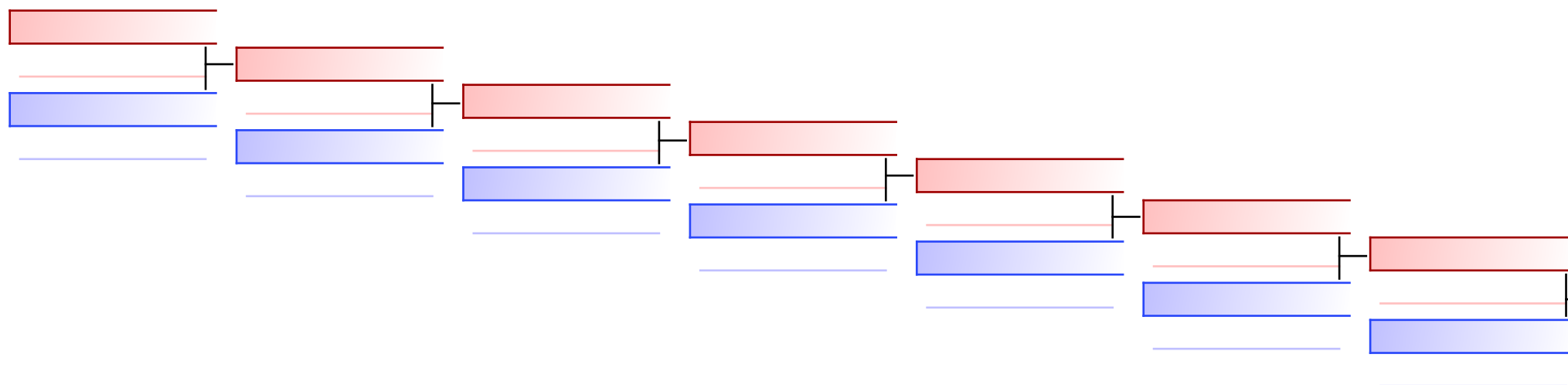





Huuskonen Kosti (OM)
 1

Anttila Ken (Renshi)

Anttila Ken (Renshi)
 5

Referees:							
-----------	--	--	--	--	--	--	--

Official Results

KUMITE, U14, POJAT -45KG yhdistetty				
1	MATTINEN NUUTTI	SPORTSKARATE KUOPIO		FIN - FINLAND
2	KELLA KASPERI	LAHDEN KARATE		FIN - FINLAND
3	ANTTILA KEN	RENSHIN-KAN RY		FIN - FINLAND
4	HUUSKONEN KOSTI	SPORTSKARATE KUOPIO		FIN - FINLAND

KUMITE, U14, POJAT -55KG
YHDISTETTY

KARATEN SM KILPAILUT 2024
ENTRIES BY WEIGHT CATEGORY
KUMITE, U14, POJAT -55KG yhdistetty
As of 7 APR 2024

NOC Code	Gender	Name	Seeding
FIN	M	Hannu Eero	
FIN	M	Keltto Topias	
FIN	M	Lämsä Luka	
FIN	M	Muurinaho Luka	
FIN	M	Vesterinen Max	
FIN	M	Wolff Arn	

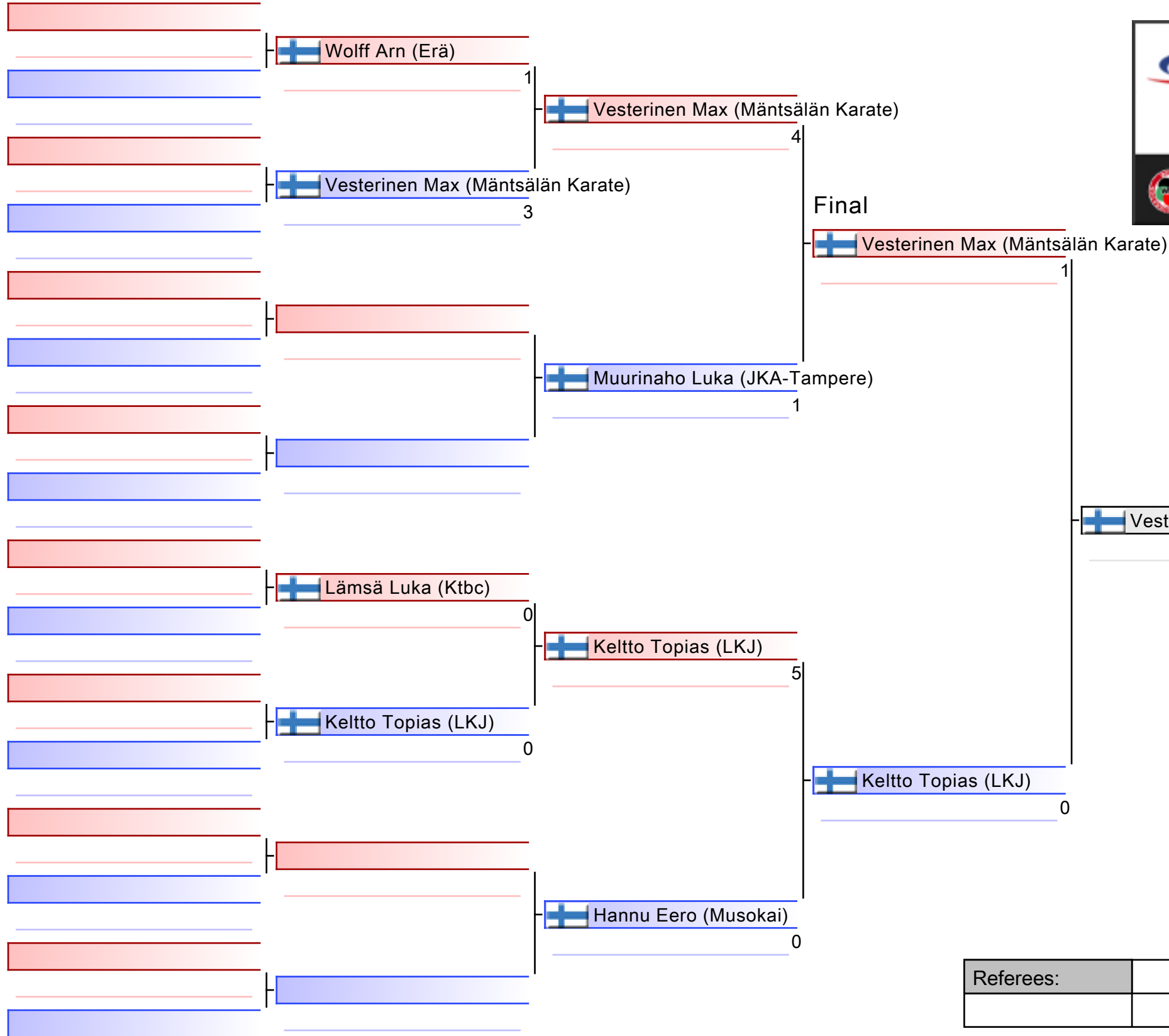

1. VESTERINEN MAX (MÄNTSÄLÄN KARATE)
2. KELTTO TOPIAS (LKJ)
3. MUURINAHO LUKA (JKA-TAMPERE)
4. LÄMSÄ LUKA (KTBC)
5. MUURINAHO LUKA (JKA-TAMPERE)
5. HANNU EERO (MUSOKAI)

Referees:			

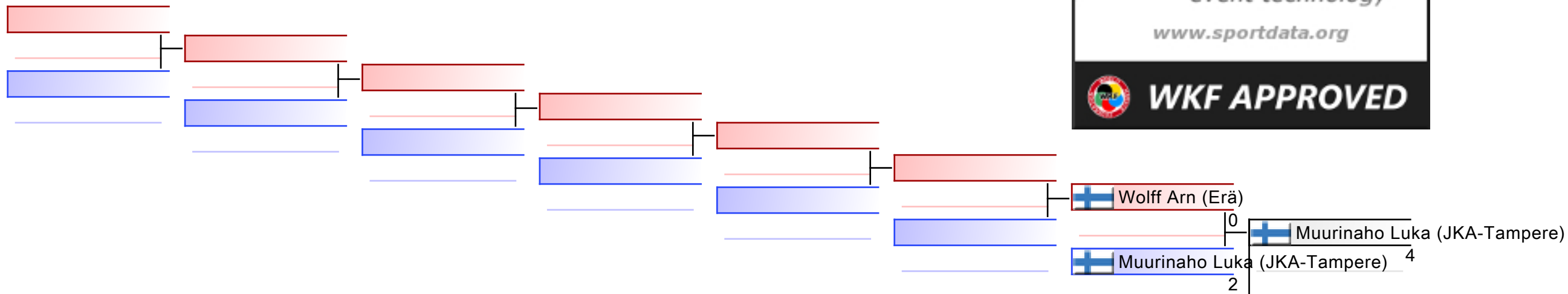

REPECHAGE: (1)

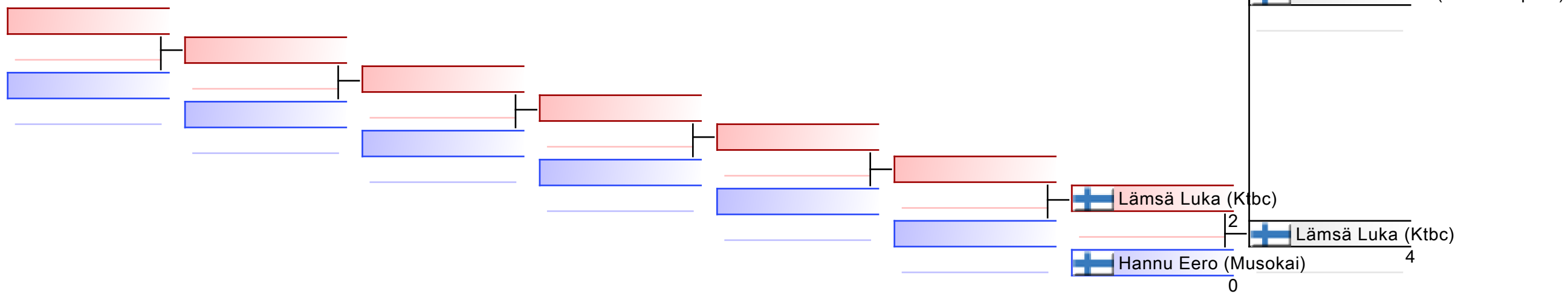

Referees:							
-----------	--	--	--	--	--	--	--

KARATEN SM KILPAILUT 2024 - 2024-04-06

Official Results

KUMITE, U14, POJAT -55KG yhdistetty				
1	VESTERINEN MAX	MÄNTSÄLÄN KARATE		FIN - FINLAND
2	KELTTO TOPIAS	LAKEUDEN KARATE- JUTSU RY		FIN - FINLAND
3	MUURINAHO LUKA	JAPAN KARATE ASSOCIATION TAMPERE RY		FIN - FINLAND
4	LÄMSÄ LUKA	KOTKA THAIBOXING CLUB		FIN - FINLAND
5	MUURINAHO LUKA	JAPAN KARATE ASSOCIATION TAMPERE RY		FIN - FINLAND
5	HANNU EERO	BUDOSEURA OULUN MUSOKAI RY		FIN - FINLAND

KUMITE, U14, POJAT, +55KG

KARATEN SM KILPAILUT 2024
ENTRIES BY WEIGHT CATEGORY
KUMITE, U14, POJAT, +55kg
As of 7 APR 2024

NOC Code	Gender	Name	Seeding
FIN	M	Lähetkangas Luka	
FIN	M	Takala Anton	
FIN	M	Tameh Mohammed	
FIN	M	Vartiainen Juuso	

KUMITE, U14, POJAT, +55kg - Round Robin (each against each)

KARATEN SM KILPAILUT 2024, Asikkalantie 14, 17200 Vääksy, FIN



















2024-04-06

Tatami

3 17:00

Pool

1/1





1	 Lähetkangas Luka (OKS)	0	 Lähetkangas Luka (OKS)
2	 Vartiainen Juuso (JM)	0	
3	 Takala Anton (OKS)	8	 Takala Anton (OKS)
4	 Tameh Mohammed (OM)	0	
5	 Lähetkangas Luka (OKS)	0	 Takala Anton (OKS)
6	 Takala Anton (OKS)	1	
7	 Tameh Mohammed (OM)	0	 Vartiainen Juuso (JM)
8	 Vartiainen Juuso (JM)	0	
9	 Lähetkangas Luka (OKS)	1	 Lähetkangas Luka (OKS)
10	 Tameh Mohammed (OM)	0	
11	 Vartiainen Juuso (JM)	0	 Takala Anton (OKS)
12	 Takala Anton (OKS)	8	



1. TAKALA ANTON (OKS)
2. LÄHETKANGAS LUKA (OKS)
3. VARTIAINEN JUUSO (JM)
4. TAMEH MOHAMMED (OM)

Referees:			

Official Results

KUMITE, U14, POJAT, +55kg				
1	TAKALA ANTON	OULUN KARATESEURA		FIN - FINLAND
2	LÄHETKANGAS LUKA	OULUN KARATESEURA		FIN - FINLAND
3	VARTIAINEN JUUSO	JOEN MAWASHI RY		FIN - FINLAND
4	TAMEH MOHAMMED	SPORTSKARATE KUOPIO		FIN - FINLAND

KUMITE, U14, TYTÖT, +47KG

KARATEN SM KILPAILUT 2024
ENTRIES BY WEIGHT CATEGORY
KUMITE, U14, TYTÖT, +47kg
As of 7 APR 2024

NOC Code	Gender	Name	Seeding
FIN	F	Hohti Hertta	
FIN	F	Korpela Siiri	
FIN	F	Monti Sofia	
FIN	F	Ollikainen Saara	
FIN	F	Stefanski Vanessa	

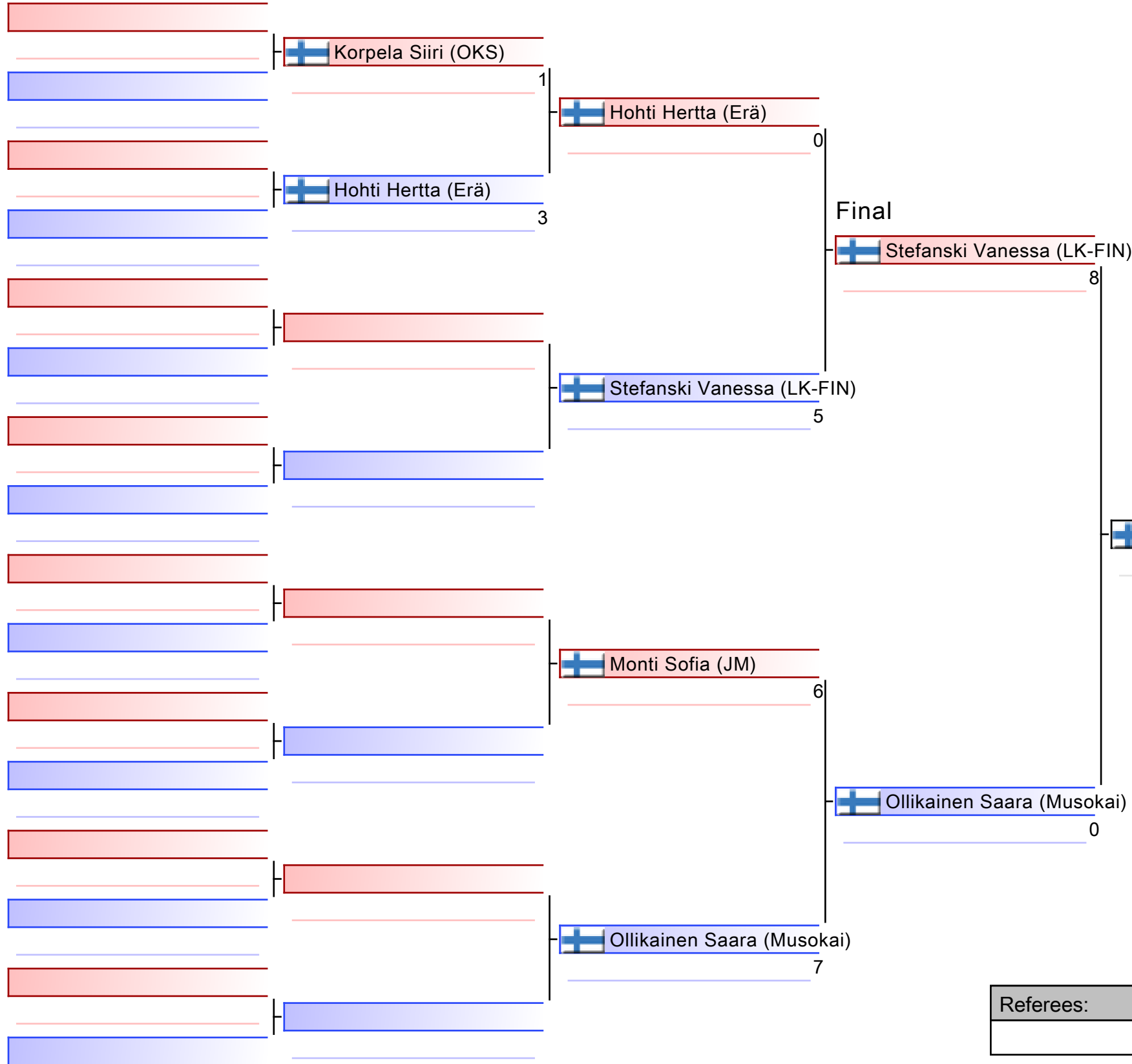

1. STEFANSKI VANESSA (LK-FIN)
2. OLLIKAINEN SAARA (MUSOKAI)
3. HOHTI HERTTA (ERÄ)
4. MONTI SOFIA (JM)

Referees:			

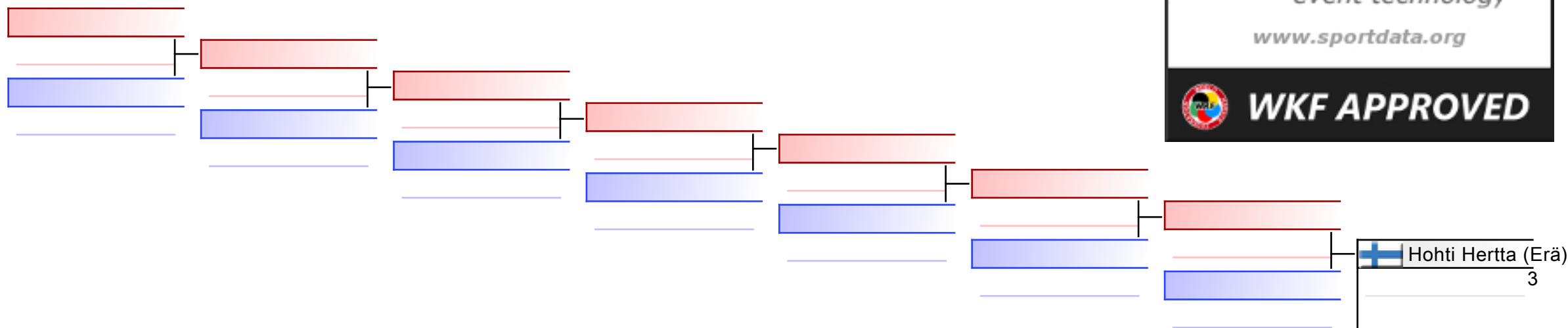



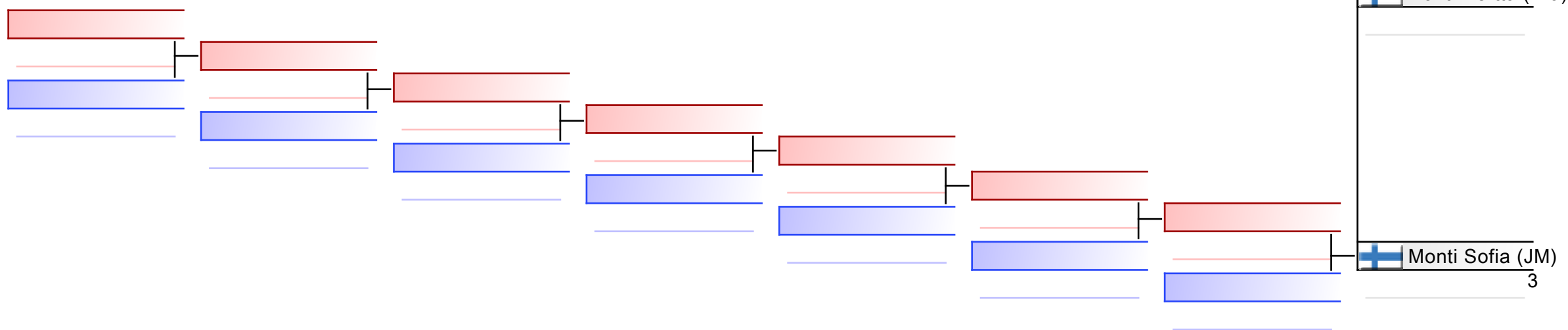

REPECHAGE: (1)



Referees:							
-----------	--	--	--	--	--	--	--

Official Results

KUMITE, U14, TYTÖT, +47kg				
1	STEFANSKI VANESSA	LAHDEN KARATE		FIN - FINLAND
2	OLLIKAINEN SAARA	BUDOSEURA OULUN MUSOKAI RY		FIN - FINLAND
3	HOHTI HERTTA	TAPANILAN ERÄ		FIN - FINLAND
4	MONTI SOFIA	JOEN MAWASHI RY		FIN - FINLAND

KUMITE, U14, TYTÖT, -42KG

KARATEN SM KILPAILUT 2024
ENTRIES BY WEIGHT CATEGORY
KUMITE, U14, TYTÖT, -42KG
As of 7 APR 2024

NOC Code	Gender	Name	Seeding
FIN	F	Antinkaapo Nea	
FIN	F	Anttila Isabella	
FIN	F	Heino Daisy	









KUMITE, U14, TYTÖT, -42KG - Round Robin (each against each)

KARATEN SM KILPAILUT 2024, Asikkalantie 14, 17200 Vääksy, FIN

2024-04-06

Tatami
3 14:05

Pool
1/1



1	 Heino Daisy (Erä)	0	 Anttila Isabella (Renshi)
2	 Anttila Isabella (Renshi)	3	
3	 Heino Daisy (Erä)	0	 Antinkaapo Nea (Jigotai)
4	 Antinkaapo Nea (Jigotai)	4	
5	 Anttila Isabella (Renshi)	4	 Anttila Isabella (Renshi)
6	 Antinkaapo Nea (Jigotai)	1	



1. ANTTILA ISABELLA (RENSHI)
2. ANTINKAAPO NEA (JIGOTAI)
3. HEINO DAISY (ERÄ)

Referees:			

Official Results

KUMITE, U14, TYTÖT, -42KG				
1	ANTTILA ISABELLA	RENSHIN-KAN RY		FIN - FINLAND
2	ANTINKAAPO NEA	JIGOTAI KARATE		FIN - FINLAND
3	HEINO DAISY	TAPANILAN ERÄ		FIN - FINLAND

KUMITE, U14, TYTÖT, -47KG

KARATEN SM KILPAILUT 2024
ENTRIES BY WEIGHT CATEGORY
KUMITE, U14, TYTÖT, -47KG
As of 7 APR 2024

NOC Code	Gender	Name	Seeding
FIN	F	Hyvönen Lila	
FIN	F	Katzman Ester	
FIN	F	Leisti Charuphat	
FIN	F	Nuhanovic Haska	



















KUMITE, U14, TYTÖT, -47KG - Round Robin (each against each)

KARATEN SM KILPAILUT 2024, Asikkalantie 14, 17200 Vääksy, FIN

2024-04-06

Tatami
3 14:20

Pool
1/1





1	 Hyvönen Lila (OM)	1	 Leisti Charuphat (Ktbc)
2	 Leisti Charuphat (Ktbc)	2	
3	 Katzman Ester (OM)	2	 Katzman Ester (OM)
4	 Nuhanovic Haska (JKA-Tampere)	0	
5	 Hyvönen Lila (OM)	0	 Katzman Ester (OM)
6	 Katzman Ester (OM)	8	
7	 Nuhanovic Haska (JKA-Tampere)	1	 Leisti Charuphat (Ktbc)
8	 Leisti Charuphat (Ktbc)	2	
9	 Hyvönen Lila (OM)	2	 Nuhanovic Haska (JKA-Tampere)
10	 Nuhanovic Haska (JKA-Tampere)	3	
11	 Leisti Charuphat (Ktbc)	2	 Katzman Ester (OM)
12	 Katzman Ester (OM)	3	



1. KATZMAN ESTER (OM)
2. LEISTI CHARUPHAT (KTBC)
3. NUHANOVIC HASKA (JKA-TAMPERE)
4. HYVÖNEN LILA (OM)

Referees:			

Official Results

KUMITE, U14, TYTÖT, -47KG				
1	KATZMAN ESTER	SPORTSKARATE KUOPIO		FIN - FINLAND
2	LEISTI CHARUPHAT	KOTKA THAIBOXING CLUB		FIN - FINLAND
3	NUHANOVIC HASKA	JAPAN KARATE ASSOCIATION TAMPERE RY		FIN - FINLAND
4	HYVÖNEN LILA	SPORTSKARATE KUOPIO		FIN - FINLAND

KUMITE, U16, POJAT +63KG
YHDISTETTY

KARATEN SM KILPAILUT 2024
ENTRIES BY WEIGHT CATEGORY
KUMITE, U16, POJAT +63KG yhdistetty
As of 7 APR 2024

NOC Code	Gender	Name	Seeding
FIN	M	Algahawi Yakoot	
FIN	M	Eronen Alex	
FIN	M	Huuskonen Veeti	
FIN	M	Pienimäki Roope	
FIN	M	Pylvänen Anton	

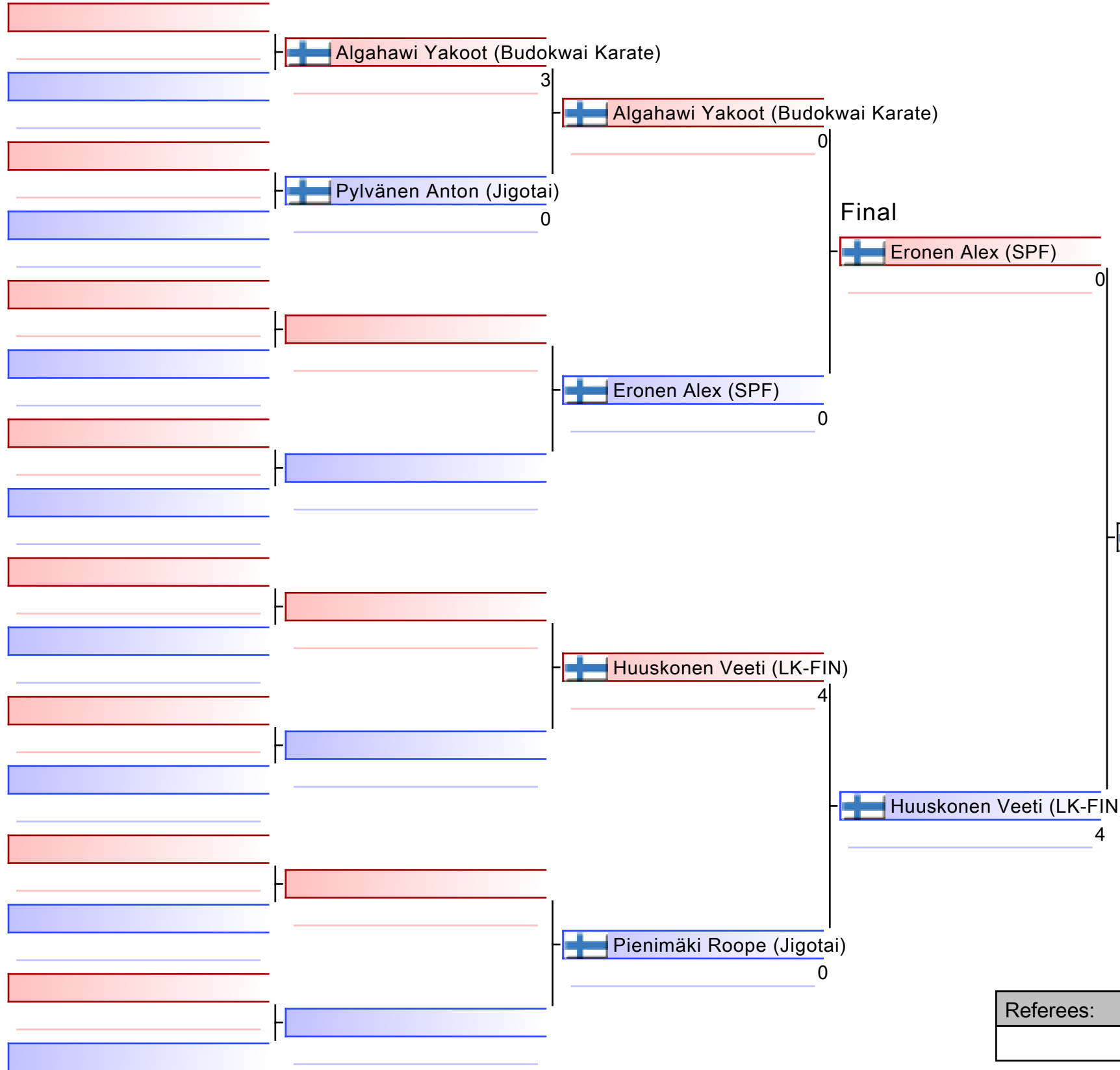



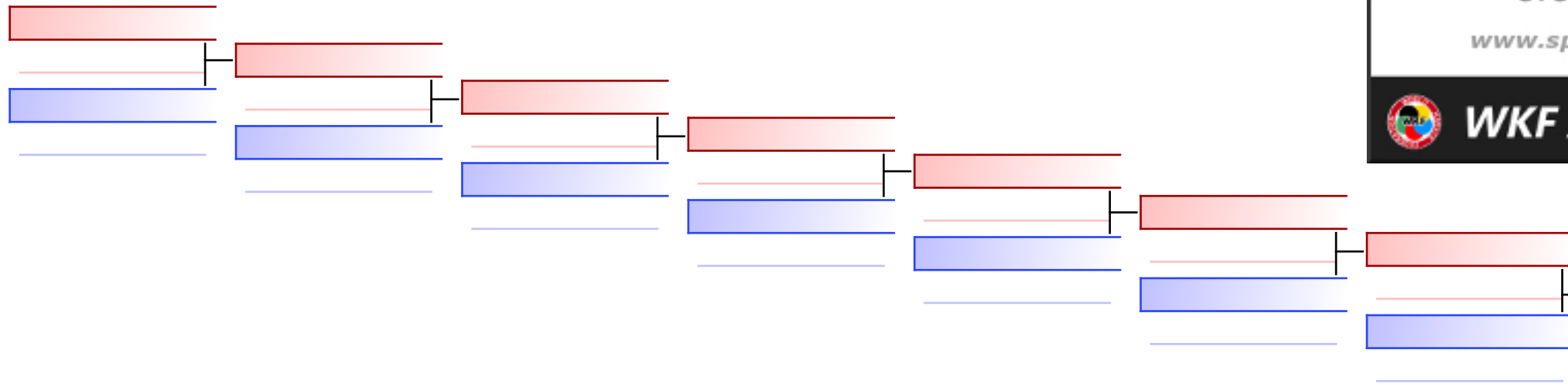

1. HUUSKONEN VEETI (LK-FIN)
2. ERONEN ALEX (SPF)
3. PIENIMÄKI ROOPE (JIGOTAI)
4. ALGAHAWI YAKOOT (BUDOKWAI KARATE)

Referees:			

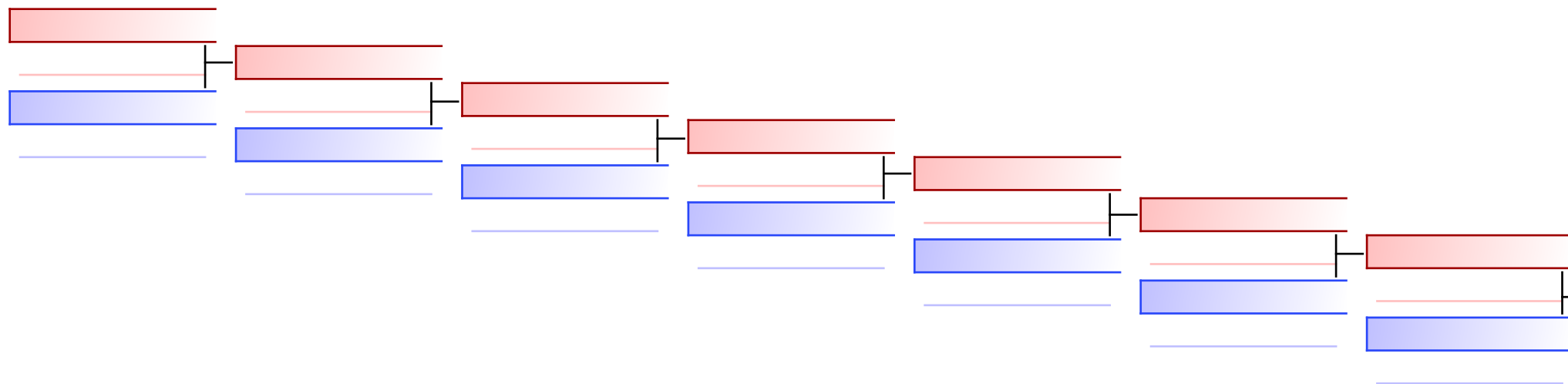





REPECHAGE: (1)



-  **Algahawi Yakoot (Budokwai Kara)**
0
-  **Pienimäki Roope (Jigotai)**
-  **Pienimäki Roope (Jigotai)**
0

Referees:							
-----------	--	--	--	--	--	--	--

Official Results

KUMITE, U16, POJAT +63KG yhdistetty				
1	HUUSKONEN VEETI	LAHDEN KARATE		FIN - FINLAND
2	ERONEN ALEX	SPORTSKARATE.FI		FIN - FINLAND
3	PIENIMÄKI ROOPE	JIGOTAI KARATE		FIN - FINLAND
4	ALGAHAWI YAKOOT	BUDOKWAI RY KARATE		FIN - FINLAND

KUMITE, U16, POJAT, -52KG

KARATEN SM KILPAILUT 2024
ENTRIES BY WEIGHT CATEGORY
KUMITE, U16, POJAT, -52KG
As of 7 APR 2024

NOC Code	Gender	Name	Seeding
FIN	M	Hanhinen Onni	
FIN	M	Kettunen Eemeli	
FIN	M	Lauronen Leo	
FIN	M	Mattinen Nuutti	
FIN	M	Sandgren Joonas	
FIN	M	Tarkkanen Otso	
FIN	M	Tikkanen Elias	
FIN	M	Tkachenko Timofei	

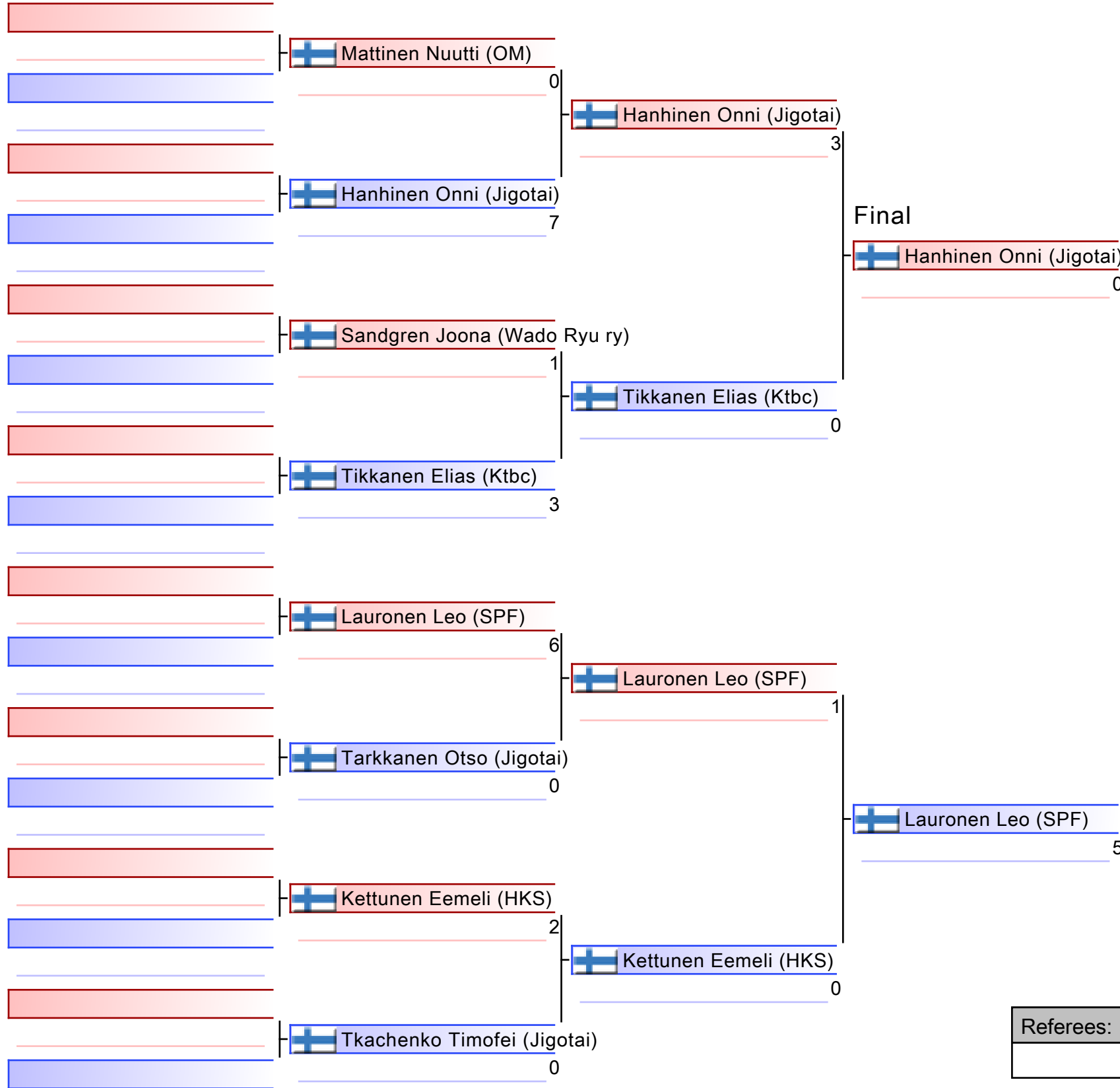

Lauronen Leo (SPF)

1. LAURONEN LEO (SPF)
2. HANHINEN ONNI (JIGOTAI)
3. KETTUNEN EEMELI (HKS)
4. TIKKANEN ELIAS (KTBC)
5. MATTINEN NUUTTI (OM)
5. TARKKANEN OTSO (JIGOTAI)

Referees:			

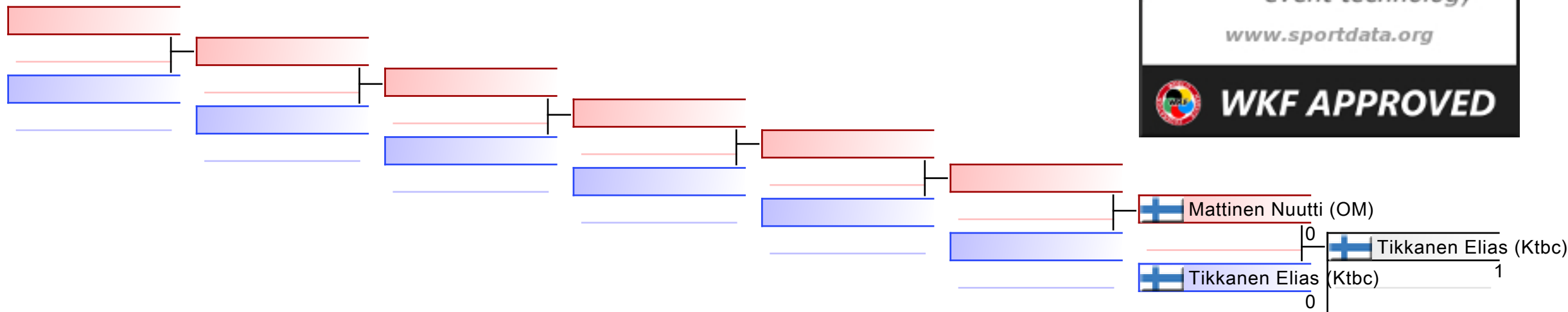



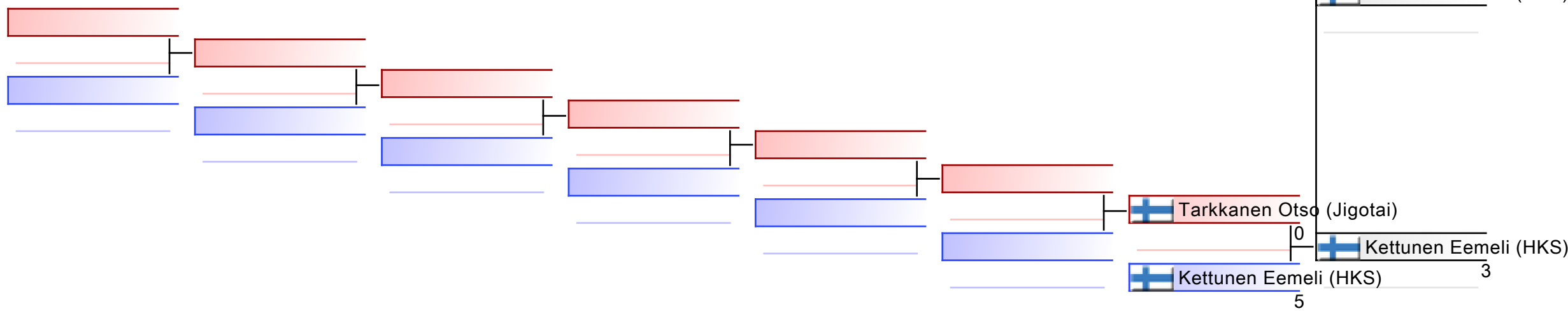



REPECHAGE: (1)



Referees:							
-----------	--	--	--	--	--	--	--

KARATEN SM KILPAILUT 2024 - 2024-04-06

Official Results

KUMITE, U16, POJAT, -52KG				
1	LAURONEN LEO	SPORTSKARATE.FI		FIN - FINLAND
2	HANHINEN ONNI	JIGOTAI KARATE		FIN - FINLAND
3	KETTUNEN EEMELI	HÄMEENLINNAN KARATESEURA		FIN - FINLAND
4	TIKKANEN ELIAS	KOTKA THAIBOXING CLUB		FIN - FINLAND
5	MATTINEN NUUTTI	SPORTSKARATE KUOPIO		FIN - FINLAND
5	TARKKANEN OTSO	JIGOTAI KARATE		FIN - FINLAND

KUMITE, U16, POJAT, -57KG

KARATEN SM KILPAILUT 2024
ENTRIES BY WEIGHT CATEGORY
KUMITE, U16, POJAT, -57KG
As of 7 APR 2024

NOC Code	Gender	Name	Seeding
FIN	M	Hirvonen Jesse	
FIN	M	Ihanus Matias	
FIN	M	Järvenpää Tatu	
FIN	M	Matero Luka	
FIN	M	Saadaoui Sami	
FIN	M	Simonen Tino	
FIN	M	Vaara Santeri	
FIN	M	Väyrynen Luukas	

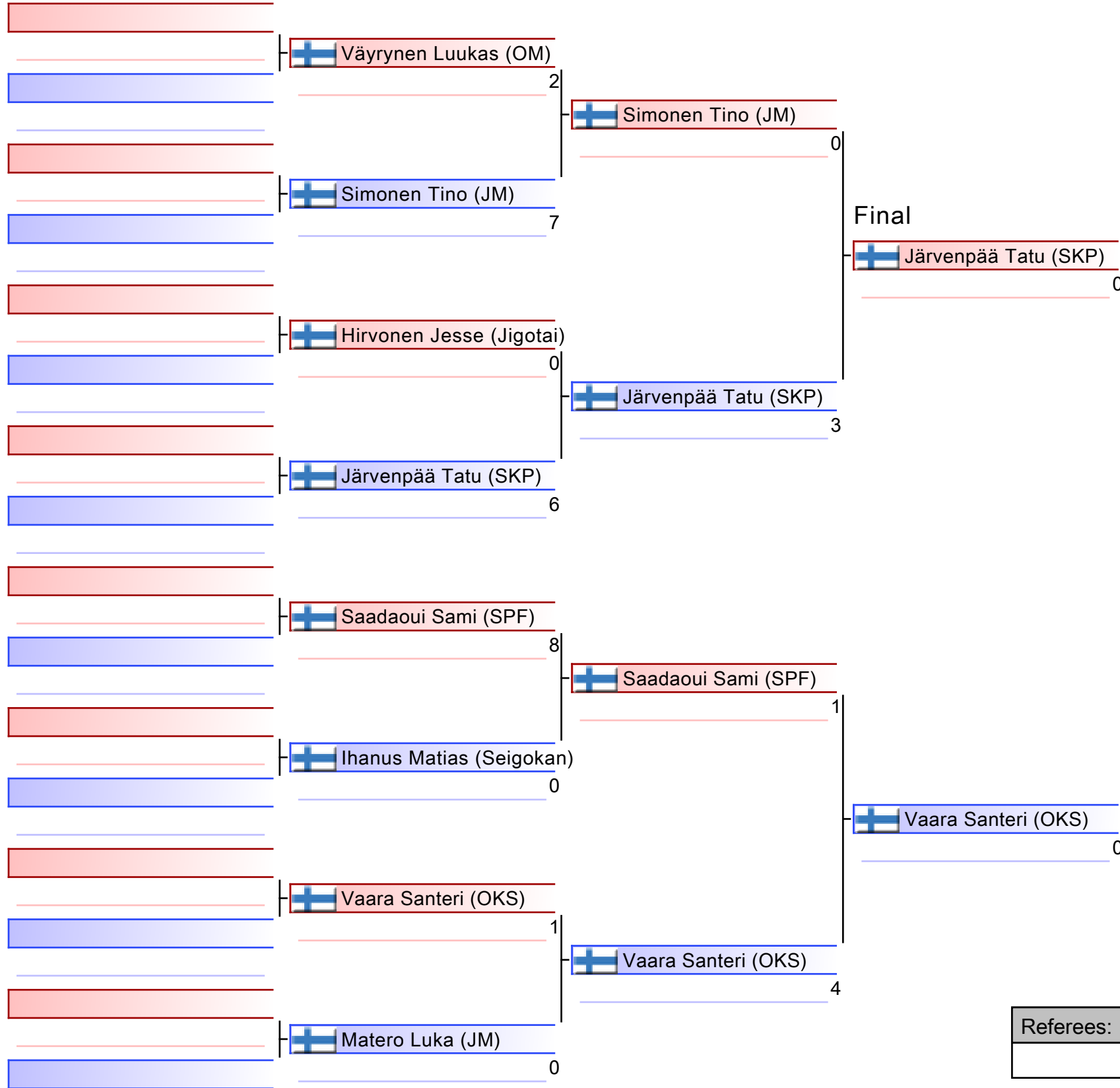

Vaara Santeri (OKS)

1. VAARA SANTERI (OKS)
2. JÄRVENPÄÄ TATU (SKP)
3. SIMONEN TINO (JM)
4. SAADAOUI SAMI (SPF)
5. HIRVONEN JESSE (JIGOTAI)
5. MATERO LUKA (JM)

Referees:			

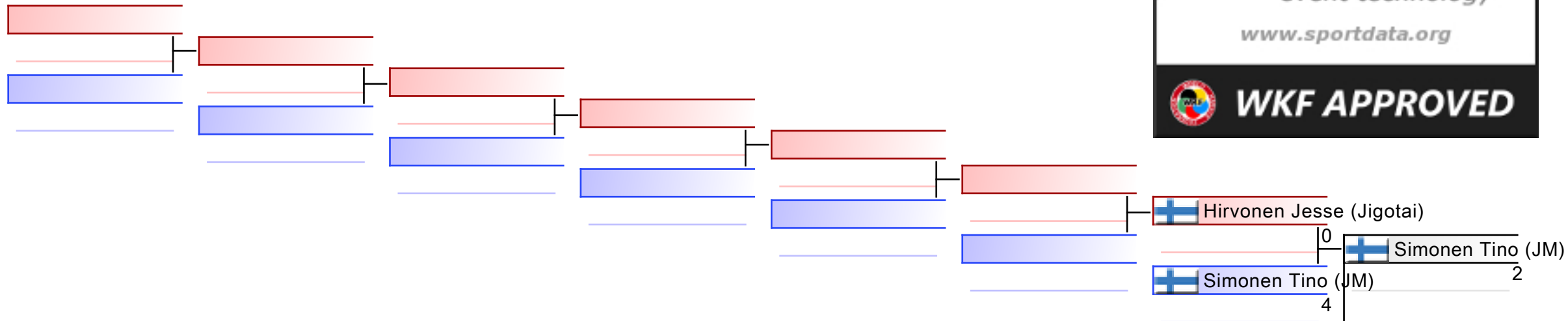



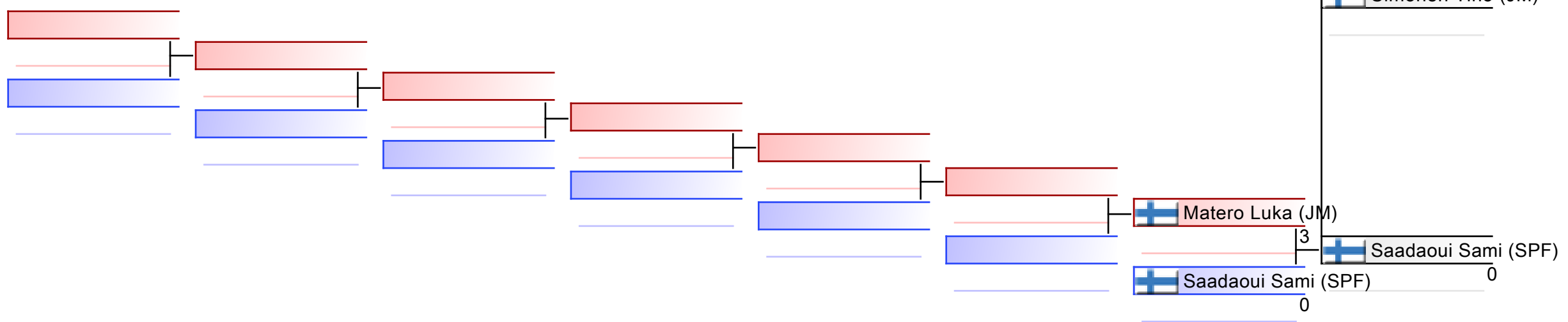



REPECHAGE: (1)



Referees:							
-----------	--	--	--	--	--	--	--

Official Results

KUMITE, U16, POJAT, -57KG					
1	VAARA SANTERI	OULUN KARATESEURA		FIN - FINLAND	
2	JÄRVENPÄÄ TATU	SPORTSKARATE PORI		FIN - FINLAND	
3	SIMONEN TINO	JOEN MAWASHI RY		FIN - FINLAND	
4	SAADAOUI SAMI	SPORTSKARATE.FI		FIN - FINLAND	
5	HIRVONEN JESSE	JIGOTAI KARATE		FIN - FINLAND	
5	MATERO LUKA	JOEN MAWASHI RY		FIN - FINLAND	

KUMITE, U16, POJAT, -63KG

KARATEN SM KILPAILUT 2024
ENTRIES BY WEIGHT CATEGORY
KUMITE, U16, POJAT, -63KG
As of 7 APR 2024

NOC Code	Gender	Name	Seeding
FIN	M	Honkanen Santtu	
FIN	M	Simonen Rene	
FIN	M	Tuononen Niko	

KUMITE, U16, POJAT, -63KG - Round Robin (each against each)

KARATEN SM KILPAILUT 2024, Asikkalantie 14, 17200 Vääksy, FIN









2024-04-06

Tatami

1 14:00

Pool

1/1

1	 Tuononen Niko (OM)	1	 Honkanen Santtu (SPF)
2	 Honkanen Santtu (SPF)	4	
3	 Tuononen Niko (OM)	0	 Simonen Rene (JM)
4	 Simonen Rene (JM)	6	
5	 Honkanen Santtu (SPF)	6	 Honkanen Santtu (SPF)
6	 Simonen Rene (JM)	6	





1. HONKANEN SANTTU (SPF)
2. SIMONEN RENE (JM)
3. TUONONEN NIKO (OM)

Referees:			

KARATEN SM KILPAILUT 2024 - 2024-04-06

Official Results

KUMITE, U16, POJAT, -63KG				
1	HONKANEN SANTTU	SPORTSKARATE.FI		FIN - FINLAND
2	SIMONEN RENE	JOEN MAWASHI RY		FIN - FINLAND
3	TUONONEN NIKO	SPORTSKARATE KUOPIO		FIN - FINLAND

KUMITE, U16, TYTÖT -54KG
YHDISTETTY

KARATEN SM KILPAILUT 2024
ENTRIES BY WEIGHT CATEGORY
KUMITE, U16, TYTÖT -54KG yhdistetty
As of 7 APR 2024

NOC Code	Gender	Name	Seeding
FIN	F	Chepelev Sofia	
FIN	F	Hannu Alva	
FIN	F	Itkonen Janika	
FIN	F	Kenttä Hilda	
FIN	F	Lehtinen Eleanor	
FIN	F	Luukka Erin	
FIN	F	Rissanen Iina	

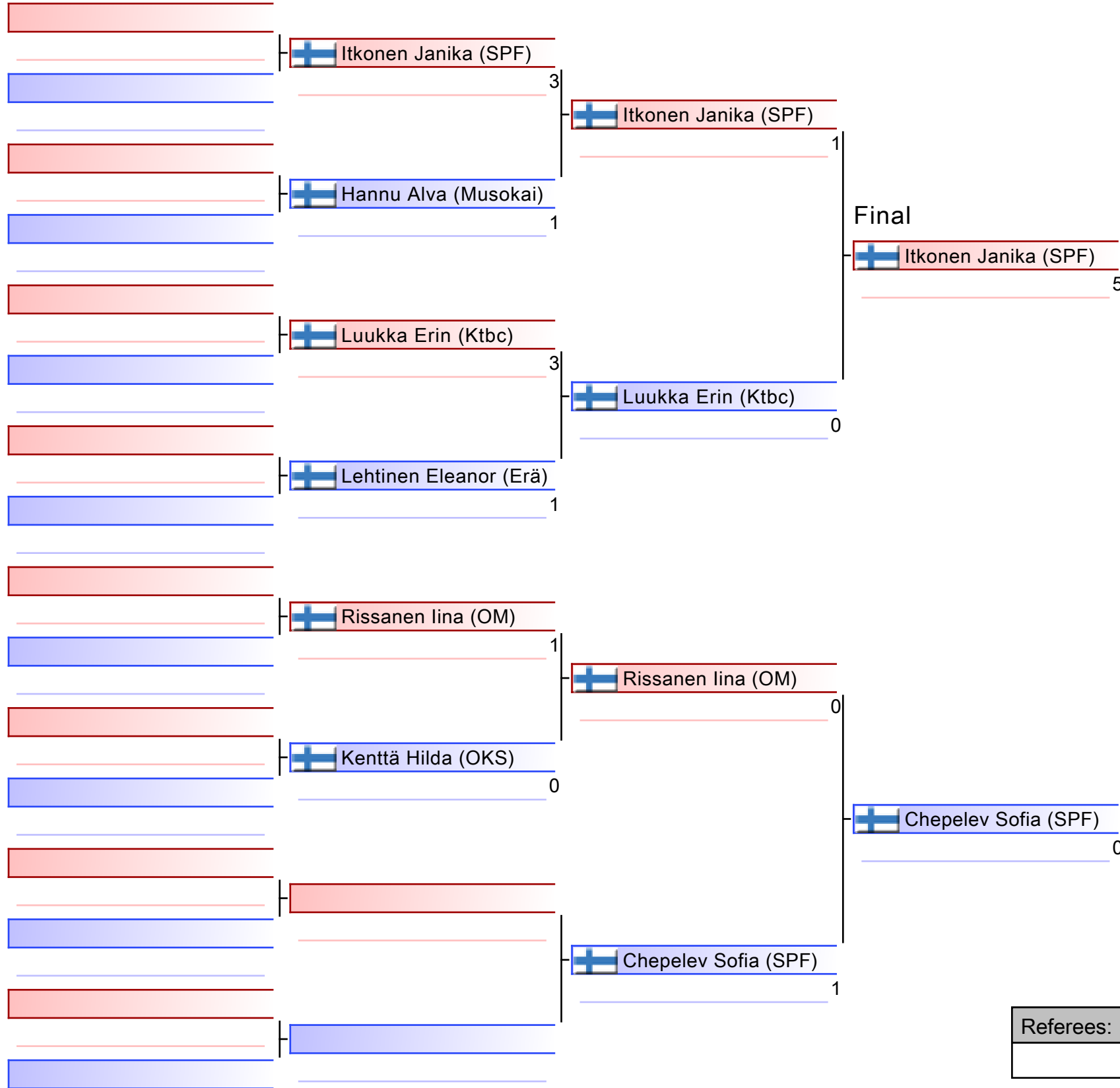

Itkonen Janika (SPF)

1. ITKONEN JANIKA (SPF)
2. CHEPELEV SOFIA (SPF)
3. HANNU ALVA (MUSOKAI)
4. RISSANEN IINA (OM)
5. LUUKKA ERIN (KTBC)

Referees:			

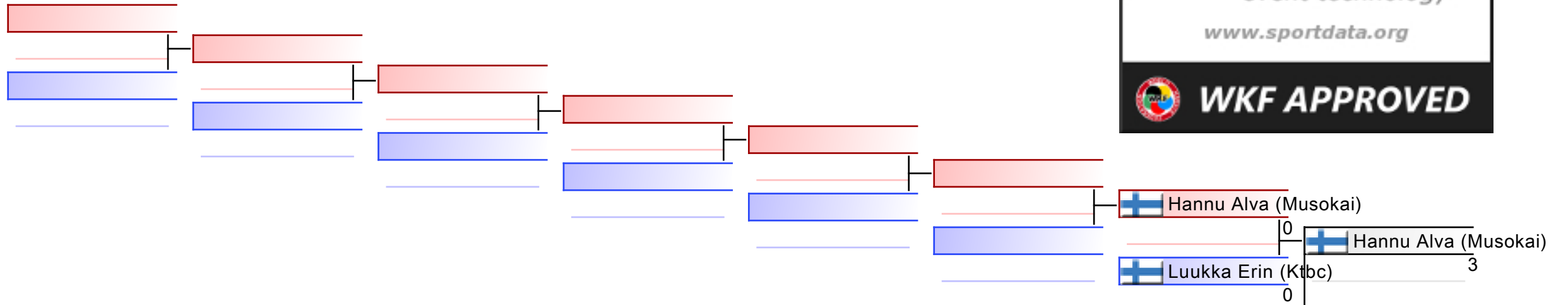



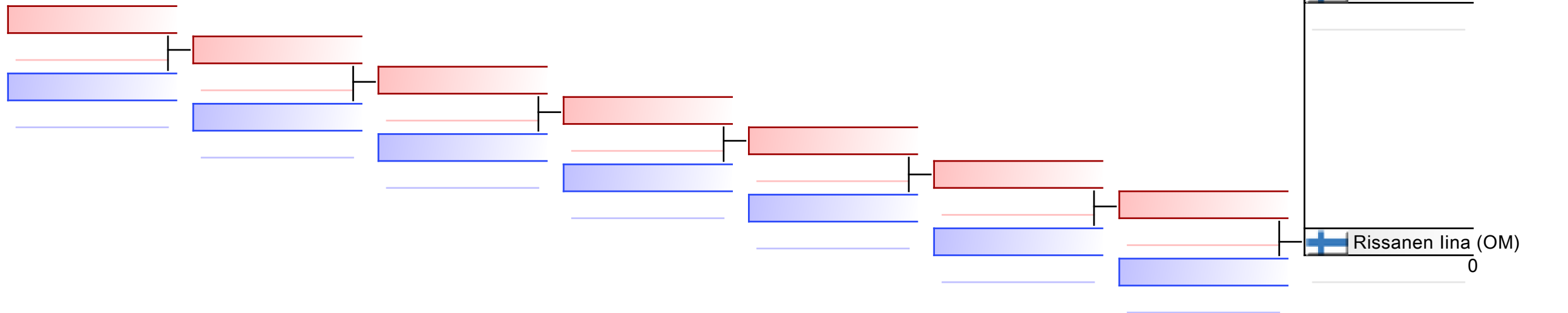

REPECHAGE: (1)



Referees:							
-----------	--	--	--	--	--	--	--

Official Results

KUMITE, U16, TYTÖT -54KG yhdistetty				
1	IITKONEN JANIKA	SPORTSKARATE.FI		FIN - FINLAND
2	CHEPELEV SOFIA	SPORTSKARATE.FI		FIN - FINLAND
3	HANNU ALVA	BUDOSEURA OULUN MUSOKAI RY		FIN - FINLAND
4	RISSANEN IINA	SPORTSKARATE KUOPIO		FIN - FINLAND
5	LUUKKA ERIN	KOTKA THAIBOXING CLUB		FIN - FINLAND

KUMITE, U16, TYTÖT, +54KG

KARATEN SM KILPAILUT 2024
ENTRIES BY WEIGHT CATEGORY
KUMITE, U16, TYTÖT, +54KG
As of 7 APR 2024

NOC Code	Gender	Name	Seeding
FIN	F	Jokinen Helmi	
FIN	F	Lehto Ida	
FIN	F	Mertamo Amanda	
FIN	F	Saarnio Selja	
FIN	F	Silen Venla	

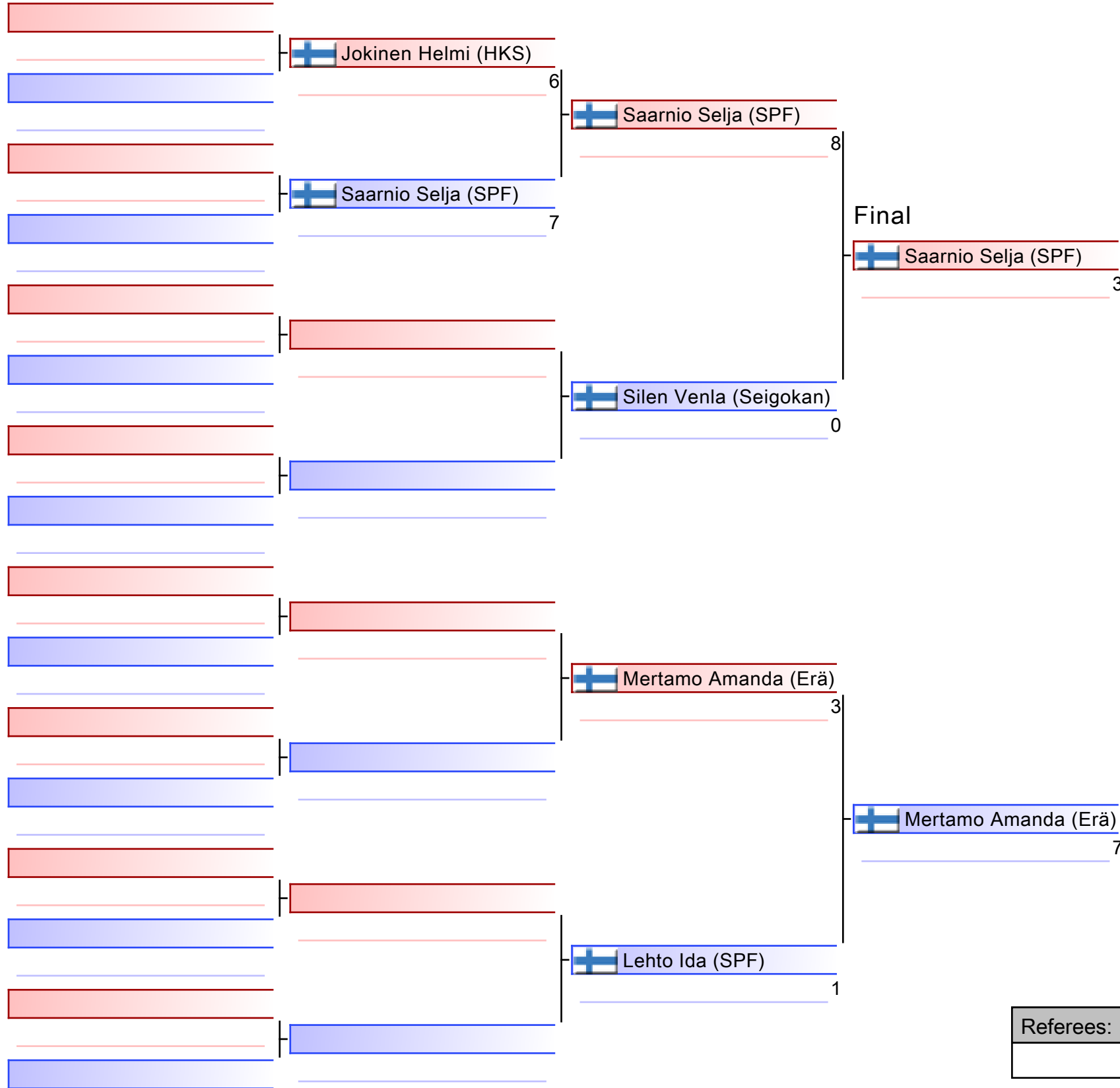

1. MERTAMO AMANDA (ERÄ)
2. SAARNIO SELJA (SPF)
3. JOKINEN HELMI (HKS)
4. LEHTO IDA (SPF)
5. SILEN VENLA (SEIGOKAN)

Referees:			

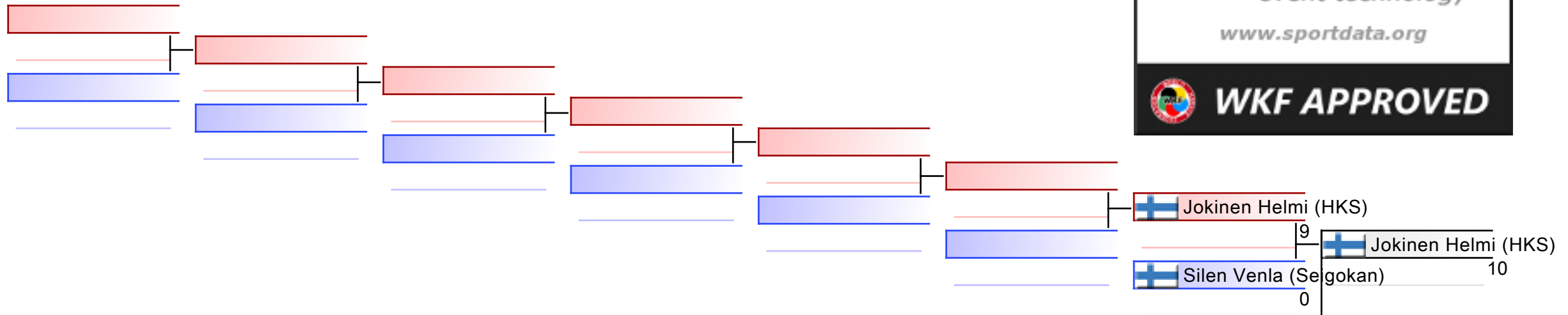



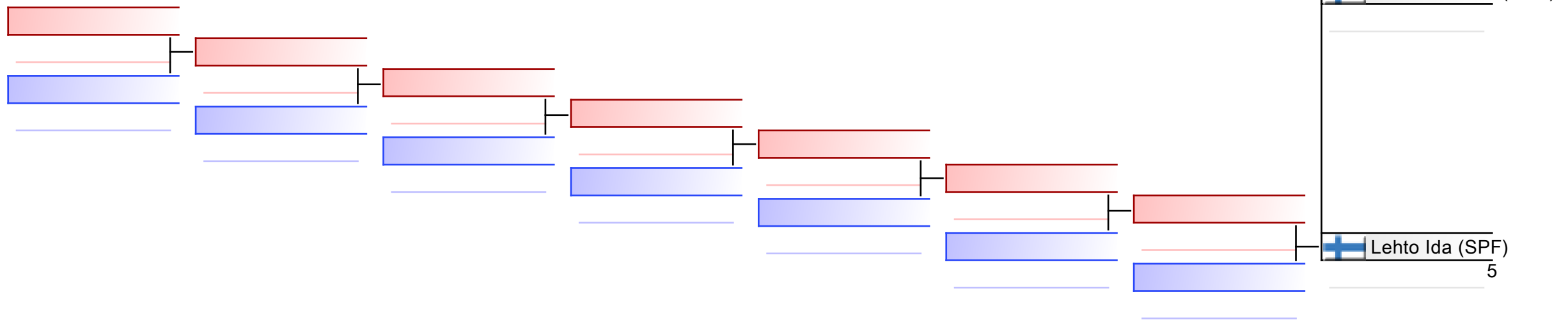

REPECHAGE: (1)



Referees:							
-----------	--	--	--	--	--	--	--

Official Results

KUMITE, U16, TYTÖT, +54KG				
1	MERTAMO AMANDA	TAPANILAN ERÄ		FIN - FINLAND
2	SAARNIO SELJA	SPORTSKARATE.FI		FIN - FINLAND
3	JOKINEN HELMI	HÄMEENLINNAN KARATESEURA		FIN - FINLAND
4	LEHTO IDA	SPORTSKARATE.FI		FIN - FINLAND
5	SILEN VENLA	SEIGOKAN TAMPERE		FIN - FINLAND

KUMITE, U18, POJAT -68KG
YHDISTETTY

KARATEN SM KILPAILUT 2024
ENTRIES BY WEIGHT CATEGORY
KUMITE, U18, POJAT -68KG yhdistetty
As of 7 APR 2024

NOC Code	Gender	Name	Seeding
FIN	M	Marttila Lauri	
FIN	M	Matero Jimi	
FIN	M	Nurmesniemi Lauri	
FIN	M	Ramula Tuukka	
FIN	M	Tolvanen Mido	
FIN	M	Väyrynen Luukas	

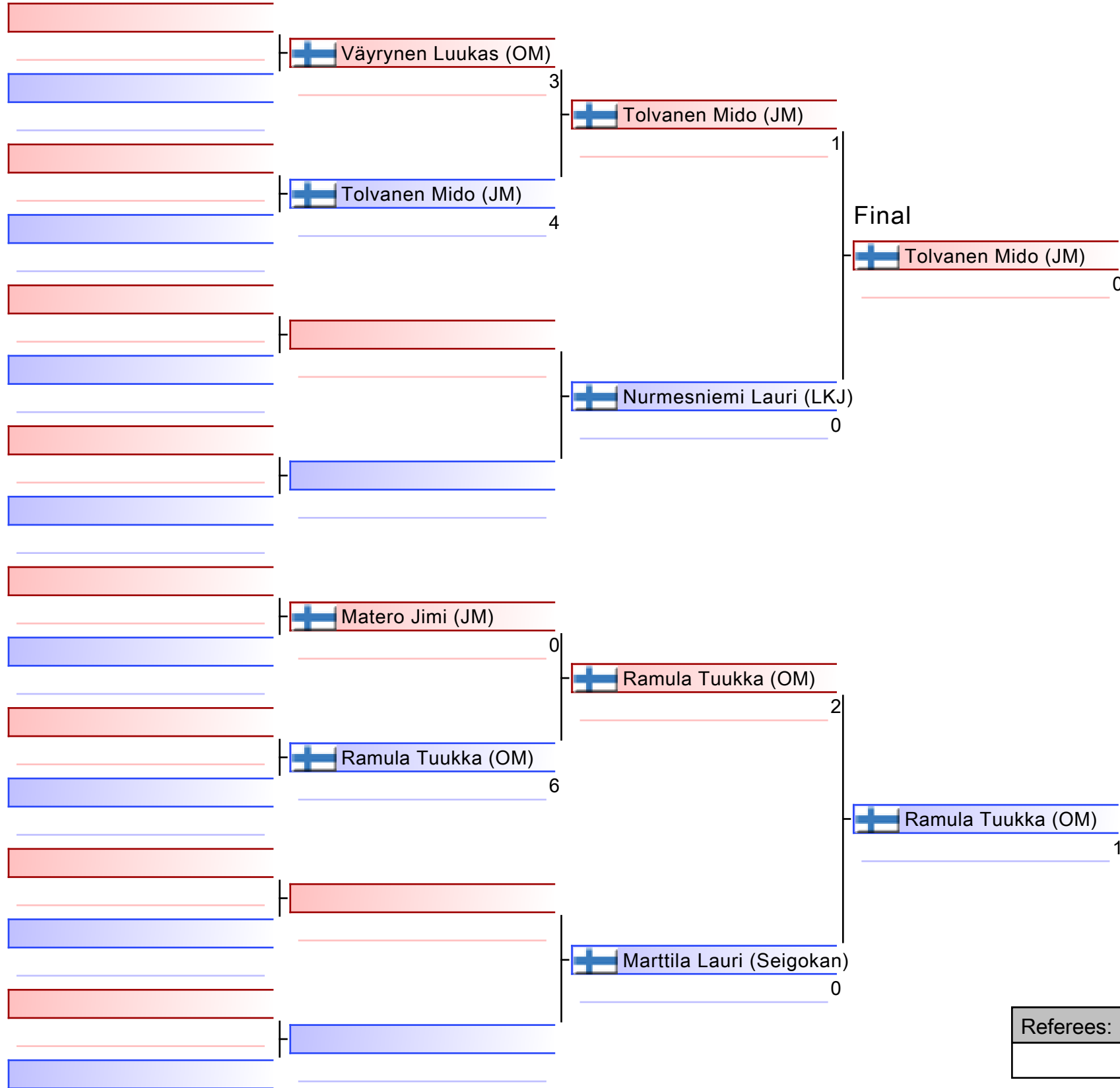

1. RAMULA TUUKKA (OM)
2. TOLVANEN MIDO (JM)
3. VÄYRYNEN LUUKAS (OM)
4. MATERO JIMI (JM)
5. NURMESNIEMI LAURI (LKJ)
5. MARTTILA LAURI (SEIGOKAN)

Referees:			

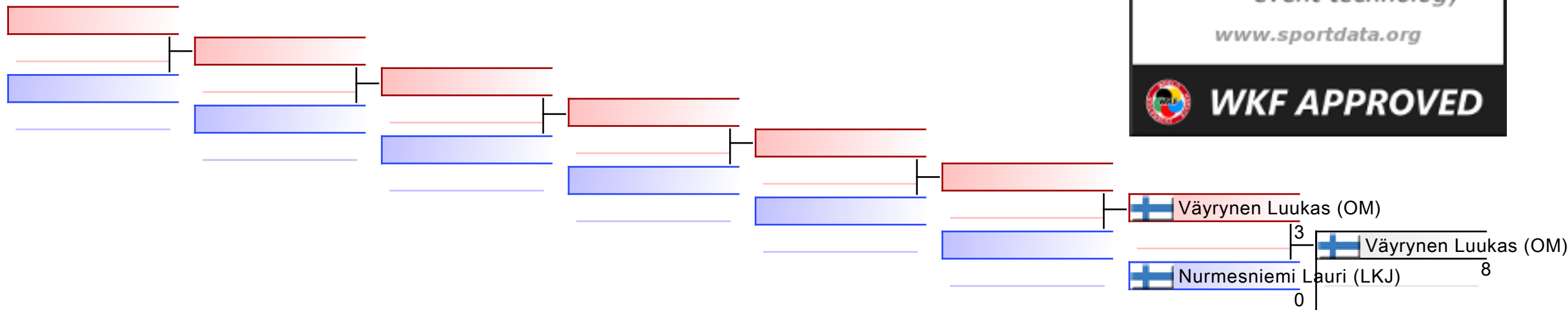



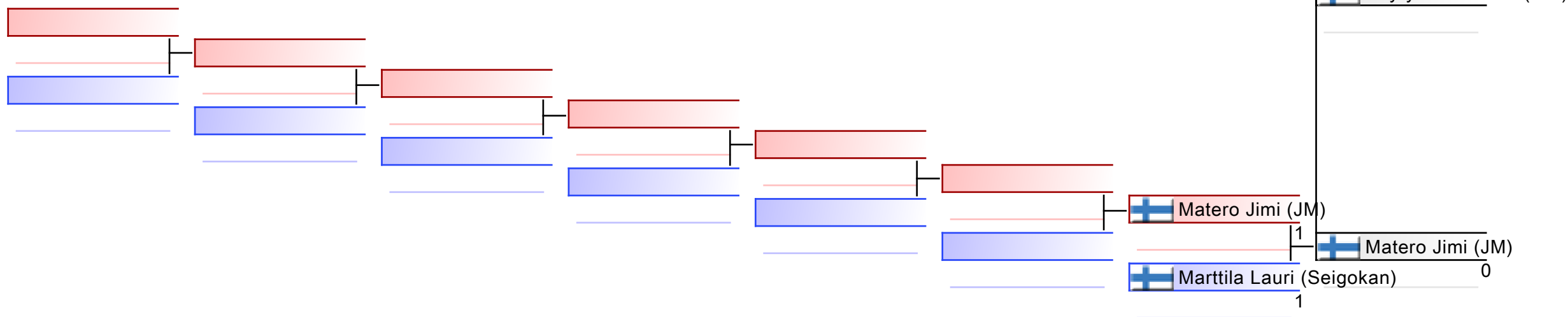



REPECHAGE: (1)



Referees:							
-----------	--	--	--	--	--	--	--

KARATEN SM KILPAILUT 2024 - 2024-04-06

Official Results

KUMITE, U18, POJAT -68KG yhdistetty				
1	RAMULA TUUKKA	SPORTSKARATE KUOPIO		FIN - FINLAND
2	TOLVANEN MIDO	JOEN MAWASHI RY		FIN - FINLAND
3	VÄYRYNEN LUUKAS	SPORTSKARATE KUOPIO		FIN - FINLAND
4	MATERO JIMI	JOEN MAWASHI RY		FIN - FINLAND
5	NURMESNIEMI LAURI	LAKEUDEN KARATE- JUTSU RY		FIN - FINLAND
5	MARTTILA LAURI	SEIGOKAN TAMPERE		FIN - FINLAND

KUMITE, U18, POJAT, +76KG

KARATEN SM KILPAILUT 2024
ENTRIES BY WEIGHT CATEGORY
KUMITE, U18, POJAT, +76KG
As of 7 APR 2024

NOC Code	Gender	Name	Seeding
FIN	M	Lintelä Jami	
FIN	M	Mantere Jimi	

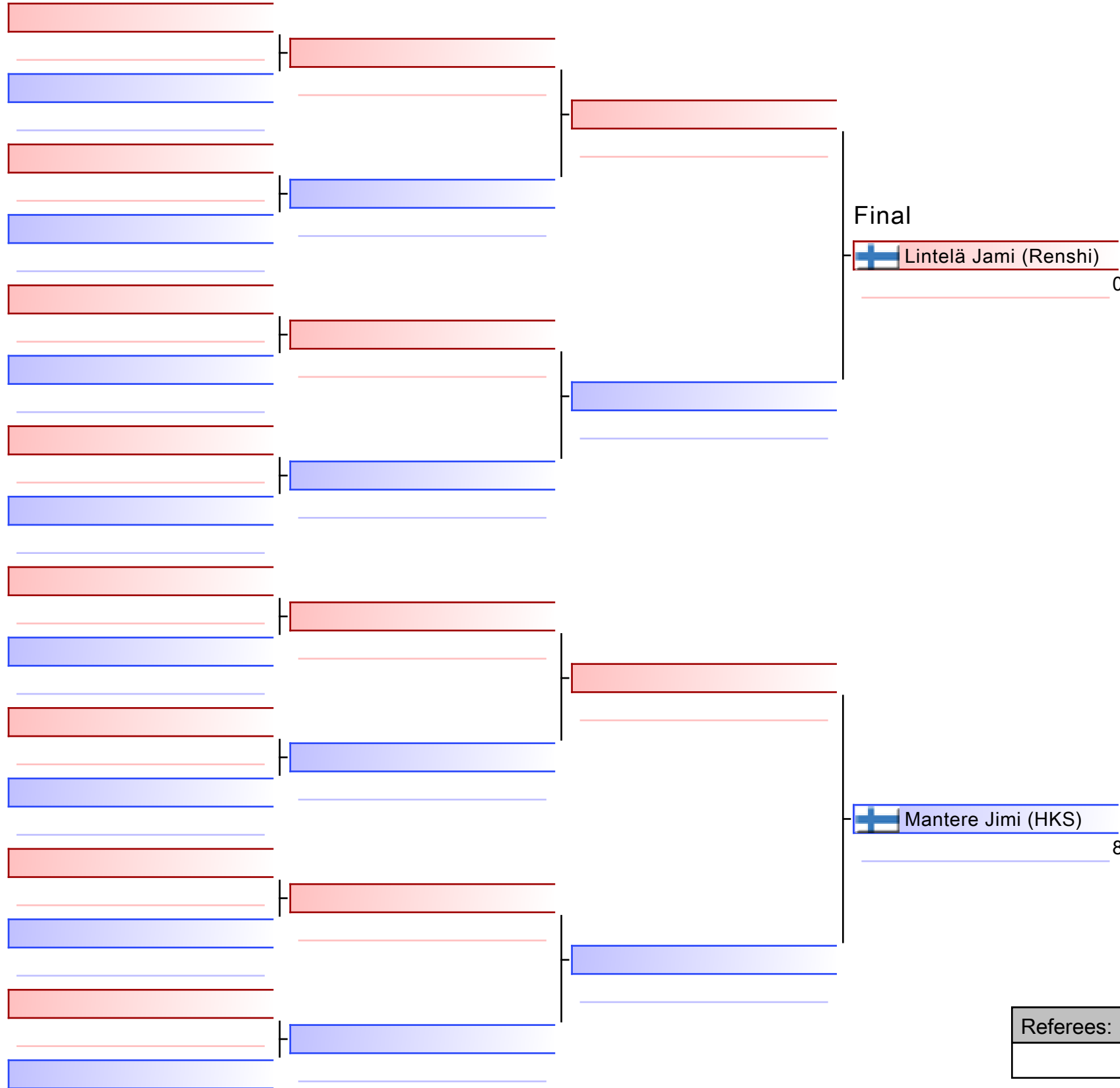

Final

Lintelä Jami (Renshi)

0

Mantere Jimi (HKS)



Mantere Jimi (HKS)

8

1. MANTERE JIMI (HKS)
2. LINTELÄ JAMI (RENSHI)

Referees:			

Official Results

KUMITE, U18, POJAT, +76KG				
1	MANTERE JIMI	HÄMEENLINNAN KARATESEURA		FIN - FINLAND
2	LINTELÄ JAMI	RENSHIN-KAN RY		FIN - FINLAND

KUMITE, U18, POJAT, -76KG

KARATEN SM KILPAILUT 2024
ENTRIES BY WEIGHT CATEGORY
KUMITE, U18, POJAT, -76KG
As of 7 APR 2024

NOC Code	Gender	Name	Seeding
FIN	M	Hänninen Aarni	
FIN	M	Hänninen Niilo	
FIN	M	Kreus Petrus	
FIN	M	Nuhanovic Alsad	



















KUMITE, U18, POJAT, -76KG - Round Robin (each against each)

KARATEN SM KILPAILUT 2024, Asikkalantie 14, 17200 Vääksy, FIN

2024-04-06

Tatami
2 13:20

Pool
1/1





1	 Hänninen Aarni (Renshi)	3	 Hänninen Aarni (Renshi)
2	 Nuhanovic Alsad (JKA-Tampere)	0	
3	 Kreus Petrus (JKA-Tampere)	0	 Hänninen Niilo (Renshi)
4	 Hänninen Niilo (Renshi)	4	
5	 Hänninen Aarni (Renshi)	2	 Hänninen Aarni (Renshi)
6	 Kreus Petrus (JKA-Tampere)	0	
7	 Hänninen Niilo (Renshi)	3	 Hänninen Niilo (Renshi)
8	 Nuhanovic Alsad (JKA-Tampere)	0	
9	 Hänninen Aarni (Renshi)	3	 Hänninen Aarni (Renshi)
10	 Hänninen Niilo (Renshi)	2	
11	 Nuhanovic Alsad (JKA-Tampere)	1	 Nuhanovic Alsad (JKA-Tampere)
12	 Kreus Petrus (JKA-Tampere)	0	



1. HÄNNINEN AARNI (RENSHI)
2. HÄNNINEN NIILLO (RENSHI)
3. NUHANOVIC ALSAD (JKA-TAMPERE)
4. KREUS PETRUS (JKA-TAMPERE)

Referees:			

Official Results

KUMITE, U18, POJAT, -76KG				
1	HÄNNINEN AARNI	RENSHIN-KAN RY		FIN - FINLAND
2	HÄNNINEN NIILLO	RENSHIN-KAN RY		FIN - FINLAND
3	NUHANOVIC ALSAD	JAPAN KARATE ASSOCIATION TAMPERE RY		FIN - FINLAND
4	KREUS PETRUS	JAPAN KARATE ASSOCIATION TAMPERE RY		FIN - FINLAND

KUMITE, U18, TYTÖT +59KG
YHDISTETTY

KARATEN SM KILPAILUT 2024
ENTRIES BY WEIGHT CATEGORY
KUMITE, U18, TYTÖT +59KG yhdistetty
As of 7 APR 2024

NOC Code	Gender	Name	Seeding
FIN	F	Jokinen Helmi	
FIN	F	Lafghani Hanan	
FIN	F	Mertamo Amanda	
FIN	F	Meyke Alexandra	
FIN	F	Saadaoui Sonya	
FIN	F	Väliahdet Olga	

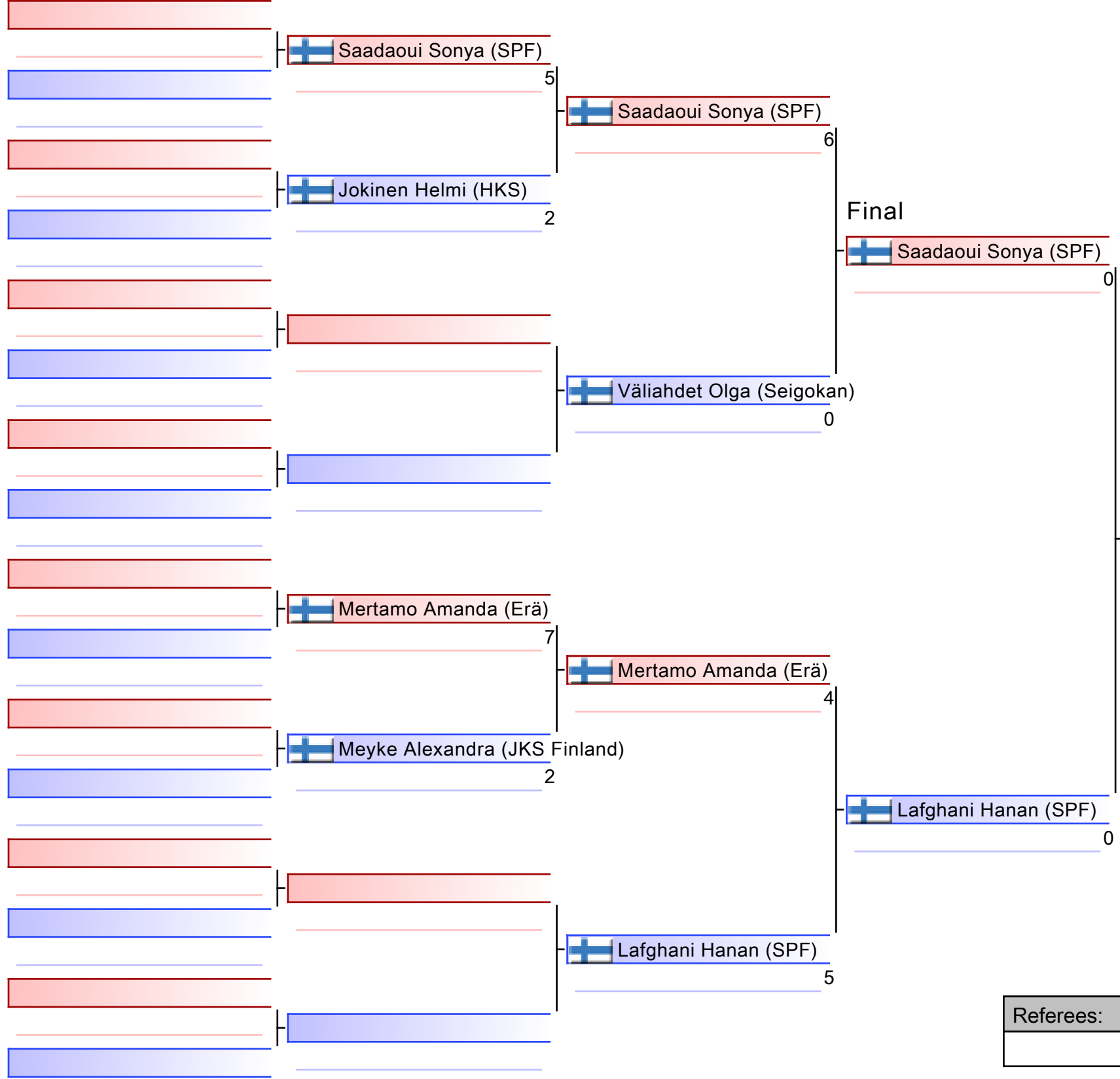

Saadaoui Sonya (SPF)

1. SAADAOUI SONYA (SPF)
2. LAFGHANI HANAN (SPF)
3. MERTAMO AMANDA (ERÄ)
4. JOKINEN HELMI (HKS)
5. VÄLIAHDET OLGA (SEIGOKAN)

Referees:			

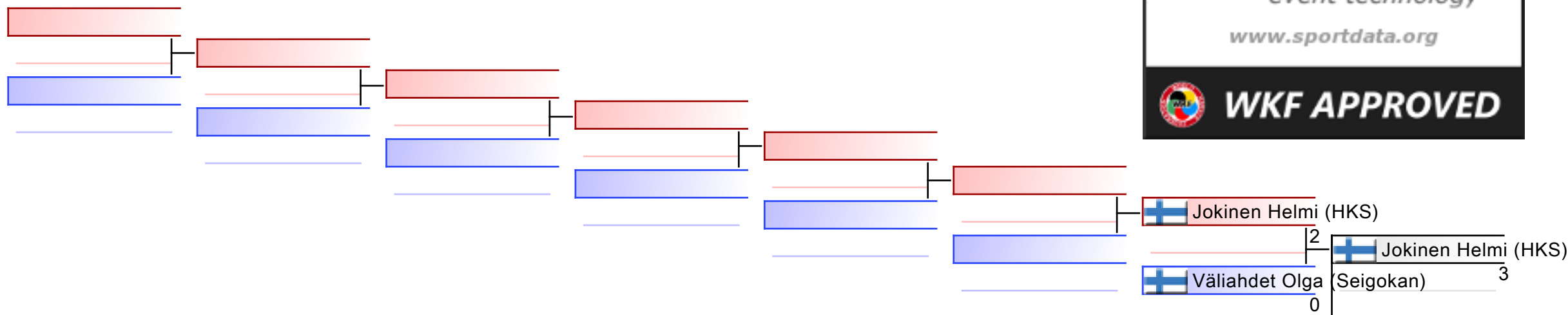



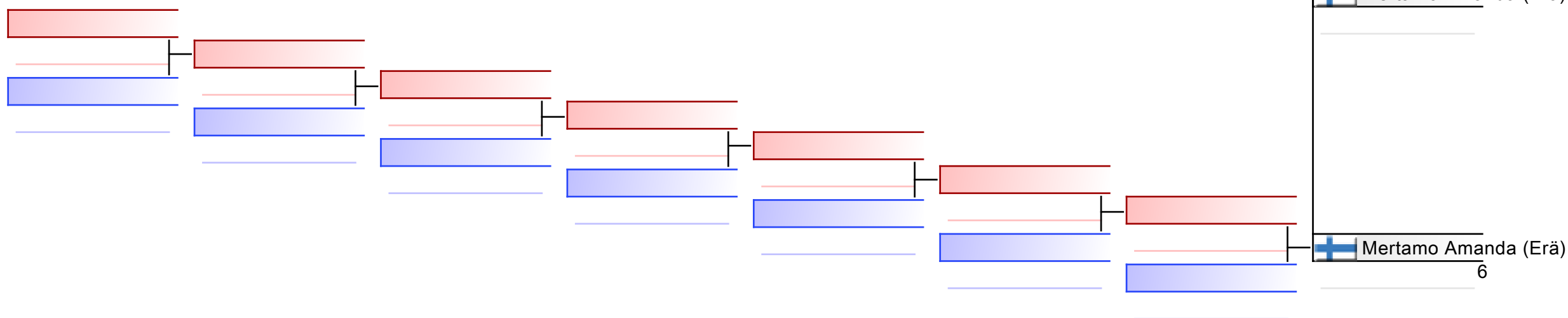

REPECHAGE: (1)



Referees:							
-----------	--	--	--	--	--	--	--

Official Results

KUMITE, U18, TYTÖT +59KG yhdistetty				
1	SAADAOUI SONYA	SPORTSKARATE.FI		FIN - FINLAND
2	LAFGHANI HANAN	SPORTSKARATE.FI		FIN - FINLAND
3	MERTAMO AMANDA	TAPANILAN ERÄ		FIN - FINLAND
4	JOKINEN HELMI	HÄMEENLINNAN KARATESEURA		FIN - FINLAND
5	VÄLIAHDET OLGA	SEIGOKAN TAMPERE		FIN - FINLAND

KUMITE, U18, TYTÖT -59KG
YHDISTETTY

KARATEN SM KILPAILUT 2024
ENTRIES BY WEIGHT CATEGORY
KUMITE, U18, TYTÖT -59KG yhdistetty
As of 7 APR 2024

NOC Code	Gender	Name	Seeding
FIN	F	Itkonen Janika	
FIN	F	Koivula Sofia	
FIN	F	Paattimäki Aliisa	
FIN	F	Rissanen Iina	
FIN	F	Salme Kristiina	
FIN	F	Savolainen Meeri	

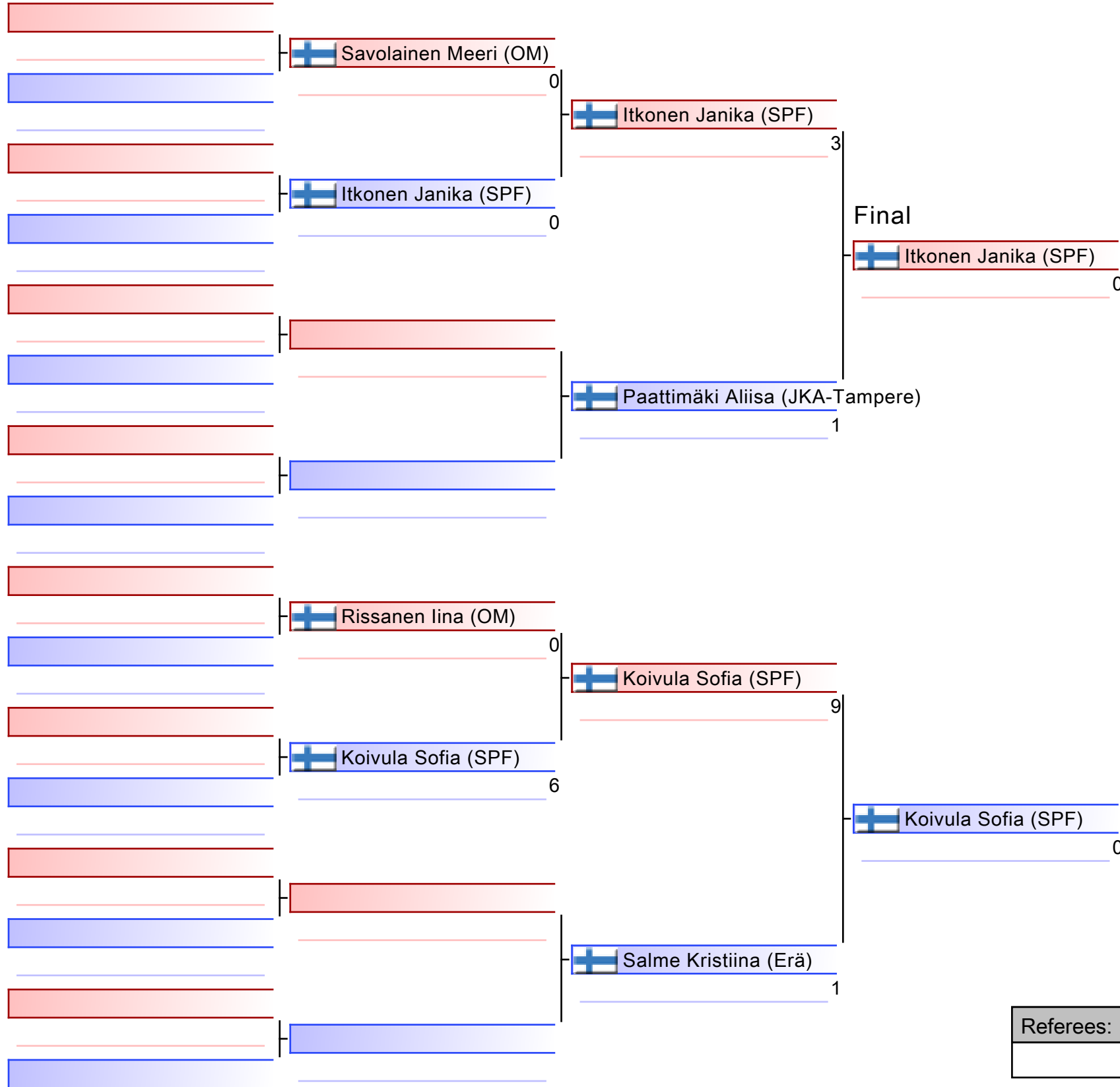

1. KOIVULA SOFIA (SPF)
2. ITKONEN JANIKA (SPF)
3. SALME KRISTIINA (ERÄ)
4. SAVOLAINEN MEERI (OM)
5. PAATTIMÄKI ALIISA (JKA-TAMPERE)
5. RISSANEN IINA (OM)

Referees:			

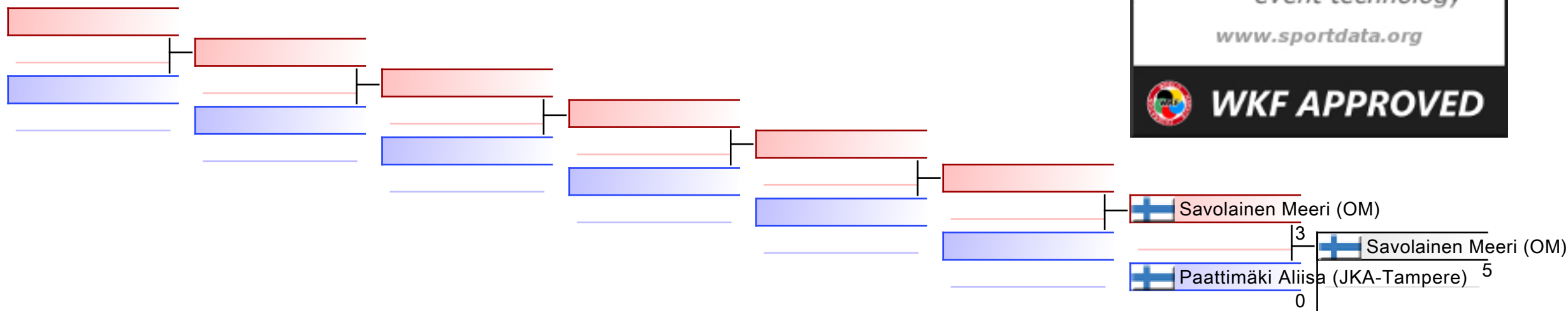



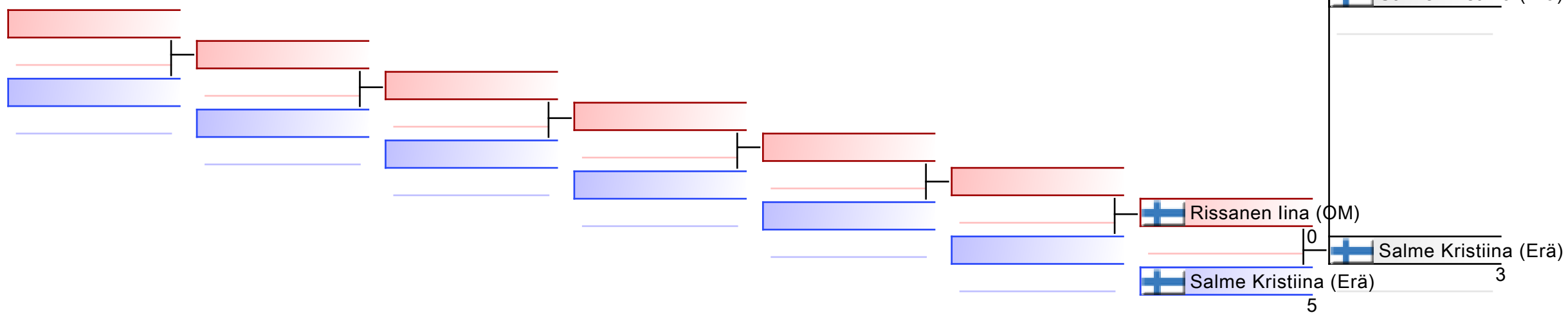



REPECHAGE: (1)



Referees:							
-----------	--	--	--	--	--	--	--

KARATEN SM KILPAILUT 2024 - 2024-04-06

Official Results

KUMITE, U18, TYTÖT -59KG yhdistetty				
1	KOIVULA SOFIA	SPORTSKARATE.FI		FIN - FINLAND
2	ITKONEN JANIKA	SPORTSKARATE.FI		FIN - FINLAND
3	SALME KRISTIINA	TAPANILAN ERÄ		FIN - FINLAND
4	SAVOLAINEN MEERI	SPORTSKARATE KUOPIO		FIN - FINLAND
5	PAATTIMÄKI ALIISA	JAPAN KARATE ASSOCIATION TAMPERE RY		FIN - FINLAND
5	RISSANEN IINA	SPORTSKARATE KUOPIO		FIN - FINLAND

KUMITE, U21, MIEHET, +67KG
YHDISTETTY

KARATEN SM KILPAILUT 2024
ENTRIES BY WEIGHT CATEGORY
KUMITE, U21, MIEHET, +67KG yhdistetty
As of 7 APR 2024

NOC Code	Gender	Name	Seeding
FIN	M	Banauliker Kartik-Otto	
FIN	M	Hänninen Aarni	
FIN	M	Keltto Matias	









KUMITE, U21, MIEHET, +67KG yhdistetty - Round Robin (each against each)

KARATEN SM KILPAILUT 2024, Asikkalantie 14, 17200 Vääksy, FIN

2024-04-06

Tatami
2 14:10

Pool
1/1



1	 Keltto Matias (LKJ)	4	 Keltto Matias (LKJ)
2	 Banauliker Kartik-Otto (Budokwai Karate)	3	
3	 Keltto Matias (LKJ)	3	 Hänninen Aarni (Renshi)
4	 Hänninen Aarni (Renshi)	3	
5	 Banauliker Kartik-Otto (Budokwai Karate)	1	 Hänninen Aarni (Renshi)
6	 Hänninen Aarni (Renshi)	6	



1. HÄNNINEN AARNI (RENSHI)
2. KELTTO MATIAS (LKJ)
3. BANAU LIKER KARTIK-OTTO (BUDOKWAI KARATE)

Referees:			

Official Results

KUMITE, U21, MIEHET, +67KG yhdistetty				
1	HÄNNINEN AARNI	RENSHIN-KAN RY		FIN - FINLAND
2	KELTTO MATIAS	LAKEUDEN KARATE- JUTSU RY		FIN - FINLAND
3	BANAULIKER KARTIK-OTTO	BUDOKWAI RY KARATE		FIN - FINLAND

KUMITE, U21, MIEHET, -67KG
YHDISTETTY

KARATEN SM KILPAILUT 2024
ENTRIES BY WEIGHT CATEGORY
KUMITE, U21, MIEHET, -67KG yhdistetty
As of 7 APR 2024

NOC Code	Gender	Name	Seeding
FIN	M	Lehtinen Jesse	
FIN	M	Rekola Tuomas	
FIN	M	Saario Leevi	

KUMITE, U21, MIEHET, -67KG yhdistetty - Round Robin (each against each)

KARATEN SM KILPAILUT 2024, Asikkalantie 14, 17200 Vääksy, FIN

2024-04-06

Tatami
2 13:55

Pool
1/1



1	Saario Leevi (LK-FIN)	0	Lehtinen Jesse (LK-FIN)
2	Lehtinen Jesse (LK-FIN)	1	
3	Saario Leevi (LK-FIN)	1	Saario Leevi (LK-FIN)
4	Rekola Tuomas (OM)	0	
5	Lehtinen Jesse (LK-FIN)	8	Lehtinen Jesse (LK-FIN)
6	Rekola Tuomas (OM)	0	



1. LEHTINEN JESSE (LK-FIN)
2. SAARIO LEEVI (LK-FIN)
3. REKOLA TUOMAS (OM)

Referees:			

Official Results

KUMITE, U21, MIEHET, -67KG yhdistetty				
1	LEHTINEN JESSE	LAHDEN KARATE		FIN - FINLAND
2	SAARIO LEEVI	LAHDEN KARATE		FIN - FINLAND
3	REKOLA TUOMAS	SPORTSKARATE KUOPIO		FIN - FINLAND

KUMITE, U21, NAISSET +55KG

KARATEN SM KILPAILUT 2024
ENTRIES BY WEIGHT CATEGORY
KUMITE, U21, NAISSET +55kg
As of 7 APR 2024

NOC Code	Gender	Name	Seeding
FIN	F	Koponen Kiia	
FIN	F	Rasoli Arezo	
FIN	F	Saadaoui Sonya	
FIN	F	SIITARINEN OLIVIA	



















KUMITE, U21, NAISSET +55kg - Round Robin (each against each)

KARATEN SM KILPAILUT 2024, Asikkalantie 14, 17200 Vääksy, FIN

2024-04-06

Tatami
1 17:10

Pool
1/1





1	 SIITARINEN OLIVIA (Renshi)	5	 SIITARINEN OLIVIA (Renshi)
2	 Koponen Kiia (LK-FIN)	4	
3	 Saadaoui Sonya (SPF)	6	 Saadaoui Sonya (SPF)
4	 Rasoli Arezo (Shuyokai)	0	
5	 SIITARINEN OLIVIA (Renshi)	0	 Saadaoui Sonya (SPF)
6	 Saadaoui Sonya (SPF)	2	
7	 Rasoli Arezo (Shuyokai)	0	 Koponen Kiia (LK-FIN)
8	 Koponen Kiia (LK-FIN)	10	
9	 SIITARINEN OLIVIA (Renshi)	5	 SIITARINEN OLIVIA (Renshi)
10	 Rasoli Arezo (Shuyokai)	2	
11	 Koponen Kiia (LK-FIN)	2	 Koponen Kiia (LK-FIN)
12	 Saadaoui Sonya (SPF)	1	



1. KOPONEN KIIA (LK-FIN)
2. SIITARINEN OLIVIA (RENSHI)
3. SAADAOUI SONYA (SPF)
4. RASOLI AREZO (SHUYOKAI)

Referees:			

Official Results

KUMITE, U21, NAISET +55kg				
1	KOPONEN KIIA	LAHDEN KARATE		FIN - FINLAND
2	SIITARINEN OLIVIA	RENSHIN-KAN RY		FIN - FINLAND
3	SAADAQUI SONYA	SPORTSKARATE.FI		FIN - FINLAND
4	RASOLI AREZO	SHUYOKAI SHOTOKAN KARATE- DO		FIN - FINLAND

KUMITE, U21, NAISSET, -55KG

KARATEN SM KILPAILUT 2024
ENTRIES BY WEIGHT CATEGORY
KUMITE, U21, NAISET, -55KG
As of 7 APR 2024

NOC Code	Gender	Name	Seeding
FIN	F	Nikander Saimi	
FIN	F	Rasoli Fatima	
FIN	F	Salme Kristiina	
FIN	F	Savolainen Meeri	



















KUMITE, U21, NAISET, -55KG - Round Robin (each against each)

KARATEN SM KILPAILUT 2024, Asikkalantie 14, 17200 Vääksy, FIN

2024-04-06

Tatami
1 16:45

Pool
1/1





1	 Rasoli Fatima (Shuyokai)	0	 Nikander Saimi (SPF)
2	 Nikander Saimi (SPF)	4	
3	 Savolainen Meeri (OM)	6	 Savolainen Meeri (OM)
4	 Salme Kristiina (Erä)	0	
5	 Rasoli Fatima (Shuyokai)	5	 Savolainen Meeri (OM)
6	 Savolainen Meeri (OM)	5	
7	 Salme Kristiina (Erä)	0	 Nikander Saimi (SPF)
8	 Nikander Saimi (SPF)	8	
9	 Rasoli Fatima (Shuyokai)	0	 Salme Kristiina (Erä)
10	 Salme Kristiina (Erä)	0	
11	 Nikander Saimi (SPF)	5	 Nikander Saimi (SPF)
12	 Savolainen Meeri (OM)	1	



1. NIKANDER SAIMI (SPF)
2. SAVOLAINEN MEERI (OM)
3. SALME KRISTIINA (ERÄ)
4. RASOLI FATIMA (SHUYOKAI)

Referees:			

Official Results

KUMITE, U21, NAISET, -55KG				
1	NIKANDER SAIMI	SPORTSKARATE.FI		FIN - FINLAND
2	SAVOLAINEN MEERI	SPORTSKARATE KUOPIO		FIN - FINLAND
3	SALME KRISTIINA	TAPANILAN ERÄ		FIN - FINLAND
4	RASOLI FATIMA	SHUYOKAI SHOTOKAN KARATE- DO		FIN - FINLAND

KATA, U14, POJAT

KARATEN SM KILPAILUT 2024
ENTRIES BY WEIGHT CATEGORY
Kata, U14, pojat
As of 7 APR 2024

NOC Code	Gender	Name	Seeding
FIN	M	Hannu Eero	
FIN	M	Kella Kasper	
FIN	M	Kivikoski Jere	
FIN	M	Lähetkangas Luka	
FIN	M	Takala Anton	

Kata, U14, pojat

KARATEN SM KILPAILUT 2024, Asikkalantie 14, 17200 Vääksy, FIN

2024-04-06

Tatami
1 10:00

Pool
1/1

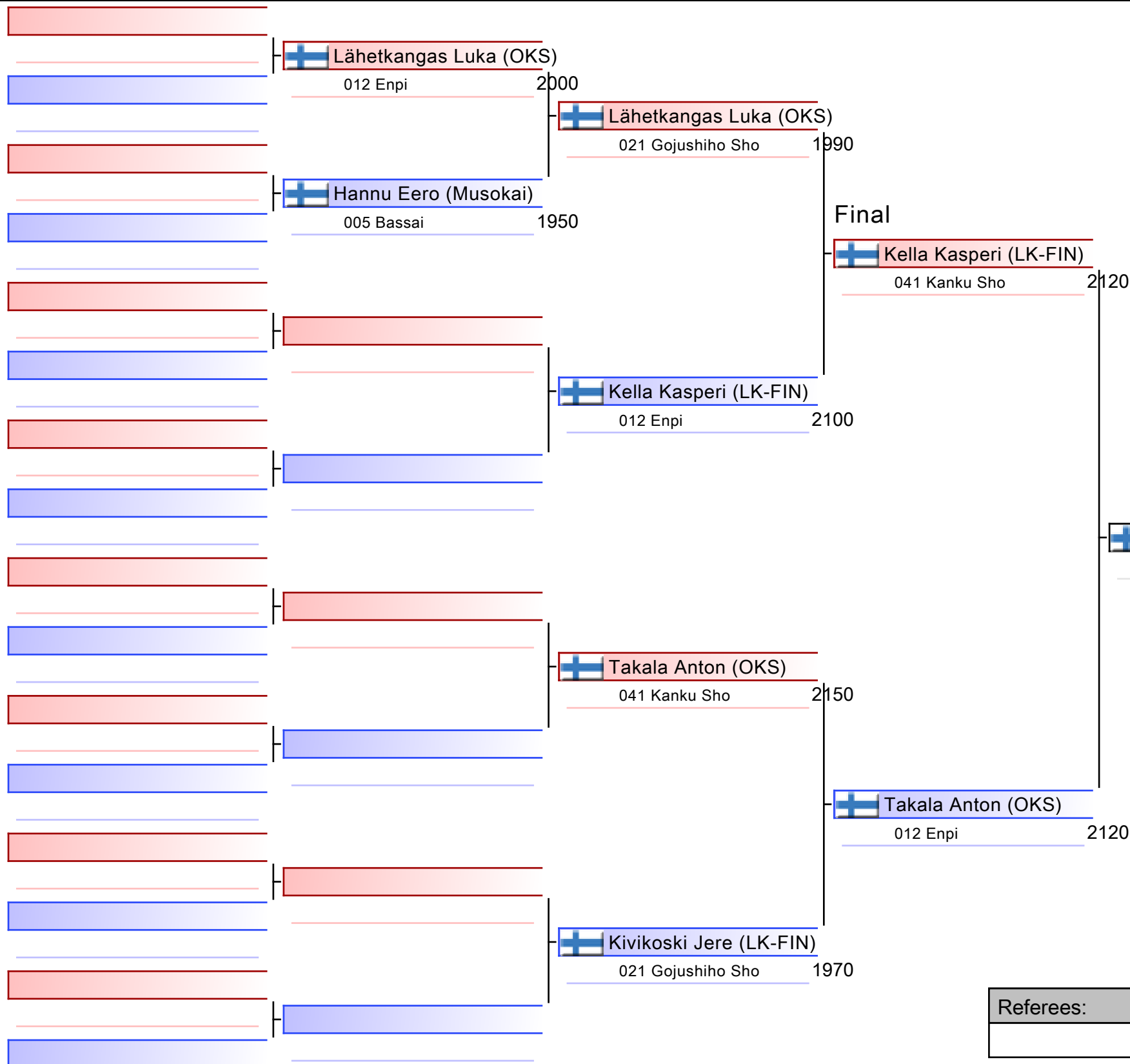

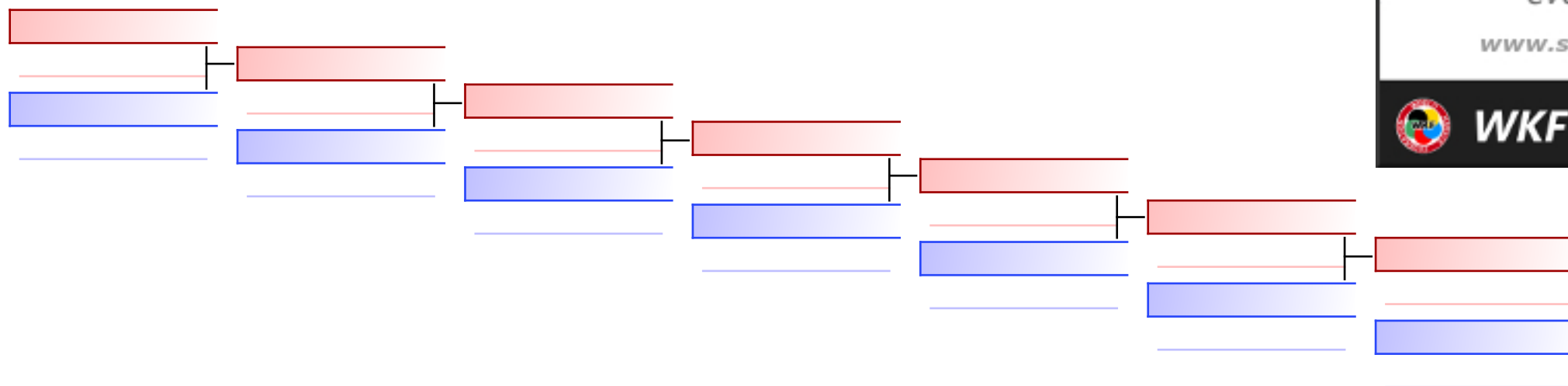

1. KELLA KASPERI (LK-FIN)
2. TAKALA ANTON (OKS)
3. LÄHETKANGAS LUKA (OKS)
4. KIVIKOSKI JERE (LK-FIN)

Referees:			

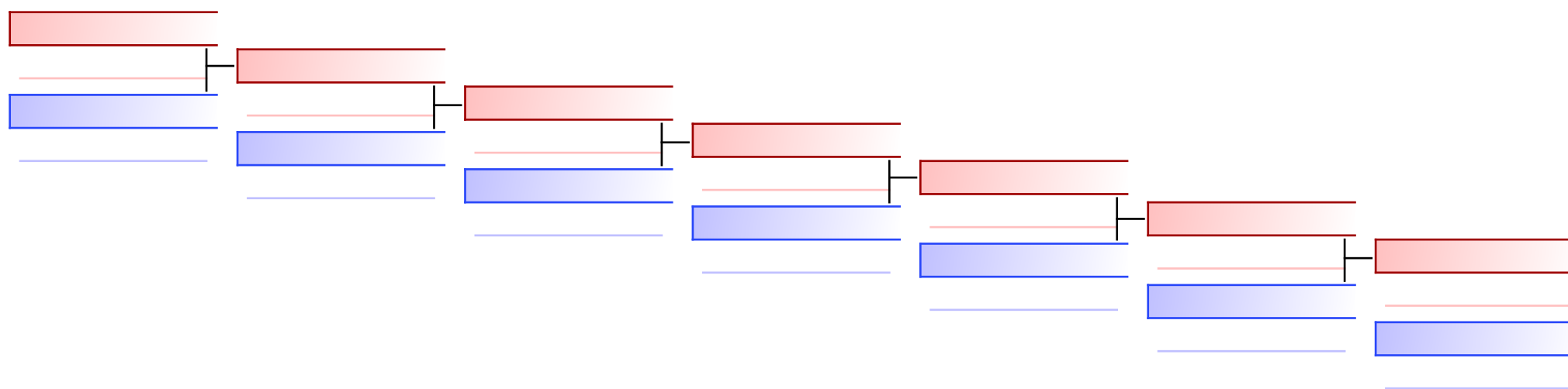

REPECHAGE: (1)







 Lähetkangas Luka (OKS)
 041 Kanku Sho 2010

 Lähetkangas Luka (OKS)

 Kivikoski Jere (LK-FIN)
 012 Enpi 1940

Referees:							
-----------	--	--	--	--	--	--	--

Official Results

Kata, U14, pojat				
1	KELLA KASPERI	LAHDEN KARATE		FIN - FINLAND
2	TAKALA ANTON	OULUN KARATESEURA		FIN - FINLAND
3	LÄHETKANGAS LUKA	OULUN KARATESEURA		FIN - FINLAND
4	KIVIKOSKI JERE	LAHDEN KARATE		FIN - FINLAND

KATA, U14, TYTÖT

KARATEN SM KILPAILUT 2024
ENTRIES BY WEIGHT CATEGORY
Kata, U14, tytöt
As of 7 APR 2024

NOC Code	Gender	Name	Seeding
FIN	F	Alatalo Vanamo	
FIN	F	Antinkaapo Nea	
FIN	F	Haven Sara	
FIN	F	Heino Daisy	
FIN	F	Kinnunen Anni	
FIN	F	Korpela Siiri	
FIN	F	Lindström Meri	
FIN	F	Ollikainen Saara	
FIN	F	Ortiz Antonia	
FIN	F	Stefanski Vanessa	
FIN	F	Vuorinen Alma	
FIN	F	Vuorinen Elin	
FIN	F	Wanic Marie	

Kata, U14, tytöt

KARATEN SM KILPAILUT 2024, Asikkalantie 14, 17200 Vääksy, FIN

2024-04-06

Tatami
3 10:55

Pool
1/1

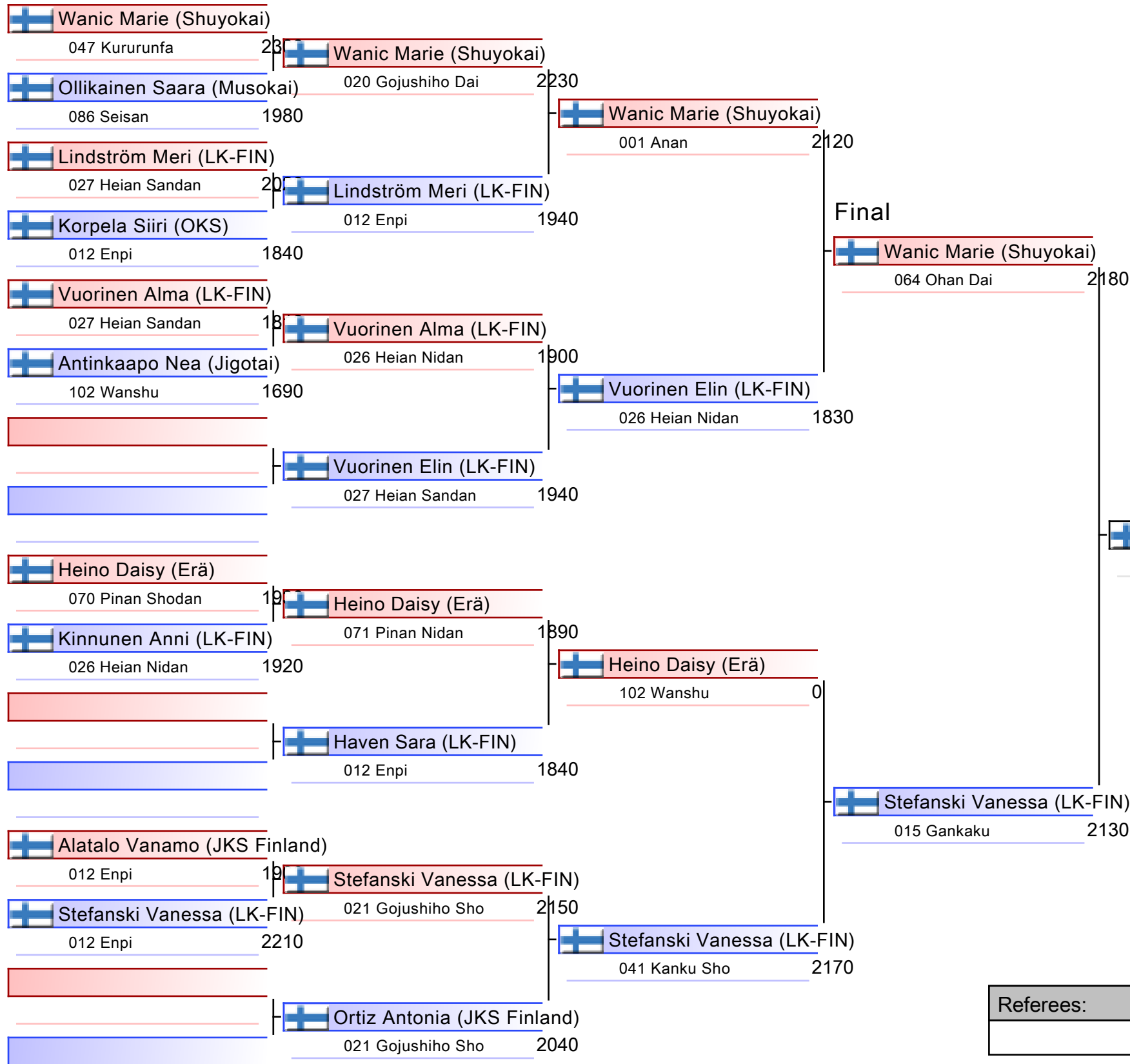

- | |
|---------------------------------|
| 1. WANIC MARIE (SHUYOKAI) |
| 2. STEFANSKI VANESSA (LK-FIN) |
| 3. ORTIZ ANTONIA (JKS FINLAND) |
| 4. OLLIKAINEN SAARA (MUSOKAI) |
| 5. VUORINEN ELIN (LK-FIN) |
| 5. HEINO DAISY (ERÄ) |
| 7. LINDSTRÖM MERI (LK-FIN) |
| 7. ALATALO VANAMO (JKS FINLAND) |

Referees:			

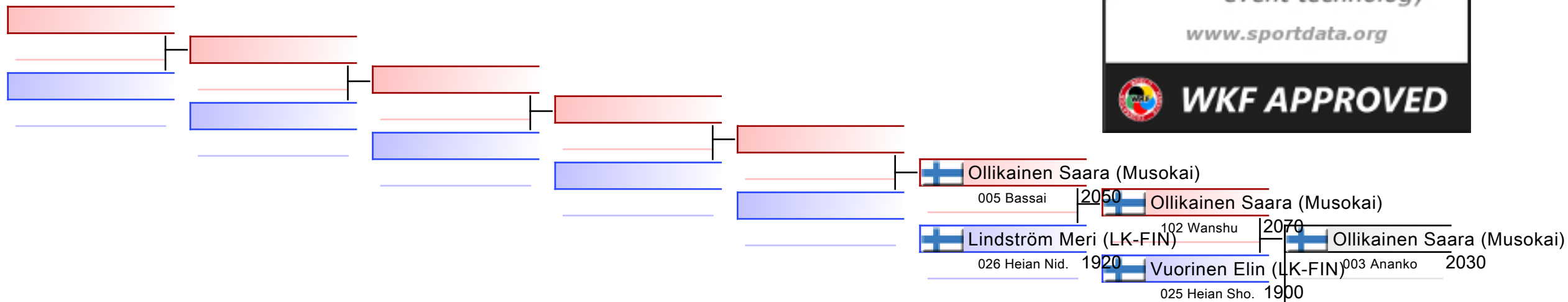

REPECHAGE: (1)

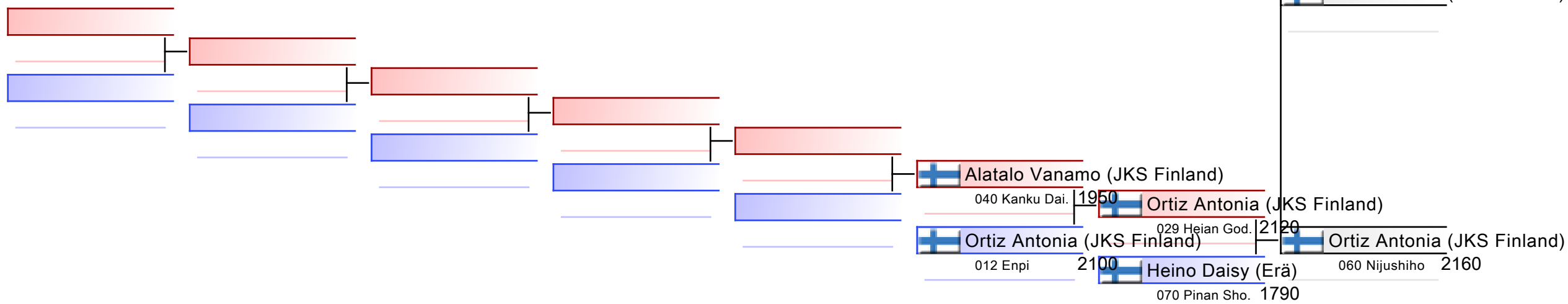

Referees:							
-----------	--	--	--	--	--	--	--

Official Results

Kata, U14, tytöt				
1	WANIC MARIE	SHUYOKAI SHOTOKAN KARATE- DO		FIN - FINLAND
2	STEFANSKI VANESSA	LAHDEN KARATE		FIN - FINLAND
3	ORTIZ ANTONIA	JKS FINLAND - SHOTOKAN KARATE HELSINKI		FIN - FINLAND
4	OLLIKAINEN SAARA	BUDOSEURA OULUN MUSOKAI RY		FIN - FINLAND
5	VUORINEN ELIN	LAHDEN KARATE		FIN - FINLAND
5	HEINO DAISY	TAPANILAN ERÄ		FIN - FINLAND
7	LINDSTRÖM MERI	LAHDEN KARATE		FIN - FINLAND
7	ALATALO VANAMO	JKS FINLAND - SHOTOKAN KARATE HELSINKI		FIN - FINLAND

KATA MIEHET +40V

KARATEN SM KILPAILUT 2024
ENTRIES BY WEIGHT CATEGORY
Kata miehet +40v
As of 7 APR 2024

NOC Code	Gender	Name	Seeding
FIN	M	Casci Giangabriele	
FIN	M	Härkönen Jarno	
FIN	M	Tuominen Vesa	

Kata miehet +40v

KARATEN SM KILPAILUT 2024, Asikkalantie 14, 17200 Vääksy, FIN

2024-04-06

Tatami

2 11:35

Pool

1/1

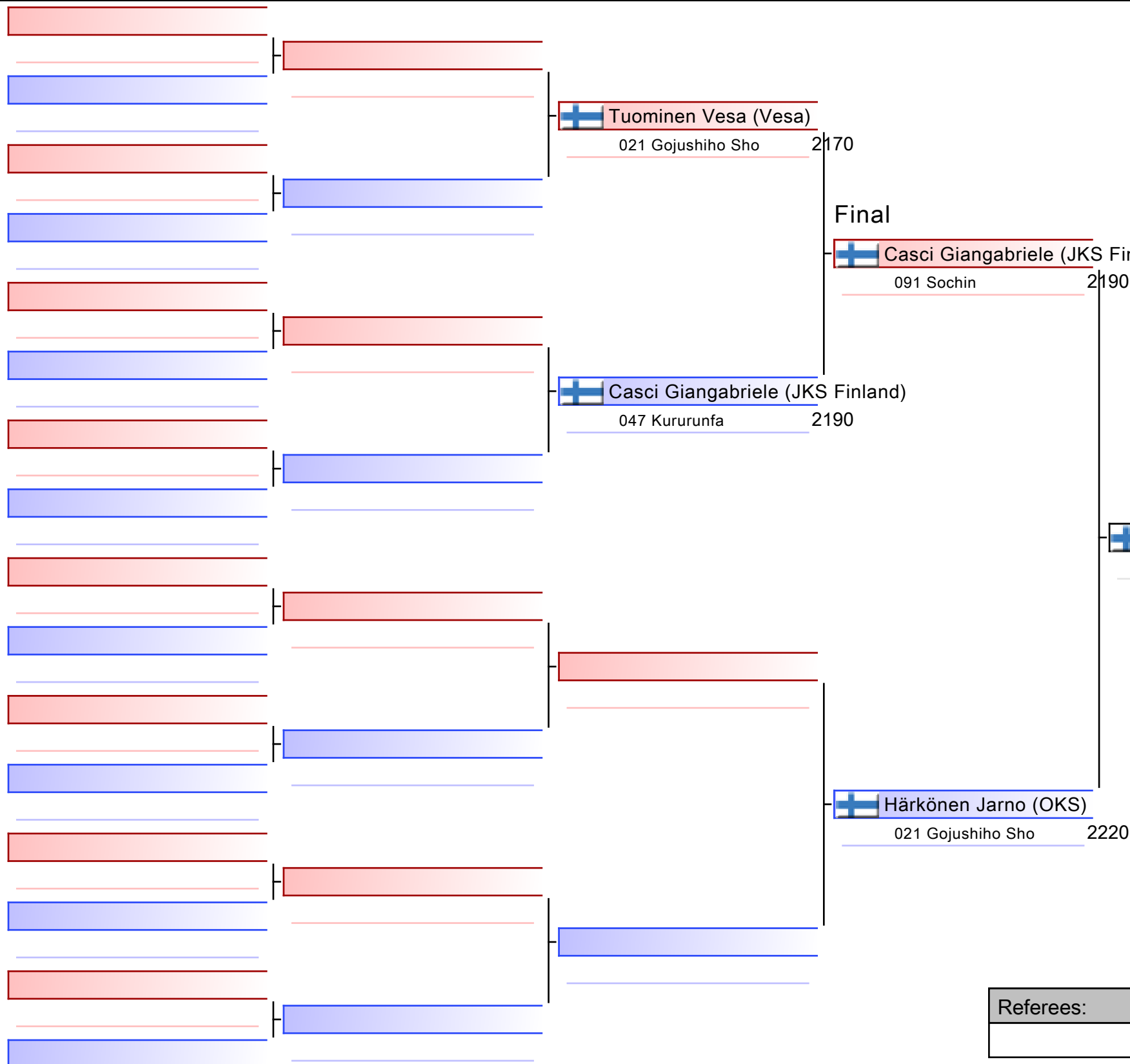

1. HÄRKÖNEN JARNO (OKS)
2. CASCI GIANGABRIELE (JKS FINLAND)
3. TUOMINEN VESA (VESA)

Referees:			

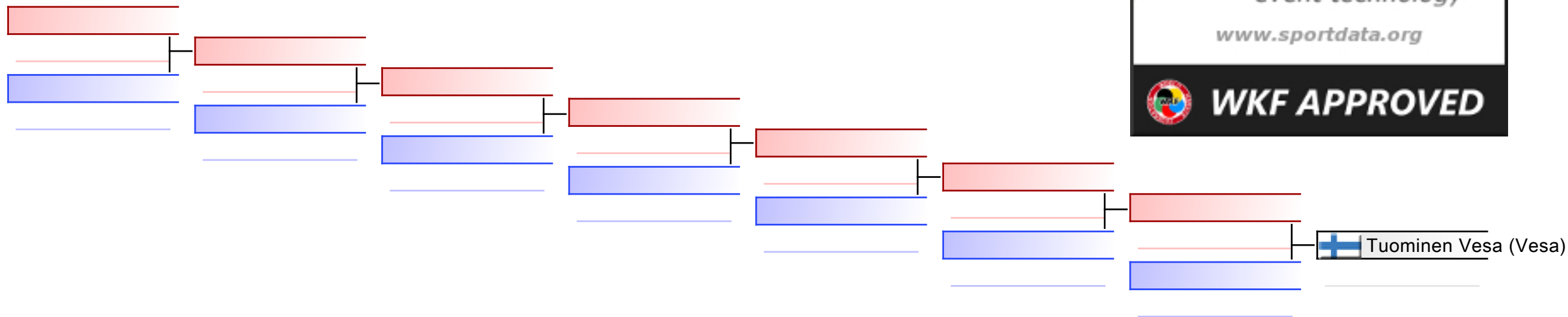

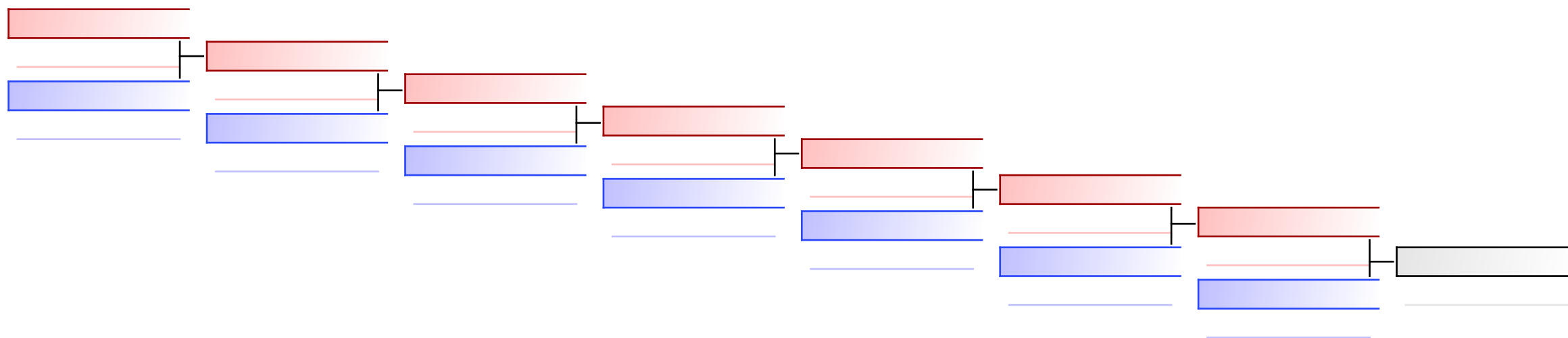

REPECHAGE: (1)



Referees:							
-----------	--	--	--	--	--	--	--

Official Results

Kata miehet +40v				
1	HÄRKÖNEN JARNO	OUTOKUMMUN KARATESEURA RY		FIN - FINLAND
2	CASCI GIANGABRIELE	JKS FINLAND - SHOTOKAN KARATE HELSINKI		FIN - FINLAND
3	TUOMINEN VESA	HYVINKÄÄN SHOTOKAN KARATE RY		FIN - FINLAND

KATA SOVELLETTU

KARATEN SM KILPAILUT 2024
ENTRIES BY WEIGHT CATEGORY
Kata sovellettu
As of 7 APR 2024

NOC Code	Gender	Name	Seeding
FIN	M	Lehtinen Tuomas	
FIN	M	Mäenpää Jaakko	

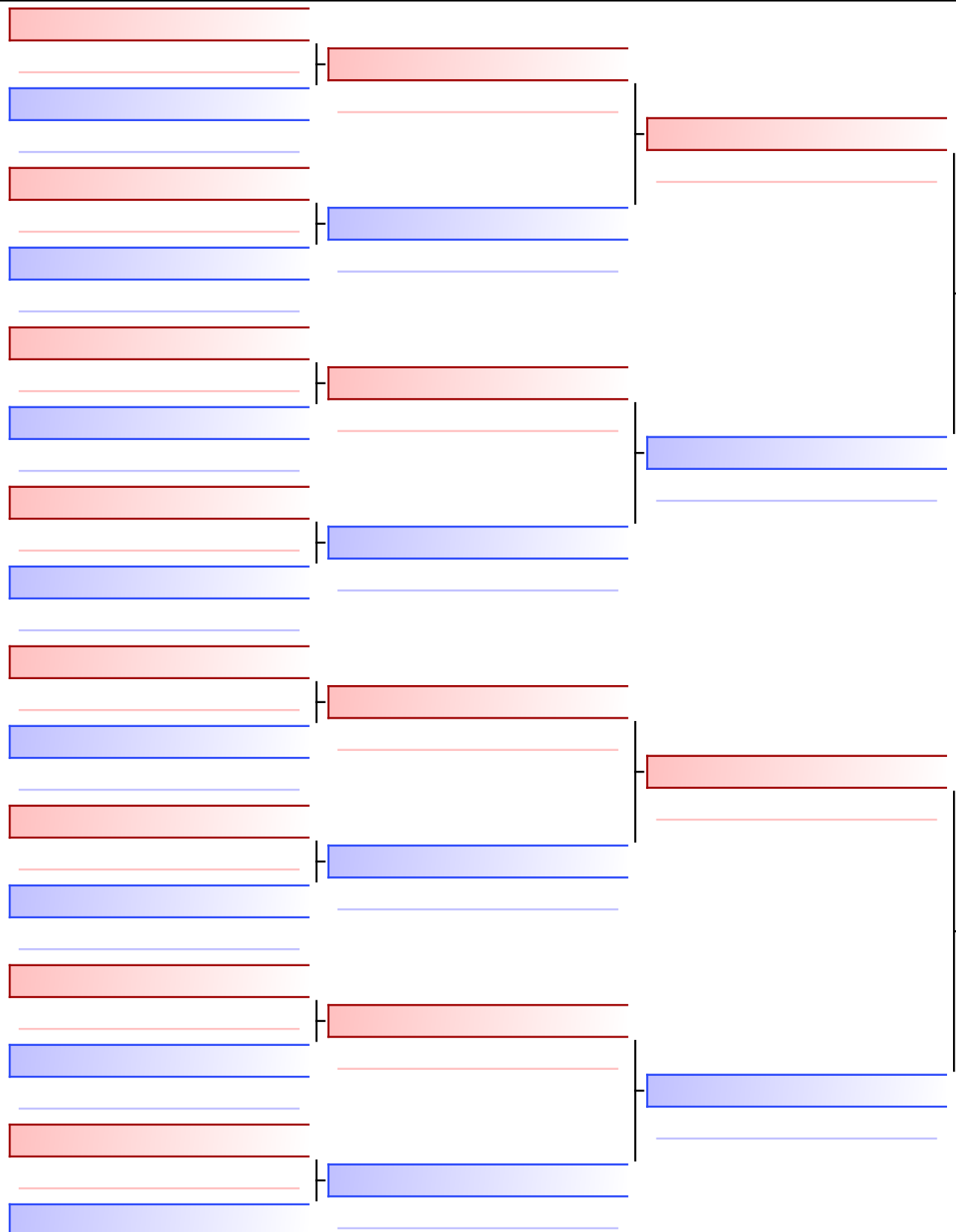

Final

 Mäenpää Jaakko (LK-FIN)
2150

 Mäenpää Jaakko (LK-FIN)

 Lehtinen Tuomas (LK-FIN)
2090





1. MÄENPÄÄ JAAKKO (LK-FIN)
2. LEHTINEN TUOMAS (LK-FIN)

Referees:			

KARATEN SM KILPAILUT 2024 - 2024-04-06

Official Results

Kata sovellettu				
1	MÄENPÄÄ JAAKKO	LAHDEN KARATE		FIN - FINLAND
2	LEHTINEN TUOMAS	LAHDEN KARATE		FIN - FINLAND

KUMITE, MIEHET, -67KG
YHDISTETTY

KARATEN SM KILPAILUT 2024
ENTRIES BY WEIGHT CATEGORY
Kumite, miehet, -67kg yhdistetty
As of 7 APR 2024

NOC Code	Gender	Name	Seeding
FIN	M	Lehtinen Jesse	
FIN	M	Saario Leevi	

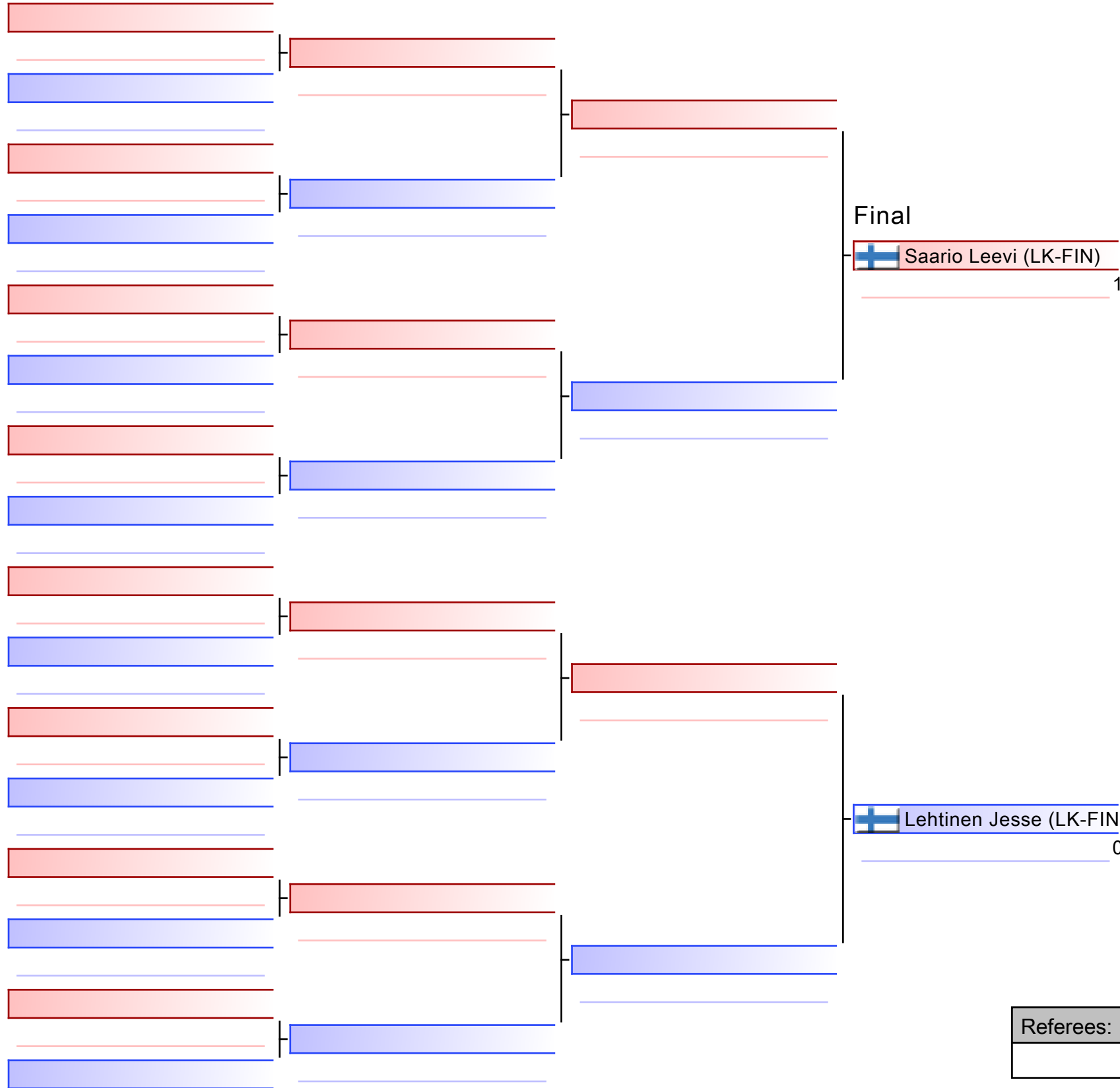



Saario Leevi (LK-FIN)

1. SAARIO LEEVI (LK-FIN)
2. LEHTINEN JESSE (LK-FIN)

Referees:			

KARATEN SM KILPAILUT 2024 - 2024-04-06

Official Results

Kumite, miehet, -67kg yhdistetty				
1	SAARIO LEEVI	LAHDEN KARATE		FIN - FINLAND
2	LEHTINEN JESSE	LAHDEN KARATE		FIN - FINLAND

KUMITE MIEHET 35-50V +75KG

KARATEN SM KILPAILUT 2024
ENTRIES BY WEIGHT CATEGORY
Kumite miehet 35-50v +75kg
As of 7 APR 2024

NOC Code	Gender	Name	Seeding
FIN	M	Härkönen Jarno	
FIN	M	Rasila Petri	

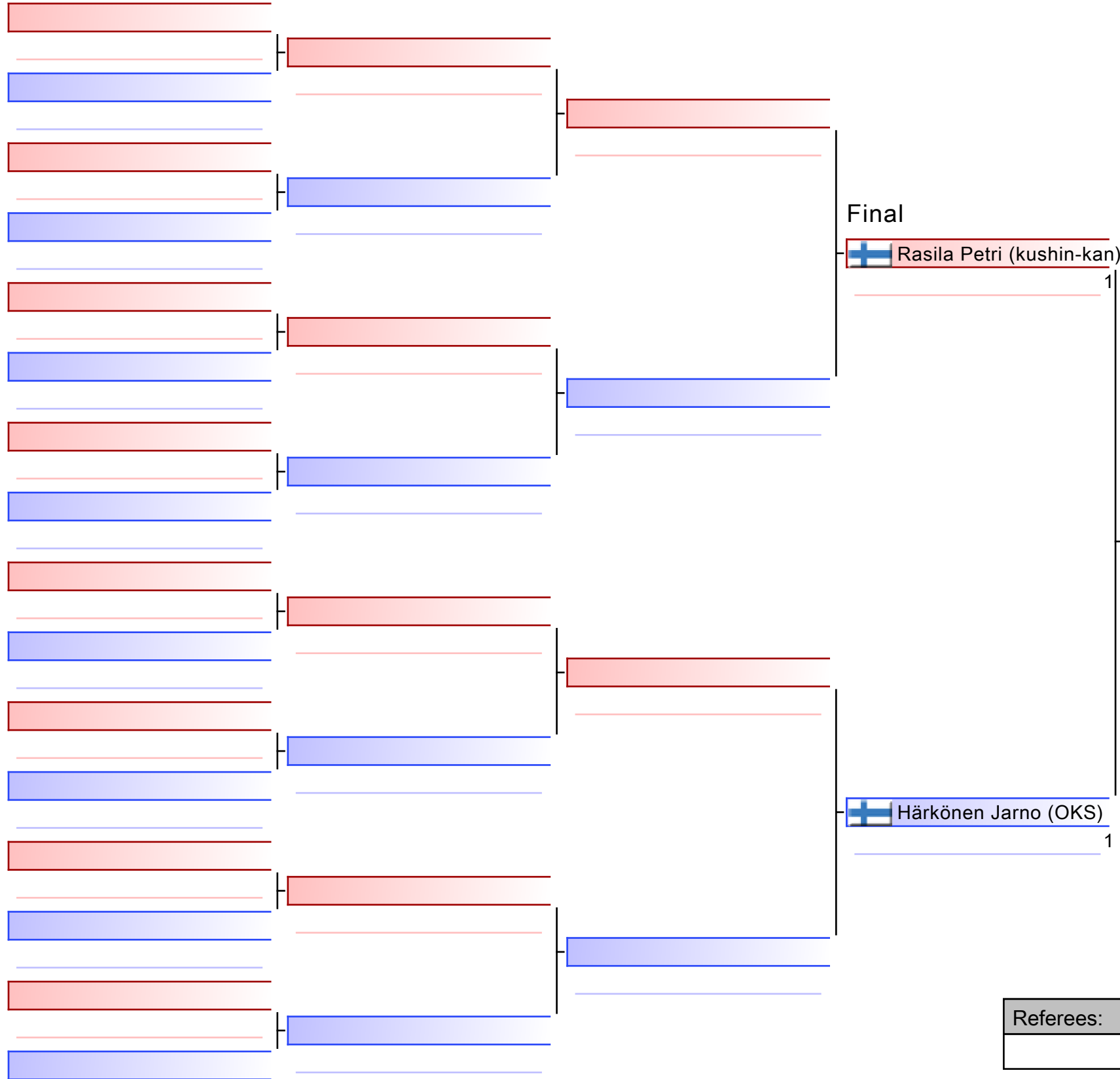



Härkönen Jarno (OKS)

1. HÄRKÖNEN JARNO (OKS)
2. RASILA PETRI (KUSHIN-KAN)

Referees:			

Official Results

Kumite miehet 35-50v +75kg				
1	HÄRKÖNEN JARNO	OUTOKUMMUN KARATESEURA RY		FIN - FINLAND
2	RASILA PETRI	KUSHIN-KAN		FIN - FINLAND

U12 POJAT KATA

KARATEN SM KILPAILUT 2024
ENTRIES BY WEIGHT CATEGORY
U12 pojat kata
As of 7 APR 2024

NOC Code	Gender	Name	Seeding
FIN	M	Bonden Matias	
FIN	M	Hannu Aarre	
FIN	M	Larkin Takehiro	
FIN	M	Lehto Eemeli	
FIN	M	Säippä Emil	
FIN	M	Tejesvi Shashank	
FIN	M	Wanic Mark	

U12 pojat kata

KARATEN SM KILPAILUT 2024, Asikkalantie 14, 17200 Vääksy, FIN

2024-04-06

Tatami
3 10:25

Pool
1/1

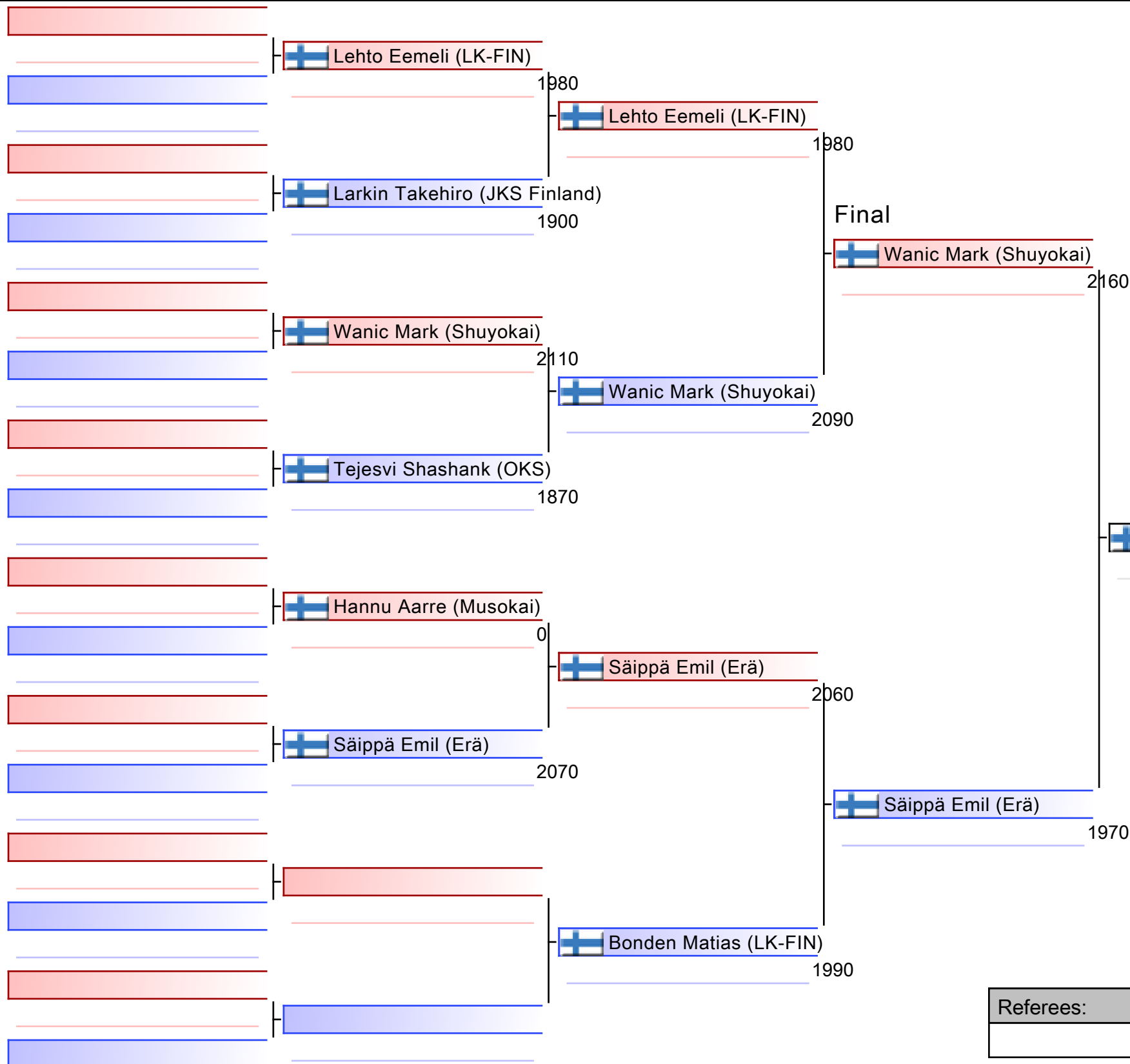

1. WANIC MARK (SHUYOKAI)
2. SÄIPPÄ EMIL (ERÄ)
3. BONDEN MATIAS (LK-FIN)
4. LEHTO EEMELI (LK-FIN)
5. TEJESVI SHASHANK (OKS)
5. HANNU AARRE (MUSOKAI)

Referees:			

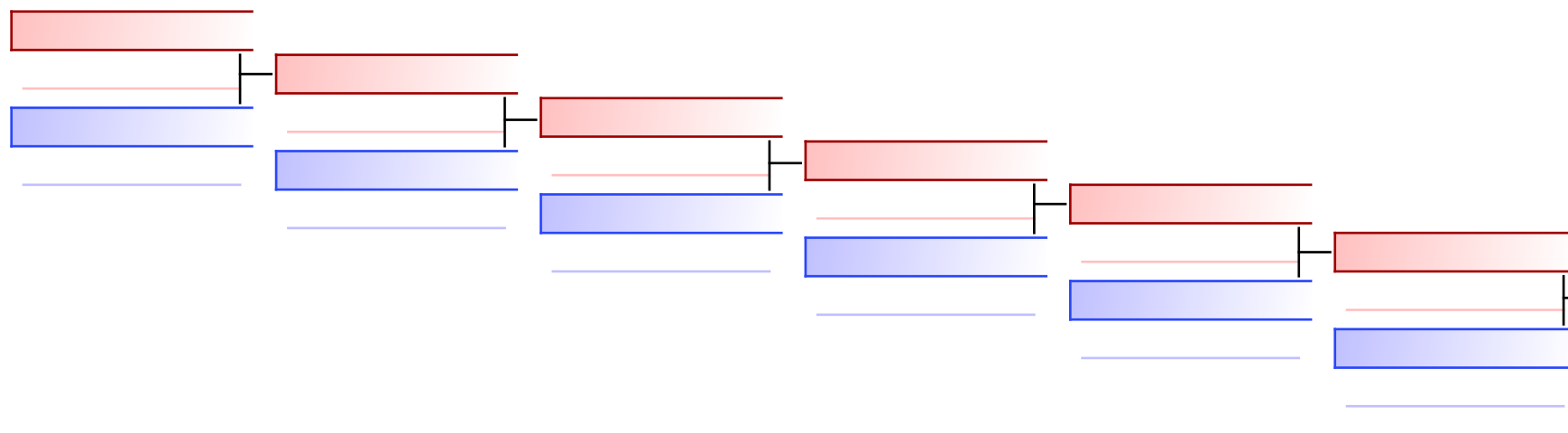

Tejesvi Shashank (OKS)
 Lehto Eemeli (LK-FIN) 1880
 Lehto Eemeli (LK-FIN) 1970
 Lehto Eemeli (LK-FIN) 2030

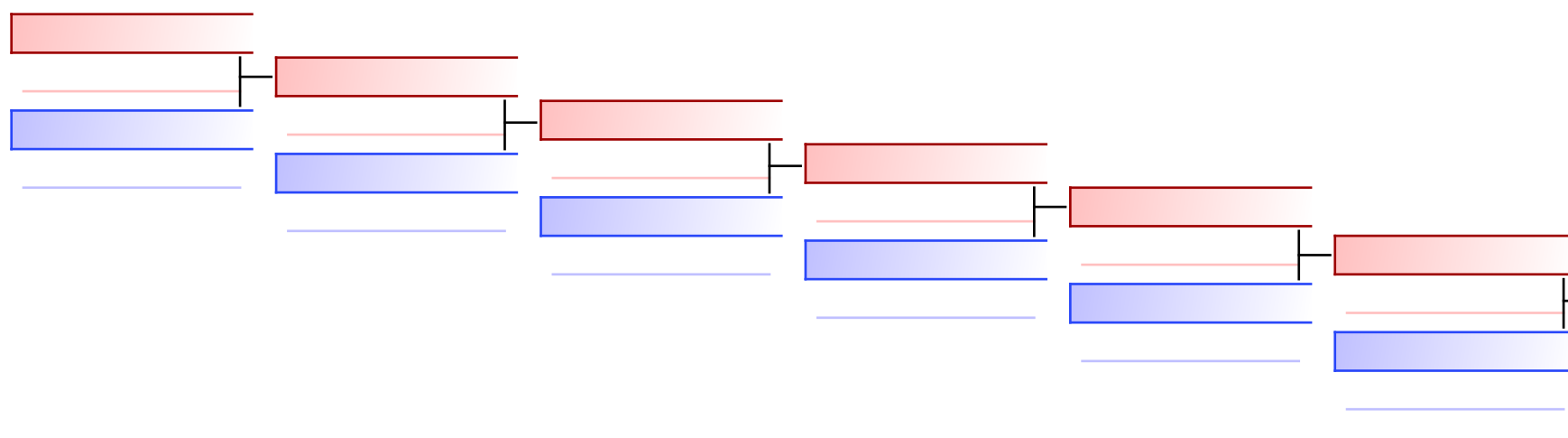

REPECHAGE: (1)



Bonden Matias (LK-FIN)
 Hannu Aarre (Musokai) 2020
 Bonden Matias (LK-FIN) 2220
 Bonden Matias (LK-FIN) 2230

Referees:							
-----------	--	--	--	--	--	--	--

Official Results

U12 pojat kata					
1	WANIC MARK	SHUYOKAI SHOTOKAN KARATE- DO		FIN - FINLAND	
2	SAIPPA EMIL	TAPANILAN ERA		FIN - FINLAND	
3	BONDEN MATIAS	LAHDEN KARATE		FIN - FINLAND	
4	LEHTO EEMELI	LAHDEN KARATE		FIN - FINLAND	
5	TEJESVI SHASHANK	OULUN KARATESEURA		FIN - FINLAND	
5	HANNU AARRE	BUDOSEURA OULUN MUSOKAI RY		FIN - FINLAND	

U12 POJAT KUMITE +42KG

KARATEN SM KILPAILUT 2024
ENTRIES BY WEIGHT CATEGORY
U12 pojat kumite +42kg
As of 7 APR 2024

NOC Code	Gender	Name	Seeding
FIN	M	Heikkilä Eliel	
FIN	M	Kullberg Adam	
FIN	M	Lehto Eemeli	
FIN	M	Tameh Abdulkarim	



U12 pojat kumite +42kg - Round Robin (each against each)

KARATEN SM KILPAILUT 2024, Asikkalantie 14, 17200 Vääksy, FIN

2024-04-06

Tatami
3 13:45

Pool
1/1



1	 Kullberg Adam (Imatran Kusanku)	1	 Heikkilä Eliel (Budokwai Karate)
2	 Heikkilä Eliel (Budokwai Karate)	2	
3	 Lehto Eemeli (LK-FIN)	0	 Tameh Abdulkarim (OM)
4	 Tameh Abdulkarim (OM)	8	
5	 Kullberg Adam (Imatran Kusanku)	8	 Kullberg Adam (Imatran Kusanku)
6	 Lehto Eemeli (LK-FIN)	0	
7	 Tameh Abdulkarim (OM)	4	 Tameh Abdulkarim (OM)
8	 Heikkilä Eliel (Budokwai Karate)	0	
9	 Kullberg Adam (Imatran Kusanku)	1	 Tameh Abdulkarim (OM)
10	 Tameh Abdulkarim (OM)	2	
11	 Heikkilä Eliel (Budokwai Karate)	8	 Heikkilä Eliel (Budokwai Karate)
12	 Lehto Eemeli (LK-FIN)	0	



1. TAMEH ABDULKARIM (OM)
2. HEIKKILÄ ELIEL (BUDOKWAI KARATE)
3. KULLBERG ADAM (IMATRAN KUSANKU)

Referees:			

Official Results

U12 pojat kumite +42kg				
1	TAMEH ABDULKARIM	SPORTSKARATE KUOPIO		FIN - FINLAND
2	HEIKKILÄ ELIEL	BUDOKWAI RY KARATE		FIN - FINLAND
3	KULLBERG ADAM	BUDOSEURA IMATRAN KUSANKU RY		FIN - FINLAND

U12 POJAT KUMITE -35KG

KARATEN SM KILPAILUT 2024
ENTRIES BY WEIGHT CATEGORY
U12 pojat kumite -35kg
As of 7 APR 2024

NOC Code	Gender	Name	Seeding
FIN	M	Hannu Aarre	
FIN	M	Kivistö Hugo	
FIN	M	Ralli Alexi	
FIN	M	Tejesvi Shashank	

U12 pojat kumite -35kg - Round Robin (each against each)

KARATEN SM KILPAILUT 2024, Asikkalantie 14, 17200 Vääksy, FIN



















2024-04-06

Tatami

3 13:00

Pool

1/1





1	 Tejesvi Shashank (OKS)	2	 Ralli Alexi (Imatran Kusanku)
2	 Ralli Alexi (Imatran Kusanku)	4	
3	 Hannu Aarre (Musokai)	1	 Kivistö Hugo (HKS)
4	 Kivistö Hugo (HKS)	2	
5	 Tejesvi Shashank (OKS)	4	 Hannu Aarre (Musokai)
6	 Hannu Aarre (Musokai)	10	
7	 Kivistö Hugo (HKS)	2	 Kivistö Hugo (HKS)
8	 Ralli Alexi (Imatran Kusanku)	0	
9	 Tejesvi Shashank (OKS)	2	 Kivistö Hugo (HKS)
10	 Kivistö Hugo (HKS)	0	
11	 Ralli Alexi (Imatran Kusanku)	3	 Hannu Aarre (Musokai)
12	 Hannu Aarre (Musokai)	4	



1. KIVISTÖ HUGO (HKS)
2. HANNU AARRE (MUSOKAI)
3. RALLI ALEXI (IMATRAN KUSANKU)
4. TEJESVI SHASHANK (OKS)

Referees:			

Official Results

U12 pojat kumite -35kg				
1	KIVISTÖ HUGO	HÄMEENLINNAN KARATESEURA		FIN - FINLAND
2	HANNU AARRE	BUDOSEURA OULUN MUSOKAI RY		FIN - FINLAND
3	RALLI ALEXI	BUDOSEURA IMATRAN KUSANKU RY		FIN - FINLAND
4	TEJESVI SHASHANK	OULUN KARATESEURA		FIN - FINLAND

U12 POJAT KUMITE -42KG

KARATEN SM KILPAILUT 2024
ENTRIES BY WEIGHT CATEGORY
U12 pojat kumite -42kg
As of 7 APR 2024

NOC Code	Gender	Name	Seeding
FIN	M	Anttila Paolo	
FIN	M	Bonden Matias	
FIN	M	Larkin Takehiro	
FIN	M	Lilja Dani	
FIN	M	Luukka Erkkö	
FIN	M	Mahmood Zohaib	
FIN	M	Säippä Emil	

U12 pojat kumite -42kg

KARATEN SM KILPAILUT 2024, Asikkalantie 14, 17200 Vääksy, FIN

2024-04-06

Tatami
3 13:20

Pool
1/1

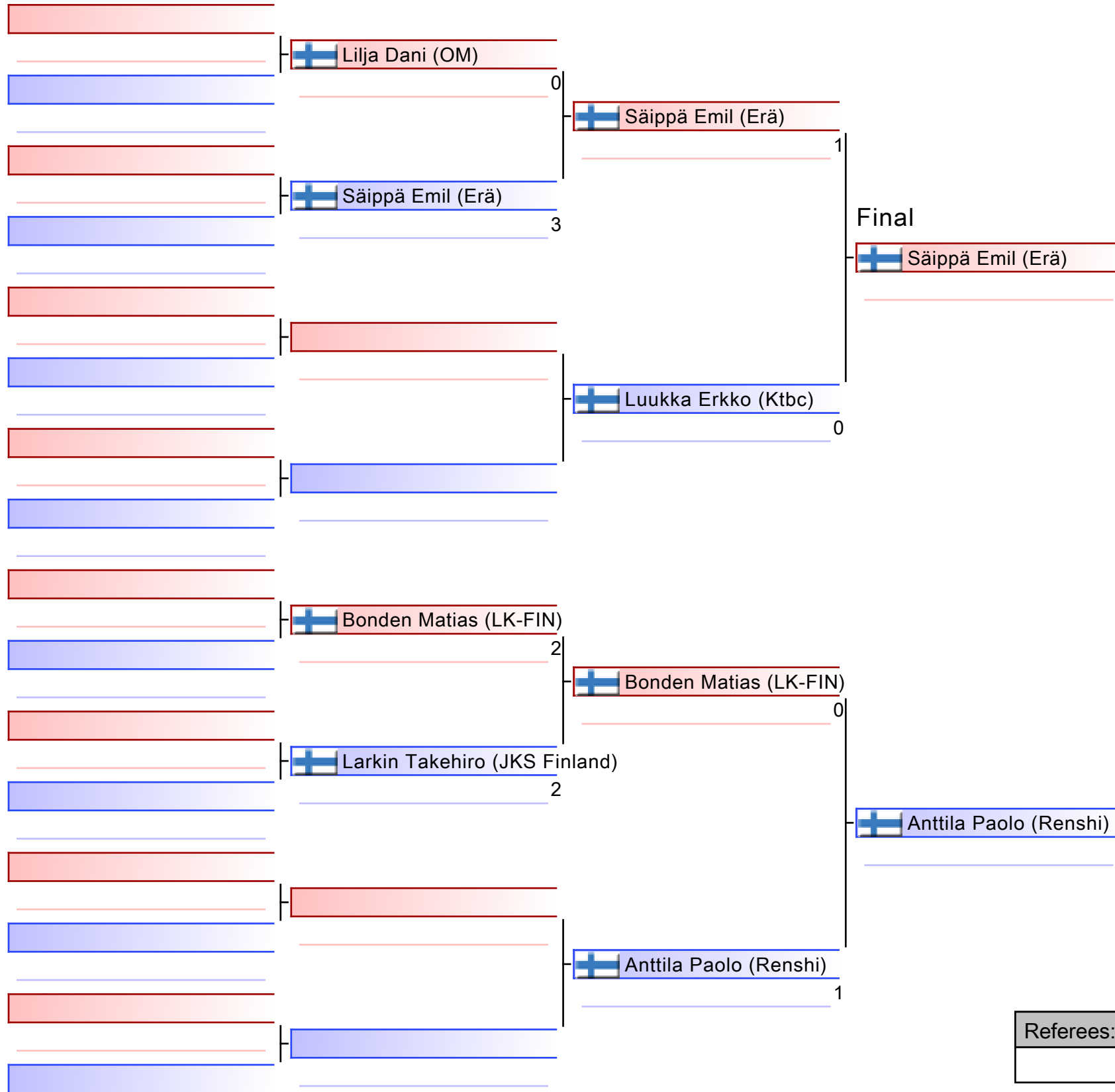

1. SÄIPPÄ EMIL (ERÄ)
2. ANTTILA PAOLO (RENSHI)
3. BONDEN MATIAS (LK-FIN)
4. LILJA DANI (OM)
5. LUUKKA ERKKO (KTBC)

Referees:			

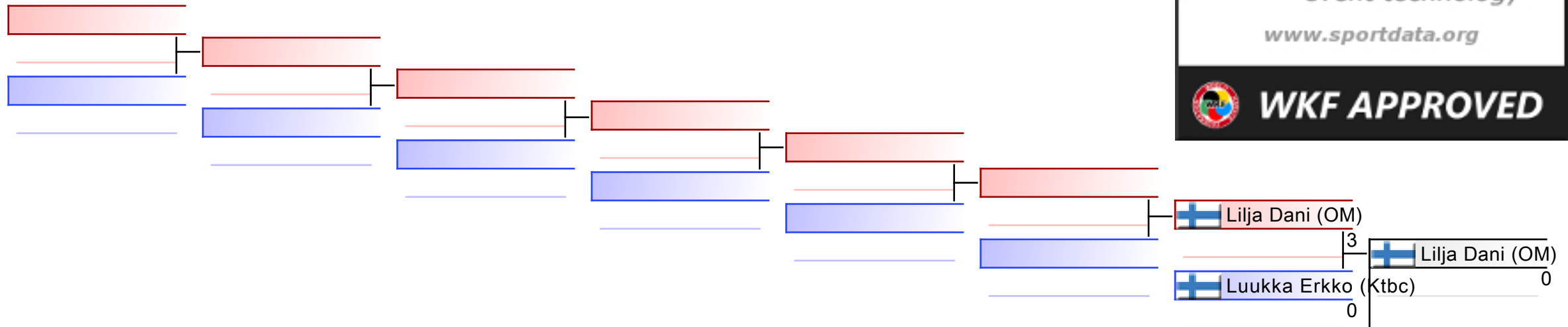



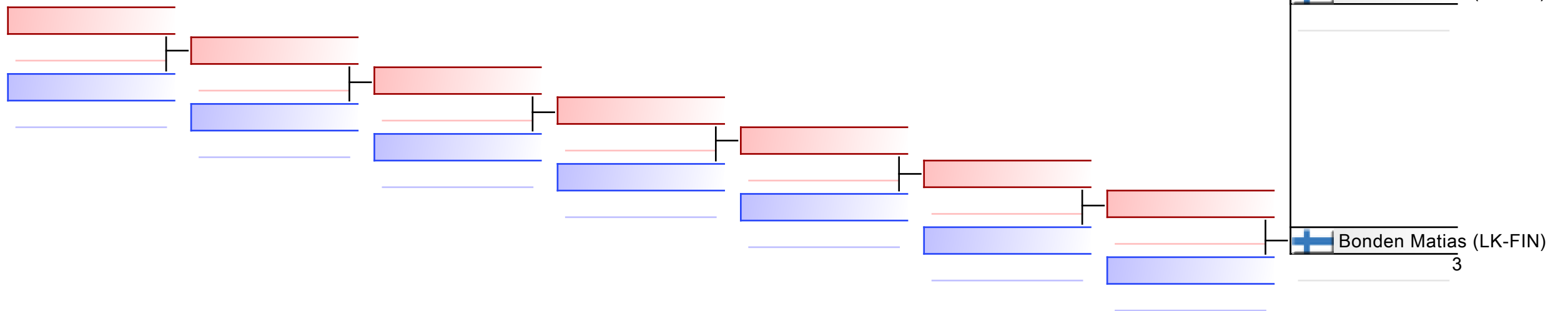

REPECHAGE: (1)



Referees:							
-----------	--	--	--	--	--	--	--

Official Results

U12 pojat kumite -42kg				
1	SÄIPPÄ EMIL	TAPANILAN ERÄ		FIN - FINLAND
2	ANTTILA PAOLO	RENSHIN-KAN RY		FIN - FINLAND
3	BONDEN MATIAS	LAHDEN KARATE		FIN - FINLAND
4	LILJA DANI	SPORTSKARATE KUOPIO		FIN - FINLAND
5	LUUKKA ERKKO	KOTKA THAIBOXING CLUB		FIN - FINLAND

U12 TYTÖT KATA

KARATEN SM KILPAILUT 2024
ENTRIES BY WEIGHT CATEGORY
U12 tytöt kata
As of 7 APR 2024

NOC Code	Gender	Name	Seeding
FIN	F	Asiala Erin	
FIN	F	Heino Lilya	
FIN	F	Pöllänen Hilma	
FIN	F	Pöyhönen Iida	
FIN	F	Rasoli Asma	

U12 tytöt kata

KARATĒN SM KILPAILUT 2024, Asikkalantie 14, 17200 Vääksy, FIN

2024-04-06

Tatami
3 10:00

Pool
1/1

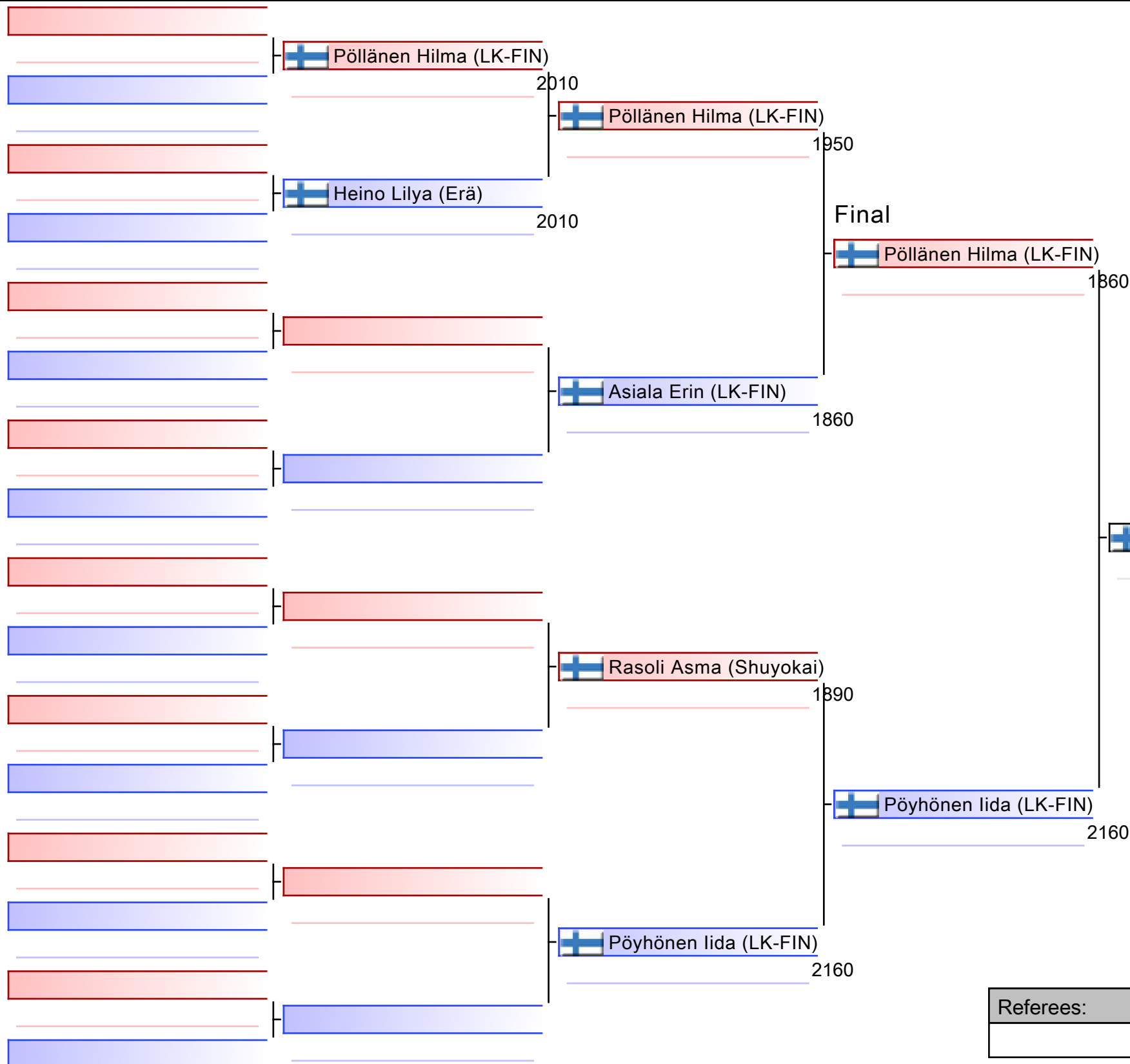

1. PÖYHÖNEN IIDA (LK-FIN)
2. PÖLLÄNEN HILMA (LK-FIN)
3. HEINO LILYA (ERÄ)
4. RASOLI ASMA (SHUYOKAI)
5. ASIALA ERIN (LK-FIN)

Referees:			

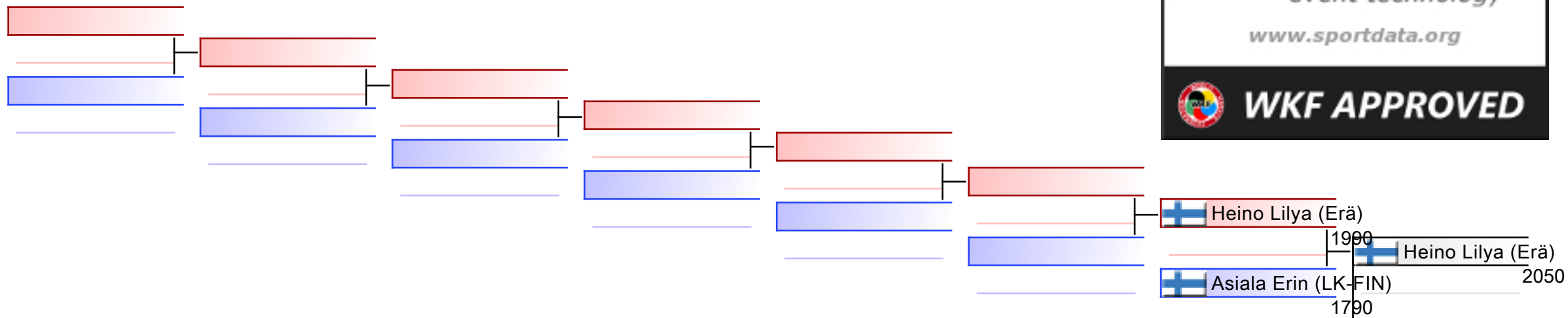



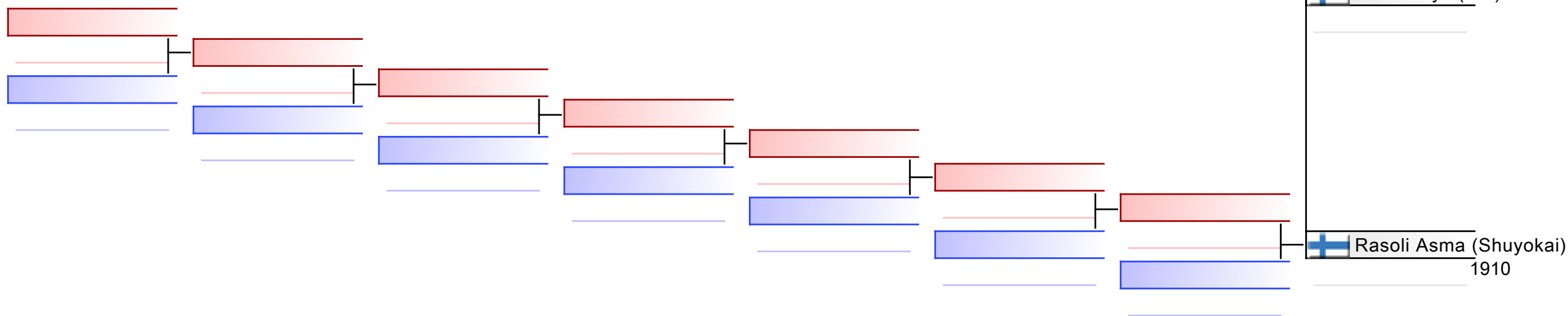

REPECHAGE: (1)



Referees:							
-----------	--	--	--	--	--	--	--

Official Results

U12 tytöt kata				
1	PÖYHÖNEN IIDA	LAHDEN KARATE		FIN - FINLAND
2	PÖLLÄNEN HILMA	LAHDEN KARATE		FIN - FINLAND
3	HEINO LILYA	TAPANILAN ERÄ		FIN - FINLAND
4	RASOLI ASMA	SHUYOKAI SHOTOKAN KARATE- DO		FIN - FINLAND
5	ASIALA ERIN	LAHDEN KARATE		FIN - FINLAND

U12 TYTÖT KUMITE AVOIN

KARATEN SM KILPAILUT 2024
ENTRIES BY WEIGHT CATEGORY
u12 tytöt kumite avoin
As of 7 APR 2024

NOC Code	Gender	Name	Seeding
FIN	F	Heino Lilya	
FIN	F	Keskinen Emilia	
FIN	F	Nuhanovic Amina	
FIN	F	Pöyhönen Iida	
FIN	F	Savolainen Elli	
FIN	F	Vesikko Minea	

u12 tytöt kumite avoin

KARATĒN SM KILPAILUT 2024, Asikkalantie 14, 17200 Vääksy, FIN

2024-04-06

Tatami
3 12:40

Pool
1/1

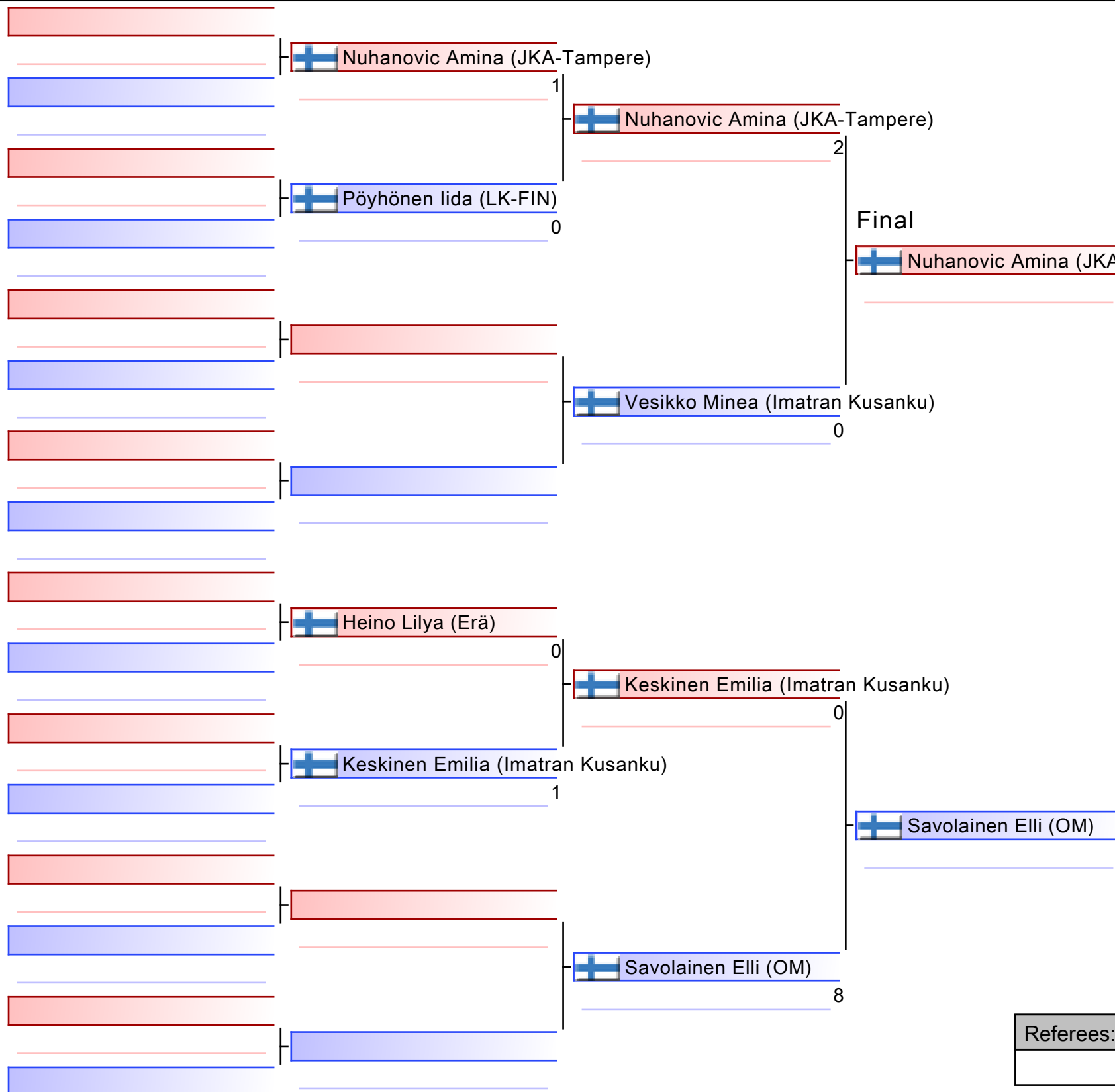

1. NUHANOVIC AMINA (JKA-TAMPERE)
2. SAVOLAINEN ELLI (OM)
3. PÖYHÖNEN IIDA (LK-FIN)
4. KESKINEN EMILIA (IMATRAN KUSANKU)
5. VESIKKO MINEA (IMATRAN KUSANKU)

Referees:			

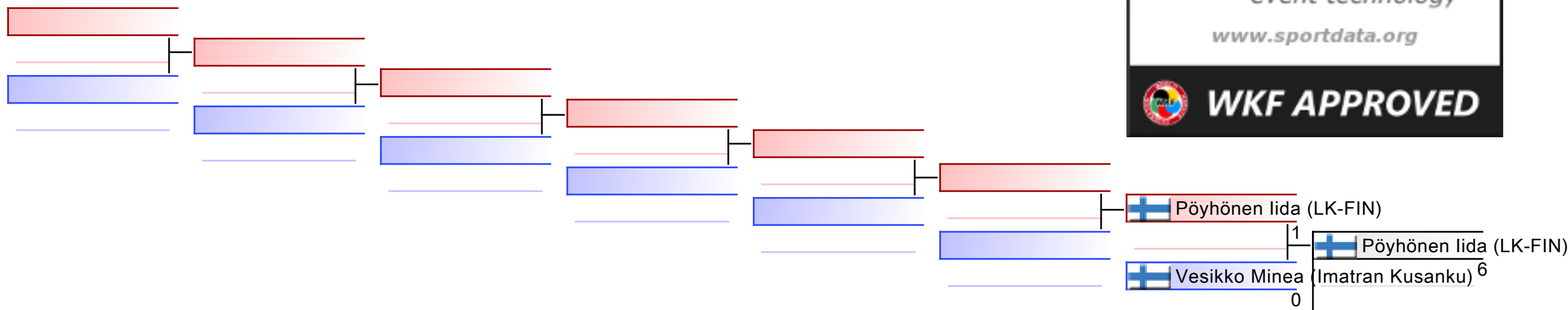



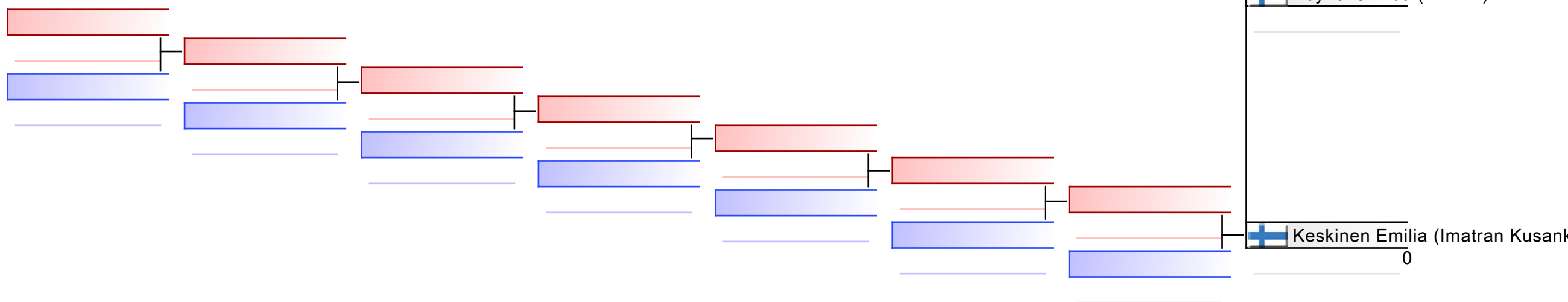

REPECHAGE: (1)







Referees:							
-----------	--	--	--	--	--	--	--



Official Results



u12 tytöt kumite avoin				
1	NUHANOVIC AMINA	JAPAN KARATE ASSOCIATION TAMPERE RY		FIN - FINLAND
2	SAVOLAINEN ELLI	SPORTSKARATE KUOPIO		FIN - FINLAND
3	PÖYHÖNEN IIDA	LAHDEN KARATE		FIN - FINLAND
4	KESKINEN EMILIA	BUDOSEURA IMATRAN KUSANKU RY		FIN - FINLAND
5	VESIKKO MINEA	BUDOSEURA IMATRAN KUSANKU RY		FIN - FINLAND



Official Results

JOUKKUE, KATA, NAISET				
1	SPORTSKARATE.FI - MARTTILA NOORA - KYLMÄNEN JENNA - KESKIIVARI MARI	SPORTSKARATE.FI		FIN - FINLAND
2	LAHDEN KARATE - KALLIO SARA - LEHTINEN NEA - MÄNTY BESS	LAHDEN KARATE		FIN - FINLAND
3	JKA - LANTTA WIIVI - HINTIKKA MARIA - HEISKANEN IINES	JAPAN KARATE ASSOCIATION TAMPERE RY		FIN - FINLAND

JOUKKUE, KUMITE, U16, POJAT				
1	JOEN MAWASHI RY - JÄRVENPÄÄ TATU - SIMONEN RENE - SIMONEN TINO	JOEN MAWASHI RY		FIN - FINLAND
2	OULUN KARATESEURA - LÄHETKANGAS LUKA - TAKALA ANTON - VAARA SANTERI	OULUN KARATESEURA		FIN - FINLAND
3	SPORTSKARATE.FI - HONKANEN SANTTU - LAURONEN LEO - SAADAOUI SAMI	SPORTSKARATE.FI		FIN - FINLAND
4	JIGOTAI KARATE 1 - PYLVÄNEN ANTON - PIENIMÄKI ROOPE - HANHINEN ONNI	JIGOTAI KARATE		FIN - FINLAND
5	JIGOTAI KARATE 2 - HIRVONEN JESSE - TARKKANEN OTSO - TKACHENKO TIMOFEI	JIGOTAI KARATE		FIN - FINLAND

JOUKKUE, KUMITE, U18, POJAT				
1	JKA-HML - NUHANOVIC ALSAD - KREUS PETRUS - MANTERE JIMI	JAPAN KARATE ASSOCIATION TAMPERE RY		FIN - FINLAND
2	RENSHIN-KAN RY - HÄNNINEN AARNI - HÄNNINEN NILO - LINTELÄ JAMI	RENSHIN-KAN RY		FIN - FINLAND

KATA, MIEHET				
1	TAKALA AKSELI	OULUN KARATESEURA		FIN - FINLAND
2	JÄRVINEN OTSO	JAPAN KARATE ASSOCIATION TAMPERE RY		FIN - FINLAND
3	HÄRKÖNEN JARNO	OUTOKUMMUN KARATESEURA RY		FIN - FINLAND

KATA, NAISET				
1	MÄNTY BESS	LAHDEN KARATE		FIN - FINLAND
2	LEHTINEN NEA	LAHDEN KARATE		FIN - FINLAND





Official Results

3	HINTIKKA MARIA	JAPAN KARATE ASSOCIATION TAMPERE RY		FIN - FINLAND	
4	SIHVONEN ELLA	BUDOSEURA OULUN MUSOKAI RY		FIN - FINLAND	

KATA, U16, POJAT

1	VAARA SANTERI	OULUN KARATESEURA		FIN - FINLAND	
2	KIVIMÄKI VEIKKO	LAHDEN KARATE		FIN - FINLAND	
3	HUUSKONEN VEETI	LAHDEN KARATE		FIN - FINLAND	
4	SANDGREN JOONA	VANTAAN WADO RYU RY		FIN - FINLAND	
5	TARKKANEN OTSO	JIGOTAI KARATE		FIN - FINLAND	
5	HEISKA OSKARI	HYVINKÄÄN SHOTOKAN KARATE RY		FIN - FINLAND	
7	TKACHENKO TIMOFEI	JIGOTAI KARATE		FIN - FINLAND	



KATA, U16, TYTÖT

1	KALLIO SARA	LAHDEN KARATE		FIN - FINLAND	
2	KUUSI NIKA	HÄMEENLINNAN KARATESEURA		FIN - FINLAND	
3	HANNU ALVA	BUDOSEURA OULUN MUSOKAI RY		FIN - FINLAND	
4	AHONEN VENLA	LAHDEN KARATE		FIN - FINLAND	
5	TAMMELA IITU	HÄMEENLINNAN KARATESEURA		FIN - FINLAND	





KATA, U18, TYTÖT

1	KUUSI NIKA	HÄMEENLINNAN KARATESEURA		FIN - FINLAND	
2	ALATALO ONERVA	JKS FINLAND - SHOTOKAN KARATE HELSINKI		FIN - FINLAND	

KATA, U21, MIEHET

1	LEHTINEN JESSE	LAHDEN KARATE		FIN - FINLAND	
2	TAKALA AKSELI	OULUN KARATESEURA		FIN - FINLAND	

KATA, U21, NAISET

1	LEHTINEN NEA	LAHDEN KARATE		FIN - FINLAND	
2	LANTTA WIIVI	JAPAN KARATE ASSOCIATION TAMPERE RY		FIN - FINLAND	
3	SIHVONEN ELLA	BUDOSEURA OULUN MUSOKAI RY		FIN - FINLAND	
4	MYLLYMÄKI MAIJU	PARKANON KAMPPAILUSEURA RY.		FIN - FINLAND	

KUMITE, MIEHET +35v, -75KG yhdistetty

1	LUUKKA EKI	KOTKA THAIBOXING CLUB		FIN - FINLAND	
---	------------	-----------------------	---	---------------	--

Official Results

2	TOIVANEN PETRI	SPORTSKARATE KUOPIO		FIN - FINLAND	
---	----------------	------------------------	---	---------------	--



KUMITE, MIEHET, +84KG

1	NURMI LALLI	RENSHIN-KAN RY		FIN - FINLAND	
2	KHALIFA MIIDU	OULUN KARATESEURA		FIN - FINLAND	





KUMITE, MIEHET, -75KG

1	TOIVANEN PETRI	SPORTSKARATE KUOPIO		FIN - FINLAND	
2	BANAULIKER KARTIK-OTTO	BUDOKWAI RY KARATE		FIN - FINLAND	
3	LUUKKA EKI	KOTKA THAIBOXING CLUB		FIN - FINLAND	



KUMITE, MIEHET, -84KG

1	KULOVUORI BJÖRN	JKS FINLAND - SHOTOKAN KARATE HELSINKI		FIN - FINLAND	
2	MANTERE NIKO	HÄMEENLINNAN KARATESEURA		FIN - FINLAND	
3	MANTERE JIMI	HÄMEENLINNAN KARATESEURA		FIN - FINLAND	

KUMITE, MIEHET, AVOIN

1	NURMI LALLI	RENSHIN-KAN RY		FIN - FINLAND	
2	MANTERE NIKO	HÄMEENLINNAN KARATESEURA		FIN - FINLAND	
3	KHALIFA MIIDU	OULUN KARATESEURA		FIN - FINLAND	
4	VINK JEFFREY	JKS FINLAND - SHOTOKAN KARATE HELSINKI		FIN - FINLAND	





KUMITE, NAISET, +68KG

1	KEINÄNEN TITTA	EURAN KARATESEURA		FIN - FINLAND	
2	KORPELA MARIA	SPORTSKARATE.FI		FIN - FINLAND	
3	SIITARINEN OLIVIA	RENSHIN-KAN RY		FIN - FINLAND	





KUMITE, NAISET, -68KG

1	KOPONEN KIIA	LAHDEN KARATE		FIN - FINLAND	
2	SEPPÄLÄ SAANA	LEMPÄÄLÄN SHOTOKAN KARATE		FIN - FINLAND	





KUMITE, NAISET, AVOIN





1	KEINÄNEN TITTA	EURAN KARATESEURA		FIN - FINLAND	
2	KOPONEN KIIA	LAHDEN KARATE		FIN - FINLAND	
3	SIITARINEN OLIVIA	RENSHIN-KAN RY		FIN - FINLAND	
4	SEPPÄLÄ SAANA	LEMPÄÄLÄN SHOTOKAN KARATE		FIN - FINLAND	



Official Results





KUMITE, U14, POJAT -45KG yhdistetty				
1	MATTINEN NUUTTI	SPORTSKARATE KUOPIO		FIN - FINLAND
2	KELLA KASPERI	LAHDEN KARATE		FIN - FINLAND
3	ANTTILA KEN	RENSHIN-KAN RY		FIN - FINLAND
4	HUUSKONEN KOSTI	SPORTSKARATE KUOPIO		FIN - FINLAND

KUMITE, U14, POJAT -55KG yhdistetty				
1	VESTERINEN MAX	MÄNTSÄLÄN KARATE		FIN - FINLAND
2	KELTTO TOPIAS	LAKEUDEN KARATE- JUTSU RY		FIN - FINLAND
3	MUURINAHO LUKA	JAPAN KARATE ASSOCIATION TAMPERE RY		FIN - FINLAND
4	LÄMSÄ LUKA	KOTKA THAIBOXING CLUB		FIN - FINLAND
5	MUURINAHO LUKA	JAPAN KARATE ASSOCIATION TAMPERE RY		FIN - FINLAND
5	HANNU EERO	BUDOSEURA OULUN MUSOKAI RY		FIN - FINLAND





KUMITE, U14, POJAT, +55kg				
1	TAKALA ANTON	OULUN KARATESEURA		FIN - FINLAND
2	LÄHETKANGAS LUKA	OULUN KARATESEURA		FIN - FINLAND
3	VARTIAINEN JUUSO	JOEN MAWASHI RY		FIN - FINLAND
4	TAMEH MOHAMMED	SPORTSKARATE KUOPIO		FIN - FINLAND







KUMITE, U14, TYTÖT, +47kg				
1	STEFANSKI VANESSA	LAHDEN KARATE		FIN - FINLAND
2	OLLIKAINEN SAARA	BUDOSEURA OULUN MUSOKAI RY		FIN - FINLAND
3	HOHTI HERTTA	TAPANILAN ERÄ		FIN - FINLAND
4	MONTI SOFIA	JOEN MAWASHI RY		FIN - FINLAND







KUMITE, U14, TYTÖT, -42KG				
1	ANTTILA ISABELLA	RENSHIN-KAN RY		FIN - FINLAND
2	ANTINKAAPO NEA	JIGOTAI KARATE		FIN - FINLAND
3	HEINO DAISY	TAPANILAN ERÄ		FIN - FINLAND



KUMITE, U14, TYTÖT, -47KG				
1	KATZMAN ESTER	SPORTSKARATE KUOPIO		FIN - FINLAND
2	LEISTI CHARUPHAT	KOTKA THAIBOXING CLUB		FIN - FINLAND
3	NUHANOVIC HASKA	JAPAN KARATE ASSOCIATION TAMPERE RY		FIN - FINLAND
4	HYVÖNEN LILA	SPORTSKARATE KUOPIO		FIN - FINLAND





Official Results





KUMITE, U16, POJAT +63KG yhdistetty				
1	HUUSKONEN VEETI	LAHDEN KARATE		FIN - FINLAND
2	ERONEN ALEX	SPORTSKARATE.FI		FIN - FINLAND
3	PIENIMÄKI ROOPE	JIGOTAI KARATE		FIN - FINLAND
4	ALGAHAWI YAKOOT	BUDOKWAI RY KARATE		FIN - FINLAND

KUMITE, U16, POJAT, -52KG				
1	LAURONEN LEO	SPORTSKARATE.FI		FIN - FINLAND
2	HANHINEN ONNI	JIGOTAI KARATE		FIN - FINLAND
3	KETTUNEN EEMELI	HÄMEENLINNAN KARATESEURA		FIN - FINLAND
4	TIKKANEN ELIAS	KOTKA THAIBOXING CLUB		FIN - FINLAND
5	MATTINEN NUUTTI	SPORTSKARATE KUOPIO		FIN - FINLAND
5	TARKKANEN OTSO	JIGOTAI KARATE		FIN - FINLAND







KUMITE, U16, POJAT, -57KG				
1	VAARA SANTERI	OULUN KARATESEURA		FIN - FINLAND
2	JÄRVENPÄÄ TATU	SPORTSKARATE PORI		FIN - FINLAND
3	SIMONEN TINO	JOEN MAWASHI RY		FIN - FINLAND
4	SAADAOUI SAMI	SPORTSKARATE.FI		FIN - FINLAND
5	HIRVONEN JESSE	JIGOTAI KARATE		FIN - FINLAND
5	MATERO LUKA	JOEN MAWASHI RY		FIN - FINLAND



KUMITE, U16, POJAT, -63KG				
1	HONKANEN SANTTU	SPORTSKARATE.FI		FIN - FINLAND
2	SIMONEN RENE	JOEN MAWASHI RY		FIN - FINLAND
3	TUONONEN NIKO	SPORTSKARATE KUOPIO		FIN - FINLAND





KUMITE, U16, TYTÖT -54KG yhdistetty				
1	ITKONEN JANIKA	SPORTSKARATE.FI		FIN - FINLAND
2	CHEPELEV SOFIA	SPORTSKARATE.FI		FIN - FINLAND
3	HANNU ALVA	BUDOSEURA OULUN MUSOKAI RY		FIN - FINLAND
4	RISSANEN IINA	SPORTSKARATE KUOPIO		FIN - FINLAND
5	LUUKKA ERIN	KOTKA THAIBOXING CLUB		FIN - FINLAND





KUMITE, U16, TYTÖT, +54KG				
1	MERTAMO AMANDA	TAPANILAN ERÄ		FIN - FINLAND
2	SAARNIO SELJA	SPORTSKARATE.FI		FIN - FINLAND
3	JOKINEN HELMI	HÄMEENLINNAN KARATESEURA		FIN - FINLAND
4	LEHTO IDA	SPORTSKARATE.FI		FIN - FINLAND
5	SILEN VENLA	SEIGOKAN TAMPERE		FIN - FINLAND







Official Results



KUMITE, U18, POJAT -68KG yhdistetty				
1	RAMULA TUUKKA	SPORTSKARATE KUOPIO		FIN - FINLAND
2	TOLVANEN MIDO	JOEN MAWASHI RY		FIN - FINLAND
3	VÄYRYNEN LUUKAS	SPORTSKARATE KUOPIO		FIN - FINLAND
4	MATERO JIMI	JOEN MAWASHI RY		FIN - FINLAND
5	NURMESNIEMI LAURI	LAKEUDEN KARATE-JUTSU RY		FIN - FINLAND
5	MARTTILA LAURI	SEIGOKAN TAMPERE		FIN - FINLAND

KUMITE, U18, POJAT, +76KG				
1	MANTERE JIMI	HÄMEENLINNAN KARATESEURA		FIN - FINLAND
2	LINTELÄ JAMI	RENSHIN-KAN RY		FIN - FINLAND



KUMITE, U18, POJAT, -76KG				
1	HÄNNINEN AARNI	RENSHIN-KAN RY		FIN - FINLAND
2	HÄNNINEN NIILLO	RENSHIN-KAN RY		FIN - FINLAND
3	NUHANOVIC ALSAD	JAPAN KARATE ASSOCIATION TAMPERE RY		FIN - FINLAND
4	KREUS PETRUS	JAPAN KARATE ASSOCIATION TAMPERE RY		FIN - FINLAND





KUMITE, U18, TYTÖT +59KG yhdistetty				
1	SAADAQUI SONYA	SPORTSKARATE.FI		FIN - FINLAND
2	LAFGHANI HANAN	SPORTSKARATE.FI		FIN - FINLAND
3	MERTAMO AMANDA	TAPANILAN ERÄ		FIN - FINLAND
4	JOKINEN HELMI	HÄMEENLINNAN KARATESEURA		FIN - FINLAND
5	VÄLIAHDET OLGA	SEIGOKAN TAMPERE		FIN - FINLAND





KUMITE, U18, TYTÖT -59KG yhdistetty				
1	KOIVULA SOFIA	SPORTSKARATE.FI		FIN - FINLAND
2	ITKONEN JANIKA	SPORTSKARATE.FI		FIN - FINLAND
3	SALME KRISTIINA	TAPANILAN ERÄ		FIN - FINLAND
4	SAVOLAINEN MEERI	SPORTSKARATE KUOPIO		FIN - FINLAND
5	PAATTIMÄKI ALIISA	JAPAN KARATE ASSOCIATION TAMPERE RY		FIN - FINLAND
5	RISSANEN IINA	SPORTSKARATE KUOPIO		FIN - FINLAND



KUMITE, U21, MIEHET, +67KG yhdistetty				
1	HÄNNINEN AARNI	RENSHIN-KAN RY		FIN - FINLAND
2	KELTTO MATIAS	LAKEUDEN KARATE-JUTSU RY		FIN - FINLAND
3	BANAULIKER KARTIK-OTTO	BUDOKWAI RY KARATE		FIN - FINLAND



Official Results





KUMITE, U21, MIEHET, -67KG yhdistetty					
1	LEHTINEN JESSE	LAHDEN KARATE		FIN - FINLAND	
2	SAARIO LEEVI	LAHDEN KARATE		FIN - FINLAND	
3	REKOLA TUOMAS	SPORTSKARATE KUOPIO		FIN - FINLAND	





KUMITE, U21, NAISET +55kg					
1	KOPONEN KIIA	LAHDEN KARATE		FIN - FINLAND	
2	SIITARINEN OLIVIA	RENSHIN-KAN RY		FIN - FINLAND	
3	SAADAQUI SONYA	SPORTSKARATE.FI		FIN - FINLAND	
4	RASOLI AREZO	SHUYOKAI SHOTOKAN KARATE- DO		FIN - FINLAND	

KUMITE, U21, NAISET, -55KG					
1	NIKANDER SAIMI	SPORTSKARATE.FI		FIN - FINLAND	
2	SAVOLAINEN MEERI	SPORTSKARATE KUOPIO		FIN - FINLAND	
3	SALME KRISTIINA	TAPANILAN ERÄ		FIN - FINLAND	
4	RASOLI FATIMA	SHUYOKAI SHOTOKAN KARATE- DO		FIN - FINLAND	





Kata miehet +40v					
1	HÄRKÖNEN JARNO	OUTOKUMMUN KARATESEURA RY		FIN - FINLAND	
2	CASCI GIANGABRIELE	JKS FINLAND - SHOTOKAN KARATE HELSINKI		FIN - FINLAND	
3	TUOMINEN VESA	HYVINKÄÄN SHOTOKAN KARATE RY		FIN - FINLAND	

Kata sovellettu					
1	MÄENPÄÄ JAAKKO	LAHDEN KARATE		FIN - FINLAND	
2	LEHTINEN TUOMAS	LAHDEN KARATE		FIN - FINLAND	

Kata, U14, pojat					
1	KELLA KASPERI	LAHDEN KARATE		FIN - FINLAND	
2	TAKALA ANTON	OULUN KARATESEURA		FIN - FINLAND	
3	LÄHETKANGAS LUKA	OULUN KARATESEURA		FIN - FINLAND	
4	KIVIKOSKI JERE	LAHDEN KARATE		FIN - FINLAND	

Kata, U14, tytöt					
1	WANIC MARIE	SHUYOKAI SHOTOKAN KARATE- DO		FIN - FINLAND	
2	STEFANSKI VANESSA	LAHDEN KARATE		FIN - FINLAND	
3	ORTIZ ANTONIA	JKS FINLAND - SHOTOKAN KARATE HELSINKI		FIN - FINLAND	
4	OLLIKAINEN SAARA	BUDOSEURA OULUN MUSOKAI RY		FIN - FINLAND	

Official Results

5	VUORINEN ELIN	LAHDEN KARATE		FIN - FINLAND	
5	HEINO DAISY	TAPANILAN ERÄ		FIN - FINLAND	
7	LINDSTRÖM MERI	LAHDEN KARATE		FIN - FINLAND	
7	ALATALO VANAMO	JKS FINLAND - SHOTOKAN KARATE HELSINKI		FIN - FINLAND	

Kumite miehet 35-50v +75kg

1	HÄRKÖNEN JARNO	OUTOKUMMUN KARATESEURA RY		FIN - FINLAND	
2	RASILA PETRI	KUSHIN-KAN		FIN - FINLAND	

Kumite, miehet, -67kg yhdistetty

1	SAARIO LEEVI	LAHDEN KARATE		FIN - FINLAND	
2	LEHTINEN JESSE	LAHDEN KARATE		FIN - FINLAND	

U12 pojat kata

1	WANIC MARK	SHUYOKAI SHOTOKAN KARATE- DO		FIN - FINLAND	
2	SÄIPPÄ EMIL	TAPANILAN ERÄ		FIN - FINLAND	
3	BONDEN MATIAS	LAHDEN KARATE		FIN - FINLAND	
4	LEHTO EEMELI	LAHDEN KARATE		FIN - FINLAND	
5	TEJESVI SHASHANK	OULUN KARATESEURA		FIN - FINLAND	
5	HANNU AARRE	BUDOSEURA OULUN MUSOKAI RY		FIN - FINLAND	





U12 pojat kumite +42kg

1	TAMEH ABDULKARIM	SPORTSKARATE KUOPIO		FIN - FINLAND	
2	HEIKKILÄ ELIEL	BUDOKWAI RY KARATE		FIN - FINLAND	
3	KULLBERG ADAM	BUDOSEURA IMATRAN KUSANKU RY		FIN - FINLAND	

U12 pojat kumite -35kg

1	KIVISTÖ HUGO	HÄMEENLINNAN KARATESEURA		FIN - FINLAND	
2	HANNU AARRE	BUDOSEURA OULUN MUSOKAI RY		FIN - FINLAND	
3	RALLI ALEXI	BUDOSEURA IMATRAN KUSANKU RY		FIN - FINLAND	
4	TEJESVI SHASHANK	OULUN KARATESEURA		FIN - FINLAND	





U12 pojat kumite -42kg

1	SÄIPPÄ EMIL	TAPANILAN ERÄ		FIN - FINLAND	
2	ANTTILA PAOLO	RENSHIN-KAN RY		FIN - FINLAND	
3	BONDEN MATIAS	LAHDEN KARATE		FIN - FINLAND	
4	LILJA DANI	SPORTSKARATE KUOPIO		FIN - FINLAND	





Official Results

5	LUUKKA ERKKO	KOTKA THAIBOXING CLUB		FIN - FINLAND	
---	--------------	-----------------------	---	---------------	--

U12 tytöt kata

























1	PÖYHÖNEN IIDA	LAHDEN KARATE		FIN - FINLAND	
2	PÖLLÄNEN HILMA	LAHDEN KARATE		FIN - FINLAND	
3	HEINO LILYA	TAPANILAN ERÄ		FIN - FINLAND	
4	RASOLI ASMA	SHUYOKAI SHOTOKAN KARATE-DO		FIN - FINLAND	
5	ASIALA ERIN	LAHDEN KARATE		FIN - FINLAND	

u12 tytöt kumite avoin

1	NUHANOVIC AMINA	JAPAN KARATE ASSOCIATION TAMPERE RY		FIN - FINLAND	
2	SAVOLAINEN ELLI	SPORTSKARATE KUOPIO		FIN - FINLAND	
3	PÖYHÖNEN IIDA	LAHDEN KARATE		FIN - FINLAND	
4	KESKINEN EMILIA	BUDOSEURA IMATRAN KUSANKU RY		FIN - FINLAND	
5	VESIKKO MINEA	BUDOSEURA IMATRAN KUSANKU RY		FIN - FINLAND	

KARATEN SM KILPAILUT 2024 - 2024-04-06

Medals - Club

Rank	Club	1. Place	2. Place	3. Place
1	 LAHDEN KARATE, FIN	13	10	4
2	 SPORTSKARATE.FI, FIN	7	6	2
3	 RENSHIN-KAN RY, FIN	5	5	3
4	 SPORTSKARATE KUOPIO, FIN	5	3	3
5	 OULUN KARATESEURA, FIN	4	5	2
6	 HÄMEENLINNAN KARATESEURA, FIN	3	3	3
7	 JAPAN KARATE ASSOCIATION TAMPERE RY, FIN	2	2	5
8	 TAPANILAN ERÄ, FIN	2	1	6
9	 OUTOKUMMUN KARATESEURA RY, FIN	2	0	1
10	 EURAN KARATESEURA, FIN	2	0	0
	 SHUYOKAI SHOTOKAN KARATE-DO, FIN	2	0	0
12	 JOEN MAWASHI RY, FIN	1	2	2
13	 JKS FINLAND - SHOTOKAN KARATE HELSINKI, FIN	1	2	1
14	 KOTKA THAIBOXING CLUB, FIN	1	1	1
15	 MÄNTSÄLÄN KARATE, FIN	1	0	0
16	 BUDOSEURA OULUN MUSOKAI RY, FIN	0	2	3
17	 JIGOTAI KARATE, FIN	0	2	1
	 BUDOKWAI RY KARATE, FIN	0	2	1
19	 LAKEUDEN KARATE-JUTSU RY, FIN	0	2	0
20	 SPORTSKARATE PORI, FIN	0	1	0
	 LEMPÄÄLÄN SHOTOKAN KARATE, FIN	0	1	0
	 KUSHIN-KAN, FIN	0	1	0
23	 BUDOSEURA IMATRAN KUSANKU RY, FIN	0	0	2
24	 HYVINKÄÄN SHOTOKAN KARATE RY, FIN	0	0	1