



INTEC[®]
LIGHT

outdoor

Technische Außenbeleuchtung
Technical outdoor lighting

de/en

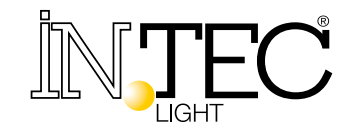

**Wenn die Forschung Antworten auf
die Anforderungen findet, alte wie neue.
Wenn die Technologie Probleme löst.
Wenn Technik und Ästhetik harmonisch eins werden.
Dort entstehen die glänzendsten Lösungen.**

When research finds solutions
to needs, both old and new.
When technology solves problems.
When technology and aesthetic
appeal harmoniously merge.
That's when the bright solutions are born.

outdoor

Technische Außenbeleuchtung
Technical outdoor lighting



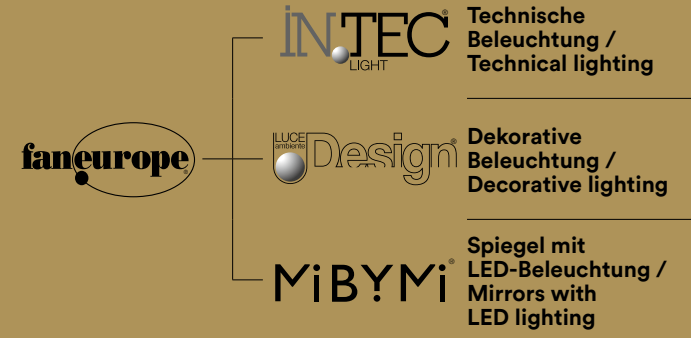

GESTERN UND HEUTE PRÄSENT /
YESTERDAY AND TODAY, PRESENT



In.tec light

Eine über 100 Jahre lange Entwicklung

Unsere Geschichte begann zu Beginn des 20. Jahrhunderts in Neapel. Es ist eine Geschichte voller Engagement, Entwicklung und Mut. Eine Geschichte, deren Verlauf ununterbrochen mit der des Glases verbunden ist. Generation um Generation entwickelt sich **FAN Europe Lighting** weiter, ändert seine Form und setzt seine Vorstellung von Produkt und Service mit dem Ziel um, ein Ansprechpartner für den gesamten Beleuchtungssektor zu werden.

Unser Unternehmen heute

Heute ist **FAN Europe Lighting** ein großartiges Team von Personen und Ressourcen. Das Streben nach Exzellenz bei der Qualität der Produkte kombinieren wir mit einem Ökosystem aus Dienstleistungen und Garantien, die wir den Anforderungen und den Kunden entsprechend entwickelt und organisiert haben. Unsere italienische Tradition lässt uns die Bedeutung von Originalität und Sorgfalt bei der Produktfertigung nicht aus den Augen verlieren. Unser Drang zu wachsen treibt uns dazu, immer mit der Beleuchtung von heute und morgen Schritt zu halten, einer Beleuchtung, die immer intelligenter und umweltfreundlicher wird und sich ständig wandelt.

Our history began in Naples in the early 1900s. It's a history of commitment, evolution and courage. A history that follows the thread of time, constantly intertwining with that of glass. Generation after generation, **FAN Europe Lighting** has evolved, changing shape, developing its concept of products and services to become a benchmark for the entire lighting industry.

Today, **FAN Europe Lighting** is a vast team of people and resources. In addition to pursuing excellence in product quality, we combine an ecosystem of services and guarantees, which we have developed and tailored to our customers' needs. Our Italian heritage does not allow us to forget the importance of originality and product care. Our desire to grow motivates us to always keep up with the lighting of today and tomorrow, lighting that is always smarter, more eco-friendly and evolving.

An evolution spanning more than 100 years

Our company, today



EINE SYNERGIE AUS RESSOURCEN UND GARANTIEN / A SYNERGY OF RESOURCES AND GUARANTEES



Qualität an erster Stelle

Hochwertige Komponenten, Mehrfachkontrollen, Prüfungen während der Entstehungsphase: Bei der Qualität gehen wir nie Kompromisse ein. Dank eines Teams von Experten sind wir in der Lage, modernste Technologie, jedes Jahr verbesserte Finish und langlebige neue Designformen zu garantieren.

Die umfassendste Produktpalette

Wir sind eines der wenigen Unternehmen der Welt, die so zahlreiche Zielbranchen abdecken: von industrieller Beleuchtung bis zu dekorativen Erzeugnissen. Wir sind "leidenschaftliche Forscher" und erweitern das Produktangebot jedes Jahr um im Trend liegende Kollektionen und die vielversprechendsten Innovationen in Hinblick auf Technologie und Nachhaltigkeit.

Durch die stilistische und technologische Weiterentwicklung der Beleuchtung hat sich die Forschung in der Beleuchtungstechnik auf maßgefertigte Beleuchtungsprojekte konzentriert, bei denen die Beleuchtungskörper Instrumente im Dienste des Architekturprojekts sind. Diese Entwicklungsphase hat uns dazu geführt, unsere Abteilung für Projekte und Beleuchtungstechnik speziell für individuell gestaltete Projekte zu erweitern. Die Abteilung ist bereits jetzt für Dienstleistungen im Bereich Planung, Prototypenbau, Prüfung und Produktionskontrolle für jedes in unserem Katalog enthaltene Produkt zuständig. Wenn die Produkte nicht den Anforderungen des Kunden entsprechen, stellen wir "kundenspezifische" Produkte nach Maß für die Anforderungen des Projekts her und um die Umgebungen des Beleuchtungsdesigns im höchsten Maße zur Geltung zu bringen. Dank Programmierwerkzeugen und Software zur photometrischen Berechnung können wir für jedes neue Produkt die photometrischen Berechnungen für einen geeigneten beleuchtungstechnischen Projektverlauf zur Verfügung stellen.

Quality components, multiple checks, testing during the manufacturing process: we never compromise on quality. With our team of experts, we can guarantee cutting-edge technology, new improved finishes every year and new designs that will stand the test of time!

We are one of the few companies in the world to cover so many target sectors: from industrial lighting to decor products. As "passionate researchers" every year we enrich our range with trend-setting collections and the most efficient innovations in terms of technology and sustainability.

The stylistic and technological evolution of lighting has steered lighting research towards custom-made lighting projects, in which luminaires are used to support architectural design. This evolutionary phase encouraged us to expand our Project and Lighting department focusing on custom-made projects. The department already provides design, prototyping, testing and production monitoring services for all the products in our catalogue. When products don't meet the customer's needs, we make bespoke products to meet project requirements and fully enhance lighting design contexts. Using computer tools and photometric calculation software, we can provide photometric calculations for each new product thereby appropriately developing the lighting design project.

Quality comes first

The most comprehensive range of products

WIR SIND UMWELTFREUNDLICH / WE ARE ECO-FRIENDLY

Wir haben Kunststoff aus unseren Verpackungen verbannt. Wir wählen und bevorzugen Materialien aus nachhaltigen Ressourcen. Wir erforschen die Technologien mit bester Energieeffizienz in Kombination mit intelligenten Systemen, die in der Lage sind, den Verbrauch noch weiter zu reduzieren. All dies und noch vieles mehr stellt unser Engagement für Nachhaltigkeit unter Beweis.

We no longer use plastic in our packaging. We select and prefer materials from sustainable resources. We research the most energy-efficient technologies combined with smart systems that further reduce consumption. All this, and much more, shows our commitment to sustainability!



STETS ERREICHBARER KUNDENDIENST / ASSISTANCE ALWAYS AVAILABLE



Höchste Produktverfügbarkeit

Wir sind immer für Sie da! Mit unserer Hilfsbereitschaft, Professionalität und einem klaren Ziel: das Leben unserer Kunden zu vereinfachen. Ein Versprechen an alle, die uns nicht kennen. Eine verlässliche Garantie für alle, die seit Jahren mit uns arbeiten! Wir verfügen über eines der breitesten Sortimente an Artikeln auf dem Markt, doch sind in der Lage, jederzeit 98% Verfügbarkeit zu garantieren. Wir garantieren, dass die verbleibenden 2% innerhalb von 30 Tagen wieder verfügbar sind!

We are always here for you! With our helpfulness, professionalism and a clear goal: to make life easier for our customers. It's a promise we make to those who don't know us. It's an established guarantee for those who have worked with us for years! We have one of the widest ranges of items on the market, but we can guarantee 98% availability at all times. We guarantee that the remaining 2% will be available in 30 days!

Maximum product availability

Schneller und sicherer Versand

Im Laufe der Jahre haben wir ein leistungsfähiges Logistiksystem entwickelt, das in der Lage ist, Lieferungen innerhalb von 24 Stunden in Italien und von 48 Stunden in Europa und gleichzeitige höchste Umsicht während des Transports zu garantieren. Unser mehrsprachiges Team steht unseren Kunden außerdem unterstützend und betreuend zur Seite.

Over the years, we have developed an efficient logistics system that guarantees deliveries within 24h in Italy and 48h in Europe, ensuring maximum care during transport. Our multilingual team also provides customers with support and assistance.

Quick and safe shipments



ANLEITUNG ZUM LESEN DER TABELLEN / GUIDE TO READING THE TABLES

Jede Kollektion wird von einem oder mehreren Symbolen für den Bestimmungszweck begleitet
Every collection will be distinguished by a symbol for intended use

Name und Merkmale der Kollektion
Collection name and characteristics



Zertifizierung und Bestimmungen
Certification and regulations

Produkteigenschaften
Product characteristics

Produktcode, EAN-Code und METEL-Code
Product code, EAN code and METEL code

Farbvariante
Colour variance
wo vorhanden / where existing

Farbtemperatur (LED) ausgedrückt in Kelvin + Lumen
Colour temperature in Kelvin + lumen
ove esistente / where existing

Leistung
Power
Für Produkte ohne eingebaute LED-Lampenfassungsdaten mit max. zertifizierter Leistung
For the products without built-in LED max lamp holder power as required by CE certificate

Steuersysteme
für unsere
SMART-Produkte /
Control system
easy installation



Smart Intec WIFI



RF 2.4G control system



Alexa e Google Home
voice control

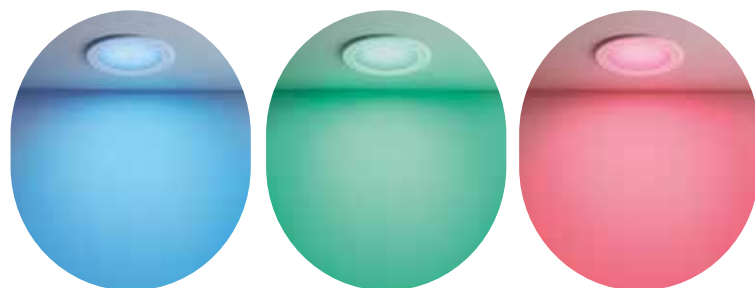

EASY DOMOTICA Mit diesem technischen Segment möchten wir dem wachsenden Bedarf daran gerecht werden, die Qualität von Privat- und Arbeitsleben durch den Einsatz von Beleuchtungsgeräten zu verbessern, die durch Wireless-Technologien zunehmend vereinfachte Anbindungen immer stärker miteinander verknüpft sind. Die Beleuchtungsgeräte werden zu extrem individuell gestalteten und modularen Elementen, die sich, auch zu unterschiedlichen Tageszeiten, an die veränderten Anforderungen an Beleuchtung anpassen, die nicht mehr nur als solche an sich dient, sondern auf verschiedene Stimmungen, sowohl der gewerblichen als auch der häuslichen oder spielerischen Nutzung, abgestimmt ist. In diesem Abschnitt sind die Niederspannungsprodukte gruppiert, die mit Konstantspannungsnetzteilen parallelgeschaltet werden können und sich durch ihre extreme Flexibilität und Modularität auszeichnen, da sie mit Steuergeräten für 2,4-G-Funkfrequenz, Infrarot, Wi-Fi oder Bluetooth kompatibel sind. Die Steuergeräte sehen ihrerseits Wi-Fi- bzw. Bluetooth-Schnittstellen vor oder können mittels Wall Pads oder Funksteuerungen bedient werden.

EASY DOMOTICA With this technical segment, we intend meet in the best way the growing need to improve the quality of home and working life through the use of lighting devices that are increasingly interconnected with each other through connections that are increasingly simplified by wireless technologies. The lighting devices become an extremely personalized and modular tool that merge, even at different times of the day, with the evolved lighting needs no longer as light source itself but light adapted to the different moods of both professional users, domestic users, playful users. This section groups low voltage products that can be connected with constant voltage power supply in parallel connection system and are characterized by extreme flexibility and modularity as they are compatible with 2.4G Radio Frequency, Infrared, Wifi or Bluetooth control units. The control units can be controlled by wifi, bluetooth devices or can be controlled via a wall pad or remote control.



Alle Leuchten können über die APP INTEC und SMART LIFE standortfern gesteuert werden/
All luminaires can be remotely controlled with INTEC and SMART LIFE APPs.

Laden Sie die App Smart Intec herunter unter /
Download App Smart Intec on:



APP INTEC WI-FI Für jeden Moment des täglichen Lebens bedarf es des richtigen Lichts. Dank der Smart-Beleuchtung ist es mit unseren Wi-Fi- und Bluetooth-Geräten möglich, für alle Momente die ideale Atmosphäre zu schaffen. Über unsere App Smart INTEC ist es möglich, alle Beleuchtungsgeräte zu steuern, um sie ein- oder auszuschalten, die Farbtemperatur in Kelvin des Lichts zu ändern und außerdem Szenen einzustellen. Unter unseren Artikeln finden Sie eine Auswahl an einbaufertigen Produkten mit integrierter LED doch auch sämtliche erforderlichen Zubehörteile, um jedes beliebige Gerät smart zu machen. Sobald die Lampe angeschlossen und die App INTEC heruntergeladen wurde, erfolgt die Einrichtung der verschiedenen Zimmer dank der schrittweisen Anleitungen auf einfache und intuitive Weise. Zur Steuerung unserer Smart-Produkte können auch die Smart Speaker und Videos von Amazon und Google verwendet werden. Aktivieren Sie die Funktion und steuern Sie die Geräte einfach mit Ihrer Stimme.

APP INTEC WI-FI Every moment of everyday life require the right light. Thank to the Smart lighting it will be possible to create the ideal atmosphere connecting them and controlling them thorough Wi-fi or Bluetooth connection. **With our APP Smart Intec** it is possible to control from remote all the lighting devices with on-off, kelvin colour temperature changing, light colour and scenes functions. To instore some smart lamps it is necessary just your standard home electric connection, and wifi connection. Once connected the lamp and downloaded the APP Smart Intec it will be very easy to create groups and rooms in very easy process thank to the instructions step by step on the App. The smart lamps can be controlled also with Wifi voice control devices.

SMART INTEC Bluetooth Sig Mesh Der Bluetooth-Standard wurde für die Beleuchtung in Industrie, Gewerbe und Haushalt mit offenen Armen empfangen, da es sich um eines der einfachsten und günstigsten Steuersysteme für intelligente Beleuchtung handelt, dem bei der Vereinfachung des Dialogs zwischen Beleuchtungsgeräten eine Schlüsselrolle zukommt. Unsere Artikel der Reihe Bluetooth Sig Mesh können mit den intelligenten Geräten über die APP Smart Intec verbunden werden und jedes Beleuchtungsgerät kann über ein Mesh-Netzwerk in einem Abstand von 15 m für jedes Gerät mit einer weiteren unendlichen Anzahl von Geräten kommunizieren. Das Mesh-Bluetooth-Netzwerk kann dank der Verbindung des Bluetooth-Gateways standortfern mittels Wi-Fi gesteuert werden, das sich wiederum mit den Sprachsteuerungsgeräten Alexa und Google verbinden kann. Für alle Nutzer sind die Mesh-Bluetooth-Produkte auch bequem zu verwenden. Ein von einem Netzwerk von Großgeräten aktiviertes Mesh-Bluetooth-Netzwerk, das in der Lage ist, den niedrigen Energieverbrauch zu nutzen, kann tausende von gleichzeitig arbeitenden Geräten unterstützen. So können Sie, gleich ob zu Hause oder im Büro, immer eine große Anzahl von gleichzeitig angebotenen intelligenten Geräten betreiben. Folglich stellen die intelligenten Bluetooth-Mesh-Produkte eine ganze Reihe von Annehmlichkeiten zum Leben und Arbeiten zur Verfügung, ohne sich um hohe Energiekosten Sorgen machen zu müssen. In der smarten Wohnung senkt Bluetooth die Hemmschwelle bei der Nutzung von Haustechnikgeräten durch seinen geringen Energieverbrauch, die umfassende Kompatibilität und sein hohes Sicherheitspotenzial und sorgt so für eine günstigere, benutzerfreundlichere und intelligentere Heimautomatisierung. Ohne die Freigabe durch den Benutzer ist das Bluetooth-Signal nicht in der Lage, sich zu verbinden und das Gerät zu verfolgen, sodass der Datenschutz des Benutzers gewahrt bleibt.

SMART INTEC Bluetooth Sig Mesh Bluetooth mesh has been well received across the industrial, commercial and domestic lighting, as one of the easiest and much convenient smart lighting control systems playing a key role in facilitating the inter-dialogue between lighting devices. Our Bluetooth mesh items can be connected with the smart devices through the APP Smart Intec and each lighting device can communicate with other infinite number of devices through the mesh network with all other devices within a distance of 15m. The Bluetooth mesh network can be controlled from remote area through Wifi thank to the connection of Bluetooth gateway that can connect in turn to Alexa and Google voice controls. For individual users, Bluetooth mesh products are also convenient to use. Enabled by a large-scale device network and able to take advantage of low power consumption, a Bluetooth mesh network can support thousands of devices working simultaneously. So, no matter if you are at home or in the office, you can always run a large number of connected smart devices at the same time. As a result, Bluetooth mesh smart products provide a full range of conveniences for living and working without worrying about high energy costs. In the smart home, Bluetooth lowers the threshold of using smart home devices with its low power consumption, high compatibility, and high-security characteristics, providing a lower cost, more user-friendly, and smarter home experience. Without the user's permission, the Bluetooth signal will not be able to connect and track any device, protecting the user's privacy.

Erläuternde Legende zum Verwendungszweck des Produkts / Explanatory legend of the product's intended use

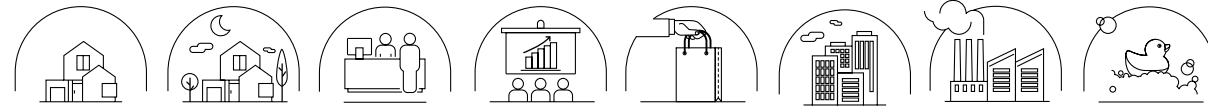

Hausgebrauch / domestic use
 Außengebrauch / outdoor use
 Beherbergungsbetriebe / accommodation areas use
 Büros / office use
 Gewerbliche Bereiche / commercial areas
 Städtische Nutzung / urban use
 Industrieanwendungen / industrial use
 Badezimmer / bathroom use



Eingebaute SMD-LED / Built-in SMD LED



Eingebaute COB-LED / Built-in COB LED



Produkt mit hoher Lichtausbeute / High luminous efficiency product



RGB-Produkt / RGB product
 RGB+UV-Produkt / RGB+ UV product
 RGB+W+UV-Produkt / RGB+white+UV product



RAINBOW-Produkt / RAINBOW product



CCT-Produkt (dynamisches Weiß) / Adjustable white



Auswählbare Farbtemperatur (2700K 3000K 4000K) / Interner Schalter zur individuellen Kelvin-Auswahl / Selectable color temperature (2700K 3000K 4000K) / Internal switch for customization of Kelvin



Auswählbare Farbtemperatur (3000K 4000K 6000K) / Interner Schalter zur individuellen Kelvin-Auswahl / Selectable color temperature (3000K 4000K 6000K) / Internal switch for customization of Kelvin



Auswählbare Farbtemperatur (3000K 4000K) / Interner Schalter zur individuellen Kelvin-Auswahl / Selectable color temperature (3000K 4000K) / Internal switch for customization of Kelvin



3-Step-CCT Regulierung von warmem, natürlichem, kaltem Licht. Speicherfunktion mittels Wandschalter / 3 step CCT Warm, natural and cold light control. Memory function by means of a wall switch



Touch-Dimmer Regulierbare Lichtstärke / Touch dimmer Dimmable light intensity



Touch-Step-Dimmer Touch-Schalter mit 3 Helligkeitsstufen / Touch step dimming Step - 3 step brightness touch switch



3-Step-DIM Die 3-Step-Dimmer gestatten die Regulierung der Beleuchtungsstärke über den Wandschalter / 3 step DIM 3 step dimming function: modulation of light intensity by wall switch



Dimmer Einstellbare Helligkeit mit Fernbedienung / Dimming Adjustable brightness with remote control



Standard-Dimmungstechnologie mit Phasenanschnitt (normalerweise Leading Edge) mit einer Einstellung, die das gesamte Intervall von 1% bis 100% abdeckt / Standard phase-cut dimming technology (typically Leading Edge), with adjustment covering the entire range from 1% to 100%.



Dimming mit spezifischem Phasenanschnitt für elektronische Lasten mit Kleinspannung (ELV), mit einem sehr präzisen Bereich von 1% bis 100% / Phase-cut dimming specifically for low voltage (ELV) electronic loads, with a very precise range from 1% to 100%.



Phasenanschnittsteuerung mit einem garantierten Dimmbereich zwischen 10% und 100% / Phase-cut adjustment with a guaranteed dimming range from 10% to 100%.



Steuerung der Helligkeit durch Betätigen einer Taste / Brightness control at the touch of a button.



System, das zur Steuerung der Lichtstärke ein Gleichstromsignal zwischen 1V und 10V verwendet / A system using a DC signal between 1V and 10V to control light intensity.

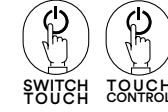

Eingebauter Touch-Schalter / Built-in touch switch



Farbwiedergabeindex / Colour rendering index

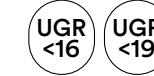

UGR ist ein von der CIE (Internationale Beleuchtungskommission) entwickelter, international standardisierter Index zur Bewertung der direkten Blendung durch die Beleuchtungsanlage. Die europäische Norm über die Beleuchtung von Arbeitsstätten in Innenbereichen **UNI-EN 12464-1** schreibt einen spezifischen UGR-Wert für jedes Gerät zwischen **10 und 30 vor: je niedriger der Wert, desto geringer die Blendung** / UGR is an international unified data, developed by CIE (commission international de l'Enclaireage) for the evaluation of the glaring degree of the light sources. The European norme for the lighting of te specifical working place **UNI-EN 12464-1** requires a value UGR for every application, included between **10 and 30: lower is the value, lower is the anti glare ratee.**

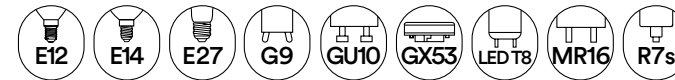

Lichtquelle / Light source

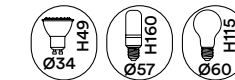

Empfohlene Glühbirnengröße / Recommended bulb size



Notleuchte / Emergency light



Sonnenenergieprodukt / Solar energy product



Begehbar / Walkable max 2000kg



Indoor- und Outdoor-Produkt / Indoor e outdoor product



Bluetooth-Verbindung / Bluetooth connection



Streichbarer Gips / Gypsum paintable



Zement / Concrete



Schallabsorbierendes System / Sound-absorbing system



Schwimmendes Produkt / Floating product



Korrosionsfreies Produkt / Corrosion-free



Einbauleuchten: asymmetrischer Lichtstrahl / Recessed lamps: description of asymmetrical light emission type

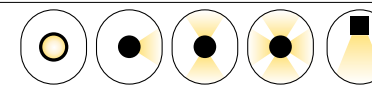

Einbau- und Orientierungsleuchten: Lichtstrahlrichtung / Inground and walk lights: description of light emission type



Deckenleuchten: Lichtstrahlrichtung / Ceiling lamps: description of light emission type

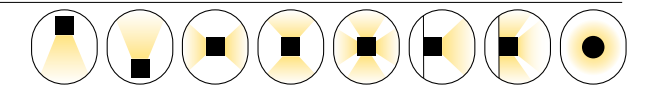

Wandleuchten: Lichtstrahlrichtung / Wall lamps: description of light emission type

SCHUTZART / IP PROTECTION RATE



IP-Klasse / IP Class

Alle im Katalog enthaltenen Produkte ohne spezifische IP-Schutzart sind als IP20 zu verstehen.

All items in the catalogue without IP rating specific are IP20.



Schutz gegen feste Fremdkörper
Protection against solid bodies

0
Kein Schutz /
No protection

1
Geschützt gegen feste Fremdkörper mit Durchmesser über 50 mm /
Protected against solid bodies larger than 50 mm

2
Geschützt gegen feste Fremdkörper mit Durchmesser über 12 mm /
Protected against solid bodies larger than 12 mm

3
Geschützt gegen feste Fremdkörper mit Durchmesser über 2,5 mm /
Protected against solid bodies larger than 2,5 mm

4
Geschützt gegen feste Fremdkörper mit Durchmesser über 1 mm /
Protected against solid bodies larger than 1 mm

5
Geschützt gegen Staub in schädigender Menge /
Protected against dust no harmful deposit

6
Staubdicht /
Completely protected against dust

Schutz gegen Flüssigkeiten
Protection against liquids

0
Kein Schutz /
No protection

1
Schutz gegen Tropfwasser /
Protected against vertically-falling drops of water

2
Schutz gegen fallendes Tropfwasser, wenn das Gehäuse bis zu 15° geneigt ist /
Protected against drops of water falling at up to 15° from the vertical

3
Schutz gegen fallendes Tropfwasser, wenn das Gehäuse bis zu 60° geneigt ist /
Protected against drops of water falling at up to 60° from the vertical

4
Gegen Wassertropfen aus allen Richtungen geschützt /
Protected against projections of water from all directions

5
Schutz gegen Strahlwasser aus beliebigem Winkel /
Protected against jets of water from all directions

6
Schutz gegen starkes Strahlwasser /
Protected against jets of water of similar force heavy seas

7
Schutz gegen zeitweiliges Untertauchen /
Protected against the effects of immersion

8
Schutz gegen dauerndes Untertauchen /
Protected against pro-longed the effects of immersion under pressure

Schutz gegen Wasser bei Hochdruck-/Dampfstrahlreinigung /
Protection against water in case of high-pressure/steam jet cleaning



IK-Klasse / IK Class

Schutzarten der Gehäuse für Elektrogeräte gegen äußere mechanische Beanspruchung
Degrees of protection for enclosures for electrical equipment against external mechanical impacts.

IK	Aufprallenergie (in Joule) / Impact energy (in Joules)
00	0
01	0,15
02	0,2
03	0,35
04	0,5
05	0,7
06	1
07	2
08	5
09	10
10	20

Schutzklasse / Appliance class

Die Schutzklassen stellen die von der IEC (International Electrotechnical Commission) festgelegte einheitliche Gruppierung der für ein Elektrogerät geltenden technischen Eigenschaften dar, um die Stromschlaggefahr durch einen Defekt desselben zu begrenzen.

The electrical insulation classes are the homogeneous grouping defined by the IEC (International Electrotechnical Commission) of the technical characteristics applicable to an electrical device to limit the risk of electrocution resulting from its failure.

I		Das Gehäuse dieser Geräte muss mittels eines getrennten Erdleiters an die Erdung angeschlossen sein / These appliance must have their chassis connected to electrical earth by a separate earth conductor
II		Diese Geräte sind so ausgelegt, dass kein Erdanschluss erforderlich ist / These appliance are designed in such a way that it does not require a safety connection to electrical earth
III		Diese Geräte sind darauf ausgelegt, von einer getrennten Sicherheitsstromquelle mit Kleinspannung versorgt zu werden / These appliance are designed to be supplied from a separated/safety extra-low voltage power source

LEGENDE DER SYMBOLE / LEGEND OF SYMBOLS

Zertifizierung und Bestimmungen / Certification and regulations

Alle unsere Produkte sind zertifiziert und entsprechen den geltenden EG-Standards /
All our products comply with CE norms and current European standards

EMV - Europäische Richtlinie über die elektromagnetische Verträglichkeit /
EMC - European electromagnetic compatibility directive

Dimmerbares Produkt /
Product dimmable

Nicht dimmerbares Produkt /
Product not dimmable

DALI - Digital Addressable Lighting Interface System zur Steuerung lichttechnischer Betriebsgeräte /
DALI - Digital Addressable Lighting Interface Domic lighting control system

Größe quadratische Öffnung für Deckeneinbau /
Square cut-out size for ceiling recessed lamps

Größe runde Öffnung für Deckeneinbau /
Round cut-out size for ceiling recessed lamps

Größe quadratische Öffnung für Wandeinbau /
Square cut-out size for wall recessed lamps

Größe runde Öffnung für Wandeinbau /
Round cut-out size for wall recessed lamps

System zur Steuerung lichttechnischer Betriebsgeräte/
Domotic lightingh control system



Das Protokoll DALI (Digital Addressable Lighting Interface) stellt eine der innovativsten und modernsten Lösungen im Bereich der Beleuchtung dar. Da es darauf ausgelegt ist, eine flexible und individuelle Steuerung der Beleuchtungsanlagen zu bieten, gestattet es DALI, die Lichtquellen in einer Vielzahl von Umgebungen auf intelligente und harmonische Weise zu verwalten, von Büros und Geschäften bis zu öffentlichen Räumen und Wohngebäuden.

Das Protokoll DALI stellt eine wirkungsvolle Antwort auf moderne Beleuchtungslösungen dar, da es Technologie, Flexibilität und Nachhaltigkeit vereint. Da es in der Lage ist, sich verschiedenen Situationen anzupassen und die Energieeffizienz zu verbessern, kommt DALI die Rolle eines unverzichtbaren Verbündeten für Planer, Architekten und Endverbraucher zu, die nach intelligenten und individuell gestalteten Beleuchtungslösungen Ausschau halten. Sich für DALI zu entscheiden bedeutet, in eine leuchtende und nachhaltige Zukunft zu investieren.

Unsere Kollektion umfasst eine ganze Reihe von Lösungen, darunter elegante Einbauleuchten, Strahler für Schienensysteme, professionelle Leuchten, Driver und vieles mehr. Jedes Produkt wird aus hochwertigen Materialien hergestellt und mit den neuesten Technologien ausgestattet, um eine individuell anpassbare und dynamische Beleuchtung zu garantieren.

The DALI system (Digital Addressable Lighting Interface) represents one of the most innovative and advanced solutions in the field of lighting. Designed to offer flexible and customizable control of lighting installations, DALI allows for the intelligent and harmonious management of light sources in a variety of settings, from offices and shops to public and residential spaces.

The DALI system is an effective response to modern lighting needs, combining technology, flexibility, and sustainability. With its ability to adapt to different situations and improve energy efficiency, DALI positions itself as an indispensable ally for designers, architects, and end-users seeking intelligent and personalized lighting solutions. Choosing DALI means investing in a bright and sustainable future.

Our collection includes a variety of solutions, including elegant recessed fixtures, track lighting, professional lamps, drivers, and much more. Each product is made with high-quality materials and equipped with the latest technologies to ensure customizable and dynamic lighting.



Das System DALI kommt in einer Vielzahl von Situationen zum Einsatz /
The DALI system finds application in a wide range of contexts.

Gleich, ob sie einladende Atmosphären zu Hause erzeugen, die Beleuchtung von Büros optimieren oder gewerbliche Räume aufwerten möchten, unsere Produktpalette mit dem Protokoll DALI bietet die Flexibilität und Kontrolle, die für alle Ihre Wünsche erforderlich sind. Erkunden Sie die unendlichen Beleuchtungsmöglichkeiten, die unser Katalog zu bieten hat, und erfahren Sie, wie unsere Produkte Ihre Räume in außerordentliche Umgebungen verwandeln können.

Whether you wish to create cozy atmospheres at home, optimize lighting in offices, or enhance commercial spaces, our DALI range offers the flexibility and control necessary to realize your vision. Explore the endless lighting possibilities that our catalog has to offer and discover how our products can transform your spaces into extraordinary environments.



BÜROS:
Schaffung von angenehmen und produktiven Arbeitsumgebungen anhand adaptiver Beleuchtung.

OFFICES:
creating comfortable and productive work environments through adaptive lighting.



GESCHÄFTE UND SHOWROOMS:
Möglichkeit der Hervorhebung von Produkten und Räumen durch strategische Beleuchtungsszenarien.

STORES AND SHOWROOMS:
the ability to highlight products and spaces with strategic lighting scenarios.



ÖFFENTLICHE RÄUME:
Beleuchtung von öffentlichen Bereichen auf sichere und einladende Weise unter Verbesserung der Besuchererfahrung.

PUBLIC SPACES:
safely and warmly illuminate public areas, enhancing the visitor experience.



WOHNGEBÄUDE:
Individuell gestaltete Beleuchtungslösungen zur Verbesserung von Komfort und Ästhetik von Wohnumgebungen.

RESIDENTIAL:
customized lighting solutions to improve the comfort and aesthetics of home environments.

DALI, Haupteigenschaften /
DALI, main features

1. Digitale Adressierbarkeit
Jedes DALI-Gerät kann einzeln adressiert werden und gestattet so eine präzise Steuerung jedes Geräts. Dies gestattet es, individuell gestaltete Beleuchtungsszenarien zu schaffen und die Beleuchtungsstärke bereichsspezifisch zu steuern.

2. Mühelose Installation und Konfiguration
Das System DALI verwendet eine einfache und standardisierte Verkabelung und senkt so die Installationskosten und vereinfacht die Konfiguration. Die Möglichkeit, bis zu 64 Geräte an einen einzigen Bus anzuschließen, macht DALI extrem skalierbar.

3. Interoperabilität.
DALI ist ein offener Standard, was bedeutet, dass die Geräte verschiedener Hersteller problemlos zusammen betrieben werden können. Dies bietet den Benutzern die Freiheit, die für ihre jeweiligen Anforderungen am besten geeigneten Komponenten zu wählen.

4. Hochmoderne Steuerung
Mit DALI ist es möglich, hochmoderne Steuerungsfunktionen zu implementieren, wie Dimmer, Programmierung von Szenarien und Synchronisation mehrerer Geräte. Dies gestattet es, die Beleuchtung abhängig von den spezifischen Anforderungen der Benutzer und Umgebungsbedingungen zu optimieren.

1. Digital Addressability.
Each DALI device can be individually addressed, allowing precise control of each unit. This enables the creation of customized lighting scenarios and the ability to manage light intensity specifically for each area.

2. Ease of Installation and Configuration.
The DALI system utilizes simple, standardized wiring, reducing installation costs and simplifying configuration. The ability to connect up to 64 devices on a single bus makes DALI highly scalable.

3. Interoperability.
DALI is an open standard, meaning devices from different manufacturers can work together seamlessly. This offers users the freedom to choose the components that best meet their needs.

4. Advanced Control.
With DALI, it is possible to implement advanced control functions, such as dimming, scenario programming, and synchronization between multiple devices. This allows for optimizing lighting according to specific user requirements and environmental conditions

- 026 **Wandleuchten /
Wall lamps**
- 128 **Deckenleuchten /
Ceiling lamps**
- 160 **Kombinierte wand-, Hänge- und bodenleuchten /
Wall, suspension and floor lamps combined**
- 250 **Aufladbare Tischleuchten /
Rechargeable table lamps**
- 264 **Einbau- und Orientierungsleuchten /
Inground and walk lights**
- 306 **Solarleuchten /
Solar lamps**
- 318 **Flutlichtleuchten /
Flood lights**
- 352 **Strassenleuchten /
Street lights**
- 372 **Easy
Domotic 24V**
- 382 **Technische DMX-Dekorleuchten /
DMX Technical Decoration Lighting**
- 410 **Beleuchtungskomponenten /
Lighting Components**

Outdoor
**Wandleuchten /
Wall lamps**

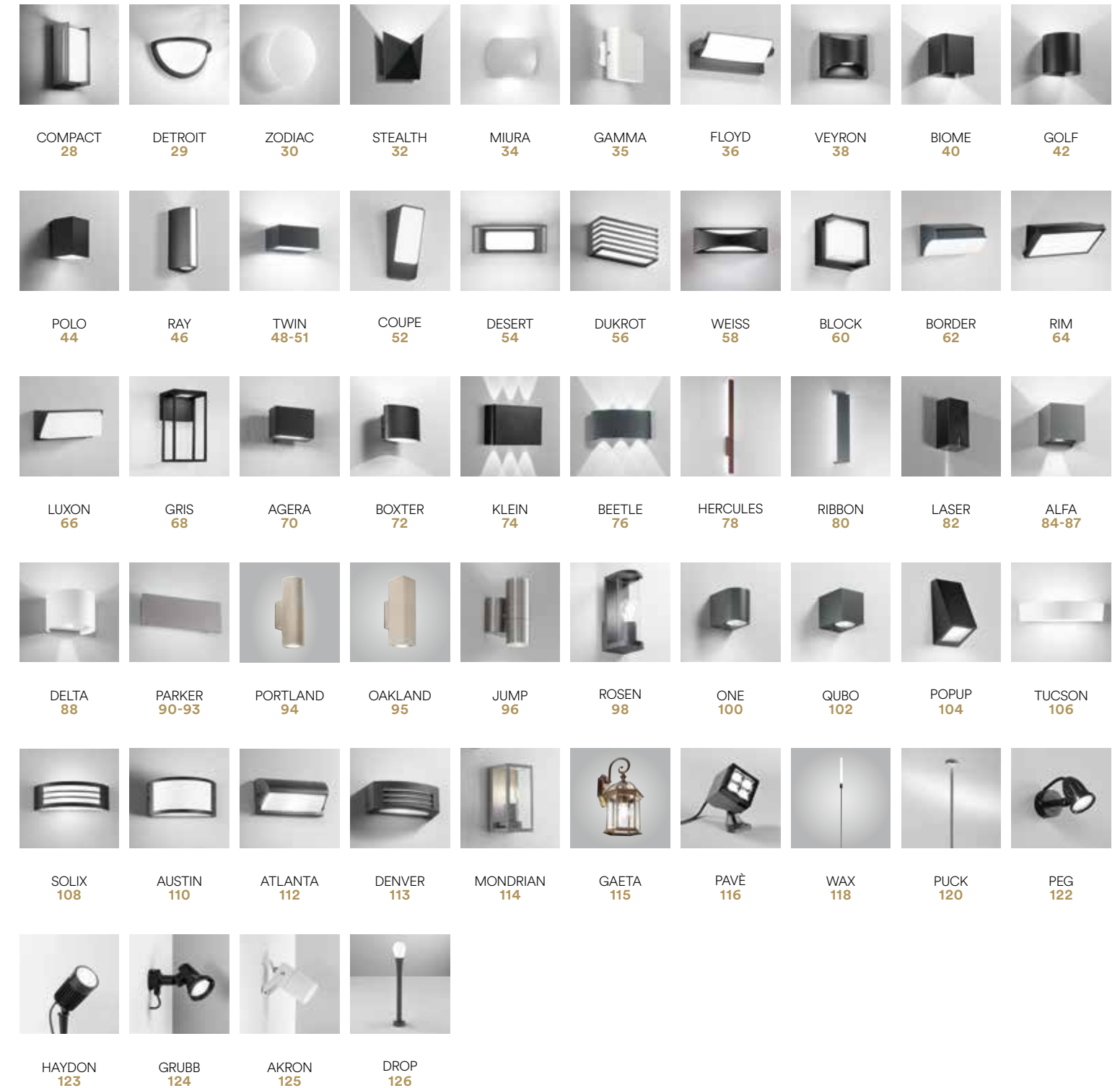

Outdoor
**Deckenleuchten /
 Ceiling lamps**

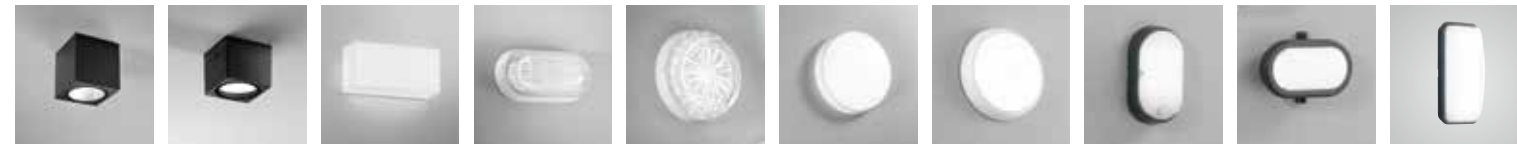

CITIZEN 130 TOWER 132 TOGO 134 ISCHIA 136 CAPRI 137 ALWAYS 138 HUBLOT SENS 139 SENSITIVE 140 EXTRA 142 SHELLY 144



EVER Q 146 EVER LP 148 EVER S 149 EVER XL 150 SPEEDY 152 FLIPPY 153 ALYCE 154 TURTLE 156-159

Outdoor
**Kombinierte wand-, Hänge- und bodenleuchten /
 Wall, suspension and floor lamps combined**



KHALIFA 162 NEEDLE 164 LUMINA 166 WAMI 168 MOBULA 170 SAIL 172 DISCOVERY 174-177 IDEM 178 REVERSE 180 BITT 182



NISMO 184 BOOSTER 186 UNDERWOOD 188 FOCUS 190 DARK 192 TOKYO 194-197 STATION 198 MIRAGE 200 SKITTLE 202 ASSISI 204



ROMA 206-208 MILANO 209-211 FIRENZE 212 SANTIAGO 214 VENEZIA 216 PAVIA 218 DALI BRIGHTMAX 220 POLLY 222-225 POLLY accessories 226-229 GECO DJ 230

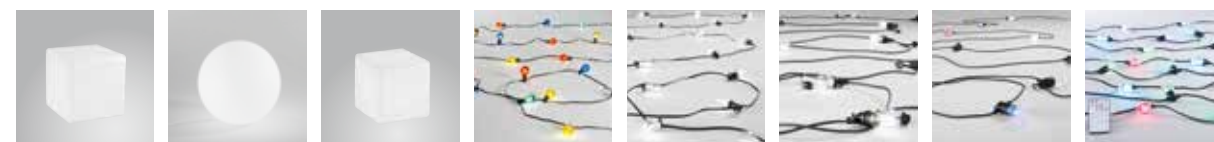

GECO LED 232 GECO E27 234-239 solar GECO LED 240 PICNIC COLOR 242 PICNIC LED 244 PICNIC E27 245 WI-FI SMART INTEC PICNIC INT 246 WI-FI SMART INTEC PICNIC RGB 248

Outdoor
**Aufladbare Tischleuchten /
 Rechargeable table lamps**



COCKTAIL 256 JIN 258-261 ROBIN 262

Outdoor
**Einbau- und Orientierungsleuchten /
 Inground and walk lights**



RIDER 266-268 BARRET 269 SUBWAY 270 EASY BOMOTICA IMPACT 271 EASY BOMOTICA STEP 272 ELMO 274 WALK 276-279 DECK 280 GROUND 282 HUMMER 284



DRIVE 286 OASIS 288 STEPLIGHT 290 SHELBY 291 ONYX 292 STRATOS 294-297 SLAB 298 BREEN 300 SMILE 302 BOLT 304

Outdoor
**Solarleuchten /
 Solar lamps**



MAEVE 308 GIZAH 310 IRIS 312 NASA 313 GLASER 314 LUXOR 316

Outdoor
Flutlichtleuchten /
Flood lights

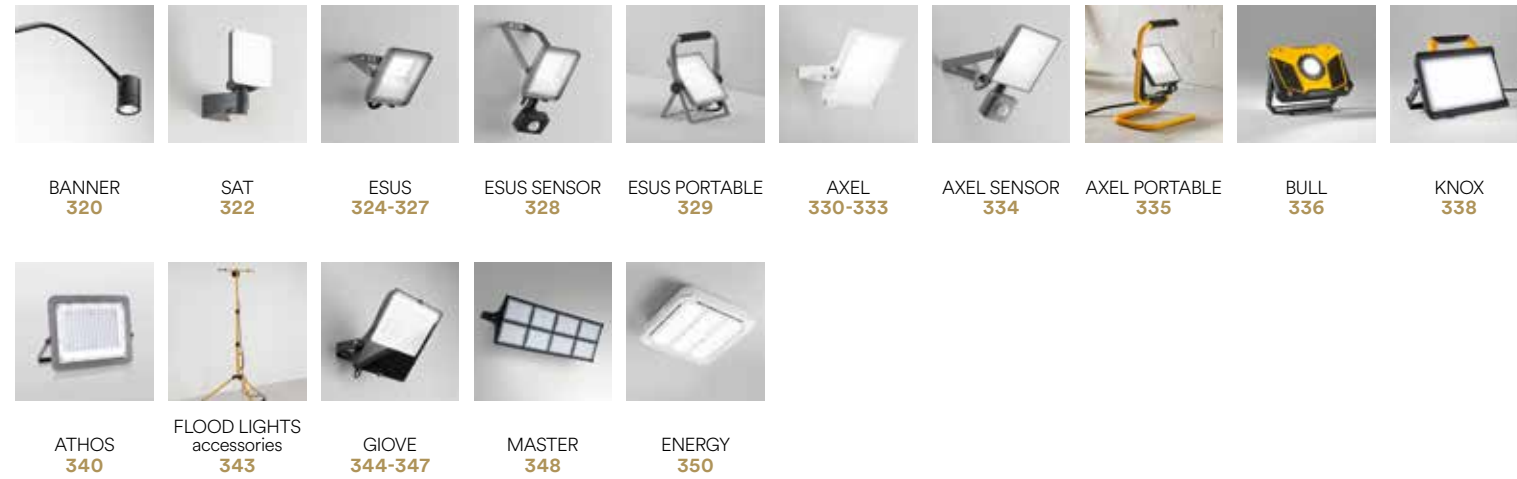

Outdoor
Strassenleuchten /
Street lights



Decorative
Easy Domotic 24V



Decorative
Technische DMX-Dekorleuchten /
DMX Technical Decoration Lighting

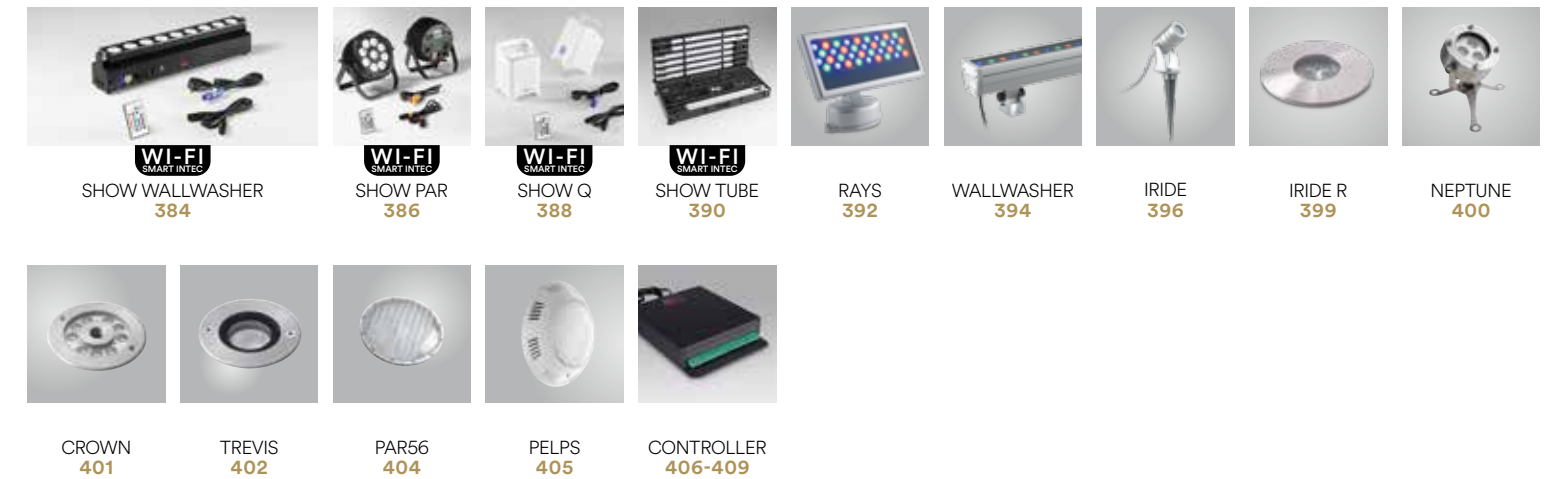

Zubehör / Accessories
Beleuchtungskomponenten /
Lighting components

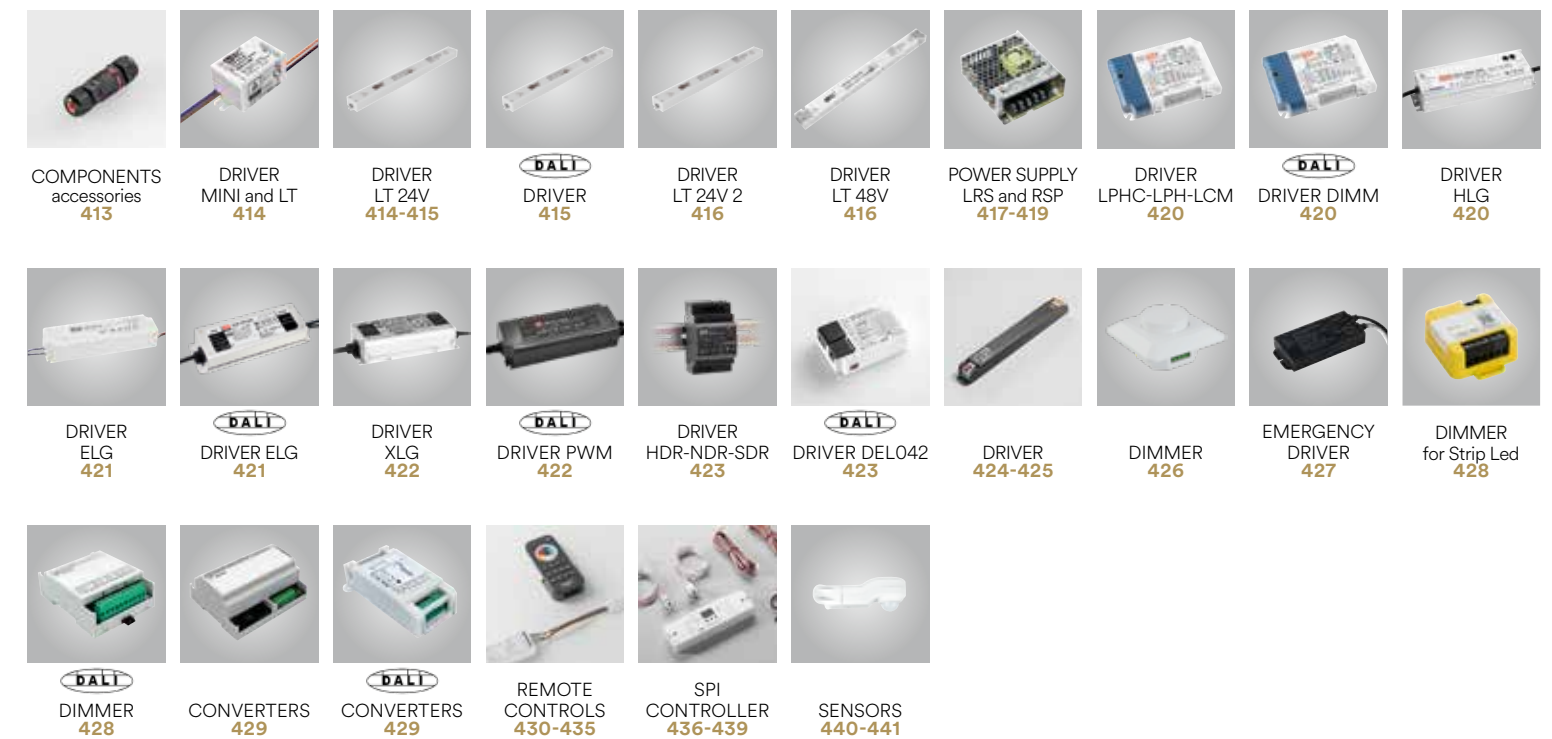

ALPHABETISCHES VERZEICHNIS / ALPHABETICAL INDEX

Artikel / article	Seite / page
AGERA	70
AGILITY Easy Domotica 24V	376
AKRON	125
ALFA	84
ALFA	86
ALWAYS	138
ALYCE	154
ASSISI	204
ATHOS	340
ATLANTA	112
AUREUS	354
AUSTIN	110
AXEL	330-333
AXEL PORTABLE	335
AXEL SENSOR	334
BANNER	320
BARRET	269
BEETLE	76
BIOME	40
BITT	182
BLOCK	60
BOLT	304
BOOSTER	186
BORDER	62
BOXTER	72
BREEN	300
BRIGHTMAX	220
BULL	336
CAPRI	137
CITIZEN	130
COCKTAIL	256
COMPACT	28
CONTROLLER DMX Technical Decoration Lighting	406-409

Artikel / article	Seite / page
CONVERTERS Lighting Components	429
COUPE	52
CROWN	401
DARK	192
DECK	280
DELTA	88
DENVER	113
DESERT	54
DETROIT	29
DIMMER Lighting Components	426, 428
DISCOVERY	174-177
DRIVE	286
DRIVER Lighting Components	414-416, 420-425, 427
DROP	126
DUKROT	56
ELMO	274
ENERGY	350
ESUS	324- 327
ESUS PORTABLE	329
ESUS SENSOR	328
EVER	146-150
EXPO	368
EXTRA	142
FEBO	358
FIRENZE	212
FLIPPY	153
FLOOD LIGHTS Accessories	343
FLOYD	36
FOCUS	190
GAETA	115

Artikel / article	Seite / page
GAMMA	35
GECO DJ	230
GECO E27	234-239
GECO LED	232
GECO LED SOLAR	240
GIOVE	344 -347
GIZAH	310
GLASER	314
GOLF	42
GRIS	68
GROUND	282
GRUBB	124
HAYDON	123
HERCULES	78
HIGHWAY	366
HUBLOT SENS	139
HUMMER	284
IDEM	178
IMPACT	271
IPERION	360
IRIDE	396-399
IRIS	312
ISCHIA	136
JIN	258-261
JUMP	96
KHALIFA	162
KLEIN	74
KNOX	338
LASER	82
LUMINA	166
LUXON	66
LUXOR	316
MAEVE	308
MASTER	348
MILANO	209-211

Artikel / article	Seite / page
MIRAGE	200
MIURA	34
MOBULA	170
MONDRIAN	114
NASA	313
NEEDLE	164
NEPTUNE	400
NISMO	184
OAKLAND	95
OASIS	288
ONE	100
ONYX	292
PAR56	404
PARKER	90
PARKER	93
PAVÈ	116
PAVIA	218
PEG	122
PELPS	405
PICNIC	244
PICNIC COLOR	242
PICNIC INT	246
PICNIC RGB	248
POLLY	222-225
POLLY Accessories	226-229
POLO	44
POPOP	104
PORTLAND	94
POWER SUPPLY Lighting Components	417-419
PUCK	120
QUBO	102
QUICK Easy Domotica 24V	378

Artikel / article	Seite / page
RADIUS	356
RAY	46
RAYS	392
REMOTE CONTROL Lighting Components	430-435
REVERSE	180
RIBBON	80
RIDER	266-268
RIM	64
ROADWAY	362
ROBIN	262
ROMA	206-208
ROSEN	98
RUNNER Easy Domotica 24V	381
SAIL	172
SANTIAGO	214
SAT	322
SENSITIVE	140
SENSORS Lighting Components	440-441
SHELBY	291
SHELLY	144
SHOW PAR	386
SHOW Q	388
SHOW TUBE	390
SHOW WALLWASHER	384
SKITTLE	202
SLAB	298
SMILE	302
SOLIX	108
SPEEDY	152
SPI CONTROLLER Lighting Components	436-439

Artikel / article	Seite / page
SPRINT Easy Domotica 24V	380
STATION	198
STEALTH	32
STEP	272
STEPLIGHT	290
STRATOS	294-297
STREETWAY	364
SUBWAY	270
TARGET Easy Domotica 24V	375
TOGO	134
TOKYO	194-197
TOWER	132
TREVIS	402
TUCSON	106
TURTLE	156-159
TWIN	48
TWIN	51
UNDERWOOD	188
VENEZIA	216
VEYRON	38
VILLA	370
WALK	276-279
WALLWASHER	394
WAMI	168
WAX	118
WEISS	58
ZODIAC	30



Wandlampen / Wall lamps
outdoor

COMPACT

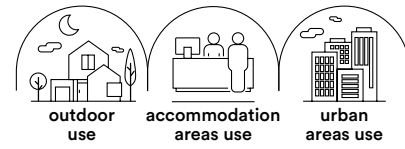

LED-Wandleuchte mit Diffusor aus Polycarbonat und anthrazitfarbenem Aluminiumgehäuse. Artikel für Innen- und Außenbereiche mit Schutz gegen Festkörper und Flüssigkeiten, hoher Stoßfestigkeit und Einstellung der Lichttemperatur.
LED wall lamp with polycarbonate diffuser and anthracite aluminium fixture. A product for indoor and outdoor use with protection against solid objects and liquids, high impact resistance and light temperature adjustment.



DETROIT



LED-Wandleuchte mit schwarzem Aluminiumgehäuse und Diffusor aus Polycarbonat. Aus hochfesten Materialien hergestellt, bietet zwei Farbtemperaturen mit hervorragender Farbwiedergabe.
LED wall lamp with black aluminium fixture and polycarbonate diffuser. Made of highly resistant materials, it features two colour temperatures with excellent colour rendering.



Material
Aluminium + Polycarbonat

Farbe
Anthrazit

Wählbare Farbtemperatur
3000K / 4000K



Driver
inklusive

Material
aluminum + polycarbonate

Colour
anthracite

Selectable color temperature
3000K / 4000K



Driver
included



LED-W-COMPACT
8031414867110
FANEU00007728
lumen

colour temp.	colour

2260 lm

watt	18W
beam angle	120°

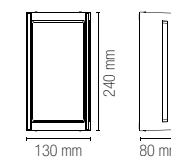

Material
Aluminium + Polycarbonat

Farbe
schwarz

Wählbare Farbtemperatur
3000K / 4000K



Driver
inklusive

Material
aluminum + polycarbonate

Colour
black

Selectable color temperature
3000K / 4000K



Driver
included



LED-W-DETROIT-AP
8031414862290
FANEU00007748
lumen

colour temp.	colour

1320 lm

watt	10W
beam angle	120°



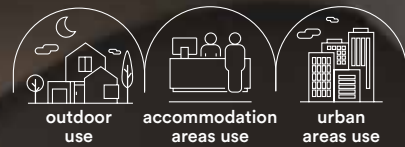

LED-Beleuchtung auf 360°, Gehäuse aus weißem oder schwarzem Polycarbonat. Aus korrosionsfesten Materialien hergestellt, garantiert Zodiac einen hohen Schutz gegen Festkörper und Flüssigkeiten, einstellbare Farbtemperatur und hervorragende Farbwiedergabe.
 360° LED lighting, white or black polycarbonate fixture. Made of anti-corrosive materials, Zodiac guarantees high protection against solid objects and liquids, adjustable colour temperature and excellent colour rendering.

- Material**
PC
- Farbe**
Weiß
Schwarz
- Wählbare Farbtemperatur**
3000K / 4000K
- Driver**
eingebaut
- Material**
PC
- Colour**
white
black
- Selectable color temperature**
3000K / 4000K
- Driver**
built-in

		LED-W-ZODIAC-M-BCO 8031414889846 FANEU00007875 lumen	colour temp.	colour
			1550 lm	
		LED-W-ZODIAC-M-NER 8031414889853 FANEU00007876 lumen	colour temp.	colour
			1550 lm	
		watt	12W	
		beam angle	360°	
			Ø 180 mm 47 mm	

		LED-W-ZODIAC-L-BCO 8031414889860 FANEU00007873 lumen	colour temp.	colour
			2450 lm	
		LED-W-ZODIAC-L-NER 8031414889877 FANEU00007874 lumen	colour temp.	colour
			2450 lm	
		watt	18W	
		beam angle	360°	
			Ø 250 mm 47 mm	

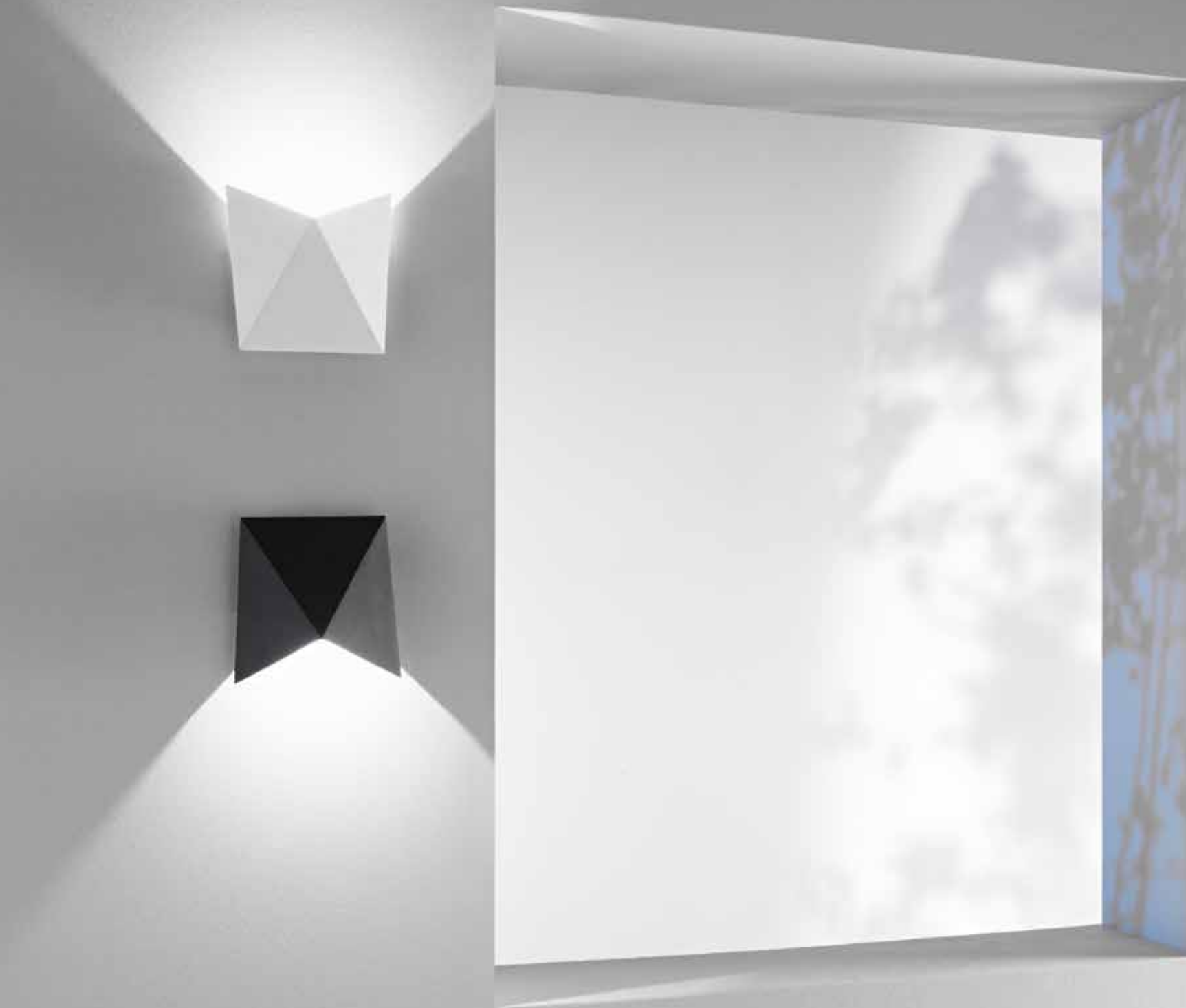

- Material**
Aluminium
- Farbe**
Geprägt, Weiß
Geprägt, Schwarz
- Wählbare Farbtemperatur**
3000K / 4000K
- Driver**
inklusive
- Material**
aluminum
- Colour**
embossed white
embossed black
- Selectable color temperature**
3000K / 4000K
- Driver**
included

LED-Wandleuchte aus geprägtem Aluminium, erhältlich in den Farbtönen Weiß oder Schwarz. Das unvergängliche Profil macht sie ideal für Innen- und Außenbereiche sowie für den Einsatz in Beherbergungsbetrieben und städtischen Umgebungen.

LED wall lamp in embossed aluminium available in white or black. Its iconic profile makes it ideal for indoor and outdoor spaces, such as hospitality facilities and urban areas.

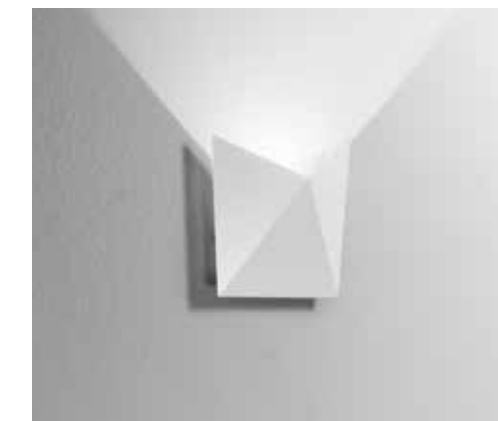

	colour temp.	colour
LED-W-STEALTH BCO 8031414866960 FANEU00007841 lumen		
	580 lm	
watt	6W	
beam angle	120°	

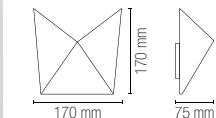

	colour temp.	colour
LED-W-STEALTH NER 8031414866953 FANEU00007842 lumen		
	580 lm	
watt	6W	
beam angle	120°	

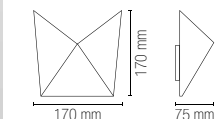

MIURA

Minimalistisches Design, das in dem extrem schmalen Profil des Gehäuses aus geprägtem weißem Aluminium und einem sanften doppelten Lichtstrahl zum Ausdruck kommt. Mit hocheffizienter LED, zwei Farbtemperaturen und hervorragender Farbwiedergabe.

Minimalist design achieved with the ultra-thin profile of the white embossed aluminium fixture and subtle dual emission. With high-efficiency LED, dual colour temperatures and excellent colour rendering.



GAMMA

Gamma besteht vollkommen aus Aluminium und zeichnet sich durch die weichen Linien des Frontgehäuses und das weiße geprägte Finish aus. Mit warmem und neutralem Lichtfarbton, um Außenbereiche in der Stadt oder in Wohngebieten zu beleuchten und zu gestalten.

Made entirely of aluminium, Gamma is striking with the smooth lines of its front fixture and white embossed finish. With warm and neutral colour temperatures to illuminate and decorate urban or residential outdoor spaces.



In.tec light WANDLAMPEN / WALL LAMPS

Material
Aluminium

Material
aluminium

Farbe
Geprägt, Weiß

Colour
embossed white

Wählbare Farbtemperatur
3000K / 4000K

Selectable color temperature
3000K / 4000K



Driver
inklusive

Driver
included



LED-W-MIURA/6W
8031440351447
FANEU00007803
lumen

colour temp.	colour
520 lm	

watt	2 x 3W
beam angle	↓ 110° + 110° ↑

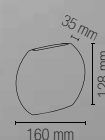

Material
Aluminium

Material
aluminum

Farbe
Geprägt, Weiß

Colour
embossed white

Wählbare Farbtemperatur
3000K / 4000K

Selectable color temperature
3000K / 4000K



Driver
inklusive

Driver
included



LED-W-GAMMA/10W
8031434041217
FANEU00007769
lumen

colour temp.	colour
1100 lm	

watt	2 x 5W
beam angle	↓ 120° + 120° ↑

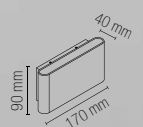

FLOYD

In Mattweiß oder in elegantem Anthrazit verbindet Floyd den ästhetischen Blickfang mit der Zweckmäßigkeit des verstellbaren Diffusors. Mit hervorragenden technischen Spezifikationen für maximale Lebensdauer und Beständigkeit in Außenumgebungen.

Floyd, in matt white or sophisticated anthracite, combines aesthetic appeal with a practical adjustable diffuser. With excellent technical specifications for maximum durability and resistance in outdoor environments.



Technische Informationen / Technical information **FLOYD**



Material

Aluminium + PC

Farbe

Mattweiß
Anthrazit



Wählbare Farbtemperatur

2700K / 3300K / 4000K



Driver

inklusive

Material

aluminum + PC

Colour

matt white
anthracite



Selectable color temperature

2700K / 3300K / 4000K



Driver

included



	colour temp.	colour
LED-FLOYD-AP-BCO 8031414931460 FANEU00027332 lumen	3300 lm	

watt	25W
beam angle	100°

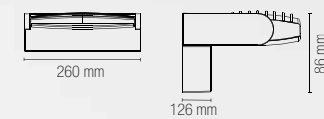

	colour temp.	colour
LED-FLOYD-AP-ANT 8031414931521 FANEU00027331 lumen	3300 lm	

watt	25W
beam angle	100°

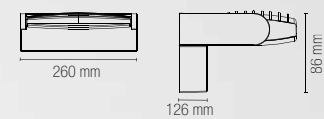



Material
Aluminium

Farbe
Geprägt, Weiß
Geprägt, Schwarz



Wählbare Farbtemperatur
3000K / 4000K



Driver
inklusive

Material
aluminium

Colour
embossed white
embossed black



Selectable color temperature
3000K / 4000K



Driver
included

LED-Wandleuchte aus geprägtem Aluminium in Weiß oder Schwarz. Mit doppeltem Lichtstrahl, doppelter Farbtemperatur und hoher Farbwiedergabe, für eine gleichermaßen technische wie ästhetische Beleuchtung.

LED wall lamp in black or white embossed aluminium. It features dual emission, dual colour temperature and high colour rendering, for a technical and aesthetic lighting solution.



	colour temp.	colour
LED-W-VEYRON BCO		
8031440361163		
FANEU00007864		
lumen	840 lm	

watt	2 × 3,5W
beam angle	↓ 120° + 120° ↑

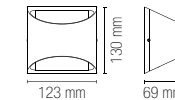

	colour temp.	colour
LED-W-VEYRON NERO		
8031440361095		
FANEU00007865		
lumen	840 lm	

watt	2 × 3,5W
beam angle	↓ 120° + 120° ↑

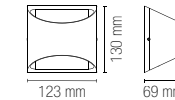



Material
Aluminium

Farbe
Geprägt, Weiß
Geprägt, Schwarz



Wählbare Farbtemperatur
3000K / 4000K



Driver
inklusive

Material
aluminium

Colour
embossed white
embossed black



Selectable color temperature
3000K / 4000K



Driver
included

COB-LED-Wandleuchte mit hervorragender Farbwiedergabe. Durch das geprägte Aluminium findet sie ihren Platz in modernen Außenbereichen, Wohngebieten mit minimalistischem Design oder als dekoratives Detail in städtischen Umgebungen.

COB LED wall lamp with excellent colour rendering. Made of embossed aluminium, it is perfect for modern outdoor spaces, minimalist residential areas or as a decorative detail in urban areas.



LED-W-BIOME BCO 8031440361125 FANEU00007714 lumen	colour temp.	colour
watt beam angle	2 × 3,5W ↓ 120° + 120° ↑	840 lm

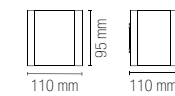

LED-W-BIOME NERO 8031440361132 FANEU00007715 lumen	colour temp.	colour
watt beam angle	2 × 3,5W ↓ 120° + 120° ↑	840 lm





Essenziell, doch mit Klasse. Golf bietet einen doppelten Lichtstrahl mit COB-LED in Kombination mit dem Aluminiumgehäuse mit geprägtem Finish.

Zwei Farbtemperaturen für eine optimale Farbtreue.

Minimalist yet sophisticated. Golf features COB LED dual emission combined with an aluminium fixture with an embossed finish. Dual colour temperatures for optimum colour fidelity.

Material
Aluminium

Farbe
Geprägt, Weiß
Geprägt, Schwarz



Wählbare Farbtemperatur
3000K / 4000K



Driver
inklusive

Material
aluminum

Colour
embossed white
embossed black



Selectable color temperature
3000K / 4000K



Driver
included



	colour temp.	colour
LED-W-GOLF BCO 8031440361101 FANEU00007772		
lumen	840 lm	

watt	2 × 3,5W
beam angle	↓ 120° + 120° ↑

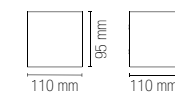

	colour temp.	colour
LED-W-GOLF NERO 8031440361118 FANEU00007773		
lumen	840 lm	

watt	2 × 3,5W
beam angle	↓ 120° + 120° ↑

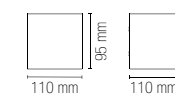



Material
PC

Farbe
Weiß
Schwarz



Wählbare Farbtemperatur
3000K / 4000K



Driver
inklusive

Material
PC

Colour
white
black



Selectable color temperature
3000K / 4000K



Driver
included



LED-Wandleuchte aus Polycarbonat mit einzelem oder doppeltem Lichtstrahl, erhältlich in Weiß oder Mattschwarz. Der Artikel verfügt über korrosionsabweisende Eigenschaften und hohen Schutz vor Staub und Wasserstrahlen.

LED wall lamp in polycarbonate with single or dual emission, available in matt black or white. The product has anti-corrosive properties and provides high protection against dust and water jets.

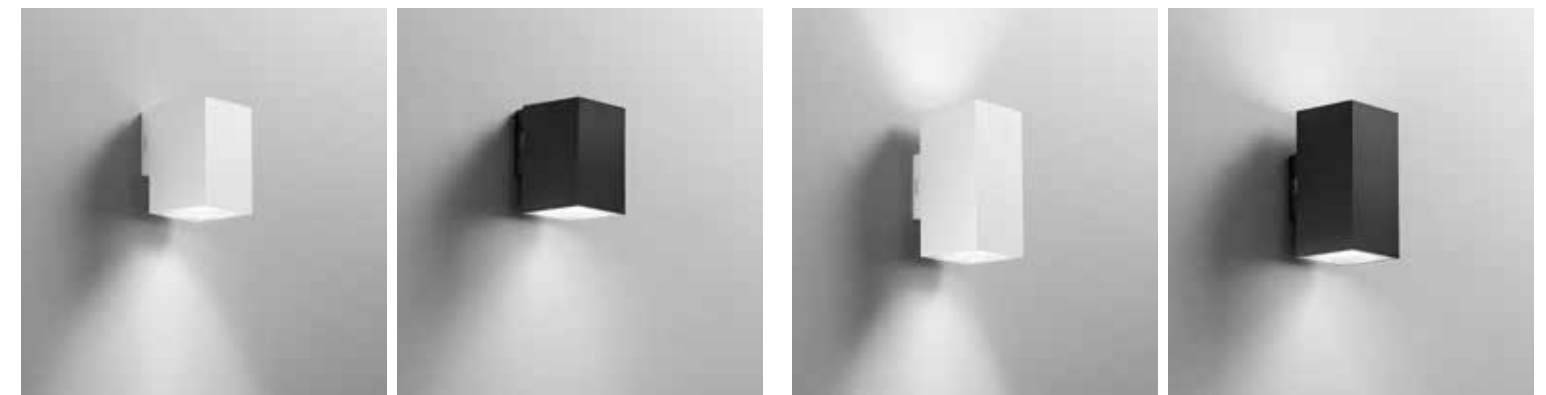

Model	colour temp.	colour	lumen	watt	beam angle	Dimensions
LED-W-POLO-Q1-BCO 8031414889655 FANEU00007818	3000K / 4000K	White	980 lm	8W	60°	99 mm x 78 mm x 116 mm
LED-W-POLO-Q1-NER 8031414889662 FANEU00007819	3000K / 4000K	White / Black	980 lm	8W	60°	99 mm x 78 mm x 116 mm
LED-W-POLO-Q2-BCO 8031414889679 FANEU00007820	3000K / 4000K	White	1960 lm	2 x 8W	↓ 60° + 60° ↑	99 mm x 78 mm x 160 mm
LED-W-POLO-Q2-NER 8031414889686 FANEU00007821	3000K / 4000K	White / Black	1960 lm	2 x 8W	↓ 60° + 60° ↑	99 mm x 78 mm x 160 mm

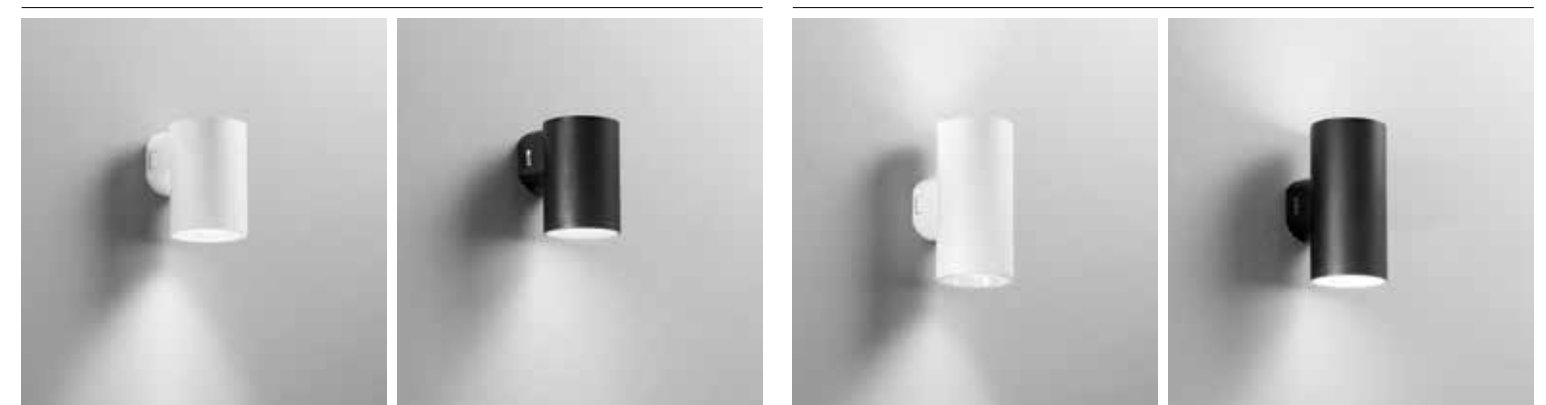

Model	colour temp.	colour	lumen	watt	beam angle	Dimensions
LED-W-POLO-R1-BCO 8031414889617 FANEU00007822	3000K / 4000K	White	980 lm	8W	60°	99 mm x 78 mm x 115 mm
LED-W-POLO-R1-NER 8031414889624 FANEU00007823	3000K / 4000K	White / Black	980 lm	8W	60°	99 mm x 78 mm x 115 mm
LED-W-POLO-R2-BCO 8031414889631 FANEU00007824	3000K / 4000K	White	1960 lm	2 x 8W	↓ 60° + 60° ↑	99 mm x 78 mm x 162 mm
LED-W-POLO-R2-NER 8031414889648 FANEU00007825	3000K / 4000K	White / Black	1960 lm	2 x 8W	↓ 60° + 60° ↑	99 mm x 78 mm x 162 mm



LED-Wandleuchte aus Aluminium mit doppeltem sowie frontalem Lichtstrahl in Anthrazit oder geprägtem Corten. Bietet hervorragenden Sehkomfort und höchsten Schutz vor mechanischen Einwirkungen.

LED wall lamp in aluminium with dual emission and front emission in anthracite or embossed corten. It provides excellent visual comfort and maximum protection against mechanical impacts.

Material
Aluminium

Farbe
Geprägt, Anthrazit
Geprägt, Corten



Wählbare Farbtemperatur
3000K / 4000K



Driver
inklusive

Material
aluminium

Colour
embossed anthracite
embossed corten



Selectable color temperature
3000K / 4000K



Driver
included



	colour temp.	colour
LED-W-RAY ANT 8031414867127 FANEU00007826		
lumen	1100+390 lm	

watt	14W
beam angle	↓ 50° + 50° ↑ + 120° →

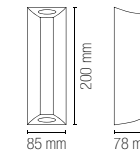

	colour temp.	colour
LED-W-RAY BRO 8031414870998 FANEU00007827		
lumen	1100+390 lm	

watt	14W
beam angle	↓ 50° + 50° ↑ + 120° →

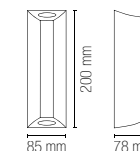

TWIN

LED-Wandleuchte aus Aluminium mit Finish in Weiß, Anthrazit oder gebürstetem Nickel. Mit Schalter für die Einstellung des Lichtfarbtons und darauf ausgelegt, eine hervorragende Beleuchtungssteuerung zu garantieren.

LED wall lamp in aluminium with white, anthracite or brushed nickel finish. Featuring a switch for adjusting the light colour temperature, it is designed to ensure superior lighting control.

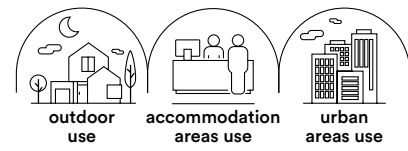

TWIN



- Material**
Aluminium
- Farbe**
Weiß
Anthrazit
Nickel, gebürstet
- Wählbare Farbtemperatur**
3000K / 4000K
- Driver**
inklusive
- Material**
aluminum
- Colour**
white
anthracite
brush nickel
- Selectable color temperature**
3000K / 4000K
- Driver**
included

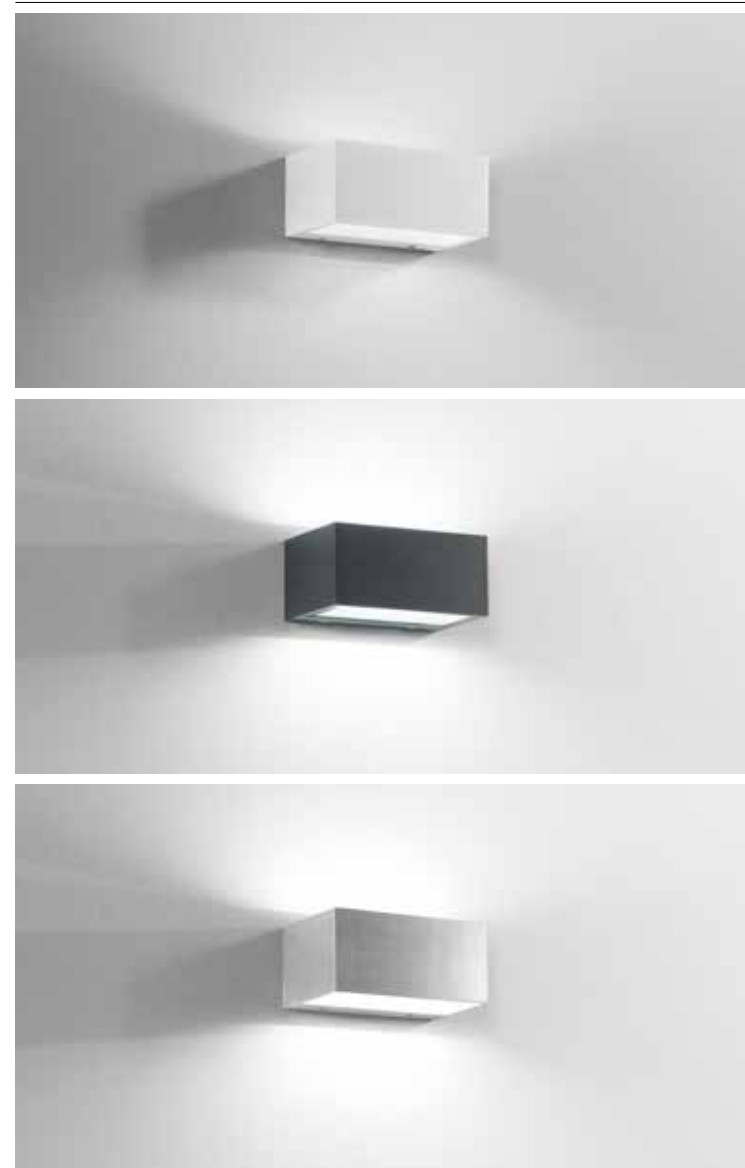

	colour temp.	colour
LED-W-TWIN-S BCO 8031414863976 FANEU00007854 lumen	3000K / 4000K	white
LED-W-TWIN-S ANT 8031414863709 FANEU00007853 lumen	3000K / 4000K	anthracite
LED-W-TWIN-S NIK 8031414863983 FANEU00007855 lumen	3000K / 4000K	brush nickel

watt 12W
beam angle ↓ 90° + 90° ↑

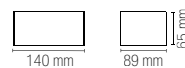

	colour temp.	colour
LED-W-TWIN-M BCO 8031414863969 FANEU00007849 lumen	3000K / 4000K	white
LED-W-TWIN-M ANT 8031414863693 FANEU00007848 lumen	3000K / 4000K	anthracite
LED-W-TWIN-M NIK 8031414863990 FANEU00007850 lumen	3000K / 4000K	brush nickel

watt 18W
beam angle ↓ 90° + 90° ↑



	colour temp.	colour
LED-W-TWIN-XL BCO 8031414863716 FANEU00007859 lumen	3000K / 4000K	white
LED-W-TWIN-XL ANT 8031414863686 FANEU00007858 lumen	3000K / 4000K	anthracite
LED-W-TWIN-XL NIK 8031414864362 FANEU00007860 lumen	3000K / 4000K	brush nickel

watt 35W
beam angle ↓ 90° + 90° ↑

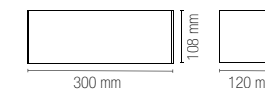



Material
Aluminium

Farbe
Geprägt, Weiß
Geprägt, Anthrazit
Geprägt, Corten



Farbtemperatur
3000K



Driver
inklusive

Material
aluminium

Colour
embossed white
embossed anthracite
embossed corten



Colour temperature
3000K



Driver
included

Die LED-Wandleuchte aus Aluminium Coupe bietet neben einer hervorragenden Farbtreue optimalen Schutz vor Staub und Flüssigkeiten. In drei Varianten - Weiß, Anthrazit und Bronze -, um sich harmonisch in den Stil der Außenbereiche einzufügen.

Coupe, a LED wall lamp in aluminium, features optimum protection against dust and liquids, as well as excellent colour fidelity. Available in three colour options – white, anthracite and bronze – to blend in harmoniously with the style of outdoor spaces.



	colour temp.	colour
LED-W-COUPE-BCO 8031414931644 FANEU00027321		
lumen	1950 lm	

watt	14W
beam angle	120°

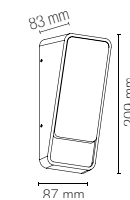

	colour temp.	colour
LED-W-COUPE-ANT 8031414931651 FANEU00027320		
lumen	1950 lm	

watt	14W
beam angle	120°

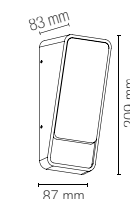

	colour temp.	colour
LED-W-COUPE-BRO 8031414931668 FANEU00027322		
lumen	1950 lm	

watt	14W
beam angle	120°

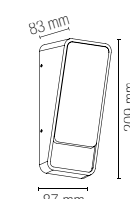



Material
Aluminium

Farbe
Geprägt, Weiß
Geprägt, Anthrazit
Geprägt, Corten



Farbtemperatur
3000K / 4000K



Driver
inklusive

Material
aluminium

Colour
embossed white
embossed anthracite
embossed corten



Colour temperature
3000K / 4000K



Driver
included

LED-Wandleuchte aus Aluminium mit doppeltem seitlichen Lichtstrahl und frontalem CCT-Lichtstrahl. Erhältlich in den eleganten Finishes Weiß, Anthrazit und Bronze, um sich elegant in Wohn-, Gewerbe- oder Stadtumgebungen einzufügen.

LED wall lamp in aluminium with dual emission at the side and CCT emission at the front. Available in an elegant white, anthracite and bronze finish to blend elegantly into residential, retail or urban areas.

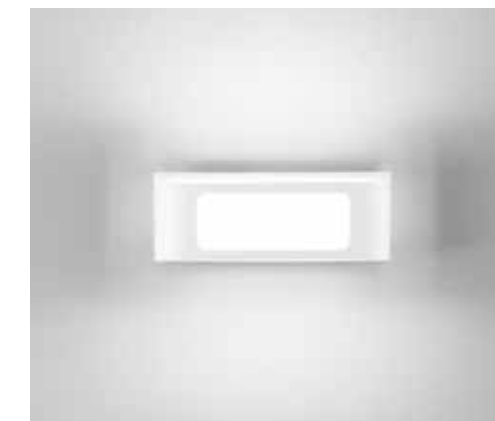

	colour temp.	colour
LED-W-DESERT-BCO 8031414922895 FANEU00027361		
lumen	1500 lm	

watt	12W
beam angle	120°

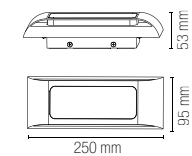

	colour temp.	colour
LED-W-DESERT-ANT 8031414922918 FANEU00027360		
lumen	1500 lm	

watt	12W
beam angle	120°

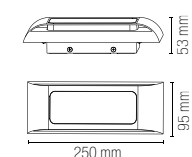

	colour temp.	colour
LED-W-DESERT-BRO 8031414922901 FANEU00027362		
lumen	1500 lm	

watt	12W
beam angle	120°

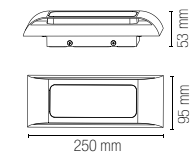



Wandleuchte aus Aluminium mit Diffusor aus Polycarbonat. Erhältlich in dem erlesenen Finish Corten, Anthrazit oder Mattweiß und mit individuell anpassbarer Farbtemperatur, um in Außen- wie Innenräumen die perfekte Beleuchtung und Atmosphäre zu schaffen.

Wall lamp in aluminium with polycarbonate diffuser. Available in a refined corten, anthracite or matt white finish, with a customisable colour temperature to create the perfect lighting and atmosphere in outdoor or indoor spaces.



Material
Aluminium

Farbe
Mattweiß
Anthrazit
Corten



Wählbare Farbtemperatur
3000K / 4000K



Driver
eingebaut

Material
aluminum

Colour
matt white
anthracite
corten



Selectable color temperature
3000K / 4000K



Driver
built-in



LED-W-DUKROT-BCO		colour temp.	colour
8031414918591			
FANEU00007759			
lumen		1440 lm	

watt	12W
beam angle	180°

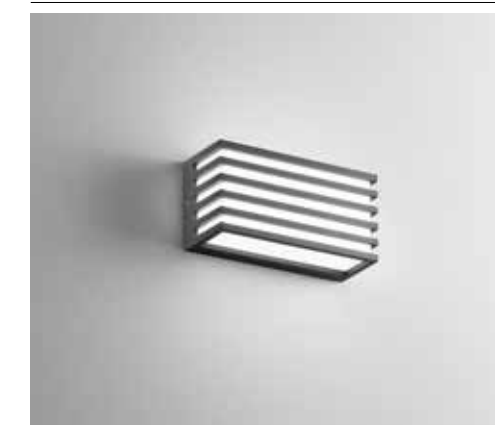
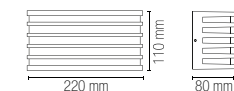

LED-W-DUKROT-ANT		colour temp.	colour
8031414918584			
FANEU00007758			
lumen		1440 lm	

watt	12W
beam angle	180°

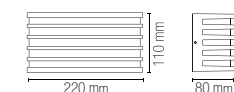

LED-W-DUKROT-BRO		colour temp.	colour
8031414918607			
FANEU00007760			
lumen		1440 lm	

watt	12W
beam angle	180°

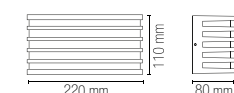

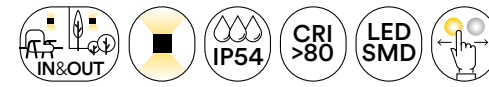

Material
Aluminium

Farbe
Weiß
Schwarz
Corten



Wählbare Farbtemperatur
3000K / 4000K



Driver
eingebaut

Material
aluminium

Colour
white
black
corten



Selectable color temperature
3000K / 4000K



Driver
built-in

LED-Wandleuchte aus Aluminium im Finish Weiß, Schwarz oder Corten. Doppelter Lichtstrahl, zwei Temperaturen und hervorragende Farbwiedergabe. Ideal für elegante Durchgangsbereiche und moderne städtische Räume.

LED wall lamp in aluminium with white, black or corten finish. Dual emission, dual colour temperatures and excellent colour rendering. Ideal for elegant pass-through areas or modern urban spaces.



LED-W-WEISS-BCO 8031414897193 FANEU00007866	colour temp. colour
lumen	1800 lm
watt	16W
beam angle	↓ 120° + 120° ↑

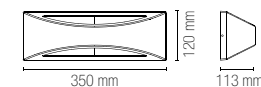

LED-W-WEISS-NER 8031414897216 FANEU00007869	colour temp. colour
lumen	1800 lm
watt	16W
beam angle	↓ 120° + 120° ↑

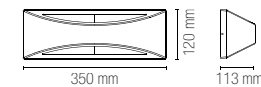

LED-W-WEISS-BRO 8031414897209 FANEU00007867	colour temp. colour
lumen	1800 lm
watt	16W
beam angle	↓ 120° + 120° ↑

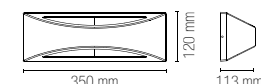



- Material**
PC
- Farbe**
Weiß, Schwarz, Corten
- Wählbare Farbtemperatur**
3000K / 4200K / 6500K
- Driver**
eingebaut
- Material**
PC
- Colour**
white, black, corten
- Selectable color temperature**
3000K / 4200K / 6500K
- Driver**
built-in



LED-Wandleuchte aus PC mit unverwechselbarem Design, erhältlich mit runder, quadratischer oder rechteckiger Form und in den drei Farbvarianten Weiß, Schwarz oder Corten. Ein Hauch von Persönlichkeit und individueller Gestaltung für Outdoor-Bereiche, der durch die wählbaren Lichtfarbtöne betont wird.
LED wall lamp in polycarbonate, available in a round, square or rectangular shape, in three colour options: white, black or corten. A touch of personality and customisation for outdoor spaces, enhanced by selectable light colour temperatures.

	LED-W-BLOCK-R-BCO 8031414947263 FANEU00028375 lumen 1900 lm	colour temp.	colour	
	LED-W-BLOCK-R-NER 8031414947256 FANEU00028374 lumen 1900 lm			
	LED-W-BLOCK-R-BRO 8031414947249 FANEU00028373 lumen 1900 lm			
	watt 15W beam angle 100°			

	LED-W-BLOCK-Q-BCO 8031414927982 FANEU00007718 lumen 1800 lm	colour temp.	colour	
	LED-W-BLOCK-Q-NER 8031414927999 FANEU00007719 lumen 1800 lm			
	LED-W-BLOCK-Q-BRO 8031414947225 FANEU00028371 lumen 1800 lm			
	watt 15W beam angle 100°			

	LED-W-BLOCK-RT-BCO 8031414927968 FANEU00007720 lumen 3210 lm	colour temp.	colour	
	LED-W-BLOCK-RT-NER 8031414927975 FANEU00007721 lumen 3210 lm			
	LED-W-BLOCK-RT-BRO 8031414947232 FANEU00028372 lumen 3210 lm			
	watt 24W beam angle 100°			

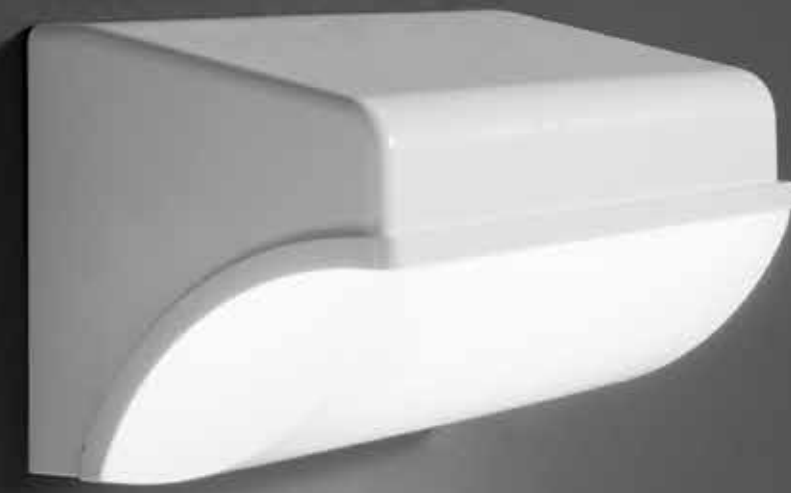

Material
PC

Farbe
Mattweiß
Mattanthrazit



Farbtemperatur
3000K / 4000K



Driver
inklusive

Material
PC

Colour
matt white
matt anthracite



Colour temperature
3000K / 4000K



Driver
included

Abgewinkelte LED-Wandleuchte mit Struktur und Diffusor aus Polycarbonat im Finish Weiß oder Anthrazit. Für Außenbereiche ausgelegt, bietet Schutz vor Staub und Flüssigkeiten, höchste Schlagfestigkeit und hervorragenden Sehkomfort.

Corner LED wall lamp with a polycarbonate fixture and diffuser in a matt white or anthracite finish. Designed for outdoor use, it provides protection against dust and liquids, with maximum resistance to impacts and excellent visual comfort.



	colour temp.	colour
LED-BORDER-30M-BCO		
8031414883578		
FANEU00005889		
lumen	3550 lm	

watt	30W
beam angle	120°

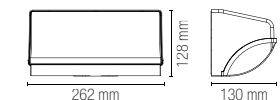

	colour temp.	colour
LED-BORDER-30M-ANT		
8031414883561		
FANEU00005888		
lumen	3550 lm	

watt	30W
beam angle	120°

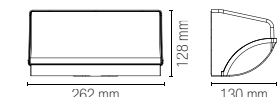



LED-Wandleuchte aus Polycarbonat, erhältlich in zwei Farbvarianten: weiß oder schwarz. Der Leuchtkörper bietet hohe Farbwiedergabe und drei Farbtemperaturen, um den Außenbereichen Charakter zu verleihen.

LED wall lamp in polycarbonate, available in two colour options: black or white. The light fixture provides high colour rendering and three colour temperatures to enhance outdoor spaces.

Material
Aluminium und Acryl

Farbe
Weiß
Schwarz



Wählbare Farbtemperatur
3000K / 4200K / 6500K



Driver
eingebaut

Material
aluminum and acrylic

Colour
white
black



Selectable color temperature
3000K / 4200K / 6500K



Driver
built-in



	colour temp.	colour
LED-W-RIM-BCO 8031414927920 FANEU00007832		
lumen	2500 lm	
watt	20W	
beam angle	100°	

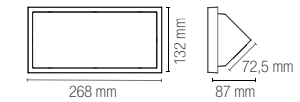

	colour temp.	colour
LED-W-RIM-NER 8031414927937 FANEU00007833		
lumen	2500 lm	
watt	20W	
beam angle	100°	

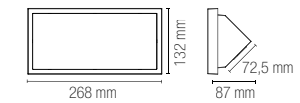



Material
Aluminium

Farbe
Geprägt, Weiß
Geprägt, Schwarz



Wählbare Farbtemperatur
3000K / 4000K



Driver
inklusive

Material
aluminium

Colour
embossed white
embossed black



Selectable color temperature
3000K / 4000K



Driver
included

Abgewinkelte LED-Wandleuchte mit Struktur aus Aluminium in geprägtem Finish: weiß oder schwarz. Mit doppeltem Lichtstrahl, zwei Farbtemperaturen, extremer Stoßfestigkeit und Kontrolle der Blendung.

Corner LED wall lamp with an aluminium fixture and embossed finish available in: black or white. It features dual emission, dual colour temperatures, exceptional resistance to impacts and glare control.



	colour temp.	colour
LED-W-LUXON BCO 8031414870677 FANEU00007795		
lumen	1550 lm	

watt	12W
beam angle	120°

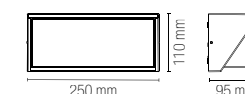

	colour temp.	colour
LED-W-LUXON ANT 8031414867097 FANEU00007794		
lumen	1550 lm	

watt	12W
beam angle	120°

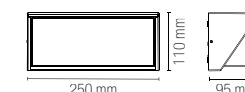



Wandleuchte aus Aluminium mit energiesparender SMD-LED-Lichtquelle und zwei Lichtfarbtönen. Das spezielle Design macht sie für Außen- wie Innenbereiche von Gewerbe-, Wohn- oder Stadtumgebungen gleichermaßen geeignet.
 Aluminium wall lamp fitted with an energy-saving LED SMD light source and two light colour temperatures. Its unique design makes it ideal for both outdoor and indoor spaces in retail, residential or urban areas.

Material
Aluminium

Farbe
Weiß
Schwarz

Wählbare Farbtemperatur
3000K / 4000K

Driver
eingebaut

Material
aluminium

Colour
white
black

Selectable color temperature
3000K / 4000K

Driver
built-in



	colour temp.	colour
LED-W-GRIS-BCO 8031414897223 FANEU00007775		
lumen	1390 lm	

watt	12W
beam angle	180°

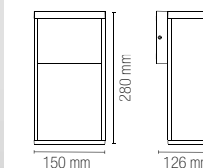

	colour temp.	colour
LED-W-GRIS-NER 8031414897230 FANEU00007777		
lumen	1390 lm	

watt	12W
beam angle	180°

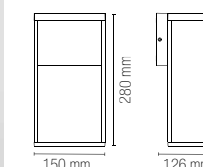



LED-Wandleuchte aus schwarzem geprägtem Aluminium in zwei Größen. Mit zweistufiger Beleuchtung, doppeltem Lichtstrahl und hoher Farbtreue, für einen essenziellen, doch nicht banalen Lichtpunkt.

LED wall lamp in black embossed aluminium, available in two dimensions. It features two colour temperatures, dual emission and high colour fidelity for a minimalist yet striking light source.

Material
Aluminium

Farbe
Geprägt, Schwarz

Wählbare Farbtemperatur
3000K / 4000K



Driver
inklusive

Material
aluminium

Colour
embossed black

Selectable color temperature
3000K / 4000K



Driver
included



	colour temp.	colour
LED-W-AGERA-90 8031440360951 FANEU00007657		
lumen	680 lm	
watt	2 × 3W	
beam angle	↓ 120° + 120° ↑	

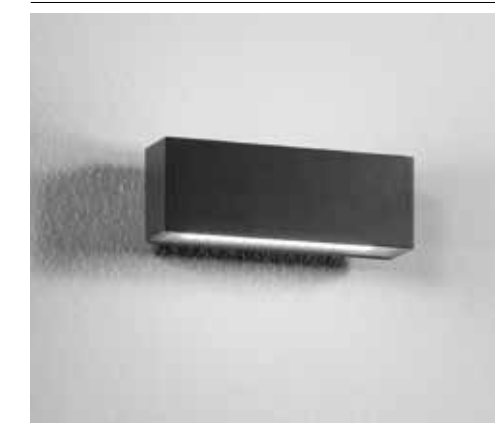
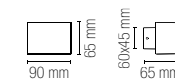

	colour temp.	colour
LED-W-AGERA-180 8031440360975 FANEU00007656		
lumen	1380 lm	
watt	2 × 6W	
beam angle	↓ 120° + 120° ↑	

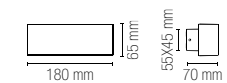

BOXTER

Wandleuchte aus geprägtem Aluminium mit verschiedenen Finishs: Weiß, Silber, Schwarz oder Corten. Die Lichtquelle mit doppeltem Lichtstrahl und zwei Farbtönen basiert auf einer hocheffizienten COB-LED.

Wall lamp in embossed aluminium, available in various finishes: white, silver, black or corten. The dual-emission light source with two colour temperatures is powered by high-efficiency COB LEDs.

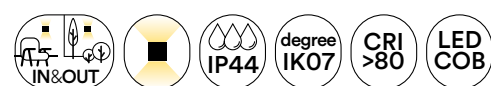

Technische Informationen / Technical information **BOXTER**



Material
Aluminium

Farbe
Weiß
Silber
Schwarz
Corten



Wählbare Farbtemperatur
3000K / 4000K



Driver
inklusive

Material
aluminium

Colour
white
silver
black
corten



Selectable color temperature
3000K / 4000K



Driver
included



LED-W-BOXTER BCO
8031414873043
FANEU00007722
lumen

colour temp. | colour



960 lm

watt 2 x 4W
beam angle ↓ 120° + 120° ↑

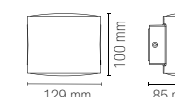

LED-W-BOXTER SIL
8031414862399
FANEU00007725
lumen

colour temp. | colour



960 lm

watt 2 x 4W
beam angle ↓ 120° + 120° ↑

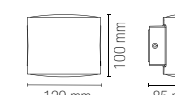

LED-W-BOXTER NER
8031414862382
FANEU00007724
lumen

colour temp. | colour



960 lm

watt 2 x 4W
beam angle ↓ 120° + 120° ↑

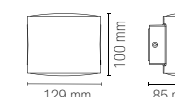

LED-W-BOXTER BRO
8031414862405
FANEU00007723
lumen

colour temp. | colour



960 lm

watt 2 x 4W
beam angle ↓ 120° + 120° ↑

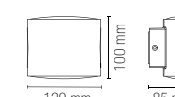



CCT-LED-Wandleuchte aus Polycarbonat mit einfachem oder mehrfachem doppeltem Lichtstrahl. Korrosionsfest, garantiert Schlagfestigkeit und Schutz vor Staub und Flüssigkeiten, was sie für Außenbereiche und Swimmingpools geeignet macht.
 CCT LED wall lamps in polycarbonate with dual emission, single or multiple. An anti-corrosive product guaranteeing impact resistance and protection against dust and liquids, making it ideal for outdoor spaces and swimming pools.

- Material**
PC
- Farbe**
Mattweiß
Mattschwarz
- Farbtemperatur**
3000K / 4000K
- Driver**
eingebaut
- Material**
PC
- Colour**
matt white
matt black
- Colour temperature**
3000K / 4000K
- Driver**
built-in

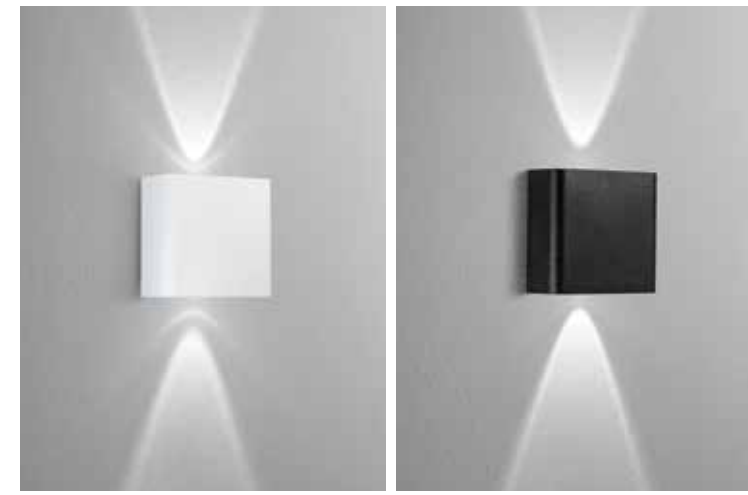

	colour temp.	colour
LED-W-KLEIN-AP2-BCO 8031414916337 FANEU00007782 lumen	3000K / 4000K	white
LED-W-KLEIN-AP2-NER 8031414916320 FANEU00007783 lumen	3000K / 4000K	black
watt	2W	
beam angle	60°	

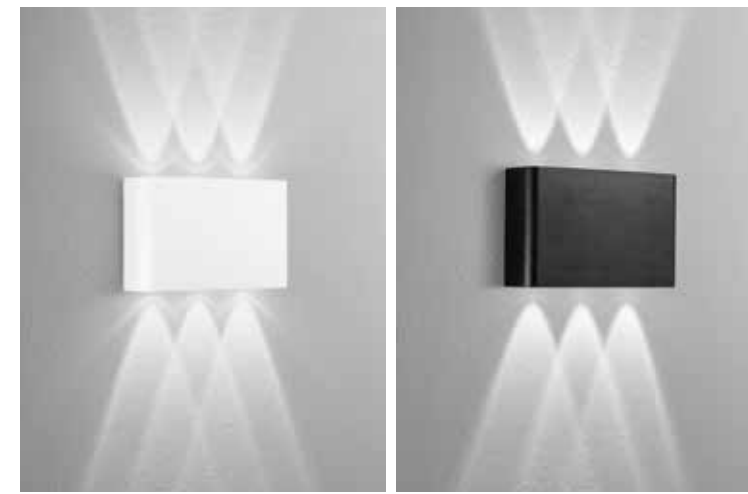

	colour temp.	colour
LED-W-KLEIN-AP6-BCO 8031414916351 FANEU00007784 lumen	3000K / 4000K	white
LED-W-KLEIN-AP6-NER 8031414916344 FANEU00007785 lumen	3000K / 4000K	black
watt	6W	
beam angle	60°	



LED-Wandleuchte aus geprägtem weißem oder anthrazitfarbenem Aluminium, gekennzeichnet durch den von mehreren Lichtpunkten erzeugten doppelten Lichtstrahl. Ein weiches und ausgesuchtes Design, bestehend aus extrem widerstandsfähigen Materialien.

LED wall lamp in white or anthracite embossed aluminium, featuring dual emission powered by multiple light points. A sleek and sophisticated design made of ultra-resistant materials.

Material
Aluminium

Farbe
Geprägt, Weiß
Geprägt, Anthrazit



Wählbare Farbtemperatur
3000K / 4000K



Driver
inklusive

Material
aluminum

Colour
embossed white
embossed anthracite



Selectable color temperature
3000K / 4000K



Driver
included

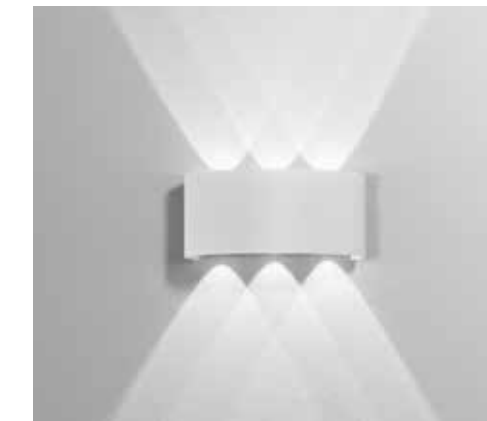

LED-W-BEETLE BCO 8031414876952 FANEU00007709	colour temp.	<input type="radio"/> <input type="radio"/> <input type="radio"/>
	lumen	600 lm
	watt	6W
beam angle	100°	

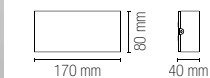

LED-W-BEETLE GR 8031414876969 FANEU00007710	colour temp.	<input type="radio"/> <input type="radio"/> <input type="radio"/>
	lumen	600 lm
	watt	6W
beam angle	100°	



HERCULES

Technisch-dekorative LED-Wandleuchte mit Aluminiumgehäuse und Corten-Finish sowie Diffusor aus Polycarbonat. Widerstandsfähige Ausführung und gesteigerter Charme dank der auswählbaren Farbtemperatur.

Technical-decorative LED wall lamp with aluminium fixture in corten finish, and polycarbonate diffuser. Made to last, its selectable colour temperature enhances its appeal.



Technische Informationen / Technical information

HERCULES



Material
Aluminium und Acryl

Farbe
Corten

Wählbare Farbtemperatur
2700K / 3300K / 4000K



Driver
inklusive

Material
aluminum and acrylic

Colour
corten

Selectable color temperature
2700K / 3300K / 4000K



Driver
included



LED-HERCULES-100
8031414935093
FANEU00027271
lumen

colour temp. colour



3500 lm

watt 23W
beam angle 120°
pf 0.95

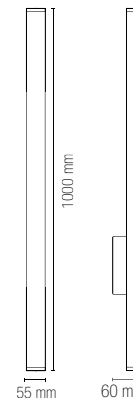

LED-HERCULES-140
8031414935109
FANEU00027272
lumen

colour temp. colour



6800 lm

watt 47W
beam angle 120°
pf 0.98

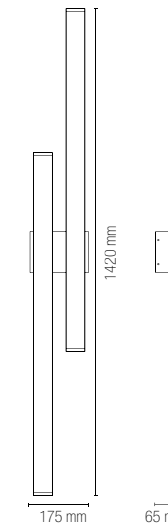

LED-HERCULES-200
8031414935116
FANEU00027273
lumen

colour temp. colour



6800 lm

watt 47W
beam angle 120°
pf 0.98

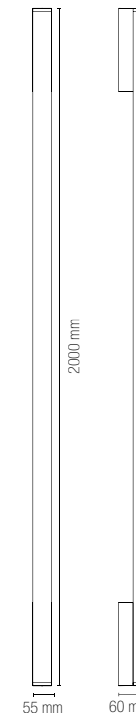

In.tec light WANDLAMPEN / WALL LAMPS

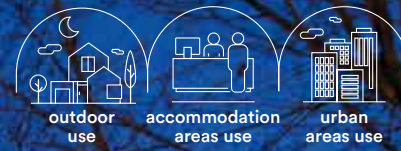

- Material**
Aluminium
- Farbe**
Geprägt, Anthrazit
- Farbtemperatur**
4000K
- Driver**
inklusive
- Material**
aluminium
- Colour**
embossed anthracite
- Colour temperature**
4000K
- Driver**
included

LED-Streifen aus geprägtem Aluminium mit anthrazitfarbenem Finish. Entwickelt, um Eleganz und gleichzeitig Schutz vor Staub und Flüssigkeiten, Schlagfestigkeit und hohe Farbwiedergabe zu garantieren.
LED strip light in embossed aluminium with an anthracite finish. Designed to ensure elegance and protection against dust and liquids, with impact resistance and high colour rendering.



	colour temp.	colour
LED-RIBBON-42 8031414882335 FANEU00007268		
lumen	1600 lm	

watt	2 x 6W
beam angle	120°

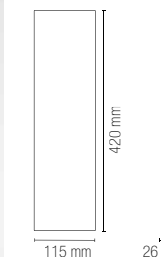

	colour temp.	colour
LED-RIBBON-72 8031414882342 FANEU00007269		
lumen	2600 lm	

watt	2 x 10W
beam angle	120°

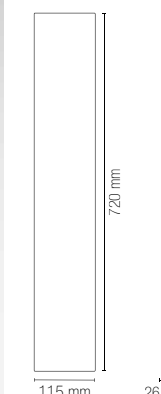



- Material**
Thermoplast
- Farbe**
Schwarz
- Farbtemperatur**
4000K
- Driver**
inklusive
- Material**
thermoplastic
- Colour**
black
- Colour temperature**
4000K
- Driver**
included

Thermoplastisches LED-Band. Fügt sich perfekt in Gewerbe-, Wohn- oder Stadtbereiche ein, indem er diesen mit seinem extrem minimalistischen Design und der Beleuchtung mit einzelner oder doppeltem sauberem Lichtstrahl Charakter verleiht.
 LED strip light in thermoplastic. It seamlessly integrates into retail, residential or urban spaces, giving them that extra edge with its ultra-minimalist design and single or double clear beam of light.



	colour temp.	colour
LED-LASER 8031414882328 FANEU00006685		
lumen	170 lm	
watt	3W	
beam angle	5°	



	colour temp.	colour
LED-LASER-BIS 8031414882311 FANEU00006686		
lumen	40 lm	
watt	5W	
beam angle	2 x 4°	



ALFA

LED-Wandleuchte aus Aluminium mit auswählbarem Lichtfarbton (CCT) und unabhängig verstellbaren Lamellen, die es gestatten, den Lichtstrahl individuell auszurichten. Erhältlich in 4 geprägten Finishes: Weiß, Silber, Anthrazit und Corten.

LED wall lamp in aluminium with selectable light colour temperatures (CCT) and independent adjustable baffles for customising the beam of light. Available in 4 embossed finishes: white, silver, anthracite and corten.

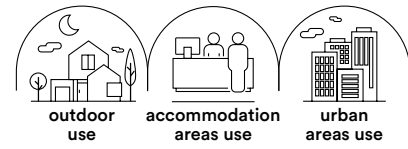

ALFA



- Material**
Aluminium
- Farbe**
Geprägt, Weiß
Geprägt, Silber
Geprägt, Anthrazit
Geprägt, Corten
- Farbtemperatur**
3000K / 4000K

- Driver**
inklusive
- Material**
aluminium
- Colour**
embossed white
embossed silver
embossed anthracite
embossed corten

- Colour temperature**
3000K / 4000K
- Driver**
included

LED-W-ALFA-10-BCO
8031414905843
FANEU00007665
lumen 1200 lm

watt 10W
beam angle $\downarrow 10^\circ/120^\circ + 10^\circ/120^\circ \uparrow$

LED-W-ALFA-10-GR
8031414905850
FANEU00007669
lumen 1200 lm

watt 10W
beam angle $\downarrow 10^\circ/120^\circ + 10^\circ/120^\circ \uparrow$

LED-W-ALFA-10-ANT
8031414929351
FANEU00009571
lumen 1200 lm

watt 10W
beam angle $\downarrow 10^\circ/120^\circ + 10^\circ/120^\circ \uparrow$

LED-W-ALFA-10-BRO
8031414929368
FANEU00009572
lumen 1200 lm

watt 10W
beam angle $\downarrow 10^\circ/120^\circ + 10^\circ/120^\circ \uparrow$

LED-W-ALFA-20-BCO
8031414905867
FANEU00007679
lumen 1800 lm

watt 18W
beam angle $\downarrow 10^\circ/120^\circ + 10^\circ/120^\circ \uparrow$

LED-W-ALFA-20-GR
8031414929344
FANEU00009569
lumen 1800 lm

watt 18W
beam angle $\downarrow 10^\circ/120^\circ + 10^\circ/120^\circ \uparrow$

LED-W-ALFA-20-ANT
8031414905874
FANEU00007678
lumen 1800 lm

watt 18W
beam angle $\downarrow 10^\circ/120^\circ + 10^\circ/120^\circ \uparrow$

LED-W-ALFA-20-BRO
8031414905881
FANEU00007680
lumen 1800 lm

watt 18W
beam angle $\downarrow 10^\circ/120^\circ + 10^\circ/120^\circ \uparrow$

Licht mit doppeltem Lichtstrahl und unabhängig verstellbaren Lamellen /
Bi-emission light with independent adjustable wings

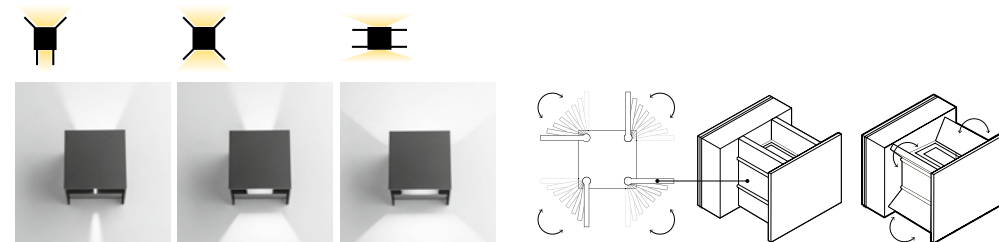



Material
Aluminium

Farbe
Geprägt, Weiß
Geprägt, Silber



Farbtemperatur
3000K / 4000K



Driver
inklusive

Material
aluminium

Colour
embossed white
embossed silver



Colour temperature
3000K / 4000K



Driver
included

LED-Wandleuchte aus geprägtem weißem oder silbernem Aluminium mit unabhängig verstellbaren Lamellen zum Ausrichten der beiden Lichtstrahlen. Die Beleuchtung erfolgt mit dynamischer Temperatur (CCT).

LED wall lamp in white or silver embossed aluminium with independent adjustable baffles to direct the two beams of light. Dynamic temperature control (CCT) lighting.



	colour temp.	colour
LED-W-DELTA-10-BCO		
8031414905829		
FANEU00007732		
lumen	1200 lm	

watt	2 × 5W
beam angle	↓ 10°/120° + 10°/120° ↑

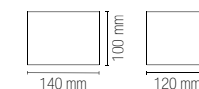

	colour temp.	colour
LED-W-DELTA-10-GR		
8031414905836		
FANEU00007735		
lumen	1200 lm	

watt	2 × 5W
beam angle	↓ 10°/120° + 10°/120° ↑

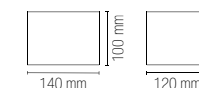

Licht mit doppeltem Lichtstrahl und unabhängig verstellbaren Lamellen /
Bi-emission light with independent adjustable wings

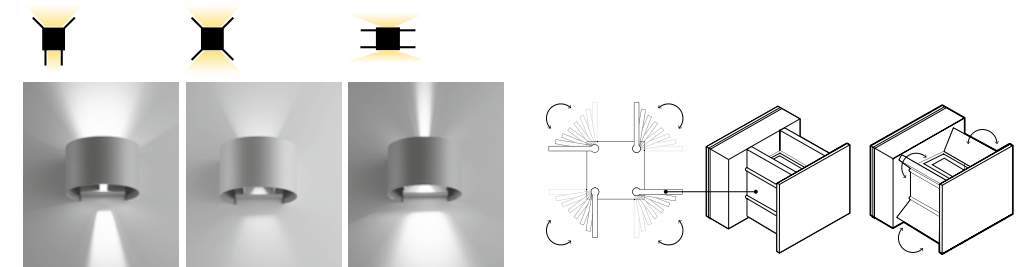

PARKER

LED-Wandleuchte aus weißem oder grauem natürlichem Zement. Erhältlich in verschiedenen Größen, verleiht Outdoor-Bereichen einen minimalistischen und plastischen Look und bietet eine sehr hohe Farbwiedergabe und Schutz vor Flüssigkeiten und Staub.

LED wall lamp in white or natural grey cement. Available in various sizes, it adds a minimalist, textured touch to outdoor spaces, providing protection and excellent colour rendering, as well as protection against liquids and dust.

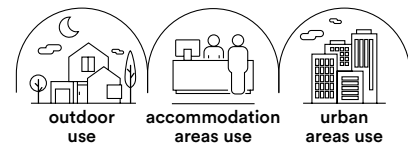

PARKER



- Material**
Zement
- Farbe**
Weiß
Grau
-
- Wählbare Farbtemperatur**
3000K / 4000K
-
- Driver**
inklusive
- Material**
concrete
- Colour**
white
grey
-
- Selectable color temperature**
3000K / 4000K
-
- Driver**
included

Verbinder IP65
 enthalten /
 IP65 connector
 included



LED-PARKER-AP30 GR
 8031414866977
 FANEU00007029
 lumen 1080 lm

watt 9W
 beam angle ↓ 120° + 120° ↑

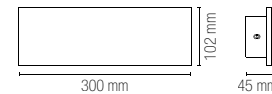

Verbinder IP65
 enthalten /
 IP65 connector
 included



LED-PARKER-AP30
 8031414864195
 FANEU00007028
 lumen 1080 lm

watt 9W
 beam angle ↓ 120° + 120° ↑

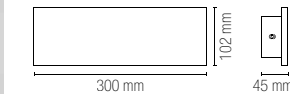

LED-PARKER-AP50 GR
 8031414866984
 FANEU00007035
 lumen 2100 lm

watt 16W
 beam angle ↓ 120° + 120° ↑

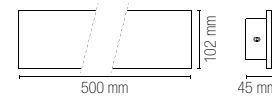

LED-PARKER-AP40
 8031414864201
 FANEU00007032
 lumen 1400 lm

watt 12W
 beam angle ↓ 120° + 120° ↑

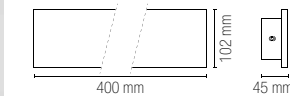

LED-PARKER-AP60
 8031414862504
 FANEU00007038
 lumen 2640 lm

watt 20W
 beam angle ↓ 120° + 120° ↑



LED-PARKER-AP120
 8031414862511
 FANEU00007025
 lumen 3800 lm

watt 30W
 beam angle ↓ 120° + 120° ↑



PORTLAND

Zylindrische Wandleuchte aus weißem Zement mit GU10-Sockel, doppeltem Lichtstrahl und hohem Schutz vor Staub und Flüssigkeiten. So diskret wie unverwechselbar, wertet Durchgangsbereiche sowie städtische Umgebungen auf schlichte Weise auf.

Cylindrical wall lamp in white cement with GU10 fitting, dual emission and high protection against dust and liquids. Understated yet refined, it enhances transit areas and urban spaces with its simplicity.

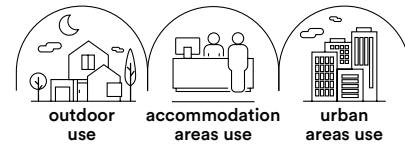

I-PORTLAND-AP2 BCO
 8031414863563
 FANEU00003208

2 x GU10 MAX 35W

colour

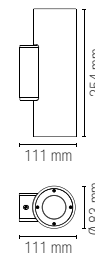

- Verbinder IP65 enthalten / IP65 connector included
- Glühbirne nicht enthalten / Light bulb not included

OAKLAND

LED-Wandleuchte aus weißem Zement mit doppeltem Lichtstrahl. Der GU10-Sockel bietet Funktionalität und Robustheit für eine perfekte Verschmelzung mit modernen Außenbereichen, insbesondere Gewerbe- und Wohngebieten.

LED wall lamp in white cement with dual emission. The GU10 fitting provides functionality and durability seamlessly blending with modern outdoor environments, especially retail or residential spaces.



I-OAKLAND-AP2 BCO
 8031414864218
 FANEU00002965

2 x GU10 MAX 10W

colour

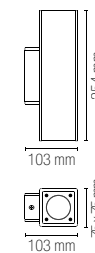

- Verbinder IP65 enthalten / IP65 connector included
- Glühbirne nicht enthalten / Light bulb not included

JUMP

Zylindrische LED-Wandleuchte aus Aluminium mit doppeltem Lichtstrahl. In drei Finish erhältlich - Weiß, Silber oder aus Edelstahl -, um sich harmonisch an die Linien und die Konstruktionsmaterialien der Außenbereiche anzupassen.

Cylindrical LED wall lamp in aluminium with dual emission. Available in three finishes – white, silver or stainless steel - to harmonise with the lines and materials used in outdoor areas.

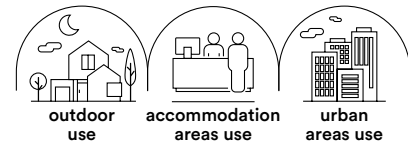

Technische Informationen / Technical information **JUMP**



Glühbirne nicht enthalten / Light bulb not included



	colour
I-JUMP-AP2 BCO 8031414862351 FANEU00002383	
I-JUMP-AP2 SIL 8031414862344 FANEU00002385	
I-JUMP-AP2 INOX 8031414862368 FANEU00002384	

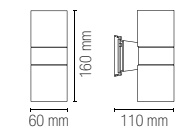

2 x GU10 MAX 35W

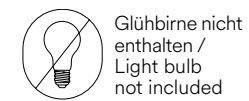

Glühbirne nicht enthalten / Light bulb not included



	colour
I-JUMP-AP2-E27 SIL 8031414865390 FANEU00002386	

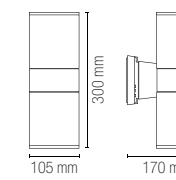

2XE27 MAX 60W

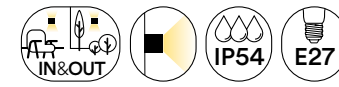

Aus Glas und Aluminium hergestellter Artikel, erhältlich in den Farben Weiß oder Anthrazit mit symmetrischem Lichtstrahl. Das spezielle Design verleiht einen Hauch von Persönlichkeit und ist ideal für neutrale Außenbereiche.

A product made of glass and aluminium, available in white or anthracite with a symmetrical beam of light. Its unique design adds a touch of personality that is ideal for neutral outdoor spaces.



Empfohlene Glühbirne / Suggested light bulb



Glühbirne nicht enthalten / Light bulb not included



I-ROSEN-AP-BCO
8031414931316
FANEU00025169

1 x E27 MAX 25W

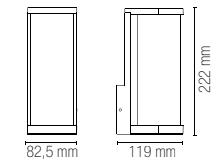

colour



I-ROSEN-AP-ANT
8031414931330
FANEU00025170

1 x E27 MAX 25W

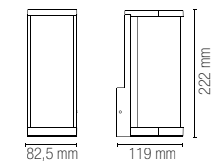

colour



ONE

LED-Wandleuchte aus geprägtem Aluminium in Weiß, Anthrazit oder Corten. Mit einzelem oder doppeltem Lichtstrahl und in zwei Größen erhältlich. Der GU10-Sockel gestattet eine diskrete Verschmelzung mit der Outdoor-Umgebung.

LED wall lamp in white, anthracite or corten embossed aluminium. Available with single or dual emission and in two sizes. The GU10 fitting enables it to subtly blend in with outdoor environments.



Technische Informationen / Technical information **ONE**



Glühbirne nicht enthalten / Light bulb not included



	colour	
I-ONE-AP1 BCO 8031414878857 FANEU00002982		
I-ONE-AP1 ANT 8031414073009 FANEU00002981		
I-ONE-AP1 BRO 8031414048861 FANEU00002983		

1 x GU10 MAX 35W



Glühbirne nicht enthalten / Light bulb not included



	colour	
I-ONE-AP2 BCO 8031414878864 FANEU00002985		
I-ONE-AP2 ANT 8031414082100 FANEU00002984		
I-ONE-AP2 BRO 8031414079995 FANEU00002986		

2 x GU10 MAX 35W



QUBO

LED-Wandleuchte mit GU10-Sockel aus geprägtem Aluminium in Weiß, Anthrazit oder Corten. Erhältlich in der quadratischen Mini-Version mit einzeltem Lichtstrahl oder der normalen Ausführung mit doppeltem Lichtstrahl.

LED wall lamp with GU10 fitting in white, anthracite or corten embossed aluminium. Available in a mini square version with single emission or in the standard version with dual emission.

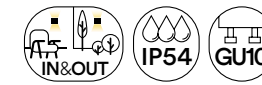

Technische Informationen / Technical information **QUBO**

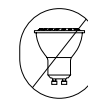

Glühbirne nicht enthalten / Light bulb not included



		colour	
I-QUBO-AP1 BCO	8031414878833 FANEU00003443		
I-QUBO-AP1 ANT	8031414084203 FANEU00003442		
I-QUBO-AP1 BRO	8031414082117 FANEU00003444		
1 x GU10 MAX 35W			

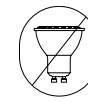

Glühbirne nicht enthalten / Light bulb not included



		colour	
I-QUBO-AP2 BCO	8031414878840 FANEU00003446		
I-QUBO-AP2 ANT	8031414084289 FANEU00003445		
I-QUBO-AP2 BRO	8031414083336 FANEU00003447		
2 x GU10 MAX 35W			



POPUP

Wandleuchte aus Metall, erhältlich in zwei verschiedenen Größen und in drei Farbvarianten: Weiß, Bronze oder Schwarz. Mit praktischem GU10-Sockel zum diskreten und vereinfachten Einfügen in die Outdoor-Bereiche. Metal wall lamp, available in two different sizes and in three colour options: white, bronze or black. With a practical GU10 fitting for subtle and easy integration into outdoor spaces.



Technische Informationen / Technical information **POPUP**

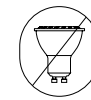

Glühbirne nicht enthalten / Light bulb not included



	colour
I-POPUP-M-BCO 8031414935123 FANEU00026202	
I-POPUP-M-NER 8031414935130 FANEU00026203	
I-POPUP-M-BRO 8031414935147 FANEU00026204	
1 x GU10 MAX 15W	

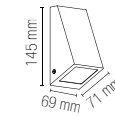

Glühbirne nicht enthalten / Light bulb not included



	colour
I-POPUP-L-BCO 8031414935154 FANEU00026205	
I-POPUP-L-NER 8031414935161 FANEU00026206	
I-POPUP-L-BRO 8031414935178 FANEU00026207	
1 x E27 MAX 15W	

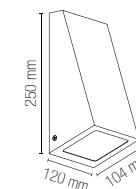

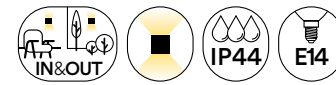

Wandleuchte mit Diffusor aus Polycarbonat und Gehäuse aus Aluminium in den Finishes Weiß, Silber oder Bronze. Das elegante Design und die Beleuchtung mit doppeltem Lichtstrahl machen die Wandleuchte ideal für gehobene Innen- sowie Außenumgebungen in zeitgemäßem Stil.

Wall lamp with diffuser in polycarbonate and aluminium fixture in a white, silver or bronze finish. Its elegant design and dual emission lighting make this wall lamp ideal for contemporary, stylish environments, both indoors and outdoors.



Empfohlene Glühbirne / Suggested light bulb



Glühbirne nicht enthalten / Light bulb not included

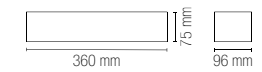

colour

I-TUCSON-AP BCO
8031414862160
FANEU00003866

2 x E14 MAX 40W

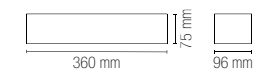

colour

I-TUCSON-AP SIL
8031414862184
FANEU00003868

2 x E14 MAX 40W

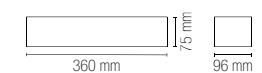

colour

I-TUCSON-AP BRO
8031414862191
FANEU00003867

2 x E14 MAX 40W



Wandleuchte mit Gehäuse und Vorderseite aus Aluminium und Diffusor aus PC. Erhältlich in den Farben Weiß, Nickel oder Schwarz, bietet Beleuchtung mit dreifachem Lichtstrahl und Schutz vor Stößen, Staub und Wasser.

Wall lamp with aluminum front and PC diffuser. Available in white, nickel or black, it provides triple-emission lighting and protection against impacts, dust and water.



Glühbirne nicht enthalten / Light bulb not included



I-SOLIX-AP-BCO
8031414946839
FANEU00028324

colour

1 x E27 MAX 20W

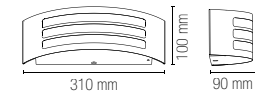

I-SOLIX-AP-CR
8031414946792
FANEU00028320

colour

1 x E27 MAX 20W

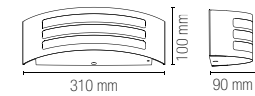

I-SOLIX-AP-NER
8031414946846
FANEU00028325

colour

1 x E27 MAX 20W

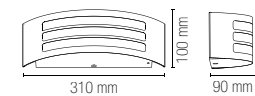

AUSTIN

Wandleuchte aus Aluminium in den Finishes Weiß, Silber, Schwarz oder Bronze. Der Diffusor mit dreifachem Lichtstrahl ist aus Polycarbonat hergestellt. Eine diskrete und funktionelle Lösung mit Schutz vor Flüssigkeiten und Staub.

Wall lamp in aluminium, available in a white, silver, black or bronze finish. The diffuser, made of polycarbonate, features triple emission. An understated, functional solution with protection against liquids and dust.

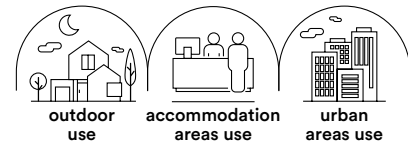

Technische Informationen / Technical information **AUSTIN**



Glühbirne nicht enthalten /
Light bulb not included



I-AUSTIN-AP BCO
8031440362122
FANEU00001201

colour



1 x E27 MAX 42W

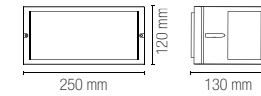

I-AUSTIN-AP SIL
8031414862429
FANEU00001204

colour



1 x E27 MAX 42W

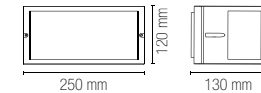

I-AUSTIN-AP NER
8031440362139
FANEU00001203

colour



1 x E27 MAX 42W

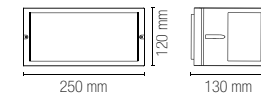

I-AUSTIN-AP BRO
8031440362108
FANEU00001202

colour



1 x E27 MAX 42W

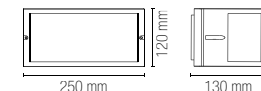

ATLANTA

Wandleuchte aus Aluminium mit elegantem anthrazitfarbenem Finish und mattem Diffusor aus Polycarbonat. Mit Schutz vor Staub und Flüssigkeiten zur sicheren Verwendung in Outdoor-Umgebungen.

Wall lamp in aluminium with an elegant anthracite finish and opal diffuser in polycarbonate. It features protection against dust and liquids for safe use in outdoor environments.

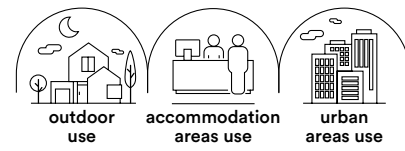

I-ATLANTA-AP
8031440312257
FANEU00001183



1 x E27 MAX 42W

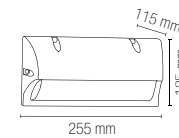

Glühbirne nicht enthalten /
Light bulb not included

DENVER

Wandleuchte mit doppeltem Lichtstrahl aus Aluminium. Mit mattem Diffusor aus Polycarbonat mit anthrazitfarbenem Finish, für eine gleichermaßen funktionelle und dekorative Beleuchtung.

Wall lamp with dual emission, made of aluminium. With an opal diffuser in polycarbonate and an anthracite finish for lighting that is both functional and decorative.

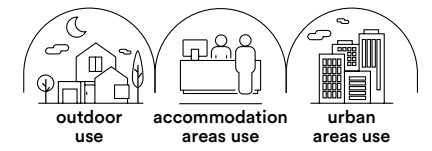

I-DENVER-AP
8031440312264
FANEU00001580



1 x E27 MAX 42W

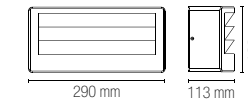

Glühbirne nicht enthalten /
Light bulb not included

MONDRIAN

Wandleuchte aus Metall in Weiß, Schwarz, Silber oder Bronze mit Diffusor aus Glas. Ein klassisches Design mit zeitgemäßem Touch, um sich harmonisch in verschiedene Architekturstile einzufügen.
Wall lamp in white, black, silver or bronze metal with glass diffuser.
A classic design with a nod to contemporary style, harmoniously blending in with various architectural styles.

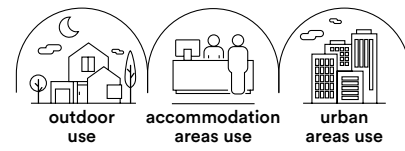

	colour
I-MONDRIAN-AP BCO 8031414896134 FANEU00002848	●
I-MONDRIAN-AP SIL 8031414862306 FANEU00002851	●
I-MONDRIAN-AP NER 8031414896127 FANEU00002850	●
I-MONDRIAN-AP BRO 8031414862313 FANEU00002849	●

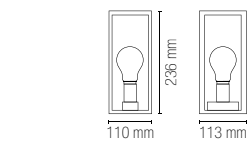

Glühbirne nicht enthalten / Light bulb not included

1 x E27 MAX 25W

GAETA

Laterne aus Aluminiumdruckguss mit schwarz-goldenem Finish und Diffusor aus Glas. Gaeta ist eine Einrichtungsergänzung für Außenbereiche mit starker Persönlichkeit und macht in klassischen wie schicken Umgebungen gleichermaßen eine tadellose Figur.
Lantern in die-cast aluminium with black and gold finish, and glass diffuser. Gaeta is an outdoor furnishing item with a striking personality, impeccable in both classic and trendy settings.

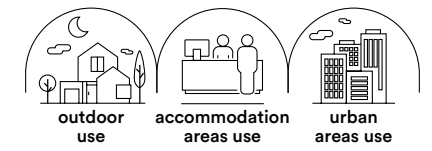

	colour
LANT-GAETA-AP1 8031440313278 FANEU00005561	●

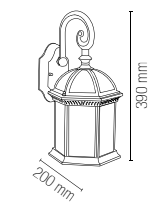

1 x E27 MAX 60W

Glühbirne nicht enthalten / Light bulb not included

PAVÈ

LED-Strahler aus anthrazitfarbenem Metall und transparentem Glas. Bietet Schlagfestigkeit und hohen Schutz vor Flüssigkeiten und Staub. Erhältlich in drei Größen, kann durch Zubehör zur Befestigung mit Pflock ergänzt werden. LED spotlight in anthracite metal and transparent glass. It provides impact resistance and high protection against liquids and dust. Available in three sizes, it can be complemented with the peg fixing accessory.



Technische Informationen / Technical information **PAVÈ**



Material
Metall,
Diffusor
transparentes Glas

Farbe
Anthrazit



Farbtemperatur
3000K



Driver
eingebaut

Material
metal
transparent glass
diffuser

Colour
anthracite



Colour temperature
3000K



Driver
built-in



LED-PAVE-7
8031414922925
FANEU00027278
lumen

colour temp.	colour
730 lm	

watt	6W
beam angle	45°
pf	-

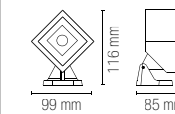

Nicht enthaltenes Zubehör / Accessory not included

Zubehör für Befestigung mit Pflock / Accessory for peg fixing



LED-PAVE-7-SPK
8031414937226
FANEU00027105



LED-PAVE-20
8031414922932
FANEU00027277
lumen

colour temp.	colour
2300 lm	

watt	17W
beam angle	45°
pf	-

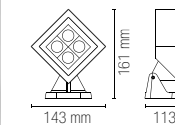

LED-PAVE-2030-SPK
8031414937233
FANEU00027106



LED-PAVE-30
8031414922949
FANEU00027276
lumen

colour temp.	colour
3500 lm	

watt	26W
beam angle	45°
pf	0.90

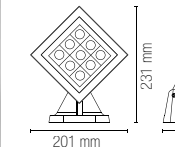

LED-PAVE-2030-SPK
8031414937233
FANEU00027106



Kollektion aus Aluminium mit integrierter LED und anthrazitfarbenem geprägtem Finish. Mit Befestigungspflock, bietet warmes Licht und drei verschiedene Höhen. Ideal, um Gärten im Außenbereich und Räumlichkeiten im zeitgemäßen Stil Charakter zu verleihen.

Collection in aluminium with integrated LED, with anthracite embossed finish. With a peg for fixing, it provides a warm light and is available in three different heights. Ideal for enhancing outdoor gardens and spaces in contemporary style.

Material
Aluminium

Farbe
Geprägt, Anthrazit



Farbtemperatur
3000K



Driver
DC 24V
Konstantspannung
nicht enthalten

Material
aluminium

Colour
embossed anthracite



Colour temperature
3000K



Driver
DC 24V
constant voltage
not included



Driver ab S. /from p. 414
Controller ab S. /from p. 430

LED-WAX-P120
8031414922956
FANEU00027444
lumen

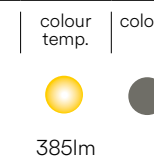

watt	3W
beam angle	120°

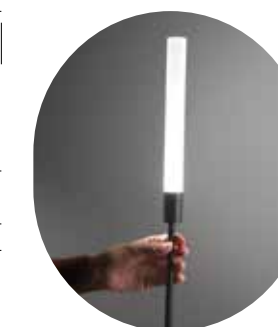
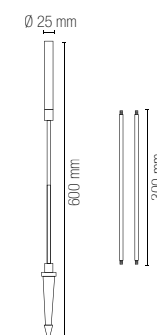

Pflock für Installation im Boden enthalten / Spike for installation in the ground included



Eine minimalistische Kollektion aus Aluminium mit LED und Finish in Anthrazit oder geprägtem Corten. So elegant wie unkonventionell, bietet Puck optimale Schlagfestigkeit, Schutz vor Staub und Flüssigkeiten und hohe Farbtreue.

A minimalist collection in aluminium with LED lighting, in anthracite or corten embossed finish. Both elegant and unconventional, Puck provides excellent impact resistance, protection against dust and liquids, and high colour fidelity.

Material
Aluminium

Farbe
Geprägt, Anthrazit
Geprägt, Corten



Farbtemperatur
3000K



Driver
DC 24V
Konstantspannung nicht
enthalten

Material
aluminium

Colour
embossed anthracite
embossed corten



Colour temperature
3000K



Driver
DC 24V
constant voltage
not included



LED-PUCK-P120-ANT

8031414918652
FANEU00007154
lumen

colour temp. | colour



360 lm

LED-PUCK-P120-BRO

8031414918669
FANEU00007155
lumen



360 lm

watt 3W
beam angle 180°

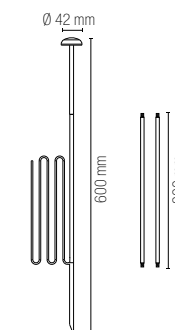

PEG

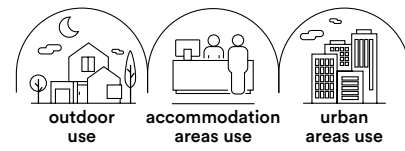

Flutlichtleuchte aus Thermoplast mit warmer oder kalter Farbtemperatur. Inklusive Pflöck, bietet optimale Farbwiedergabe und einen hervorragenden Schutz vor Wasser und Staub.

Floodlight in thermoplastic with a warm or cool colour temperature. With a peg included, it provides optimum colour rendering and excellent protection against water and dust.

Material
PC

Farbe
Schwarz

Farbtemperatur
3000K / 4000K

Driver
eingebaut

Material
PC

Colour
black

Colour temperature
3000K / 4000K

Driver
built-in

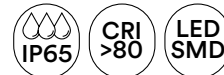

	colour temp.	colour
LED-PEG-9C-NER 8031414889600 FANEU00007090 lumen	900 lm	● ●
LED-PEG-9M-NER 8031414895403 FANEU00007091 lumen	900 lm	● ●
watt		9W
beam angle		60°

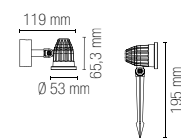

HAYDON



Flutlichtstrahler aus Aluminium inklusive Pflöck. Liefert eine Beleuchtung mit COB-LED und überlegenen technischen Eigenschaften: hervorragender Schutz vor Stößen, Staub und Flüssigkeiten und überragende Farbtreue.

Floodlight in aluminium, peg included. It provides lighting with integrated COB LED and superior technical features: optimum protection against impacts, dust and liquids, and excellent colour fidelity.

Material
Aluminium

Farbe
Schwarz

Farbtemperatur
3000K / 4000K / 6000K

Driver
inklusive

Material
aluminium

Colour
black

Colour temperature
3000K / 4000K / 6000K

Driver
included



	colour temp.
LED-HAYDON-15 8031414938995 FANEU00027561 lumen	1490 lm

watt	15W
beam angle	30°

	colour temp.
LED-HAYDON-30 8031414933754 FANEU00025859 lumen	3155 lm

watt	30W
beam angle	30°

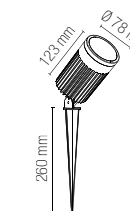

Photometrie des Produkts / Photometric curve

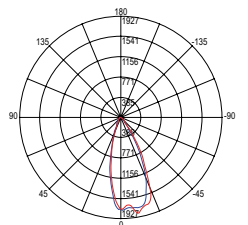

LED-HAYDON-15

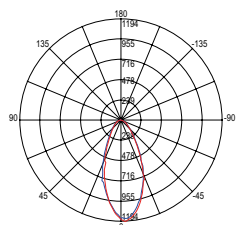

LED-HAYDON-30

GRUBB

Flutlichtleuchte aus schwarzem Thermoplast. Ausgestattet mit Erdspeiß und inklusive SMD-LED-Leuchtmittel, für eine diskrete Installation in Grünflächen von Stadt-, Wohn- oder Gewerbegebieten dank des Schutzes gegen Flüssigkeiten und Staub.

Floodlight in black thermoplastic. Equipped with ground spike and SMD LED bulb included, as well as a functional GU10 fitting, for discreet installation in green spaces in urban, residential or commercial areas, thanks to its protection against liquids and dust.

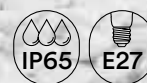

colour	●
LED-GRUBB-7M 8031414883554 FANEU00006312	
1 x E27	

Enthaltenes Zubehör / Accessories included	
	LED-SMD-Glühbirne / LED SMD light bulbs
watt	7W
beam angle	100°
cri	80
on/off	>10.000
life time	25000h
4000K	
lumen	510 lm
dimmer	



colour	●
LED-GRUBB-15M 8031414883547 FANEU00006311	
1 x E27	

Enthaltenes Zubehör / Accessories included	
	LED-SMD-Glühbirne / LED SMD light bulbs
watt	15W
beam angle	100°
cri	80
on/off	>10.000
life time	25000h
4000K	
lumen	1100 lm
dimmer	

AKRON

Kollektion von Aluminium-Flutlichtleuchten mit weißem, schwarzem oder Corten-Finish inklusive Pflock. Liefert einen optimalen Schutz vor Wasser und Staub und gestattet dank des GU10-Sockels die direkte Verkabelung.

Collection of floodlights in aluminium with white, black or corten finish, peg included. It provides optimum protection against water and dust, with direct wiring, thanks to the GU10 fitting.



colour	●
I-AKRON-BCO 8031414882649 FANEU00001018	
I-AKRON-NER 8031414882663 FANEU00001021	●
I-AKRON-BRO 8031414882656 FANEU00001019	●
1 x GU10 MAX 35W	

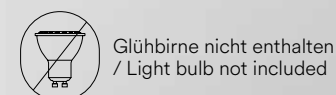

DROP

Kollektion aus Aluminium mit anthrazitfarbenem Finish und Diffusor aus Polycarbonat. Bietet eine diffuse und hocheffiziente Beleuchtung (mit G9-Sockel) sowie hervorragende Beständigkeit gegen Staub und Flüssigkeiten. So einfach wie charakteristisch.
 Collection in aluminium with anthracite finish and polycarbonate diffuser. It provides high-efficiency diffused lighting (with a G9 fitting) and excellent resistance to dust and liquids. Simple yet striking.

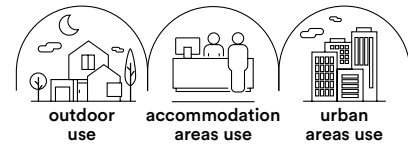

Technische Informationen / Technical information **DROP**



Empfohlene Glühbirne / Suggested light bulb



Glühbirne nicht enthalten / Light bulb not included



I-DROP-P33-ANT
 8031414883073
 FANEU00001710

colour



1 x G9 LED

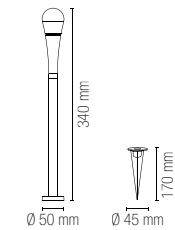

I-DROP-P53-ANT
 8031414883080
 FANEU00001711

colour



1 x G9 LED

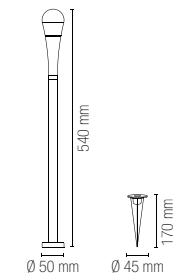

I-DROP-P73-ANT
 8031414882793
 FANEU00001712

colour



1 x G9 LED

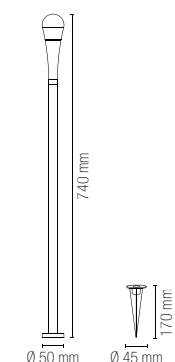



Deckenleuchten / Ceiling lamps
outdoor



Wandleuchte aus Aluminium in den Finishes Weiß, Schwarz und Corten.
Erhältlich in der Version als Würfel oder Zylinder, verleiht sowohl Außen- als auch Innenumgebungen einen Hauch von minimalistischer Eleganz, was sie insbesondere für Beherbergungsbetriebe ideal macht.

Ceiling lamp in aluminium with white, black or corten finish. Available in cubic or cylindrical version, it adds a touch of minimalist elegance to outdoor and indoor spaces, making it especially ideal for hospitality facilities.



	colour
I-CITIZEN-Q1-BCO 8031414882922 FANEU00001469	
I-CITIZEN-Q1-NER 8031414882939 FANEU00001471	
I-CITIZEN-Q1-BRO 8031414882915 FANEU00001470	

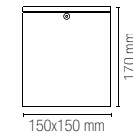

Empfohlene Glühbirne / Suggested light bulb

Glühbirne nicht enthalten / Light bulb not included



	colour
I-CITIZEN-R1-BCO 8031414882892 FANEU00001473	
I-CITIZEN-R1-NER 8031414882908 FANEU00001475	
I-CITIZEN-R1-BRO 8031414882885 FANEU00001474	

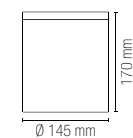

Empfohlene Glühbirne / Suggested light bulb

Glühbirne nicht enthalten / Light bulb not included



Wandleuchte mit Gehäuse aus Aluminium, erhältlich im Finish Weiß, Schwarz oder Corten. Die Kollektion zeichnet sich durch minimalistische Formen und den leicht zurückgesetzten Diffusor aus, um Innen- und Außenräume von städtischen Einrichtungen und Bereichen individuell zu gestalten.

Ceiling lamp with aluminium fixture, available in white, black or corten finish. The collection features minimalist shapes and a slightly recessed diffuser for customising indoor and outdoor spaces of buildings and urban areas.



	colour
I-TOWER-Q1-BCO 8031414922093 FANEU00003827	
I-TOWER-Q1-NER 8031414922116 FANEU00003829	
I-TOWER-Q1-BRO 8031414922109 FANEU00003828	
1 x GX53	

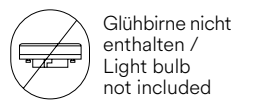
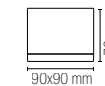

	colour
I-TOWER-R1-BCO 8031414918522 FANEU00003830	
I-TOWER-R1-NER 8031414918515 FANEU00003832	
I-TOWER-R1-BRO 8031414918539 FANEU00003831	
1 x GX53	

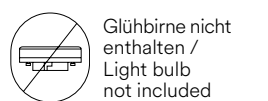
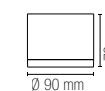

TOGO

Eine Kollektion von LED-Wandleuchten aus Acryl, erhältlich in verschiedenen Geometrien und Größen. Bietet drei Farbtemperaturen, hervorragenden Schutz vor Staub und Flüssigkeiten und hohe Farbwiedergabe. Eine Lösung für eine minimalistische, doch dabei hochwertige Beleuchtung. A collection of LED ceiling lamps in acrylic, available in various shapes and sizes. Featuring three colour temperatures, it provides excellent protection against dust and liquids, and high colour rendering. A solution for minimalist yet high-quality lighting.



Technische Informationen / Technical information **TOGO**



- Material**
Acryl PMMA
- Farbe**
Weiß
- Wählbare Farbtemperatur**
3000K / 4000K / 6500K
- Driver**
eingebaut
- Material**
PMMA acrylic
- Colour**
white
- Selectable color temperature**
3000K / 4000K / 6500K
- Driver**
built-in driver



	colour temp.	colour
LED-TOGO-Q10 8031414883615 FANEU00007532 lumen	● ● ● ●	
watt	5W	
beam angle	120°	
		



	colour temp.	colour
LED-TOGO-Q25 8031414883646 FANEU00007533 lumen	● ● ● ●	
watt	20W	
beam angle	120°	
		



	colour temp.	colour
LED-TOGO-RT20 8031414883622 FANEU00007535 lumen	● ● ● ●	
watt	8W	
beam angle	120°	
		



	colour temp.	colour
LED-TOGO-RT30 8031414883639 FANEU00007536 lumen	● ● ● ●	
watt	12W	
beam angle	120°	
		

ISCHIA

Wandleuchte mit Gehäuse aus weißem Thermoplast und transparentem Diffusor mit diamantartiger Wirkung. Mit integrierter LED, CCT-Technologie und hoher Farbwiedergabe, bietet Schutz vor Staub, Flüssigkeiten und Stößen, für eine hervorragende Beständigkeit in Außen- und Innenumgebungen. Ceiling lamp with white thermoplastic fixture and diamond-effect transparent diffuser. With integrated LED, CCT technology and high colour rendering, it provides protection against dust, liquids and impacts, for optimum durability in outdoor and indoor spaces.

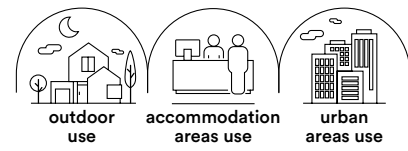

CAPRI

Deckenleuchte mit transparentem Diffusor mit diamantartiger Wirkung auf weißem Gehäuse aus Thermoplast. Mit integrierter LED und einstellbarer Farbtemperatur und so sowohl für Innen- als auch für Außenumgebungen von städtischen Bereichen oder Räumlichkeiten von Beherbergungsbetrieben geeignet. Ceiling light with white thermoplastic body and transparent diffuser with diamond effect. With integrated LED and adjustable colour temperature, it is ideal for indoor spaces, urban areas or hospitality spaces.



In.tec light DECKENLEUCHTEN / CEILING LAMPS

Material
Thermoplast

Farbtemperatur
3000K / 4000K



Driver
eingebaut

Material
thermoplastic

Colour temperature
3000K / 4000K



Driver
built-in



LED-ISCHIA-L-BCO

8031414883608
FANEU00006510
lumen

colour temp.	colour
2400 lm	

watt	20W
beam angle	100°

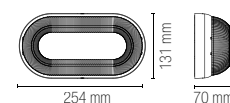

Materiale
Thermoplast

Farbtemperatur
3000K / 4000K



Driver
eingebaut

Material
thermoplastic

Colour temperature
3000K / 4000K



Driver
built-in



colour temp.	colour
2440 lm	

watt	20W
beam angle	120°

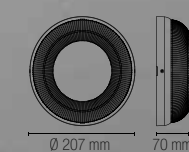

LED-CAPRI-S-BCO

8031414883585
FANEU00005944
lumen

colour temp.	colour
3550 lm	

watt	28W
beam angle	120°

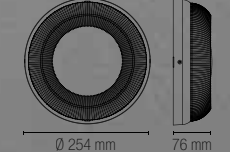

ALWAYS

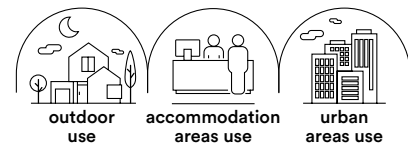

Material
PC + PC

Farbtemperatur

2700K / 3000K / 4000K / 5000K / 6500K



Driver
eingebaut

Material
PC + PC

Colour temperature

2700K / 3000K / 4000K / 5000K / 6500K



Driver
built-in



Deckenleuchte aus Thermoplast mit internem Leistungs- und Farbtemperaturwähler. Der Artikel ist außerdem mit integriertem 5.8-GHz-Radarsensor mit Bewegungs- und Dämmerungsfunktion und Taste zur Einstellung der Dauer ausgestattet.

Ceiling lamp in thermoplastic with integrated power and colour temperature selector. The product also features an integrated 5.8GHz radar sensor with motion and twilight functions and duration adjustment button.

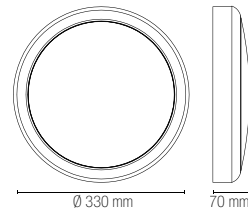

HUBLOT SENS

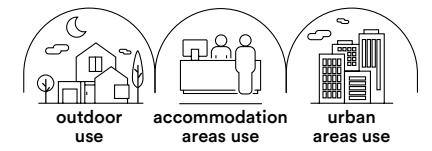

Material
PC + PC

Farbtemperatur
3000K / 4300K / 6500K



Driver
eingebaut

Material
PC + PC

Colour temperature
3000K / 4300K / 6500K



Driver
built-in



Deckenleuchte aus Thermoplast mit internem Farbtemperaturwähler und integriertem und einstellbarem Mikrowellen-Bewegungssensor zur optimalen Steuerung der Beleuchtung und der Energieeinsparung.

Ceiling lamp in thermoplastic with integrated colour temperature selector and adjustable microwave motion sensor for optimum lighting control and energy saving.

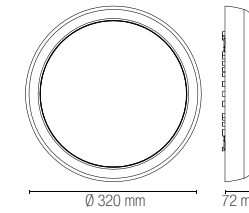

LED-ALWAYS-RS
8031414926923
FANEU00005764
lumen

colour temp.	colour
max 3120	

watt	15W / 20W / 25W
beam angle	120°
pf	0.90



Sensormodus: OFF - nur Bewegung - Dämmerung + Bewegung /
Sensor mode: OFF - motion only - dusk + motion

Auswahl der Einschaltdauer mit Bewegungssensor 30 s - 60 s - 180 s /
Motion sensor duration selection: 30S - 60S - 180S

Auswahl Grad Kelvin: 2700 K 3000 K 4000 K 5000 K 6500 K /
Kelvin degrees selection: 2700K 3000K 4000K 5000K 6500K

Leistungsauswahl: 15 W 20 W 25 W /
Power selection: 15W 20W 25W



LED-HUBLOT-SENS
8031414919604
FANEU00006442
lumen

colour temp.	colour
2500 lm	

watt	18W
beam angle	120°
pf	0.90

Enthaltenes Zubehör / Accessories included

Bewegungssensor 100 % Licht
Nach 30 Sekunden 20 % Licht /
Motion sensor 100% light
After 30 seconds 20% light

Sensor regulierbar mit LED-SENSOR-REMOTE S. 440
adjustable sensor with LED-SENSOR-REMOTE p. 440

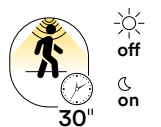

In.tec light DECKENLEUCHTEN / CEILING LAMPS



Deckenleuchte mit integrierter LED, Bewegungs- und Farbtemperatursensor (Kelvin), beide einstellbar. Der weiße Diffusor aus Polycarbonat ist mit einem Gehäuse aus polypropylenbasiertem Material kombiniert und in den Finishes Weiß oder Anthrazit erhältlich.

Ceiling lamp with integrated LED, with adjustable motion sensor and Kelvin setting. The white polycarbonate diffuser is matched with a base body in PP, available in white or anthracite finish.

Material
PP + PC

Farbe
Weiß
Anthrazit

Farbtemperatur
3000K / 4000K

Driver
eingebaut

Material
PP + PC

Colour
white
anthracite

Colour temperature
3000K / 4000K

Driver
built-in



Enthaltenes Zubehör / Accessories included

Regulierbarer
Bewegungssensor /
Adjustable
motion sensor

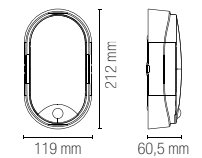
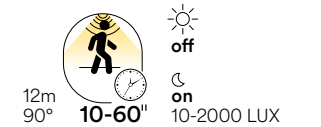

	colour temp.	colour
LED-SENSITIVE-C BCO 8031414876815 FANEU00007345 lumen		
	1400 lm	
LED-SENSITIVE-BCO 8031440361750 FANEU00007344 lumen		
	1600 lm	
LED-SENSITIVE-ANT 8031440361743 FANEU00007343 lumen		
	1600 lm	
watt	14W	
beam angle	120°	

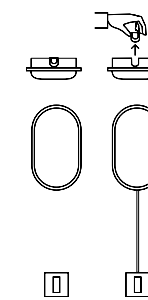

Doppeltes
Installationssystem /
Double installation system



Deckenleuchte mit integrierter LED, Basis aus weißem oder anthrazitfarbenem PP und weißem Diffusor aus Polycarbonat. Mit doppeltem Installationssystem und Auslegung für Anlagen mit externen Kabelkanälen.

Ceiling lamp with integrated LED, white or anthracite PP base and white polycarbonate diffuser. With dual installation system and provision for systems with external conduits.

Material

PP + PC

Farbe

Weiß
Anthrazit



Farbtemperatur

4000K



Driver

eingebaut

Material

PP + PC

Colour

white
anthracite



Colour temperature

4000K



Driver

built-in

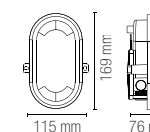

	colour temp.	colour
LED-EXTRA-BCO 8031440361071 FANEU00006220 lumen		
LED-EXTRA-ANT 8031440361064 FANEU00006219 lumen		
	1100 lm	1100 lm
watt	10W	
beam angle	120°	

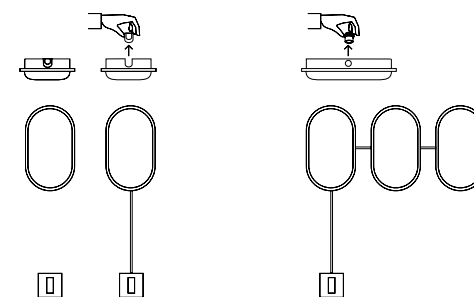

Doppeltes Installationssystem / Double installation system

Geeignet für Installationen mit externen Kabelkanälen / Surface mount cable ducts connections



Deckenleuchte mit Diffusor und Basis aus Polycarbonat in den Farben Weiß und Anthrazit. Mit CCT-Funktion für doppelte Farbtemperatur, entweder warm oder neutral. Garantiert Beständigkeit gegen Witterungseinflüsse und Belechtungskomfort.
 Ceiling lamp with white or anthracite polycarbonate diffuser and base. It features a CCT function for dual colour temperature, warm or neutral. It guarantees weather resistance and lighting comfort.

Material
PC + PC

Farbe
Weiß
Anthrazit

Farbtemperatur
3000K / 4000K



Driver
eingebaut

Material
PC + PC

Colour
white
anthracite

Colour temperature
3000K / 4000K



Driver
built-in

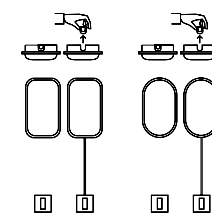

Doppeltes
Installationsystem /
Double
installation system



	colour temp.	colour
LED-SHELLY-Q-S BCO 8031414085507 FANEU00007386 lumen		
	1900 lm	
LED-SHELLY-Q-S ANT 8031414862009 FANEU00007385 lumen		
	1900 lm	
watt	15W	
beam angle	120°	

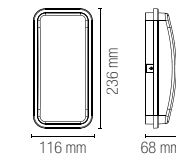

	colour temp.	colour
LED-SHELLY-Q-L BCO 8031414862016 FANEU00007381 lumen		
	2510 lm	
LED-SHELLY-Q-L ANT 8031414862023 FANEU00007380 lumen		
	2510 lm	
watt	20W	
beam angle	120°	

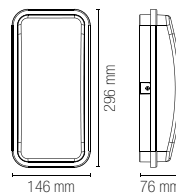

	colour temp.	colour
LED-SHELLY-S BCO 8031440351720 FANEU00007389 lumen		
	1900 lm	
LED-SHELLY-S ANT 8031440351706 FANEU00007388 lumen		
	1900 lm	
watt	15W	
beam angle	120°	

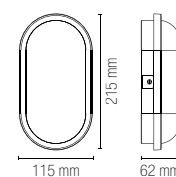

	colour temp.	colour
LED-SHELLY-L BCO 8031440351713 FANEU00007378 lumen		
	2510 lm	
LED-SHELLY-L ANT 8031440351690 FANEU00007377 lumen		
	2510 lm	
watt	20W	
beam angle	120°	

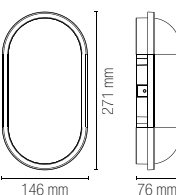



Deckenleuchte aus Polycarbonat mit Basis in den Finishes Weiß oder Anthrazit. Das weiche und minimalistische Design macht sie perfekt für die Verwendung in Indoor- oder Outdoor-Umgebungen. Mit auswählbarem CCT und technischen Eigenschaften für die Installation im Freien.

Ceiling lamp in polycarbonate with base in white or anthracite finish. Its sleek, minimalist design makes it perfect for both indoor or outdoor spaces. With selectable CCT and technical features for outdoor installation.

Material

PC + PC

Farbe

Weiß
Anthrazit



Farbtemperatur

3000K / 4000K



Driver

eingebaut

Material

PC + PC

Colour

white
anthracite



Colour temperature

3000K / 4000K



Driver

built-in



LED-EVER-Q-S BCO

8031414862238
FANEU00006198

lumen

colour temp. | colour



1870 lm

LED-EVER-Q-L BCO

8031414862276
FANEU00006195

lumen

colour temp. | colour



3470 lm

LED-EVER-Q-S ANT

8031414862269
FANEU00006197

lumen



1900 lm

LED-EVER-Q-L ANT

8031414862283
FANEU00006194

lumen



3470 lm

watt	15W
beam angle	120°
pf	-

watt	28W
beam angle	120°
pf	0.90

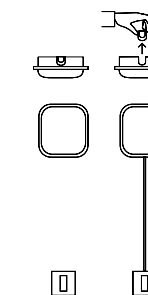
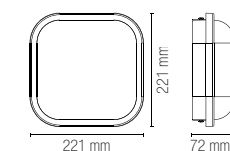
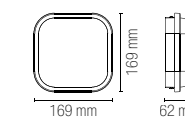

Doppeltes
Installationssystem /
Double installation system

Deckenleuchte mit integrierter LED mit CCT mit zwei Temperaturen. Der Artikel besteht aus Diffusor und Gehäuse aus Polycarbonat in den Farben Weiß und Anthrazit. Mit auswählbarem CCT und technischen Eigenschaften für die Installation im Freien.
 Ceiling lamp with integrated LED, with dual CCT. The product consists of a polycarbonate diffuser and body in white and anthracite. With selectable CCT and technical features for outdoor installation.



	colour temp.	colour
LED-EVER-LP BCO 8031440355650 FANEU00006193 lumen		
	2500 lm	
LED-EVER-LP ANT 8031440355643 FANEU00006192 lumen		
	2500 lm	
watt	20W	
beam angle	120°	
pf	-	

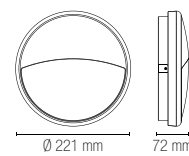

	colour temp.	colour
LED-EVER-XLP BCO 8031440355636 FANEU00006209 lumen		
	3750 lm	
LED-EVER-XLP ANT 8031440355629 FANEU00006208 lumen		
	3750 lm	
watt	28W	
beam angle	120°	
pf	0.90	

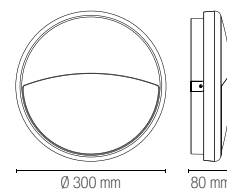

- Material**
PC + PC
- Farbe**
Weiß
Anthrazit
- Farbtemperatur**
3000K / 4000K
- Driver**
eingebaut
- Material**
PC + PC
- Colour**
white
anthracite
- Colour temperature**
3000K / 4000K
- Driver**
built-in

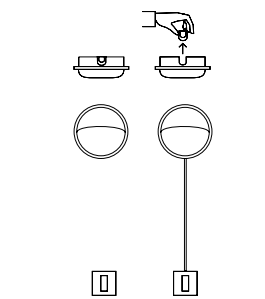

Doppeltes Installationssystem / Double installation system

Deckenleuchte mit integrierter LED und zentralem Diffusor und Basis aus Polycarbonat in den Finishes Weiß oder Anthrazit. Für die Anbringung an Decke oder Wand weist sie ein doppeltes Installationssystem auf. Bietet CCT-Beleuchtung mit warmem und neutralem Licht, hohen Sehkomfort und Schutz vor Stößen, Staub und Flüssigkeiten.
 Ceiling lamp with integrated LED, with central diffuser and base in polycarbonate with white or anthracite finish. It features a dual installation system for ceiling or wall mounting. It provides CCT lighting with warm and neutral light, high visual comfort and protection against impacts, dust and liquids.

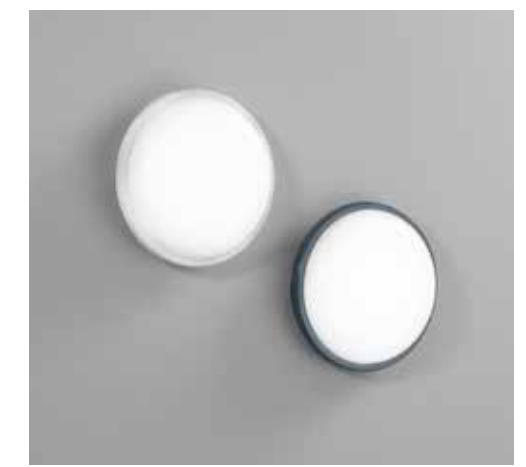
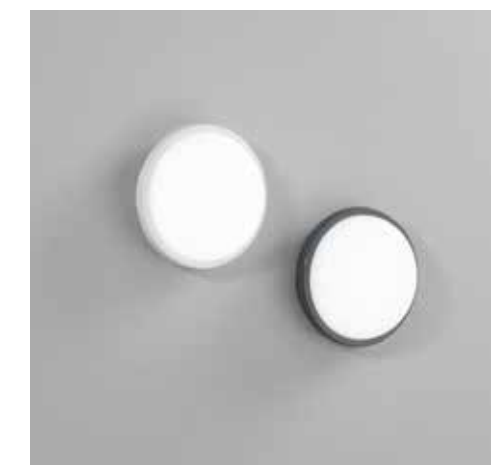

	colour temp.	colour
LED-EVER-S BCO 8031440351683 FANEU00006201 lumen		
	1900 lm	
LED-EVER-S ANT 8031440351638 FANEU00006200 lumen		
	1900 lm	
watt	15W	
beam angle	120°	
pf	-	

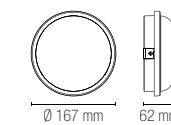

	colour temp.	colour
LED-EVER-L BCO 8031440351676 FANEU00006190 lumen		
	2500 lm	
LED-EVER-L ANT 8031440351645 FANEU00006189 lumen		
	2500 lm	
watt	20W	
beam angle	120°	
pf	0.90	

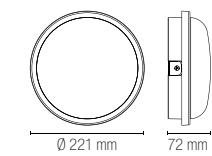

- Material**
PC + PC
- Farbe**
Weiß
Anthrazit
- Farbtemperatur**
3000K / 4000K
- Driver**
eingebaut
- Material**
PC + PC
- Colour**
white
anthracite
- Colour temperature**
3000K / 4000K
- Driver**
built-in

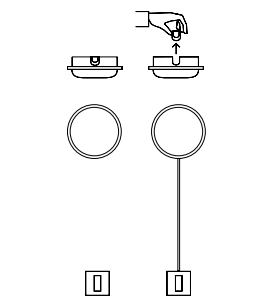

Doppeltes Installationssystem / Double installation system



Material
PC + PC

Farbe
Weiß
Silber



Farbtemperatur
3000K / 4000K



Driver
eingebaut

Material
PC + PC

Colour
white
silver



Colour temperature
3000K / 4000K



Driver
built-in

Die Deckenleuchte Ever in der Maxi-Version, mit CCT-Einstellung der Farbtemperatur, doppeltem Installationssystem an Wand oder Decke, hoher Farbwiedergabe und Schutz vor Stößen, Flüssigkeiten und Staub.

Ever ceiling lamp in maxi version, with CCT adjustment, dual wall or ceiling installation, high colour rendering and protection against impacts, liquids and dust.

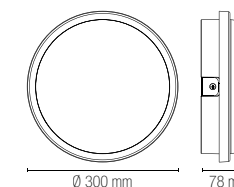

	colour temp.	colour
LED-EVER-XL BCO 8031440355612 FANEU00006203 lumen		
	3750 lm	
LED-EVER-XL SIL 8031440355605 FANEU00006204 lumen		
	3750 lm	

watt	28W
beam angle	120°
pf	0.90

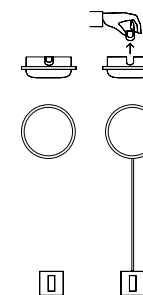

Doppeltes Installationssystem / Double installation system

SPEEDY

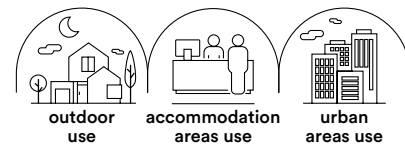

FLIPPY

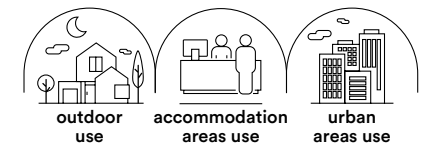

Material
PC

Farbe
Weiß

Farbtemperatur
3000K / 4000K



Driver
eingebaut

Material
PC

Colour
white

Colour temperature
3000K / 4000K



Driver
built-in



Deckenleuchte mit Basis und Diffusor aus weißem Polycarbonat. Mit elegantem und diskretem Design, um sich in Außen- oder Innenbereiche einzufügen, bietet umfassenden Schutz gegen Staub und Beständigkeit gegen Wasserstrahlen aus jeder Richtung.

Ceiling lamp with white polycarbonate base and diffuser. With an elegant, understated design, for use in outdoor or indoor spaces, it provides full protection against dust and resistance to water jets from any direction.

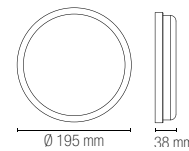

Material
PC

Farbe
Weiß

Farbtemperatur
3000K / 4000K



Driver
eingebaut

Material
PC

Colour
white

Colour temperature
3000K / 4000K



Driver
built-in



Deckenleuchte mit Basis und Diffusor aus weißem Polycarbonat. Erhältlich in zwei Farbtemperaturen, bietet Langlebigkeit in Innenumgebungen und hervorragende Beständigkeit gegen Staub und Witterungseinflüsse für die Verwendung in Outdoor-Bereichen.

Ceiling lamp with white polycarbonate base and diffuser. Available with dual colour temperatures, it provides durability in indoor spaces and optimum protection against dust and atmospheric agents for mounting in outdoor spaces.

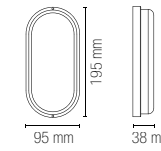

	colour temp.	colour
LED-SPEEDY-18C 8031414922000 FANEU00007435 lumen		
	1800 lm	
watt	18W	
beam angle	120°	
LED-SPEEDY-18M 8031414922017 FANEU00007436 lumen		
	1800 lm	
watt	18W	
beam angle	120°	



	colour temp.	colour
LED-FLIPPY-12C 8031414922024 FANEU00006228 lumen		
	1160 lm	
watt	12W	
beam angle	120°	
LED-FLIPPY-12M 8031414922031 FANEU00006229 lumen		
	1160 lm	
watt	12W	
beam angle	120°	



Deckenleuchte aus UV-beständigem Polycarbonat mit Gehäuse für Sensor mit einstellbarer Bewegungs- und Dämmerungsfunktion. Erhältlich in der weißen oder schwarzen Version, bietet für die sichere Anbringung in öffentlichen Bereichen höchsten Schutz gegen Stöße.

Anti-UV polycarbonate ceiling light with housing for sensor with adjustable movement and twilight functions. Available in white or black version, it provides maximum protection against impacts for safe installation in public places.

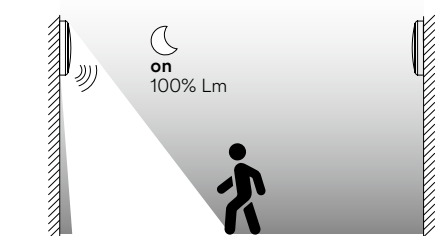

I-ALYCE-PL-BCO
8031414937516
FANEU00027379

1 x E27

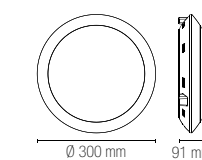

colour



Bewegungs- und Dämmerungssensor über Schalter regulierbar
Abstand: 1, 2, 3, 5 Meter
Einschaltdauer 20 s, 40 s, 5 min, 10 min
Dämmerungssensor: Tag, 50 Lux, 30 Lux, Nacht /
Functions of the motion and crepuscular sensor adjustable via switch
distance: 1, 2, 3, 5 meters
on duration: 20s, 40s, 5 min, 10 min
crepuscular: day, 50lux, 30lux, night



Sicherheitssperre für den Einsatz des Geräts an öffentlichen Orten / Safety lock for using the device in public places

TURTLE



TURTLE



DECKENLEUCHTEN / CEILING LAMPS

In.tec light

TURTLE

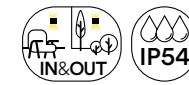

Technische Informationen / Technical information **TURTLE**



Weiße oder schwarze Deckenleuchte mit Struktur aus Thermoplast und Diffusor aus Glas. Erhältlich mit runder oder ovaler Form, in verschiedenen Modellen mit verschiedenen Geometrien für das Gitter ausgelegt, um sich an den architektonischen Stil anzupassen.
Ceiling lamp in white or black with thermoplastic fixture and glass diffuser. Available in circular or oval shape, it comes in several versions with different grid shapes to match the architectural style.



colour

I-TURTLE-AP-B-BCO
8031414935413
FANEU00026252



I-TURTLE-AP-B-NER
8031414935420
FANEU00026253



1 x E27

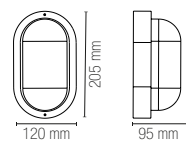

colour

I-TURTLE-AP-P-BCO
8031414935437
FANEU00026255



I-TURTLE-AP-P-NER
8031414935444
FANEU00026254



1 x E27

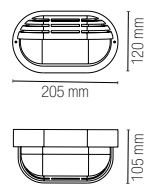

colour

I-TURTLE-AP-BCO
8031414918577
FANEU00003873



I-TURTLE-AP-NER
8031414918560
FANEU00003875



1 x E27

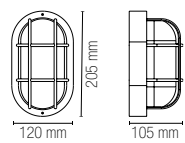

colour

I-TURTLE-PL-B-BCO
8031414935451
FANEU00026256



I-TURTLE-PL-B-NER
8031414935468
FANEU00026257



1 x E27

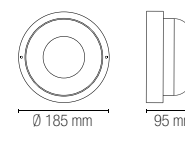

colour

I-TURTLE-PL-P-BCO
8031414935475
FANEU00026258



I-TURTLE-PL-P-NER
8031414935482
FANEU00026259



1 x E27

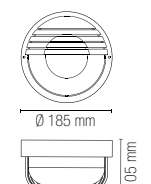

colour

I-TURTLE-PL-BCO
8031414918553
FANEU00003877



I-TURTLE-PL-NER
8031414918546
FANEU00003879



1 x E27

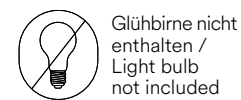
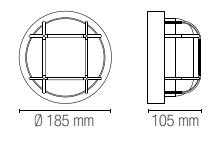

Glühbirne nicht
enthalten /
Light bulb
not included



Glühbirne nicht
enthalten /
Light bulb
not included



Kombinierte Wand-, Hänge- und Bodenleuchten / Wall, suspension and floor lamps combined
outdoor



- Material**
Aluminium
- Farbe**
Geprägt, Anthrazit
- Wählbare Farbtemperatur**
3000K / 3500K / 4000K
- Driver**
eingebaut
- Material**
aluminum
- Colour**
embossed anthracite
- Selectable color temperature**
3000K / 3500K / 4000K
- Driver**
built-in



Kollektion aus Aluminiumdruckguss mit integrierter LED und auswählbarer Farbtemperatur. Umfasst auch ein Modell mit 2 Metern Höhe, dessen idealer Verwendungsort Beherbergungsbetriebe wie Restaurants und Hotels sind.
 A collection in die-cast aluminium with integrated LED and selectable colour temperature. It also includes a 2-metre high version, ideal for hospitality spaces such as restaurants and hotels.



	colour temp.	colour
LED-KHALIFA-P100 8031414949014 FANEU00028507 lumen		
	3683 lm	
watt	25W	
beam angle	280°	

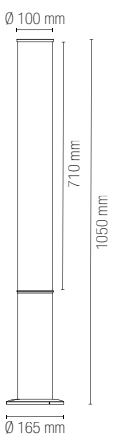

	colour temp.	colour
LED-KHALIFA-P200 8031414949021 FANEU00028508 lumen		
	5379 lm	
watt	43W	
beam angle	280°	



NEEDLE



Technische Informationen / Technical information **NEEDLE**



Material
Aluminium

Material
aluminum

Farbe
Geprägt, Anthrazit
Geprägt, Corten

Colour
embossed anthracite
embossed corten



**Wählbare
Farbtemperatur**
3000K

**Selectable color
temperature**
3000K



Driver
eingebaut

Driver
built-in



Kollektion aus Aluminiumdruckguss mit integrierter LED. Erhältlich in den geprägten Finishes Anthrazit oder Corten, bietet auch eine Version mit kompakten Abmessungen, die als Orientierungsleuchte konzipiert ist.

A collection in die-cast aluminium with integrated LED. Available in anthracite or corten embossed finish, it also comes in a compact version designed as a step light.



	colour temp.	colour
LED-NEEDLE-P30-ANT 8031414949038 FANEU00028509 lumen	3000K	anthracite
LED-NEEDLE-P30-BRO 8031414949045 FANEU00028510 lumen	3000K	corten
watt	6W	
beam angle	142°	

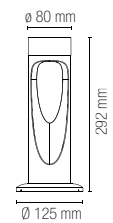

	colour temp.	colour
LED-NEEDLE-P80-ANT 8031414949052 FANEU00028511 lumen	3000K	anthracite
LED-NEEDLE-P80-BRO 8031414949069 FANEU00028512 lumen	3000K	corten
watt	6W	
beam angle	142°	

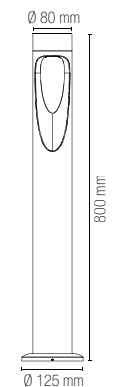

In.tec light KOMBINIERTE WAND-, HÄNGE- UND BODENLEUCHTEN / WALL-, SUSPENSION AND FLOOR LAMPS COMBINED

LUMINA

Abwechslungsreiche Kollektion aus Metall in der Farbe Anthrazit mit integriertem LED-Lichtpunkt. Ideal für moderne und elegante Stadt- oder Gewerbebereiche. In der Wandleuchtenversion kann Lumina auch als Orientierungsleuchte eingesetzt werden.

A mixed collection in metal with anthracite finish, with integrated LED light point. Ideal for urban spaces or elegant, modern retail spaces. In the wall version, Lumina can also be used as a wall light.

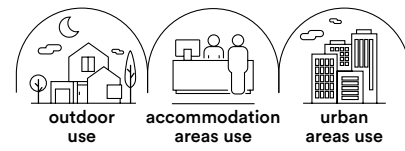

Technische Informationen / Technical information

LUMINA



Material
Aluminium

Farbe
anthracite

Farbtemperatur
3000K / 4000K

Driver
eingebaut

Material
aluminium

Colour
anthracite

Colour temperature
3000K / 4000K

Driver
built-in



	colour temp.	colour
LED-LUMINA-AP 8031414922864 FANEU00025981 lumen	3000K / 4000K	anthracite
watt	12W	
beam angle	120°	
pf	-	

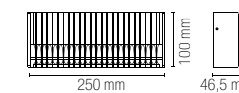

	colour temp.	colour
LED-LUMINA-P40 8031414935871 FANEU00027279 lumen	3000K / 4000K	anthracite
watt	11W	
beam angle	220°	
pf	-	

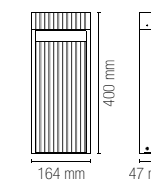

	colour temp.	colour
LED-LUMINA-P80 8031414922871 FANEU00027280 lumen	3000K / 4000K	anthracite
watt	11W	
beam angle	120°	

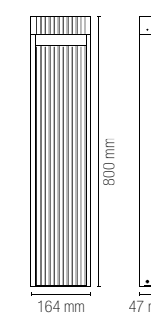

	colour temp.	colour
LED-LUMINA-P230 8031414922888 FANEU00027281 lumen	3000K / 4000K	anthracite
watt	26W	
beam angle	120°	
pf	0.90	

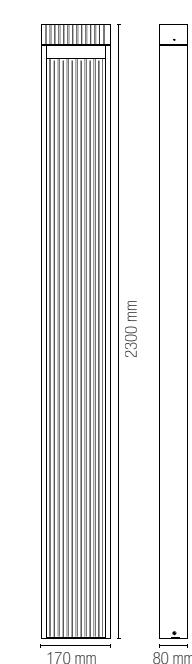

KOMBINIERTE WAND-, HÄNGE- UND BODENLEUCHTEN / WALL, SUSPENSION AND FLOOR LAMPS COMBINED

In.tec light

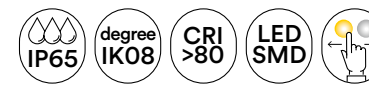
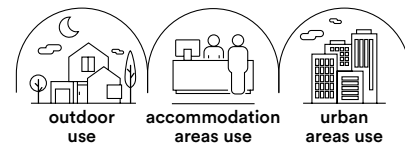

- Material**
Aluminium

- Farbe**
Geprägt, Anthrazit
Geprägt, Corten
-

- Wählbare Farbtemperatur**
3000K / 4000K
-

- Driver**
eingebaut

- Material**
aluminium

- Colour**
embossed anthracite
embossed corten
-

- Selectable color temperature**
3000K / 4000K
-

- Driver**
built-in



Kollektion aus Aluminiumdruckguss mit integrierter LED und auswählbarer Farbtemperatur. In den Farben Anthrazit oder geprägtem Corten, um sich diskret einzufügen, garantiert optimalen Schutz vor Stößen und Witterungseinflüssen.
A collection in die-cast aluminium with integrated LED and selectable colour temperature. Available in anthracite or corten embossed finish for subtle integration, it ensures excellent protection against impacts and atmospheric agents.

		colour temp.	colour	
		LED-WAMI-AP-ANT 8031414890026 FANEU00007907 lumen 1530 lm		
		LED-WAMI-AP-BRO 8031414890057 FANEU00007908 lumen 1530 lm		
		watt	12W	
		beam angle	120°	

		colour temp.	colour	
		LED-WAMI-P25-ANT 8031414890033 FANEU00007911 lumen 1530 lm		
		LED-WAMI-P25-BRO 8031414890064 FANEU00007912 lumen 1530 lm		
		watt	12W	
		beam angle	120°	

		colour temp.	colour	
		LED-WAMI-P80-ANT 8031414890040 FANEU00007913 lumen 1530 lm		
		LED-WAMI-P80-BRO 8031414890071 FANEU00007914 lumen 1530 lm		
		watt	12W	
		beam angle	120°	



LED-Wand- oder Bodenleuchte aus Metall mit minimalistischem und erlesenem Design, das durch die drei Farbvarianten verstärkt wird: Weiß, Anthrazit oder Bronze. Bietet hohe Farbwiedergabe und Schutz vor Stößen, Staub und Flüssigkeiten.
 LED wall lamp and bollard light in metal with a sophisticated and minimalist design, enhanced in three colour versions: white, anthracite or bronze. It provides high colour rendering and protection against impacts, dust and liquids.



	colour temp.	colour
LED-MOBULA-AP-BCO 8031414931552 FANEU00027315 lumen	1100 lm	
LED-MOBULA-AP-ANT 8031414931569 FANEU00027314 lumen	1100 lm	
LED-MOBULA-AP-BRO 8031414931576 FANEU00027316 lumen	1100 lm	
watt	8W	
beam angle	120°	

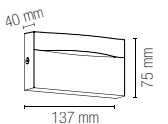

	colour temp.	colour
LED-MOBULA-P70-BCO 8031414931583 FANEU00027318 lumen	1100 lm	
LED-MOBULA-P70-ANT 8031414931590 FANEU00027317 lumen	1100 lm	
LED-MOBULA-P70-BRO 8031414931606 FANEU00027319 lumen	1100 lm	
watt	8W	
beam angle	120°	

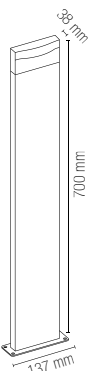

- Material**
Aluminium
- Farbe**
Geprägt, Weiß
Geprägt, Anthrazit
Geprägt, Corten
- Wählbare Farbtemperatur**
3000K
- Driver**
inklusive
- Material**
aluminium
- Colour**
embossed white
embossed anthracite
embossed corten
- Selectable color temperature**
3000K
- Driver**
included



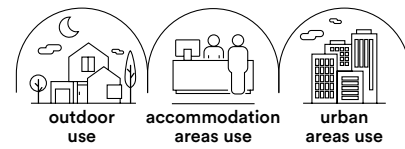

Kollektion aus Aluminium im Finish Weiß oder geprägtes Anthrazit mit integrierter LED und zwei wählbaren Farbtemperaturen. Das besondere Design wird als Boden- und Wandleuchte ausgelegt, auch mit Bewegungssensoren erhältlich.
 A collection in aluminium with white or anthracite finish, with integrated LED and selectable dual colour temperatures. A unique design in a bollard light or wall lamp version, also available with motion sensors.

		LED-SAIL-AP-BCO 8031414918614 FANEU00007319	colour temp. colour	
		lumen	1440 lm	
		LED-SAIL-AP-ANT 8031414920174 FANEU00007318	colour temp. colour	
		lumen	1440 lm	
		watt	12W	
		beam angle	180°	

		LED-SAIL-APS-BCO 8031414920181 FANEU00007322	colour temp. colour	
		lumen	1440 lm	
		LED-SAIL-APS-ANT 8031414918621 FANEU00007321	colour temp. colour	
		lumen	1440 lm	
		watt	12W	
		beam angle	180°	

Enthaltenes Zubehör / Accessories included

Bewegungssensor maximale Entfernung 6m, 120° /
 Motion sensor maximum distance 6m, 120°

on 20% LM <20 LUX 30" sec 8m - 120° OFF

		LED-SAIL-P90-BCO 8031414918638 FANEU00007326	colour temp. colour	
		lumen	1440 lm	
		LED-SAIL-P90-ANT 8031414918645 FANEU00007325	colour temp. colour	
		lumen	1440 lm	
		watt	12W	
		beam angle	180°	

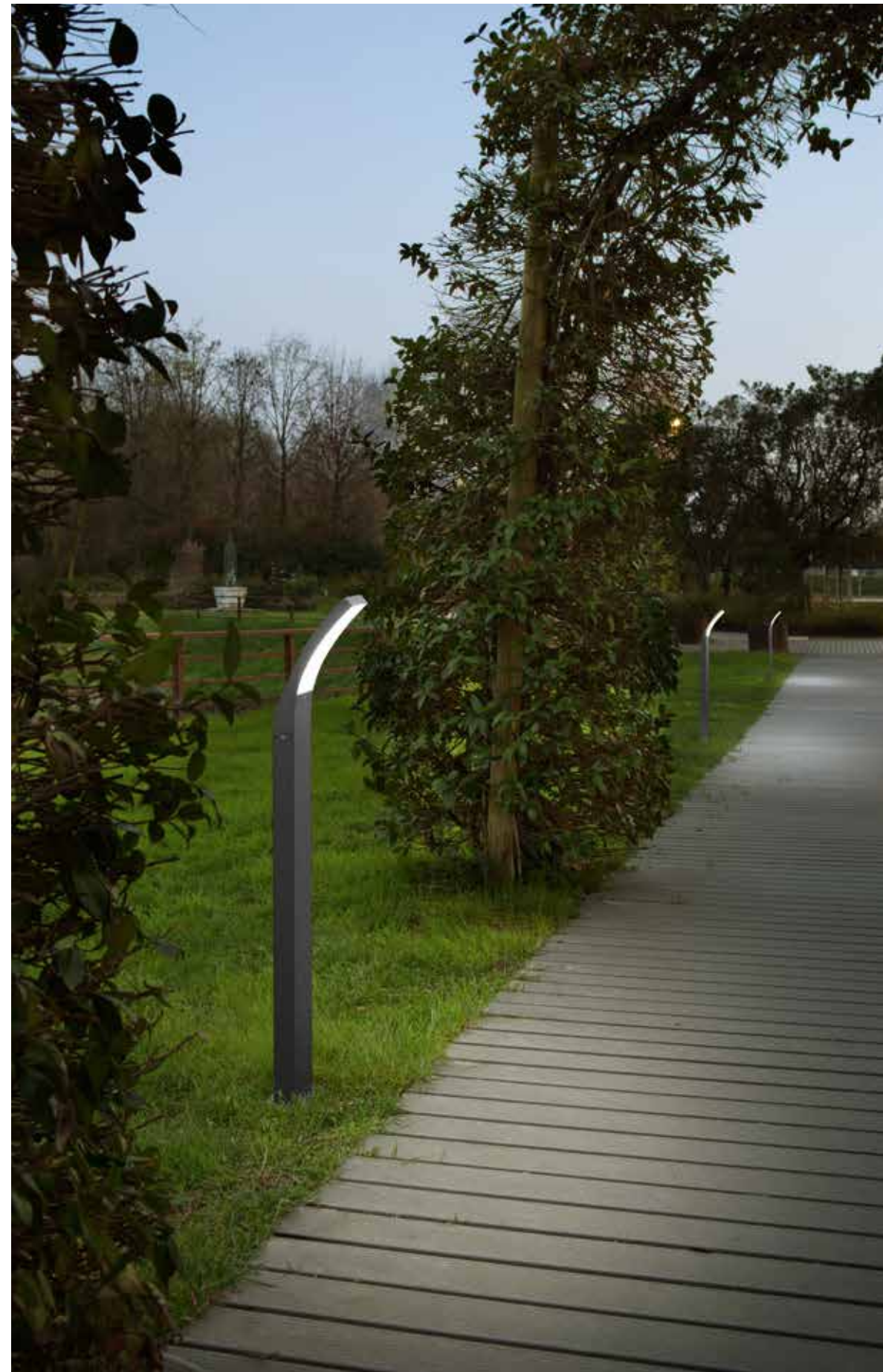

- Material**
Aluminium
- Farbe**
Geprägt, Weiß
Geprägt, Anthrazit
- Farbtemperatur**
3000K / 4000K
- Driver**
eingebaut
- Material**
aluminium
- Colour**
embossed white
embossed anthracite
- Colour temperature**
3000K / 4000K
- Driver**
built-in

DISCOVERY

Kollektion mit integrierter Led aus Aluminium mit geprägtem anthrazitfarbenem Finish. Garantiert eine extrem hohe Farbwiedergabe und Schutz vor Staub, Wasser und Stößen. Die Bodenversion ist mit doppeltem Versorgungsanschluss ausgestattet.

A collection with integrated LED in aluminium with anthracite embossed finish. Excellent colour rendering and protection against dust, water and impacts. The bollard light version is fitted with a dual power socket.





Material
Aluminium

Farbe
Geprägt, Anthrazit

Farbtemperatur
4000K

Driver
eingebaut

Material
aluminium

Colour
embossed anthracite

Colour temperature
4000K

Driver
built-in



LED-DISCOVERY-AP
8031414877836
FANEU00006048

	colour temp.	colour
lumen	1440 lm	
watt	13W	
beam angle	360°	

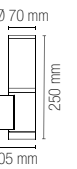

LED-DISCOVERY-P65
8031414877850
FANEU00006056

	colour temp.	colour
lumen	1440 lm	
watt	13W	
beam angle	360°	



LED-DISCOVERY-HUB
8031414877867
FANEU00006050

	colour temp.	colour
lumen	1440 lm	
watt	13W	
beam angle	360°	

Plug 2X max 15A 250V 2500W





Lampe aus Aluminium mit integrierter LED und hoher Farbwiedergabe mit Finish aus geprägtem Anthrazit. Sowohl in der Wand- als auch in der Bodenlampenvariante sind die Lichtpunkte mit einer Neigung von bis zu 180° verstellbar.
 Lamp with integrated LED in aluminium, with high colour rendering and anthracite embossed finish. The wall lamp and the bollard light version feature adjustable light points, allowing tilting up to 180°.

- Material**
Aluminium
- Farbe**
Geprägt, Anthrazit
- Farbtemperatur**
4000K
- Driver**
eingebaut
- Material**
aluminium
- Colour**
embossed anthracite
- Colour temperature**
4000K
- Driver**
built-in

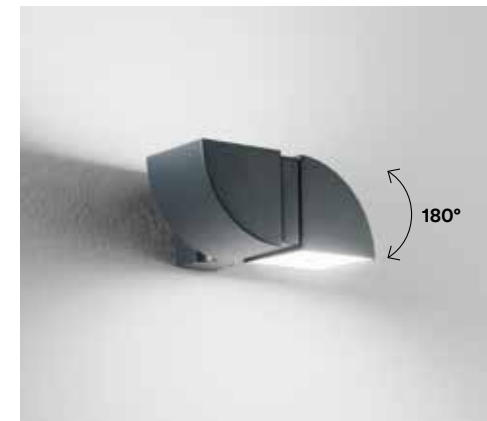

	colour temp.	colour
LED-IDEM-AP 8031414883103 FANEU00006453 lumen	840 lm	
watt	8W	
beam angle	120°	

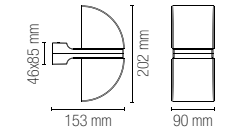

	colour temp.	colour
LED-IDEM-P1 8031414883110 FANEU00006454 lumen	840 lm	
watt	8W	
beam angle	120°	

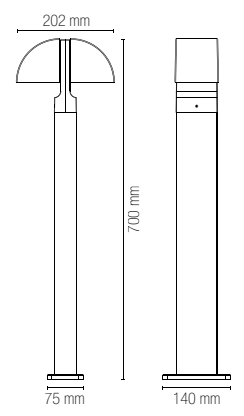

REVERSE



Technische Informationen / Technical information **REVERSE**



Lampe aus Aluminium mit integrierter LED und geprägtem anthrazitfarbenem Finish. Ihr stark prägender Stil ist in der Boden- oder Wandleuchtenversion mit verstellbarem Lichtpunkt zum Ausrichten des Lichtstrahls zu finden.
Lamp with integrated LED in aluminium with anthracite embossed finish. A striking style for a bollard light or wall light version, with adjustable light point to direct the beam.

- Material**
Aluminium
- Farbe**
Geprägt, Anthrazit
- Farbtemperatur**
4000K
- Driver**
eingebaut
- Material**
aluminium
- Colour**
embossed anthracite
- Colour temperature**
4000K
- Driver**
built-in

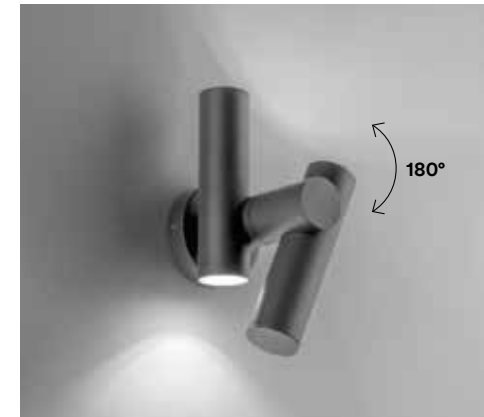

	colour temp.	colour
LED-REVERSE-AP 8031414883127 FANEU00007266 lumen	620 lm	
watt	7,5W	
beam angle	120°	

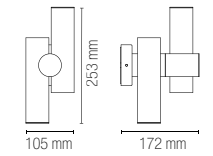

	colour temp.	colour
LED-REVERSE-P1 8031414883134 FANEU00007267 lumen	460 lm	
watt	5,3W	
beam angle	120°	

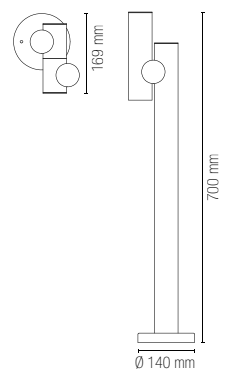

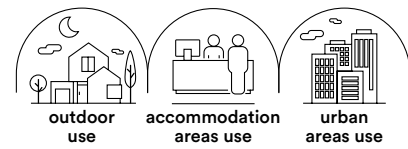

- Material**
Aluminium

- Farbe**
Geprägt, Anthrazit
Geprägt, Corten
-

- Wählbare Farbtemperatur**
3000K / 4000K
-

- Driver**
eingebaut

- Material**
aluminium

- Colour**
embossed anthracite
embossed corten
-

- Selectable color temperature**
3000K / 4000K
-

- Driver**
built-in



Leuchte aus Aluminium in den Finishes Anthrazit und geprägtes Corten mit integrierter LED und verstellbarer Lichttemperatur. Die ideale Wahl für die Außenbereiche von Beherbergungsstrukturen oder Stadtparks, bietet optimalen Schutz vor Staub, Flüssigkeiten und Stößen.
Lamp with integrated LED in aluminium with anthracite or corten embossed finish and adjustable light temperature. The ideal choice for the exteriors of hospitality facilities or urban parks, it provides excellent protection against dust, liquids and impacts.



	colour temp.	colour
LED-BITT-P28-ANT 8031414883011 FANEU00005862 lumen		
	1200 lm	
LED-BITT-P28-BRO 8031414883028 FANEU00005863 lumen		
	1200 lm	
watt	10W	
beam angle	120°	

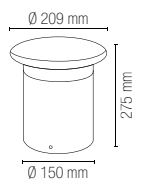

	colour temp.	colour
LED-BITT-P76-ANT 8031414883035 FANEU00005864 lumen		
	1200 lm	
LED-BITT-P76-BRO 8031414883042 FANEU00005865 lumen		
	1200 lm	
watt	10W	
beam angle	120°	

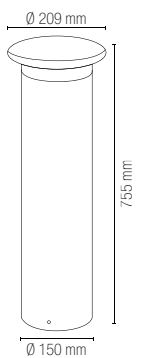



Material
Aluminium

Farbe
Geprägt, Weiß

Wählbare Farbtemperatur
3000K / 4000K



Driver
eingebaut

Material
aluminium

Colour
embossed white

Selectable color temperature
3000K / 4000K



Driver
built-in

Kollektion aus Aluminium mit integrierter LED und zwei auswählbaren Farbtemperaturen. Das Gehäuse von Wand- und Bodenlampe zeigt sich im geprägten Total-White-Finish, um sich harmonisch in moderne und prestigereiche Beherbergungsbetriebe einzufügen.

A collection in aluminium with integrated LED, with selectable colour temperatures. The wall light and bollard light fixture have a total white embossed finish to perfectly blend in with prestigious modern hospitality facilities.



	colour temp.	colour
LED-NISMO-AP 8031440361224 FANEU00006862 lumen		
	1430 lm	

watt	12W
beam angle	120°

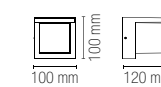

	colour temp.	colour
LED-NISMO-P60 8031440361231 FANEU00006864 lumen		
	1430 lm	

watt	12W
beam angle	120°

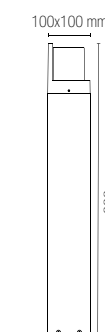



Kollektion aus Metall mit silbernem Finish in den Varianten als Wand- oder Bodenleuchte. Die moderne und elegante Booster kann sich harmonisch in zeitgemäße städtische Umgebungen oder Außen- und Durchgangsbereiche einfügen.
 A collection in metal with silver finish in a wall lamp and bollard light version. Modern and elegant, Booster harmoniously blends in with contemporary urban spaces, outdoor areas and walk-through areas.



Glühbirne nicht enthalten /
Light bulb not included



I-BOOSTER-AP
8031414918492
FANEU00001312

colour



1 x E27 MAX 40W

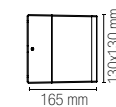

I-BOOSTER-P60
8031414918508
FANEU00001314

colour



1 x E27 MAX 40W

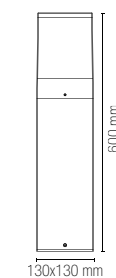



Kollektion aus Metall mit Finish in Anthrazit oder Corten, konzipiert zum Einfügen in besonders gepflegte Außenumgebungen. Mit umfassendem Schutz vor Staub und hervorragendem Spritzschutz.
 A collection in metal with anthracite or corten finish designed for installation in elegant outdoor spaces. With full protection against dust and excellent protection against splashes.

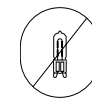

Glühbirne nicht enthalten / Light bulb not included



	colour
I-UNDERWOOD-P70-ANT 8031414883059 FANEU00003885	
I-UNDERWOOD-P70-BRO 8031414883066 FANEU00003886	

4 x G9 MAX 10W

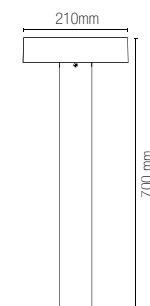

FOCUS

Kollektion von Wand- und Bodenleuchten aus Polycarbonat, erhältlich in den Farben Weiß und Schwarz und in der rechteckigen oder runden Variante. Für hervorragende Beständigkeit aus korrosionsfesten Materialien mit einem hohen Schutzgrad vor Witterungseinflüssen hergestellt.

A collection of polycarbonate wall lamps and bollard lights, available in black or white and in a square or round version. Made of anti-corrosive materials, it provides high protection against external agents, ensuring optimum durability.

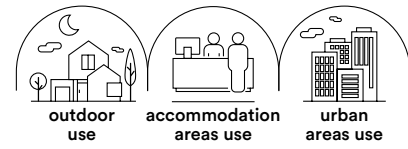

Technische Informationen / Technical information **FOCUS**



	colour
I-FOCUS-R-AP-BCO 8031414916290 FANEU00001965	
I-FOCUS-R-AP-NER 8031414916283 FANEU00001966	

1 x GU10 MAX 35W

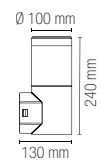

	colour
I-FOCUS-Q-AP-BCO 8031414916313 FANEU00001961	
I-FOCUS-Q-AP-NER 8031414916306 FANEU00001962	

1 x GU10 MAX 35W

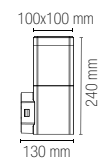

	colour
I-FOCUS-R-P-BCO 8031414916252 FANEU00001967	
I-FOCUS-R-P-NER 8031414916245 FANEU00001968	

1 x GU10 MAX 35W

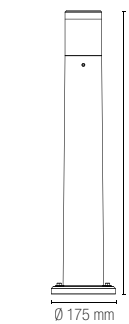

	colour
I-FOCUS-Q-P-BCO 8031414916276 FANEU00001963	
I-FOCUS-Q-P-NER 8031414916269 FANEU00001964	

1 x GU10 MAX 35W

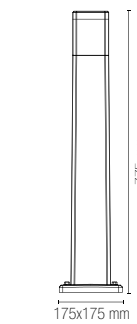

Nicht enthaltenes Zubehör /
Accessory not included



I-FOCUS-SPK
8031414929481
FANEU00027081
Zubehör für Befestigung mit Pflock /
Accessory for peg fixing

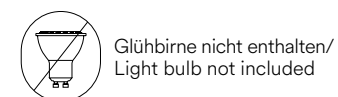

DARK

Kollektion aus Thermoplast im Farbton Anthrazit mit Diffusor aus Polycarbonat. Diskrete und funktionelle Boden- und Wandleuchten mit einstellbarem integriertem Bewegungssensor für die Beleuchtung von städtischen Bereichen oder Räumlichkeiten von Beherbergungsbetrieben.

A collection in anthracite thermoplastic with a polycarbonate diffuser. Understated and functional bollard lights and wall lamps feature an adjustable integrated motion sensor to illuminate urban areas and hospitality spaces.

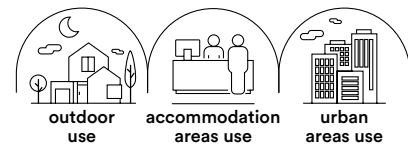

Technische Informationen / Technical information **DARK**



I-DARK-AP1
8031414918775
FANEU00001561

colour ●

1 x E27 MAX 25W

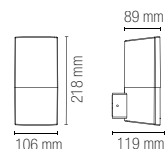

I-DARK-AP1-S
8031414919093
FANEU00001562

colour ●

1 x E27 MAX 25W

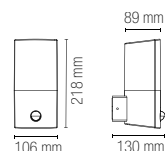

Enthaltenes Zubehör / Accessories included



Regulierbarer Bewegungssensor
max. Abstand 10 m 100° /
Adjustable motion sensor
max distance 10m 100°



I-DARK-AP2
8031414919109
FANEU00001563

colour ●

2 x E27 MAX 25W

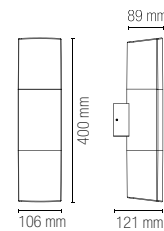

I-DARK-APV
8031414919116
FANEU00001564

colour ●

1 x E27 MAX 25W

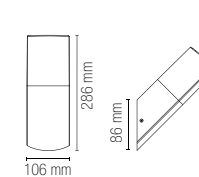

I-DARK-P1
8031414918782
FANEU00001566

colour ●

1 x E27 MAX 25W

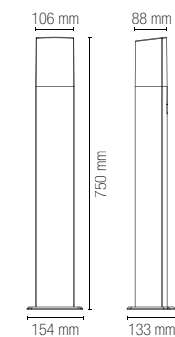

Glühbirne nicht enthalten /
Light bulb not included

TOKYO

Erlesene Kollektion aus Edelstahl mit Diffusor aus Polycarbonat. Vielseitig und komplett, umfasst Wand- und Bodenleuchten in verschiedenen Größen, die durch Finishes in Weiß, Bronze, gebürstetem Nickel und Anthrazit veredelt werden.

A sophisticated collection in stainless steel with a polycarbonate diffuser. Versatile and complete, it includes wall lamps and bollard lights in various sizes, embellished with white, bronze, brushed nickel or anthracite finish.

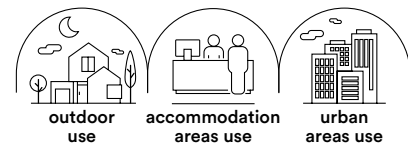

TOKYO

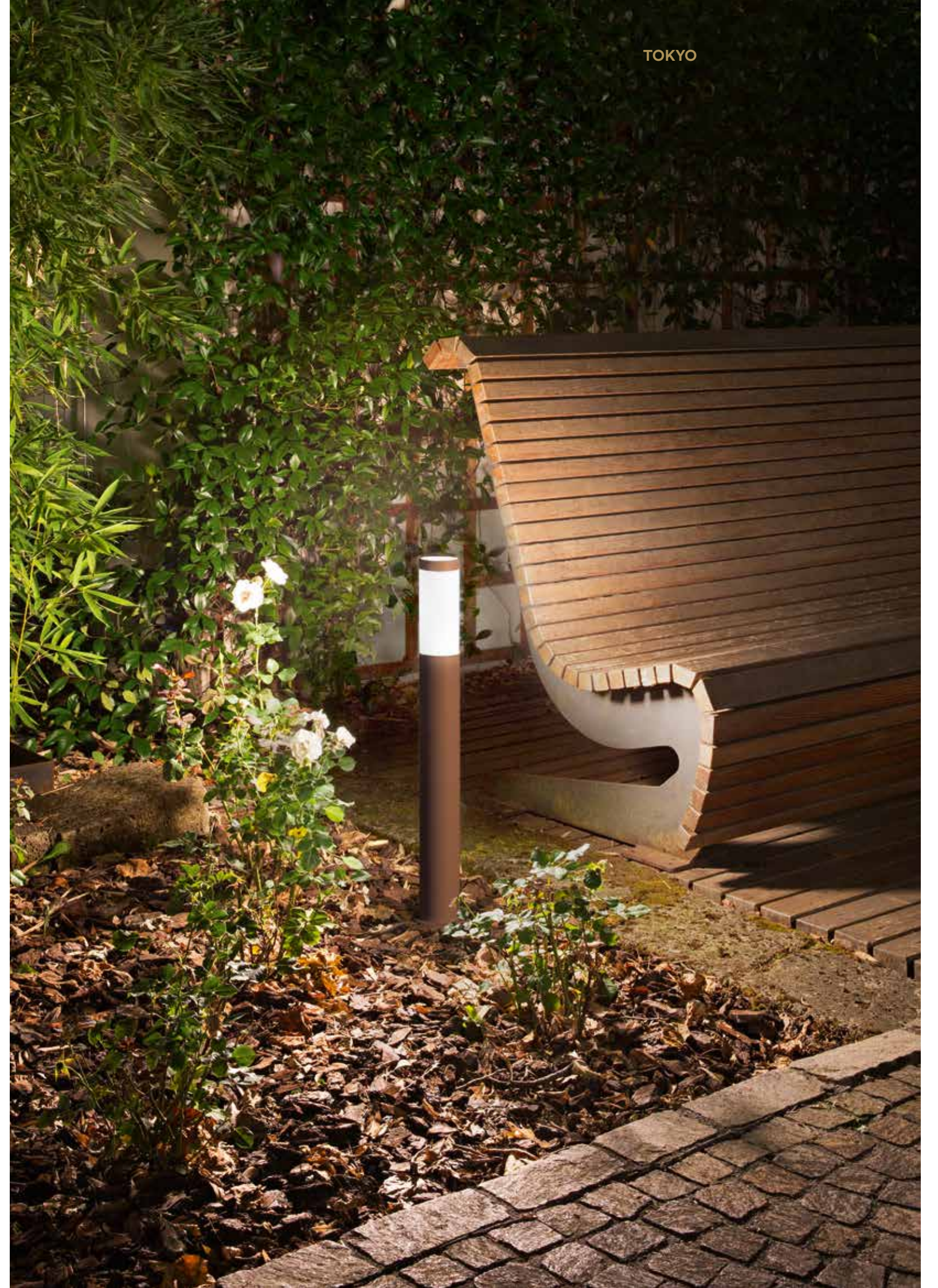



				colour
I-TOKYO-AP BCO 8031414864447 FANEU00003808				
I-TOKYO-AP ANT 8031414888795 FANEU00003807				
I-ST021 8031421451081 FANEU00003702				
I-TOKYO-AP BRO 8031414864423 FANEU00003809				
1 x E27 MAX 40W				
Empfohlene Glühbirne / Suggested light bulb				
Glühbirne nicht enthalten / Light bulb not included				

				colour
I-TOKYO-P45 BCO 8031414935512 FANEU00026242				
I-TOKYO-P45 ANT 8031414935505 FANEU00026241				
I-ST022-450 8031414935499 FANEU00026294				
I-TOKYO-P45 BRO 8031414935529 FANEU00026243				
1 x E27 MAX 40W				

				colour
I-TOKYO-P70 BCO 8031414875320 FANEU00003816				
I-TOKYO-P70 ANT 8031414888818 FANEU00003815				
I-ST022-700 8031414877225 FANEU00003704				
I-TOKYO-P70 BRO 8031414871780 FANEU00003817				
1 x E27 MAX 40W				

				colour
I-TOKYO-P BCO 8031414864416 FANEU00003813				
I-TOKYO-P ANT 8031414888801 FANEU00003812				
I-ST022-1100 8031421661084 FANEU00003703				
I-TOKYO-P BRO 8031414864393 FANEU00003814				
1 x E27 MAX 40W				

STATION



Technische Informationen / Technical information **STATION**



Kollektion mit Gehäuse aus Stahl und anthrazitfarbenem Finish. Essenziell und erlesen und als Bodenleuchte in Kombination mit dem Diffusor aus weißem Polycarbonat oder als Versorgungssäule mit doppelter Steckdose erhältlich.

A collection with a steel fixture and anthracite finish. Minimalist and elegant, it comes in a bollard light version with a white polycarbonate diffuser or in a service column version with a dual socket.



Glühbirne nicht enthalten / Light bulb not included



colour

I-STATION-E27-SC2
8031414879571
FANEU00003707

1 x E27 MAX 60W



Plug 2X max 15A 250V 2500W

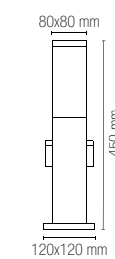

colour

I-STATION-SC2
8031414879564
FANEU00003708



Plug 2X max 15A 250V 2500W

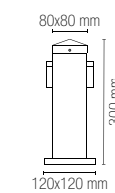

MIRAGE

Laterne aus Metall in Weiß oder Anthrazit mit Diffusor aus transparentem Glas. Das gleiche Design wird für zahlreiche Lösungen verwendet: Wand- bzw. Hängeleuchte, Stehlampe, Bodenleuchte oder Laterne.

Lantern in metal with a white or anthracite finish, with transparent glass diffuser.
The same design is available as various solutions: wall lamp, pendant light, floor lamp, bollard light or street lamp.

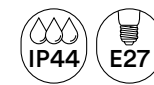

Technische Informationen / Technical information **MIRAGE**



	colour
LANT-MIRAGE-AP-BCO 8031414896394 FANEU00005601	●
LANT-MIRAGE-AP 8031414867059 FANEU00005600	●

1 x E27 MAX 60W

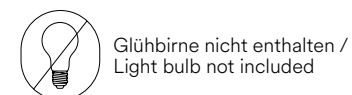
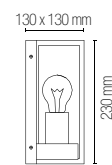

	colour
LANT-MIRAGE-S1-BCO 8031414896431 FANEU00005612	●
LANT-MIRAGE-S1 8031414867066 FANEU00005611	●

1 x E27 MAX 60W

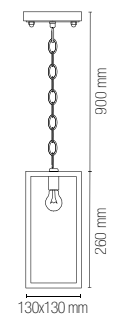

	colour
LANT-MIRAGE-L1-BCO 8031414896400 FANEU00005604	●
LANT-MIRAGE-L1 8031414869190 FANEU00005603	●

1 x E27 MAX 60W

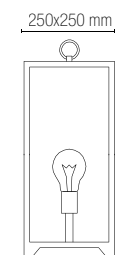

Enthaltenes Zubehör /
Accessories included

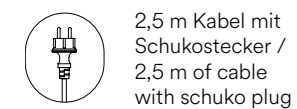

	colour
LANT-MIRAGE-P90-BCO 8031414896424 FANEU00005610	●
LANT-MIRAGE-P90 8031414869206 FANEU00005609	●

1 x E27 MAX 60W

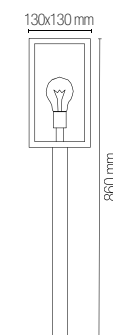

	colour
LANT-MIRAGE-P200-BCO 8031414896417 FANEU00005607	●
LANT-MIRAGE-P200 8031414869213 FANEU00005606	●

1 x E27 MAX 60W

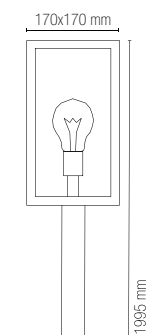



Collezione in alluminio pressofuso colore antracite con diffusore in PC. Sobria ma non banale, la collezione è disponibile in diverse varianti per offrire molteplici soluzioni in armonia con le aree esterne.

Collezione in alluminio pressofuso colore antracite con diffusore in PC. Sobria ma non banale, la collezione è disponibile in diverse varianti per offrire molteplici soluzioni in armonia con le aree esterne.



I-SKITTLE-AP
8031414881819
FANEU00003618

1 x E27 MAX 28W

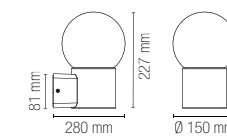

I-SKITTLE-PL
8031414881826
FANEU00003622

1 x E27 MAX 28W

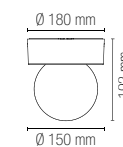

I-SKITTLE-P65
8031414881833
FANEU00003621

1 x E27 MAX 28W

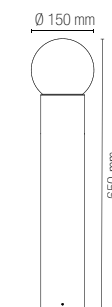

I-SKITTLE-P100
8031414882434
FANEU00003620

1 x E27 MAX 28W

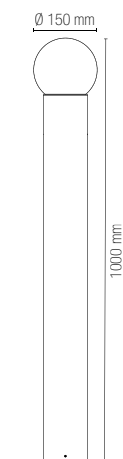

Empfohlene Glühbirne / Suggested light bulb



Glühbirne nicht enthalten / Light bulb not included

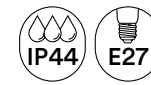

Eine Kollektion, die Originalität und Eleganz verbindet und im Design als Wand- und Bodenleuchte ausgelegt ist, erhältlich in den Varianten in Weiß, Anthrazit und Bronze. Ein Modell, das dazu gedacht ist, sich makellos in gehobene Außenbereiche einzufügen.
 A collection combining uniqueness with elegance, extending its design to include a LED wall light and a bollard light, available in a white, anthracite and bronze version. A model designed to blend seamlessly into elegant outdoor settings.



Glühbirne nicht enthalten/
Light bulb not included



	colour
LANT-ASSISI-AP1-BCO 8031414950300 FANEU00028681	White
LANT-ASSISI-AP1-NER 8031414946464 FANEU00028570	Black
LANT-ASSISI-AP1-BRO 8031414950317 FANEU00028682	Bronze

1 x E27 MAX 15W



	colour
LANT-ASSISI-P1-BCO 8031414950324 FANEU00028683	White
LANT-ASSISI-P1-NER 8031414946471 FANEU00028571	Black
LANT-ASSISI-P1-BRO 8031414950331 FANEU00028684	Bronze

1 x E27 MAX 15W

ROMA

Umfassende Kollektion von Laternen aus Aluminiumdruckguss mit Diffusor aus transparentem Glas. Roma ist in zahlreichen Varianten erhältlich und eine dekorative Wahl mit starker Wirkung, die über die technische Funktion hinausgeht. A complete collection of lanterns in die-cast aluminium with transparent glass diffuser. Available in various versions, Roma is a decorative choice with striking appeal that goes beyond its technical function.

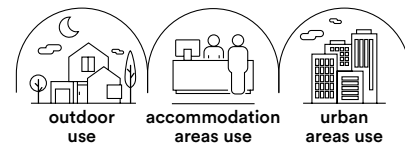

Technische Informationen / Technical information ROMA



colour
LANT-ROMA/AP1A BCO
8031434661217
FANEU00005643

1 x E27 MAX 60W

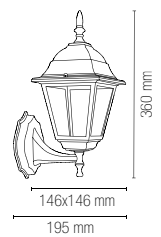

colour
LANT-ROMA/AP1A-S
8031435921235
FANEU00005644

1 x E27 MAX 60W

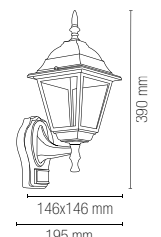

colour
LANT-ROMA/AP1B BCO
8031434671216
FANEU00005646

1 x E27 MAX 60W

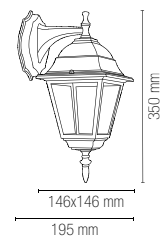

colour
LANT-ROMA/S1 BCO
8031434681215
FANEU00005652

1 x E27 MAX 60W

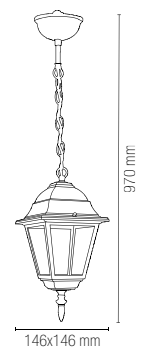

colour
LANT-ROMA/L1 BCO
8031436951248
FANEU00005647

1 x E27 MAX 60W



colour
LANT-ROMA/P1 BCO
8031436941249
FANEU00005649

1 x E27 MAX 60W

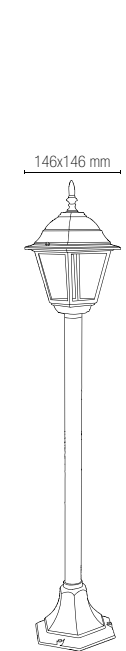

colour
LANT-ROMA/P3
8031430781179
FANEU00005650

3 x E27 MAX 60W

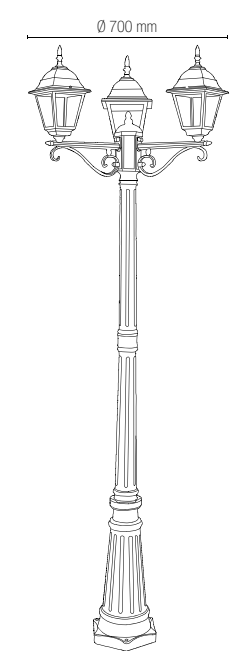

colour
LANT-ROMA-HEAD21
8031414878512
FANEU00005640

1 x E27 MAX 60W

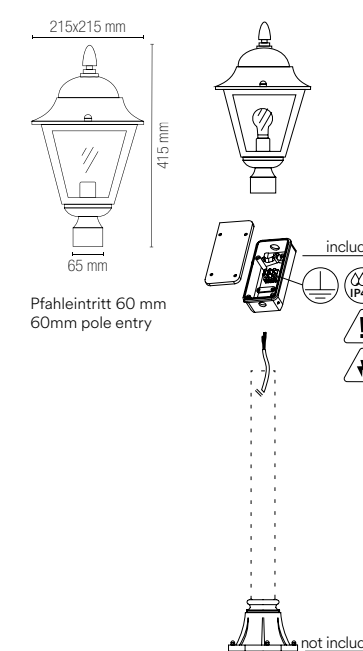

Eingebautes Zubehör / Built in accessories

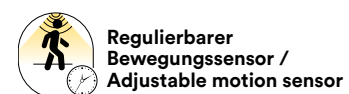

Regulierbarer Bewegungssensor / Adjustable motion sensor

ON	10lux
Abstand / distance	1-8m
	90°
	5 seconds - 5 minutes

Glühbirne nicht enthalten / Light bulb not included

KOMBINIERTE WAND-, HÄNGE- UND BODENLEUCHTEN / WALL, SUSPENSION AND FLOOR LAMPS COMBINED

on photo: ROMA



on photo: MILANO



In.tec light KOMBINIERTE WAND-, HÄNGE- UND BODENLEUCHTEN / WALL, SUSPENSION AND FLOOR LAMPS COMBINED

MILANO

Eine erlesene Kollektion von Laternen aus Aluminiumdruckguss mit Diffusor aus transparentem Glas. Die Verwendung wird in Außenumgebungen von Beherbergungsbetrieben oder in besonders gepflegten städtischen Umgebungen empfohlen. A sophisticated collection of lanterns in die-cast aluminium with transparent glass diffuser. This product is recommended for outdoor use in hospitality settings or for particularly elegant urban areas.



Technische Informationen / Technical information **MILANO**



	colour
LANT-MILANO/AP1A BCO 8031436931240 FANEU00005590	●
LANT-MILANO/AP1A 8031436921241 FANEU00005589	●
1 x E27 MAX 60W	



	colour
LANT-MILANO/AP1B BCO 8031436911242 FANEU00005592	●
LANT-MILANO/AP1B 8031436901243 FANEU00005591	●
1 x E27 MAX 60W	



	colour
LANT-MILANO/S1 BCO 8031436851234 FANEU00005598	●
LANT-MILANO/S1 8031436841235 FANEU00005597	●
1 x E27 MAX 60W	

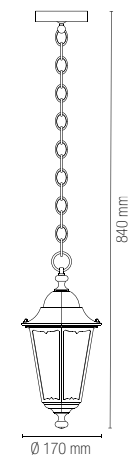

	colour
LANT-MILANO/L1 BCO 8031436891247 FANEU00005594	●
LANT-MILANO/L1 8031436881248 FANEU00005593	●
1 x E27 MAX 60W	

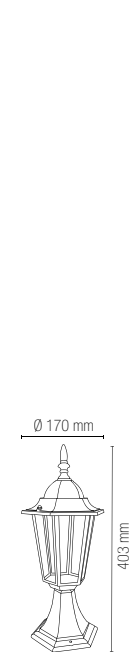

	colour
LANT-MILANO/P1 BCO 8031436871232 FANEU00005596	●
LANT-MILANO/P1 8031436971246 FANEU00005595	●
1 x E27 MAX 60W	

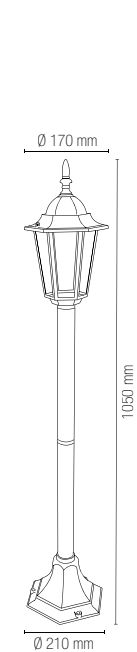

	colour
LANT-MILANO-HEAD23 8031414878529 FANEU00005585	●
1 x E27 MAX 60W	

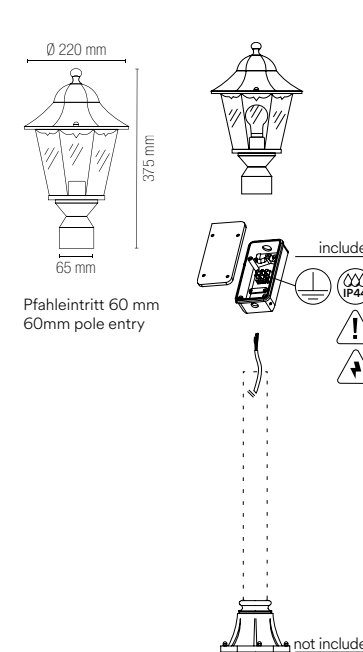

Glühbirne nicht enthalten / Light bulb not included

FIRENZE

Eine umfassende Kollektion von Laternen, die sich durch extrem hochwertige Details auszeichnet. Das Gehäuse besteht aus schwarzem Aluminiumdruckguss mit silbernem Anstrich mit Diffusor aus transparentem Glas.

A complete collection of lanterns featuring highly prestigious details. Black die-cast aluminium fixture with brushed silver finish and transparent glass diffuser.

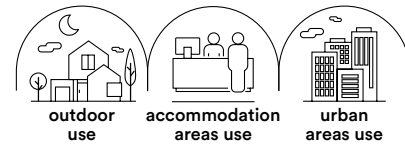



Technische Informationen / Technical information FIRENZE

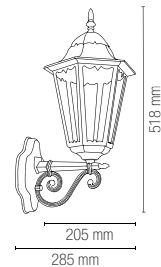

colour 
LANT-FIRENZE/AP1A
 8031430701177
 FANEU00005556

1 x E27 MAX 60W



colour 
LANT-FIRENZE/AP1B
 8031430711176
 FANEU00005557

1 x E27 MAX 60W

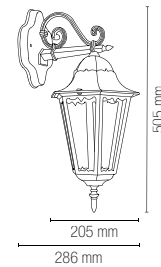

colour 
LANT-FIRENZE/S1
 8031430741173
 FANEU00005560

1 x E27 MAX 60W

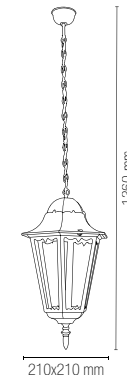

colour 
LANT-FIRENZE/P1
 8031430721175
 FANEU00005558

1 x E27 MAX 60W



colour 
LANT-FIRENZE/P3
 8031430731174
 FANEU00005559

3 x E27 MAX 60W

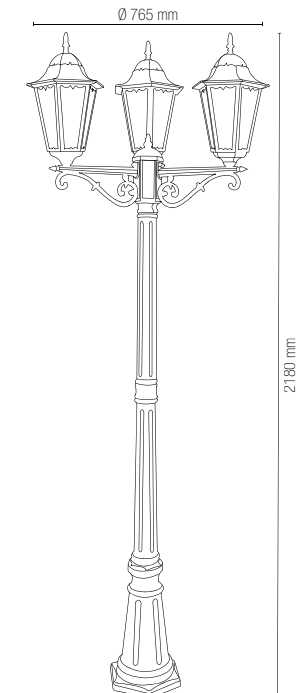

 Glühbirne nicht enthalten /
 Light bulb not included

SANTIAGO

Die Laterne besteht aus schwarzem Aluminiumdruckguss mit grünem Anstrich und Diffusor aus transparentem Glas. Die in den Einzelheiten sehr gepflegte Kollektion findet ihren richtigen Platz in eleganten Umgebungen von Beherbergungsbetrieben oder Stadtteilen.

Lanterns in black die-cast aluminium with brushed green finish and transparent glass diffuser. With great attention to detail, this collection is ideal for sophisticated hospitality facilities or urban spaces.



Technische Informationen / Technical information **SANTIAGO**



colour ●
LANT-SANTIAGO/AP1A
8031430801174
FANEU00005656

1 x E27 MAX 60W

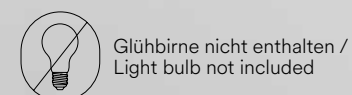
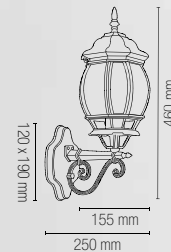

colour ●
LANT-SANTIAGO/AP1B
8031430811173
FANEU00005657

1 x E27 MAX 60W

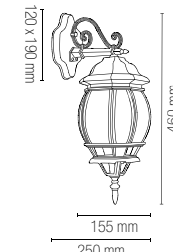

colour ●
LANT-SANTIAGO/S1
8031430841170
FANEU00005660

1 x E27 MAX 60W



colour ●
LANT-SANTIAGO/P1
8031430821172
FANEU00005658

1 x E27 MAX 60W

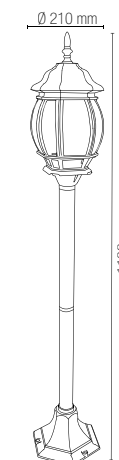

colour ●
LANT-SANTIAGO/P3
8031430831171
FANEU00005659

3 x E27 MAX 60W

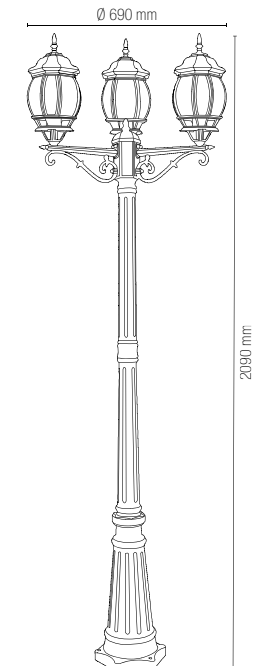

VENEZIA

Laterne aus Aluminiumdruckguss mit kupferfarbenen Finishs und Diffusor aus transparentem Polycarbonat. Ein Anklang ewiger Schönheit für eine technische Beleuchtung, die nicht auf Stil und Originalität verzichtet.
Lanterns in die-cast aluminium with copper finish and transparent polycarbonate diffuser. A touch of timeless beauty for technical lighting that does not compromise on style and originality.

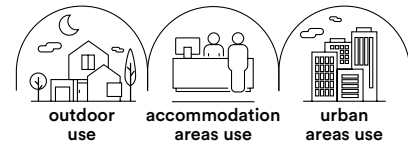

Technische Informationen / Technical information **VENEZIA**



colour 
LANT-VENEZIA-AP1A
8031440312004
FANEU00005661

1 x E27 MAX 60W

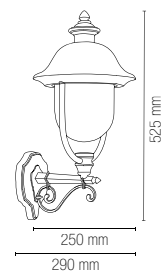

colour 
LANT-VENEZIA-AP1B
8031440311991
FANEU00005662

1 x E27 MAX 60W

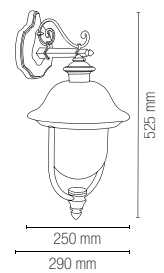

 Glühbirne nicht enthalten /
Light bulb not included



colour 
LANT-VENEZIA-S1
8031440313285
FANEU00005667

1 x E27 MAX 60W

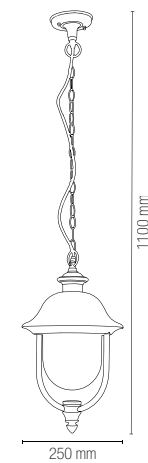

colour 
LANT-VENEZIA-L1
8031440311984
FANEU00005664

1 x E27 MAX 60W

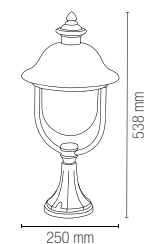

colour 
LANT-VENEZIA-P1
8031440313308
FANEU00005665

1 x E27 MAX 60W

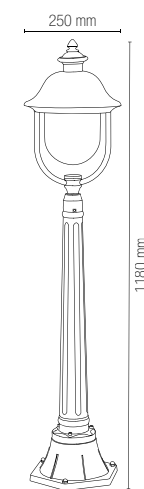

colour 
LANT-VENEZIA-P3
8031440313292
FANEU00005666

3 x E27 MAX 60W

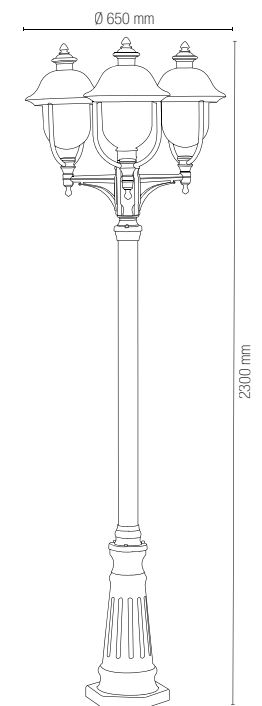

In.tec light KOMBINIERTE WAND-, HÄNGE- UND BODENLEUCHTEN / WALL, SUSPENSION AND FLOOR LAMPS COMBINED



Eine vielseitige Kollektion von zeitgemäßen Laternen, die als Wandleuchte, Wand- bzw. Hängelampe, Bodenleuchte und Laterne erhältlich ist. Das Gehäuse besteht aus schwarzem, geprägtem Aluminiumdruckguss mit Diffusor aus transparentem Acryl.
 A versatile collection of contemporary lanterns, available in the following versions: wall lamp, wall light, pendant light, bollard light and street lamp. Black die-cast aluminium fixture with black embossed finish and transparent acrylic diffuser.



LANT-PAVIA-AP1
 8031440312028
 FANEU00005625

1 x E27 MAX 60W

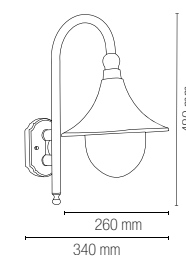

LANT-PAVIA-S1
 8031440312042
 FANEU00005628

1 x E27 MAX 60W

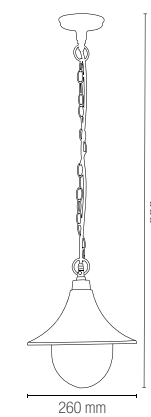

LANT-PAVIA-P1
 8031440312035
 FANEU00005626

1 x E27 MAX 60W

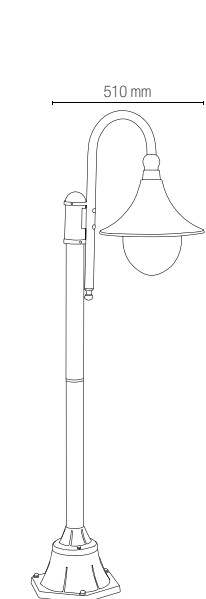

LANT-PAVIA-P3
 8031440312011
 FANEU00005627

3 x E27 MAX 60W

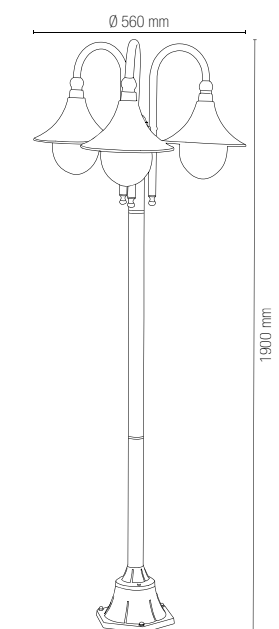

Glühbirne nicht enthalten /
 Light bulb not included



LED-Modul für Laternen mit Netzteil OSRAM OT60 DALI und virtueller Mitternacht. Ideal für größte Energieeinsparung und mit einem unabhängigen System zur Verringerung des Lichts während der Nachtstunden ausgestattet.

LED module for street lamps with OSRAM OT60 DALI power supply and virtual midnight system. Ideal for maximum energy saving, it is fitted with an autonomous system for reducing light output at night.

Material
Aluminium

Farbe
Schwarz



Farbtemperatur
2700K / 4000K



Driver
inklusive
DALI

Durata e on/off
50.000h
>25.000 on/off

Material
aluminum

Colour
black



Colour temperature
2700K / 4000K



Driver
included
DALI

Life time and on/off
50.000h
>25.000 on/off

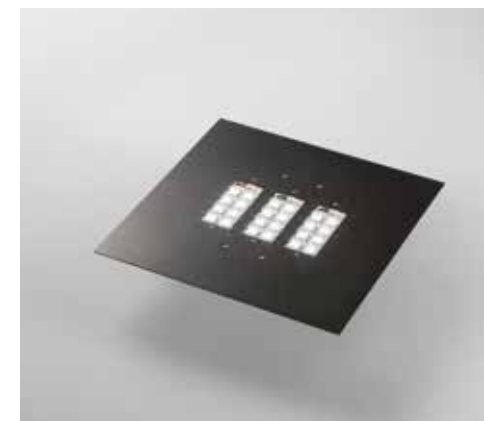

	colour temp.	colour
BRIGHTMAX-60C 8031414883899 FANEU00000472 lumen	9600 lm	
BRIGHTMAX-60M 8031414883905 FANEU00000473 lumen	9600 lm	
watt	60W	
beam angle	360°	

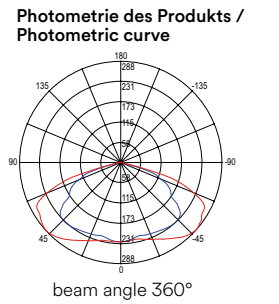

BRIGHTMAX-LENS
8031414883912
FANEU00000474
Doppelt und dreifach asymmetrische Linse /
Be-asymmetric and three-asymmetric lens

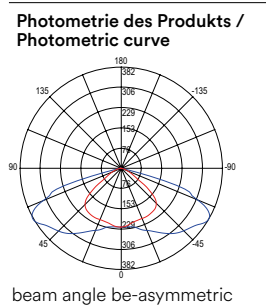
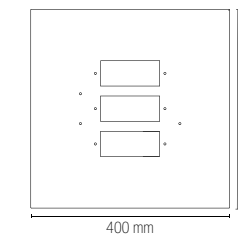

Die Platte kann bis zu einer Größe von 220x220 mm zugeschnitten werden /
The plate can be cut up to a size of 220x220mm

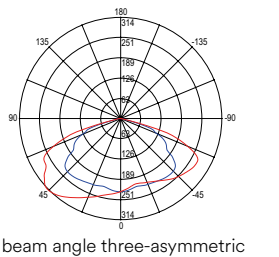

Virtuelle Mitternacht / Minuit Virtuel

Unabhängiges System zur Lichtreduzierung in 5 SCHRITTEN. Das LED-Modul ist nach einem bestimmten Programm konfiguriert (auf Wunsch individuell anpassbar), um die Energieeinsparung während der Nachtstunden zu optimieren. Das Gerät sieht ein Einlernsystem vor, das abhängig von den vorangegangenen Ein- und Ausschaltungen den Zeitpunkt der virtuellen Mitternacht eigenständig bestimmt. Die virtuelle Mitternacht ist der Zeitpunkt, der die Verringerung des Lichtstroms abhängig vom eingegebenen Profil bestimmt und die Anlage nicht beeinflusst. Für eine korrekte Funktionsweise des Systems der Virtuellen Mitternacht ist ein regelmäßiges tägliches Ein- und Ausschalten erforderlich.

Independent system of light reduction in 5 steps. The LED module is set with a specific program (customizable) to optimize the energy saving time during night hours. The device is equipped with a auto-feedback system which determine independently, the Virtual Midnight point based on the past switch on-switch-off time record. Virtual Midnight is the point which determines the light flux reduction based on the set profile, keeping the electrical system untouched. For a correct working of the system of Virtual Midnight it is necessary a daily regular cycle of switching on-off.

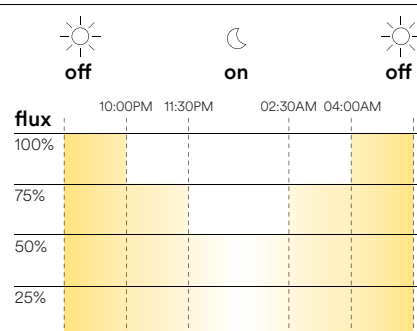

Werkseitige Einstellungen / Default Settings

hours	flux
ON ÷ 10:00	100%
10:00 ÷ 11:30	75%
11:30 ÷ 02:30	50%
02:30 ÷ 04:00	75%
04:00 ÷ OFF	100%

POLLY

Kollektion mit Basis aus Kunststofffaser und Kugeln aus Acrylglas in den Farben Durchsichtig, Weiß oder Rauchfarben. In verschiedenen Kombinationen erhältlich, garantiert Vielseitigkeit und ein perfektes Einfügen in sämtliche Umgebungen.,

A collection with a plastic fibre base and PMMA spheres with a transparent, white or tinted finish. Available in a variety of combinations, it ensures versatility and perfect integration into any space.



POLLY



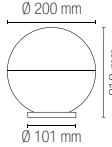

I-POLLY-G20-TR180 8031414921973 FANEU00003173	colour ●	
1 x E27 MAX 20W		

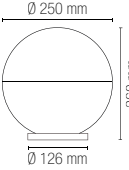

I-POLLY-G25-TR180 8031414921980 FANEU00003177	colour ●	
1 x E27 MAX 20W		

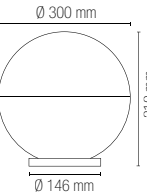

I-POLLY-G30-TR180 8031414921997 FANEU00003181	colour ●	
1 x E27 MAX 20W		



Glühbirne nicht enthalten /
Light bulb not included

Die Kugeln POLLY G20-G25-G30 können ausschließlich unter Verwendung
der auf S. 226-229 aufgeführten Zubehörteile montiert werden /
The POLLY G20-G25-G30 spheres can only be mounted
using the accessories listed on pages 226-229



I-POLLY-G20-TR 8031414889136 FANEU00003172	colour ●	
I-POLLY-G20-BCO 8031414889112 FANEU00003170	●	
I-POLLY-G20-GR 8031414889129 FANEU00003171	●	
1 x E27 MAX 20W		



I-POLLY-G25-TR 8031414889167 FANEU00003176	colour ●	
I-POLLY-G25-BCO 8031414889143 FANEU00003174	●	
I-POLLY-G25-GR 8031414889150 FANEU00003175	●	
1 x E27 MAX 20W		



I-POLLY-G30-TR 8031414889198 FANEU00003180	colour ●	
I-POLLY-G30-BCO 8031414889174 FANEU00003178	●	
I-POLLY-G30-GR 8031414889181 FANEU00003179	●	
1 x E27 MAX 20W		



I-POLLY-AP-TR 8031414889105 FANEU00003167	colour ●	
I-POLLY-AP-BCO 8031414889389 FANEU00003165	●	
I-POLLY-AP-GR 8031414889099 FANEU00003166	●	
1 x E27 MAX 20W		

POLLY

Zubehör / accessories **POLLY**



I-POLLY-PD
8031414921942
FANEU00003183

Zubehör für Aufhängung mit Gummikabel und Verbinder / Suspension accessory with rubber cable

colour
●



I-POLLY-SPK
8031414921959
FANEU00003189

Zubehör zur Befestigung mit Pflock mit Verbinder und Kabelhalter / Accessory for peg fixing with connector and cable holder

colour
●

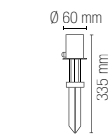

I-POLLY-SPK-S
8031414921966
FANEU00003190

Zubehör zur Befestigung mit Pflock mit Gummikabel und Schukostecker / Accessory for peg fixing with rubber cable and Schuko socket

colour
●

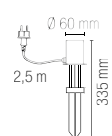

Enthaltenes Zubehör / Accessories included



2,5 m Kabel mit Schukostecker / 2,5 m of cable with schuko plug

IP44

POLLY



Zubehör / accessories **POLLY**



	colour
I-POLLY-TUBE100 8031414890149 FANEU00003191	●
I-POLLY-TUBE150 8031414890156 FANEU00003192	●
I-POLLY-TUBE200 8031414890163 FANEU00003193	●

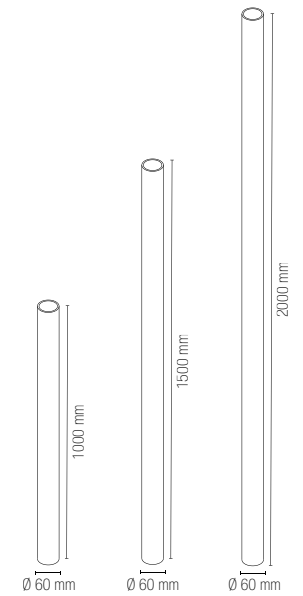

I-POLLY-BASE
8031414889235
FANEU00003168

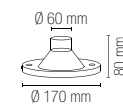

I-POLLY-JOINT
8031414890170
FANEU00003182

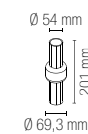

I-POLLY-BASE-AP
8031414904587
FANEU00003169

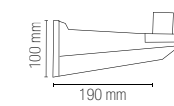

GECO DJ

LED-Handlampe RGBW aus Polyethylen mit integriertem Bluetooth-Lautsprecher. Ein Konzentrat an Technologie mit überraschenden Farbeffekten und Steuerung der Musik über Smartphone oder IR-Fernbedienung.

Portable RGBW LED lamp in polyethylene with Bluetooth speaker. A technological marvel with stunning colour effects and music control via smartphone or IR remote control.



GECO

Material
PE

Farbtemperatur
RGB + 4000K



Driver
inklusive

Material
PE

Colour temperature
RGB + 4000K



Driver
included



I-GECO-DJ-L25
8031414862542
FANEU00002026
lumen

colour temp.
RGB + 180 lm - 8h

watt 3W

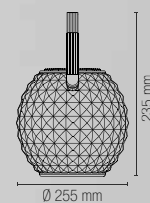

Enthaltenes Zubehör / Accessories included

Ladekabel mit Adapter DC5 V 1 A 1,2 m / Charging cable with adaptor DC5V 1A 1,2 m 230V 50Hz

Infrarot-Fernbedienung / IR remote control

Speaker 10 W Bluetooth 4.0, Anschlussabstand max. 15 m, Dauer 2h / 10w speaker bluetooth 4.0 connection distance max 15 m, lasting time 2h

6 hours Aufladbare Batterie, nicht ersetzbar / Rechargeable battery not replaceable



In.tec light KOMBINIERTE WAND-, HÄNGE- UND BODENLEUCHTEN / WALL, SUSPENSION AND FLOOR LAMPS COMBINED

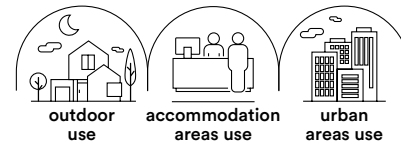

Eine Kollektion, die Vase und LED-Lampen RGBW aus Polyethylen umfasst, in Kugel- oder Würfelform. Die ganze Funktionalität der LED für die gewünschte Farbeinstellung. Ideal für Innen- und Außenbereiche.

A collection including a vase and RGBW LED lamps in polyethylene, in spherical or cubic shapes. All LED functions for adjusting to the required colour. Ideal for outdoor and indoor spaces.

Material

PE

Farbtemperatur

RGB + 4000K



Driver

inklusive

Material

PE

Colour temperature

RGB + 4000K



Driver

included



Enthaltenes Zubehör / Accessories included



Infrarot-Fernbedienung / IR remote control



Aufladbare Batterie, nicht ersetzbar / Rechargeable battery non replaceable

I-GECO-VASO-Q-L

8031414862535
FANEU00002043

colour temp. RGB + 4000K
lumen 240 lm - 8h

I-GECO-VASO-Q-XL

8031414864713
FANEU00002044

colour temp. RGB + 4000K
lumen 240 lm - 8h
watt 4W

I-GECO-VASO-R-L

8031414862528
FANEU00002045

colour temp. RGB + 4000K
lumen 240 lm - 8h

I-GECO-VASO-R-XL

8031414864720
FANEU00002046

colour temp. RGB + 4000K
lumen 240 lm - 8h
watt 4W

I-GECO-SFERA-L30

8031414862436
FANEU00002030

colour temp. RGB + 4000K
lumen 240 lm - 8h

I-GECO-SFERA-L40

8031414862443
FANEU00002031

colour temp. RGB + 4000K
lumen 240 lm - 8h

I-GECO-SFERA-L50

8031414862450
FANEU00002032

colour temp. RGB + 4000K
lumen 240 lm - 8h
watt 4W

I-GECO-CUBO-L30

8031414862467
FANEU00002021

colour temp. RGB + 4000K
lumen 240 lm - 8h

I-GECO-CUBO-L40

8031414862474
FANEU00002022

colour temp. RGB + 4000K
lumen 240 lm - 8h

I-GECO-CUBO-L50

8031414862481
FANEU00002023

colour temp. RGB + 4000K
lumen 240 lm - 8h
watt 4W

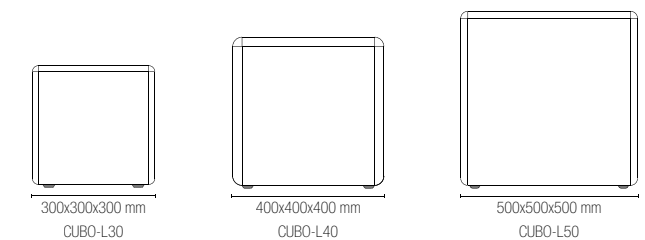
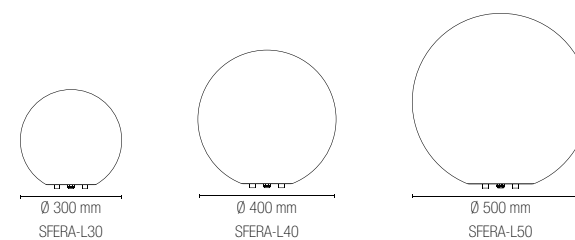
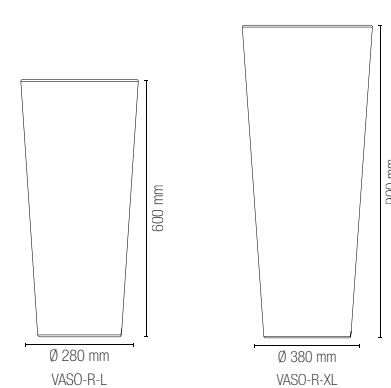
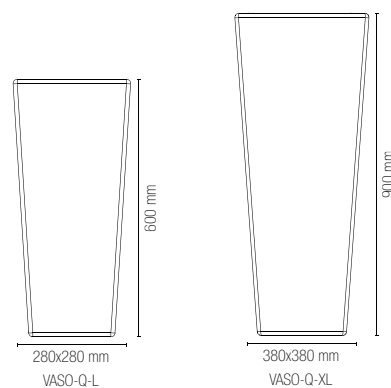



Umfassende Lampenkollektion mit E27-Sockel aus Polyethylen und hohem Schutz vor Staub und Flüssigkeiten. Mit mittels IR-System einstellbarer Steuerung der Beleuchtung von mehrfarbig bis zu dynamischem Weiß.

An extensive collection of lamps with E27 socket in polyethylene and high protection against dust and liquids. With multicolour and dynamic white lighting control, adjustable via an IR system.



Glühbirne nicht enthalten /
Light bulb not included



I-GECO-SFERA-S30
8031414864461
FANEU00002034

1 x E27 MAX 42W

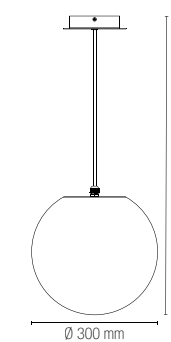

I-GECO-SFERA-S40
8031414864454
FANEU00002035

1 x E27 MAX 42W

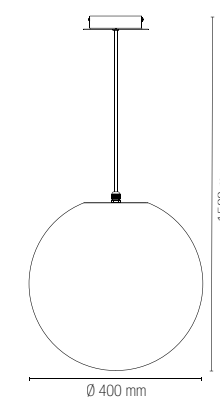



I-GECO-VASO-E-Q-L
8031414868506
FANEU00002039
I-GECO-VASO-E-Q-XL
8031414868131
FANEU00002040

1 x E27 MAX 42W

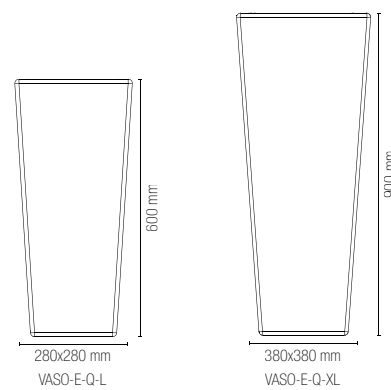

I-GECO-VASO-E-R-L
8031414868513
FANEU00002041
I-GECO-VASO-E-R-XL
8031414868520
FANEU00002042

1 x E27 MAX 42W

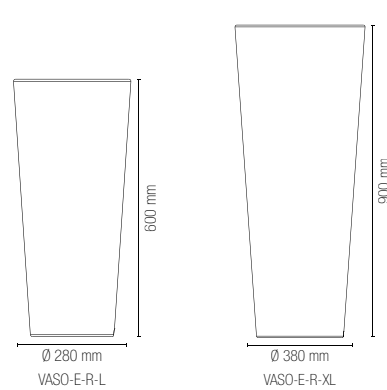

I-GECO-SFERA-E-L30
8031414868476
FANEU00002027
I-GECO-SFERA-E-L40
8031414868483
FANEU00002028
I-GECO-SFERA-E-L50
8031414868490
FANEU00002029

1 x E27 MAX 42W

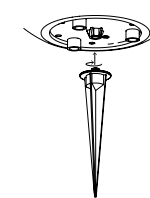
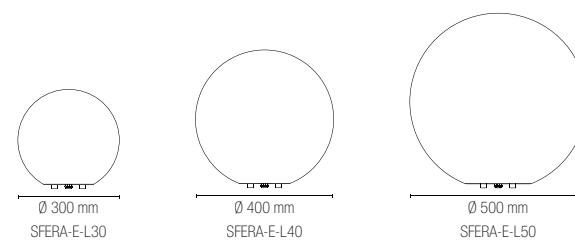

I-GECO-SPK
8031414878437
FANEU00002038
Aluminiumpflock für Lampen Reihe GECO E27 / Aluminum spike for E27 GECO family



I-GECO-CUBO-E-L30
8031414867943
FANEU00002018
I-GECO-CUBO-E-L40
8031414868117
FANEU00002019
I-GECO-CUBO-E-L50
8031414868124
FANEU00002020

1 x E27 MAX 42W

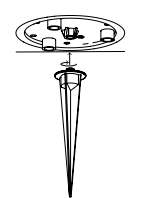
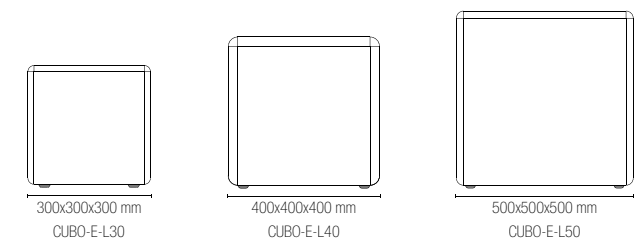

I-GECO-SPK
8031414878437
FANEU00002038
Aluminiumpflock für Lampen Reihe GECO E27 / Aluminum spike for E27 GECO family



Glühbirne nicht enthalten / Light bulb not included

GECO E27

Stehlampe aus Polyethylen mit Struktur aus mattweißem oder anthrazitfarbenem Metall.
PE floor lamp with metal structure white or anthracite colour.



Technische Informationen / Technical information **GECO E27**

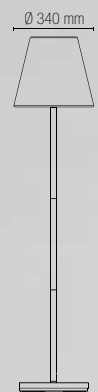

I-GECO-BAR-PT
8031414868599
FANEU00002013

colour



Enthaltenes Zubehör /
Accessories included



2,5 m Kabel mit
Schukostecker /
2,5 m of cable
with schuko plug



1 x E27 MAX 42W



Glühbirne nicht enthalten /
Light bulb not included

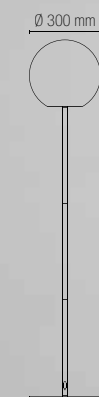

I-GECO-SFERA-PT30
8031414864430
FANEU00002033

colour



Enthaltenes Zubehör /
Accessories included



2,5 m Kabel mit
Schukostecker /
2,5 m of cable
with schuko plug



1 x E27 MAX 42W



Glühbirne nicht enthalten /
Light bulb not included

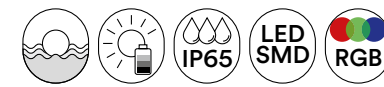

Tragbare und schwimmende LED-Leuchte RGBW aus Polyethylen mit automatischer Solarladung. Eine originelle Lösung für Außenumgebungen mit komplettem Schutz vor Staub und hervorragender Beständigkeit gegen Spritzer.
 Portable and floating RGBW LED lamp in polyethylene with solar self-charging. An original solution for outdoor spaces, with full protection against dust and optimum protection against splashes.

Material
PE

Farbtemperatur
RGB + 4000K



Driver
inklusive

Material
PE

Colour temperature
RGB + 4000K



Driver
included



Enthaltenes Zubehör / Accessories included



Infrarot-Fernbedienung / IR remote control



Netzteiladung / DC charge
Auffadbare Batterie, nicht ersetzbar / Rechargeable battery not replaceable



Solarladung / Auto solar charge
Auffadbare Batterie, nicht ersetzbar / Rechargeable battery not replaceable

I-GECO-SFERA-SOL30
8031414870868
FANEU00002036
lumen

colour temp.
RGB +

I-GECO-SFERA-SOL40
8031414870875
FANEU00002037
lumen

colour temp.
RGB +

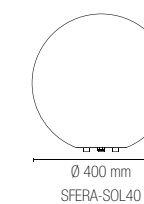
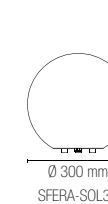

I-GECO-CUBO-SOL30
8031414870837
FANEU00002024
lumen

colour temp.
RGB +

I-GECO-CUBO-SOL40
8031414870844
FANEU00002025
lumen

colour temp.
RGB +

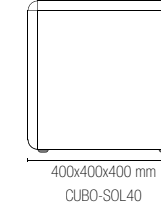
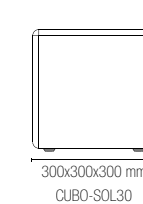

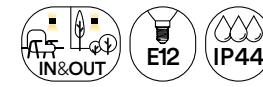

Elektrische Lichterkette E12 für Außenbereiche mit PVC-Kabel, Schuko-Stecker und modulierbarem Verbinder, der einen leichteren "End-to-End"-Anschluss garantiert. Ideal für Innen- oder Außenbereiche.

E12 light string with PVC cable for outdoor use, Schuko plug and modular connector that ensures easy end-to-end connection. Ideal for indoor and outdoor spaces.



colour

Enthaltenes Zubehör / Accessories included

I-PICNIC-COLOR
8031414891863
FANEU00003090



25 x E12

Glühbirne E12
E12 light bulb

7 rot/red
6 gelb/yellow
6 grün/green
6 blau/blue

watt 0,3W
volt 230V

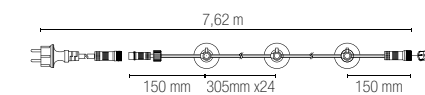

END-TO-END
easy connection / max 1000W



Elektrische Lichterkette E12 für Außenbereiche mit PVC-Kabel, Schukostecker und modulierbarem Verbinder. Für Innen- oder Außenbereiche, mit Schutz vor Staub und Flüssigkeiten. Auch in der Version mit Solarpanel zum Aufladen.

E12 light string with PVC cable for outdoor use, Schuko plug and modular connector. For outdoor and indoor spaces, with protection against dust and liquids. Also available in a version with solar charging panel.

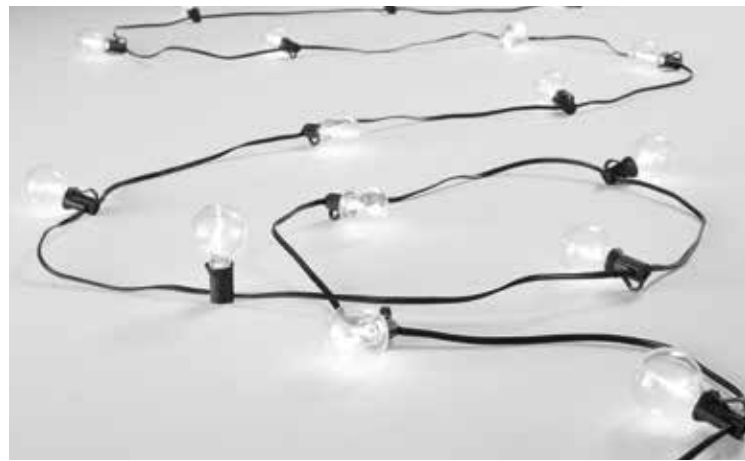

colour | Enthaltene Zubehör / Accessories included

I-PICNIC-LED
8031414884407
FANEU00003097



Glühbirne E12
E12 light bulb

watt	0,3W
volt	230V
3000K	

25 x E12

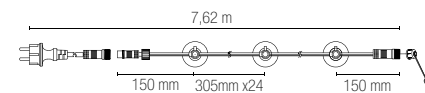

END-TO-END

easy connection / max 1000W

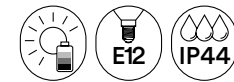
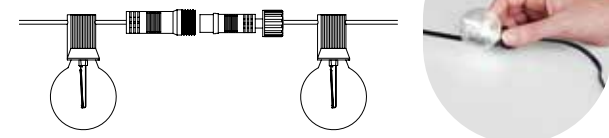

colour | Enthaltene Zubehör / Accessories included

I-PICNIC-SOLAR
8031414884414
FANEU00003101



Glühbirne E12
E12 light bulb

watt	0,3W
volt	3V
3000K	

25 x E12



3.7V 2200mAh
Aufladbare Batterie,
nicht ersetzbar /
Rechargeable battery
not replaceable

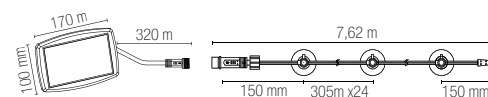

Elektrische Lichterkette E14 oder E27 für Außenbereiche mit Kabel aus Gummi, inklusive Schukostecker und modulierbarem Verbinder.

Light string E14 or E27 for outdoor rubber cable inclusive of schukoplug and modular connector.



colour |

I-PICNIC-E27-BCO
8031414043064
FANEU00003094



Glühbirne
nicht
enthalten /
Light bulb
not included

I-PICNIC-E27
8031414862719
FANEU00003093



10 x E27 MAX 25W

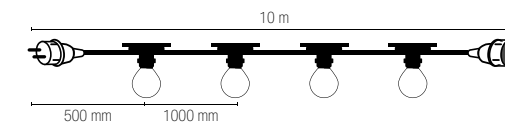

END-TO-END

easy connection / max 1000W

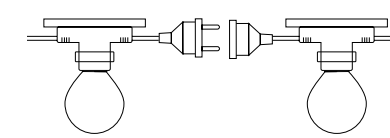

colour |

I-PICNIC-E14-BCO
8031414023745
FANEU00003092



Glühbirne
nicht
enthalten /
Light bulb
not included

I-PICNIC-E14
8031414862726
FANEU00003091



10 x E14 MAX 25W

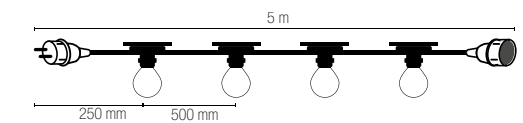

END-TO-END

easy connection / max 1000W

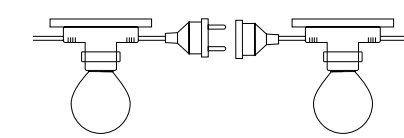

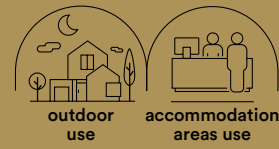

Elektrische LED-Lichterkette für Außenbereiche mit PVC-Kabel, Schukostecker und modulierbarem Verbinder. Mit modernem System zur smarten Steuerung über zahlreiche Geräte und RGB- und CCT-Farbeeinstellung.

LED light string with PVC cable for outdoor use, including a Schuko plug and modular connector. Cutting-edge system for smart control from multiple devices and RGB colour and CCT adjustment.

- Material**
PC + PVC
- Farbe**
Schwarz
- Farbtemperatur**
RGB + CCT
- Driver**
eingebaut
- Material**
PC + PVC
- Colour**
black
- Colour temperature**
RGB + CCT
- Driver**
built-in



I-PICNIC-INT
8031414884391
FANEU00003096
lumen

colour temp.	colour
400 lm	

watt	10 x 0,5W
beam angle	110°

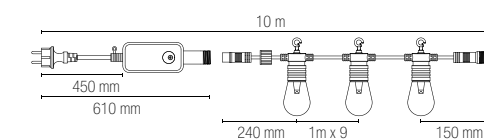

END-TO-END
easy connection / max 1000W

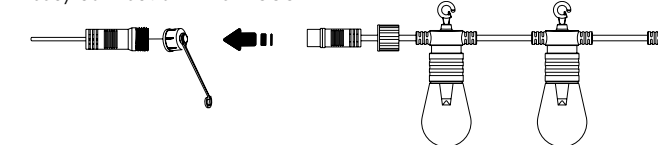

Control system easy installation



PICNIC RGB



Technische Informationen / Technical information **PICNIC RGB**



Material
PC + PVC

Farbe
Schwarz



Farbtemperatur
RGB



Driver
eingebaut

Material
PC + PVC

Colour
black



Colour temperature
RGB



Driver
built-in

LED-Lichterkette für Außenbereiche mit PVC-Kabel, inklusive Schukostecker und modulierbarem Verbinder. Mit RGB-Farbsteuerung mittels Fernbedienung, hoher Farbwiedergabe und Schutz vor Wasser und Staub.
LED light string with PVC cable for outdoor use, including a Schuko plug and modular connector. With remote control of RGB colours, high colour rendering and protection against water and dust.



I-PICNIC-LED-RGB
8031414921911
FANEU00003099

colour temp.



RGB

colour



watt

5W

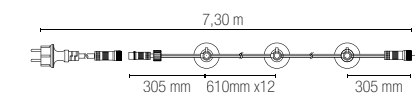

END-TO-END

easy connection / max 2 wires with a single adapter

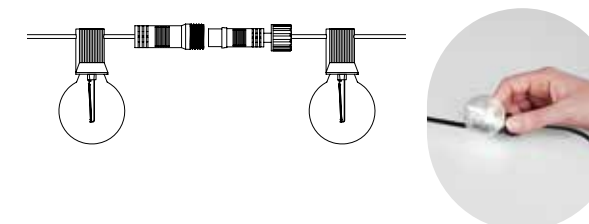



Aufladbare Tischleuchten / Rechargeable table lamps
outdoor

COCKTAIL

Eine erlesene Kollektion von aufladbaren Tischlampen. Gehäuse aus Metall mit geprägtem Finish und in verschiedenen Farbtönen erhältlich. Die Lichtstärke kann über eine bequeme Touch-Steuerung eingestellt werden.

A sophisticated collection of rechargeable table lamps. It features a metal fixture with embossed finish and is available in various colours. Brightness intensity is adjusted with convenient touch control.



Material
Metall

Farbe
Geprägt, Weiß
Geprägt, Schwarz
Geprägt, Gold
Geprägt, Corten



Farbtemperatur
3000K



Material
métal

Colour
embossed white
embossed black
embossed gold
embossed corten



Colour temperature
3000K



LED-COCKTAIL-BCO
8031414882496
FANEU00005977
lumen

colour temp.	colour
192 lm - 9h	

LED-COCKTAIL-NER
8031414882502
FANEU00005983
lumen

192 lm - 9h	

LED-COCKTAIL-ORO
8031414885282
FANEU00005986
lumen

192 lm - 9h	

LED-COCKTAIL-BRO
8031414882519
FANEU00005979
lumen

192 lm - 9h	

watt 2,2W

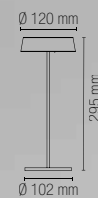

Enthaltenes Zubehör / Accessories included

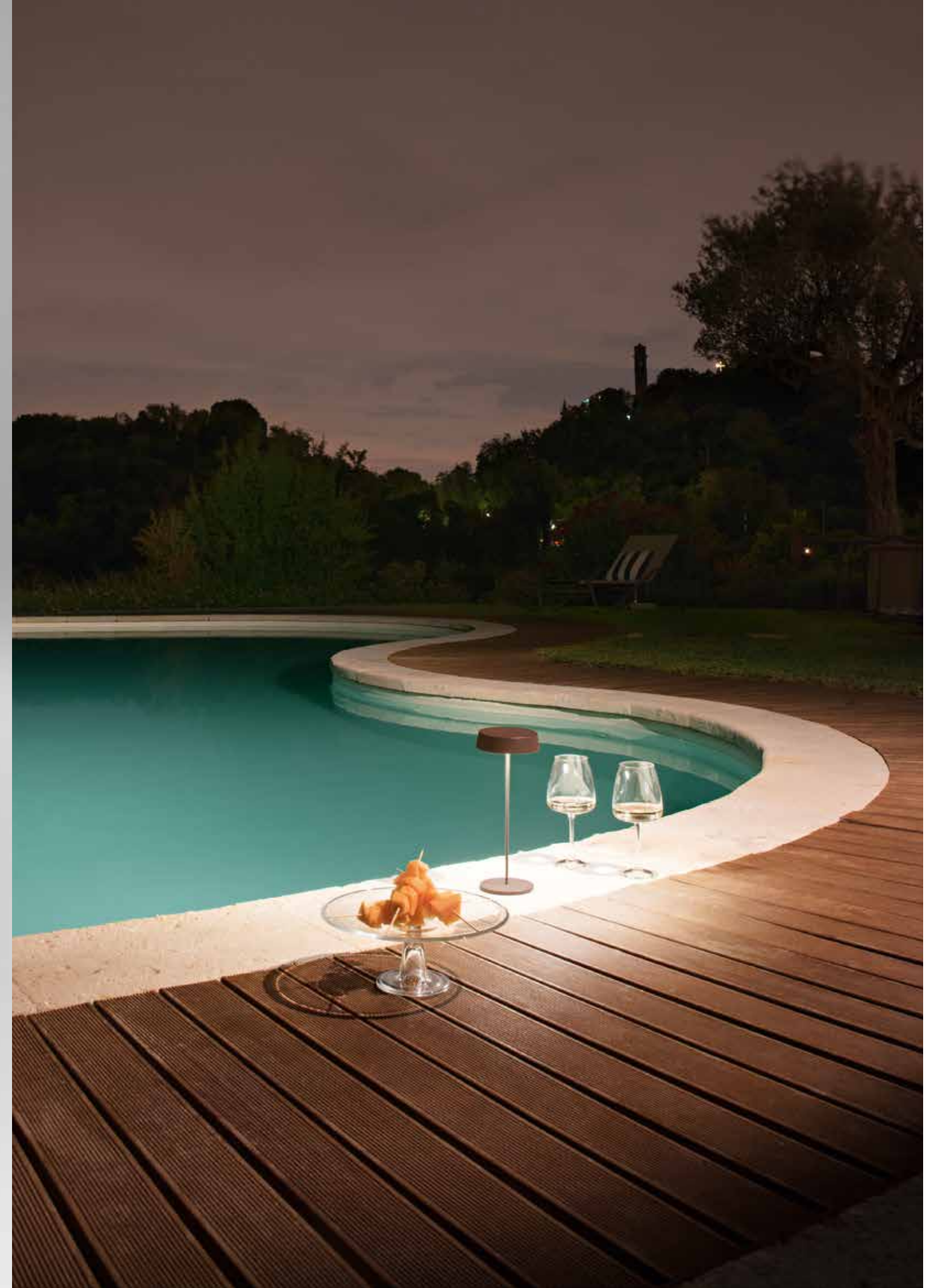
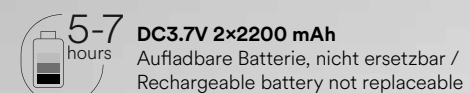

In.tec light AUFLADBARE TISCHLEUCHTEN / RECHARGEABLE TABLE LAMPS

JIN

Kollektion bestehend aus LED-Tisch- und Stehlampe mit Solarpanel und Aufladung über Kabel. Minimalistisches, schickes Design, das durch die erlesenen Farbtöne (Schwarz, Grün und Weiß) und die verstellbare Lichtstärke zur Geltung kommt.

A collection including a LED table lamp and floor lamp provided with a solar panel and cable charging. Minimalist chic design enhanced with subtle colours – black, green and white – and adjustable brightness intensity.



JIN



JIN

Unvergängliche Tischlampe mit warmer LED-Beleuchtung mit Versorgung über Solarpanel für eine Dauer von bis zu 10 Stunden. Mit Einschaltsystem über Kabel und drei eleganten Finishes in Grün, Weiß oder Schwarz.

Iconic table lamp with warm LED lighting, powered by a solar panel for up to 10 hours of battery life. With cable ignition system and three elegant finishes: green, white or black.



Material
Metall oder PE

Farbe
Weiß
Schwarz
Grün



Farbtemperatur
3000K



Material
metal and PE

Colour
white
black
green



Colour temperature
3000K



	colour temp.	colour
LED-JIN-L-BCO 8031414931156 FANEU00024010 lumen	112 lm	white
LED-JIN-L-NER 8031414931149 FANEU00024011 lumen	112 lm	black
LED-JIN-L-VDE 8031414931163 FANEU00024012 lumen	112 lm	green
watt	1,2W	

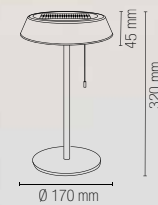

Enthaltenes Zubehör / Accessories included

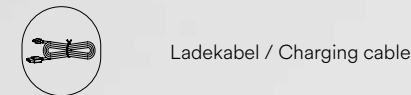
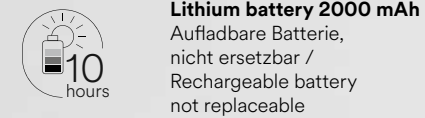

Technische Informationen / Technical information **JIN**



Elegante LED-Stehlampe für Außenbereiche mit Solarpanel und Aufladung über Kabel. Minimalistisches, schickes Design, das durch die erlesenen Farbtöne (Schwarz, Grün und Weiß) und die verstellbare Lichtstärke zur Geltung kommt.

Elegant LED floor lamp for outdoor use, provided with a solar panel and cable charging. Minimalist chic design enhanced with subtle colours – black, green and white – and adjustable brightness intensity.



	colour temp.	colour
LED-JIN-PT-BCO 8031414931187 FANEU00024013 lumen	180 lm	white
LED-JIN-PT-NER 8031414931170 FANEU00024014 lumen	180 lm	black
LED-JIN-PT-VDE 8031414931194 FANEU00024015 lumen	180 lm	green
watt	3W	



Enthaltenes Zubehör / Accessories included

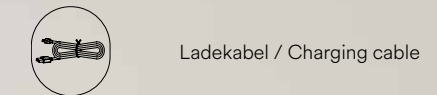
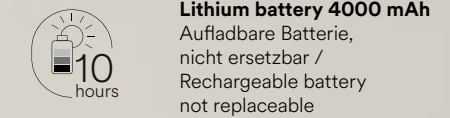

ROBIN

Charakteristische kleine LED-Lampe aus Metall mit Solar- oder Kabelaufladung und langer Dauer. Tragbar und mit Touch-Schalter mit 3 Helligkeitsstufen ausgestattet. Wird in den Farben Grün, Schwarz und Weiß angeboten.

Distinctive metal LED lamp with solar or cable charging and extended battery life. Portable and fitted with a touch switch with 3 levels of brightness intensity. Available in green, black and white.



ROBIN

Material
Metall oder PE

Farbe
Weiß
Schwarz
Grün



Farbtemperatur
3000K



Material
metal and PE

Colour
white
black
green



Colour temperature
3000K



	colour temp.	colour
LED-ROBIN-BCO 8031414931125 FANEU00027038 lumen	84 lm	white
LED-ROBIN-NER 8031414931118 FANEU00024016 lumen	84 lm	black
LED-ROBIN-VER 8031414931132 FANEU00024031 lumen	84 lm	green

watt 1,2W

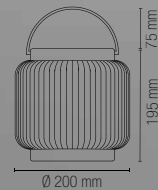

Enthaltenes Zubehör / Accessories included



Solarpanel / Solar panel



Lithium battery 2000 mAh
Aufladbare Batterie,
nicht ersetzbar /
Rechargeable battery
non replaceable



Ladekabel / Charging cable



Einbau- und Orientierungsleuchten / Inground and walk lights
outdoor



Satz Einbau-Orientierungsleuchten bestehend aus 6 Teilen. Die begehbaren Orientierungsleuchten garantieren einen optimalen IP-Schutzgrad gegen Staub und Flüssigkeiten und hohe Farbwiedergabe. Der Artikel kann auch mit RGB-Beleuchtung individuell gestaltet werden.
 Recessed step light kit comprising 6 pieces. Walkable, the step lights ensure an optimum level of IP protection against dust and liquids, and high colour rendering. The product can also be customised with RGB lighting.

Material
Stahl

Farbe
Stahl

Farbtemperatur
RGB



Driver
12V 6W
inklusive

Material
steel

Colour
stainless steel

Colour temperature
RGB



Driver
12V 6W
included



LED-RIDER-R6

8031436141236
FANEU00007273
lumen

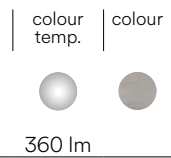

watt	6 x 0,6W
driver	12V 6W DC
beam angle	120°
pressure loads	max 100 kg
	Ø 23 mm

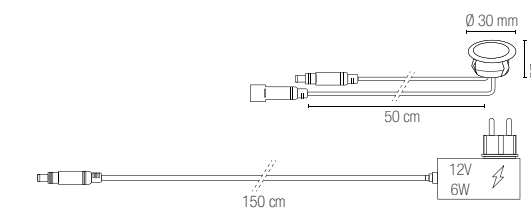

LED-RIDER-R6-RGB

8031439871260
FANEU00007278
lumen

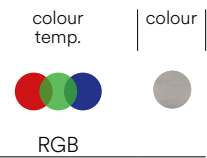

watt	6 x 0,6W
driver	12V 6W DC
beam angle	120°
pressure loads	max 100 kg
	Ø 23 mm

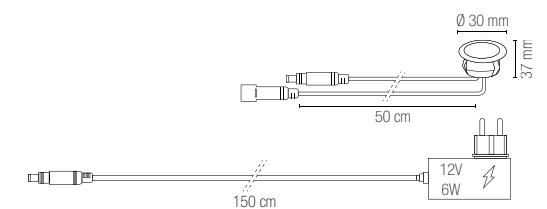
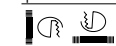

Photometrie des Produkts / Photometric curve

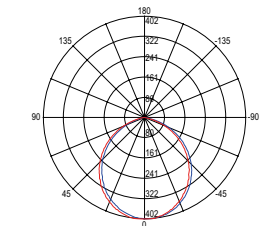

LED-RIDER-R6

Enthaltenes Zubehör / Accessories included

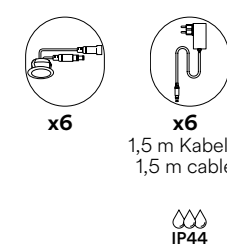

Enthaltenes Zubehör / Accessories included

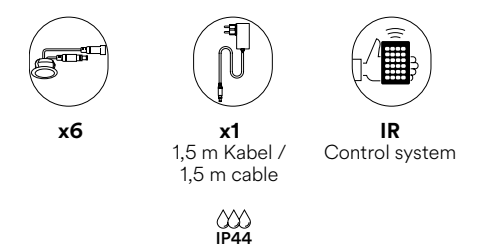

RIDER

Das elegante silberne Finish und das natürliche weiße Licht machen Rider ideal für die Verwendung in Beherbergungsbetrieben.

The elegant silver finish and natural white light make Rider ideal for installation at hospitality facilities.



Material
Zinklegierung

Material
zinc alloy

Farbe
Silber

Colour
silver

Farbtemperatur
4000K

Colour temperature
4000K

Driver

12V 6W DC
inklusive

Driver

12V 6W DC
included



LED-RIDER-R6-DIR

8031439921279

FANEU00007275

lumen 100 lm

watt	6 × 0,6W
driver	12V 6W DC
beam angle	105°
pressure loads	max 100 kg
	Ø 23 mm

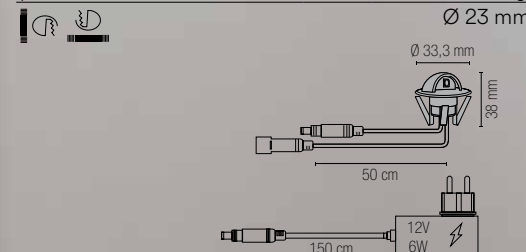

Photometrie des Produkts /
Photometric curve

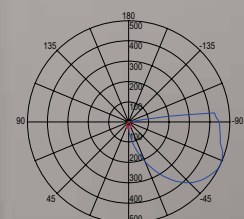

LED-RIDER-R6-DIR

Enthaltenes Zubehör /
Accessories included

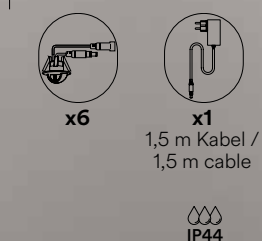

BARRET

Einbau-Orientierungsleuchte, erhältlich mit 2 Farbtemperaturen und hohem Farbwiedergabeindex. Bietet hervorragenden Schutz gegen Staub und Wasser, bis zum Eintauchen, und extreme Strapazierfähigkeit beim Begehen.

Recessed step light available in 2 colour temperatures with high colour rendering. It provides excellent protection against dust and water, even when submerged, and is extremely resistant to foot traffic.

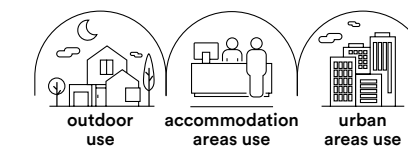

Material
Aluminium

Farbe
Nickel

Temperatura colore
3000K / 4000K

Driver

350 mA 3,5 V
Konstantstrom
nicht enthalten

Material
aluminium

Colour
nikel

Colour temperature
3000K / 4000K

Driver

350mA 3,5V
constant current
not included



LED-BARRET-R24C

8031440355070

FANEU00005848

lumen 85 lm

LED-BARRET-R24

8031440364416

FANEU00005847

lumen 85 lm

watt	1W
driver	3,5V DC
beam angle	40°
pressure loads	max 250 kg
	Ø 16 mm

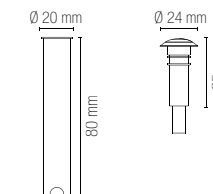

Photometrie des Produkts /
Photometric curve

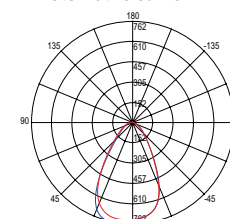

LED-BARRET-R24

Serieller Anschluss /
Serie connection system

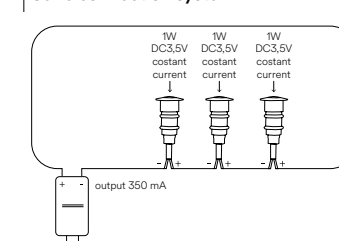

Driver ab S./from p. 414

Enthaltenes Zubehör /
Accessories included

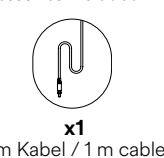

SUBWAY



Einbau-Orientierungsleuchte mit Beleuchtung mit warmem, neutralem oder blauem Licht. Aus Aluminium im Farbton Nickel, garantiert einen extrem hohen Schutzgrad in Bezug auf Staub, Flüssigkeiten und Stoßfestigkeit und eine Farbwiedergabe, die den Sehkomfort garantiert. Recessed step light with warm, neutral or blue lighting. Made of aluminium with a nickel finish, it guarantees an extremely high level of protection against dust, liquids and impacts, with a colour rendering that ensures visual comfort.

- Material**
Aluminium
- Farbe**
Nickel
- Farbtemperatur**
3000K / 4000K / BLUE
- Driver**
DC 12-24V
Konstantspannung nicht enthalten
- Material**
aluminum
- Colour**
nikel
- Colour temperature**
3000K / 4000K / BLUE



	colour temp.	colour
LED-SUBWAY-R1C 8031414879342 FANEU00007492 lumen	3000K	Nickel
LED-SUBWAY-R1M 8031414877263 FANEU00007494 lumen	4000K	Nickel
LED-SUBWAY-R1B 8031414877270 FANEU00007491 lumen	BLUE	Nickel

watt	3W
driver	12/24V
beam angle	15°
pressure loads	max 1000 kg
	Ø 24 mm

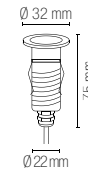

Photometrie des Produkts /
Photometric curve

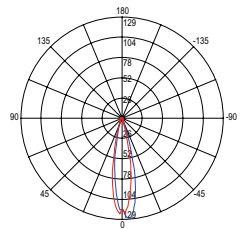

LED-SUBWAY-R1

Parallelschaltung /
Serie connection system

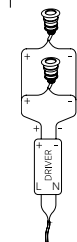

Driver ab S./from p. 414
Controller ab S./from p. 430

Enthaltenes Zubehör /
Accessories included

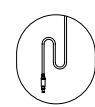

x1
1 m Kabel / 1 m cable



IMPACT



Einbau-Orientierungsleuchte aus Aluminium im Farbton Nickel mit warmem oder neutralem Licht. Garantiert den höchsten Schutzgrad in Hinblick auf Stöße und eine hervorragende Beständigkeit gegen Staub und Flüssigkeiten. Damit ist sie die ideale Wahl für Garagen oder Durchgangsbereiche mit Fahrzeugverkehr. Recessed step light in aluminium with nickel finish and warm or neutral light. It ensures maximum protection against impacts and excellent protection against dust and liquids. This makes it the ideal choice for garages or vehicle passageways.

- Material**
Aluminium
- Farbe**
Nickel
- Farbtemperatur**
3000K / 4000K
- Driver**
DC 24V
Konstantspannung nicht enthalten
- Material**
aluminum
- Colour**
nikel
- Colour temperature**
3000K / 4000K



	colour temp.	colour
LED-IMPACT24V-R1C 8031414879298 FANEU00006469 lumen	3000K	Nickel
LED-IMPACT24V-R1M 8031414879304 FANEU00006470 lumen	4000K	Nickel

watt	2W
driver	DC 24V
beam angle	105°
pressure loads	max 250 kg
	Ø 35 mm

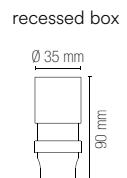

Parallelschaltung / Serie
connection system
Driver ab S./from p. 414
Controller ab S./from p. 430

Photometrie des Produkts /
Photometric curve

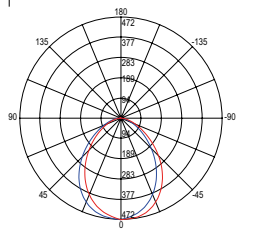

LED-IMPACT24V-R1C
LED-IMPACT24V-Q1C

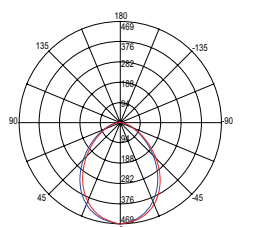

LED-IMPACT24V-R1M
LED-IMPACT24V-Q1M

	colour temp.	colour
LED-IMPACT24V-Q1C 8031414879311 FANEU00006466 lumen	3000K	Nickel
LED-IMPACT24V-Q1M 8031414879328 FANEU00006467 lumen	4000K	Nickel

watt	2W
driver	DC 24V
beam angle	105°
pressure loads	max 250 kg
	Ø 35 mm

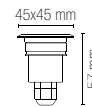
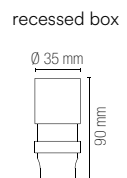

Enthaltenes Zubehör /
Accessories included



x1
1 m Kabel / 1 m cable



Material
Aluminium

Farbe
Silber



Farbtemperatur
3000K / 4000K



Driver
DC 24V
Konstantspannung
nicht enthalten

Material
aluminium

Colour
silver



Colour temperature
3000K / 4000K



Driver
DC 24V
constant voltage
not included

Einbau-Orientierungsleuchte aus Aluminium mit silbernem Finish. Erhältlich mit warmem oder neutralem Licht, mit direktem oder mehrfachem Lichtstrahl, ist sie mit technischen Eigenschaften konzipiert, die hohe Leistungen in Hinblick auf extreme Stoßfestigkeit und Beständigkeit gegen Staub und Flüssigkeiten bieten.

Recessed step light in aluminium with silver finish. Available with warm or neutral light, direct or multiple emission, it is designed with high-performance technical features for exceptional protection against impacts, dust and liquids.



	colour temp.	colour	recessed box
LED-STEP24V-R1C 8031414879250 FANEU00007473 lumen	☀	●	
LED-STEP24V-R1M 8031414879267 FANEU00007474 lumen	☾	●	
watt		2W	
driver		DC 24V	
beam angle		105°	
pressure loads		max 250 kg	
		Ø 35 mm	

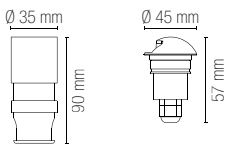

	colour temp.	colour	recessed box
LED-STEP24V-R4C 8031414879274 FANEU00007475 lumen	☀	●	
LED-STEP24V-R4M 8031414879281 FANEU00007476 lumen	☾	●	
watt		2W	
driver		DC 24V	
beam angle		105°	
pressure loads		max 250 kg	
		Ø 35 mm	

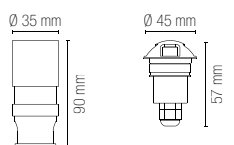

Parallelschaltung / Serie connection system
Driver ab S./from p. 414
Controller ab S./from p. 430

Photometrie des Produkts / Photometric curve

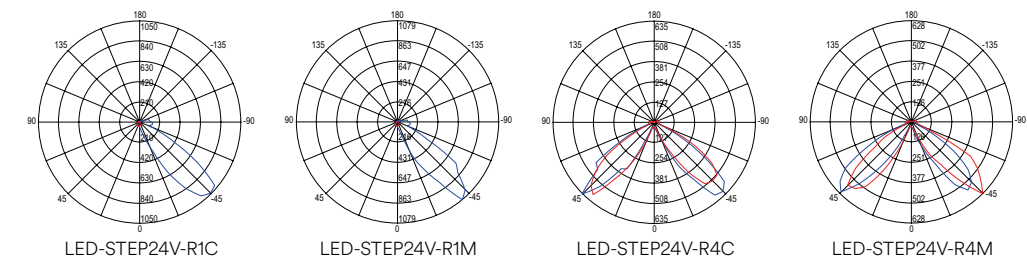

Enthaltenes Zubehör / Accessories included

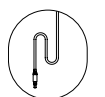

x1
1 m Kabel / 1 m cable

ELMO

Orientierungsleuchte aus Aluminiumdruckguss im Farbton Silber. Sie wird in den Versionen mit **einzeltem, doppeltem, mehrfachem oder oberem Lichtstrahl** und **zwei Farbtemperaturen** angeboten. **Hervorragende Stoßfestigkeit und Schutz vor Staub und Wasser.**

Wall light in die-cast aluminium with silver finish. Available in the versions: single, dual, multiple or higher emission lighting and dual colour temperatures. Excellent impact resistance and protection against dust and water.



Material
Aluminium

Farbe
Silber

Farbtemperatur
3000K / 4000K

Driver
DC 24V
Konstantspannung
nicht enthalten

Material
aluminium

Colour
silver

Colour temperature
3000K / 4000K

Driver
DC 24V
constant voltage
not included



Technische Informationen / Technical information **ELMO**



		<p>LED-ELMO-R1C 8031414882823 FANEU00006143 lumen</p> <p>LED-ELMO-R1M 8031414882830 FANEU00006144 lumen</p>	<table border="1"> <tr> <th>colour temp.</th> <th>colour</th> </tr> <tr> <td></td> <td></td> </tr> <tr> <td colspan="2">59 lm</td> </tr> <tr> <td></td> <td></td> </tr> <tr> <td colspan="2">65 lm</td> </tr> </table>	colour temp.	colour			59 lm				65 lm		
colour temp.	colour													
59 lm														
65 lm														
<p>watt 0,5W beam angle 90° pressure loads max 1000 kg</p>		<p>Ø 70 mm 15 mm</p>												

		<p>LED-ELMO-R2C 8031414882847 FANEU00006145 lumen</p> <p>LED-ELMO-R2M 8031414882854 FANEU00006146 lumen</p>	<table border="1"> <tr> <th>colour temp.</th> <th>colour</th> </tr> <tr> <td></td> <td></td> </tr> <tr> <td colspan="2">116 lm</td> </tr> <tr> <td></td> <td></td> </tr> <tr> <td colspan="2">121 lm</td> </tr> </table>	colour temp.	colour			116 lm				121 lm		
colour temp.	colour													
116 lm														
121 lm														
<p>watt 1W beam angle 90° x 2 pressure loads max 1000 kg</p>		<p>Ø 70 mm 15 mm</p>												

		<p>LED-ELMO-R4C 8031414882861 FANEU00006147 lumen</p> <p>LED-ELMO-R4M 8031414882878 FANEU00006148 lumen</p>	<table border="1"> <tr> <th>colour temp.</th> <th>colour</th> </tr> <tr> <td></td> <td></td> </tr> <tr> <td colspan="2">226 lm</td> </tr> <tr> <td></td> <td></td> </tr> <tr> <td colspan="2">236 lm</td> </tr> </table>	colour temp.	colour			226 lm				236 lm		
colour temp.	colour													
226 lm														
236 lm														
<p>watt 2W beam angle 90° x 4 pressure loads max 1000 kg</p>		<p>Ø 70 mm 15 mm</p>												

		<p>LED-ELMO-UPC 8031414897247 FANEU00006150 lumen</p> <p>LED-ELMO-UPM 8031414897254 FANEU00006151 lumen</p>	<table border="1"> <tr> <th>colour temp.</th> <th>colour</th> </tr> <tr> <td></td> <td></td> </tr> <tr> <td colspan="2">360 lm</td> </tr> <tr> <td></td> <td></td> </tr> <tr> <td colspan="2">380 lm</td> </tr> </table>	colour temp.	colour			360 lm				380 lm		
colour temp.	colour													
360 lm														
380 lm														
<p>watt 3W beam angle 180° pressure loads max 200 kg</p>		<p>Ø 70 mm 15 mm</p>												



I-ELMO-SPK
8031414888092
FANEU00001776

Enthaltenes Zubehör / Accessories included



x1
30 cm Kabel /
30 cm cable

In.tec light EINBAU- UND ORIENTIERUNGSLEUCHTEN / INGROUND AND WALK LIGHTS

WALK

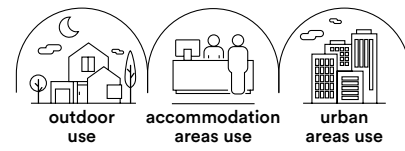

Begehbarer Einbau-Flutlichtstrahler aus Edelstahl mit höchstem Stoßfestigkeitsgrad und hervorragendem Schutz gegen Staub und Flüssigkeiten. Erhältlich mit rechteckiger, runder oder quadratischer Basis und für warmes oder neutrales Licht ausgelegt.

Walkable recessed light in stainless steel with maximum impact resistance and excellent protection against dust and liquids. Available with a rectangular, round or square base and a choice of warm or neutral light.

Material
Edelstahl

Farbtemperatur
4000K



Driver
eingebaut

Material
stainless steel

Colour temperature
4000K



Driver
built-in

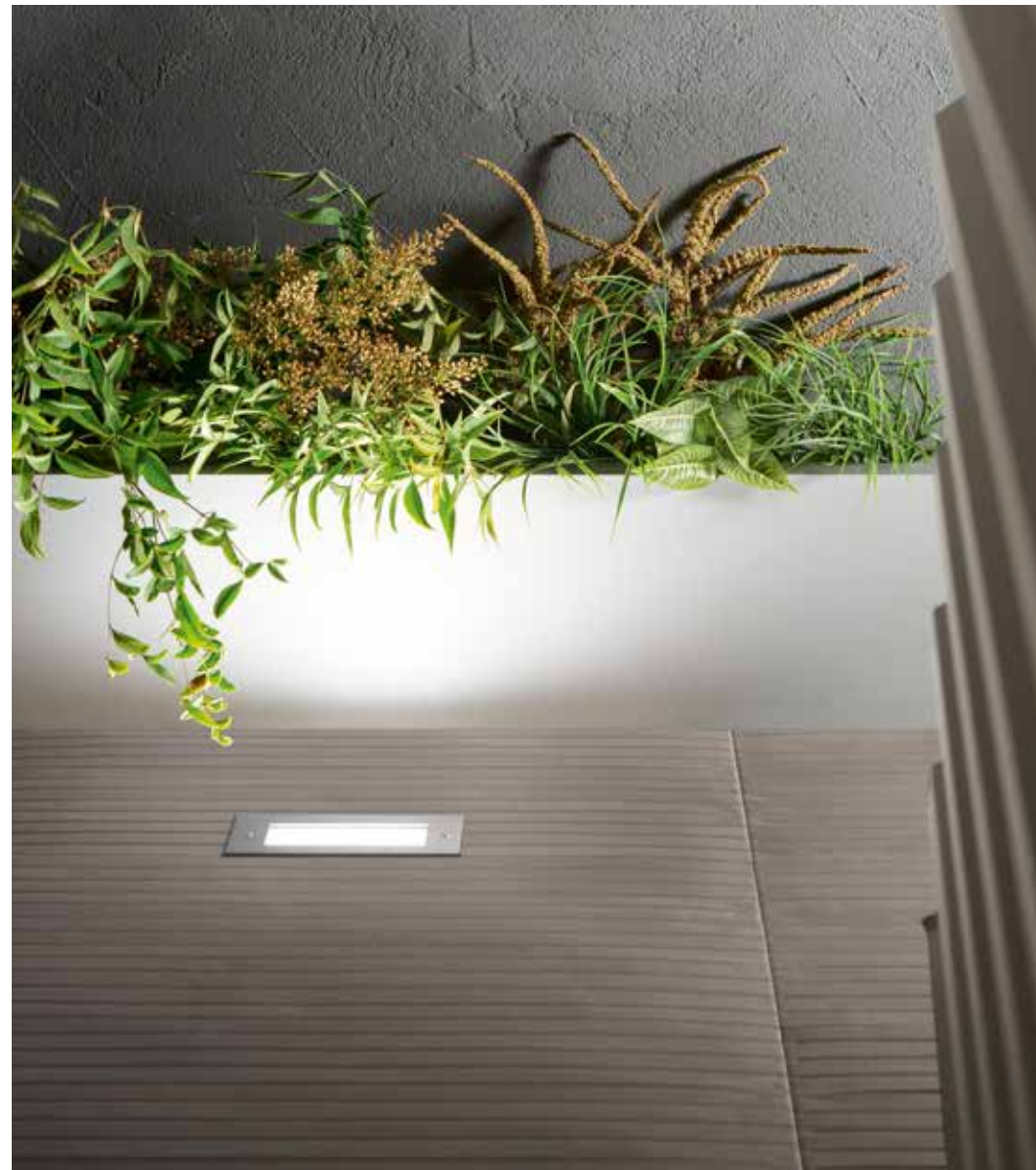

LED-WALK-RT

8031414882816

FANEU00007904

lumen

colour temp. | colour | recessed box

1500 lm

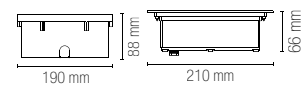

watt 12W
beam angle 30°
pressure loads max 2000 kg

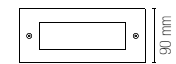

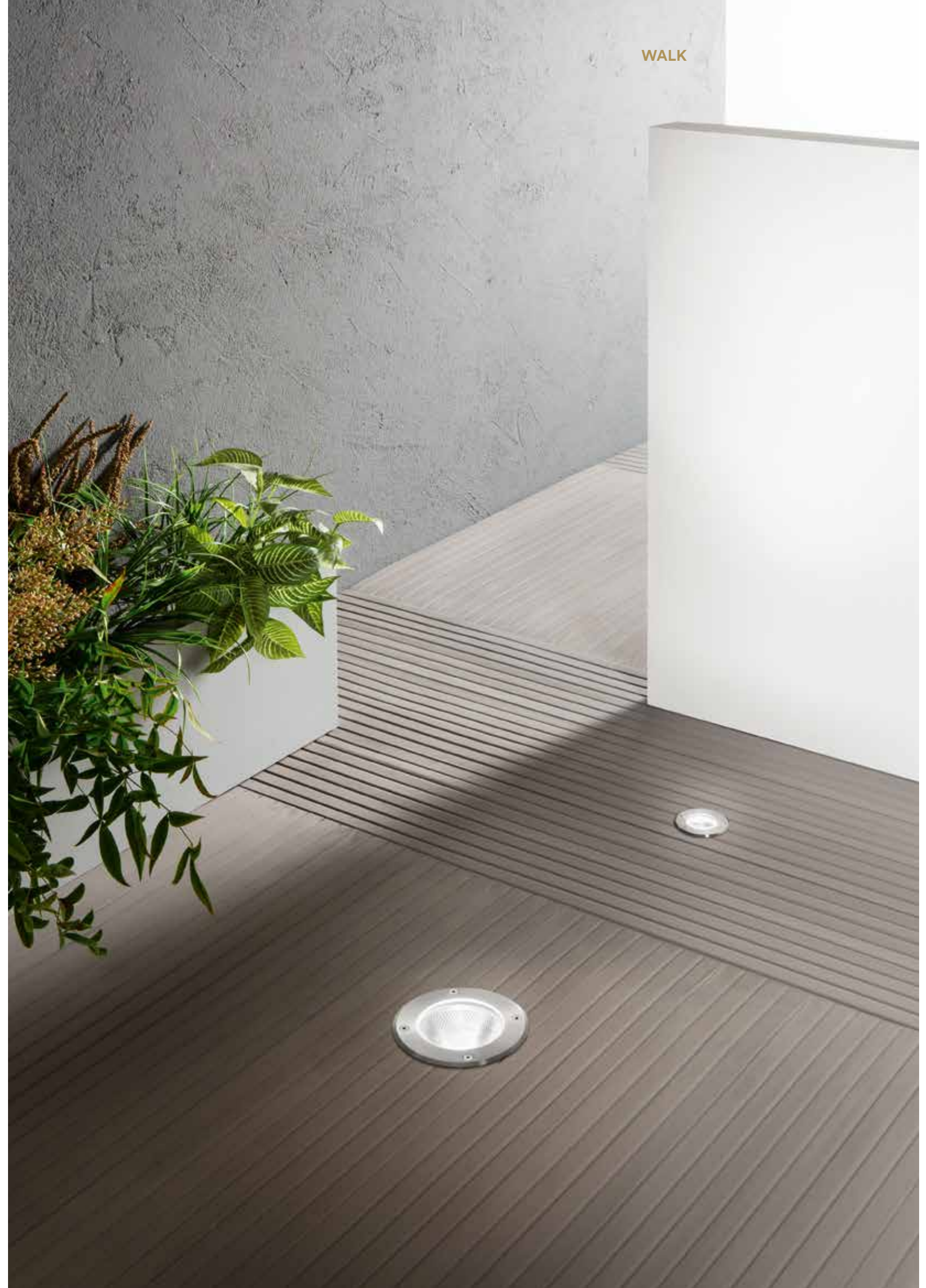

WALK





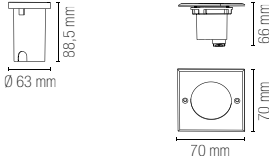



	colour temp.	colour	recessed box
LED-WALK-Q7C 8031414885824 FANEU00007896 lumen			
LED-WALK-Q7 8031440355599 FANEU00007895 lumen			
watt	3W		
beam angle	30°		
pressure loads	max 2000 kg		

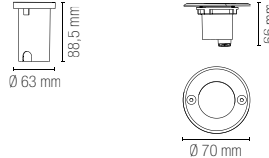

	colour temp.	colour	recessed box
LED-WALK-R7C 8031414885855 FANEU00007903 lumen			
LED-WALK-R7 8031440355582 FANEU00007902 lumen			
watt	3W		
beam angle	30°		
pressure loads	max 2000 kg		

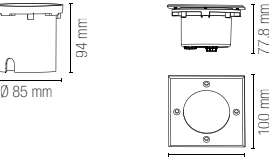

	colour temp.	colour	recessed box
LED-WALK-Q11C 8031414885800 FANEU00007892 lumen			
LED-WALK-Q11 8031440355575 FANEU00007891 lumen			
watt	8W		
beam angle	30°		
pressure loads	max 2000 kg		

	colour temp.	colour	recessed box
LED-WALK-R11C 8031414885831 FANEU00007899 lumen			
LED-WALK-R11 8031440355568 FANEU00007898 lumen			
watt	8W		
beam angle	30°		
pressure loads	max 2000 kg		

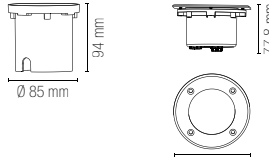
	colour temp.	colour	recessed box
LED-WALK-Q14C 8031414885817 FANEU00007894 lumen			
LED-WALK-Q14 8031440355551 FANEU00007893 lumen			
watt	12W		
beam angle	30°		
pressure loads	max 2000 kg		

	colour temp.	colour	recessed box
LED-WALK-R14C 8031414885848 FANEU00007901 lumen			
LED-WALK-R14 8031440355544 FANEU00007900 lumen			
watt	12W		
beam angle	30°		
pressure loads	max 2000 kg		

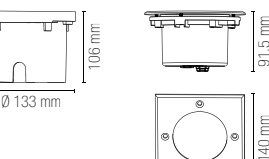

Photometrie des Produkts / Photometric curve

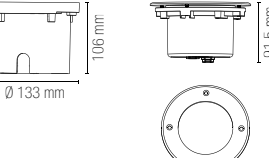

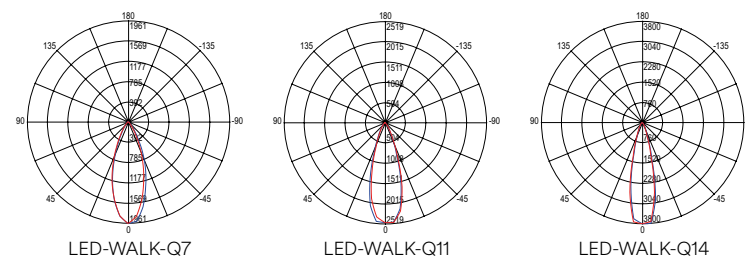
Photometrie des Produkts / Photometric curve

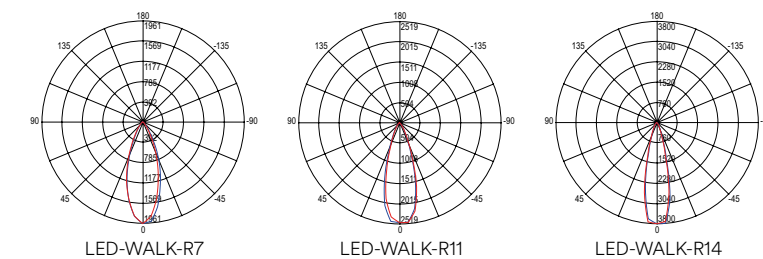



Begehbarer LED-Strahler aus Aluminium mit silbernem Finish. Das essenzielle Design umschließt technische Eigenschaften auf hohem Niveau in Hinblick auf den Schutz vor Stößen, Flüssigkeiten und Staub und bietet dabei hohe Farbwiedergabe und Blendschutzoptik.

Walkable LED light in aluminium with silver finish. Its minimalist design incorporates hi-tech features for protection against impacts, liquids and dust, with high colour rendering and anti-glare features.

- Material**
Aluminium
- Farbe**
Silber
- Farbtemperatur**
3000K / 4000K
- Driver**
inklusive
- Material**
aluminum
- Colour**
silver
- Colour temperature**
3000K / 4000K
- Driver**
included



Photometrie des Produkts / Photometric curve

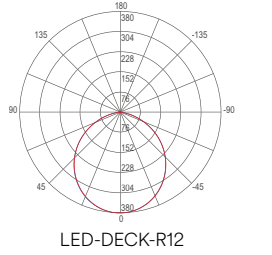

	colour temp.	colour
LED-DECK-R12C 8031414937561 FANEU00027389 lumen	☀	🌙
	1100 lm	
LED-DECK-R12M 8031414937578 FANEU00027390 lumen	🌙	🌙
	1100 lm	
watt	9W	
beam angle	107°	
pressure loads	max 250 kg	
	Ø 115 mm	

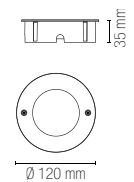

GROUND

Anthrazitfarbene Orientierungsleuchte aus Aluminiumdruckguss. Die angebotenen Modelle bieten Beleuchtung mit einem, doppeltem, mehrfachem oder oberem Lichtstrahl und zwei wählbaren Farbtemperaturen. Ideal für die Outdoor-Installation, auch in Grünflächen, dank des erhältlichen Pflocks.

Wall light in die-cast aluminium with anthracite finish. The available versions feature single, dual, multiple or higher emission lighting and selectable dual colour temperatures. Ideal for outdoor installation, also in green areas, with the provided stake.



Technische Informationen / Technical information **GROUND**



Material
Aluminium

Farbe
Anthrazit

Wählbare Farbtemperatur
3000K / 4000K

Driver
DC 24V
Konstantspannung
nicht enthalten

Material
aluminum

Colour
anthracite

Selectable color temperature
3000K / 4000K

Driver
DC 24V
constant voltage
not included

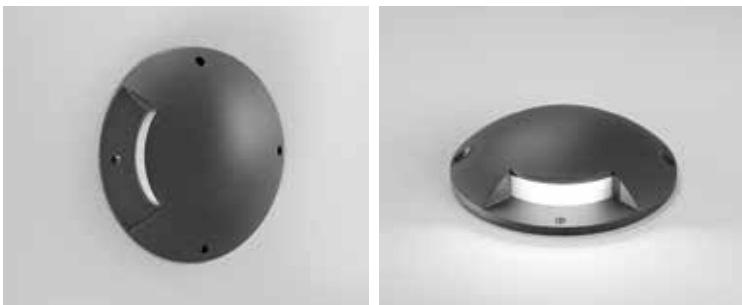

	colour temp.	colour	
LED-GROUND-R1 8031414897261 FANEU00006301 lumen			
	730 lm		
watt	6W		
beam angle	120°		
pressure loads	max 2000 kg		



	colour temp.	colour	
LED-GROUND-R2 8031414897278 FANEU00006304 lumen			
	1460 lm		
watt	12W		
beam angle	120°		
pressure loads	max 2000 kg		



	colour temp.	colour	
LED-GROUND-R4 8031414897285 FANEU00006305 lumen			
	1960 lm		
watt	16W		
beam angle	120°		
pressure loads	max 2000 kg		



	colour temp.	colour	
LED-GROUND-UP 8031414897292 FANEU00006308 lumen			
	1480 lm		
watt	12W		
beam angle	120°		
pressure loads	max 1000 kg		



LED-GROUND-SPK 8031414897308 FANEU00006307			
---------------------------------------------------------	--	--	--

HUMMER

Befahrbarer Einbau-Strahler aus Edelstahl mit überlegenen technischen Eigenschaften in Hinblick auf Stöße, Staub und Flüssigkeiten. Er kann mit verschiedenen Finishes - Silber, Schwarz oder Corten - und Beleuchtungstypen gewählt werden.

Drive-over step light in stainless steel with superior technical specifications for protection against impacts, dust and liquids. Available in a choice of finishes – silver, black or corten – and types of emission.



Technische Informationen / Technical information **HUMMER**

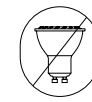

Glühbirne nicht enthalten / Light bulb not included

			colour	recessed box	
<p>I-HUMMER-R1 8031414893188 FANEU00002229</p> <p>I-HUMMER-R1-ANT 8031414895830 FANEU00002230</p> <p>I-HUMMER-R1-BRO 8031414893195 FANEU00002232</p>					
<p>1 x GU10 MAX 35W pressure loads max 500 kg</p>					

			colour	recessed box	
<p>I-HUMMER-R2 8031414893201 FANEU00002235</p> <p>I-HUMMER-R2-ANT 8031414895847 FANEU00002236</p> <p>I-HUMMER-R2-BRO 8031414893218 FANEU00002238</p>					
<p>1 x GU10 MAX 35W pressure loads max 500 kg</p>					

			colour	recessed box	
<p>I-HUMMER-R4 8031414877249 FANEU00002241</p> <p>I-HUMMER-R4-ANT 8031414895854 FANEU00002242</p> <p>I-HUMMER-R4-BRO 8031414893225 FANEU00002244</p>					
<p>1 x GU10 MAX 35W pressure loads max 500 kg</p>					

			colour	recessed box	
<p>I-HUMMER-UP 8031414893232 FANEU00002247</p> <p>I-HUMMER-UP-ANT 8031414895861 FANEU00002248</p> <p>I-HUMMER-UP-BRO 8031414893249 FANEU00002250</p>					
<p>1 x GU10 MAX 35W pressure loads max 500 kg</p>					

In.tec light EINBAU- UND ORIENTIERUNGSLEUCHTEN / INGROUND AND WALK LIGHTS

DRIVE

Begehbarer Einbau-Strahler aus Edelstahl mit silbernem Finish und runder oder quadratischer Basis. Dazu konzipiert, den höchsten Grad an Stoßfestigkeit, umfassenden Schutz vor Staub und bei vorübergehendem Eintauchen zu garantieren.

Walkable recessed light in stainless steel with silver finish and round or square base. Designed to guarantee maximum impact resistance and full protection against dust and temporary immersion.



Technische Informationen / Technical information **DRIVE**

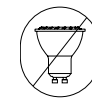

Glühbirne nicht enthalten / Light bulb not included



colour	recessed box
●	
I-DRIVE-R1 8031440313261 FANEU00001625	
1 x GU10 MAX 42W pressure loads max 500 kg	



colour	recessed box
●	
I-DRIVE-Q1 8031440313254 FANEU00001622	
1 x GU10 MAX 42W pressure loads max 500 kg	



colour	recessed box
●	
I-DRIVE-M-R1 8031440313247 FANEU00001620	
1 x GU10 MAX 42W pressure loads max 500 kg	



Glühbirne nicht enthalten / Light bulb not included



colour	recessed box
●	
I-DRIVE-E27 8031440313230 FANEU00001618	
1 x E27 MAX 60W pressure loads max 500 kg	



Material
PC

Farbe
Weiß
Schwarz



Wählbare Farbtemperatur
3000K / 4200K / 6500K



Driver
eingebaut

Material
PC

Colour
white
black



Selectable color temperature
3000K / 4200K / 6500K



Driver
built-in

Wandleuchte aus Polycarbonat, in den Farben Weiß oder Schwarz erhältlich. Mit Auswahl des Weißtons - warmes, neutrales und kaltes Licht -, hoher Farbwiedergabe und hoher Beständigkeit gegen Witterungseinflüsse. Durch ihren sauberen Stil ist sie sowohl für Außen- als auch für Innenbereiche geeignet.
Wall lamp in polycarbonate, available in white or black. Selectable warm, neutral and cool white light, high colour rendering and high protection against adverse weather conditions. With its sleek design, it can be placed in outdoor or indoor spaces.



	colour temp.	colour
LED-W-OASIS-BCO 8031414927944 FANEU00027282		
lumen	370 lm	

watt	3W
beam angle	100°

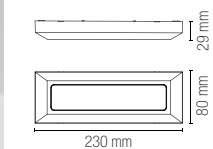

	colour temp.	colour
LED-W-OASIS-NER 8031414927951 FANEU00027283		
lumen	370 lm	

watt	3W
beam angle	100°

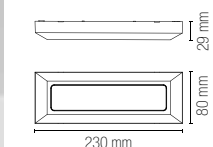

STEPLIGHT

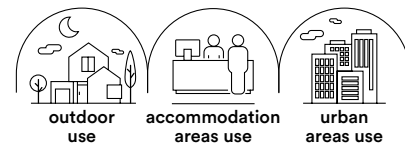

LED-Orientierungsleuchte aus Thermoplast mit anthrazitfarbenem Finish. Für die Verwendung in Außenbereichen ausgelegt, kann auch in Durchgangsbereichen im Inneren von Beherbergungsbetrieben eingesetzt werden.

LED wall light in thermoplastic with anthracite finish. Designed for outdoor use, it can also be installed in indoor pass-through areas in hospitality facilities.

- Material**
Thermoplast
- Farbe**
Schwarz
- Farbtemperatur**
4000K
- Driver**
eingebaut
- Material**
thermoplastic
- Colour**
black
- Colour temperature**
4000K
- Driver**
built-in

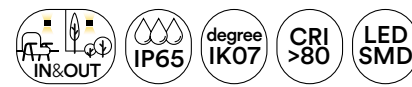

LED-STEPLIGHT
8031414882304
FANEU00007477
lumen

colour temp. | colour |
95 lm

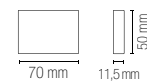

watt 1W
beam angle 120°

SHELBY

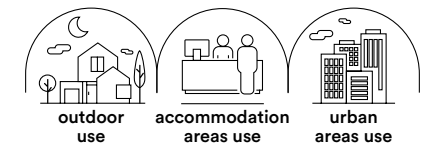

LED-Orientierungsleuchte aus Aluminium mit geprägtem Finish im Farbton Anthrazit. Als elegante Lösung für Outdoor- und Indoor-Bereiche bietet Shelby die Wahl von warmem oder neutralem Licht und eine hervorragende Farbwiedergabe.

LED wall light in aluminium with anthracite embossed finish. An elegant solution for outdoor or indoor spaces, Shelby provides selectable warm or neutral light and excellent colour rendering.

- Material**
Aluminium
- Farbe**
Anthrazit, geprägt
- Wählbare Farbtemperatur**
3000K / 4000K
- Driver**
eingebaut
- Material**
aluminium
- Colour**
embossed anthracite
- Selectable color temperature**
3000K / 4000K
- Driver**
built-in



LED-W-SHELBY-130
8031440361002
FANEU00007834
lumen

colour temp. | colour |
445 lm

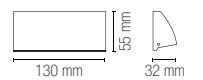

watt 4W
beam angle 120°



LED-W-SHELBY-170
8031440361019
FANEU00007837
lumen

colour temp. | colour |
670 lm

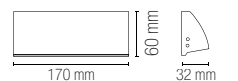

watt 6W
beam angle 120°



Orientierungsleuchte aus Aluminiumdruckguss im kompakten Format mit geprägtem Finish in Schwarz oder Weiß. Höchster Schutzgrad gegen Stöße, hohe Farbwiedergabe und minimalistisches Design für Anwendungen in sämtlichen Außen- und Innenbereichen.
 Step light in die-cast aluminium, compact and available in black or white embossed finish. Maximum protection against impacts, high colour rendering and minimalist design for use in any outdoor or indoor space.

	INC-ONYX-Q1C BCO 8031414929429 FANEU00026038 lumen	colour temp.	colour	recessed box 	
	INC-ONYX-Q1 BCO 8031414864089 FANEU00004978 lumen				
	INC-ONYX-Q1C NERO 8031414929436 FANEU00026039 lumen			recessed box 	
	INC-ONYX-Q1 NERO 8031440361262 FANEU00004979 lumen				
		watt	3W		
		beam angle	45°		
			Ø 68 mm		

	INC-ONYX-R1C BCO 8031414929443 FANEU00026040 lumen	colour temp.	colour	recessed box 	
	INC-ONYX-R1 BCO 8031440361248 FANEU00004982 lumen				
	INC-ONYX-R1C NERO 8031414929450 FANEU00026041 lumen			recessed box 	
	INC-ONYX-R1 NERO 8031440361255 FANEU00004983 lumen				
		watt	3W		
		beam angle	45°		
			Ø 68 mm		

- Material**
Aluminium
- Farbe**
Weiß
Schwarz
- Farbtemperatur**
3000K / 4000K
- Driver**
eingebaut
- Material**
aluminum
- Colour**
white
black
- Colour temperature**
3000K / 4000K
- Driver**
built-in

STRATOS

Einbau-Orientierungsleuchte, kompatibel mit der Unterbringung in Abzweigdose 503, 504 oder 506. Erhältlich mit Blenden aus Aluminium in den Farben Weiß, Anthrazit, Silber oder Corten, gestattet die individuelle Auslegung der Kelvin-Temperatur.

Recessed step light box, compatible with 503, 504 or 506 junction boxes. Available with an aluminium mounting plate in white, anthracite, silver or corten, and customisable Kelvin setting.

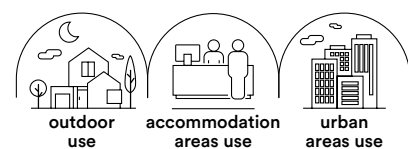

STRATOS



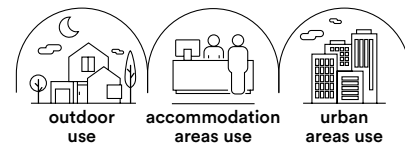

- | | |
|---------------------------------------------------------|--------------------------------------------------------------|
| Material
Aluminium | Material
aluminium |
| Farbe
Weiß
Silber
Schwarz
Corten | Colour
white
silver
black
corten |
| | |
| Wählbare Farbtemperatur
3000K / 4000K / 6000K | Selectable color temperature
3000K / 4000K / 6000K |
| | |
| Driver
eingebaut | Driver
built-in |



INC-STRATOS-503
8031414888184
FANEU00005170
lumen 360 lm

colour temp.

watt 3W
beam angle 120°

INC-STRATOS-504
8031414888221
FANEU00005178
lumen 360 lm

colour temp.

watt 3W
beam angle 120°

INC-STRATOS-506
8031414888276
FANEU00005183
lumen 600 lm

colour temp.

watt 5W
beam angle 120°

- | | |
|-----------------------------------------------------------|--------|
| INC-STRATOS-503W
8031414888690
FANEU00005177 | colour |
| INC-STRATOS-503S
8031414888214
FANEU00005176 | colour |
| INC-STRATOS-503B
8031414888191
FANEU00005174 | colour |
| INC-STRATOS-503C
8031414888207
FANEU00005175 | colour |

- | | |
|-----------------------------------------------------------|--------|
| INC-STRATOS-504W
8031414888269
FANEU00005182 | colour |
| INC-STRATOS-504S
8031414888252
FANEU00005181 | colour |
| INC-STRATOS-504B
8031414888238
FANEU00005179 | colour |
| INC-STRATOS-504C
8031414888245
FANEU00005180 | colour |

- | | |
|-----------------------------------------------------------|--------|
| INC-STRATOS-506W
8031414888313
FANEU00005190 | colour |
| INC-STRATOS-506S
8031414888306
FANEU00005189 | colour |
| INC-STRATOS-506B
8031414888283
FANEU00005187 | colour |
| INC-STRATOS-506C
8031414888290
FANEU00005188 | colour |

Abzweigdose 503
503 junction box
Nicht enthalten /
not included

Abzweigdose 503
503 junction box
Nicht enthalten /
not included

Abzweigdose 504
504 junction box
Nicht enthalten /
not included

Abzweigdose 506L
506L junction box
Nicht enthalten /
not included



- Material**
Aluminiumstruktur
und Diffusor
aus Hartglas
- Wählbare
Farbtemperatur**
3000K / 4000K / 5500K
- Driver**
eingebaut
- Material**
structure in
aluminum and
tempered glass diffuser
- Selectable color
temperature**
3000K / 4000K / 5500K
- Driver**
built-in

Einbau-Orientierungsleuchte zur Unterbringung in Abzweigdose 502, 503 oder 506. Der Diffusor besteht aus weißem Hartglas, mit Einstellung der Farbtemperatur. Slab ist in verschiedenen Designausführungen erhältlich und für die Verwendung in Gewerbebereichen, Büros oder Beherbergungsbetrieben konzipiert.
 Recessed step light box, compatible with 502, 503 or 506 junction boxes. White tempered glass diffuser, with colour temperature adjustment. Available in various designs, Slab is designed for use in retail spaces, offices or hospitality facilities.



INC-SLAB-502
8031414888177
FANEU00005122
lumen

colour temp. colour
360 lm

watt 3W
beam angle 120°
Ø 60 mm

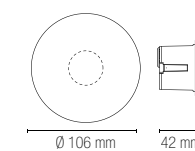

Federn enthalten /
spring included

Doppeltes Befestigungssystem / Double fixing system

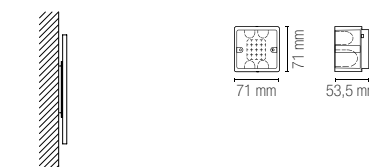

Wand- oder
Deckeneinbau /
Recessed wall or
ceiling mounting

Abzweigdose 502E
502E junction box
Nicht enthalten / not included



INC-SLAB-503
8031414864683
FANEU00005123
lumen

colour temp. colour
440 lm

watt 3W
beam angle 120°
92 × 55 × 31 mm

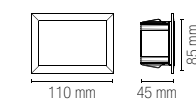

Abzweigdose 503
503 junction box
Nicht enthalten / not included

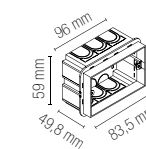

INC-SLAB-506
8031414877232
FANEU00005127
lumen

colour temp. colour
730 lm

watt 5W
beam angle 120°
163 × 60 × 50 mm

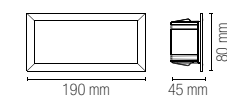

Abzweigdose 506L
506L junction box
Nicht enthalten / not included

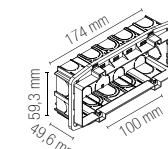



Einbau-Orientierungsleuchte zur Unterbringung in Abzweigdose 503 oder 506 in den Farben Weiß, Anthrazit oder geprägtem Corten. Durch den erlesenen Stil und die einstellbare Farbtemperatur ist sie die ideale Wahl für Büros, Gewerberäume, Hotels und Restaurants.

Recessed step light box, compatible with 503 or 506 junction boxes. Available in white, anthracite or corten embossed finish. With its sophisticated style and adjustable colour temperature, it is the perfect choice for offices, retail spaces, hotels or restaurants.

	colour temp.	colour
INC-BREEN-503 BCO 8031414864690 FANEU00004773 lumen		
		290 lm
INC-BREEN-503 ANT 8031414866809 FANEU00004772 lumen		
		300 lm
INC-BREEN-503 BRO 8031414888139 FANEU00004774 lumen		
		290 lm
watt		3W

Abzweigdose 503
503 junction box
Nicht enthalten / not included

	colour temp.	colour
INC-BREEN-506 BCO 8031414888153 FANEU00004776 lumen		
		380 lm
INC-BREEN-506 ANT 8031414888146 FANEU00004775 lumen		
		380 lm
INC-BREEN-506 BRO 8031414888160 FANEU00004777 lumen		
		380 lm
watt		4W

Abzweigdose 506L
506L junction box
Nicht enthalten / not included

Doppeltes Befestigungssystem / Double fixing system

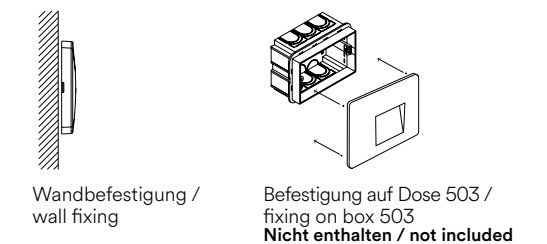

Material
Polycarbonat

Farbe
Weiß, geprägt
Anthrazit, geprägt
Corten, geprägt



Wählbare Farbtemperatur
3000K / 4000K



Driver
eingebaut

Material
polycarbonate

Colour
embossed white
embossed anthracite
embossed corten



Selectable color temperature
3000K / 4000K

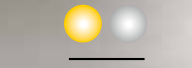

Driver
built-in



SMILE



Technische Informationen / Technical information **SMILE**



- Material**
PC
- Farbe**
Weiß
Anthrazit
- Wählbare Farbtemperatur**
3000K / 3500K / 4000K
- Driver**
eingebaut
- Material**
PC
- Colour**
white
anthracite
- Selectable color temperature**
3000K / 3500K / 4000K
- Driver**
built-in

LED-Orientierungsleuchte aus Aluminium mit doppelter Anbringung: an der Wand oder auf Abzweigdose 502E. Das Modell bietet zwei Farbgebungen - Weiß oder Anthrazit -, die individuelle Wahl der Kelvin-Temperatur und eine für die Sicht angenehme Beleuchtung.
LED wall light in aluminium with dual mounting system: on wall or on 502E junction box. The model is available in two colours - white or anthracite - with customisable Kelvin setting and eye-friendly lighting.



	colour temp.	colour
LED-SMILE-BCO 8031414881574 FANEU00007433 lumen		
watt	3W	
beam angle	100°	

Doppeltes Befestigungssystem / Double fixing system

Wandbefestigung / wall fixing Befestigung auf Dose 502E / fixing on box 502E
Nicht enthalten / not included



	colour temp.	colour
LED-SMILE-ANT 8031414881567 FANEU00007432 lumen		
watt	3W	
beam angle	100°	

Doppeltes Befestigungssystem / Double fixing system

Wandbefestigung / wall fixing Befestigung auf Dose 502E / fixing on box 502E
Nicht enthalten / not included

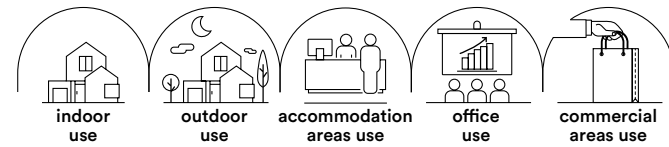

- Material**
Aluminium
und Stahlblenden
- Farbe**
Nickel
Weiß
- Wählbare Farbtemperatur**
2800K / 3500K / 4500K / 5000K / 6500K
- Driver**
eingebaut
- Material**
aluminum and
steel frames
- Colour**
nikel
white
- Selectable color temperature**
2800K / 3500K / 4500K / 5000K / 6500K
- Driver**
built-in

Für die Unterbringung in den Abzweigdosen 503 ausgelegte Einbau-Orientierungsleuchte. Mit Bewegungs- und Dämmerungssensor und mit austauschbarer doppelter Stahlplakette in den Farben Nickel oder Weiß erhältlich. Recessed step light, compatible with 503 junction boxes. Fitted with a motion sensor and twilight sensor, it is available with a dual interchangeable steel mounting plate with a nickel or white finish.



Mehrere Produkte seitlich in einem Mindestabstand von 2 m installieren / Install multiple bolt 503S within 2 m of each other

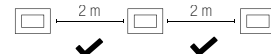

Die Produkte wegen möglichen Konflikts nicht einander gegenüberliegend installieren / Do not install products one of facing each other for possible conflict

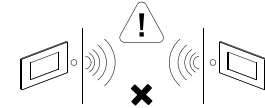

Das Produkt darf nicht in der Nähe einer starken und konstanten Lichtquelle mit über 20 LUX installiert werden / Do not install the bolt 503S near a light source with intensity over 20 LUX

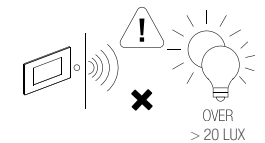

Material
PC und
Stahlblenden

Farbe
Nickel
Weiß

Wählbare Farbtemperatur
3000K / 4500K / 6500K

Driver
eingebaut

Material
PC and
steel frames

Colour
nikel
white

Selectable color temperature
3000K / 4500K / 6500K

Driver
built-in

Einbau-Orientierungsleuchte zur Unterbringung in Abzweigdose 503 oder 506L. Der Artikel wird mit doppelter austauschbarer Stahlplakette in den Farben Nickel oder Weiß geliefert. Bietet drei wählbare Farbtemperaturen. Recessed step light, compatible with 503 or 506L junction boxes. The product is provided with a dual interchangeable steel mounting plate with a nickel or white finish. Available with 3 selectable colour temperatures.

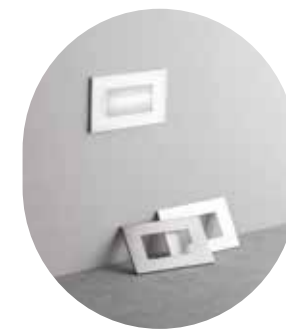

	colour temp.	colour		colour temp.	colour	
INC-BOLT-503S 8031414866281 FANEU00004763 lumen	●	●	200 lm	INC-BOLT-506S 8031414936694 FANEU00026611 lumen	● ● ● ● ●	650 lm
watt	3W		watt	5W		
beam angle	120°		beam angle	120°		

	colour temp.	colour		colour temp.	colour	
INC-BOLT-503CCT 8031414881543 FANEU00004759 lumen	● ● ● ● ●	● ● ● ● ●	350 lm	INC-BOLT-506CCT 8031414881550 FANEU00004766 lumen	● ● ● ● ● ● ● ● ● ● ●	650 lm
watt	3W		watt	5W		
beam angle	120°		beam angle	120°		

Enthaltenes Zubehör / Accessories included

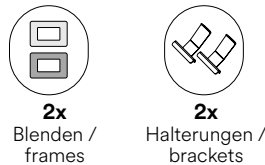

Abzweigdose 503
503 junction box
Nicht enthalten / not included

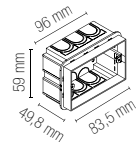

Abzweigdose 506L
506L junction box
Nicht enthalten / not included

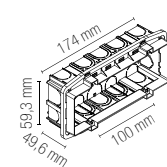

Enthaltenes Zubehör / Accessories included

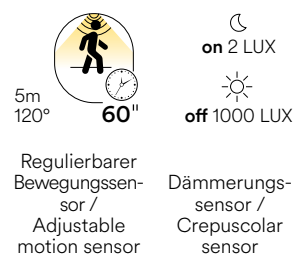

Enthaltenes Zubehör / Accessories included

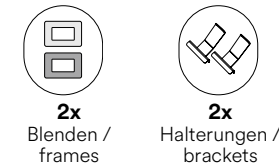

Abzweigdose 503
503 junction box
Nicht enthalten / not included

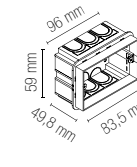

Abzweigdose 506L
506L junction box
Nicht enthalten / not included

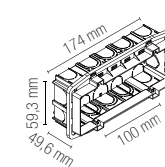



Solarleuchten / Solar lamps
outdoor

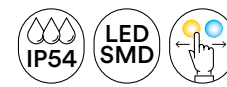

Material
PC

Farbe
Anthrazit



Farbtemperatur
2700K / 6500K



Driver
eingebaut

Material
PC

Colour
anthracite



Colour temperature
2700K / 6500K





Driver
built-in

Koordinierte Kollektion mit LED-Wand- und Bodenleuchte aus Polycarbonat mit anthrazitfarbenem Finish. Mit Solaraufladung und Aktivierungstaste des Dämmerungssensors. Erhältlich mit sehr warmer weißer oder Tageslichtbeleuchtung.



A coordinated collection comprising a wall light and a LED bollard light in polycarbonate with anthracite finish. With solar charging and twilight sensor activation button. Available with very warm white or daylight lighting.



	colour temp.	colour
LED-MAEVE-AP 8031414928002 FANEU00006742	 	
lumen	300 lm	

watt	2,8W
beam angle	120°



	colour temp.	colour
LED-MAEVE-P80 8031414928019 FANEU00006743	 	
lumen	300 lm	

watt	2,8W
beam angle	120°

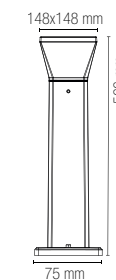

Enthaltenes Zubehör / Accessories included

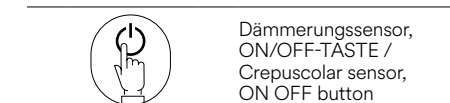

GIZAH

LED-Wandleuchte aus Polycarbonat, erhältlich mit quadratischer oder rechteckiger Form in der Farbe Anthrazit. Die Wandleuchte ist mit Solarpanel, eingebautem Bewegungssensor und verstellbarer Lichtstärke und Einschaltdauer ausgestattet.

LED wall lamp in polycarbonate, available in a square or rectangular version with anthracite finish. The wall lamp is supplied with a solar panel, integrated motion sensor and adjustable brightness intensity and lighting duration.

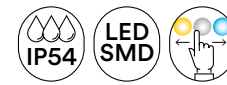

Technische Informationen / Technical information **GIZAH**



Material
PC

Farbe
Anthrazit

Farbtemperatur
3000K / 4000K / 6500K



Driver
eingebaut

Material
PC

Colour
anthracite

Colour temperature
3000K / 4000K / 6500K

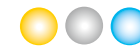

Driver
built-in



LED-GIZAH-Q 8031414931057 FANEU00023668	colour temp.	colour
lumen	500 lm	
watt	4W	
beam angle	120°	

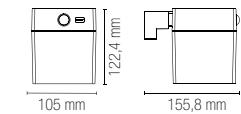

LED-GIZAH-RT 8031414931064 FANEU00023669	colour temp.	colour
lumen	500 lm	
watt	4W	
beam angle	120°	



Enthaltenes Zubehör / Accessories included

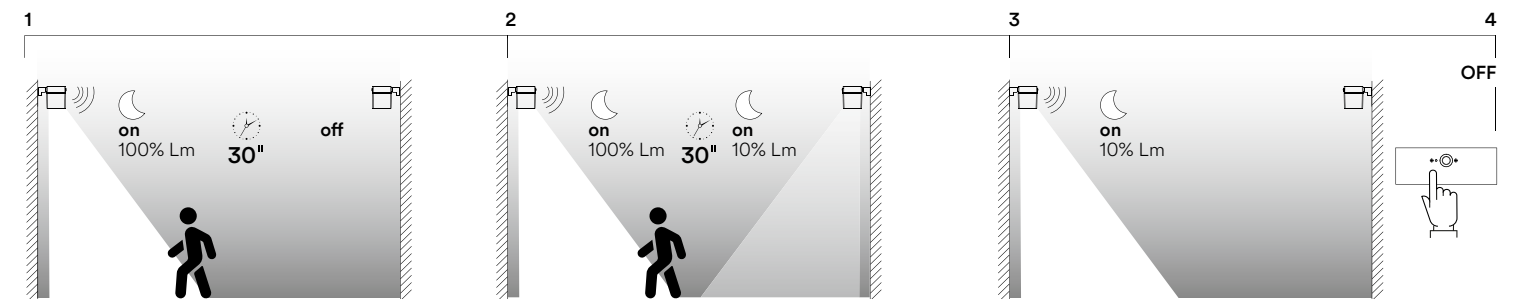

1
Bewegungssensor 100 % Licht
Nach 30 Sekunden OFF /
Motion sensor 100% light
After 30 seconds OFF

2
Bewegungssensor 100 % Licht
Nach 30 Sekunden 10 % Licht /
Motion sensor 100% light
After 30 seconds 10% light

3
Dämmerungssensor 10 % Licht
Nach < 15 Lux OFF /
Crepuscular sensor 10% light
After < 15 lux OFF do

4
OFF

IRIS

Solarbetriebene schwarze LED-Wandleuchte mit Solarpanel und verstellbarem Diffusor. Mit einstellbarem Bewegungssensor und hochleistungsfähiger Batterie ausgestattet, garantiert bis zu 8 Stunden Dauer und darüber hinaus IP-Schutz vor Staub und Flüssigkeiten.

LED solar wall lamp in black polycarbonate with solar panel and adjustable diffuser. Supplied with an adjustable motion sensor and high-efficiency batteries, it ensures up to 8 hours of battery life, and IP protection against dust and liquids.



Material
PC

Farbe
Schwarz

Farbtemperatur
2700K / 6500K

Driver
eingebaut

Material
PC

Colour
black

Colour temperature
2700K / 6500K

Driver
built-in



LED-IRIS-SOLAR
8031414928026
FANEU00006509
lumen

colour temp. colour
200 lm

watt 1,8W
beam angle 120°

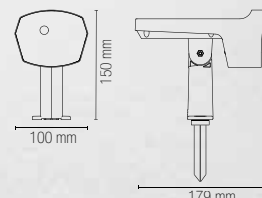

Enthaltenes Zubehör / Accessories included

Solarpanel / Solar panel

Li-ion 3,7V 2000 mAh
Batterie nicht ersetzbar /
Battery not replaceable

Dämmerungssensor,
ON/OFF-TÄSTE /
Crepuscular sensor,
ON OFF button

Pflock für Installation
im Boden enthalten /
Spike for installation
in the ground included

NASA

LED-Flutlichtleuchte aus schwarzem Polycarbonat mit um 180° verstellbarem Lichtpunkt. Mit Solarpanel und aufladbarer Batterie ausgestattet, wird sie für beste Energieausbeute mit Bewegungs- und Dämmerungssensor angeboten.

LED floodlight in black polycarbonate with 180° adjustable light point. Supplied with a solar panel and rechargeable battery, it comes with a motion sensor and twilight sensor for maximum energy saving.



Material
PC

Farbe
Schwarz

Farbtemperatur
4000K

Driver
eingebaut

Material
PC

Colour
black

Colour temperature
4000K

Driver
built-in

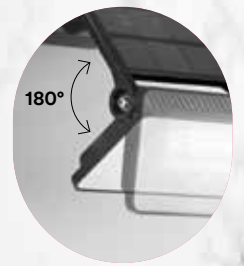

LED-NASA-SOLAR
8031414931040
FANEU00023667
lumen

colour temp. colour
1600 lm

watt 12W
beam angle 120°

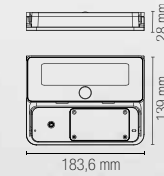

Enthaltenes Zubehör / Accessories included

Solarpanel / Solar panel

Li-ion 3,7V 1800 mAh
Batterie nicht ersetzbar /
Battery not replaceable

Bewegungssensor /
Adjustable motion sensor

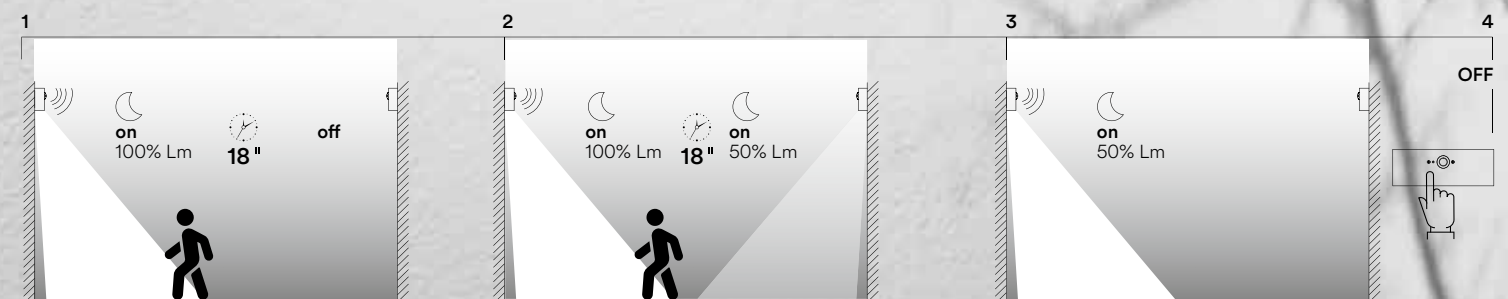

Bewegungssensor 100 % Licht
Nach 18 Sekunden OFF /
Motion sensor 100% light
After 18 seconds OFF

Bewegungssensor 100 % Licht
Nach 18 Sekunden 50 % Licht /
Motion sensor 100% light
After 18 seconds 50% light

Dämmerungssensor 50 % Licht
Nach < 15 Lux OFF /
Crepuscular sensor 50% light
After < 15 lux OFF do

GLASER

Glaser ist die batteriebetriebene Flutlichtleuchte mit Solaraufladung, die mittels Fernbedienung standortfern gesteuert werden kann. Sie bietet eine hohe Farbwiedergabe und optimalen IP-Schutz vor Staub und Wasserstrahlen und darüber hinaus Stoßfestigkeit. Der Artikel ist in verschiedenen Größen erhältlich.

Glaser is a battery-powered floodlight with remote control solar charging. It provides high colour rendering and excellent IP protection against dust and water jets, as well as protection against impacts. The product is available in various sizes.



Material
Aluminium

Farbe
Silber

Farbtemperatur
3000K / 4000K



Material
aluminium

Colour
silver

Colour temperature
3000K / 4000K



Technische Informationen / Technical information **GLASER**



LED-GLASER-SOL100C

8031414917082
FANEU00006286

lumen 1200 lm

LED-GLASER-SOL100M

8031414917075
FANEU00006287

lumen 1200 lm

beam angle 120°



Extension cable
Solar panel connection /
Verlängerungskabel
Solarpanel-Anschluss

colour temp. colour

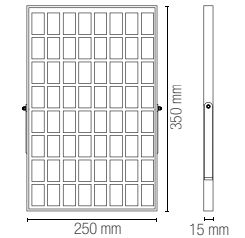
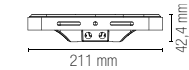
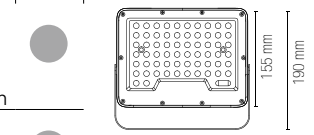

LED-GLASER-SOL200C

8031414917099
FANEU00006288

lumen 1800 lm

LED-GLASER-SOL200M

8031414917105
FANEU00006289

lumen 1800 lm

beam angle 120°



Extension cable
Solar panel connection /
Verlängerungskabel
Solarpanel-Anschluss

colour temp. colour

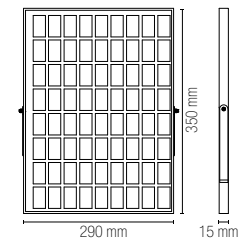
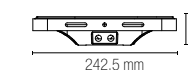
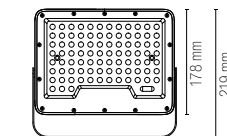

LED-GLASER-SOL400C

8031414917129
FANEU00006290

lumen 3500 lm

LED-GLASER-SOL400M

8031414917112
FANEU00006291

lumen 3500 lm

beam angle 120°



Extension cable
Solar panel connection /
Verlängerungskabel
Solarpanel-Anschluss

colour temp. colour

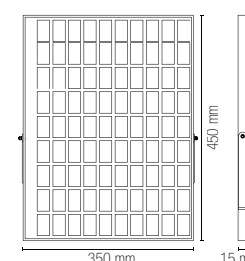
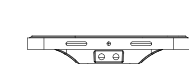
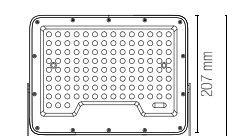

Enthaltenes Zubehör / Accessories included



Li-ion 3.2V 15Ah
Batterie nicht ersetzbar /
Battery not replaceable



Batterie nicht ersetzbar /
Battery not replaceable

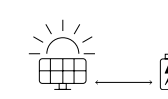

Solarpanel /
Solar panel



Fernbedienung /
Remote control

Nicht enthaltene Zubehör / Accessory not included

LED-GLASER-CABLE

8031414917136
FANEU00006279

2 m Kabel für Solarpanel mit
Stecker-/Buchsenanschluss /
2 m extension cable for solar
panel with male/female extend



Material
PC

Farbe
Anthrazit



Farbtemperatur
3000K / 4000K



Material
PC

Colour
anthracite



Colour temperature
3000K / 4000K



Im Farbton Anthrazit, eine praktische solarbetriebene Laterne, die als Wandleuchte oder oben auf einem Pfahl installiert werden kann. Ausgestattet mit einem leistungsstarken Akku garantiert es eine optimale Akkulaufzeit Lichtausbeute dank Bewegungs- und Dämmerungssensor.

A practical solar street light with anthracite finish, which can be installed as a wall light or mounted on a pole. Supplied with a powerful rechargeable battery, it guarantees optimal battery life light output thanks to the motion and twilight sensor.



	colour temp.	colour
LED-LUXOR-6C-SOLAR 8031414921898 FANEU00006736 lumen		
LED-LUXOR-6M-SOLAR 8031414921904 FANEU00006737 lumen		
watt	6,5W	
beam angle	90° x 110°	

Enthaltenes Zubehör / Accessories included

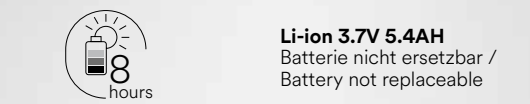
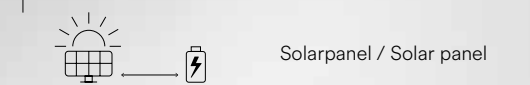

Mastbefestigungswinkel,
Eingangsdurchmesser:
min. 40 mm - max. 80 mm /
Pole mounting bracket,
entry diameter
min. 40mm - max 80mm

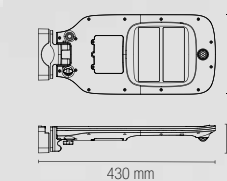

Schalter für zwei Funktionen / Switch for two functions

1. Dämmerungssensor ON 100 % Licht für 10 min
Nach 2 Stunden allmähliche Reduzierung bis auf 10 % Licht /
Crepuscular sensor ON 100% light for 10 min
After 2 hours gradual reduction to 10% light
2. Bewegungssensor ON 100 % Licht
Nach 20 Sekunden 20 % Licht /
Motion sensor ON 100% light
After 20 seconds 20% light



Flutlichtleuchten / Flood lights
outdoor

BANNER



Technische Informationen / Technical information **BANNER**



- Material
Metall
- Farbe
Satinieretes Schwarz
- Material
metal
- Colour
satin black



Flutlichtleuchte aus schwarzem Metall mit satiniertem Finish. Die Struktur ist flexibel, mit vertikal bis zu 45° und horizontal bis zu 340° verstellbarem Lichtpunkt. Bietet Schutz vor Staub und Wasserstrahlen aus allen Richtungen und einen G10-Sockel.
Spotlight in black metal with satin finish. Its structure is flexible with a light point that can be adjusted vertically up to 45°, and horizontally up to 340°. It provides protection against dust and water jets from all directions, and has a GU10 fitting.



Glühbirne nicht enthalten / Light bulb not included

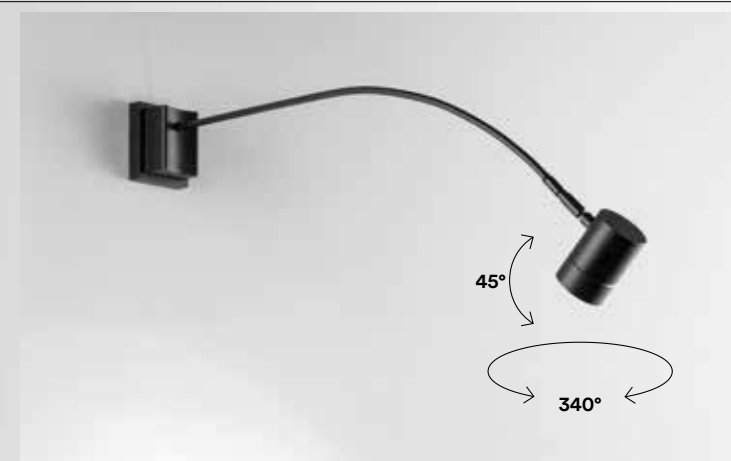

I-BANNER-AP
8031414883004
FANEU00001246

colour



1 x GU10 MAX 35W

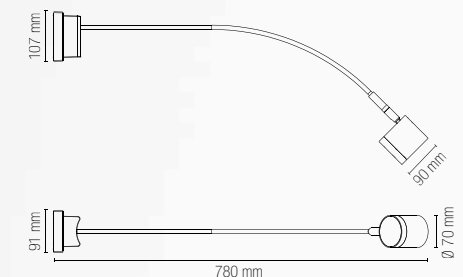

In.tec light FLUTLICHTLEUCHTEN / FLOOD LIGHTS



Material
Thermoplast

Farbe
Anthrazit



Farbtemperatur
4000K



Driver
eingebaut

Material
thermoplastic

Colour
anthracite



Colour temperature
4000K



Driver
included

Flutlichtleuchte aus Thermoplast mit neigbarem einzelner oder doppeltem Lichtpunkt. Die Beleuchtung erfolgt mit integrierter LED und die Ausstattung umfasst auch einen einstellbaren Dämmerungs- und Bewegungssensor.
Floodlight in thermoplastic with adjustable single or dual light point. Integrated LED lighting, also supplied with a twilight sensor and an adjustable motion sensor.



LED-SAT-10 8031414868261 FANEU00007335 lumen	colour temp.	colour
	1200 lm	
watt	10W	
beam angle	120°	

LED-SAT-20 8031414868278 FANEU00007336 lumen	colour temp.	colour
	2400 lm	
watt	2 × 10W	
beam angle	120°	

Enthaltenes Zubehör / Accessories included

Regulierbarer Bewegungssensor / Adjustable motion sensor

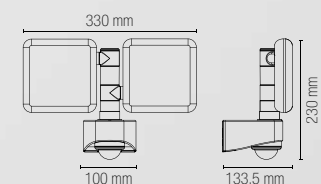
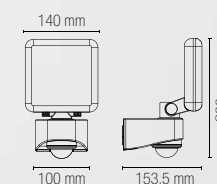
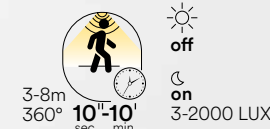

ESUS

Kollektion von LED-Flutlichtleuchten mit Diffusor aus Acryl und Gehäuse aus Aluminium mit weißem oder silberfarbenem Finish. Erhältlich in zahlreichen Größen, kann mit warmem, neutralem oder natürlich kaltem Lichtfarbton installiert werden.

A collection of LED floodlights with acrylic diffuser and aluminium fixture with a white or silver finish. Available in many sizes, it can be installed with a natural warm, neutral or cool colour temperature.

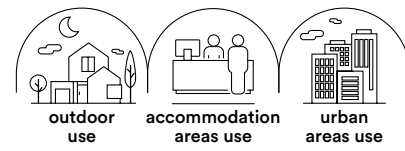

- Material**
Aluminium,
Diffusor Acryl
- Farbe**
Weiß
Silber
- Farbtemperatur**
3000K / 4000K / 6500K
- Driver**
eingebaut
- Material**
aluminium
acrylic diffuser
- Colour**
white
silver
- Colour temperature**
3000K / 4000K / 6500K
- Driver**
built-in

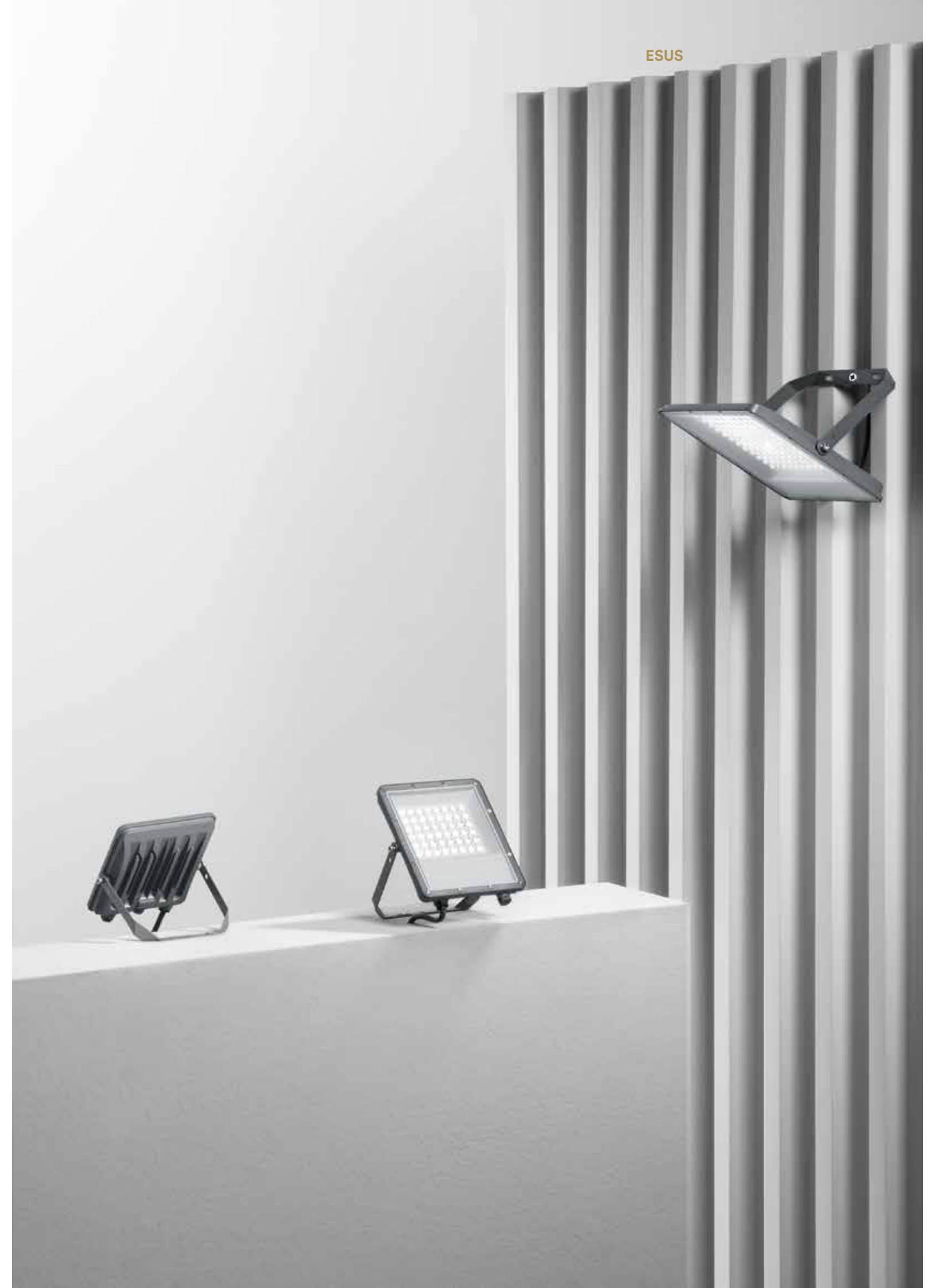

ESUS

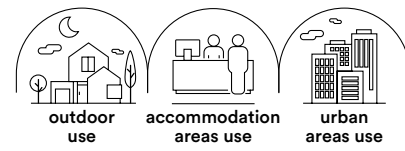

LED-ESUS-10
8031414927845
FANEU00025696
lumen

colour temp.	colour
1000 lm	

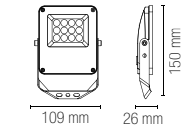

watt	10W
beam angle	110°
pf	-



LED-ESUS-10-BCO
8031414930449
FANEU00025901
lumen

colour temp.	colour
1000 lm	

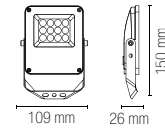

watt	10W
beam angle	110°
pf	-



LED-ESUS-20
8031414927869
FANEU00025693
lumen

colour temp.	colour
2000 lm	

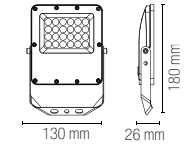

watt	20W
beam angle	110°
pf	-



LED-ESUS-20-BCO
8031414930456
FANEU00025902
lumen

colour temp.	colour
2000 lm	

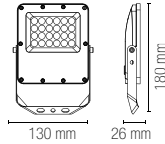

watt	20W
beam angle	110°
pf	-



LED-ESUS-30
8031414927883
FANEU00025695
lumen

colour temp.	colour
3000 lm	

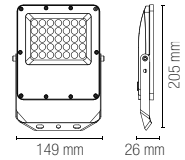

watt	30W
beam angle	110°
pf	0.90



LED-ESUS-50-BCO
8031414930463
FANEU00025903
lumen

colour temp.	colour
5000 lm	

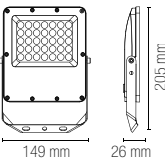

watt	50W
beam angle	110°
pf	0.90



LED-ESUS-50
8031414927906
FANEU00025700
lumen

colour temp.	colour
5000 lm	

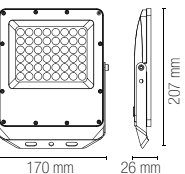

watt	50W
beam angle	110°
pf	0.90

Photometrie des Produkts / Photometric curve

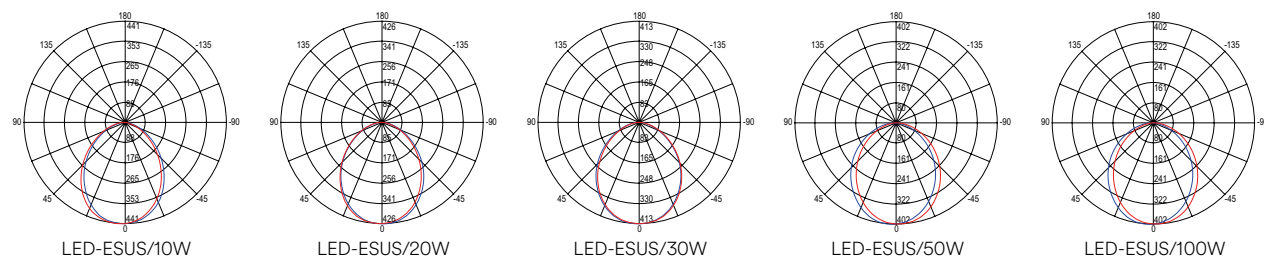

LED-ESUS-100
8031414927913
FANEU00025904
lumen

colour temp.	colour
10000 lm	

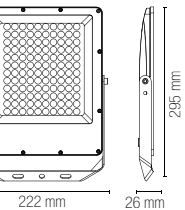

watt	100W
beam angle	110°
pf	0.90

ESUS SENSOR

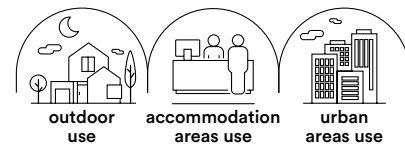

LED-Flutlichtleuchte aus weißem oder silbernem Aluminium mit konfigurierbarem Bewegungssensor. Mit drei auswählbaren Farbtemperaturen garantiert er hervorragende Leistungen in Hinblick auf Stoßfestigkeit sowie Schutz gegen Staub und Flüssigkeiten und hohe Farbtreue.

LED floodlight in aluminium with white or silver finish, with configurable motion sensor. With three selectable colour temperatures, it ensures excellent impact resistance, protection against dust and liquids and high colour fidelity.

- Material**
Aluminium
- Farbe**
Silber
- Farbtemperatur**
3000K / 4000K / 6500K
- Driver**
eingebaut
- Material**
aluminium
- Colour**
silver
- Colour temperature**
3000K / 4000K / 6500K
- Driver**
built-in



Enthaltenes Zubehör / Accessories included

Regulierbarer Bewegungssensor / Adjustable motion sensor

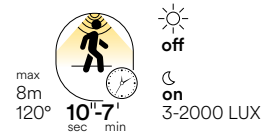

LED-ESUS-S10
8031414927852
FANEU00026612
lumen

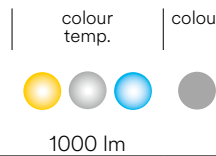

1000 lm

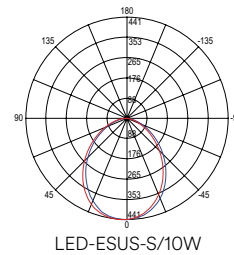

watt 10W
beam angle 110°

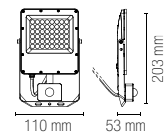

Enthaltenes Zubehör / Accessories included

Regulierbarer Bewegungssensor / Adjustable motion sensor



LED-ESUS-S30
8031414927890
FANEU00026613
lumen

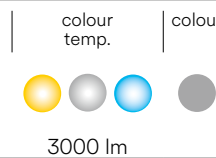

3000 lm

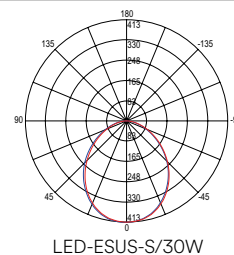

watt 30W
beam angle 110°

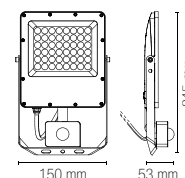

ESUS PORTABLE



Tragbare LED-Flutlichtleuchte in silbernem Finish. Ein echter Arbeitskamerad, dank des hohen Grads an Stoßfestigkeit, Schutz vor Staub und Wasserstrahlen, hohem Sehkomfort und auf 3 Temperaturen verstellbarer Helligkeit.

Portable LED floodlight with silver finish. A true work companion with its high impact resistance, protection against dust and water jets, high visual comfort and brightness adjustable to 3 colour temperatures.

- Material**
Aluminium
- Farbe**
Silber
- Farbtemperatur**
3000K / 4000K / 6500K
- Driver**
eingebaut
- Material**
aluminium
- Colour**
silver
- Colour temperature**
3000K / 4000K / 6500K
- Driver**
built-in

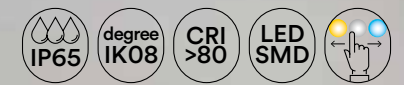

Enthaltenes Zubehör / Accessories included

Kabel 1,6 Meter mit Stecker / 1,6 m cable with plug



Verbinder IP65 enthalten / IP65 connector included

LED-ESUS-P30
8031414927876
FANEU00025699
lumen

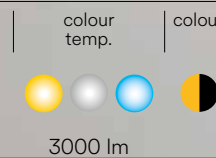

3000 lm

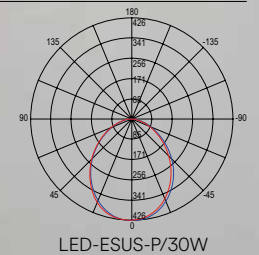

watt 30W
beam angle 110°

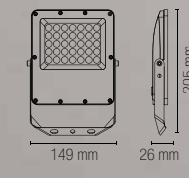

AXEL

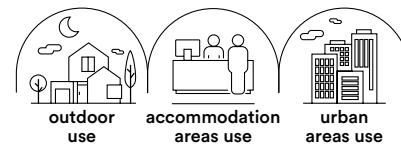

Flutlichtleuchte mit integrierter LED und Diffusor aus Acryl sowie Metallgehäuse mit geprägten Finishes in Weiß oder Silber. Erhältlich in unterschiedlichen Formaten, bietet Einstellung mit CCT, hohe Farbwiedergabe und Schutz vor Staub und Flüssigkeiten.

Floodlight with integrated LED, acrylic diffuser and metal fixture with white or silver embossed finish. Available in various sizes, it provides adjustable CCT, high colour rendering and protection against dust and liquids.

Material

Aluminium,
Diffusor Acryl

Farbe

Weiß, geprägt
Silber, geprägt



Farbtemperatur

3000K / 4000K



CCT



Driver

eingebaut

Material

aluminium
acrylic diffuser

Colour

embossed white
embossed silver



Colour temperature

3000K / 4000K



CCT



Driver

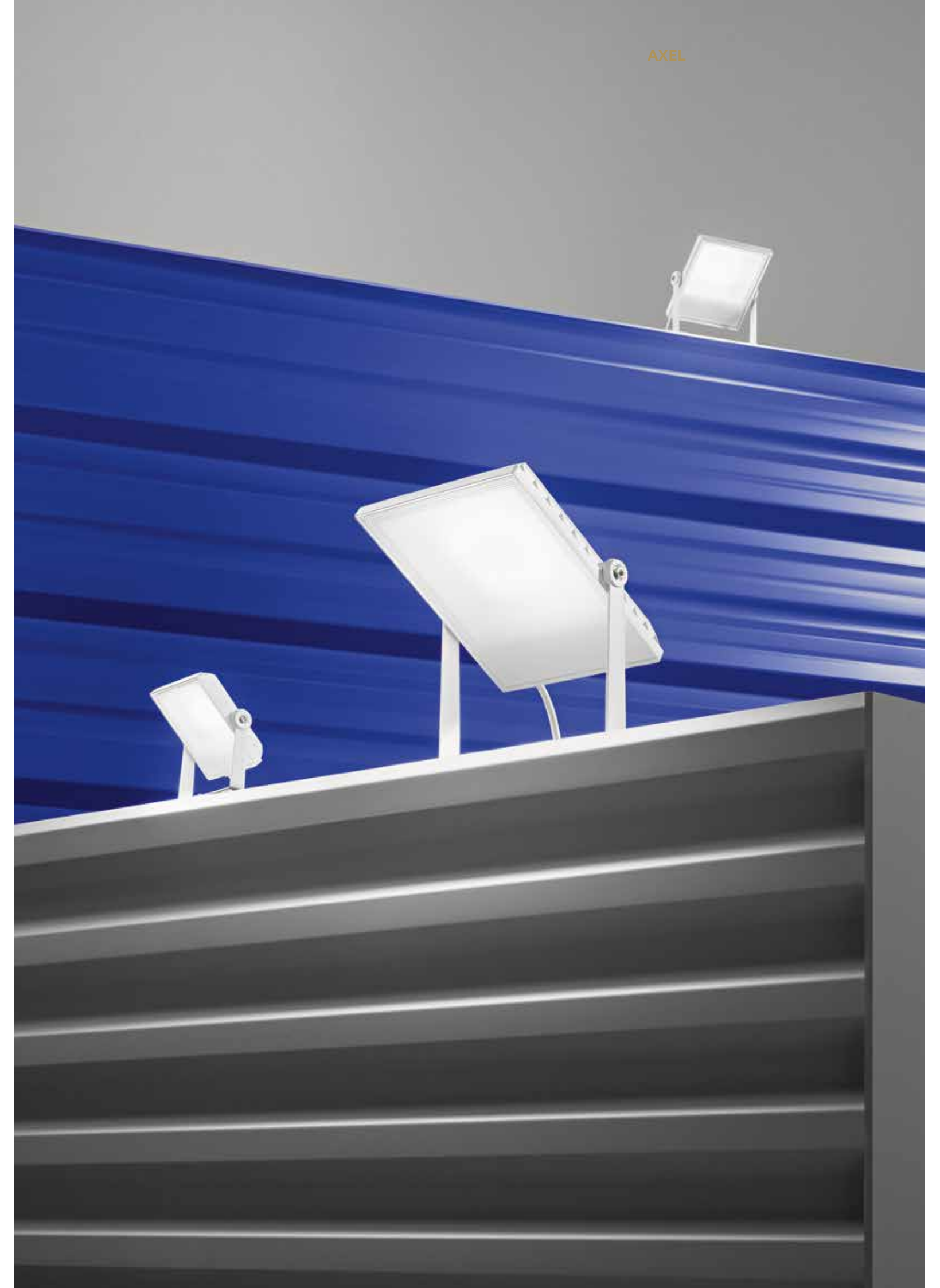

built-in







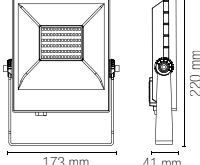

AXEL



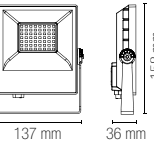

		LED-AXEL-10-BCO 8031414918744 FANEU00005816	colour temp. 	colour 	
		lumen	1100 lm		
		LED-AXEL-10-SIL 8031414918676 FANEU00005817	colour temp. 	colour 	
		lumen	1100 lm		
		watt		10W	
		beam angle		100°	
		pf		-	



	LED-AXEL-30-SIL 8031414918690 FANEU00005820	colour temp. 	colour 	
	lumen	3300 lm		
	watt		30W	
	beam angle		100°	
	pf		0.90	

		LED-AXEL-20-BCO 8031414918751 FANEU00005818	colour temp. 	colour 	
		lumen	2200 lm		
		LED-AXEL-20-SIL 8031414918683 FANEU00005819	colour temp. 	colour 	
		lumen	2200 lm		
		watt		20W	
		beam angle		100°	
		pf		-	

	LED-AXEL-100-SIL 8031414951574 FANEU00028791	colour temp. 	colour 	
	lumen	13650 lm		
	watt		100W	
	beam angle		100°	
	pf		0.95	

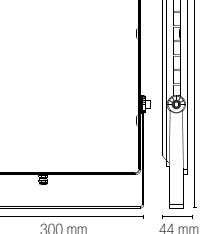
		LED-AXEL-50-BCO 8031414918768 FANEU00005821	colour temp. 	colour 	
		lumen	5500 lm		
		LED-AXEL-50-SIL 8031414918706 FANEU00005822	colour temp. 	colour 	
		lumen	5500 lm		
		watt		50W	
		beam angle		100°	
		pf		0.90	

LED-AXEL-150-SIL 8031414951581 FANEU00028792	colour temp. 	colour 	
lumen	20475 lm		
watt		150W	
beam angle		100°	
pf		0.95	

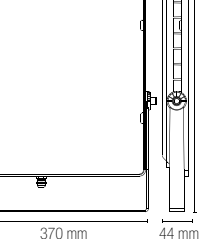
LED-AXEL-200-SIL 8031414951598 FANEU00028793	colour temp. 	colour 	
lumen	27300 lm		
watt		200W	
beam angle		100°	
pf		0.95	

AXEL SENSOR

Flutlichtleuchte aus Aluminium mit geprägtem silbernem Finish. Die Flutlichtleuchte mit integrierter LED ist für größte Zweckmäßigkeit und Energieeinsparung mit einstellbarem Bewegungs- und Dämmerungssensor ausgestattet.

Floodlight in aluminium with silver embossed finish. With integrated LED, the floodlight is supplied with a motion sensor and adjustable twilight sensor for maximum practicality and energy saving.



Material

Aluminium

Farbe

Silber, geprägt

Farbtemperatur

3000K / 4000K



Driver

eingebaut

Material

aluminium

Colour

embossed silver

Colour temperature

3000K / 4000K



Driver

built-in

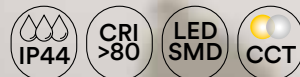

Enthaltenes Zubehör / Accessories included

Regulierbarer Bewegungssensor / Adjustable motion sensor



LED-AXEL-S10-SIL
8031414918713
FANEU00005824
lumen

colour temp. colour
1100 lm

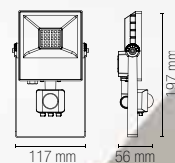

watt 10W
beam angle 110°

Enthaltenes Zubehör / Accessories included

Regulierbarer Bewegungssensor / Adjustable motion sensor



LED-AXEL-S30-SIL
8031414918737
FANEU00005825
lumen

colour temp. colour
3300 lm

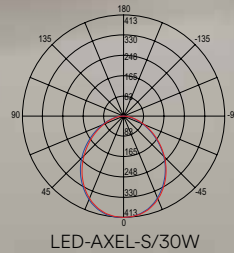
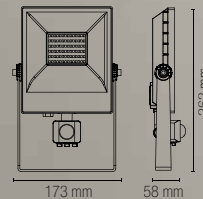

watt 30W
beam angle 110°

AXEL PORTABLE

Tragbare, zweifarbige (gelb und schwarz) LED-Flutlichtleuchte mit technischen Spezifikationen auf hohem Niveau für den Schutz vor Staub und Wasserstrahlen, CCT-Einstellung mit zwei Farbtemperaturen und hohem Farbwiedergabeindex. Portable LED floodlight with dual colour – yellow and black – with high technical specifications for protection against dust and water jets, dual CCT adjustment and high colour rendering.



Material

Aluminium

Farbe

Gelb/Schwarz



Farbtemperatur

3000K / 4000K



Driver

eingebaut

Material

aluminium

Colour

yellow/black



Colour temperature

3000K / 4000K



Driver

built-in

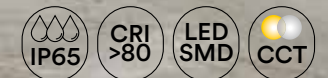

Enthaltenes Zubehör / Accessories included

Kabel 1,6 Meter mit Stecker / 1,6 m cable with plug



LED-AXEL-P20-NER
8031414918720
FANEU00005823
lumen

colour temp. colour
2200 lm

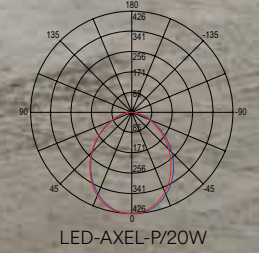
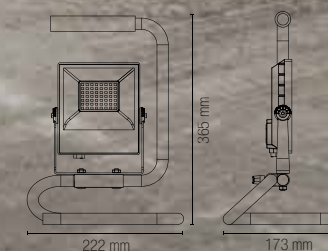

watt 20W
beam angle 110°

FLUTLICHTLEUCHTEN / FLOOD LIGHTS

In.tec light

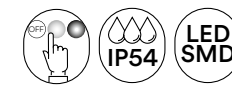

Eine Kollektion von tragbaren, batteriebetriebenen Arbeitsflutlichtleuchten in zwei Größen und in der Version mit eingebauten Bluetooth-Lautsprecher. Die Beleuchtung mit der Farbtemperatur von Tageslicht erfolgt mittels Touch-Schalter mit 3 Helligkeitsstufen.

A collection of battery-powered portable work floodlights, available in two sizes and in a version with integrated Bluetooth speaker. Daylight lighting with a touch switch offering 3 brightness settings.

- Material**
Kunststoff
- Farbe**
Gelb/Schwarz
- Farbtemperatur**
6500K
- Driver**
eingebaut
- Material**
plastic
- Colour**
yellow/black
- Colour temperature**
4000K
- Driver**
built-in



LED-BULL-15DJ 8031414917167 FANEU00026866 lumen	colour temp.	colour
	1200 lm	
watt	15W	
beam angle	90°	
switch DIMMER 25% 50% 70% 100% OFF		

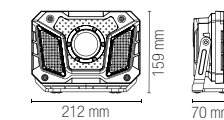

LED-BULL-10 8031414917150 FANEU00026722 lumen	colour temp.	colour
	1000 lm	
watt	10W	
beam angle	90°	
switch DIMMER 25% 50% 70% 100% OFF		

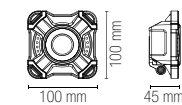

SPEAKER
2x5 W Bluetooth-Verbindung 4.2 max. 10 m /
2x5W bluetooth 4.2 connection max 10m

Enthaltenes Zubehör / Accessories included

USB
Ladekabel 60 cm /
60 cm charging cable

4 hours
3.7V/6600 mAh
Aufladbare Batterie, nicht ersetzbar /
Rechargeable battery, not replaceable

Adapter nicht enthalten /
Adaptor not included

Enthaltenes Zubehör / Accessories included

USB
Ladekabel 60 cm /
60 cm charging cable

2 hours
3.7V/2200 mAh
Aufladbare Batterie, nicht ersetzbar /
Rechargeable battery, not replaceable



Knox ist aus widerstandsfähigem Kunststoff und Aluminium hergestellt und eine Flutlichtleuchte mit auswählbarer Temperatur und doppeltem Schuko-Anschluss für größte Zweckmäßigkeit. Garantiert optimale Sicht und IP-Schutz vor Flüssigkeiten und Staub.
 Made of durable plastic and aluminium, Knox is a floodlight with selectable temperature and two rear Schuko sockets for maximum ease of use. It ensures optimum visibility and IP protection against liquids and dust.

- Material**
Kunststoff
- Farbe**
Gelb/Schwarz
- Farbtemperatur**
6500K
- Driver**
eingebaut
- Material**
plastic
- Colour**
yellow/black
- Colour temperature**
6500K
- Driver**
built-in



	colour temp.	colour
LED-KNOX-45 8031414917174 FANEU00026868 lumen		
	max 6400 lm	
watt	45W	
beam angle	120°	
	Plug 2X max 15A 250V 2500W	

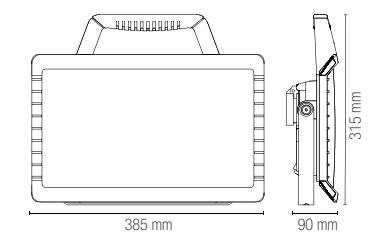

Enthaltenes Zubehör / Accessory included

 Kabel 3 Meter mit Stecker / 3 m cable with plug



	colour temp.	colour
LED-KNOX-80 8031414917181 FANEU00026870 lumen		
	max 11500 lm	
watt	80W	
beam angle	120°	
	Plug 2X max 15A 250V 2500W	

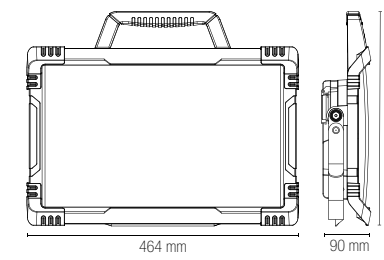

Enthaltenes Zubehör / Accessory included

 Kabel 3 Meter mit Stecker / 3 m cable with plug

Helligkeitseinstellschalter / Brightness adjustment switch



ATHOS

Flutlichtleuchte mit integrierter LED, satiniertem Diffusor und Gehäuse aus Aluminium in silbernem Finish. In drei Größen erhältlich, sichert höchste Leistungen durch Stoßfestigkeit und hohen IP-Schutz gegen Staub und Wasserstrahlen.

Floodlight with integrated LED, satin diffuser and aluminium fixture with silver finish. Available in three sizes, it ensures the highest performance in terms of impact resistance, and high IP protection against dust and water jets.



Technische Informationen / Technical information **ATHOS**



Material Aluminium	Material aluminium
Farbe Silber	Colour silver
Farbtemperatur 4000K / 6000K	Colour temperature 4000K / 6000K
Driver eingebaut	Driver built-in



LED-ATHOS-100 8031414884186 FANEU00005776 lumen	colour temp. colour ● ● 10115 lm
LED-ATHOS-100F 8031414884193 FANEU00005777 lumen	● ● 9624 lm
watt	100W
beam angle	120°
pf	0.90

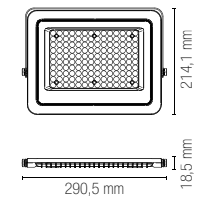

LED-ATHOS-150 8031414884209 FANEU00005778 lumen	colour temp. colour ● ● 14557 lm
LED-ATHOS-150F 8031414884216 FANEU00005779 lumen	● ● 14388 lm
watt	150W
beam angle	120°
pf	0.90

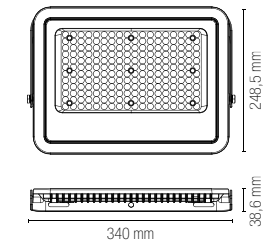

LED-ATHOS-200 8031414884223 FANEU00005780 lumen	colour temp. colour ● ● 20371 lm
LED-ATHOS-200F 8031414884230 FANEU00005781 lumen	● ● 20310 lm
watt	200W
beam angle	120°
pf	0.90

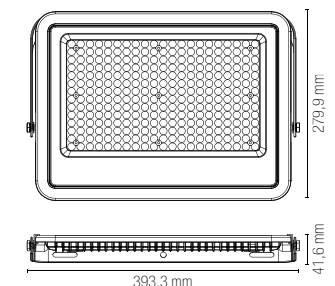

Photometrie des Produkts / Photometric curve

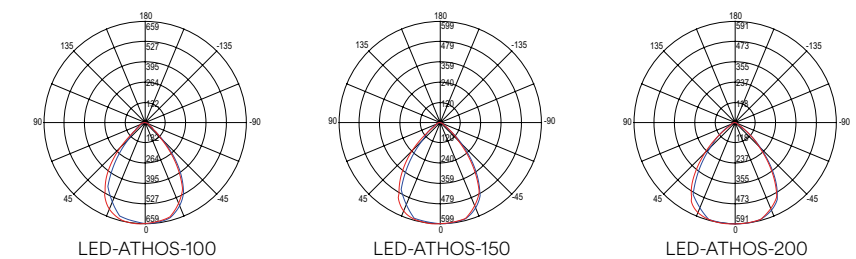



I-TRIPOD

8031440361729
FANEU00003852

Zubehör für
Flutlichtleuchten
Befestigungssystem
einzeln und doppelt

Flood light accessories
Single and double
connection system

**Enthaltenes Zubehör /
Accessories included**

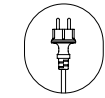

Kabel 2,8 Meter
mit Stecker /
2,8 m cable
with plug

IP44

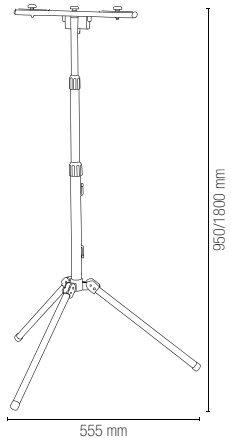

I-SPIKE-ANT

8031414877973
FANEU00003679

Anthrazitfarbener
Aluminiumpflock

Anthracite aluminum
spike

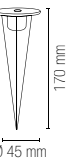

GIOVE

Flutlichtleuchte mit integrierter LED und Struktur aus Aluminiumdruckguss sowie Diffusor aus Hartglas. Erhältlich in verschiedenen Größen bietet die Möglichkeit der Auswahl verschiedener Farbtemperaturen oder von rotem und grünem Licht.

Floodlight with integrated LED, die-cast aluminium fixture and tempered glass diffuser. Available in various sizes, it allows you to select different colour temperatures or red and green light.

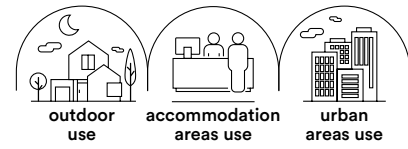

GIOVE

- Material**
Aluminium
- Farbe**
Schwarz
- Farbtemperatur**
3000K / 4000K / 6000K / RED / GREEN
- Driver**
inklusive
- Lebensdauer und on/off**
50.000 h
>25.000 on/off
- Material**
aluminium
- Colour**
black
- Colour temperature**
3000K / 4000K / 6000K / RED / GREEN
- Driver**
included
- Life time and on/off**
50.000 h
>25.000 on/off



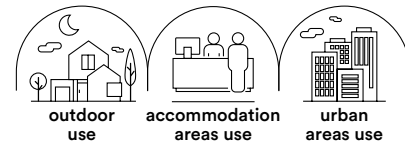

	colour temp.	beam angle	colour
LED-GIOVE-100 8031414882557 FANEU00006266		150° x 80°	
lumen	15670 lm		
watt		100W	
pf		0.90	

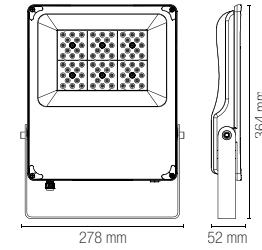

	colour temp.	beam angle	colour
LED-GIOVE-300 8031414876372 FANEU00006274		150° x 80°	
lumen	47150 lm		
watt		300W	
pf		0.90	

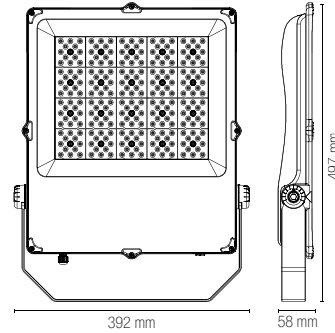

	colour temp.	beam angle	colour
LED-GIOVE-400 8031414876389 FANEU00006275		150° x 80°	
lumen	66031 lm		
watt		400W	
pf		0.90	

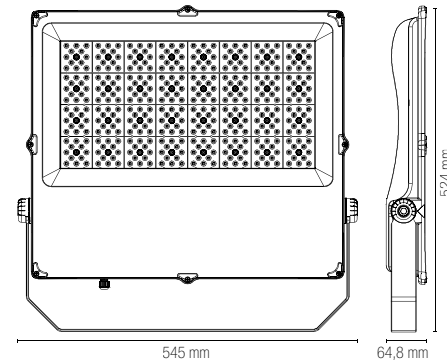

	colour temp.	beam angle	colour
LED-GIOVE-200 8031414876365 FANEU00006267		150° x 80°	
lumen	32666 lm		
LED-GIOVE-200-30 8031414885138 FANEU00006268		30°	
lumen	32666 lm		
LED-GIOVE-200-60 8031414885145 FANEU00006269		60°	
lumen	32666 lm		
LED-GIOVE-200R-30 8031414885152 FANEU00006270		30°	
lumen	RED		
LED-GIOVE-200R-60 8031414885169 FANEU00006271		60°	
lumen	RED		
LED-GIOVE-200V-30 8031414885176 FANEU00006272		30°	
lumen	GREEN		
LED-GIOVE-200V-60 8031414885183 FANEU00006273		60°	
lumen	GREEN		
watt		200W	
pf		0.90	

	colour temp.	beam angle	colour
LED-GIOVE-200C 8031414934553 FANEU00026032		150° x 80°	
lumen	32000 lm		
LED-GIOVE-200M 8031414934560 FANEU00026033		150° x 80°	
lumen	32000 lm		
LED-GIOVE-200C-30 8031414934577 FANEU00026034		30°	
lumen	32000 lm		
LED-GIOVE-200M-30 8031414934591 FANEU00026036		30°	
lumen	32000 lm		
LED-GIOVE-200C-60 8031414934584 FANEU00026035		60°	
lumen	32000 lm		
LED-GIOVE-200M-60 8031414934607 FANEU00026037		60°	
lumen	32000 lm		
watt		200W	
pf		0.90	

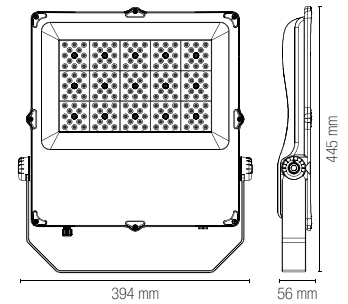

Photometrie des Produkts / Photometric curve

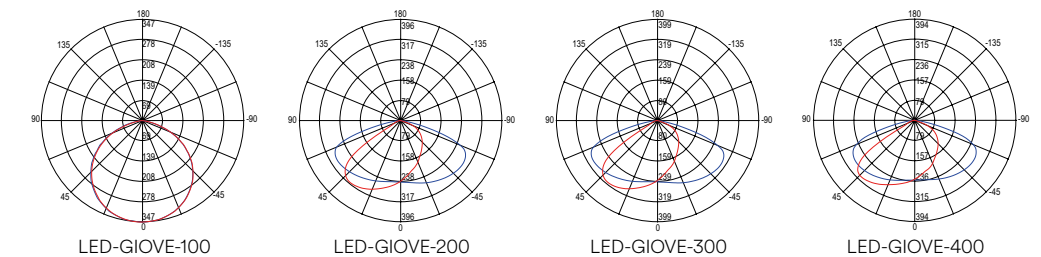

MASTER



Technische Informationen / Technical information **MASTER**



Material
Aluminium

Farbe
Schwarz



Farbtemperatur
5700K



Driver
inklusive

Lebensdauer und on/off
50.000 h
>25.000 on/off

Material
aluminium

Colour
black



Colour temperature
5700K



Driver
included



Life time and on/off
50.000 h
>25.000 on/off

Flutlichtleuchte mit integrierter LED und Struktur aus Aluminiumdruckguss sowie Diffusor mit Linsen aus selbstlöschendem, stoßfestem und UV-beständigem Material. Mit IK-Index auf höchstem Niveau garantiert sie einen hohen Schutz vor Flüssigkeiten und Staub.

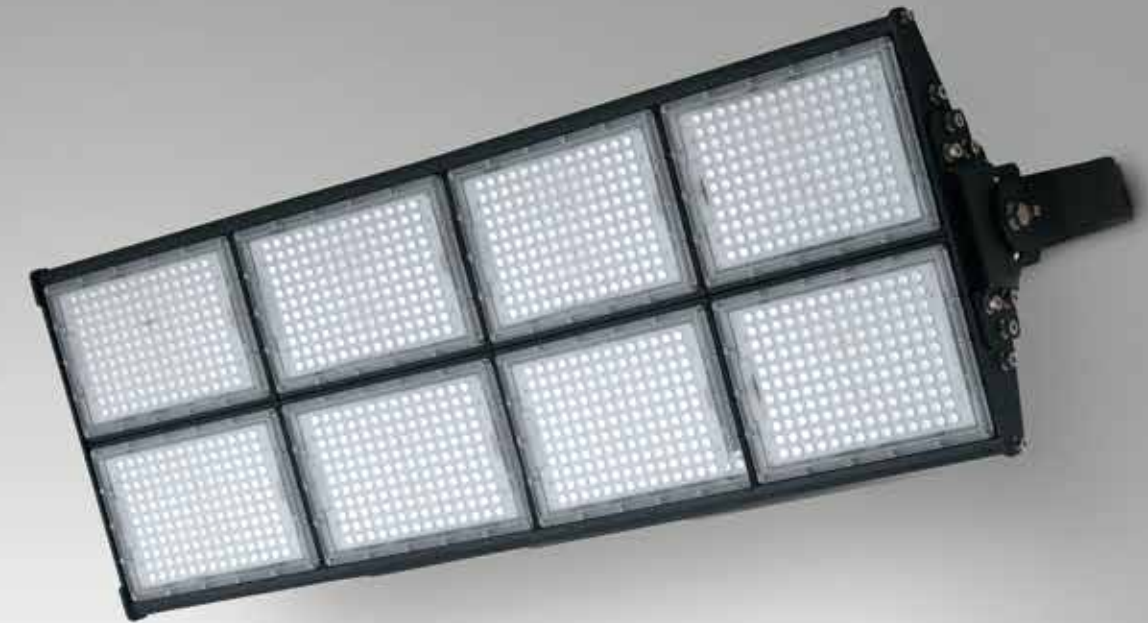
Floodlight with integrated LED with die-cast aluminium fixture and diffuser and lenses made of self-extinguishing, impact-resistant and UV-resistant material. With the highest IK rating, it ensures high protection against liquids and dust.

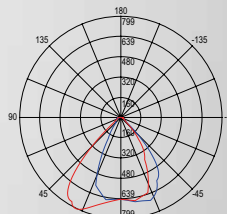

In.tec light FLUTLICHTLEUCHTEN / FLOOD LIGHTS

LED-MASTER-960 8031414862122 FANEU00006755 lumen	colour temp.	colour	
			
	129600 lm		LED-MASTER-960
watt	960W		
beam angle	60° x 100°		
pf	0.90		

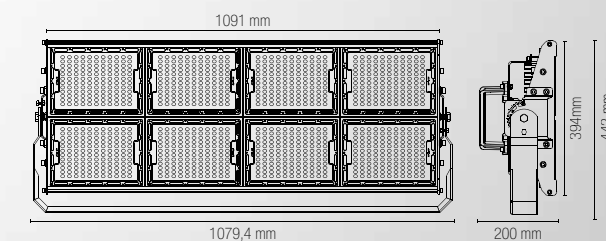

ENERGY

Eingebauter LED-Strahler für Überdachung, Struktur aus Aluminiumdruckguss und Diffusor mit Linsen aus selbstlöschendem, schlagfestem, UV-beständigem Material.
Gas station built-in LED light in die-cast aluminium body and lens in anti-UV, self-extinguishing, shockproof material.



ENERGY



Material Aluminium	Material aluminium
Farbe Weiß	Colour white
Farbtemperatur 4000K	Colour temperature 4000K
Driver inklusive	Driver included
Lebensdauer und on/off 50.000 h >25.000 on/off	Life time and on/off 50.000 h >25.000 on/off

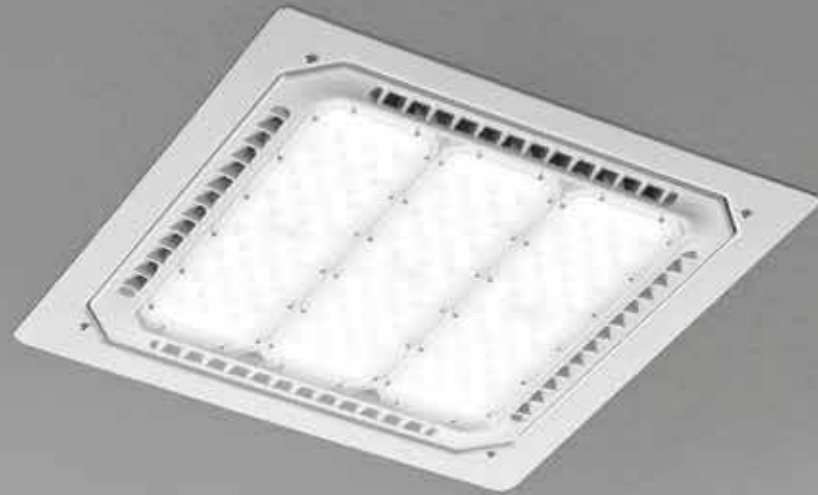

LED-ENERGY-80-INC 8031414862085 FANEU00006152 lumen	colour temp.	colour
	1100 lm	
watt	80W	
beam angle	80°	
pf	0.90	

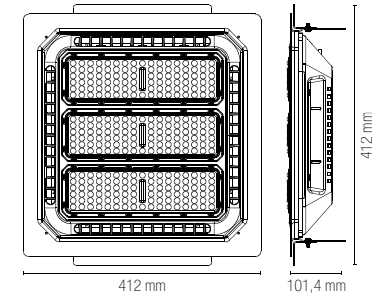

LED-ENERGY-80-PL 8031414862078 FANEU00006153 lumen	colour temp.	colour
	1100 lm	
watt	80W	
beam angle	80°	
pf	0.90	

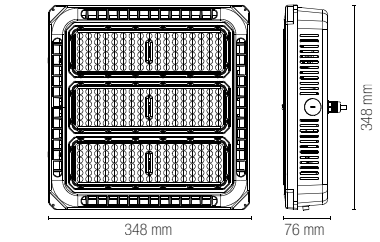

Photometrie des Produkts / Photometric curve

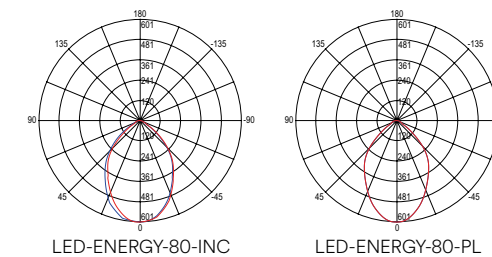



Strassenlampen / Street lights
outdoor

AUREUS

LED-Straßenleuchte aus Aluminium mit anthrazitfarbenem Finish und integriertem Solarpanel. Mit Fernbedienung, Dämmerungs- und Bewegungssensor mit Einstellung des Lichtstroms für höchste Energieeffizienz.

LED street light in aluminium with anthracite finish and integrated solar panel. With remote control, twilight sensor and motion sensor with luminous flux adjustment, for maximum energy efficiency.



Technische Informationen / Technical information **AUREUS**



Material
Aluminium

Farbe
Anthrazit

Farbtemperatur
3000K / 4000K

Driver
inklusive

Material
aluminium

Colour
anthracite

Colour temperature
3000K / 4000K

Driver
included



LED-AUREUS-20C-SOLAR

8031414921874
FANEU00005798

lumen 1600 lm

LED-AUREUS-20M-SOLAR

8031414921881
FANEU00005799

lumen 1600 lm

watt 20W
beam angle 80° x 80°

colour temp. colour

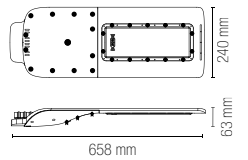
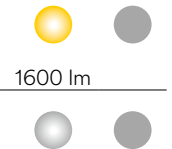

Enthaltenes Zubehör / Included accessories

Solarpanel / Solar panel

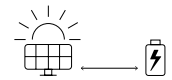

3.2V 20Ah LiFePO4
Aufladbare Batterie, nicht ersetzbar / Rechargeable battery not replaceable



Fernbedienung / Remote control

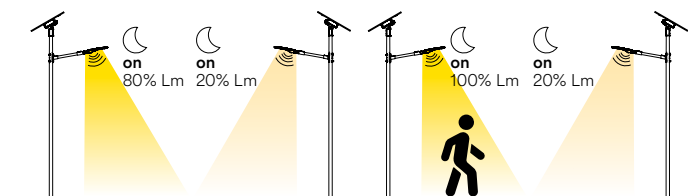

Schalter für zwei Funktionen / Switch for two functions

1. Dämmerungssensor ON 100 % Licht für 10 min
Nach 2 Stunden allmähliche Reduzierung bis auf 10 % Licht / Crepuscular sensor ON 100% light for 10 min
After 2 hours gradual reduction to 10% light

2. Bewegungssensor ON 100 % Licht
Nach 20 Sekunden 20 % Licht / Motion sensor ON 100% light
After 20 seconds 20% light

RADIUS

LED-Straßenleuchte aus silbernem Aluminium mit Solarpanel und Bewegungs- und Dämmerungssensor. Erhältlich in zwei Größen und mit zwei Leistungen, kann standortfernen Steuerung mit Fernbedienung ausgestattet werden.

LED street light in aluminium with silver finish, with solar panel, motion sensor and twilight sensor. Available in two sizes and luminous outputs, it can be fitted with radio remote control for remote operation.



Technische Informationen / Technical information **RADIUS**



Material
Aluminium

Farbe
Silber

Farbtemperatur
3000K / 4000K



Driver
inklusive

Material
aluminium

Colour
silver

Colour temperature
3000K / 4000K



Driver
included



LED-RADIUS-15C-SOLAR

8031414917006
FANEU00007180
lumen

colour temp.	colour
2100 lm	

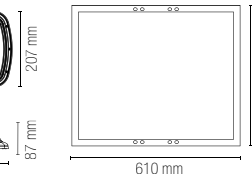

LED-RADIUS-15M-SOLAR

8031414917013
FANEU00007181
lumen

colour temp.	colour
2100 lm	

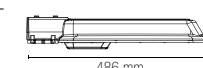

watt	15W
beam angle	80° x 140°
pf	0.90

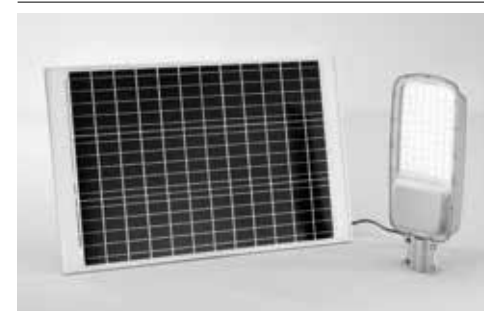

LED-RADIUS-30C-SOLAR

8031414917020
FANEU00007182
lumen

colour temp.	colour
4200 lm	

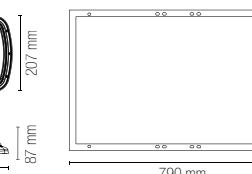

LED-RADIUS-30M-SOLAR

8031414917037
FANEU00007183
lumen

colour temp.	colour
4200 lm	

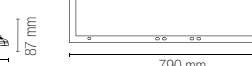

watt	30W
beam angle	80° x 140°
pf	0.90

Pfahleintritt 60 mm /
60 mm pole entry

Nicht enthaltene Zubehör / Accessories not included



LED-RADIUS-ST
8031414917044
FANEU00007185

Halterung für Montage auf Pfahl /
Pole mounting bracket

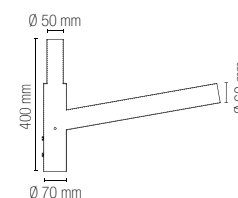

LED-RADIUS-ST-W
8031414917051
FANEU00007186

Halterung für Montage
auf Pfahl und an Mauer /
Pole or wall mounting bracket

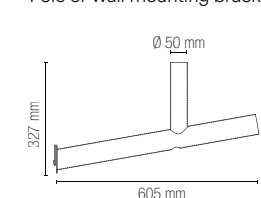

Enthaltenes Zubehör / Included accessories

Solarpanel /
Solar panel



15W - 12,8V 12000 mAh
30W - 12,8V 18000 mAh
Aufladbare Batterie,
nicht ersetzbar /
Rechargeable battery
not replaceable



LED-RADIUS-REMOTE
8031414917068
FANEU00007184

Fernbedienung / Remote control

Wichtig: Für den Betrieb des
LED-RADIUS-SOLAR ist die
Fernbedienung erforderlich
(separat erhältlich) /
Important: The remote
control is required to operate
the **LED-RADIUS-SOLAR**
(sold separately)

Photometrie des Produkts / Photometric curve

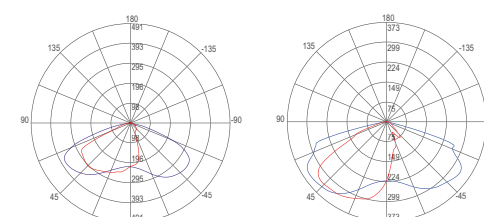

LED-RADIUS-15-SOLAR

LED-RADIUS-30-SOLAR

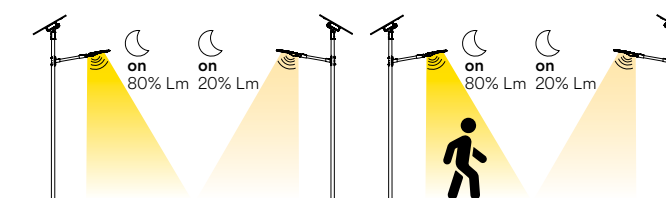

Dämmerungssensor ON 80 % Licht
Nach 20 Sekunden 20 % Licht /
Crepuscular sensor ON 80% light
After 20 seconds 20% light

Bewegungssensor ON 80 % Licht
Nach 20 Sekunden 20 % Licht /
Motion sensor ON 80% light
After 20 seconds 20% light



Material
Aluminium

Material Solarpanel
Zellen aus
einkristallinem Silizium

Farbe
Silber

Farbtemperatur
4000K

Material
aluminum

Solar panel material
monocrystalline
silicon

Colour
silver

Colour temperature
4000K



LED-Straßenleuchte aus silbernem Aluminium mit Solarpanel und Linsen aus selbstlöschendem, stoßfestem und UV-beständigem Material. Für größte Funktionalität und Energieeinsparung mit Lichtstrom mit variierbarer Stärke.
LED street light in aluminium with silver finish, solar panel and lenses in self-extinguishing, impact-resistant and UV-resistant material. With variable luminous flux for maximum functionality and energy saving.

Linsen aus selbstlöschendem, schlagfestem Anti-UV-Material / Lens in anti-UV, self-extinguishing, shockproof material

LED-FEBO-SOLAR
8031414879052
FANEU00006224
lumen

colour temp. | colour
6800 lm

watt | 40W
beam angle | 140° x 85°

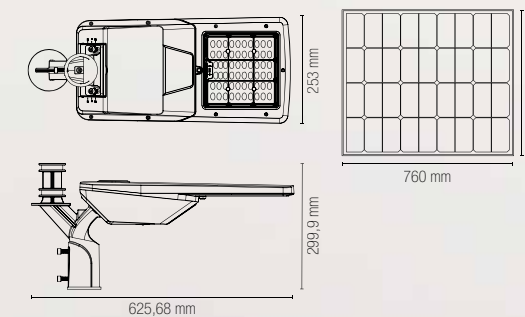

Enthaltenes Zubehör / Accessories included

Solarpanel / Solar panel



Lithium 12,8V 30AH
Aufladbare Batterie, nicht ersetzbar / Rechargeable battery not replaceable



Pfahleintritt 60 mm / 60 mm pole entry

Photometrie des Produkts / Photometric curve

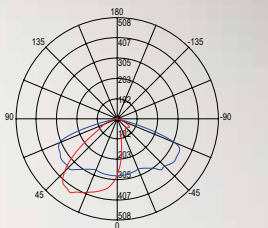

LED-FEBO-SOLAR

flux	on <20lux				on				off +12h				Werkseitige Settings	Einstellungen / Default	flux
	T1	T2	T3	T4	T1	T2	T3	T4	T1	T2	T3	T4			
100%	[Light bar]				[Light bar]				[Light bar]				T1	<20lux ÷ +2h	100%
60%	[Light bar]				[Light bar]				[Light bar]				T2	T1 ÷ +2h	60%
50%	[Light bar]				[Light bar]				[Light bar]				T3	T2 ÷ +7h	10%
10%	[Light bar]				[Light bar]				[Light bar]				T4	T3 ÷ +2h	50%
														+12h off	

IPERION

Mit Solarenergie betriebene LED-Straßenleuchte aus Aluminium mit silbernem Finish. Bietet einen Mikrowellen-Bewegungs- und Dämmerungssensor und ist mit Linsen aus stoßfestem, selbstlöschendem und UV-beständigem Material ausgestattet.

LED street light with solar panel in aluminium with silver finish. It features a microwave motion sensor and twilight sensor, and lenses in impact-resistant, self-extinguishing and UV-resistant material.



Material
Aluminium

Materiale pannello solare

Zellen aus einkristallinem Silizium

Farbe
Silber

Farbtemperatur
4000K

Material
aluminium

Solar panel material

monocrystalline silicon

Colour
silver

Colour temperature
4000K

	colour temp.
LED-IPERION-50-SOLAR 8031414879069 FANEU00006495	9000 lm
LED-IPERION-75-SOLAR 8031414879076 FANEU00006496	13500 lm
watt	50W
beam angle	156° x 71°

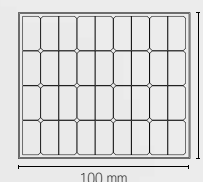
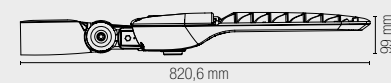
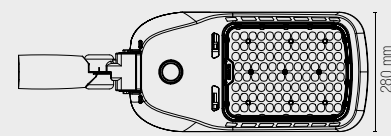

LED-IPERION-50-SOLAR

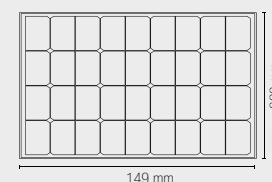

LED-IPERION-75-SOLAR



Technische Informationen / Technical information **IPERION**



Linsen aus selbstlöschendem, schlagfestem Anti-UV-Material / Lens in anti-UV, self-extinguishing, shockproof material

Mikrowellensensor max. Höhe 6 m, Radius 7 m / **Microwave sensor** max height 6m radius 7m

Nicht enthaltene Zubehör
Accessory not included

LED-IPERION-REMOTE
8031414879083
FANEU00006497

Multifunktionsfernbedienung / Remote control multi-mode control

* nur mit Multifunktionsfernbedienung LED-IPERION-REMOTE einstellbar / * adjustable only with LED-IPERION-REMOTE remote control



Enthaltenes Zubehör / Included accessories

Pfahl 60 cm / Pole 60 cm



Solarpanel / Solar panel

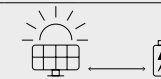

50W - lithium 12,8V 54000 mAh
75W - lithium 25,6V 36000 mAh
Aufladbare Batterie, nicht ersetzbar / Rechargeable battery not replaceable



Pfahleintritt 60 mm / 60 mm pole entry

Photometrie des Produkts / Photometric curve

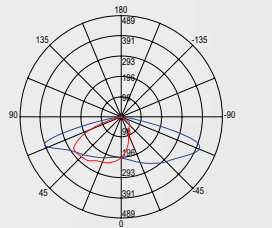

LED-IPERION-50-SOLAR

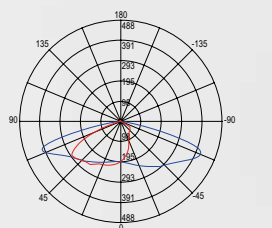

LED-IPERION-75-SOLAR

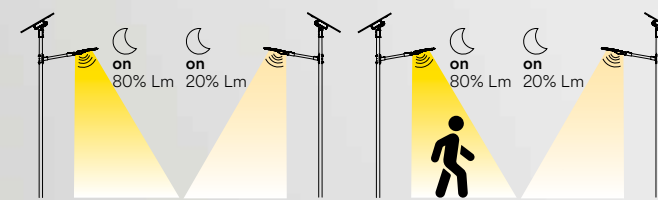

Dämmerungssensor ON 80 % Licht Nach 20 Sekunden 20 % Licht / Crepuscular sensor ON 80% light After 20 seconds 20% light

Bewegungssensor ON 80 % Licht Nach 20 Sekunden 20 % Licht / Motion sensor ON 80% light After 20 seconds 20% light

ROADWAY

Graue LED-Straßenleuchte aus Metall mit langer Lebensdauer und 5 Jahren Garantie. In mehreren Größen erhältlich, bietet ein doppeltes Montagesystem und dank der Beständigkeit gegen Stöße, Staub und Wasserstrahlen hervorragende Leistungen. LED street light in metal with grey finish, with extended life cycle and 5-year warranty. Available in various sizes, it features a dual mounting system and excellent performance in terms of protection against impacts, dust and water jets.



Technische Informationen / Technical information

ROADWAY



- Material**
Aluminium
- Farbe**
Silber
- Farbtemperatur**
3000K / 4000K
- Driver**
inklusive
- Lebensdauer**
50.000 h
- Material**
aluminum
- Colour**
silver
- Colour temperature**
3000K / 4000K
- Driver**
included
- Life time**
50.000 h



	colour temp.	colour
LED-ROADWAY-50C 8031414936076 FANEU00026472	☀	🌑
lumen	8250 lm	
LED-ROADWAY-50M 8031414936083 FANEU00026476	🌑	🌑
lumen	8500 lm	
watt	50W	
beam angle	75° x 150°	
pf	0.90	

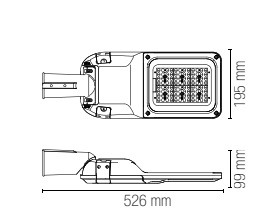

	colour temp.	colour
LED-ROADWAY-100C 8031414936090 FANEU00026477	☀	🌑
lumen	16500 lm	
LED-ROADWAY-100M 8031414936106 FANEU00026478	🌑	🌑
lumen	17000 lm	
watt	100W	
beam angle	75° x 150°	
pf	0.90	

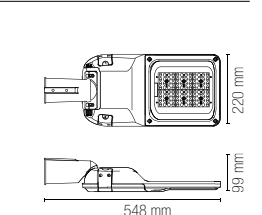

	colour temp.	colour
LED-ROADWAY-150C 8031414936113 FANEU00026479	☀	🌑
lumen	24750 lm	
LED-ROADWAY-150M 8031414936120 FANEU00026480	🌑	🌑
lumen	25500 lm	
watt	150W	
beam angle	75° x 150°	
pf	0.90	

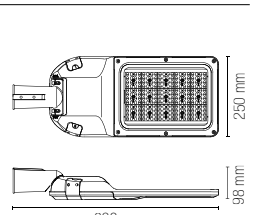

	colour temp.	colour
LED-ROADWAY-200C 8031414936137 FANEU00026481	☀	🌑
lumen	33000 lm	
LED-ROADWAY-200M 8031414936144 FANEU00026482	🌑	🌑
lumen	34000 lm	
watt	200W	
beam angle	75° x 150°	
pf	0.90	

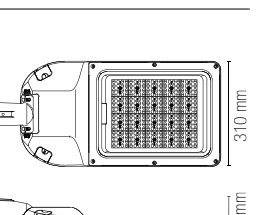

Photometrie des Produkts / Photometric curve

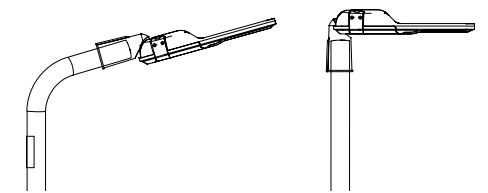
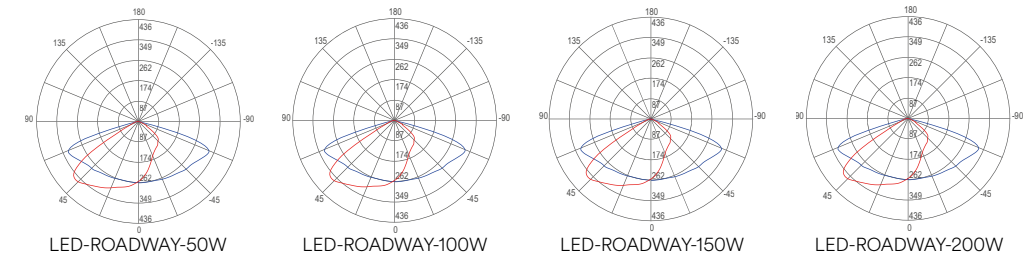

Doppeltes Montagesystem. Für Pfahl Ø 60 mm / Double mounting system. Fit for Ø 60 mm pole

STREETWAY

Straßenleuchte mit integrierter LED in verschiedenen Formaten mit Struktur aus Aluminiumdruckguss und Diffusor mit Linsen aus selbstlöschendem, stoßfestem und UV-beständigem Material. Garantiert eine lange Lebensdauer und Schutz vor Stößen, Staub und Wasserstrahlen.

Street light with integrated LED, available in various sizes, with die-cast aluminium fixture and diffuser with lenses in self-extinguishing, impact-resistant and UV-resistant material. It ensures an extended life cycle and protection against impacts, dust and water jets.



Technische Informationen / Technical information **STREETWAY**



Material
Aluminium

Farbe
Silber

Farbtemperatur
4000K

Driver
inklusive

Lebensdauer und on/off
50.000 h
>25.000 on/off

Material
aluminium

Colour
silver

Colour temperature
4000K

Driver
included

Life time and on/off
50.000 h
>25.000 on/off



LED-STREETWAY-50

8031414876334
FANEU00007489

lumen

colour temp.	colour
7800 lm	

watt	50W
beam angle	80° x 140°
pf	0.90

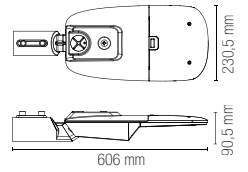

LED-STREETWAY-100

8031414876341
FANEU00007485

lumen

colour temp.	colour
15500 lm	

LED-STREETWAY-100FC
8031414879113
FANEU00007486

lumen

crepuscular sensor

colour temp.	colour
15500 lm	

on 6 lux	off 50 lux
----------	------------

watt	100W
beam angle	80° x 140°
pf	0.90

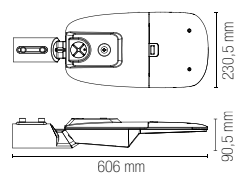

LED-STREETWAY-150

8031414876358
FANEU00007487

lumen

colour temp.	colour
22000 lm	

watt	150W
beam angle	80° x 140°
pf	0.90

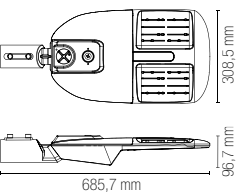

LED-STREETWAY-200

8031414879106
FANEU00007488

lumen

colour temp.	colour
29900 lm	

watt	200W
beam angle	80° x 140°
pf	0.90

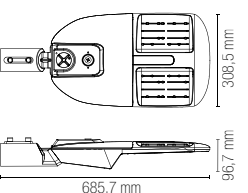

Photometrie des Produkts / Photometric curve

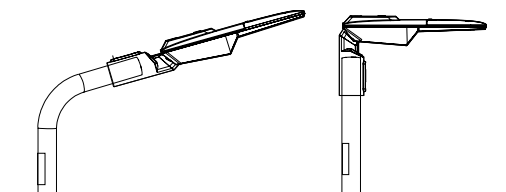
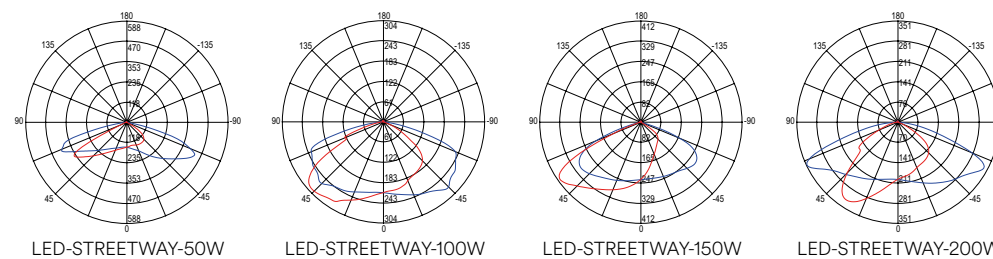

Doppeltes Montagesystem. Für Pfahl Ø 60 mm / Double mounting system. Fit for Ø 60 mm pole

HIGHWAY

Straßenleuchte mit integrierter LED und Diffusor mit Linsen aus selbstlöschendem, stoßfestem und UV-beständigem Material sowie Metallstruktur mit anthrazitfarbenem Finish. In verschiedenen Größen und mit unterschiedlicher Lichtleistung angeboten.
 Street light with integrated LED, diffuser with lenses in self-extinguishing, impact-resistant and UV-resistant material, and metal fixture with anthracite finish. Available in various sizes and luminous outputs.



Technische Informationen / Technical information **HIGHWAY**



Material
Aluminium

Farbe
Anthrazit

Farbtemperatur
4000K

Driver
inklusive

Lebensdauer und on/off
30.000 h
>15.000 on/off

Material
aluminium

Colour
anthracite

Colour temperature
4000K

Driver
included

Life time and on/off
30.000 h
>15.000 on/off



	colour temp.	colour
LED-HIGHWAY-50 8031414877034 FANEU00006405	7500 lm	
watt	50W	
beam angle	135° x 80°	
pf	0.90	

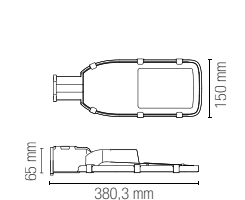

Pfahleintritt 60 mm /
60 mm pole entry



	colour temp.	colour
LED-HIGHWAY-100 8031414877041 FANEU00006397	14000 lm	
watt	100W	
beam angle	135° x 80°	
pf	0.90	

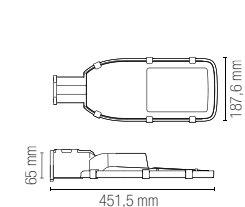

Pfahleintritt 60 mm /
60 mm pole entry



	colour temp.	colour
LED-HIGHWAY-150 8031414877058 FANEU00006401	20000 lm	
watt	150W	
beam angle	135° x 80°	
pf	0.90	

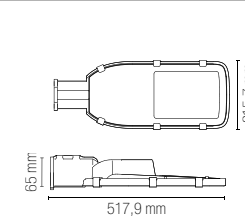

Pfahleintritt 60 mm /
60 mm pole entry



LED-HIGHWAY-ADAT 8031414877904 FANEU00006408	
90°-Adapter Highway-Straßenleuchtenanbringung Pfahleintritt 60 mm / 90° adapter 60 mm pole entry for street light	

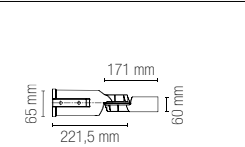

Pfahleintritt 60 mm /
60 mm pole entry

Photometrie des Produkts / Photometric curve

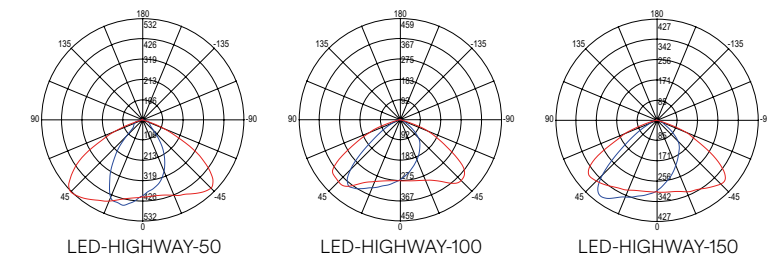

In.tec light STRASSENLAMPEN / STREET LIGHTS



LED-Flutlichtstrahler aus Aluminiumdruckguss mit anthrazitfarbener Farbe. Durch das moderne Design garantiert er eine lange Lebensdauer, Schutz vor Stößen und eignet sich auch für die Reinigung mit Hochdrucksystemen.
 LED street light in die-cast aluminium with anthracite finish. With its modern design, it ensures long-lasting durability, impact protection, and is suitable for cleaning even with high-pressure systems.

Material
Aluminiumdruckguss

Farbe
Anthrazit

Farbtemperatur
3000K / 4000K

Driver
inklusive

Lebensdauer und on/off
50.000 h
>25.000 on/off

Material
die-cust aluminum

Colour
anthracite

Colour temperature
3000K / 4000K

Driver
included

Life time and on/off
50.000 h
>25.000 on/off



	colour temp.	colour
LED-EXPO-60C 8031414936038 FANEU00026463 lumen	8700 lm	
LED-EXPO-60M 8031414936045 FANEU00026468 lumen	9000 lm	
watt	60W	
beam angle	60°	
pf	0.90	

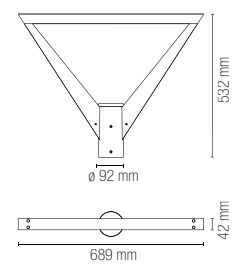

Pfahleintritt 76 mm
76 mm pole entry



LED-EXPO-VILLA-ADAT
8031414947843
FANEU00028380

Stangenadapter 60-76 cm kompatibel mit LED-EXPO-60 und LED-VILLA-100 / Pole adapter 60-76 cm compatible with LED-EXPO-60 and LED-VILLA-100

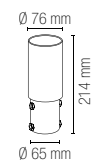

Pfahleintritt 60 mm / 60 mm pole entry

Photometrie des Produkts / Photometric curve

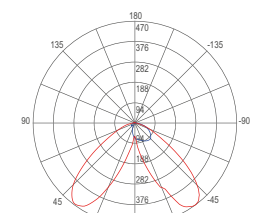

LED-EXPO-60



Material
Aluminiumdruckguss

Farbe
Anthrazit

Farbtemperatur
3000K / 4000K



Driver
inklusive

Lebensdauer und on/off
50.000 h
>25.000 on/off

Material
die-cust aluminum

Colour
anthracite



Colour temperature
3000K / 4000K



Driver
included

Life time and on/off
50.000 h
>25.000 on/off

Integrierter LED-Scheinwerfer aus Aluminiumdruckguss mit Anthrazit-Finish. Zertifiziert für die Beständigkeit gegen starke Wasserstrahlen und den optimalen Schutz gegen Stöße, bietet er außerdem eine hervorragende Farbwiedergabe.
Street light with integrated LED in die-cast aluminium with anthracite finish. Certified for resistance to powerful water jets and optimum impact-resistance, it also provides excellent colour rendering.



	colour temp.	colour
LED-VILLA-100C 8031414936052 FANEU00026469 lumen	14500 lm	
LED-VILLA-100M 8031414936069 FANEU00026470 lumen	15000 lm	
watt	100W	
beam angle	90°	
pf	0.90	

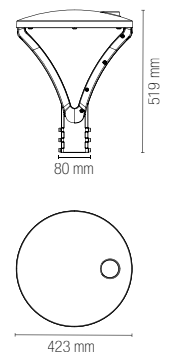

Pfahleintritt 76 mm / 76 mm pole entry



LED-EXPO-VILLA-ADAT
8031414947843
FANEU00028380

Stangenadapter 60-76 cm kompatibel mit LED-EXPO-60 und LED-VILLA-100 / Pole adapter 60-76 cm compatible with LED-EXPO-60 and LED-VILLA-100

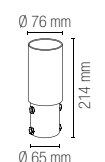

Pfahleintritt 60 mm / 60 mm pole entry

Photometrie des Produkts / Photometric curve

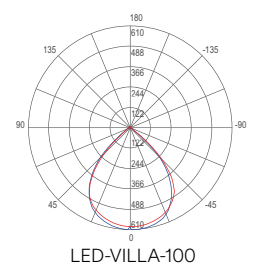

LED-VILLA-100



Easy Domotic 24V
decorative

EASY DOMOTICA 24V



Mit diesem technischen Segment möchten wir dem wachsenden Bedarf daran gerecht werden, die Qualität von Privat- und Arbeitsleben durch den Einsatz von Beleuchtungsgeräten zu verbessern, die durch Wireless-Technologien zunehmend vereinfachte Anbindungen immer stärker miteinander verknüpft sind.

Die Beleuchtungsgeräte werden zu extrem individuell gestalteten und modularen Elementen, die sich, auch zu unterschiedlichen Tageszeiten, an die veränderten Anforderungen an Beleuchtung anpassen, die nicht mehr nur als solche an sich dient, sondern auf verschiedene Stimmungen, sowohl der gewerblichen als auch der häuslichen oder spielerischen Nutzung, abgestimmt ist. Dieser Abschnitt gruppiert die verschiedenen Typologien von mit 24 V betriebenen Produkten (z. B. Indoor und Outdoor), die dank der Verwendung von Easy-Connector-Zubehör zur gleichzeitigen Steuerung miteinander verbunden werden können. Die Steuerung der Geräte wird easy: Der Anschluss an parallel geschaltete Konstantspannungsnetzteile ist mit Funkfrequenz 2.4G, Infrarot, Wi-Fi oder Bluetooth betriebenen Steuergeräten kompatibel und die Steuergeräte ihrerseits sehen Wi-Fi- bzw. Bluetooth-Schnittstellen vor oder können mittels Wall Pads oder Funksteuerungen gesteuert werden.

With this technical segment, we intend meet in the best way the growing need to improve the quality of home and working life through the use of lighting devices that are increasingly interconnected with each other through connections that are increasingly simplified by wireless technologies.

The lighting devices become an extremely personalized and modular tool that merge, even at different times of the day, with the evolved lighting needs no longer as light source itself but light adapted to the different moods of both professional users, domestic users, playful users. This section groups 24V products (for example indoor or outdoor) that, thanks to easy connector accessories, can be connected each other for simultaneous control. Devices control becomes easy: constant voltage power supply in parallel connection system are compatible with 2.4G Radio Frequency, Infrared, Wifi or Bluetooth control units and the control units can be controlled by wifi, bluetooth devices or via a wall pad or remote control.

	CAVO-4CH-CONN-MF 8031414878772 FANEU00000585 100 cm, Anschlusskabel M+F-Verbinder / 100 cm, connection cable M+F connector
	CAVO-4CH-CONN-T 8031414878789 FANEU00000586 40 + 20 cm, Anschlusskabel mit T-Verbinder M+F+F / 40+20 cm, T connection cable M+F+F connector
	CAVO-4CH-CONN-M 8031414878796 FANEU00000584 50 cm, Anschlusskabel F-Verbinder + lose Kabel / 50 cm, connection cable F+cables

TARGET

Flutlichtstrahler aus Aluminium inklusive Pflock, eingebautes Easy-Connection-Kabel.

Aluminum flood light with spike included, built-in easy domotic cable.



Material
Aluminium

Farbe
Schwarz



Farbtemperatur
RGB + 4000K



Driver
DC 24 V
Konstantspannung
nicht enthalten

Lebensdauer und on/off
30.000h
>15.000 on/off

Material
aluminium

Colour
black



Colour temperature
RGB + 4000K



Driver
DC 24V
constant voltage
not included

Life time and on/off
30.000h
>15.000 on/off



Driver ab S. /from p. 414
Controller ab S. /from p. 430

	LED-TARGET-8-24V 8031414878604 FANEU00007515 lumen	colour temp. 190 lm		watt 8W beam angle 30°
	LED-TARGET-30-24V 8031414878550 FANEU00007512 lumen	colour temp. 468 lm		watt 30W beam angle 30°



Material
Aluminium,
Diffusor aus Glas

Farbe
Schwarz



Farbtemperatur
RGB + 4000K



Driver
DC 24V
Konstantspannung
nicht enthalten

Lebensdauer und on/off
20.000h
>10.000 on/off

Material
aluminum
glass diffuser

Colour
black



Colour temperature
RGB



Driver
DC 24V
constant voltage
not included

Life time and on/off
20.000h
>10.000 on/off

**Flutlichtleuchte mit eingebauter LED
us schwarzem Aluminium und
transparentem Diffusor.**

Built-in LED aluminium flood lamp black
finish with transparent diffuser.

Driver ab S. /from p. 414
Controller ab S. /from p. 430



LED-AGILITY-36-24V
8031414915828
FANEU00005726
lumen

colour
temp.

735 lm

watt 36W
beam angle 120°

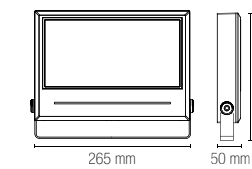

LED-AGILITY-72-24V
8031414915835
FANEU00005728
lumen

colour
temp.

1540 lm

watt 72W
beam angle 120°

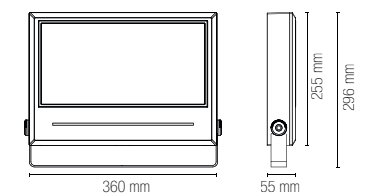

Photometrie des Produkts / Photometric curve

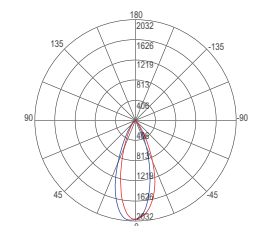

LED-AGILITY-36-24V

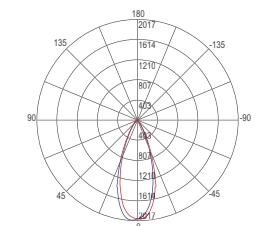

LED-AGILITY-72-24V



Material
Aluminium,
Diffusor aus Glas

Farbe
Schwarz



Farbtemperatur
RGB



Driver
DC 24V
Konstantspannung
nicht enthalten

Durata e on/off
20.000h
>10.000 on/off

Material
aluminum
glass diffuser

Colour
black



Colour temperature
RGB



Driver
DC 24V
constant voltage
not included

Life time and on/off
20.000h
>10.000 on/off

Integrierter LED-Projektor aus schwarzem Aluminium und transparentem Diffusor.
Integrated LED projector in black aluminum and transparent diffuser.

Driver ab S. /from p. 414
Controller ab S. /from p. 430



LED-QUICK-36-24V
8031414915842
FANEU00007172
lumen

colour temp.
735 lm

watt 36W
beam angle 120°

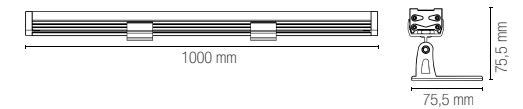

LED-QUICK-72-24V
8031414915859
FANEU00007174
lumen

colour temp.
1800 lm

watt 72W
beam angle 120°

Photometrie des Produkts / Photometric curve

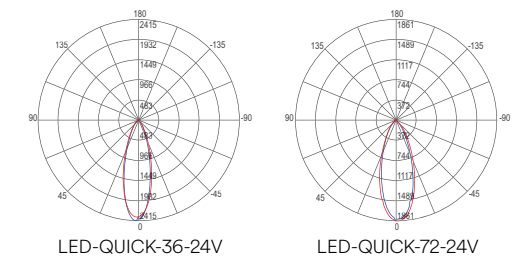

SPRINT

Einbau-Orientierungsleuchten an Boden oder Wand mit eingebautem Easy-Connection-Kabel.

Inground and wall recessed light with built-in easy domotic cable.



Material
Aluminium

Farbe
Stahl

Farbtemperatur
RGB + 4000K



Driver

DC 24V
Konstantspannung
nicht enthalten

Lebensdauer und on/off

25.000h
>10.000 on/off

Material

aluminium

Colour

stainless steel

Colour temperature

RGB + 4000K



Driver

DC 24V
constant voltage
not included

Life time and on/off

25.000h
>10.000 on/off



Driver ab S. /from p. 414
Controller ab S. /from p. 430



LED-SPRINT-R5-24V

8031414878543
FANEU00007441

lumen

colour
temp.



60 lm

watt 1,5W

beam angle 108°

pressure loads max 100 kg



Ø 42 mm



Photometrie des Produkts /
Photometric curve

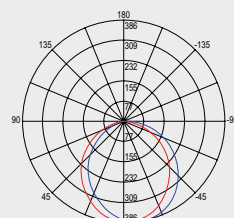

LED-SPRINT-R5-24V



RUNNER

Einbau-Orientierungsleuchten an Boden oder Wand mit eingebautem Easy-Connection-Kabel.

Inground and wall recessed light with built-in easy domotic cable.



Material
Aluminium

Farbe
Nickel, gebürstet

Farbtemperatur
RGB + 4000K



Driver

DC 24V
Konstantspannung
nicht enthalten

Lebensdauer und on/off

30.000h
>15.000 on/off

Material

aluminium

Colour

brushed nickel

Colour temperature

RGB + 4000K



Driver

DC 24V
constant voltage
not included

Life time and on/off

30.000h
>15.000 on/off



Driver ab S. /from p. 414
Controller ab S. /from p. 430



LED-RUNNER-Q8-24V

8031414878536
FANEU00007315

lumen

colour
temp.



1020 lm

watt 10W

beam angle 30°

pressure loads max 100 kg



Ø 63 mm

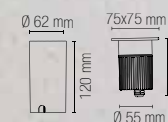

LED-RUNNER-R8-24V

8031414878567
FANEU00007316

lumen

colour
temp.



1020 lm

watt 10W

beam angle 30°

pressure loads max 100 kg



Ø 63 mm

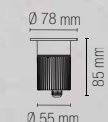

Photometrie des Produkts /
Photometric curve

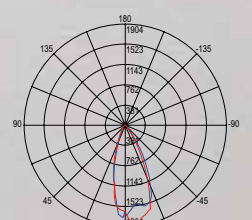

LED-RUNNER-Q8-24V
LED-RUNNER-R8-24V



Technische DMX-Dekorleuchten / DMX Technical Decoration Lighting
decorative

SHOW WALLWASHER

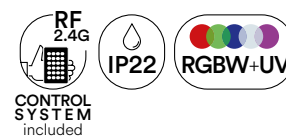

Technische Informationen / Technical information **SHOW WALLWASHER**



Material
Aluminium

Farbtemperatur
RGBW + UV



Driver
eingebaut

Lebensdauer und on/off
50.000h
>25.000 on/off

Material
aluminium

Colour temperature
RGBW + UV



Driver
built-in

Life time and on/off
50.000h
>25.000 on/off

Vollfarb-LED-Flutlichtleuchte RGB aus Aluminium und Wandfluter mit aufladbarem Batterie mit 9 LED RGBW+UV und eingebautem Empfänger DMX 512 für eine breite Farbpalette durch Mischen von sechs Hauptfarben: Rot, Grün, Blau, Weiß, Amber und Ultraviolett.

Full color RGB LED projector made of aluminum and rechargeable battery-powered wallwasher with 9 RGBW+UV LEDs and built-in DMX 512 receiver to emit a wide range of colors by mixing six main colors: red, green, blue, white, amber and ultraviolet.



	colour temp.	colour
LED-SHOW-WW9 8031414915446 FANEU00007412 lumen		
	RGBW+UV	
watt	9 x 18W	
beam angle	45°	

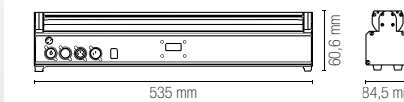

Ladezeit /
Charging time

Einschaltdauer /
Ignition duration

Auto-Modus /
Auto mode

Kanal-Modus /
Channel mode

Automatikmodi
mittels Taste /
Automatic modes
via push-button

Control mode

**Volle Aufladung in 5 Stunden /
Full recharge in 5 hours**

**RGBW+UV bei maximaler Helligkeit 3 Stunden /
RGBW+UV with maximum brightness 3 hours**

**7 Stunden, monochrom mehr als 20 Stunden /
7 hours monochrome more than 20 hours**

**6/11 DMX-Kanäle - 16,7 Millionen Farbkombinationen /
6/11 DMX channels - 16.7 million color combinations**

**Farbwechsel, Stroboskopfarbe, Farbverdunkelung,
gradueller Farbwechsel, stufenweiser Farbwechsel /
Color change, strobe color, color dimming,
gradual color change, step color change**

**DMX512, master/slave, auto, sound active /
Wireless DMX, WiFi mobile phone APP control**

Enthaltenes Zubehör / Accessories included



Wi-Fi-Zubehör /
Wi-Fi accessories



13200 mAh
Aufladbare Batterie, nicht ersetzbar /
Rechargeable battery, not replaceable

Control system



Smart Bluetooth

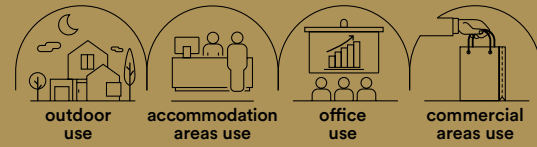

- Material**
Aluminium
- Farbtemperatur**
RGBW + UV
- Driver**
eingebaut
- Lebensdauer und on/off**
50.000h
>25.000 on/off
- Material**
aluminum
- Colour temperature**
RGBW + UV
- Driver**
built-in
- Life time and on/off**
50.000h
>25.000 on/off

LED-Flutlichtleuchte mit aufladbarer Batterie mit 9 LEDs RGBW+UV und eingebautem Empfänger DMX 512, eine breite Farbpalette durch Mischen von sechs Hauptfarben: Rot, Grün, Blau, Weiß, Amber und Ultraviolett, sodass jede gewünschte Farbe erzeugt werden kann.
Rechargeable battery-powered LED spotlight with 9 RGBW+UV LEDs and built-in DMX 512 receiver, emits a wide range of colors by mixing the six main ones: red, green, blue, white, amber and ultraviolet, allowing you to create any color you want.



LED-SHOW-PAR9 8031414915439 FANEU00007393 lumen	colour temp. RGBW+UV	colour
watt	9 x 18W	
beam angle	45°	

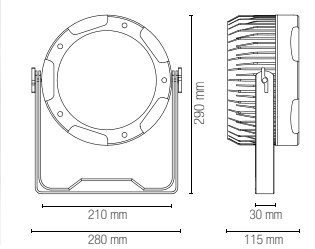

Ladezeit / Charging time	Volle Aufladung in 5 Stunden / Full recharge in 5 hours
Einschaltdauer / Ignition duration	RGBW+UV bei maximaler Helligkeit 3 Stunden / RGBW+UV with maximum brightness 3 hours
Auto-Modus / Auto mode	7 Stunden, monochrom mehr als 20 Stunden / 7 hours monochrome more than 20 hours
Kanal-Modus / Channel mode	6/11 DMX-Kanäle - 16,7 Millionen Farbkombinationen / 6/11 DMX channels - 16.7 million color combinations
Automatikmodi mittels Taste / Automatic modes via push-button	Farbwechsel, Stroboskopfarbe, Farbverdunkelung, gradueller Farbwechsel, stufenweiser Farbwechsel / Color change, strobe color, color dimming, gradual color change, step color change
Control mode	DMX512, master/slave, auto, sound active/ Wireless DMX, WiFi mobile phone APP control

Enthaltenes Zubehör / Accessories included

- Wi-Fi-Zubehör / Wi-Fi accessories
- 5 hours 13200 mAh**
Aufladbare Batterie, nicht ersetzbar / Rechargeable battery, not replaceable

Control system

Smart Bluetooth

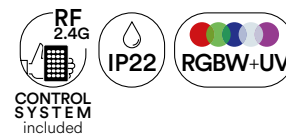
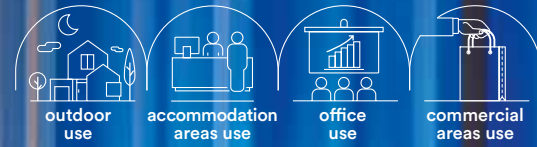

Material
Aluminium

Farbtemperatur
RGBW + UV



Driver
eingebaut

Lebensdauer und on/off
50.000h
>25.000 on/off

Material
aluminium

Colour temperature
RGBW + UV



Driver
built-in

Life time and on/off
50.000h
>25.000 on/off

LED-Flutlichtleuchte mit aufladbarem Batterie mit 6 LEDs RGBW+UV und eingebautem Empfänger DMX 512, eine breite Farbpalette durch Mischen der sechs Hauptfarben: Rot, Grün, Blau, Weiß, Amber und Ultraviolett, sodass jede gewünschte Farbe erzeugt werden kann.

Rechargeable battery-operated LED spotlight with 6 RGBW+UV LEDs and built-in DMX 512 receiver, emits a wide range of colors by mixing the six main ones: red, green, blue, white, amber and ultraviolet, allowing the creation of any desired color.



	colour temp.	colour
LED-SHOW-Q6 8031414915408 FANEU00007398 lumen		
	RGBW+UV	
watt	6 x 18W	
beam angle	45°	

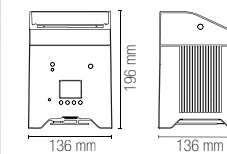

Ladezeit /
Charging time

Einschaltdauer /
Ignition duration

Auto-Modus /
Auto mode

Kanal-Modus /
Channel mode

Automatikmodi
mittels Taste /
Automatic modes
via push-button

Control mode

Volle Aufladung in 5 Stunden /
Full recharge in 5 hours

RGBW+UV bei maximaler Helligkeit 3 Stunden /
RGBW+UV with maximum brightness 3 hours

7 Stunden, monochrom mehr als 20 Stunden /
7 hours monochrome more than 20 hours

6/11 DMX-Kanäle - 16,7 Millionen Farbkombinationen /
6/11 DMX channels - 16.7 million color combinations

Farbwechsel, Stroboskopfarbe, Farbverdunkelung,
gradueller Farbwechsel, stufenweiser Farbwechsel /
Color change, strobe color, color dimming,
gradual color change, step color change

DMX512, master/slave, auto, sound active/
Wireless DMX, WiFi mobile phone APP control

Nicht enthaltene Zubehör / Accessory not included



LED-SHOW-CASE
8031414915415
FANEU00007392

Koffer mit Ladestation
für 10 Stück /
Case with charging
base for 10 pieces

Enthaltenes Zubehör / Accessories included



Wi-Fi-Zubehör /
Wi-Fi accessories



9600 mAh
Aufladbare Batterie, nicht ersetzbar /
Rechargeable battery, not replaceable

Control system



Smart Bluetooth

SHOW TUBE

LED-Flutlichtleuchte mit aufladbarer Batterie mit 9 LEDs RGBW+UV und eingebautem Empfänger DMX 512, eine breite Farbpalette durch Mischen der sechs Hauptfarben: Rot, Grün, Blau, Weiß, Amber und Ultraviolett, sodass jede gewünschte Farbe erzeugt werden kann, von warmen bis zu kalten Tönen.

Rechargeable battery-powered LED spotlight with 9 RGBW+UV LEDs and built-in DMX 512 receiver, emits a wide range of colors by mixing the six main ones: red, green, blue, white, amber and ultraviolet, allowing the creation of any desired color from warm to cool tones.



Technische Informationen / Technical information **SHOW TUBE**



- Material**
Aluminium
- Farbtemperatur**
RGBW + UV
- Driver**
eingebaut
- Lebensdauer und on/off**
50.000h
>25.000 on/off
- Material**
aluminium
- Colour temperature**
RGBW + UV
- Driver**
built-in
- Life time and on/off**
50.000h
>25.000 on/off



LED-SHOW-TUBE
8031414915422
FANEU00007405
lumen

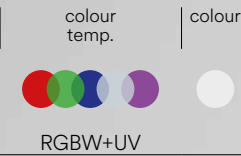

watt 8 x 28W
beam angle 360°

Ladezeit / Charging time

Volle Aufladung in 5 Stunden / Full recharge in 5 hours

Einschaltdauer / Ignition duration

RGBW+UV bei maximaler Helligkeit 3 Stunden / RGBW+UV with maximum brightness 3 hours

Auto-Modus / Auto mode

7 Stunden, monochrom mehr als 20 Stunden / 7 hours monochrome more than 20 hours

Kanal-Modus / Channel mode

6/11 DMX-Kanäle - 16,7 Millionen Farbkombinationen / 6/11 DMX channels - 16.7 million color combinations

Automatikmodi mittels Taste / Automatic modes via push-button

Farbwechsel, Stroboskopfarbe, Farbverdunkelung, gradueller Farbwechsel, stufenweiser Farbwechsel / Color change, strobe color, color dimming, gradual color change, step color change

Control mode

DMX512, master/slave, auto, sound active / Wireless DMX, WiFi mobile phone APP control



Enthaltenes Zubehör / Accessories included

Wi-Fi-Zubehör / Wi-Fi accessories

10000 mAh
Aufladbare Batterie, nicht ersetzbar / Rechargeable battery, not replaceable

Control system

Smart Bluetooth

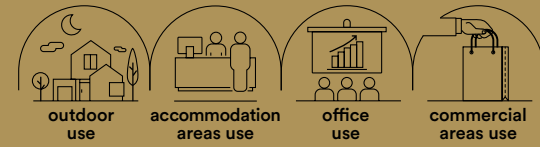

VOLLFARB-LED-FLUTLICHTLEUCHTE RGB aus Aluminium.
LED RGB FULL COLOR lamp in aluminium.



Material
Aluminium

Farbtemperatur
RGB full color



Driver
inklusive

Lebensdauer und on/off
50.000h
>25.000 on/off

Material
aluminium

Colour temperature
RGB full color



Driver
included

Life time and on/off
50.000h
>25.000 on/off

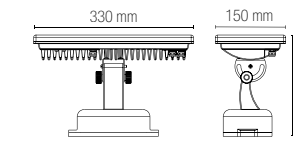

LED-RAYS-36P
8031440355445
FANEU00007264
lumen

colour temp. | colour
RGB

watt 30 x 1W
beam angle 36°

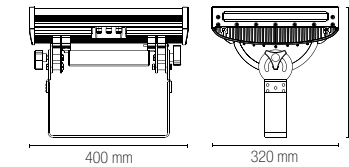
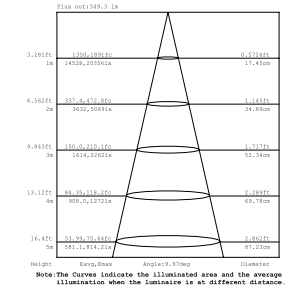
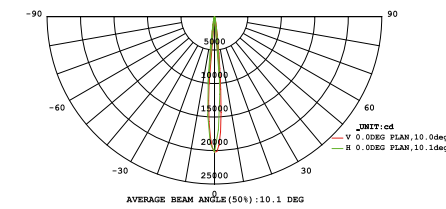

LED-RAYS-72P
8031440358040
FANEU00007265
lumen

colour temp. | colour
RGB

watt 72 x 2W
beam angle 45°

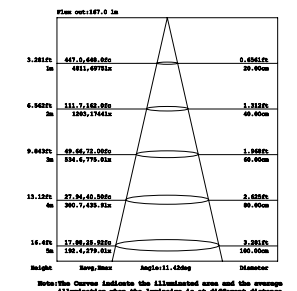
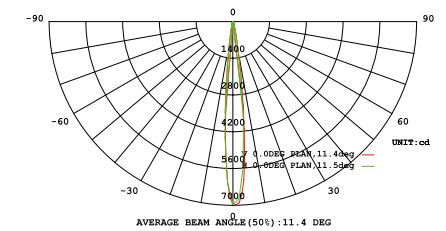

WALLWASHER

VOLLFARB-LED-FLUTLICHTLEUCHTE RGB aus Aluminium.
LED RGB FULL COLOR lamp in aluminium.



Technische Informationen / Technical information **WALLWASHER**



Material
Aluminium

Farbtemperatur
RGB full color



Driver
eingebaut

Lebensdauer und on/off
50.000h
>25.000 on/off

Material
aluminium

Colour temperature
RGB full color



Driver
built-in

Life time and on/off
50.000h
>25.000 on/off

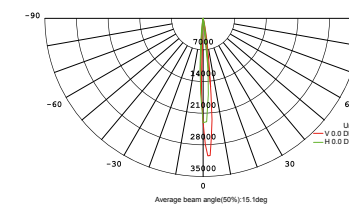

Flux out: 278.7 lm

Height	Eavg, Emax	Angle ±15.4 deg	Diameter
3.282ft 1m	1891,8823lx 18917,3338lx	0.44730°	13.43mm
6.564ft 2m	472,97058lx 4729,7071lx	0.89461°	27.87mm
9.846ft 3m	315,31377lx 3153,1378lx	1.34192°	41.80mm
13.128ft 4m	236,47783lx 2364,7781lx	1.78923°	55.74mm
16.410ft 5m	187,48113lx 1874,8113lx	2.23654°	69.67mm

Note: The curves indicate the illuminated area and the average illumination when the luminaire is at different distance.

	colour temp.	colour
LED-WALLWASHER-18 8031440359559 FANEU00007905	RGB	RGB
lumen	RGB	
watt	18 x 2W	
beam angle	45°	

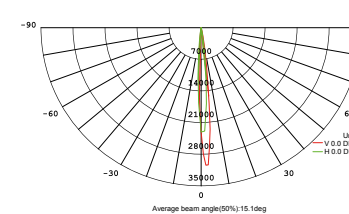
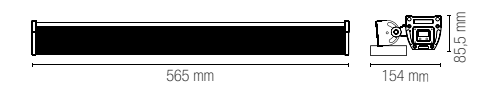

Flux out: 279.7 lm

Height	Eavg, Emax	Angle ±15.4 deg	Diameter
3.282ft 1m	1891,8823lx 18917,3338lx	0.44730°	13.43mm
6.564ft 2m	472,97058lx 4729,7071lx	0.89461°	27.87mm
9.846ft 3m	315,31377lx 3153,1378lx	1.34192°	41.80mm
13.128ft 4m	236,47783lx 2364,7781lx	1.78923°	55.74mm
16.410ft 5m	187,48113lx 1874,8113lx	2.23654°	69.67mm

Note: The curves indicate the illuminated area and the average illumination when the luminaire is at different distance.

	colour temp.	colour
LED-WALLWASHER-36 8031440359528 FANEU00007906	RGB	RGB
lumen	RGB	
watt	36 x 2W	
beam angle	45°	

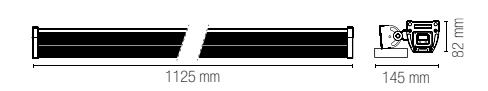

TECHNISCHE DMX-DEKORLEUCHTEN / DMX TECHNICAL DECORATION LIGHTING

In.tec light

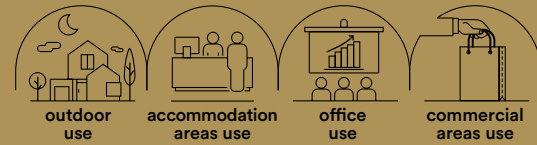

Einfarbige oder VOLLFARB-LED-FLUT- LICHTLEUCHTE RGB aus Aluminium.
LED single colour or RGB FULL COLOR lamp in aluminium.



Material
Aluminium

Farbtemperatur
RGB full color + 6000K



Driver
DC 12/24 V
nicht enthalten

Lebensdauer und on/off
50.000h
>25.000 on/off

Material
aluminium

Colour temperature
RGB full color + 6000K



Driver
DC 12/24V
not included

Life time and on/off
50.000h
>25.000 on/off

	colour temp.	colour		colour temp.	colour
LED-IRIDE-3P 8031440358101 FANEU00006500 lumen	RGB		LED-IRIDE-3P-BCO 8031440359719 FANEU00006501 lumen	240 lm	
watt	3 x 1W		watt	3 x 1W	
driver	DC12/24V		driver	DC12/24V	
beam angle	45°		beam angle	30°	

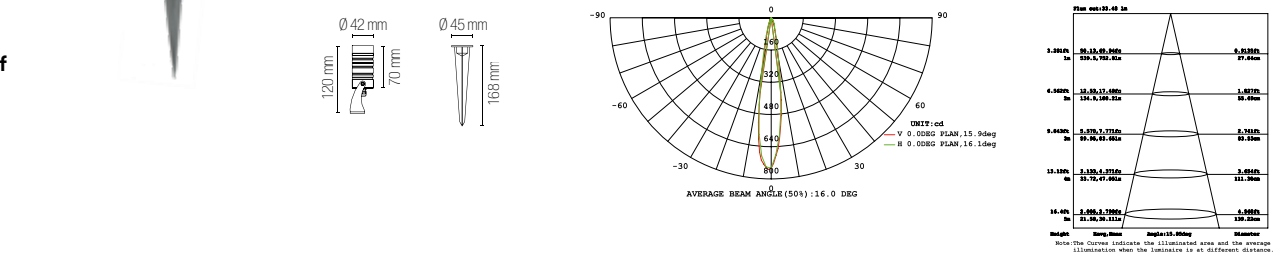

	colour temp.	colour		colour temp.	colour
LED-IRIDE-9P 8031440358118 FANEU00006502 lumen	RGB		LED-IRIDE-9P-BCO 8031440359702 FANEU00006503 lumen	720 lm	
watt	9 x 1W		watt	9 x 1W	
driver	DC12/24V		driver	DC12/24V	
beam angle	40°		beam angle	30°	

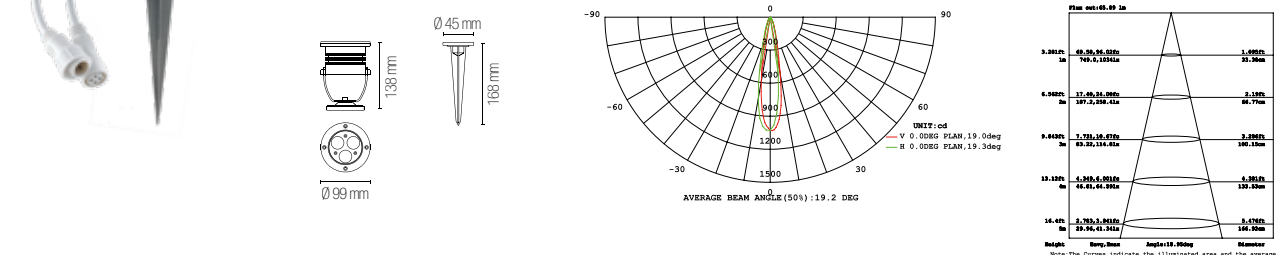

	colour temp.	colour		colour temp.	colour
LED-IRIDE-18P 8031440358088 FANEU00006498 lumen	RGB		LED-IRIDE-18P-BCO 8031440359689 FANEU00006499 lumen	1620 lm	
watt	18 x 1W		watt	18 x 1W	
driver	DC24V		driver	DC24V	
beam angle	40°		beam angle	30°	

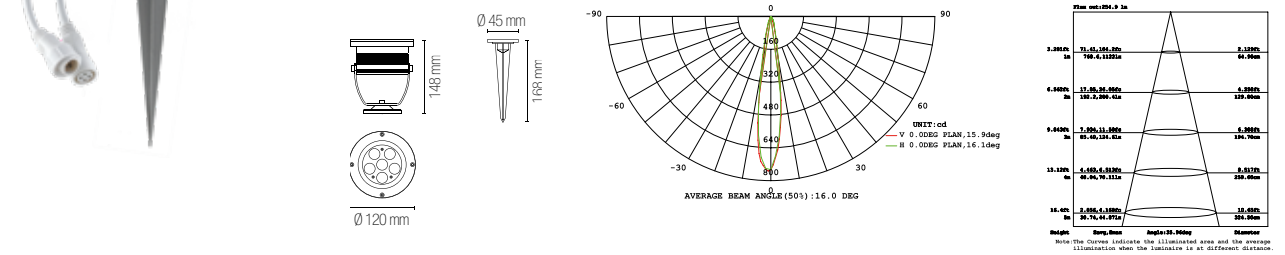

IRIDE

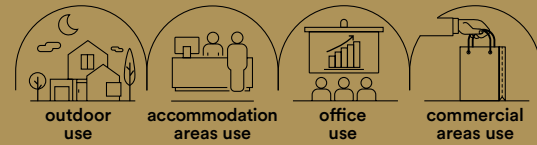

Technische Informationen / Technical information

IRIDE

Begehbare Vollfarb-LED-Einbauleuchten RGB, Gehäuse aus Aluminiumlegierung, Ring aus Stahl 316.
Walkable built-in LED RGB FULL COLOR light 316 stainless steel cover and aluminium alloy housing.



Material
Aluminiumdruckguss

Farbtemperatur
RGB full color



Driver
DC 12/24 V
nicht enthalten

Lebensdauer und on/off
50.000h
>25.000 on/off

Material
die cast aluminium

Colour temperature
RGB full color



Driver
DC 12/24V
not included

Life time and on/off
50.000h
>25.000 on/off



LED-IRIDE-R6
8031414868971
FANEU00006508
lumen

colour temp. | colour | recessed box



watt 3 × 1W
driver DC12/24V
beam angle 15°

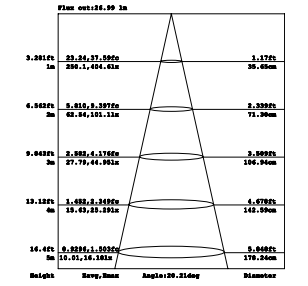
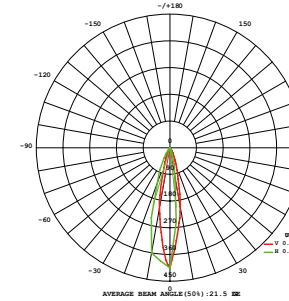
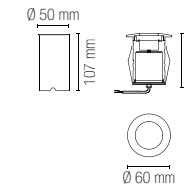
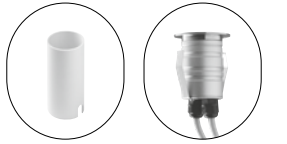

NEPTUNE

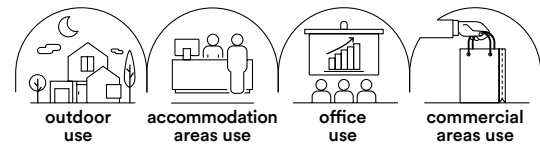

CROWN

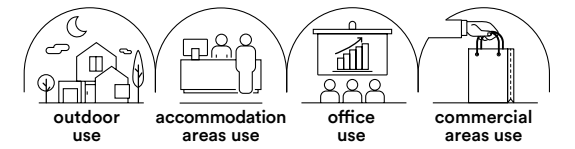

Material
Edelstahl 316

Farbe
Silber
Schwarz



Farbtemperatur
RGB full color



Driver
DC 24 V
nicht enthalten

Lebensdauer und on/off
50.000h
>25.000 on/off

Material
316 stainless steel

Colour
black
silver



Colour temperature
RGB full color



Driver
DC24V
not included

Life time and on/off
50.000h
>25.000 on/off

VOLLFARB-LED-FLUTLICHTLEUCHTE
RGB für Springbrunnen.
LED RGB FULL COLOR fountain flood lamp.



LED-NEPTUNE-3P
8031414869008
FANEU00006840
lumen

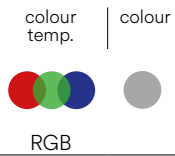

watt 3 x 3W
beam angle 25°

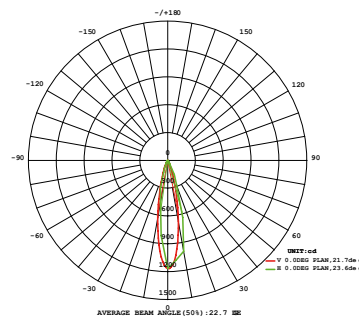
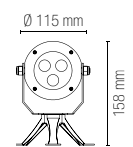

Plan view: 18.48 in	Height	Beam, Max	Angle: 21.48deg	Diameter
0.281ft	73.49, 108.80ft	1.877ft		
1a	790.9, 1198.1in	30.30in		
0.448ft	18.37, 27.88ft	3.814ft		
1a	197.7, 291.2in	76.54in		
0.615ft	8.166, 12.38ft	3.779ft		
1a	97.89, 137.4in	114.9in		
0.782ft	3.995, 5.98ft	3.893ft		
1a	40.49, 71.96in	130.39in		
0.949ft	2.009, 2.99ft	4.008ft		
1a	31.64, 49.99in	131.49in		

LED-NEPTUNE-36P
8031440358057
FANEU00006839
lumen

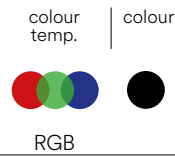

watt 36 x 1W
beam angle 45°

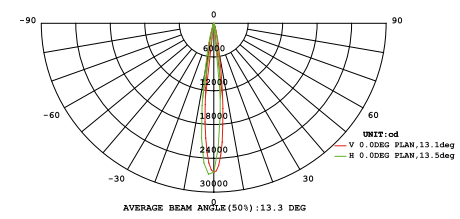
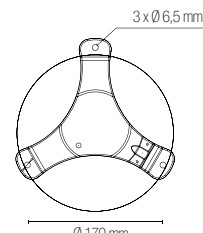
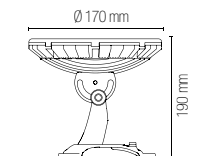

Plan view: 18.48 in	Height	Beam, Max	Angle: 13.30deg	Diameter
0.281ft	189.0, 283.5ft	1.192ft		
1a	1539.24, 2479.5in	27.28in		
0.448ft	50.4, 75.6ft	1.192ft		
1a	542.4, 828.6in	46.27in		
0.615ft	20.7, 31.0ft	1.192ft		
1a	202.2, 294.2in	37.49in		
0.782ft	10.0, 15.0ft	1.192ft		
1a	100.0, 150.0in	32.24in		
0.949ft	5.0, 7.5ft	1.192ft		
1a	50.0, 75.0in	25.19in		

Material
Edelstahl 316

Farbtemperatur
RGB full color



Driver
DC 24 V
nicht enthalten

Lebensdauer und on/off
50.000h
>25.000 on/off

Material
316 stainless steel

Colour temperature
RGB full color



Driver
DC24V
not included

Life time and on/off
50.000h
>25.000 on/off

VOLLFARB-LED-EINBAULEUCHTE
RGB für Springbrunnen.
LED RGB FULL COLOR fountain recess lamp.



LED-CROWN-R14
8031414869015
FANEU00006019
lumen

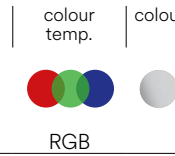

watt 9 x 2W
beam angle 25°

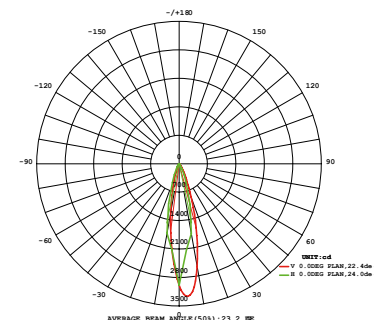
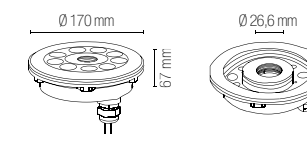

Plan view: 18.48 in	Height	Beam, Max	Angle: 23.20deg	Diameter
0.281ft	189.0, 283.5ft	1.192ft		
1a	1539.24, 2479.5in	27.28in		
0.448ft	50.4, 75.6ft	1.192ft		
1a	542.4, 828.6in	37.49in		
0.615ft	20.7, 31.0ft	1.192ft		
1a	202.2, 294.2in	37.49in		
0.782ft	10.0, 15.0ft	1.192ft		
1a	100.0, 150.0in	32.24in		
0.949ft	5.0, 7.5ft	1.192ft		
1a	50.0, 75.0in	25.19in		



TREVIS



Technische Informationen / Technical information

TREVIS



VOLLFARB-LED-LEUCHE RGB für Unterwassereinbau.
Immersion recessed light LED RGB FULL COLOR.

Material
Edelstahl 316

Farbtemperatur
RGB full color



Driver
DC 24 V
nicht enthalten

Lebensdauer und on/off
50.000h
>25.000 on/off

Material
316 stainless steel

Colour temperature
RGB full color



Driver
DC 24V
not included

Life time and on/off
50.000h
>25.000 on/off



LED-TREVIS-R7
8031414869022
FANEU00007612

lumen

watt

beam angle

colour temp. | colour | recessed box

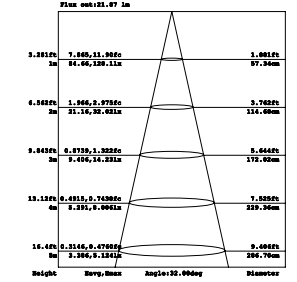
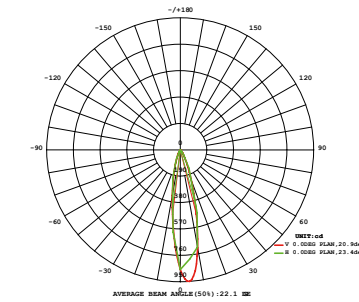
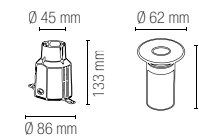
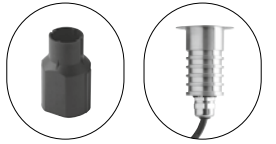

LED-TREVIS-R11
8031414869039
FANEU00007611

lumen

watt

beam angle

colour temp. | colour | recessed box

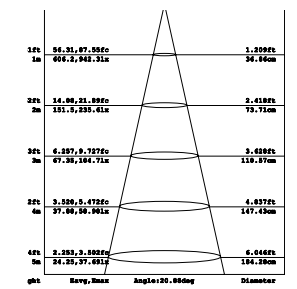
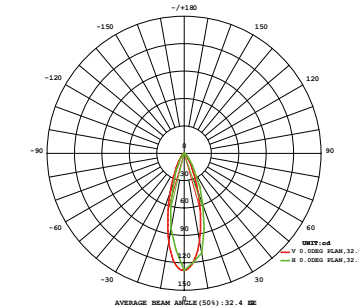
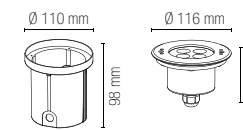

PAR56

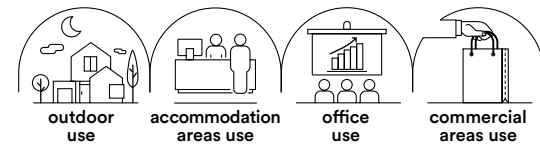

PELPS

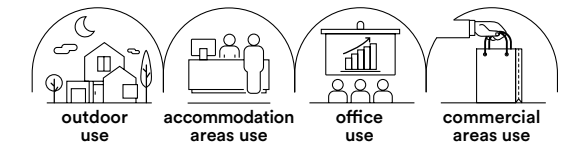

Material
Polycarbonat

Farbtemperatur
RGB full color + 6500K



Driver
AC 12 V nicht enthalten
DC 24 V nicht enthalten

Lebensdauer und on/off
50.000h
>25.000 on/off

Material
PC

Colour temperature
RGB full color + 6500K



Driver
AC 12V not included
DC 24V not included

Life time and on/off
50.000h
>25.000 on/off

LED-Unterwasserleuchte für Swimmingpools.
Pool immersion LED down light.



LED-PAR56-24V-RGB

8031414879755
FANEU00007022

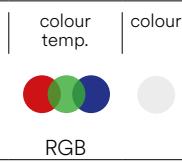

lumen
watt
driver
beam angle
1 m cable included

21W
DC24V
45°

LED-PAR56-BCO

8031440359504
FANEU00007023



lumen
watt
driver
beam angle

1050 lm
21W
12V AC
45°

INC-POOL-PAR56

8031440359511
FANEU00005024

Einbaustruktur für PAR 56 für Beton-Pools /
Recessed structure for PAR56 for concrete swimming pool

1 m cable included
Ø 260 mm

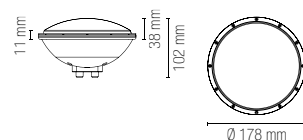
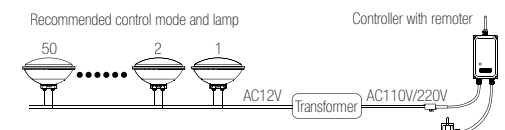

Material
Polycarbonat

Farbtemperatur
RGB full color + 6500K



Driver
AC 12 V nicht enthalten
DC 24 V nicht enthalten

Lebensdauer und on/off
50.000h
>25.000 on/off

Material
PC

Colour temperature
RGB full color + 6500K



Driver
AC 12V not included
DC 24V not included

Life time and on/off
50.000h
>25.000 on/off

LED-Leuchte für Swimmingpool mit Wandbefestigung.
Pool LED wall lamp.



LED-PELPS24V-RGB

8031414868872
FANEU00007095

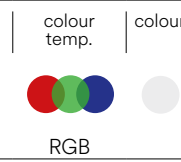

lumen
watt
driver
beam angle
1 m cable included

18W
DC24V
45°

LED-PELPS-BCO

8031414865420
FANEU00007093



lumen
watt
driver
beam angle

1122 lm
18W
AC12V
45°

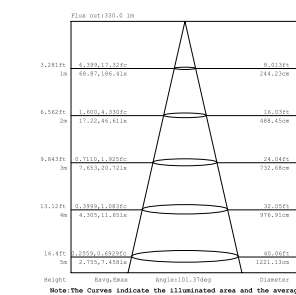
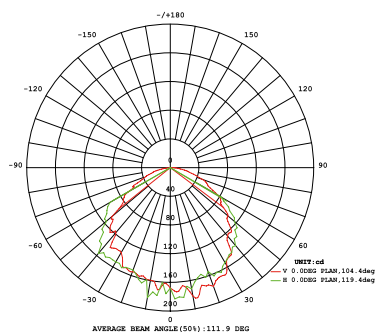
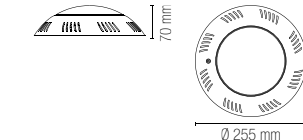

CONTROLLER



CONTROLLER-POOL
8031440359481
FANEU00000620

Controller 240 V
AC MAX 5 A/1100 W
IP65 Abstand max. 30 M

Controller 240V
AC max 5A/1100W
IP65 max distance 30M

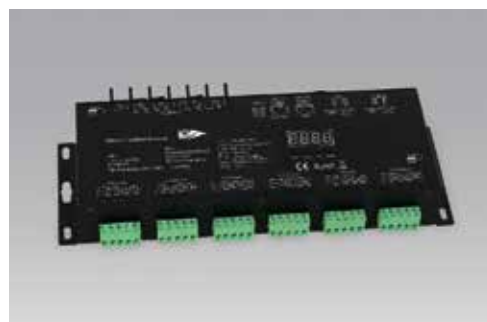
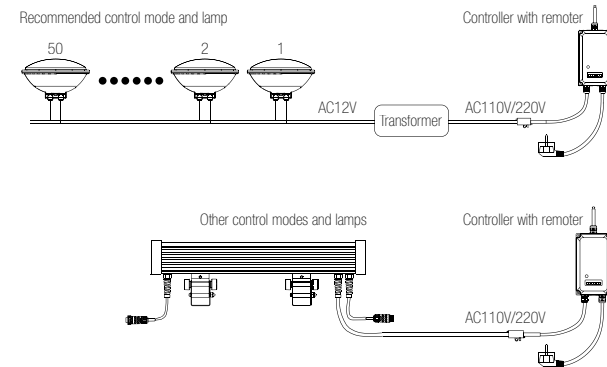
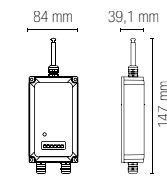
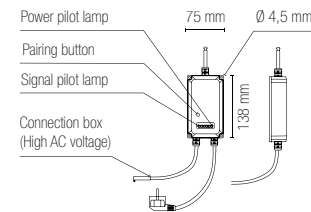

CONTROLLER-DMX-24
8031414872718
FANEU00000619

Controller DMX 24 Kanäle
Konstantspannung 4 A
Eingang SPANNUNG 12/24 V DC
Ausgang LEISTUNG 24X(48-96) W
Ausgang STROM 24X4 A

Controller DMX 24 channels
Constant voltage 4A
Input VOLTAGE 12/24V DC
Output POWER 24X(48-96)W
Output CURRENT 24X4A

264,5 × 83 × 42 mm



SPLITTER-DMX-4
8031440359542
FANEU00008541

SPLITTER DMX
6W XLR-3X4PCS XLR-5X4PCS

DMX SPLITTER
6W XLR-3X4PCS XLR-5X4PCS



CONTROLLER



CONTROLLER-CTR-RGB
8031440358026
FANEU00000617

Steuergerät
PORT FÜR DMX512 LED RGB
Eingang 230 V AC
Ausgang DC (12 V 144 W - 24 V 300 W)
6 Ports 3 RGB-Kanäle

Control box with DMX512
Port for LED RGB
Input 230V AC
Output DC (12V 144W - 24V 300W)
6 ports 3 RGB channels

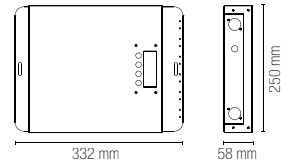

CONTROLLER-CTR-RGB12
8031440355438
FANEU00000618

Steuergerät
PORT FÜR DMX512 LED RGB
Eingang 230 V AC
Ausgang DC (12 V 300 W)
6 Ports 3 RGB-Kanäle

Control box with DMX512
Port for LED RGB
Input 230V AC
Output DC 12V 300W
6 ports 3 RGB channels

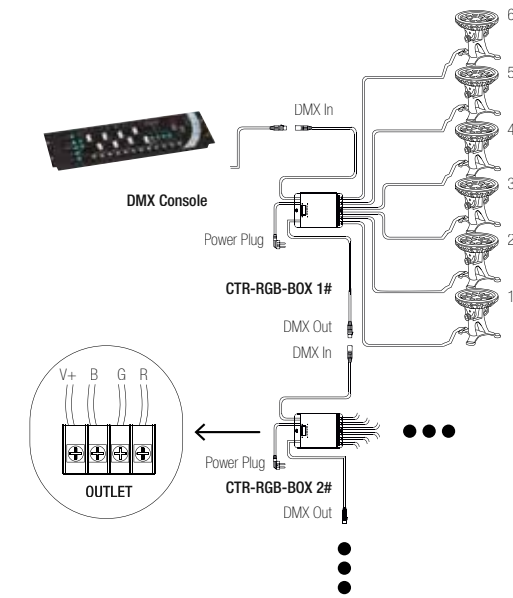

CONTROLLER-PRO-3
8031440358033
FANEU00000622

Controller Master 3 Kanäle
für Flutlichtleuchten
im Modus EASY
EIN 230 V AUS DMX/XLR-3
2 Kanäle IP20

Controller Master 3 channels
for flood in EASY MODE
IN 230V OUT DMX/XLR-3
2 channels IP20

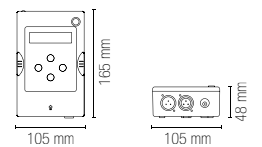

CONTROLLER-PRO-2
8031440358002
FANEU00000621

Controller DMX LED
3 Kanäle RGB AUSGANGSSIGNAL
DMX/XLR-3 (zwei Ausgänge)
IP20 mit Ladekabel

Controller DMX LED
3 channels RGB OUTPUT SIGNAL
DMX/XLR-3 (two port)
IP20 with charge cable

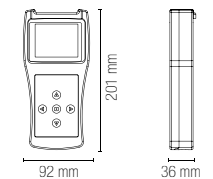
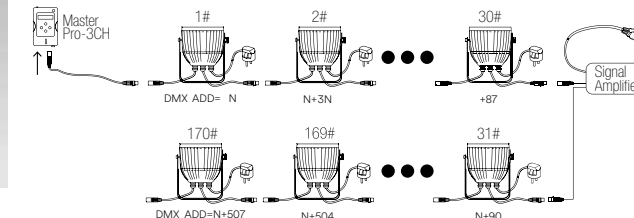

CONTROLLER



AMPLIFIER-DMX
8031414936793
FANEU00026885

Signalverstärker DMX, kompatibel mit dem internationalen Protokoll DMX512, gekennzeichnet durch hervorragende Anpassungsfähigkeit, hohe Zuverlässigkeit und kompakte Abmessungen. Dieses Gerät umfasst Isolatoren mit Optoisolator zwischen den Eingangs- und Ausgangssignalen und garantiert so eine wirksame Trennung zwischen der Gleichstromversorgung und damit eine sicherere Auslegung. Diese Merkmale sorgen für mehr Sicherheit bei der Stromlast und eine stabile und zuverlässige Signalübertragung.

DMX signal amplifier compatible with the international DMX512 protocol, characterized by excellent adaptability, high reliability, and compact dimensions. This device integrates opto-isolator isolators between the input and output signals, ensuring effective separation between the DC power supply for a safer design. These features contribute to a safer load and stable, reliable signal transmission.

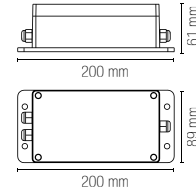

CONTROLLER



LED-SUNLITE-U9
8031440359467
FANEU00007498

SUNLITE Controller
256 Input-Kanäle
(max. 218 Steps)

SUNLITE Controller
256 channels Input
(218 steps max)

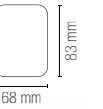

LED-SUNLITE-GU2
8031422251093
FANEU00007497

SUNLITE DMX STICK-GU2
128 Input-Kanäle 240 V

SUNLITE DMX STICK-GU2
128 channels Input 240V

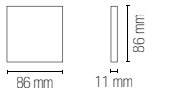

LED-SUNLITE-DE3
8031440359498
FANEU00007496

SUNLITE 2X512 DMX
ESA PRO/SUITE 2

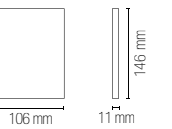



Beleuchtungskomponenten / Lighting components
Zubehör / Accessories

Die Berechnung des richtigen Netzteils für Beleuchtungsprodukte mit Niederspannung ist ein ausschlaggebender Schritt, um die korrekte Funktionsweise und die Sicherheit der Anlage zu garantieren. Im Anschluss ein detaillierter Leitfadens dazu, wie bei dieser Berechnung vorzugehen ist.

Ermitteln der technischen Daten des Beleuchtungsprodukts. Beginnen Sie damit, die notwendigen Informationen zu den Produkten zusammenzutragen, die Sie verwenden möchten. Zu den wichtigsten technischen Daten gehören:

- **Nennspannung (V)**
Die Betriebsspannung des Produkts, z. B. 12V oder 24V.
- **Leistung (W)**
Die vom Produkt aufgenommene Leistung (Stromverbrauch), die in Watt (W) ausgedrückt wird. Dieser Wert ist zur Berechnung des Netzteils unverzichtbar.
- **Berechnen des Gesamtenergieverbrauchs**
Wenn Sie mehr als eine Beleuchtung versorgen müssen, müssen Sie die Leistung aller Geräte summieren. Wenn Sie zum Beispiel drei 10-W-Glühlampen haben, erfolgt die Berechnung so:
Gesamtleistung = 10 W + 10 W + 10 W = 30W
- **Dabei ist ein Sicherheitspielraum zu berücksichtigen**
Es ist empfehlenswert, das Netzteil mit einer höheren Leistung als der für den Betrieb der Geräte erforderlichen zu wählen. Dieser Sicherheitspielraum trägt dazu bei, Überhitzung vorzubeugen und verlängert die Lebensdauer des Netzteils. Als Faustregel ist ein Spielraum von 20 % bis 30 % vorzusehen. So ergibt sich folgendes Beispiel:
Empfohlene Leistung = Leistung insg. x 1,25 = 30W x 1,25 = 37,5 W
Nach Aufrundung kann man ein 40-W-Netzteil wählen.
- **Prüfen der Ausgangsspannung**
Vergewissern Sie sich, dass das gewählte Netzteil die gleiche Nennspannung liefert, die von den Beleuchtungsgeräten verlangt wird. Wenn Ihre Produkte mit 12V betrieben werden, muss das Netzteil einen 12-V-Ausgang aufweisen.
- **Kontrolle des Netzteiltyps**
Es gibt verschiedenen Netzteiltypen, zum Beispiel: Gleichstromnetzteile (DC), die für den Großteil der LED-Glühlampen und anderen Niederspannungsbeleuchtungen erforderlich sind. Schaltnetzteile, die leistungsfähiger, leichter und kompakter sind und sich für verschiedene Anwendungen eignen. Vergewissern Sie sich, dass das gewählte Netzteil mit Ihrer jeweiligen Beleuchtungsart kompatibel ist.
- **Sicherheitszertifizierung kontrollieren**
Vergewissern Sie sich, dass das Netzteil gemäß den maßgeblichen Sicherheitsstandards zertifiziert ist (CE, UL usw.), um einen sicheren und zuverlässigen Betrieb zu gewährleisten.

PRAKTISCHES BEISPIEL

Stellen wir uns vor, wir haben 5 LED-Einbauleuchten mit jeweils 8 W, die mit 24V betrieben werden. Und so wird das Netzteil berechnet:

1. Gesamtleistung:
5 Einbauleuchten x 8 W = 40 W
2. Sicherheitspielraum:
40 W x 1,25 = 50W
3. Wahl des Netzteils
Ein 24-V-Netzteil mit einer Leistung von mindestens 50W wählen.

Durch Befolgung dieser Schritte sind Sie in der Lage, das für Ihr Niederspannungsbeleuchtungssystem geeignete Netzteil zu wählen und garantieren so optimale und sichere Leistungen.

Calculating the appropriate power supply for low-voltage lighting products is a crucial step in ensuring the proper functioning and safety of the system. Below is a detailed guide on how to proceed with this calculation.

Identify the Lighting Product Specifications. Start by gathering the necessary information about the lighting products you intend to use. The most important specifications include:

- **Nominal Voltage (V)**
The operating voltage of the product, for example, 12V or 24V.
- **Power (W)**
The power consumed by the product, which can be expressed in watts (W). This value is essential for calculating the power supply.
- **Calculate the total power consumption**
If you have multiple lighting fixtures to power, you will need to sum the power of all devices. For example, if you have three 10W bulbs, the calculation will be: **Total Power = 10W + 10W + 10W = 30W**
- **Consider a safety margin**
It is advisable to choose a power supply with a capacity greater than what is required for the operation of the devices. This safety margin helps prevent overheating and increases the lifespan of the power supply itself. A common rule is to add a margin of 20-30%. Therefore, in our example:
Recommended Power = Total Power x 1.25 = 30W x 1.25 = 37.5W
Rounding up, you might opt for a 40W power supply.
- **Check the output voltage**
Make sure that the chosen power supply provides the same nominal voltage required by the lighting devices. If your products operate at 12V, the power supply must have an output of 12V.
- **Check the type of power supply**
There are different types of power supplies, such as: DC Power Supplies necessary for most LED bulbs and other low-voltage lighting. Switching Power Supplies more efficient, lightweight, and compact, suitable for various applications. Ensure that the chosen power supply is compatible with the type of lighting you have.
- **Check the safety certification**
Make sure the power supply is certified according to relevant safety standards (CE, UL, etc.) to ensure safe and reliable operation.























PRACTICAL EXAMPLE

Let's assume you have 5 LED recessed lights, each consuming 8W, operating at 24V. Here's how to calculate the power supply:























1. Total Power:
5 fixtures x 8W = 40W
2. Safety Margin:
40W x 1.25 = 50W
3. Choosing the Power Supply:
Select a 24V power supply with a capacity of at least 50W.

By following these steps, you will be able to choose the appropriate power supply for your low-voltage lighting system, ensuring optimal and safe performance.

ZUBEHÖR / ACCESSORIES











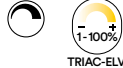

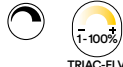

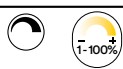

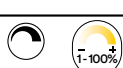











	TRASFORMATORE-120 8031440355094 FANEU00008930			
	Transformator 120 W Eingang 240 V AC Ausgang 12V AC IP44 10A	Voltage power supply 120W Input 240V AC Output 12V AC IP44 10A		180 x 134 x 63 mm
	LED-IRIDE-CAVO-2M-2P 8031440355452 FANEU00006505			
	2-poliges Kabel für Strahler IRIDE aus weißem Aluminium	Cable 2 poles for IRIDE white headlight aluminium		2 metri / 2 meters
	LED-IRIDE-CAVO-2M 8031440358095 FANEU00006504			
	4-poliges RGB-Kabel für Strahler IRIDE RGB aus weißem Aluminium	RGB cable 4 poles for IRIDE RGB white headlight aluminium		2 metri / 2 meters
	CONNETTORE-M 8031440355469 FANEU00000615			
	Stecker für DMX	Male connector for DMX		
	CONNETTORE-F 8031440355476 FANEU00000611			
	Buchse für DMX	Female connector for DMX		
	CONNECTBOX-IP68-3 8031440358903 FANEU00000609			
	3-polige Anschlussdose	Connection box with three poles		35 x 115 x 71 mm
	CONNECTBOX-IP68-2 8031440358927 FANEU00000608			
	2-polige Anschlussdose	Connection box with two poles		30 x 115 x 41 mm
	GUAINA 8031440355483 FANEU00000906			
	Isolierummantelung	Insulating sheath		
	CONNETTORE-IP20 8031414897681 FANEU00000612			
	Verbinder IP20 2L+2N	IP20 2L+2N Connector		
	CONNETTORE-IP65 8031414897698 FANEU00000613			
	Verbinder IP65	IP65 Connector		
	CONNETTORE-IP68 8031414897704 FANEU00000614			
	Verbinder IP68	IP68 Connector		
	CONNETTORE-T-IP68 8031414949076 FANEU00028513			
	Verbinder IP68	IP68 Connector		

DRIVER

























Driver MINI and LT		I-DRIVER/4W 8031414862801 FANEU00001704	Konstantstrom / constant current	
		MINI-Driver Konstantstrom Ausgang 2-12V 350 mA 4W Eingang 100 ~ 240 V	MINI constant current driver Output 2-12V 350mA 4W Input 100 ~ 240V	38 × 27 × 21 mm
		I-DRIVER/4W-24V 8031414871797 FANEU00001705	Konstantspannung / constant voltage	
		MINI-Driver Konstantstrom Ausgang 24V DC 0,17 A 4W Eingang 100 ~ 240 V AC 50 ~ 60 H	MINI constant voltage driver Output 24V DC 0.17A 4W Input 100 ~ 240V AC 50 ~ 60H	38 × 27 × 21 mm
Driver LT 24V Ultradünne Konstantspannungsnetzteile / Ultra Thin Constant Voltage Power Supplies		I-DRIVER-LT-30-24 8031414896196 FANEU00001668	Konstantspannung / constant voltage	
		LT-Driver Konstantspannung Ausgang 24VDC 1,25 A 30W Eingang 220 ~ 240V AC	LT constant voltage driver Output 24VDC 1.25A 30W Input 220 ~ 240V AC	251 × 30 × 16 mm
		I-DRIVER-LT-45-24 8031414941087 FANEU00027788	Konstantspannung / constant voltage	
		LT-Driver Konstantspannung Ausgang 24VDC 1,87 A 45W Eingang 220 ~ 240V AC	LT constant voltage driver Output 24VDC 1.87A 45W Input 220 ~ 240V AC	251 × 30 × 16 mm
		I-DRIVER-LT-60-24 8031414896202 FANEU00001669	Konstantspannung / constant voltage	
		LT-Driver Konstantspannung Ausgang 24VDC 2,5 A 60W Eingang 220 ~ 240V AC	LT constant voltage driver Output 24VDC 2.5A 60W Input 220 ~ 240V AC	305 × 30 × 18,2 mm
		I-DRIVER-LT-75-24 8031414876822 FANEU00001671	Konstantspannung / constant voltage	
		LT-Driver Konstantspannung Ausgang 24VDC 3,12 A 75W Eingang 220 ~ 240V AC	LT constant voltage driver Output 24VDC 3.12A 75W Input 220 ~ 240V AC	305 × 30 × 17 mm
		I-DRIVER-LT-100-24 8031414896226 FANEU00001664	Konstantspannung / constant voltage	
		LT-Driver Konstantspannung Ausgang 24VDC 4,17 A 100W Eingang 220 ~ 240V AC	LT constant voltage driver Output 24VDC 4.17A 100W Input 220 ~ 240V AC	312 × 30 × 18,2 mm
	I-DRIVER-LT-150-24 8031414876846 FANEU00001665	Konstantspannung / constant voltage		
	LT-Driver Konstantspannung Ausgang 24V DC 6,25 A 150W Eingang 220 ~ 240V AC	LT constant voltage driver Output 24V DC 6.25A 150W Input 220 ~ 240V AC	336 × 30 × 17 mm	
	I-DRIVER-LT-200-24 8031414896240 FANEU00001667	Konstantspannung / constant voltage		
	LT-Driver Konstantspannung Ausgang 24VDC 8,34 A 200W Eingang 220 ~ 240V AC	LT constant voltage driver Output 24VDC 8.34A 200W Input 220 ~ 240V AC	335 × 30 × 21,6 mm	
	I-DRIVER-LT-240-24 8031414941100 FANEU00027790	Konstantspannung / constant voltage		
	LT-Driver Konstantspannung Ausgang 24VDC 0-10 A 240W Eingang 220 ~ 240V AC	LT constant voltage driver Output 24VDC 0-10A 240W Input 220 ~ 240V AC	357 × 32 × 22,5 mm	

DRIVER

Ultradünne Konstantspannungsnetzteile,
dimmbar, Phasenschnitt und Dali /
Ultra Thin Constant Voltage Power Supplies
Dimmable Phase Cutting and Dali

Driver LT 24V DIMM Phasenschnitt / Driver LT 24V DIMM phase-cut		I-DRIVER-LT-100-24T 8031414941414 FANEU00027802	Konstantspannung / constant voltage	
		Dimmerfunktion mit Phasenschnitt sowohl Leading Edge als auch Trailing Edge 1-100 % LT-Driver Konstantspannung Ausgang 24VDC 1,38 ~ 4,17 A von 33W bis 100W Eingang 220 ~ 240V AC	Phase-cut dimming function, both Leading Edge and Trailing Edge 1-100% LT constant voltage driver Output 24VDC 1.38 ~ 4.17A 33 to 100W Input 220 ~ 240V AC	400 × 21,6 × 32 mm
		I-DRIVER-LT-150-24T 8031414941421 FANEU00027803	Konstantspannung / constant voltage	
		Dimmerfunktion mit Phasenschnitt sowohl Leading Edge als auch Trailing Edge 1-100 % LT-Driver Konstantspannung Ausgang 24VDC 2,06 ~ 6,25 A von 50W bis 150W Eingang 220-240V AC	Phase-cut dimming function, both Leading Edge and Trailing Edge 1-100% LT constant voltage driver Output 24VDC 2.06 ~ 6.25A 50 to 150W Input 220 ~ 240V AC	400 × 21,6 × 32 mm
		I-DRIVER-LT-200-24T 8031414941438 FANEU00027804	Konstantspannung / constant voltage	
		Dimmerfunktion mit Phasenschnitt sowohl Leading Edge als auch Trailing Edge 1-100 % LT-Driver Konstantspannung Ausgang 24VDC 0,2 ~ 8,33 A 200W Eingang 220 ~ 240V AC	Phase-cut dimming function, both Leading Edge and Trailing Edge 1-100% LT constant voltage driver Output 24VDC 0.2 ~ 8.33A 200W Input 220 ~ 240V AC	450 × 32 × 23 mm
		I-DRIVER-LT-240-24T 8031414941445 FANEU00027805	Konstantspannung / constant voltage	
		Dimmerfunktion mit Phasenschnitt sowohl Leading Edge als auch Trailing Edge 1-100 % LT-Driver Konstantspannung Ausgang 24VDC 3,33 ~ 10 A 240W Eingang 220 ~ 240V AC	Phase-cut dimming function, both Leading Edge and Trailing Edge 1-100% LT constant voltage driver Output 24VDC 3.33 ~ 10A 240W Input 220 ~ 240V AC	450 × 23 × 32 mm
Driver LT 24V DALI2 push		I-DRIVER-LT-75-24D 8031414941124 FANEU00027792	Konstantspannung / constant voltage	 
		Dimmerfunktion 0,1-100 % Dimmerschalter - DALI 2 LT-Driver Konstantspannung Ausgang 24VDC 0 - 3,125 A 75W Eingang 220 ~ 240V AC	Dimming function 0.1-100% switch dimm - DALI 2 LT constant voltage driver Output 24VDC 0 - 3.125A 75W Input 220 ~ 240V AC	400 × 21,6 × 32 mm
		I-DRIVER-LT-100-24D 8031414941131 FANEU00027793	Konstantspannung / constant voltage	 
		Dimmerfunktion 0,1-100 % Dimmerschalter - DALI 2 LT-Driver Konstantspannung Ausgang 24VDC 0 - 4,17 A 100W Eingang 220 ~ 240V AC	Dimming function 0.1-100% switch dimm - DALI 2 LT constant voltage driver Output 24VDC 0 - 4.17A 100W Input 220 ~ 240V AC	400 × 21,6 × 32 mm
		I-DRIVER-LT-150-24D 8031414941148 FANEU00027794	Konstantspannung / constant voltage	 
		Dimmerfunktion 0,1-100 % Dimmerschalter - DALI 2 LT-Driver Konstantspannung Ausgang 24VDC 0 - 6,25 A 150W Eingang 220 ~ 240V AC	Dimming function 0.1-100% switch dimm - DALI 2 LT constant voltage driver Output 24VDC 0 - 6.25A 150W Input 220 ~ 240V AC	400 × 21,6 × 32 mm
		I-DRIVER-LT-200-24D 8031414941155 FANEU00027795	Konstantspannung / constant voltage	 
		Dimmerfunktion 0,1-100 % Dimmerschalter - DALI 2 LT-Driver Konstantspannung Ausgang 24VDC 0 - 8,33 A 200W Eingang 220 ~ 240V AC	Dimming function 0.1-100% switch dimm - DALI 2 LT constant voltage driver Output 24VDC 0 - 8.33A 200W Input 220 ~ 240V AC	450 × 23 × 32 mm
		I-DRIVER-LT-240-24D 8031414941162 FANEU00027796	Konstantspannung / constant voltage	 
		Dimmerfunktion 0,1-100 % Dimmerschalter - DALI 2 LT-Driver Konstantspannung Ausgang 24VDC 0 - 10 A 240W Eingang 220 ~ 240V AC	Dimming function 0.1-100% switch dimm - DALI 2 LT constant voltage driver Output 24VDC 0 - 10A 240W Input 220 ~ 240V AC	450 × 23 × 32 mm

DRIVER

<p>Dimmbare ultradünne Konstantspannungsnetzteile von Dali. Driver LT 24V 2 Ausgangskanäle und Dimmerfunktion DALI2 DALI-2 DT8-Integration für die native Steuerung von Tunable White LED-Streifen über eine einzige Adresse</p> <p>/</p> <p>Dali Dimmable Ultrathin Constant Voltage Power Supplies. Driver LT 24V 2 output channels and DALI2 dimming DALI-2 DT8 integration for native control of Tunable White LED strips via a single address</p>		<p>I-DRIVER-LT-75-24DTW 8031414941179 FANEU00027797</p> <p>LT Driver Konstantspannung Dimmerfunktionen DALI2 DT8 und PUSH-Dimming, mit Dimming-Speicher 0,1% ~ 100% Ausgang 24VDC 3,12 A 75W Eingang 220 ~ 240V AC</p>	<p>Konstantspannung / constant voltage</p> <p>400 × 32 × 21,6 mm</p> <p>  </p>
		<p>I-DRIVER-LT-100-24DTW 8031414941186 FANEU00027798</p> <p>LT Driver Konstantspannung Dimmerfunktionen DALI2 DT8 und PUSH-Dimming, mit Dimming-Speicher 0,1% ~ 100% Ausgang 24VDC 0 - 4,17 A 100W Eingang 220 ~ 240V AC</p>	<p>Konstantspannung / constant voltage</p> <p>400 × 32 × 21,6 mm</p> <p>  </p>
		<p>I-DRIVER-LT-150-24DTW 8031414941384 FANEU00027799</p> <p>LT Driver Konstantspannung Dimmerfunktionen DALI2 DT8 und PUSH-Dimming, mit Dimming-Speicher 0,1% ~ 100% Ausgang 24VDC 0 - 6,25 A 150W Eingang 220 ~ 240V AC</p>	<p>Konstantspannung / constant voltage</p> <p>400 × 32 × 21,6 mm</p> <p>  </p>
		<p>I-DRIVER-LT-200-24DTW 8031414941391 FANEU00027800</p> <p>Driver Konstantspannung Dimmerfunktionen DALI2 DT8 und PUSH-Dimming, mit Dimming-Speicher 0,1% ~ 100% Ausgang 24VDC 2,78-8,33 A 200W Eingang 220 ~ 240V AC</p>	<p>Konstantspannung / constant voltage</p> <p>50 × 32 × 23 mm</p> <p>  </p>
		<p>I-DRIVER-LT-240-24DTW 8031414941407 FANEU00027801</p> <p>LT Driver Konstantspannung Dimmerfunktionen DALI2 DT8 und PUSH-Dimming, mit Dimming-Speicher 0,1% ~ 100% Ausgang 24VDC 0 - 10 A 240W Eingang 220 ~ 240V AC</p>	<p>Konstantspannung / constant voltage</p> <p>450 × 32 × 23 mm</p> <p>  </p>
	Driver LT 48V		<p>I-DRIVER-LT-60-48 8031414896219 FANEU00001670</p> <p>LT-Driver Konstantspannung Ausgang 48VDC 1,25 A 60W Eingang 220 ~ 240V AC</p>
	<p>I-DRIVER-LT-100-48 8031414941094 FANEU00027789</p> <p>LT-Driver Konstantspannung Ausgang 48VDC 0 - 2,08 A 100W Eingang 220 ~ 240V AC</p>	<p>Konstantspannung / constant voltage</p> <p>312 × 30 × 18,2 mm</p>	
	<p>I-DRIVER-LT-150-48 8031414896233 FANEU00001666</p> <p>LT-Driver Konstantspannung Ausgang 48VDC 3,125 A 150W Eingang 220 ~ 240V AC</p>	<p>Konstantspannung / constant voltage</p> <p>335 × 30 × 21,6 mm</p>	
	<p>I-DRIVER-LT-240-48 8031414941117 FANEU00027791</p> <p>LT-Driver Konstantspannung Ausgang 48VDC 0-5 A 240W Eingang 220 ~ 240V AC</p>	<p>Konstantspannung / constant voltage</p> <p>57 × 32 × 22,5 mm</p>	

NETZTEILE / POWER SUPPLY

<p>Konstantspannungsnetzteile LRS und RSP 12V / Constant voltage power supply LRS and RSP 12V</p>		<p>STRIP-DRIVER12V-35W 8031440360265 FANEU00008698</p> <p>Ausgang 12V 3 A 36W Eingang 85 ~ 264VAC 120 ~ 373VDC</p>	<p>Konstantspannung / constant voltage</p> <p>99 × 82 × 30 mm</p>
		<p>STRIP-DRIVER12V-50W 8031414866779 FANEU00008699</p> <p>Ausgang 12V 4,2 A 50W Eingang 85 ~ 264VAC 120 ~ 373VDC</p>	<p>Konstantspannung / constant voltage</p> <p>99 × 82 × 30 mm</p>
		<p>STRIP-DRIVER12V-75W 8031439581268 FANEU00008700</p> <p>Ausgang 12V 6 A 72W Eingang 85 ~ 264VAC 120 ~ 373VDC</p>	<p>Konstantspannung / constant voltage</p> <p>99 × 97 × 30 mm</p>
		<p>STRIP-DRIVER12V-100W 8031440359368 FANEU00008693</p> <p>Ausgang 12V 8,5 A 102W Eingang 85 ~ 264VAC 120 ~ 373VDC</p>	<p>Konstantspannung / constant voltage</p> <p>129 × 97 × 30 mm</p>
		<p>STRIP-DRIVER12V-150W 8031439611262 FANEU00008694</p> <p>Ausgang 12V 12,5 A 150W Eingang 85 ~ 132 VAC / 170 ~ 264 VAC mit Schalter 240 ~ 370VDC (Schalter auf 230VAC)</p>	<p>Konstantspannung / constant voltage</p> <p>159 × 97 × 30 mm</p>
		<p>STRIP-DRIVER12V-200W 8031440359375 FANEU00008695</p> <p>Ausgang 12V 16,7 A 200W Eingang 85 ~ 264VAC 124 ~ 370VDC</p>	<p>Konstantspannung / constant voltage</p> <p>215 × 115 × 30 mm</p>
		<p>STRIP-DRIVER12V-320W 8031440359344 FANEU00008697</p> <p>Ausgang 12V 26,7 A 320W Eingang 88 ~ 264VAC 124 ~ 370VDC</p>	<p>Konstantspannung / constant voltage</p> <p>215 × 115 × 30 mm</p>

NETZTEILE / POWER SUPPLY

**Konstantspannungs-
netzteile
LRS und RSP 24V /
Constant voltage
power supply
LRS and RSP 24V**



STRIP-DRIVER24V-35W 8031414870943 FANEU00008705	Konstantspannung / constant voltage	
Ausgang 24V 1,5 A 36W Eingang 85 ~ 264VAC 120 ~ 373VDC	Output 24V 1,5A 36W Input 85 ~ 264VAC 120 ~ 373VDC	99 × 82 × 30 mm



STRIP-DRIVER24V-50W 8031440364744 FANEU00008706	Konstantspannung / constant voltage	
Ausgang 24V 2,2 A 52W Eingang 85 ~ 264VAC 120 ~ 373VDC	Output 24V 2,2A 52W Input 85 ~ 264VAC 120 ~ 373VDC	99 × 82 × 30 mm



STRIP-DRIVER24V-75W 8031414870950 FANEU00008707	Konstantspannung / constant voltage	
Ausgang 24V 3,2 A 76W Eingang 85 ~ 264VAC 120 ~ 373VDC	Output 24V 3,2A 76W Input 85 ~ 264VAC 120 ~ 373VDC	99 × 97 × 30 mm



STRIP-DRIVER24V-100W 8031440364751 FANEU00008701	Konstantspannung / constant voltage	
Ausgang 24V 4,5 A 108 W Eingang 85 ~ 264VAC 120 ~ 373VDC	Output 24V 4.5A 108W Input 85 ~ 264VAC 120 ~ 373VDC	129 × 97 × 30 mm



STRIP-DRIVER24V-150W 8031414870967 FANEU00008702	Konstantspannung / constant voltage	
Ausgang 24V 6,5 A 156 W Eingang 85 ~ 132VAC / 170 ~ 264VAC mit Schalter 240 ~ 370VDC (Schalter auf 230VAC)	Output 24V 6.5A 156W Input 85 ~ 132VAC / 170 ~ 264VAC by switch 240 ~ 370VDC (switch on 230VAC)	159 × 97 × 30 mm



STRIP-DRIVER24V-200W 8031440364737 FANEU00008703	Konstantspannung / constant voltage	
Ausgang 24V 8,4 A 201 W Eingang 85 ~ 264VAC 124 ~ 370VDC	Output 24V 8,4A 201W Input 85 ~ 264VAC 124 ~ 370VDC	215 × 115 × 30 mm



STRIP-DRIVER24V-320W 8031414864959 FANEU00008704	Konstantspannung / constant voltage	
Ausgang 24V 13,4 A 321W Eingang 88 ~ 264VAC 124 ~ 370VDC	Output 24V 13,4A 321W Input 88 ~ 264VAC 124 ~ 370VDC	215 × 115 × 30 mm

NETZTEILE / POWER SUPPLY

**Konstantspannungs-
netzteile UHP 24V /
Constant voltage power
supply UHP 24V**



I-DRIVER-UHP-200-24 8031414896387 FANEU00001688	Konstantspannung / constant voltage	
Ausgang 24V 8,4 A 200W Eingang 90 ~ 264VAC 127 ~ 370VDC	Output 24V 8.4A 200W Input 90 ~ 264VAC 127 ~ 370VDC	194 × 55 × 26 mm



I-DRIVER-UHP-350-24 8031414879618 FANEU00001689	Konstantspannung / constant voltage	
Ausgang 24V 14,6 A 350W Eingang 90 ~ 264VAC 127 ~ 370VDC ohne Gebläse	Output 24V 14.6A 350W Input 90 ~ 264VAC 127 ~ 370VDC without fan	220 × 62 × 31 mm



I-DRIVER-UHP-500-24 8031414879625 FANEU00001690	Konstantspannung / constant voltage	
Ausgang 24V 20,9 A 501 W Eingang 90 ~ 264VAC 127 ~ 370VDC ohne Gebläse	Output 24V 20.9A 501W Input 90 ~ 264VAC 127 ~ 370VDC without fan	220 × 62 × 31 mm

**Konstantspannungs-
netzteile RSP 36 V /
Constant voltage power
supply RSP 36 V**



STRIP-DRIVER36V-200W 8031414870974 FANEU00008708	Konstantspannung / constant voltage	
Ausgang 36 V 5,56 A 200W Eingang 88 ~ 264VAC 124 ~ 370VDC	Output 36V 5.56A 200W Input 88 ~ 264VAC 124 ~ 370VDC	215 × 115 × 30 mm



STRIP-DRIVER36V-320W 8031414864829 FANEU00008709	Konstantspannung / constant voltage	
Ausgang 36 V 8,9 A 320W Eingang 88 ~ 264VAC 124 ~ 370VDC	Output 36V 8.9A 320W Input 88 ~ 264VAC 124 ~ 370VDC	215 × 115 × 30 mm

**Konstantspannungs-
netzteile RSP 48V /
Constant voltage power
supply RSP 48V**



STRIP-DRIVER48V-75W 8031414881536 FANEU00008713	Konstantspannung / constant voltage	
Ausgang 48V 1,6 A 76,8 W Eingang 88 ~ 264VAC 124 ~ 370VDC	Output 48V 1.6A 76,8W Input 88 ~ 264VAC 124 ~ 370VDC	99 × 97 × 30 mm



STRIP-DRIVER48V-150W 8031414881529 FANEU00008710	Konstantspannung / constant voltage	
Ausgang 48V 3,3 A 158,4W Eingang 85 ~ 132 VAC 240 ~ 370VDC	Output 48V 3.3A 158,4W Input 85 ~ 132VAC 240 ~ 370VDC	159 × 97 × 30 mm



STRIP-DRIVER48V-200W 8031414878307 FANEU00008711	Konstantspannung / constant voltage	
Ausgang 48V 4,2 A 201 W Eingang 88 ~ 264VAC 124 ~ 370VDC	Output 48V 4.2A 201W Input 88 ~ 264VAC 124 ~ 370VDC	215 × 115 × 30 mm





































STRIP-DRIVER48V-320W 8031414878314 FANEU00008712	Konstantspannung / constant voltage	
Ausgang 48V 6,7 A 321,6 W Eingang 88 ~ 264VAC 124 ~ 370VDC	Output 48V 6,7 A 321,6 W Input 88 ~ 264VAC 124 ~ 370VDC	215 × 115 × 30 mm



















DRIVER

	I-DRIVER/18W-24V 8031414875351 FANEU00001699 LPH Output 24V 0.75A 18W Input 180 ~ 264VAC 254 ~ 370VDC	Konstantspannung / constant voltage	
	I-DRIVER/18W 8031439571269 FANEU00001698 LPHC Output 6~48V 350mA 16,8W Input 180 ~ 264VAC	Konstantstrom / constant current	
	I-DRIVER-DIMM-LCM25 8031414924653 FANEU00001636 LCM dimmable 42W Output DC 0~54V 350mA; 6~50V 500mA; 6~42V 600mA; 6~36V 700mA; 6~28V 900mA; 6~24V 1050mA; Input 180 ~ 277VAC 254~392VDC	Konstantstrom / constant current	 
	I-DRIVER-DIMM-LCM40 8031439591267 FANEU00001638 LCM dimmable 42W Output DC 2~100V 350mA; 2~80V 500mA; 2~67V 600mA; 2~57V 700mA; 2~45V 900mA; 2~40V 1050mA; Input 180 ~ 295VAC 254~417VDC	Konstantstrom / constant current	 
	I-DRIVER-DIMM-LCM60 8031439561260 FANEU00001640 LCM dimmable 60W Output DC 2~90V 500mA; 2~90V 600mA; 2~86V 700mA; 2~67V 900mA; 2~57V 1050mA; 2~42V 1400mA; Input 180 ~ 295VAC 254~417VDC	Konstantstrom / constant current	 
	I-DRIVER-DIMM-LCM25DA 8031414924660 FANEU00001637 LCM dimmable 42W Output DC 0~54V 350mA; 6~50V 500mA; 6~42V 600mA; 6~36V 700mA; 6~28V 900mA; 6~24V 1050mA; Input 180 ~ 277VAC 254~380VDC(254~375VDC for DA2-Type)	Konstantstrom / constant current	 
	I-DRIVER-DIMM-LCM40DA 8031414924677 FANEU00001639 LCM dimmable 42W Output DC 2~100V 350mA; 2~80V 500mA; 2~67V 600mA; 2~57V 700mA; 2~45V 900mA; 2~40V 1050mA; Input 180 ~ 295VAC 254 ~ 392VDC	Konstantstrom / constant current	 
	I-DRIVER-DIMM-LCM60DA 8031414924684 FANEU00001641 LCM dimmable 60W Output DC 2~90V 500mA; 2~90V 600mA; 2~86V 700mA; 2~67V 900mA; 2~57V 1050mA; 2~42V 1400mA; Input 180 ~ 295VAC 254 ~ 392VDC	Konstantstrom / constant current	 
	I-DRIVER-HLG-320-12 8031440360258 FANEU00001658 Output 12V 22A 264W Input 90 ~ 305VAC 127 ~ 431VDC	Konstantspannung / constant voltage	









DRIVER

	Driver ELG 24V IP67 dimmbar und LPV 24V IP67 / Dimmable driver ELG 24V IP67 and LPV 24V IP67	Konstantspannung / constant voltage	  
	I-DRIVER-ELG-100-24 8031414876914 FANEU00001642 ELG Dimmable Output 24V 4A 100W Input 100 ~ 305VAC 142 ~ 431VDC continue 320VAC for 24Hrs; 360VAC for 1Hr	Konstantspannung / constant voltage	  
	I-DRIVER-ELG-100-24DA 8031414876921 FANEU00001643 ELG Dimmable DALI Output 24V 4A 100W Input 100 ~ 305VAC 142 ~ 431VDC continue 320VAC for 24Hrs; 360VAC for 1Hr	Konstantspannung / constant voltage	  
	I-DRIVER-ELG-150-24 8031414876891 FANEU00001644 ELG Dimmable Output 24V 6.25A 150W Input 100 ~ 305VAC 142 ~ 431VDC	Konstantspannung / constant voltage	  
	I-DRIVER-ELG-150-24DA 8031414876907 FANEU00001645 ELG Dimmable DALI Output 24V 6.25A 150W Input 100 ~ 305VAC 142 ~ 431VDC	Konstantspannung / constant voltage	  
	I-DRIVER-ELG-240-24 8031414876877 FANEU00001646 ELG Dimmable Output 24V 10A 240W Input 100 ~ 305VAC 142 ~ 431VDC	Konstantspannung / constant voltage	  
	I-DRIVER-ELG-240-24DA 8031414876884 FANEU00001647 ELG Dimmable DALI Output 24V 10A 240W Input 100 ~ 305VAC 142 ~ 431VDC	Konstantspannung / constant voltage	  
	I-DRIVER-LPV-60-24 8031414876839 FANEU00001663 LPV Output 24V 2.5A 60W Input 90 ~ 264VAC 127 ~ 370VDC	Konstantspannung / constant voltage	
	I-DRIVER-LPV-100-24 8031414876853 FANEU00001661 LPV Output 24V 4.2A 100W Input 90 ~ 264VAC 127 ~ 370VDC	Konstantspannung / constant voltage	
	I-DRIVER-LPV-150-24 8031414876860 FANEU00001662 LPV Output 24V 6.3A 150W Input 180 ~ 305VAC 254 ~ 431VDC	Konstantspannung / constant voltage	















DRIVER











Driver XLG 24V IP67		I-DRIVER-XLG-75-24 8031414873708 FANEU00001694 Ausgang 24V 3,1 A 75W Eingang 100 ~ 305VAC 142 ~ 431VDC	Konstantspannung / constant voltage Output 24V 3,1A 75W Input 100 ~ 305VAC 142 ~ 431VDC		140 × 63 × 32 mm
		I-DRIVER-XLG-100-24 8031414879595 FANEU00001691 Ausgang 24V 4 A 100W Eingang 100 ~ 305VAC 142 ~ 431VDC	Konstantspannung / constant voltage Output 24V 4A 100W Input 100 ~ 305VAC 142 ~ 431VDC		140 × 63 × 32 mm
		I-DRIVER-XLG-150-24 8031414879601 FANEU00001692 Ausgang 24V 6,25 A 150W Eingang 100 ~ 305VAC 142 ~ 431VDC	Konstantspannung / constant voltage Output 24V 6.25A 150W Input 100 ~ 305VAC 142 ~ 431VDC		180 × 63 × 35,5 mm
		I-DRIVER-XLG-200-24 8031414879588 FANEU00001693 Ausgang 24V 8,3 A 200W Eingang 100 ~ 305VAC 142 ~ 431VDC	Konstantspannung / constant voltage Output 24V 8.3A 200W Input 100 ~ 305VAC 142 ~ 431VDC		199 × 63 × 35,5 mm
		I-DRIVER-XLG-320-V-A 8031414933761 FANEU00025947 Eingang 12/24V 13-18 A (24V/13 A, 12V/18 A) 24V/312 W, 12V/216 W Eingang 100 ~ 305VAC 142 ~ 431VDC	Konstantspannung / constant voltage Output 12/24V 13-18A (24V/13A, 12V/18A) 24V/312W, 12V/216W Input 100 ~ 305VAC 142 ~ 431VDC		246 × 77 × 39,5 mm
Driver PWM DALI2		I-DRIVER-PWM-60-24DA 8031414896356 FANEU00001678 Ausgang 24V 2,5 A 60W Eingang 90 ~ 305VAC 127 ~ 431VDC DALI2 0.2% - 100% Deep Dimming	Konstantspannung / constant voltage Output 24V 2.5A 60W Input 90 ~ 305VAC 127 ~ 431VDC DALI2	 	150 × 53 × 35 mm
		I-DRIVER-PWM-120-24DA 8031414896363 FANEU00001676 Ausgang 24V 5 A 120 W Eingang 90 ~ 305VAC 127 ~ 431VDC DALI2 0.2% - 100% Deep Dimming	Konstantspannung / constant voltage Output 24V 5A 120W Input 90 ~ 305VAC 127 ~ 431VDC DALI2 0.2% - 100% Deep Dimming	 	191 × 63 × 37,5 mm
		I-DRIVER-PWM-200-24DA 8031414896370 FANEU00001677 Ausgang 24V 8,3 A 200W Eingang 100 ~ 305VAC 142 ~ 431VDC DALI2 0.2% - 100% Deep Dimming	Konstantspannung / constant voltage Output 24V 8.3A 200W Input 100 ~ 305VAC 142 ~ 431VDC DALI2 0.2% - 100% Deep Dimming	 	195 × 68 × 39,5 mm

DRIVER

Ultraschmale DIN-Schiene in Stufenform / Ultra Slim Step Shape DIN Rail		I-DRIVER-HDR-60-24 8031414896271 FANEU00001651 Ausgang 24V 2,5 A 60W Eingang 85-264 VAC (277VAC operativ) 120 ~ 370VDC (390VAC operativ)	Konstantspannung / constant voltage Output 24V 2.5A 60W Input 85 ~ 264VAC (277VAC operational) 120 ~ 370VDC (390VAC operational)		52,5 × 90 × 54,5 mm
		I-DRIVER-HDR-100-24 8031414896288 FANEU00001649 Ausgang 24V 3,83 A 100W Eingang 85-264 VAC (277VAC operativ) 120 ~ 370VDC (390VAC operativ)	Konstantspannung / constant voltage Output 24V 3.83A 100W Input 85 ~ 264VAC (277VAC operational) 120 ~ 370VDC (390VAC operational)		70 × 90 × 54,5 mm
		I-DRIVER-HDR-150-24 8031414896295 FANEU00001650 Ausgang 24V 6,25 A 150W Eingang 85-264 VAC (277VAC operativ) 120 ~ 370VDC (390VAC operativ)	Konstantspannung / constant voltage Output 24V 6.25A 150W Input 85 ~ 264VAC (277VAC operational) 120 ~ 370VDC (390VAC operational)		105 × 90 × 54,5 mm
Industrielle DIN-Schiene mit Einzelausgang / Single Output Industrial DIN RAIL		I-DRIVER-NDR-240-24 8031414896301 FANEU00001672 Ausgang 24V 10 A 240W Eingang 90 ~ 264VAC 127 ~ 370VDC	Konstantspannung / constant voltage Output 24V 10A 240W Input 90 ~ 264VAC 127 ~ 370VDC		63 × 125,2 × 113,5 mm
		I-DRIVER-NDR-480-24 8031414896325 FANEU00001674 Ausgang 24V 20 A 480W Eingang 90 ~ 264VAC 127 ~ 370VDC	Konstantspannung / constant voltage Output 24V 20A 480W Input 90 ~ 264VAC 127 ~ 370VDC		85,5 × 125,2 × 128,5 mm
		I-DRIVER-NDR-240-48 8031414896318 FANEU00001673 Ausgang 48V 5 A 240W Eingang 90 ~ 264VAC 127 ~ 370VDC	Konstantspannung / constant voltage Output 48V 5A 240W Input 90 ~ 264VAC 127 ~ 370VDC		63 × 125,2 × 113,5 mm
		I-DRIVER-NDR-480-48 8031414896332 FANEU00001675 Ausgang 48V 10 A 480W Eingang 90 ~ 264VAC 127 ~ 370VDC	Konstantspannung / constant voltage Output 48V 10A 480W Input 90 ~ 264VAC 127 ~ 370VDC		85,5 × 125,2 × 128,5 mm
Industrielle DIN-Schiene mit Einzelausgang und PFC-Funktion / Single Output Industrial DIN RAIL		I-DRIVER-SDR-960-24 8031414896349 FANEU00001679 Ausgang 24V 40 A 960W Eingang 180 ~ 264VAC 254 ~ 370VDC	Konstantspannung / constant voltage Output 24V 40A 960W Input 180 ~ 264VAC 254 ~ 370VDC		110 × 125,2 × 150 mm
		I-DRIVER-DELO42 8031414897667 FANEU00001635 Unterstützung für Dimm-Modus DALI-2+PushDIM 10-Stufen-Stromausgang mittels DIP-Schalter weiches Dimmen ohne Flackern bei jeder Lichtstärke unter Verwendung der patentierten HPC-Technologie bleibt die Helligkeit der Leuchten bei jeder Dimmstufe konstant Dimmbereich 1~100%, Ausgangsstromgenauigkeit 2% Ausgang 6-38/40/42 VDC 0,45-1,10 A 42W Eingang 220 ~ 240VAC DALI2 PUSH DIM	Konstantspannung / constant voltage Support for DALI-2+pushDIM dimming mode 10-level current output achievable via DIP switch Soft dimming and flicker-free at any brightness Using patented HPC technology, the brightness of the lights remains constant at any dimming level Dimming range 1~100%, output current accuracy 2% Output 6-38/40/42 VDC 0.45-1.10A 42W Input 220 ~ 240VAC DALI2 PUSH DIM	 	103 × 68,5 × 30,5 mm







DRIVER

	I-DRIVER-60-24 8031414897797 FANEU00001633 Ausgang 24V 2,5 A 60W Eingang 176 ~ 264VAC 176 ~ 370VDC	Konstantspannung / constant voltage Output 24V 2.5A 60W Input 176 ~ 264VAC 176~370VDC	178 × 53 × 23 mm	
	I-DRIVER-60-24-IP67 8031414897841 FANEU00001634 Ausgang 24V 2,5 A 60W Eingang 176~264VAC	Konstantspannung / constant voltage Output 24V 2.5A 60W Input 176 ~ 264VAC	160 × 50 × 31 mm	
	I-DRIVER-100-24 8031414897803 FANEU00001626 Ausgang 24V 4,1 A 100W Eingang 176 ~ 264VAC 250 ~ 360VDC	Konstantspannung / constant voltage Output 24V 4.1A 100W Input 176 ~ 264VAC 250 ~ 360VDC	188 × 53 × 23 mm	
	I-DRIVER-100-24-IP67 8031414897858 FANEU00001627 Ausgang 24V 4,2 A 100W Eingang 176~264VAC	Konstantspannung / constant voltage Output 24V 4.2A 100W Input 176 ~ 264VAC	220 × 50 × 31 mm	
	I-DRIVER-150-24 8031414897810 FANEU00001628 Ausgang 24V 6,3 A 150W Eingang 175 ~ 264VAC 176 ~ 370VDC	Konstantspannung / constant voltage Output 24V 6.3A 150W Input 175 ~ 264VAC 176 ~ 370VDC	220 × 53 × 23 mm	
	I-DRIVER-150-24-IP67 8031414897865 FANEU00001629 Ausgang 24V 6,25 A 150W Eingang 176~264VAC	Konstantspannung / constant voltage Output 24V 6.25A 150W Input 176 ~ 264VAC	230 × 65 × 21 mm	
	I-DRIVER-200-24 8031414897827 FANEU00001630 Ausgang 24V 8,3 A 200W Eingang 175 ~ 264VAC 175 ~ 370VDC	Konstantspannung / constant voltage Output 24V 8.3A 200W Input 175 ~ 264VAC 175 ~ 370VDC	274 × 53 × 23 mm	
	I-DRIVER-200-24-IP67 8031414897872 FANEU00001631 Ausgang 24V 8,3 A 200W Eingang 175~264VAC	Konstantspannung / constant voltage Output 24V 8.3A 200W Input 175 ~ 264VAC	230 × 65 × 31 mm	
	I-DRIVER-300-24 8031414897834 FANEU00001632 Ausgang 22-24V 11,5 A 300W Eingang 175 ~ 264VAC 175 ~ 370VDC	Konstantspannung / constant voltage Output 22-24V 11.5A 300W Input 175 ~ 264VAC 175 ~ 370VDC	230 × 65 × 31 mm	
	I-DRIVER-300-24-IP67 8031414943357 FANEU00027996 Ausgang 24V 12,5A 300W Eingang 200 ~ 240VAC 2.1A / 230PAC	Konstantspannung / constant voltage Output 24V 12.5A 300W Input 200 ~ 240VAC 2.1A / 230PAC		

	I-DRIVER-60-48 8031414937981 FANEU00027370 Ausgang 48V 1.25A 60W Eingang 100~264VAC 48VD	Konstantspannung / constant voltage Output 48V 1.25A 60W Input 100~264VAC 48VD	170 × 35 × 23 mm	
	I-DRIVER-100-48 8031414937998 FANEU00027371 Ausgang 48V 2.08A 100W Eingang 175~264VAC	Konstantspannung / constant voltage Output 48V 2.08A 100W Input 175~264VAC	145 × 48 × 24 mm	
	I-DRIVER-150-48 8031414938001 FANEU00027372 Ausgang 48V 3.12A 150W Eingang 175~264VAC	Konstantspannung / constant voltage Output 48V 3.12A 150W Input 175~264VAC	195 × 48 × 24 mm	
	I-DRIVER-200-48 8031414938018 FANEU00027373 Ausgang 48V 4.16A 200W Eingang 200~240VAC	Konstantspannung / constant voltage Output 48V 4.16A 200W Input 200~240VAC	215 × 48 × 24 mm	
	I-DRIVER-300-48 8031414938025 FANEU00027374 Ausgang 48V 6.25A 300W Eingang 200~240VAC	Konstantspannung / constant voltage Output 48V 6.25A 300W Input 200~240VAC	236 × 49 × 29 mm	
	I-DRIVER-SL-100-24 8031414937943 FANEU00027407 Ausgang 24V 4.2A 100W Eingang 175~264VAC	Konstantspannung / constant voltage Output 24V 4.2A 100W Input 175~264VAC	217 × 27 × 23 mm	
	I-DRIVER-SL-150-24 8031414937950 FANEU00027369 Ausgang 24V 6.25A 150W Eingang 175~264VAC	Konstantspannung / constant voltage Output 24V 6.25A 150W Input 175~264VAC	217 × 27 × 23 mm	
	I-DRIVER-SL-200-24 8031414937967 FANEU00027405 Ausgang 24V 8.33A 200W Eingang 175~264VAC	Konstantspannung / constant voltage Output 24V 8.33A 200W Input 175~264VAC	217 × 27 × 23 mm	
	I-DRIVER-SL-250-24 8031414937974 FANEU00027406 Ausgang 24V 10.4A 250W Eingang 200~240VAC	Konstantspannung / constant voltage Output 24V 10.4A 250W Input 200~240VAC	292 × 31,3 × 22,6 mm	
	I-DRIVER-SL-36-24 8031414937929 FANEU00027363 Ausgang 24V 1.5A 36W Eingang 100~240VAC	Konstantspannung / constant voltage Output 24V 1.5A 36W Input 100~240VAC	94 × 25 × 20 mm	
	I-DRIVER-SL-60-24 8031414937936 FANEU00027364 Ausgang 24V 2.5A 60W Eingang 175~264VAC	Konstantspannung / constant voltage Output 24V 2.5A 60W Input 175~264VAC	222 × 19,5 × 18 mm	

DIMMER







Dimmer-Taste /
Dimmer button

	I-DIMMER-D1-10 8031414877959 FANEU00001592	
D1-10 Dimmer Dimmbereich 1%-100% 1-10V 40mA	D1-10 dimmer Dimming range 1%-100% 1-10V 40mA	22,5 × 22,5 × 48,6 mm
	I-DIMMER-D1-10S 8031414896257 FANEU00001593	
D1-10 Dimmer Dimmbereich 1%-100% 1-10V 40mA	D1-10 dimmer Dimming range 1%-100% 1-10V 40mA	83,5 × 83,5 × 44 mm
	I-DIMMER-D350S 8031414896264 FANEU00001594	
Dimmer mit Phasenanschnitt 220-240VAC 10-350W 1.5A	Trailing edge dimmer 220-240VAC 10-350W 1.5A	83,5 × 83,5 × 44 mm

NOTFAHRER / EMERGENCY DRIVER

	I-DRIVER-EMERGENCY 8031414864751 FANEU00001648	
Not-Driver 6-60 V 400-40 mA 4W 180 min Batterie 3,6 V 3,0 Ah Ni-Cd	Emergency driver 6-60V 400-40mA 4W 180Min Battery 3,6V 3.0Ah Ni-Cd	160 × 38 × 28 mm
	I-DRIVER-HELP 8031414862559 FANEU00001654	
Not-Driver Ausgangsspannung 10-120V Eingangsspannung 85-265V 3-40 W, Notfall 120 min 18650 Li-Ionen-Batterie 3,7 V 2.4Ah	Emergency driver Output Voltage 10-120V Input Voltage 85-265V 3-40W. emergency 120 min. 18650 Li-Ion Battery. 3,7V 2.4Ah	131 × 55 × 21 mm
	I-DRIVER-HELP-HV 8031414882595 FANEU00001655	
Notausgang Spannung 230V AC, geeignet für:	Emergency output voltage 230V AC, suitable for:	160 × 38 × 28 mm
2,5W Notversorgung 3 Stunden Notbetrieb	2,5W emergency power 3 hours emergency time	
3,5W Notversorgung 2 Stunden Notbetrieb	3,5W emergency power 2 hours emergency time	
5W Notversorgung 1,5 Stunden Notbetrieb	5W emergency power 1,5 hours emergency time	
Batterie 18650 LiFePO4 6,4 V 1500 mAh	Battery 18650 LiFePO4 6.4V 1500mAh	

DIMMER

<p>Dimmer für LED-Streifen 12-24-48V / Dimmer for 12-24-48V LED Strip</p>		<p>DIM-PUSH-CV 8031414939183 FANEU00027728</p> <p>Der Dimmer PUSH-CV ist ein PWM-Dimmer mit extrem niedriger Spannung von 12, 24 und 48V DC und für die Steuerung von LED-Streifen und dimmbaren PWM-LED-Lasten geeignet. Der Dimmer kann über Drucktaste (N/O, Schließer) gesteuert werden, 0-10 V oder 1-10 V über aktiven Stellantrieb (der daher eine variable Spannung zwischen 0 und 10V erzeugt) und Potentiometer mit 100k. In der Einschaltphase ist der PUSH-CV in der Lage, das Eingangssystem zu erkennen und sich automatisch für den angeschlossenen Steuereingang zu konfigurieren.</p>	<p>The PUSH-CV dimmer is a low voltage 12, 24, and 48V DC PWM dimmer suitable for controlling LED strips and dimmable PWM LED loads. The dimmer can be controlled via a push button (N/O normally open), 0-10V or 1-10V from an active actuator (which generates a variable voltage between 0 and 10V) and a 100k potentiometer. Upon powering on, the PUSH-CV is capable of recognizing the input system and automatically configuring itself for the connected control input.</p>	48 × 48 × 22,5 mm	
		<p>DIM-DALI2-CV-M2 8031414939190 FANEU00027729</p> <p>PWM-Dimmer mit extrem niedriger Spannung von 12, 24 und 48V DC und für die Steuerung von LED-Streifen und dimmbaren PWM-LED-Lasten geeignet. Geeignet für die Steuerung von Led-Streifen mit 12/24/48V über die Haustechniksysteme Bticino/Vimar mit Ausgang mit Phasenanschnitt. Steuerbar mittels: - BUS DALI oder DALI2 - Taste (N/O, Schließer) mit Netzspannung oder 12-24-48V - Analoges Signal 0-10V oder 1-10V über aktiven (der daher eine variable Spannung zwischen 0 und 10V erzeugt) oder passiven Stellantrieb - Potentiometer mit 47 KOhm - Anwesenheitssensor</p>	<p>PWM dimmer for low voltage 12, 24, and 48V DC suitable for controlling LED strips and dimmable PWM LED loads. Suitable for controlling 12/24/48V LED strips from Bticino/Vimar home automation systems with phase-cut output. Controllable via: - DALI or DALI2 bus - Button (N/O normally open) at mains voltage or 12-24-48V - Analog signal 0-10V or 1-10V from an active actuator (which generates a variable voltage between 0 and 10V) or passive - 47KOhm potentiometer - Presence sensor</p>	48 × 48 × 22,5 mm	
		<p>DIM-PUSH-4CV 8031414939206 FANEU00027730</p> <p>PUSH-Eingang Konstantspannungsausgang PWMPUSH input Constant voltage PWM output - Dimmer mit vier getrennten monochromen Ausgängen mit vier Eingängen - Push und Bluetooth-Steuerung - Anzeige-LED der korrekten Versorgung</p>	<p>Dimmer with four separate monochromatic outputs, four - Push inputs, and Bluetooth control - LED indicator for correct power supply</p>	90 × 71 × 32,2 mm	
		<p>DIM-DALI-4CV 8031414939213 FANEU00027731</p> <p>DALI-Eingang Konstantspannungsausgang PWMDALI Input Constant Voltage PWM Output - Dimmer mit vier getrennten monochromen Ausgängen mit Eingang DALI DT6</p>	<p>Dimmer with four separate monochromatic outputs with DALI DT6 input</p>	71 × 90 × 32,2 mm	
	<p>Dimmer für LED-Streifen 230V oder dimmbare LED-Glühlampen / Dimmer for 230V LED Strips or dimmable LED bulbs</p>		<p>DIM-PUSH-230-AI 8031414939220 FANEU00027732</p> <p>PUSH-Eingang Phasenanschnittausgang ohne Notwendigkeit der Änderung der Hausanlage.</p>	<p>Push entry, phase-cut output without the need to modify the home system.</p>	22 × 45 × 40 mm
			<p>DIM-PUSH230-500-AI 8031414939237 FANEU00027733</p> <p>PUSH-Eingang Phasenanschnittausgang - Kompakte Abmessungen - Optimierter Phasenanschnitt für LED-Streifen mit Netzspannung - Versorgungsbereich: 80÷230V AC 50/60Hz - Ausgangsleistung 220W A 110V, 440W A 220V, 500W A 230V - Max. ohmsche Last 1A</p>	<p>Input PUSH Phase-cut Output - Compact dimensions - Phase-cut optimized for mains voltage LED STRIP - Power range: 80÷230V AC 50/60Hz - Output power: 220W at 110V, 440W at 220V, 500W at 230V - Maximum resistive load 1A</p>	48 × 48 × 22,8 mm
			<p>DIM-PUSH230-350-AI 8031414939244 FANEU00027734</p> <p>PUSH-Eingang Phasenanschnittausgang - Kompakte Abmessungen - Optimierter Phasenanschnitt für LED-Streifen mit Netzspannung - Versorgungsbereich: 80 ÷ 230V AC 50/60Hz - Ausgangsleistung 110W bei 110V, 220W bei 220V, 230W bei 230V - Max. ohmsche Last 1A</p>	<p>Input PUSH Phase-cut Output - Compact dimensions - Phase-cut optimized for mains voltage LED STRIP - Power range: 80÷230V AC 50/60Hz - Output power: 220W at 110V, 440W at 220V, 500W at 230V - Maximum resistive load 1A</p>	48 × 48 × 22,8 mm

UMRICHTER / CONVERTERS

	<p>DIM-DALI230-AI 8031414939251 FANEU00027735</p> <p>DALI2-Eingang Phasenanschnittausgang - Dimmer Phasenanschnittausgang mit DALI2-Eingang - AI Edge-Ausgang mit MOSFET - Ausgangsleistung 110W bei 110V, 220W bei 220V, 230W bei 230V - Max. ohmsche Last 1A</p>	<p>DALI2 Input Phase Cut Output - Phase cut dimmer with DALI2 input - AI Edge output with MOSFET - Power delivered: 110W at 110V, 220W at 220V, 230W at 230V - Maximum resistive load: 1A</p>	48 × 48 × 22,8 mm
	<p>DIM-DALI230-500-AI 8031414939268 FANEU00027736</p> <p>DALI2-Eingang Phasenanschnittausgang Dimmer DIN-SCHIENE, Phasenanschnittausgang mit Push-Eingang, DALI2 - Trailing Edge-Ausgang mit MOSFET - Versorgungsbereich: 80 ÷ 230V AC 50/60Hz - Max. Ausgangsleistung Version DALI2-230V-500W-AI: 500W</p>	<p>DALI2 Input Phase Cut Output - DIN Rail Dimmer, phase cut output with Push input, DALI2 - Trailing Edge output with MOSFET - Power supply range: 80÷230V AC 50/60Hz - Maximum power delivered for version DALI2-230V-500W-AI: 500W</p>	105 × 90 × 58 mm
	<p>DIM-DALI230-1KW-AI 8031414939275 FANEU00027737</p> <p>DALI2-Eingang Phasenanschnittausgang - Dimmer DIN-SCHIENE, Phasenanschnittausgang mit Push-Eingang, DALI2 - Trailing Edge-Ausgang mit MOSFET - Versorgungsbereich: 80 ÷ 230V AC 50/60Hz - Max. Ausgangsleistung Version DALI2-230V-1KWW-AI: 1000W</p>	<p>DALI2 Input Phase Cut Output - DIN Rail Dimmer, phase cut output with Push input, DALI2 - Trailing Edge output with MOSFET - Power supply range: 80÷230V AC 50/60Hz - Maximum power delivered for version DALI2-230V-1KWW-AI: 1000W</p>	105 × 90 × 58 mm
	<p>DIM-PHASECUT-DALI 8031414939282 FANEU00027738</p> <p>Phasenanschnittausgang Ausgang DALI BROADCAST - Schnittstelle mit Phasenanschnittausgängen für Netzteile und dimmbare Lampen mit DALI-Eingang - Netzteil des DALI-Busses, bis zu 16 Geräte eingebaut - Konvertierungsfunktion von Phasenanschnitt (z. B. Haustechnik Bticino/Vimar) auf DALI</p>	<p>Phase-cut input DALI BROADCAST output - Interface with phase-cut inputs for power supplies and dimmable lamps with DALI input - Integrated DALI bus power supply for up to 16 devices - Operation of conversion from phase-cut (e.g., Bticino/Vimar home automation) to DALI</p>	40 × 80 × 24,5 mm
	<p>DIM-010-230-1KW 8031414939299 FANEU00027739</p> <p>Dimmer 230V 1CH PUSH 010V 1000W</p>		105 × 90 × 58 mm
	<p>DIM-DALI2-IRELE 8031414939305 FANEU00027740</p> <p>DALI-Eingang Relaisausgang - Stellantrieb DALI2 Relaisausgang bistabil - Versorgung über DALI-Bus</p>	<p>DALI Input Relay Output - DALI2 Actuator Relay Output Bistable - Power Supply from DALI Bus</p>	48 × 48 × 22,8 mm
	<p>DIM-WIFI-16DALI 8031414939312 FANEU00027741</p> <p>Dimmer für Netzteile DALI Eingang PUSH / Wi-Fi oder Bluetooth OIKOS - DALI-Ausgang an bis zu 16 Geräte adressierbar - Kompatibel mit Sprachassistenten Amazon Alexa und Google Nest im WI-FI-Modus</p>	<p>Dimmer for DALI power supplies with PUSH / Wifi or Bluetooth input OIKOS - DALI output addressable up to 16 devices - Compatible with Amazon Alexa and Google Nest voice assistants in WIFI mode</p>	40 × 80 × 24,5 mm
	<p>DIM-WIFI-DALI 8031414939329 FANEU00027742</p> <p>Dimmer für Netzteile DALI Eingang PUSH / Wi-Fi oder Bluetooth OIKOS - DALI-Broadcast-Ausgang für bis zu 16 Geräte - Kompatibel mit Sprachassistenten Amazon Alexa und Google Nest im WI-FI-Modus</p>	<p>DALI dimmer for PUSH / Wifi or Bluetooth OIKOS power supplies - DALI Broadcast output for up to 16 devices - Compatible with Amazon Alexa and Google Nest voice assistants in WIFI mode</p>	40 × 80 × 24,5 mm

REMOTE CONTROLS

ÜBERSICHT DER STEUERKOMPONENTEN / CONTROLS COMPONENTS SCHEME

Dieser Abschnitt unseres Katalogs ist den Empfängern und Controllern für Streifen und Beleuchtungsprodukte mit Niederspannung gewidmet und soll Ihre Wohnung in eine intelligente und interaktive Umgebung verwandeln.

Unsere Produktpaletten an Zubehörteilen ist dazu konzipiert, allen Beleuchtungsanforderungen gerecht zu werden, gleich ob es sich um monochrome Beleuchtung, CCT, RGB oder RGB+CCT handelt. Jedes Produkt ist darauf ausgelegt, Vielseitigkeit und Benutzerfreundlichkeit zu garantieren und gestattet es Ihnen so, dank der mit IP-Isolierung ausgestatteten Modelle einzigartige und individuell gestaltete Atmosphären in jeder Umgebung zu schaffen, gleich ob im Innen- oder Außenbereich.

Für diejenigen, die nach einer hochentwickelten Steuerung Ausschau halten, bieten wir auch Artikel an, die die Steuerung der Beleuchtung mittels Wi-Fi ermöglichen. Mit einer dedizierten App und der Möglichkeit der Verwendung von Sprachbefehlen können Sie die Lichtstärke Ihrer Streifen und anderer Beleuchtungsprodukte direkt über Ihr Smartphone oder Sprachassistenten einschalten, ausschalten und regulieren.

Erkunden Sie unseren Katalog und erfahren Sie, wie unsere Empfänger und Controller Ihr Beleuchtungserlebnis verbessern können und so Ihr Zuhause smarter, funktioneller und einladender machen.

This section of our catalog is dedicated to receivers and controllers for strips and low-voltage lighting products, designed to make your home an intelligent and interactive environment.







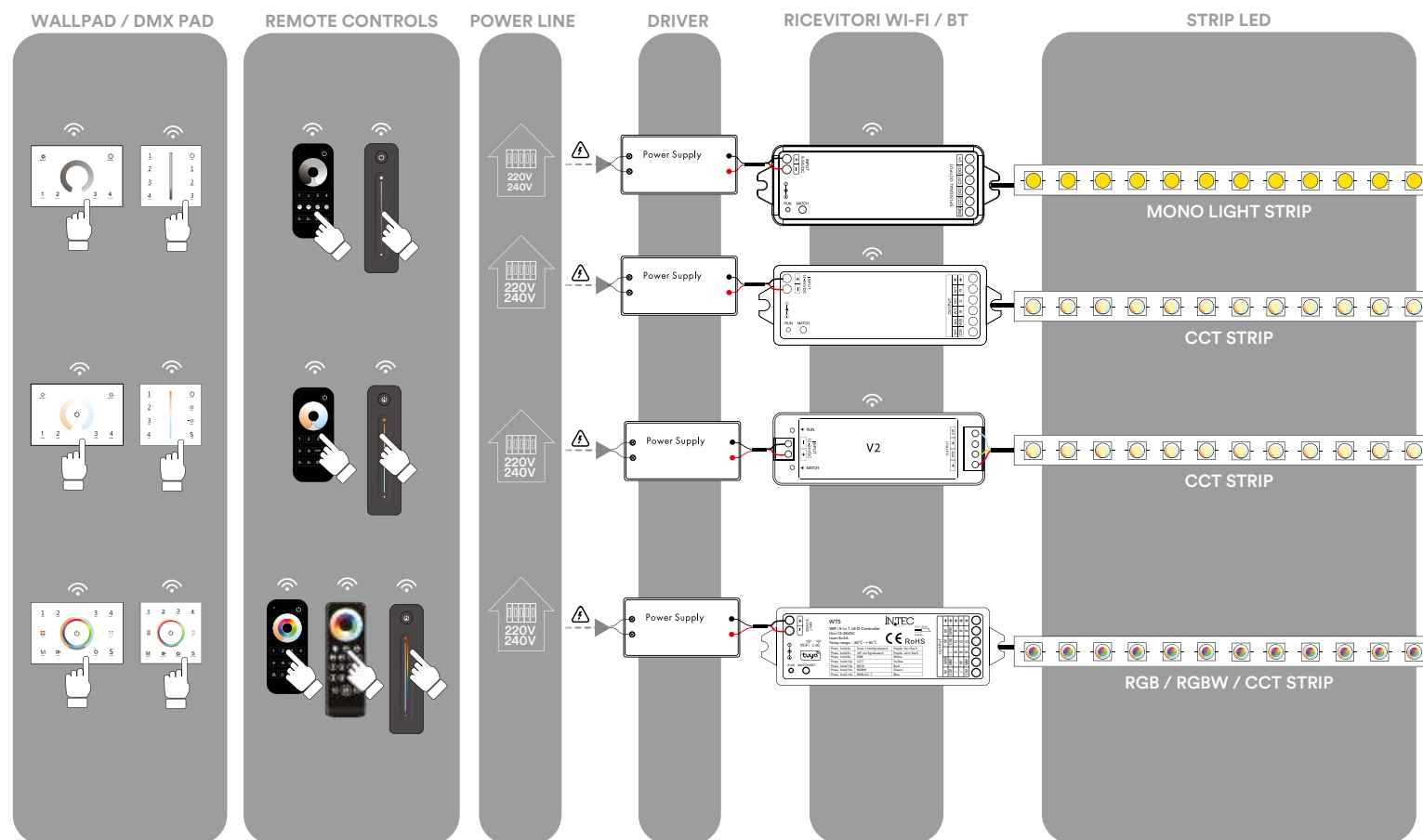







Our range of accessories is crafted to meet every lighting need, whether it's monochromatic lighting, CCT, RGB, or RGB+CCT. Each product is designed to ensure versatility and ease of use, allowing you to create unique and personalized atmospheres in any space, both indoors and outdoors, thanks to models equipped with IP isolation.

For those seeking advanced control, we also offer items that allow for managing lights via Wi-Fi. With a dedicated app and the ability to use voice commands, you can turn on, turn off, and adjust the brightness of your strips and other lighting products directly from your smartphone or through voice assistants.











Explore our catalog and discover how our receivers and controllers can enhance your lighting experience, making your home smarter, more functional, and welcoming.







REMOTE CONTROL

	RF-WALLPAD-1CH 8031414876426 FANEU00008460 Wallpad RF 2.4G 4-Zonen-Dimmersteuerung 1 Kanal 2xAAA nicht enthalten	RF 2.4G wallpad dimming light 4 zone 1 channel 2xAAA not included	86 × 86 × 36,5 mm	
	RF-WALLPAD-2CH 8031414876433 FANEU00008461 Wallpad RF 2.4G CCT weiß, dynamisch 4 Zonen 2 Kanäle 2xAAA nicht enthalten	RF 2.4G wallpad CCT adjustable white 4 zone 2 channels 2xAAA not included	86 × 86 × 36,5 mm	
	RF-WALLPAD-5CH 8031414876440 FANEU00008462 Wallpad RF 2.4G RGB/RGBW/RGB+CCT 4 Zonen 5 Kanäle 2xAAA nicht enthalten	RF 2.4G wallpad RGB/RGBW/RGB+CCT 4 zone 5 channels 2xAAA not included	86 × 86 × 36,5 mm	 
	RF-DMXPAD-1CH 8031414876457 FANEU00008450 Wallpad RF 2.4G 4-Zonen-Dimmersteuerung 1 Kanal 230V mit Protokoll DMX 512 anschließbar	RF 2.4G wallpad dimming light 4 zone 1 channel 230V linkable with DMX512 protocol	120 × 80 × 37 mm universelle Größe für Anschlussdose 503 / universal size for 503 box	
	RF-DMXPAD-2CH 8031414876464 FANEU00008451 Wallpad RF 2.4G CCT, weiß, dynamisch 4 Zonen 2 Kanäle 230V mit Protokoll DMX 512 anschließbar	RF 2.4G wallpad CCT adjustable white 4 zone 2 channels 230V collegabile con protocollo DMX 512	120 × 80 × 37 mm universelle Größe für Anschlussdose 503 / universal size for 503 box	
	RF-DMXPAD-5CH 8031414876471 FANEU00008452 Wallpad RF 2.4G RGB/RGBW/RGB+CCT 4 Zonen 5 Kanäle 230V mit Protokoll DMX 512 anschließbar	RF 2.4G wallpad RGB/RGBW/RGB+CCT 4 zone 5 channels 230V collegabile con protocollo DMX 512	120 × 80 × 37 mm universelle Größe für Anschlussdose 503 / universal size for 503 box	 

REMOTE CONTROL

	RF-COM-1CH 8031414876402 FANEU00008439 Fernbedienung RF 2.4G 4-Zonen-Dimmersteuerung 1 Kanal 2xAAA nicht enthalten	RF 2.4G remote control dimming light 4 zone 1 channel 2xAAA not included	
	RF-COM-2CH 8031414876396 FANEU00008441 Fernbedienung RF 2.4G CCT weiß, dynamisch 4 Zonen 2 Kanäle 2xAAA nicht enthalten	RF 2.4G remote control CCT adjustable white 4 zone 2 channels 2xAAA not included	
	RF-COM-5CH 8031414876419 FANEU00008443 Fernbedienung RF 2.4G RGB/RGBW/RGB+CCT 4 Zonen 2 Kanäle 2xAAA nicht enthalten	RF 2.4G remote control CCT adjustable white 4 zone 2 channels 2xAAA not included	 
	RF-COM-5CH-1ZN 8031414897919 FANEU00008444 Steuerung RGB+CCT 1 Zone Batterie CR2032	RGB+CCT Remote Control 1 zone Battery CR2032	
	RF-COM-1CH-1ZN 8031414897896 FANEU00008440 Helligkeitssteuerung 1 Zone Batterie CR2032	Brightness Remote Control 1 zone Battery CR2032	
	RF-COM-2CH-1ZN 8031414897902 FANEU00008442 Steuerung CCT 1 Zone Batterie CR2032	CCT Remote Control 1 zone Battery CR2032	
	RF-COM-5CH-8ZN 8031414897926 FANEU00008445 Fernbedienung RF 2.4G RGB/RGBW/RGB+CCT 8 Zonen Batterien nicht enthalten: 2xAAA nicht enthalten	8 scene 2xAAA non include RF Remote Controller 8 zones 8 scenes Battery: 2xAAA not included	

REMOTE CONTROL

	RF-RICEVITORE-1CH 8031414897933 FANEU00008454 Empfänger RF 2.4G 1 Kanal (K) für WALLPAD FERNBEDIENUNG WALLPAD DMX für EINE FARBE verwendbar Eingang 8,5 A 12-24V Ausgang 1K 8 A - 40W/96W/192W/288W	RF 2.4G receiver box 2 channels for WALLPAD RADIOCOMANDO WALLPAD DMX usable for SINGLE COLOR Input 8.5A 12-24V Output 1CH 8A - 40W/96W/192W/288W	97 × 33 × 18 mm
	RF-RICEVITORE-2CH 8031414876488 FANEU00008455 Empfänger RF 2.4G 2 K für WALLPAD FERNBEDIENUNG WALLPAD DMX für EINE FARBE/CCT verwendbar Eingang 10,5 A 12-24V Ausgang 2K; 5 A/K - 2x(60-120)W	RF 2.4G receiver box 2 channels for WALLPAD RADIOCOMANDO WALLPAD DMX usable for SINGLE COLOR/CCT Input 10.5A 12-24V Output 2CH;5A/CH - 2x(60-120)W	97 × 33 × 18 mm
	RF-RICEVITORE-5CH 8031414876495 FANEU00008457 Empfänger RF 2.4G 5 Kanäle für WALLPAD FERNBEDIENUNG WALLPAD DMX für EINE FARBE/RGB/RGBW/RGB+CCT verwendbar Eingang 15,5 A 12-24V Ausgang 5K; 3 A/K - 5x(36-72)W	F 2.4G receiver box 5 channels for WALLPAD RADIOCOMANDO WALLPAD DMX usable for SINGLE COLOR/RGB/RGBW/RGB+CCT Input 15.5A 12-24V Output 5CH;3A/CH - 5x(36-72)W	114 × 38 × 20 mm
	RF-RICEVITORE-5CH-PRO 8031414882724 FANEU00008458 Empfänger RF 2.4G 5 Kanäle für WALLPAD FERNBEDIENUNG WALLPAD DMX für EINE FARBE/CCT/RGB/RGBW/RGB+CCT verwendbar Eingang 30,5 A 12-48V Ausgang 5K;6A/K 12/24V 5 x (72-144)W 5K;4A/K 36/48V - 5x(144-192)W	RF 2.4G receiver box 5 channels for WALLPAD RADIOCOMANDO WALLPAD DMX usable for SINGLE COLOR/CCT/RGB/RGBW/RGB+CCT Input 30.5A 12-48V Output 5CH;6A/CH 12/24V 5x(72-144)W 5CH;4A/CH 36/48V - 5x(144-192)W	179 × 56 × 30 mm
	RF-RICEVITORE-4CH-IP67 8031414882717 FANEU00008456 Empfänger RF 2.4G 4 Kanäle für WALLPAD FERNBEDIENUNG WALLPAD DMX für EINE FARBE/RGB/RGBW verwendbar Eingang 20,5 A 12-36V Ausgang 4K; 5 A/K - 4x(60-180)W	RF 2.4G receiver box 4 channels for WALLPAD RADIOCOMANDO WALLPAD DMX usable for SINGLE COLOR/RGB/RGBW Input 20.5A 12-36V Output 4CH;5A/CH - 4x(60-180)W	176 × 78 × 38 mm

REMOTE CONTROL

	RF-WIFI-CONTROL-5CH 8031414878710 FANEU00008463 Empfänger WI-FI + RF 2.4G 5 Kanäle für WALLPAD FERNBEDIENUNG WALLPAD DMX für EINE FARBE/CCT/RGB/RGBW/RGB+CCT verwendbar Eingang 15,5 A 12-24V Ausgang 5K; 3 A/K - 5x(36-72)W	Wi-Fi + RF 2.4G receiver box 5 channels for WALLPAD RADIOCOMANDO WALLPAD DMX usable for SINGLE COLOR /CCT/RGB/RGBW/RGB+CCT Input 15.5A 12-24V Output 5CH;3A/CH - 5x(36-72)W	114 × 38 × 20 mm
	RF-BT-CONTROL-5CH 8031414878826 FANEU00008438 Empfänger Bluetooth + RF 2.4G 5 Kanäle für WALLPAD FERNBEDIENUNG WALLPAD DMX für EINE FARBE/CCT/RGB/RGBW/RGB+CCT verwendbar Eingang 15,5 A 12-24V Ausgang 5K; 3 A/K - 5x(36-72)W	Bluetooth + RF 2.4G receiver box 5 channels for WALLPAD RADIOCOMANDO WALLPAD DMX usable for SINGLE COLOR /CCT/RGB/RGBW/RGB+CCT Input 15.5A 12-24V Output 5CH;3A/CH - 5x(36-72)W	114 × 38 × 20 mm
	RF-AMPLIFICATORE-5CH 8031414882700 FANEU00008437 5-Kanal-Verstärker Eingang 25,5 A 12-24VDC Ausgang 5K; 5 A/K 12/24V - 5x(60-120)W	5 Channel amplifier Input 25.5A 12-24VDC Output 5CH;5A/CH 12/24V - 5x(60-120)W	107 × 75 × 24,5 mm
	RF-AMPLIFICATORE-2CH 8031414882694 FANEU00008436 2-Kanal-Verstärker Eingang 16,5 A 12-36 VDC Ausgang 2K; 8 A/K 12/36V - 2x(96-288)W	2 Channel amplifier Input 16.5A 12-36VDC Output 2CH;8A/CH 12/36V - 2x(96-288)W	175 × 45 × 27 mm
	RF-RIPETITORE 8031414882731 FANEU00008459 Signalverstärker RF 2.4G AC100-240V DC 12-24V	RF 2.4G signal Repeater AC100-240V DC12-24V	52 × 52 × 26 mm

SPI CONTROLLER

Controller und Empfänger für digitale LED-Streifen: dazu konzipiert, eine genaue und dynamische Steuerung jedes einzelnen Pixels zu garantieren. In diesem Abschnitt finden Sie eine große Auswahl an innovativen Lösungen, die es ermöglichen, außerordentliche und individuell abgestimmte Beleuchtungseffekte zu erzielen.

Unsere spezifischen Controller für Lauflichteffekte sind ideal, um fließende und dynamische Lichtabfolgen zu erzeugen. Diese Geräte sind **perfekt für Anwendungen, die kontinuierliche und ansprechende Lichtbewegungen erfordern wie architektonische Dekorationen und künstlerische Installationen.**

Für diejenigen, die Treppen auf funktionelle und dekorative Weise beleuchten möchten, bieten wir eigens für diesen Verwendungsbereich ausgelegte Controller an. Diese Geräte garantieren eine sichere und eindrucksvolle Beleuchtung, indem sie die Lichtspiele mit dem Schritt des Benutzers synchronisieren und so eine einladende und sichere Atmosphäre schaffen.

Tauchen Sie mit unseren hochmodernen Controllern in die Welt der RGB-Lichtspiele ein, die es gestatten, Farben und Beleuchtungseffekte mittels App, Fernbedienung oder DMX einzustellen und zu steuern. Gleich, ob es darum geht, mitreißende Atmosphären für Events zu erzeugen oder einen Hauch von Magie für Innenbereiche hinzuzufügen, bieten diese Controller eine unvergleichliche Flexibilität und gestatten es Ihnen, jede kreative Idee zum Leben zu erwecken.

Controllers and receivers for digital LED strips: designed to ensure precise and dynamic control of each individual pixel. In this section, you will find a wide range of innovative solutions that enable the creation of extraordinary and customized lighting effects.

Our controllers specifically designed for run effects are ideal for creating smooth and dynamic light sequences. These devices are **perfect for applications that require continuous and captivating light movements, such as architectural decorations and artistic installations.**





For those looking to illuminate staircases in a functional and decorative way, we offer controllers specifically designed for this application. These devices ensure safe and evocative lighting, synchronizing light effects with the user's steps, creating a welcoming and secure atmosphere.

Dive into the world of RGB light shows with our advanced controllers, which allow you to set and manage colors and lighting effects via app, remote control, or DMX. Whether it's creating engaging atmospheres for events or adding a touch of magic to indoor spaces, these controllers offer unparalleled flexibility, enabling you to bring any creative idea to life.



SPI CONTROLLER

	<p>RF-PIR-CONTROL-SPI 8031414927326 FANEU00008453</p> <p>Der SPI-Controller für RGB- oder Weißlicht steuert LED-Lichter über Bewegungssensoren und Tasten. Er kann zwei digitale LED-Lichtgruppen steuern und unterstützt dabei verschiedene integrierte Schaltkreise (IC) und gestattet es, den Typ des Schaltkreises und die Farbreihenfolge zu wählen. Dies ist für die Treppenbeleuchtung nützlich, da so verschiedene Situationen wie durchgehende Beleuchtung oder Farbwechsel geboten werden. Es können mehrere Controller für eine zentralisierte Steuerung angeschlossen und so Farben, Geschwindigkeit und Helligkeit der Lichter reguliert werden.</p> <p>Input voltage: 5-24VDC; Output type: 2*SPI(TTL), Input type: PIR sensor + Push button Pixel number: Max 960 Comes with 2 PIR Sensors(ER-C), 1 daylight sensor and 2 PIR sensor extension line(5m) Compatible with 28 kinds driving ICs</p>	<p>The SPI controller for RGB or white lights manages LED lights through motion sensors and buttons. It can control two groups of digital LED lights, supporting various types of integrated circuits (IC) and allowing the selection of the IC type and the color order. It is useful for stair lights, offering different modes such as continuous light or color transitions. It can connect multiple controllers for centralized control and allows for the adjustment of colors, speed, and brightness of the lights.</p>	186 × 86 × 25 mm
	<p>RF-CONTROL-32CH-SPI 8031414927364 FANEU00008447</p> <p>Der Controller für Treppenbeleuchtung ist ein Gerät, das zum Einschalten des Lichts einen Bewegungssensor (PIR) verwendet. Er kann LED-Streifen mit Niederspannung mit 32 Kanälen steuern, von denen jeder in der Lage ist, bis zu 1A Strom zu verwalten. Er unterstützt verschiedene RGB-LED-Streifen und verfügt für eine mühelose Bedienung über ein OLED-Display mit 3 Tasten. Er bietet vier Beleuchtungsarten mit Einstellung von Farbe, Geschwindigkeit und Helligkeit.</p> <p>Input voltage: 5-24VDC; Output voltage: 32 x (5-24)VDC; 32CH, 1A/CH; 32 x (5-24)W Output type: Constant voltage + SPI(TTL) Reverse Polarity Protection Comes with 2 PIR Sensors(ER-C) and 1 daylight sensor, 2 PIR sensor extension line(5m)</p>	<p>The stair light controller is a device that uses a motion sensor (PIR) to turn on the lights. It can control low-voltage LED strips with 32 channels, each capable of handling up to 1A of current. It supports various types of RGB LED strips and features an OLED display with 3 buttons for easy management. It offers four lighting modes, with adjustments for color, speed, and brightness.</p>	186 × 86 × 25 mm
	<p>RF-AMPLIFIER-SPI-6CH 8031414941070 FANEU00027787</p> <p>Für den Empfang von Signalen von einem Controller konzipiertes Gerät, indem die Informationen verstärkt werden, um gleichzeitig mehrere LED-Streifen zu verwalten. Es ist möglich, die Farben und die Beleuchtungsarten zu synchronisieren. Mit RF-CONTROL-SPI kompatibel.</p> <p>5-24VDC; 30A max. Input signal: SPI(TTL) (1 group) Output signal: SPI(TTL) (6 groups) Reverse polarity protection</p>	<p>Device designed to receive signals from a controller, amplifying the information to simultaneously manage multiple LED strips. It is possible to synchronize colors and lighting modes. Compatible with RF-CONTROL-SPI.</p>	145 × 75 × 35 mm

	<p>LED-FORREST-SPI 8031414927319 FANEU00006234</p> <p>Controller für Pixel-to-Pixel-LED-Streifen mit "LAUFLICHT"-Effekt. Starten der Show und Ausschalten über N/O-Taste. Kompatibel mit LED-Streifen Pixel to Pixel, SPI WS2811 oder anderen Protokollen. Streifenlänge, Richtung und Geschwindigkeit mittels APP NewlabForrest programmierbar. Synchronisationsausgang für multiple Lauflichteffekte.</p>	<p>Pixel to Pixel LED strip controller with "RUN" effect. Show start and turn off via N/O button. Compatible with Pixel to Pixel SPI WS2811 LED strips or other protocols. Strip length, direction and speed programmable via NewlabForrest APP. Synchronization output for multiple chasing effects.</p>	97 × 33 × 18 mm
	<p>RF-CONTROL-SPI 8031414927340 FANEU00008448</p> <p>Kompakter Multi-Pixel-Controller, der die Steuerung von farbigen LED-SPI-Streifen auf einfache und praktische Weise gestattet. Kompatibel mit RF-Fernbedienung. Der Controller bietet 40 verschiedene dynamische Beleuchtungsmöglichkeiten. Diese umfassen Effekte wie Lauflicht, Verfolgung, Fluss und fließenden Farbverlauf, was die Beleuchtung angenehmer und abwechslungsreicher macht.</p> <p>5-24VDC; 8A Input signal: RF2.4G; work with R9 remote; Output signal: SPI (TTL) Control dots: 1024 Dynamic mode: 32 kinds color light, 8 kinds white light Compatible with 49 kinds of Driving Ics</p>	<p>Compact multi-pixel controller that allows for easy and practical control of colored SPI LED strips. Compatible with RF remote control. The controller offers 40 different dynamic lighting modes. These include effects such as running, chasing, flowing, and smooth color transitions, making the lighting much more enjoyable and varied.</p>	97 × 33 × 18 mm
	<p>RF-WIFI-CONTROL-SPI 8031414927333 FANEU00008464</p> <p>5-24VDC; 8A Input signal: Tuya APP + RF 2.4GHz; Output signal: SPI(TTL) x 2 Control dots: Max.1000 Rich dynamic effects, Multiple music rhythms, Wireless remote control Compatible with 49 kinds of RGB or RGBW LED strips</p>	<p>Compatible ICs: TM1803, TM1804, TM1809, TM1812, UCS1903, UCS1909, UCS1912, SK6813, UCS2903, UCS2909, UCS2912, WS2811, WS2812, WS2813, WS2815, TM1829, TLS3001, TLS3002, GW6205, MBI6120, TM1814B(RGBW), SK6812(RGBW), WS2813(RGBW), WS2814(RGBW), UCS8904B(RGBW), LPD6803, LPD1101, D705, UCS6909, UCS6912, LPD8803, LPD8806, WS2801, WS2803, P9813, SK9822, TM1914A, GS8206, GS8208, UCS2904, SM16804, SM16825, SM16714(RGBW), UCS2603, UCS5603, SM16714D, SM16703P, UCS7604(RGBW), UCS7804(RGBW).</p>	114 × 38 × 20 mm
	<p>RF-DMX-DECODER-SPI 8031414927357 FANEU00008449</p> <p>Der Decoder DMX512 mit SPI und RF-Controller ist ein Gerät, das die Steuerung verschiedener RGB- oder RGBW-SPI-LED-Streifen ermöglicht. Er gestattet die Einstellung von Chiptyp und Farbreihenfolge (rot, grün, blau). Es sind drei verschiedene Betriebsarten möglich: DMX (zur professionellen Steuerung), Stand-alone (unabhängig) und RF (mit Fernbedienung). Im DMX-Modus können Sie eine Adresse für die Steuerung eingeben, während Sie im Stand-alone-Modus Betriebsart, Geschwindigkeit und Helligkeit über die Tasten einstellen können. Mit der RF-Fernbedienung können Sie die Einstellungen mühelos aus der Ferne ändern. Das Gerät bietet außerdem 32 dynamische Beleuchtungsarten wie z. B. Lauflichteffekte.</p>	<p>The DMX512 decoder with SPI and RF controller is a device that allows you to control various types of RGB or RGBW SPI LED strips. It enables you to set the type of chip and the color order (red, green, blue). It can operate in three different modes: DMX (for professional control), stand-alone (independent), and RF (with remote control). In DMX mode, you can set an address for control, while in stand-alone mode, you can adjust the mode, speed, and brightness using the buttons. With the RF remote control, you can easily change the settings from a distance. The device also offers 32 dynamic lighting modes, such as running effects.</p>	170 × 50 × 23 mm
	<p>RF-COM-SPI 8031414927371 FANEU00008446</p> <p>RGB/RGBW RF Remote Controller 1 zone Battery: CR2032</p>	58,5 × 9 × 107 mm	

SENSOREN SENSORS

Industrielle
Bewegungssensoren /
Industrial motion
sensors



LED-SENSOR-TP
8031414879724
FANEU00007349

Load capacity
no limitation
220V - 240V



IP65

1 / function

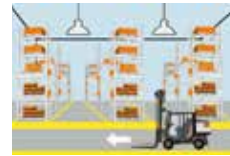

In ausreichend heller Umgebung schaltet sich die Lampe nicht ein, auch wenn Bewegung erfasst wird.

With sufficient ambient light, the light will not be switched on even if with motion signal.

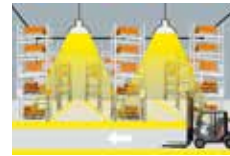

In schlecht beleuchteter Umgebung schaltet der Sensor die Lampe ein, sobald eine Bewegung erfasst wird.

With insufficient ambient light, the sensor switches on the light when motion is detected.

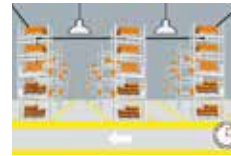

Nach der Wartezeit schaltet der Sensor die Lampe aus, wenn keine Bewegung erfasst wird.

After elapse of hold time, the sensor switches off the light when no motion is detected.



LED-SENSOR-REMOTE
8031414879717
FANEU00007348

Funkfernsteuerung für Industrielampen. Industrial sensor remote control.

SENSOREN SENSORS

An jedes
Beleuchtungsprodukt
anpassbare Sensoren /
Sensors compatible for
any lighting products



I-SENSORE-130
8031434401219
FANEU00003599

PIR-Sensor 230V
max. 1000 W 130°
Max. Abstand 12 m
Zeit 10 s - 4 min
Lux 2 - 2000
Winklige Zubehörbasis

PIR sensor 230V
max 1000W 130°
max 12m.
time 10 sec. - 4 min.
lux 2 - 2000
corner accessory base

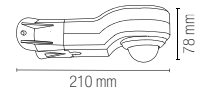

IP44



faneurope divisione F.A.N. EUROPE LIGHTING s.r.l. a socio unico

Agglomerato A.S.I

NAPOLI
Località Bosco Fangone
80035 Nola (NA)

MILANO
Via Monzoro, 46
20007 Cornaredo (MI)

FRANCE
259 Rue de la Bandido lot 13,
34160 Castries, France

GERMANY
FAN EUROPE LIGHTING GmbH
Lichtpromenade 50, 59759 Arnsberg

info@faneurope.it
+39 081 3151017
+39 081 8210771

info@faneurope.it
+39 02 84345083

info@faneurope.it
+33 7 86659408

info@faneurope.it
+49 2242 9043022

www.faneurope.it



Download Catalogue



SMART INTEC

Download App Smart Intec on:



concept
DITRE IDEAS MAKERS

graphic artwork & photo editing
Ditre.com

photo
Quasarfoto.com

styling
Cristina Romanello
Gilda Zoggia

printed in Italy
Graficametelliana.com
March 2026

Das Unternehmen behält sich das Recht auf Änderungen der in diesem Katalog enthaltenen Produkte ohne jede Vorankündigung vor.
/
The company reserves the right to make changes to the products in this catalog without prior notice.



faneurope.it