

PV Link™ / S2501 Installation Manual

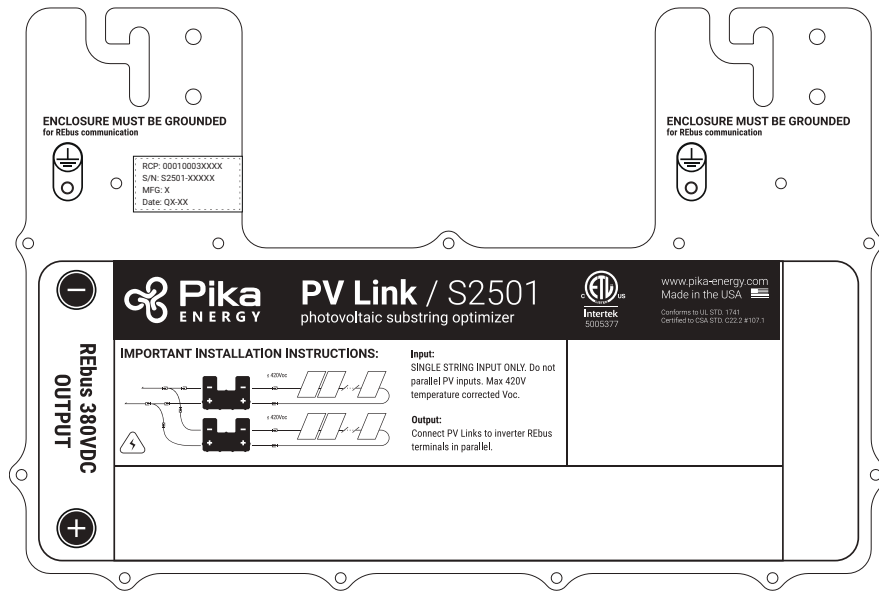

M00011-10

IMPORTANT SAFETY INSTRUCTIONS: SAVE THESE INSTRUCTIONS

This manual contains important instructions for the model S2501 PV Link optimizer/ power converter that shall be followed during installation and maintenance of the power converter.



WARNING: Electrical installation in the United States shall be done in accordance with all local electrical codes and/or the National Electric Code (NEC), ANSI/NFPA 70.

WARNING: Electrical installation in Canada shall be done in accordance with all local electrical codes and/or the Canadian Electrical Code.

WARNING: The S2501 unit is sealed at the factory, and contains no field-service-able parts. Do not open the unit.

CAUTION: The maximum ambient temperature rating of the S2501 is 70°C. When operating in high ambient temperature conditions, the unit attains high surface temperatures. The unit should be located and installed such that it is not expected to be contacted by persons.

GFI Information:

The S2501 incorporates an internal ground fault interrupt circuit. The circuit is designed to trip at 240mA of PV ground current +/- 40mA. Ground faults are indicated on the inverter LCD display.

Product Description and Specifications:

The S2501 PV Link is a 2500W maximum-power-point-tracking (MPPT) DC/DC converter designed to connect strings of PV modules to DC-coupled solar-storage systems, microgrids, nanogrids, and other distributed energy applications.

The S2501 is designed for attachment to standard PV racking. The unit is sealed in a type 3R enclosure at the factory. The S2501 incorporates safety features including ground fault and rapid shutdown capability. The S2501 is based on a single-stage, non-isolated boost converter that boosts PV input to a higher voltage and feeds it onto REbus, a DC bus.

The input to the S2501 is a series-connected string of standard PV modules not to exceed 420VDC. The output of the S2501 is designed to interface with Pika Energy's REbus products and other devices compatible with Pika's regulated 380VDC bus. The S2501 and other REbus-compatible equipment provides droop-mode power management enabling multiple units to connect in parallel on a common bus. The DC output also carries a 1.9MHz bi-directional powerline communication (PLC) protocol for communicating with inverters and other devices on REbus.

Rated power	2500W (Continuous)
Peak efficiency	99%
MPPT input voltage	60-360 VDC
Rated power input voltage	200-360 VDC
Max input voltage (VOC)	420V (Absolute Maximum)
Max output	420V (open circuit)
Nominal output	REbus 380VDC + data
Max output current	8A
Standby power	<1W
Topology	Boost converter
Protections	Ground-fault protection
Max operating temp	70° C
Enclosure	Type 3R
Weight	3.3kg (7.3lb)
Dimensions	390mm x 50mm x 243mm (15.4" x 2" x 9.6")

Mounting and connecting the unit:

Step 1: Determine Location

Guidelines for installation:

- Refer to Installation Design section to calculate maximum string length.
- In a system with multiple PV Links, each PV Link independently performs Maximum Powerpoint Tracking on the substring of modules connected to it. Therefore it is not necessary to match the number of modules, roof pitch, or orientation across all the substrings in an array.
- The modules within each substring should be of the same type, and all should be mounted at the same pitch and orientation.
- The ambient temperature rating of the S2501 is 70° C. When operating in hot weather, the surface of the unit can become too hot to touch. The unit should be located and installed to avoid inadvertent contact.
- Ensure at least 1" of clearance on all sides to allow sufficient air flow for cooling.
- Install PV Links close to the edge of the array for best cooling and easier access in case of service.
- PV Links can be installed in any orientation. Cooling will be most effective if fins are oriented vertically.
- Mount the unit at least 3' from the ground.

Step 2: Attachment and Grounding of the Unit

The S2501 incorporates an internal ground fault interrupt circuit. The circuit is designed to trip at 240mA of PV ground current +/- 40mA. Ground faults are indicated on the inverter LCD display. Proper grounding is necessary for REbus communication.

- Install the unit at the location determined in step 1 with the label facing up. The slots on the attachment flange of the unit accept fasteners up to M8 or 5/16" in diameter.
- For attachment to a grounded metal rail, use two rail-compatible fasteners. Use a WEEB clip (Wiley P/N: 30020098) or equivalent grounding washer between the rail and the attachment flange to penetrate the anodized coating on the rail. Torque fasteners to 10 N-m for M6 and 25N-m for M8, or per clip manufacturers' instructions.
- For attachment to non-metallic or non-grounded structures, use two fasteners appropriate to the structure. Connect *equipment grounding conductor* using a lug (ex. 6-14AWG Copper Set Screw Lug, McMaster P/N: 6923K31) or equivalent fastened to the grounding hole provided. Use bonding hardware only. Size  EGC per NEC requirements and torque per manufacturer specifications.

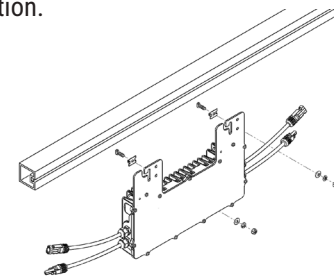

- For installations with multiple PV Links, note the location of each PV Link by serial number for future reference, and leave a permanent record of the layout with the inverter.





Step 3: Connecting to Inverter

Next, connect the output of each PV Link to the REbus DC microgrid and inverter.

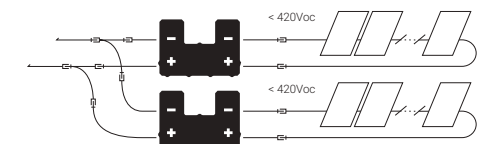
CAUTION: Connect the output of the S2501 to REbus-compatible devices (+/- 190VDC nominal regulated DC bus) only. Do not connect to conventional PV inverters or any other device.

CAUTION: Do not reverse the input and output or cross-wire polarity. To avoid confusion, complete wiring of PV Link output before installing PV modules.



- Connect multiple PV Link outputs in parallel. To connect in parallel, connect  (RE-) to  (RE-) and  (RE+) to  (RE+).
- Current adds when connecting units in parallel. The maximum output current of each S2501 is 8A. When wiring PV Link outputs to the inverter, observe temperature ratings and current-carrying capacity of the wire used, including appropriate NEC derating factors. Multiple home runs will be necessary in larger installations.
- Connect field wiring to PV Link with MC4 PV Connectors (Multi-Contact P/N: 32.0010P0001-UR/32.0011P0001-UR or equivalent).
- Mark positive REbus field wiring leads with red insulation or flagging. Mark negative REbus field wiring leads with blue insulation or flagging.
- Connect multiple units in parallel, using listed MC4 Branch connectors (Multi-Contact P/N: 32.0018/32.0019 or equivalent). Do not connect PV Link devices in series.



Step 4: Connecting PV Modules to S2501 Units

Connect the modules of the string in series to the input of the PV Link.

WARNING: PV input only - The S2501 is designed to work with series-connected PV modules only. Do not connect to any other source of power.

CAUTION: The S2501 is housed in a watertight type 3R enclosure. However warranty does not cover water ingress through wiring from external connections due to poor wiring practices.

Install the PV modules of the substring and connect in series:

1. Connect the negative lead of the first module in the string to the PV Link at the right-hand location marked "PV SUBSTRING INPUT  " (the negative input lead of the PV Link).
2. Connect the positive lead of the first module to the negative lead of the second module.
3. Continue connecting the substring module leads in series until the last module is reached.
4. Connect the positive lead of the last module in the substring to the PV Link at the right-hand location marked "PV SUBSTRING INPUT  " (the positive input lead of the PV Link).



Operating Instructions:

Step 5: Commissioning the REbus System

Follow inverter instructions to power up and commission the system. The S2501 unit ships from the factory in disabled state, and each unit must be enabled from the Inverter LCD screen. Once enabled, operation of the S2501 is automatic. The unit automatically detects the presence of a REbus microgrid and begins export of power when the bus is within normal operating specifications.

User Interface via Inverter

While the S2501 has no user interface, it communicates with the inverter and other devices on the microgrid via Powerline Carrier Communication (PLC). Information and control features for each S2501 unit are accessible via the inverter when REbus is energized.

To access the device page for each PV Link, use the left or right arrow buttons on the inverter to scroll through connected REbus devices.

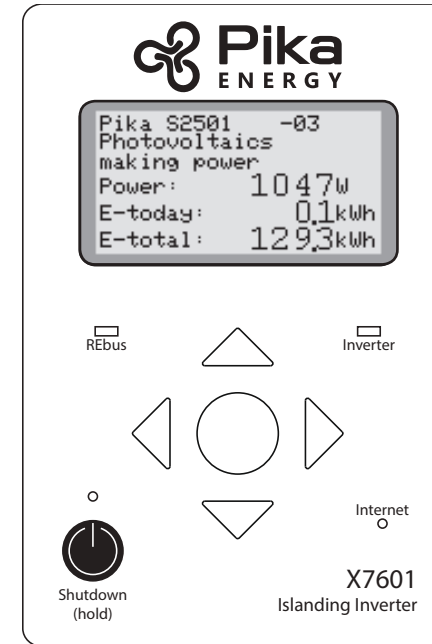

The operating state of each PVL is displayed on its device screen. The following states are available:

- disabled
- initializing
- powering up
- low REbus voltage
- standby
- waiting
- low input voltage
- connecting input
- disconnecting input
- connecting bus
- making power
- limiting power
- low sun
- error
- error: ground fault
- error: insulation fault
- device off line

Daily and lifetime energy production (kWh) is available on the individual device screen. The output power circuit of individual S2501 units may be disabled or enabled from the inverter controller. Communication with the inverter is not affected by Disabled/Enabled state.

To disable the S2501:

1. On the inverter front panel use the left or right arrows to scroll to the S2501 device page
2. Press the center button
3. Scroll down to 'disable'
4. Press the center button to select
5. Scroll right to "confirm"
6. Press the center button to confirm
7. Repeat the process to re-enable the S2501

WARNING: Disabling the PVL does not de-energize the PV array itself, nor will it de-energize the DC bus if other devices are providing power to the DC bus. The Disabled/Enabled state of each unit persists through AC power outages and power-cycling of the DC bus.

System Rapid Shutdown:

Hold the red power button on the inverter front panel for several seconds until the system de-energizes. An external shutdown switch may be used instead if one is equipped.

Operation in High Temperatures:

The S2501 is designed and tested to operate continuously at full power in ambient air temperature up to 70°C. In higher ambient temperatures, power output will be reduced to avoid damage to the unit. Full power operation will resume when conditions moderate.

Servicing Instructions:

The S2501 does not require any regular maintenance and contains no user serviceable parts. To ensure maximum performance, keep heatsink fins free of leaves and other debris. In the event that the S2501 unit is not operating as expected, or if a PV Link error message appears on the inverter's display, contact your installer or Pika Energy technical support.

Technical Support Information:

Support department hours: 9AM to 5PM EST, Monday – Friday (excluding holidays)

Phone: 207-887-9105

Email: support@pika-energy.com

M00011-10



Installation Design:

Use this worksheet to determine the maximum length for PV Link controlled substring, using a given PV module. Fewer PV modules can always be used as long as the minimum MPPT input voltage is met.

1. **Adjust VOC:** Use an appropriate NEC cold factor from table to calculate an adjusted VOC for the module you are installing. The module name-plate temperature correction factor may be used if available.

2. **Limit by VOC:** Divide the S2501's VOC by the chosen panel's adjusted VOC to determine the number of panels you can connect in series to PV Link without exceeding the open circuit voltage limit.

3. **Limit by VMP:** Divide the S2501's VMP by the chosen panel's VMP and round down to determine the number of panels you can connect in series to PV Link without exceeding the voltage at maximum power.

4. **Choose the smaller of the two limit results:** Choose the smaller of the two numbers from the results of steps 3 and 4. Round down to the nearest integer and record it here. This is the maximum number of modules of this type that you can connect to PV Link given the specified cold factor.

Min. Temp (°C)	NEC Cold Factor	Min. Temp (°F)
9 to 5	1.08	49 to 41
4 to 0	1.10	40 to 32
-1 to -5	1.12	22 to 14
-6 to -10	1.14	22 to 14
-11 to -15	1.16	13 to 5
-16 to -20	1.18	4 to -4
-21 to -25	1.20	-5 to -13
-26 to -30	1.21	-14 to -22
-31 to -35	1.23	-23 to -31
-36 and below	1.25	-31 and below

