



RESULTS BOOK

MOSCOW-KARATE-UNIVERSE
INTERNATIONAL 2024

2024.11.08 - 2024.11.10

MOSCOW

RUSSIAN FEDERATION, RUS

TABLE OF CONTENTS

NUMBER OF ENTRIES	3
ENTRYLIST	4
ENTRYLIST BY WEIGHT CATEGORY	12
STATISTICS	21
SESSION STARTLISTS	22
SESSION RESULTS	23
SENIOR KATA FEMALE	152
SENIOR KATA MALE	165
SENIOR KUMITE FEMALE -50KG	35
SENIOR KUMITE FEMALE -55KG	48
SENIOR KUMITE FEMALE -61KG	61
SENIOR KUMITE FEMALE -68KG	74
SENIOR KUMITE FEMALE +68KG	24
SENIOR KUMITE MALE +84KG	87
SENIOR KUMITE MALE -60KG	100
SENIOR KUMITE MALE -67KG	113
SENIOR KUMITE MALE -75KG	126
SENIOR KUMITE MALE -84KG	139
OFFICIAL RESULTS	178
MEDAL STANDING	181





MOSCOW-KARATE-UNIVERSE INTERNATIONAL ..

RUSSIAN FEDERATION
Moscow

2024.11.08 - 2024.11.10



NUMBER OF ENTRIES

#	Code	Country	Male Entries	Female Entries	Total Entries	Total Athletes
1	 ALG	ALGERIA	3	2	5	5
2	 ARM	ARMENIA	6	0	6	6
3	 AZE	AZERBAIJAN	7	7	14	14
4	 BLR	BELARUS	22	15	37	37
5	 BUL	BULGARIA	0	1	1	1
6	 CHI	CHILE	0	1	1	1
7	 CIV	COTE D'IVOIRE	2	0	2	2
8	 CUB	CUBA	0	1	1	1
9	 EGY	EGYPT	4	7	11	11
10	 IND	INDIA	5	2	7	7
11	 INA	INDONESIA	1	1	2	2
12	 IRI	ISLAMIC REPUBLIC OF IRAN	10	0	10	10
13	 ITA	ITALY	3	0	3	3
14	 KAZ	KAZAKHSTAN	17	11	28	28
15	 KUW	KUWAIT	1	0	1	1
16	 KGZ	KYRGYZSTAN	3	2	5	5
17	 MAD	MADAGASCAR	1	0	1	1
18	 MGL	MONGOLIA	0	2	2	2
19	 PAK	PAKISTAN	2	2	4	4
20	 RUS	RUSSIAN FEDERATION	58	79	137	137
21	 KSA	SAUDI ARABIA	1	0	1	1
22	 SEN	SENEGAL	1	0	1	1
23	 SRB	SERBIA	4	2	6	6
24	 SRI	SRI LANKA	1	0	1	1
25	 SUI	SWITZERLAND	2	0	2	2
26	 TJK	TAJIKISTAN	5	1	6	6
27	 TUN	TUNISIA	2	5	7	7
28	 TUR	TURKIYE	2	4	6	6
29	 UAE	UNITED ARAB EMIRATES	2	2	4	4
30	 UZB	UZBEKISTAN	9	7	16	16
31	 VEN	VENEZUELA	1	1	2	2
Totals:			175	155	330	330



MOSCOW-KARATE-UNIVERSE INTERNATIONAL ..



ENTRIES BY NOC

As of 10 NOV 2024

NOC Code	Gender	Name	Date Of Birth	Event	Seed
ALG	M	MOHAMED EL AMINE SELLOUM	20 FEB 1996	Senior Kumite Male -84kg	
	M	OUSSAMA ZAID	03 FEB 2000	Senior Kumite Male -75kg	
	M	SALAH EDDINE SEKKOUR	17 NOC 1995	Senior kata male	4
	F	Dounia Moukhtari	28 OCT 1997	Senior Kumite Female +68kg	
	F	RAYANE SEKKOUR	18 JAN 2001	Senior Kumite Female -50kg	
ARM	M	Harutyunyan Suren	26 MAR 2004	Senior Kumite Male -67kg	15
	M	Hovhannisyan Robert	14 DEC 2004	Senior Kumite Male -75kg	
	M	Karyan Hayk	15 AUG 2001	Senior Kumite Male -75kg	
	M	MAKYAN DAVIT	08 MAR 2001	Senior Kumite Male -75kg	
	M	Mkhitaryan Mikhayil	01 MAR 1999	Senior kata male	
	M	Nersisyan Gor	04 SEP 2003	Senior Kumite Male -84kg	15
AZE	M	guliyev aminagha	18 SEP 2002	Senior Kumite Male -60kg	15
	M	Gurbanli Asiman	10 AUG 1992	Senior Kumite Male +84kg	8
	M	hasanov turgut	07 SEP 1993	Senior Kumite Male -84kg	
	M	heydarov roman	24 JAN 1999	Senior kata male	1
	M	mammadli huseyn	12 MAI 2003	Senior Kumite Male -67kg	13
	M	nuran rzazade	28 JUL 2002	Senior Kumite Male -67kg	
	M	savadov farid	09 MAR 2005	Senior Kumite Male -60kg	24
	F	alibayova khumar	30 OCT 2003	Senior Kumite Female -50kg	
	F	Aliyeva Aysu	17 OCT 2005	Senior Kumite Female -68kg	
	F	arabli renata	15 SEP 2000	Senior Kumite Female -61kg	
	F	Karimova Suada	17 MAR 2004	Senior Kumite Female -55kg	
	F	neda rezai	08 OCT 1985	Senior kata female	
	F	sadigova madina	01 JUN 2001	Senior Kumite Female -55kg	7
F	teymurova fidan	02 JAN 2000	Senior Kumite Female -50kg	16	
BLR	M	Antsimonik Ivan	12 OCT 2007	Senior kata male	
	M	Bahamolets Mikita	06 AUG 2006	Senior Kumite Male -67kg	
	M	Bareika Maksim	20 SEP 1996	Senior kata male	3
	M	Chymbur Raman	29 APR 2006	Senior Kumite Male -75kg	
	M	Dubina Mikita	17 MAI 2005	Senior Kumite Male -75kg	
	M	Isakau Anton	19 JUL 1995	Senior Kumite Male +84kg	
	M	Kashyrski Maksim	13 SEP 2004	Senior Kumite Male -60kg	
	M	Kiryievich Mikita	29 MAR 1999	Senior Kumite Male -84kg	
	M	Krautsou Artsiom	20 SEP 1991	Senior Kumite Male -67kg	
	M	Kryviankou Daniil	19 APR 2004	Senior Kumite Male -75kg	
	M	Kudzinou Ivan	12 JAN 2006	Senior Kumite Male +84kg	
	M	Markau Matsvei	12 APR 2006	Senior Kumite Male -67kg	
	M	Melyokhin Oleg	09 JUN 1999	Senior Kumite Male -67kg	
	M	Nhuyen Devid	03 DEC 2000	Senior Kumite Male -75kg	
	M	Prykhozka Pavel	13 JUL 2006	Senior Kumite Male -60kg	
	M	Rysevets Hleb	07 AUG 2005	Senior Kumite Male -75kg	
	M	Sachkouski Hleb	05 AUG 2001	Senior Kumite Male -84kg	
	M	Sakhvon Mikita	16 JAN 2004	Senior Kumite Male -84kg	
	M	Stahouski Arseni	27 NOC 2003	Senior Kumite Male -67kg	
	M	Vialionda Vadzim	24 MAR 2006	Senior Kumite Male -60kg	
M	Vodchyts Aliaksei	19 MAI 1997	Senior Kumite Male +84kg		
M	Volosov Uladzislau	05 JUL 2006	Senior Kumite Male -75kg		



MOSCOW-KARATE-UNIVERSE INTERNATIONAL ..



ENTRIES BY NOC

As of 10 NOV 2024

NOC Code	Gender	Name	Date Of Birth	Event	Seed
BLR	F	Azarava Maryia	29 JUL 2000	Senior Kumite Female -61kg	
	F	Baravik Veranika	01 APR 2002	Senior kata female	2
	F	Barodzich Volha	20 JAN 2002	Senior Kumite Female -50kg	
	F	Bucha Uliya	24 NOC 2007	Senior kata female	
	F	Chystsiaikova Varvara	12 FEB 2006	Senior Kumite Female -61kg	
	F	Fiadosava Katsiaryna	28 AUG 2000	Senior kata female	
	F	Hrachova Palina	11 DEC 2007	Senior kata female	
	F	Hryneuskaya Alisa	13 JUN 2006	Senior kata female	
	F	Kolb Alesia	11 SEP 2006	Senior kata female	
	F	Konnava Yana	04 JUL 2006	Senior Kumite Female -61kg	
	F	Markava Ulyana	20 AUG 2005	Senior Kumite Female -50kg	
	F	Mukha Palina	05 NOC 2004	Senior kata female	
	F	Ramaniuk Volha	15 MAR 2004	Senior Kumite Female -68kg	
	F	Rolia Milena	27 NOC 2003	Senior kata female	
	F	Rudzenchanka Viktoryia	28 MAR 2008	Senior kata female	4
BUL	F	Goranova Ivet	03 JUN 2000	Senior Kumite Female -55kg	8
CHI	F	De La Paz Carol	16 JAN 1983	Senior kata female	3
CIV	M	KONE NERIME ZIE JOSPIN	17 JAN 2000	Senior kata male	
	M	MEITE IBRAHIMA SY	03 MAI 2000	Senior Kumite Male -67kg	
CUB	F	Torres Alverd Baurelys de la Caridad	20 SEP 1994	Senior Kumite Female -55kg	
EGY	M	BADAWY YOUSSEF	06 AUG 2001	Senior Kumite Male -84kg	8
	M	Elsawy Aly	16 FEB 1995	Senior Kumite Male -75kg	6
	M	Fathy Ebrahim	01 FEB 2002	Senior Kumite Male -67kg	
	M	Mohamed Gaber	01 AUG 2001	Senior Kumite Male -60kg	
	F	Abdelaziz Feryal	16 FEB 1999	Senior Kumite Female -68kg	16
	F	Attia Mirna	14 AUG 2000	Senior Kumite Female -55kg	
	F	Gomaa Asmaa	20 MAI 2004	Senior Kumite Female +68kg	
	F	Haidi Mahgoub	03 FEB 2001	Senior Kumite Female +68kg	
	F	Mahmoud Gana	01 OCT 2005	Senior Kumite Female -50kg	
	F	Nourhan Sewidan	27 AUG 2003	Senior kata female	
	F	Tolba Rahma	01 JAN 2006	Senior Kumite Female -61kg	8
IND	M	DAS RUPESH	10 JUN 1995	Senior Kumite Male -67kg	
	M	NATH ARJUN	17 MAI 1996	Senior kata male	
	M	PYDIPATI BABI VARMA	13 JUL 2003	Senior Kumite Male -60kg	
	M	SHARMA PRANAY	23 FEB 2000	Senior Kumite Male -75kg	
	M	SINDHIYA GAURAV	28 JAN 1987	Senior Kumite Male -60kg	
	F	JADHAV BHUVANESHWARI SURESH	04 SEP 1995	Senior Kumite Female -68kg	
	F	SINGHI MESOM	18 NOC 1998	Senior kata female	5
INA	M	YUSTISIO HUGGIES	12 DEC 2000	Senior Kumite Male -84kg	
	F	AGUNG SANISTYARANI COK ISTRY	31 DEC 1994	Senior Kumite Female -55kg	
IRI	M	ABAZARI SALEH	03 MAR 1998	Senior Kumite Male +84kg	14
	M	Asgari ghonchek Bahman	21 DEC 1991	Senior Kumite Male -84kg	6
	M	ASHOURI GARMJANI MAHDI	03 AUG 1998	Senior Kumite Male +84kg	15



MOSCOW-KARATE-UNIVERSE INTERNATIONAL ..



ENTRIES BY NOC

As of 10 NOV 2024

NOC Code	Gender	Name	Date Of Birth	Event	Seed
IRI	M	Askaripour Mohammaderfan	06 AUG 2005	Senior Kumite Male -75kg	16
	M	GANJZADEH GHOUJEH BEIGLOU MAHDI	01 JUN 2003	Senior Kumite Male +84kg	
	M	HEYDARIYASAVOLI ALIREZA	17 JAN 2002	Senior Kumite Male -84kg	
	M	KHODABAKHSHI MAHDI	30 APR 1995	Senior Kumite Male -84kg	11
	M	Nemati Mahmoud	23 JUN 2002	Senior Kumite Male +84kg	
	M	Nemati Morteza	10 MAR 2001	Senior Kumite Male -75kg	
	M	SHAHGOL MAHDI	16 AUG 2000	Senior Kumite Male -75kg	
ITA	M	De Vivo Gianluca	16 AUG 1992	Senior Kumite Male -67kg	
	M	Ingenito Angelo	20 JUL 2004	Senior Kumite Male -67kg	
	M	Sabatino Christian	18 JUN 2004	Senior Kumite Male -60kg	
KAZ	M	ALPYSBAY KAISAR	11 DEC 1995	Senior Kumite Male -60kg	8
	M	ALTYNBEK OLZHAS	17 MAI 2004	Senior Kumite Male -67kg	
	M	ANARBЕКOV DIAS	06 JUN 2003	Senior Kumite Male +84kg	
	M	AZHIKANOV NURKANAT	23 FEB 2001	Senior Kumite Male -75kg	8
	M	BATYRGALI ABILMANSUR	15 OCT 2001	Senior Kumite Male -75kg	
	M	BIGABYL ZHOLAMAN	22 MAR 2003	Senior Kumite Male -60kg	
	M	Ganiyev Alikhan	17 OCT 2003	Senior Kumite Male -75kg	
	M	Kateshov Madi	03 DEC 1987	Senior kata male	2
	M	MUKHAT AIDOS	17 MAI 2004	Senior Kumite Male -75kg	
	M	Mussa Nurassyl	08 AUG 2006	Senior Kumite Male -60kg	
	M	Taizhan Alisher	13 DEC 2005	Senior Kumite Male +84kg	
	M	Tangirbergen Yersultan	16 JUL 2004	Senior Kumite Male -67kg	
	M	TARNAKIN NIKITA	22 OCT 2003	Senior Kumite Male -84kg	
	M	Timraliyev Darkhan	06 SEP 2000	Senior Kumite Male -60kg	
	M	Turebek Yelnur	07 DEC 2005	Senior Kumite Male -60kg	
	M	Ulbek Dias	07 AUG 2003	Senior Kumite Male -84kg	
	M	YULDASHEV DANIYAR	03 SEP 1996	Senior Kumite Male -84kg	12
	F	Alimanova Madina	19 DEC 2000	Senior Kumite Female -55kg	
	F	Bakirova Aizhan	12 APR 2005	Senior Kumite Female -61kg	16
	F	BERULTSEVA SOFYA	06 NOC 2000	Senior Kumite Female +68kg	8
	F	DARENKAYA DAIYANA	09 SEP 2005	Senior Kumite Female -68kg	15
	F	KANAY ASSEL	25 MAI 2001	Senior Kumite Female -61kg	7
	F	Sagynbek Laura	27 DEC 2005	Senior Kumite Female -68kg	
F	Samasheva Bella	22 SEP 2004	Senior Kumite Female -55kg	6	
F	Tizimbay Nuriya	18 APR 2004	Senior Kumite Female -61kg		
F	Ussenova Gulmira	11 SEP 1999	Senior Kumite Female -55kg		
F	YERDAULET ASEMGUL	21 NOC 2003	Senior Kumite Female -55kg		
F	ZHANGBYRBAY MOLDIR	18 MAI 1997	Senior Kumite Female -50kg	7	
KUW	M	HASAN NOUH	20 FEB 2002	Senior Kumite Male -60kg	
KGZ	M	Baratov Vizit	15 MAI 2004	Senior Kumite Male -67kg	
	M	Iliasov Mukhammed	27 SEP 2005	Senior Kumite Male -84kg	
	M	Nurlanov Nazim	19 NOC 2003	Senior Kumite Male -75kg	
	F	Iarova Dali	14 AUG 2005	Senior Kumite Female -50kg	
	F	Ryrenko Ekaterina	09 FEB 2002	Senior Kumite Female +68kg	
MAD	M	RAJAONARISON CHRISTIANFINOANA	07 AUG 2003	Senior Kumite Male -60kg	



MOSCOW-KARATE-UNIVERSE INTERNATIONAL ..



ENTRIES BY NOC

As of 10 NOV 2024

NOC Code	Gender	Name	Date Of Birth	Event	Seed
MGL	F	CHINZORIG ENKHZAYA	20 SEP 2006	Senior Kumite Female -50kg	
	F	NARMANDAKH NARANGOO	24 DEC 2005	Senior Kumite Female -50kg	
PAK	M	DIN SHAMS UD	14 APR 2000	Senior Kumite Male -67kg	
	M	RASHEED MUHAMMAD FARHAN	27 JUN 2000	Senior Kumite Male -60kg	
	F	ARZO ARZO	08 MAI 2006	Senior Kumite Female +68kg	
	F	GUL MA	01 JAN 2002	Senior Kumite Female -61kg	
RUS	M	Akhmedov Akhmed	04 NOC 2003	Senior Kumite Male -67kg	2
	M	AKHMEDOV RUSTAM	20 MAR 2006	Senior Kumite Male -75kg	7
	M	Antohii Vasilii	23 SEP 1995	Senior Kumite Male +84kg	6
	M	ANTONYAN ARUTYUN	05 SEP 1993	Senior Kumite Male -84kg	7
	M	ANUCHIN PAVEL	17 NOC 2005	Senior kata male	14
	M	BAKIROV VARISHAN	22 JUN 2005	Senior kata male	16
	M	BASCHIN EVGENIY	18 MAI 2002	Senior Kumite Male -60kg	
	M	BELONOGOV KIRILL	04 OCT 2002	Senior Kumite Male +84kg	
	M	BELYKH VALERIY	17 JUN 2003	Senior kata male	11
	M	Bobrov Egor	14 MAI 2005	Senior Kumite Male -84kg	4
	M	BOLSHAKOV NIKITA	28 OCT 2003	Senior Kumite Male -60kg	4
	M	BRANTOV DANILA	12 MAR 2002	Senior kata male	
	M	BUROV VLADISLAV	14 DEC 2002	Senior Kumite Male +84kg	
	M	Danilov Daniil	01 JUL 1999	Senior Kumite Male -67kg	5
	M	Drozdov Maksim	15 JUN 2003	Senior Kumite Male +84kg	
	M	Fedin Timofey	12 FEB 2006	Senior Kumite Male -75kg	11
	M	Gabeliia Zurab	14 JAN 1980	Senior Kumite Male -84kg	
	M	Gadzhiev Gadzhi	19 AUG 2005	Senior Kumite Male -75kg	4
	M	GASPARYAN EDUARD	02 JAN 2005	Senior Kumite Male -84kg	1
	M	GOLOVIN MAKAR	09 JAN 2001	Senior Kumite Male +84kg	1
	M	Grachev Semen	17 JUN 2004	Senior Kumite Male -75kg	2
	M	GRETSKIY DANIIL	21 AUG 2002	Senior Kumite Male -75kg	
	M	Guglevatyi Dmitriy	31 JUL 1997	Senior Kumite Male -84kg	
	M	Gusev Igor	18 JUN 2005	Senior Kumite Male +84kg	
	M	Ilushin Anatoliy	14 MAR 2006	Senior Kumite Male -67kg	4
	M	Ivanian Enriko	29 JUN 2003	Senior Kumite Male -84kg	
	M	KACHESOV GEORGII	28 AUG 1998	Senior kata male	9
	M	Kamyshov Daniil	16 JUL 2001	Senior Kumite Male +84kg	7
	M	Khorsik Egor	23 AUG 2001	Senior Kumite Male -75kg	3
	M	KIM VALENTIN	05 AUG 1993	Senior kata male	15
	M	Kireev Egor	02 JUL 2004	Senior Kumite Male -84kg	
	M	KOKOVUROV KONSTANTIN	17 FEB 2004	Senior Kumite Male +84kg	3
	M	Kovalev Kirill	22 MAR 2002	Senior Kumite Male +84kg	4
	M	Kurmanov Konshau-Biy	07 APR 2006	Senior Kumite Male -84kg	2
M	Makhmudov Oleg	17 FEB 1995	Senior Kumite Male -75kg	14	
M	Mikhailichenko Danila	22 JAN 2003	Senior Kumite Male -67kg	7	
M	Ogannisyan Yurik	05 AUG 2002	Senior Kumite Male -67kg	1	
M	Pakhomov Suleyman	13 MAR 2005	Senior Kumite Male -60kg	1	
M	PCHENITCIN ALEKSANDR	01 MAR 1992	Senior Kumite Male +84kg	2	
M	PETRAKOV DANIIL	29 APR 2003	Senior Kumite Male -84kg	3	
M	Ponomarenko Michael	25 APR 2002	Senior Kumite Male +84kg		



MOSCOW-KARATE-UNIVERSE INTERNATIONAL ..



ENTRIES BY NOC

As of 10 NOV 2024

NOC Code	Gender	Name	Date Of Birth	Event	Seed
RUS	M	Popov Egor	25 AUG 2001	Senior kata male	13
	M	Pritmov Alexander	20 JUN 2002	Senior Kumite Male -75kg	5
	M	SALYNOV ALEKSANDR	10 JAN 2005	Senior Kumite Male -60kg	3
	M	Satybaldiev Erbol	23 JAN 2004	Senior Kumite Male -60kg	
	M	Savin Ilya	02 AUG 2000	Senior Kumite Male -60kg	2
	M	SAVVIN NIKOLAI	08 MAI 2006	Senior kata male	
	M	SERGEEV IVAN	04 APR 2003	Senior kata male	
	M	SHARAFUTDINOV ERNEST	04 OCT 2000	Senior Kumite Male -75kg	1
	M	Sidorenko Denis	28 JUN 2004	Senior kata male	
	M	Sisin Alexandr	10 JAN 2003	Senior Kumite Male -84kg	
	M	SON EVGENII	28 AUG 2003	Senior Kumite Male -67kg	8
	M	Spitsin Sergey	21 MAI 1992	Senior Kumite Male -67kg	3
	M	STARILOV ARTEM	31 MAI 2006	Senior kata male	
	M	Surikov Artem	17 JAN 2006	Senior Kumite Male -60kg	
	M	SUTYAGIN KONSTANTIN	28 FEB 2000	Senior kata male	12
	M	UKHABOV PAVEL	28 FEB 2004	Senior Kumite Male -67kg	6
	M	ZHURAVLEV MAKSIM	30 JUN 2004	Senior kata male	10
	F	Abramova Valeria	17 MAI 2002	Senior Kumite Female -61kg	
	F	ARKHIPOVA SVETLANA	06 OCT 2006	Senior kata female	
	F	Basangova Altana	01 NOC 2005	Senior Kumite Female -61kg	3
	F	Bibikova Anna	01 AUG 2003	Senior Kumite Female -55kg	
	F	BIKMETOVA AIDA	18 MAI 2005	Senior Kumite Female -61kg	5
	F	Bikmullina Kamilla	04 JUN 2004	Senior Kumite Female -68kg	2
	F	Boiko Anna	10 OCT 1998	Senior Kumite Female -55kg	
	F	Boradzova Kamila	26 SEP 2003	Senior Kumite Female -55kg	3
	F	Bublikova Victoria	16 AUG 2003	Senior Kumite Female -68kg	
	F	BUMAGINA KIRA	24 MAR 2006	Senior kata female	
	F	Chernysheva Anna	29 SEP 2001	Senior Kumite Female -55kg	1
	F	Chizhikova Dariya	06 NOC 2004	Senior Kumite Female -61kg	4
	F	Chupina Anastasiya	24 JUL 2003	Senior Kumite Female -61kg	1
	F	DAVIDOVA VIKTORIYA	23 SEP 2006	Senior Kumite Female -50kg	
	F	DEMENEVA VARVARA	03 MAI 2005	Senior Kumite Female -61kg	
	F	Dimova Valeriia	10 MAR 2001	Senior Kumite Female -55kg	
	F	Dorofeeva Varvara	29 NOC 2005	Senior Kumite Female +68kg	
	F	Falkova Anastasia	26 FEB 2002	Senior Kumite Female -50kg	
	F	FEDOROVA EKATERINA	23 JUN 2006	Senior kata female	
	F	FILIMONOVA ANASTASIYA	09 JUL 2001	Senior Kumite Female -61kg	
	F	Gadzhieva Victoriya	06 DEC 1999	Senior Kumite Female -68kg	
	F	Gagieva Snezhana	05 DEC 2004	Senior Kumite Female -68kg	
	F	Garipova Kamilla	28 JUL 2006	Senior Kumite Female -50kg	
	F	Garipova Yana	23 OCT 2002	Senior Kumite Female +68kg	4
	F	Goretskaya Polina	04 NOC 2001	Senior Kumite Female -61kg	
	F	GORYACHEVA EKATERINA	13 JUN 2005	Senior kata female	9
	F	Grigoreva Elizaveta	17 MAR 2003	Senior Kumite Female -50kg	1
	F	GUSEVA POLINA	12 AUG 2005	Senior kata female	
	F	Ilina Daria	05 JAN 2006	Senior Kumite Female -50kg	
	F	Iushkevich Vasilina	03 FEB 2006	Senior Kumite Female -55kg	
	F	Khalimova Sunita	03 JAN 1999	Senior Kumite Female +68kg	2



MOSCOW-KARATE-UNIVERSE INTERNATIONAL ..



ENTRIES BY NOC

As of 10 NOV 2024

NOC Code	Gender	Name	Date Of Birth	Event	Seed
RUS	F	Kochieva Alana	29 DEC 1997	Senior Kumite Female -61kg	6
	F	Kokareva Kseniya	26 AUG 2004	Senior kata female	
	F	Kopylova Darya	19 SEP 2004	Senior Kumite Female -68kg	
	F	KOSTYUSHKINA ZHANNA	02 MAI 2002	Senior Kumite Female -55kg	2
	F	KOTLYAROVA POLINA	05 AUG 1999	Senior kata female	12
	F	KUDRIAVTSEVA ANNA	13 NOC 2004	Senior Kumite Female -68kg	7
	F	LAVROVA POLINA	04 OCT 2005	Senior Kumite Female -55kg	
	F	LENNIK ALEKSANDRA	03 JUL 2003	Senior kata female	14
	F	Lyahova Varvara	03 AUG 2006	Senior Kumite Female -68kg	
	F	Markovskaya Svetlana	23 FEB 2004	Senior Kumite Female -68kg	
	F	Meshkova Aleksandra	15 JUN 2002	Senior Kumite Female -68kg	1
	F	MIRONOVA TATYANA	09 JUN 2001	Senior Kumite Female +68kg	3
	F	MIROSHNICHENKO ANNA	06 SEP 2001	Senior kata female	
	F	NOVICHIKHINA ELENA	04 FEB 2007	Senior kata female	15
	F	PEREVOZCHIKOVA ANNA	12 FEB 2003	Senior Kumite Female -55kg	4
	F	Perminova Yulianna	25 JUL 2006	Senior kata female	
	F	PETKINA POLINA	12 AUG 2002	Senior Kumite Female -50kg	
	F	Pipko Daria	07 SEP 2002	Senior Kumite Female +68kg	1
	F	PUGACHEVA DARYA	17 FEB 2005	Senior Kumite Female -50kg	
	F	Pustovit Ekaterina	28 JAN 1999	Senior Kumite Female -68kg	
	F	Razumnykh Anastasiya	14 APR 2000	Senior Kumite Female -50kg	4
	F	Rodina Anna	08 AUG 1999	Senior Kumite Female -61kg	2
	F	RUSANOVA VITALIYA	14 FEB 2004	Senior Kumite Female -55kg	
	F	Sadovskaya Mariya	13 OCT 2005	Senior Kumite Female -61kg	
	F	SADYKOVA AIGUL	18 FEB 2006	Senior Kumite Female -50kg	2
	F	SAVKOVSKAYA TATIANA	12 NOC 1998	Senior Kumite Female -50kg	
	F	SAZHINA ARINA	05 JUN 2003	Senior Kumite Female -55kg	
	F	SEMENOVA MARIYA	25 APR 2005	Senior Kumite Female -68kg	8
	F	Sergeeva Valeriia	23 DEC 1999	Senior Kumite Female -50kg	3
	F	Shcherbina Anna	22 SEP 2001	Senior kata female	16
	F	SHISHOVA KSENIYA	12 JUL 2005	Senior Kumite Female +68kg	
	F	SMETANINA ANASTASIYA	04 AUG 2000	Senior Kumite Female -55kg	
	F	Sokolova Anastasia	13 APR 2004	Senior Kumite Female -50kg	
	F	Sotyreva Mariya	24 JUN 2005	Senior Kumite Female -55kg	
	F	Surikova Darya	28 FEB 2002	Senior Kumite Female -68kg	4
	F	Tarasova Angelina	14 OCT 2008	Senior kata female	
	F	Tarasova Ekaterina	12 JUN 2004	Senior Kumite Female +68kg	
	F	TEPIKINA KSENIYA	27 AUG 2006	Senior Kumite Female -61kg	
	F	Tsysova Anastasia	27 APR 2002	Senior Kumite Female -61kg	
	F	TULYAKOVA DARYA	12 AUG 2000	Senior kata female	11
	F	VARLAMOVA EKATERINA	16 JAN 2004	Senior kata female	13
	F	Verevkina Mariya	21 JUL 2002	Senior Kumite Female -55kg	
	F	VIDENMEER VIKTORIA	09 AUG 2002	Senior Kumite Female -68kg	
	F	Vishnyakova Viktoriya	26 JAN 2006	Senior Kumite Female -55kg	
	F	Zakarian Anaida	28 NOC 2003	Senior Kumite Female -68kg	
	F	Zavgarova Liya	21 MAI 2000	Senior Kumite Female -68kg	3
	F	ZOTOVA MARIYA	14 AUG 1999	Senior kata female	10
	F	Zvyagentseva Olga	01 FEB 2006	Senior Kumite Female -55kg	



MOSCOW-KARATE-UNIVERSE INTERNATIONAL ..



ENTRIES BY NOC

As of 10 NOV 2024

NOC Code	Gender	Name	Date Of Birth	Event	Seed
KSA	M	HUSSAIN NASHWAN	11 JUN 2004	Senior Kumite Male -67kg	
SEN	M	GUEYE SALIOU	27 MAI 1999	Senior Kumite Male +84kg	
SRB	M	BREZANCIC VLADIMIR	23 JUL 1999	Senior Kumite Male -84kg	
	M	JOKSIC STEFAN	26 MAR 1992	Senior Kumite Male -67kg	
	M	TOPUZOVIC ALEKSANDAR	03 OCT 2002	Senior Kumite Male -75kg	
	M	TRIKOS BOGDAN	27 JUN 1997	Senior Kumite Male +84kg	
	F	TRIKOS MINA	22 FEB 2003	Senior Kumite Female -61kg	
	F	ZIVKOVIC TAMARA	25 AUG 2002	Senior Kumite Female -68kg	
SRI	M	CHAMINDA SISIRA KUMARA AHANGAMA WITHANAGE	09 APR 1979	Senior kata male	
SUI	M	Gindre Maxime	29 JUN 1997	Senior Kumite Male -84kg	
	M	Timmer Eric	09 NOC 2003	Senior Kumite Male -60kg	16
TJK	M	MASHRABOV SIYOVUSH	04 MAI 2002	Senior Kumite Male -67kg	
	M	RAKHIMOV FARUKHDZHON	24 OCT 1993	Senior Kumite Male +84kg	
	M	Sharapov Abdulvahob	31 OCT 2000	Senior Kumite Male -67kg	
	M	Sultonov Alisher	10 NOC 2005	Senior Kumite Male -60kg	
	M	TESHAEV MUHAMMAD	03 JAN 2001	Senior Kumite Male -60kg	
	F	Shukurbekova Yasmin	16 SEP 2006	Senior Kumite Female +68kg	
TUN	M	FERCHICHI IHEB	09 OCT 2005	Senior Kumite Male -60kg	7
	M	KHALIL KHALIL AHMED	29 MAI 2006	Senior Kumite Male -60kg	
	F	ESSID TESNIME	26 NOC 2002	Senior Kumite Female -68kg	24
	F	EZZAR WISSAL	31 OCT 2002	Senior Kumite Female -68kg	
	F	JEMI CHEHINEZ	29 APR 1997	Senior Kumite Female +68kg	16
	F	MSAKNI TESNIM	07 AUG 2006	Senior Kumite Female +68kg	
	F	ZARRATI CHIRINE	16 DEC 2002	Senior Kumite Female -55kg	
TUR	M	KILIÇ Emirhan	20 NOC 2004	Senior Kumite Male +84kg	
	M	YILMAZ Ekrem Altuner	27 DEC 2001	Senior Kumite Male -67kg	
	F	Büber Nurbade	29 AUG 2002	Senior Kumite Female -61kg	
	F	Ghorbi Nahal	15 MAR 1997	Senior Kumite Female -55kg	
	F	HOCAOGLU AKYOL MELTEM	15 JAN 1992	Senior Kumite Female +68kg	7
	F	Seyedefereshteh RAZAVI	07 FEB 2000	Senior Kumite Female -61kg	
UAE	M	KHUDHAIR ZAYED	04 OCT 2000	Senior Kumite Male -84kg	
	M	MOHAMED ABDULGHANI	30 JUL 2005	Senior kata male	6
	F	AL AJMI HAWRAA	23 JAN 1996	Senior Kumite Female -50kg	
	F	KHASAIF FATMA	04 OCT 2002	Senior Kumite Female -68kg	
UZB	M	ABDULLAEV JAVOKHIRKHON	21 FEB 2002	Senior Kumite Male +84kg	
	M	ISMATULLAYEV ISLOMBEK	02 AUG 2005	Senior Kumite Male +84kg	
	M	MUKHAMMADIYEV KUVONCHBEK	18 JAN 2002	Senior Kumite Male -75kg	
	M	NAMOOZOV SHUKHRATJON	21 AUG 2004	Senior Kumite Male -84kg	
	M	RASHIDOV ABDUL VAKHKHOB	31 DEC 2005	Senior Kumite Male -67kg	
	M	RASULOV MANSUR	24 OCT 1994	Senior Kumite Male -67kg	
	M	Soyibjonov Sanjarbek	23 DEC 2003	Senior kata male	
	M	TURAKHONOV MEKHRIDDIN	01 AUG 2005	Senior Kumite Male -60kg	
	M	VOISOV UMIDJON	16 OCT 2003	Senior kata male	



MOSCOW-KARATE-UNIVERSE INTERNATIONAL ..



ENTRIES BY NOC

As of 10 NOV 2024

NOC Code	Gender	Name	Date Of Birth	Event	Seed
UZB	F	ABDRIMOVA MOHICHEHRA	22 MAR 2006	Senior Kumite Female -68kg	
	F	ALIMARDANOVA GULSHAN	19 JAN 2006	Senior Kumite Female -50kg	15
	F	Ganieva Dilnoza	12 JUL 1995	Senior Kumite Female -61kg	
	F	NURSEITOVA ANGELINA	29 DEC 2003	Senior Kumite Female +68kg	
	F	OTABOYEVA SEVINCH UZB02811	11 AUG 2004	Senior Kumite Female -61kg	
	F	RAKHIMOVA SEVINCH	22 JAN 1999	Senior Kumite Female -55kg	
	F	TURAKULOVA DURDONA	12 JUN 2001	Senior kata female	1
VEN	M	Martínez Edgar	19 SEP 2001	Senior Kumite Male -84kg	
	F	Salazar Yorgelis	10 NOC 1997	Senior Kumite Female -50kg	8



MOSCOW-KARATE-UNIVERSE INTERNATIONAL ..
ENTRIES BY WEIGHT CATEGORY



Senior kata female
As of 10 NOV 2024

NOC Code	Gender	Name	Seeding
AZE	F	neda rezai	
BLR	F	Baravik Veranika	2
BLR	F	Bucha Uliya	
BLR	F	Fiadosava Katsiaryna	
BLR	F	Hrachova Palina	
BLR	F	Hryneuskaya Alisa	
BLR	F	Kolb Alesia	
BLR	F	Mukha Palina	
BLR	F	Rolia Milena	
BLR	F	Rudzenchanka Viktoryia	4
CHI	F	De La Paz Carol	3
EGY	F	Nourhan Sewidan	
IND	F	SINGHI MESOM	5
RUS	F	ARKHIPOVA SVETLANA	
RUS	F	BUMAGINA KIRA	
RUS	F	FEDOROVA EKATERINA	
RUS	F	GORYACHEVA EKATERINA	9
RUS	F	GUSEVA POLINA	
RUS	F	Kokareva Kseniya	
RUS	F	KOTLYAROVA POLINA	12
RUS	F	LENNIK ALEKSANDRA	14
RUS	F	MIROSHNICHENKO ANNA	
RUS	F	NOVICHIKHINA ELENA	15
RUS	F	Perminova Yulianna	
RUS	F	Shcherbina Anna	16
RUS	F	Tarasova Angelina	
RUS	F	TULYAKOVA DARYA	11
RUS	F	VARLAMOVA EKATERINA	13
RUS	F	ZOTOVA MARIYA	10
UZB	F	TURAKULOVA DURDONA	1

Senior kata male
As of 10 NOV 2024

NOC Code	Gender	Name	Seeding
ALG	M	SALAH EDDINE SEKKOUR	4
ARM	M	Mkhitaryan Mikhayil	
AZE	M	heydarov roman	1
BLR	M	Antsimonik Ivan	
BLR	M	Bareika Maksim	3
CIV	M	KONE NERIME ZIE JOSPIN	
IND	M	NATH ARJUN	
KAZ	M	Kateshov Madi	2
RUS	M	ANUCHIN PAVEL	14
RUS	M	BAKIROV VARISHAN	16



MOSCOW-KARATE-UNIVERSE INTERNATIONAL ..
ENTRIES BY WEIGHT CATEGORY



Senior kata male
As of 10 NOV 2024

NOC Code	Gender	Name	Seeding
RUS	M	BELYKH VALERIY	11
RUS	M	BRANTOV DANILA	
RUS	M	KACHESOV GEORGII	9
RUS	M	KIM VALENTIN	15
RUS	M	Popov Egor	13
RUS	M	SAVVIN NIKOLAI	
RUS	M	SERGEEV IVAN	
RUS	M	Sidorenko Denis	
RUS	M	STARILOV ARTEM	
RUS	M	SUTYAGIN KONSTANTIN	12
RUS	M	ZHURAVLEV MAKSIM	10
SRI	M	CHAMINDA SISIRA KUMARA AHANGAMA WITHANAGE	
UAE	M	MOHAMED ABDULGHANI	6
UZB	M	Soyibjonov Sanjarbek	
UZB	M	VOISOV UMIDJON	

Senior Kumite Female -50kg
As of 10 NOV 2024

NOC Code	Gender	Name	Seeding
ALG	F	RAYANE SEKKOUR	
AZE	F	alibayova khumar	
AZE	F	teymurova fidan	16
BLR	F	Barodzich Volha	
BLR	F	Markava Ulyana	
EGY	F	Mahmoud Gana	
KAZ	F	ZHANGBYRBAY MOLDIR	7
KGZ	F	Iarova Dali	
MGL	F	CHINZORIG ENKHZAYA	
MGL	F	NARMANDAKH NARANGOO	
RUS	F	DAVIDOVA VIKTORIYA	
RUS	F	Falkova Anastasia	
RUS	F	Garipova Kamilla	
RUS	F	Grigoreva Elizaveta	1
RUS	F	Ilina Daria	
RUS	F	PETKINA POLINA	
RUS	F	PUGACHEVA DARYA	
RUS	F	Razumnykh Anastasiya	4
RUS	F	SADYKOVA AIGUL	2
RUS	F	SAVKOVSKAYA TATIANA	
RUS	F	Sergeeva Valeriia	3
RUS	F	Sokolova Anastasia	
UAE	F	AL AJMI HAWRAA	
UZB	F	ALIMARDANOVA GULSHAN	15
VEN	F	Salazar Yorgelis	8



MOSCOW-KARATE-UNIVERSE INTERNATIONAL ..
ENTRIES BY WEIGHT CATEGORY



Senior Kumite Female -55kg
As of 10 NOV 2024

NOC Code	Gender	Name	Seeding
AZE	F	Karimova Suada	
AZE	F	sadigova madina	7
BUL	F	Goranova Ivet	8
CUB	F	Torres Alverd Baurelys de la Caridad	
EGY	F	Attia Mirna	
INA	F	AGUNG SANISTYARANI COK ISTR	
KAZ	F	Alimanova Madina	
KAZ	F	Samasheva Bella	6
KAZ	F	Ussenova Gulmira	
KAZ	F	YERDAULET ASEMGUL	
RUS	F	Bibikova Anna	
RUS	F	Boiko Anna	
RUS	F	Boradzova Kamila	3
RUS	F	Chernysheva Anna	1
RUS	F	Dimova Valeriia	
RUS	F	Iushkevich Vasilina	
RUS	F	KOSTYUSHKINA ZHANNA	2
RUS	F	LAVROVA POLINA	
RUS	F	PEREVOZCHIKOVA ANNA	4
RUS	F	RUSANOVA VITALIYA	
RUS	F	SAZHINA ARINA	
RUS	F	SMETANINA ANASTASIYA	
RUS	F	Sotyreva Mariya	
RUS	F	Verevkina Mariya	
RUS	F	Vishnyakova Viktoriya	
RUS	F	Zvyagentseva Olga	
TUN	F	ZARRATI CHIRINE	
TUR	F	Ghorbi Nahal	
UZB	F	RAKHIMOVA SEVINCH	

Senior Kumite Female -61kg
As of 10 NOV 2024

NOC Code	Gender	Name	Seeding
AZE	F	arabli renata	
BLR	F	Azarava Maryia	
BLR	F	Chystsiakova Varvara	
BLR	F	Konnava Yana	
EGY	F	Tolba Ragma	8
KAZ	F	Bakirova Aizhan	16
KAZ	F	KANAY ASSEL	7
KAZ	F	Tizimbay Nuriya	
PAK	F	GUL MA	
RUS	F	Abramova Valeria	



MOSCOW-KARATE-UNIVERSE INTERNATIONAL ..
ENTRIES BY WEIGHT CATEGORY



Senior Kumite Female -61kg
As of 10 NOV 2024

NOC Code	Gender	Name	Seeding
RUS	F	Basangova Altana	3
RUS	F	BIKMETOVA AIDA	5
RUS	F	Chizhikova Dariya	4
RUS	F	Chupina Anastasiya	1
RUS	F	DEMENEVA VARVARA	
RUS	F	FILIMONOVA ANASTASIYA	
RUS	F	Goretskaya Polina	
RUS	F	Kochieva Alana	6
RUS	F	Rodina Anna	2
RUS	F	Sadovskaya Mariya	
RUS	F	TEPIKINA KSENIIA	
RUS	F	Tsysova Anastasia	
SRB	F	TRIKOS MINA	
TUR	F	Büber Nurbade	
TUR	F	Seyedefereshteh RAZAVI	
UZB	F	Ganieva Dilnoza	
UZB	F	OTABOYEVA SEVINCH UZB02811	

Senior Kumite Female -68kg
As of 10 NOV 2024

NOC Code	Gender	Name	Seeding
AZE	F	Aliyeva Aysu	
BLR	F	Ramaniuk Volha	
EGY	F	Abdelaziz Feryal	16
IND	F	JADHAV BHUVANESHWARI SURESH	
KAZ	F	DARENKAYA DAIYANA	15
KAZ	F	Sagynbek Laura	
RUS	F	Bikmullina Kamilla	2
RUS	F	Bublikova Victoria	
RUS	F	Gadzhieva Victoriya	
RUS	F	Gagieva Snezhana	
RUS	F	Kopylova Darya	
RUS	F	KUDRIAVTSEVA ANNA	7
RUS	F	Lyahova Varvara	
RUS	F	Markovskaya Svetlana	
RUS	F	Meshkova Aleksandra	1
RUS	F	Pustovit Ekaterina	
RUS	F	SEMENOVA MARIYA	8
RUS	F	Surikova Darya	4
RUS	F	VIDENMEER VIKTORIA	
RUS	F	Zakarian Anaida	
RUS	F	Zavgarova Liya	3
SRB	F	ZIVKOVIC TAMARA	
TUN	F	ESSID TESNIME	24



MOSCOW-KARATE-UNIVERSE INTERNATIONAL ..
ENTRIES BY WEIGHT CATEGORY



Senior Kumite Female -68kg
As of 10 NOV 2024

NOC Code	Gender	Name	Seeding
TUN	F	EZZAR WISSAL	
UAE	F	KHASAIF FATMA	
UZB	F	ABDRIMOVA MOHICHEHRA	

Senior Kumite Female +68kg
As of 10 NOV 2024

NOC Code	Gender	Name	Seeding
ALG	F	Dounia Moukhtari	
EGY	F	Gomaa Asmaa	
EGY	F	Haidi Mahgoub	
KAZ	F	BERULTSEVA SOFYA	8
KGZ	F	Ryrenko Ekaterina	
PAK	F	ARZO ARZO	
RUS	F	Dorofeeva Varvara	
RUS	F	Garipova Yana	4
RUS	F	Khalimova Sunita	2
RUS	F	MIRONOVA TATYANA	3
RUS	F	Pipko Daria	1
RUS	F	SHISHOVA KSENIYA	
RUS	F	Tarasova Ekaterina	
TJK	F	Shukurbekova Yasmin	
TUN	F	JEMI CHEHINEZ	16
TUN	F	MSAKNI TESNIM	
TUR	F	HOCAOGLU AKYOL MELTEM	7
UZB	F	NURSEITOVA ANGELINA	

Senior Kumite Male +84kg
As of 10 NOV 2024

NOC Code	Gender	Name	Seeding
AZE	M	Gurbanli Asiman	8
BLR	M	Isakau Anton	
BLR	M	Kudzinou Ivan	
BLR	M	Vodchyts Aliaksei	
IRI	M	ABAZARI SALEH	14
IRI	M	ASHOURI GARMJANI MAHDI	15
IRI	M	GANJZADEH GHOUJEH BEIGLOU MAHDI	
IRI	M	Nemati Mahmoud	
KAZ	M	ANARBEOV DIAS	
KAZ	M	Taizhan Alisher	
RUS	M	Antohii Vasili	6
RUS	M	BELONOGOV KIRILL	
RUS	M	BUROV VLADISLAV	



MOSCOW-KARATE-UNIVERSE INTERNATIONAL ..
ENTRIES BY WEIGHT CATEGORY



Senior Kumite Male +84kg
As of 10 NOV 2024

NOC Code	Gender	Name	Seeding
RUS	M	Drozdov Maksim	
RUS	M	GOLOVIN MAKAR	1
RUS	M	Gusev Igor	
RUS	M	Kamyshov Daniil	7
RUS	M	KOKOVUROV KONSTANTIN	3
RUS	M	Kovalev Kirill	4
RUS	M	PCHENITCIN ALEKSANDR	2
RUS	M	Ponomarenko Michael	
SEN	M	GUEYE SALIOU	
SRB	M	TRIKOS BOGDAN	
TJK	M	RAKHIMOV FARUKHDZHON	
TUR	M	KILIÇ Emirhan	
UZB	M	ABDULLAEV JAVOKHIRKHON	
UZB	M	ISMATULLAYEV ISLOMBEK	

Senior Kumite Male -60kg
As of 10 NOV 2024

NOC Code	Gender	Name	Seeding
AZE	M	guliyev aminagha	15
AZE	M	savadov farid	24
BLR	M	Kashyrski Maksim	
BLR	M	Prykhodzka Pavel	
BLR	M	Vialionda Vadzim	
EGY	M	Mohamed Gaber	
IND	M	PYDIPATI BABI VARMA	
IND	M	SINDHIYA GAURAV	
ITA	M	Sabatino Christian	
KAZ	M	ALPYSBAY KAISAR	8
KAZ	M	BIGABYL ZHOLAMAN	
KAZ	M	Mussa Nurassyl	
KAZ	M	Timraliyev Darkhan	
KAZ	M	Turebek Yelnur	
KUW	M	HASAN NOUH	
MAD	M	RAJAONARISON CHRISTIANFINOANA	
PAK	M	RASHEED MUHAMMAD FARHAN	
RUS	M	BASCHIN EVGENIY	
RUS	M	BOLSHAKOV NIKITA	4
RUS	M	Pakhomov Suleyman	1
RUS	M	SALYNOV ALEKSANDR	3
RUS	M	Satybaldiev Erbol	
RUS	M	Savin Ilya	2
RUS	M	Surikov Artem	
SUI	M	Timmer Eric	16
TJK	M	Sultonov Alisher	



MOSCOW-KARATE-UNIVERSE INTERNATIONAL ..
ENTRIES BY WEIGHT CATEGORY



Senior Kumite Male -60kg
As of 10 NOV 2024

NOC Code	Gender	Name	Seeding
TJK	M	TESHAEV MUHAMMAD	
TUN	M	FERCHICHI IHEB	7
TUN	M	KHALIL KHALIL AHMED	
UZB	M	TURAKHONOV MEKHRIDDIN	

Senior Kumite Male -67kg
As of 10 NOV 2024

NOC Code	Gender	Name	Seeding
ARM	M	Harutyunyan Suren	15
AZE	M	mammadli huseyn	13
AZE	M	nuran rzazade	
BLR	M	Bahamolets Mikita	
BLR	M	Krautsou Artsiom	
BLR	M	Markau Matsvei	
BLR	M	Melyokhin Oleg	
BLR	M	Stahouski Arseni	
CIV	M	MEITE IBRAHIMA SY	
EGY	M	Fathy Ebrahim	
IND	M	DAS RUPESH	
ITA	M	De Vivo Gianluca	
ITA	M	Ingenito Angelo	
KAZ	M	ALTYNBEK OLZHAS	
KAZ	M	Tangirbergen Yersultan	
KGZ	M	Baratov Vizit	
KSA	M	HUSSAIN NASHWAN	
PAK	M	DIN SHAMS UD	
RUS	M	Akhmedov Akhmed	2
RUS	M	Danilov Daniil	5
RUS	M	Ilushin Anatoliy	4
RUS	M	Mikhailichenko Danila	7
RUS	M	Ogannisyan Yurik	1
RUS	M	SON EVGENII	8
RUS	M	Spitsin Sergey	3
RUS	M	UKHABOV PAVEL	6
SRB	M	JOKSIC STEFAN	
TJK	M	MASHRABOV SIYOVUSH	
TJK	M	Sharapov Abdulvahob	
TUR	M	YILMAZ Ekrem Altuner	
UZB	M	RASHIDOV ABDUL VAKHKHOB	
UZB	M	RASULOV MANSUR	



MOSCOW-KARATE-UNIVERSE INTERNATIONAL ..
ENTRIES BY WEIGHT CATEGORY



Senior Kumite Male -75kg
As of 10 NOV 2024

NOC Code	Gender	Name	Seeding
ALG	M	OUSSAMA ZAID	
ARM	M	Hovhannisyan Robert	
ARM	M	Karyan Hayk	
ARM	M	MAKYAN DAVIT	
BLR	M	Chymbur Raman	
BLR	M	Dubina Mikita	
BLR	M	Kryviankou Daniil	
BLR	M	Nhuyen Devid	
BLR	M	Rysevets Hleb	
BLR	M	Volosov Uladzislau	
EGY	M	Elsawy Aly	6
IND	M	SHARMA PRANAY	
IRI	M	Askaripour Mohammaderfan	16
IRI	M	Nemati Morteza	
IRI	M	SHAHGOL MAHDI	
KAZ	M	AZHIKANOV NURKANAT	8
KAZ	M	BATYRGALI ABILMANSUR	
KAZ	M	Ganiyev Alikhan	
KAZ	M	MUKHAT AIDOS	
KGZ	M	Nurlanov Nazim	
RUS	M	AKHMEDOV RUSTAM	7
RUS	M	Fedin Timofey	11
RUS	M	Gadzhiev Gadzhi	4
RUS	M	Grachev Semen	2
RUS	M	GRETSKIY DANIIL	
RUS	M	Khorsik Egor	3
RUS	M	Makhmudov Oleg	14
RUS	M	Pritmov Alexander	5
RUS	M	SHARAFUTDINOV ERNEST	1
SRB	M	TOPUZOVIC ALEKSANDAR	
UZB	M	MUKHAMMADIYEV KUVONCHBEK	

Senior Kumite Male -84kg
As of 10 NOV 2024

NOC Code	Gender	Name	Seeding
ALG	M	MOHAMED EL AMINE SELLOUM	
ARM	M	Nersisyan Gor	15
AZE	M	hasanov turgut	
BLR	M	Kiryievich Mikita	
BLR	M	Sachkouski Hleb	
BLR	M	Sakhvon Mikita	
EGY	M	BADAWY YOUSSEF	8
INA	M	YUSTISIO HUGGIES	
IRI	M	Asgari ghoncheh Bahman	6



MOSCOW-KARATE-UNIVERSE INTERNATIONAL ..
ENTRIES BY WEIGHT CATEGORY



Senior Kumite Male -84kg
As of 10 NOV 2024

NOC Code	Gender	Name	Seeding
IRI	M	HEYDARIYASAVOLI ALIREZA	
IRI	M	KHODABAKHSHI MAHDI	11
KAZ	M	TARNAKIN NIKITA	
KAZ	M	Ulbek Dias	
KAZ	M	YULDASHEV DANIYAR	12
KGZ	M	Iliasov Mukhammed	
RUS	M	ANTONYAN ARUTYUN	7
RUS	M	Bobrov Egor	4
RUS	M	Gabeliia Zurab	
RUS	M	GASPARYAN EDUARD	1
RUS	M	Guglevatyi Dmitriy	
RUS	M	Ivanian Enriko	
RUS	M	Kireev Egor	
RUS	M	Kurmanov Konshau-Biy	2
RUS	M	PETRAKOV DANIIL	3
RUS	M	Sisin Alexandr	
SRB	M	BREZANCIC VLADIMIR	
SUI	M	Gindre Maxime	
UAE	M	KHUDHAIR ZAYED	
UZB	M	NAMOOV SHUKHRATJON	
VEN	M	Martínez Edgar	



Statistics

Participating Countries: 31

	Competitors	Entries
Female	155	155
Male	175	175
Total	330	330

Entries per Category	Entries	Teams
Senior Kumite Female -50kg	25	-
Senior Kumite Female -55kg	29	-
Senior Kumite Female -61kg	27	-
Senior Kumite Female -68kg	26	-
Senior Kumite Female +68kg	18	-
Senior Kumite Male +84kg	27	-
Senior Kumite Male -60kg	30	-
Senior Kumite Male -67kg	32	-
Senior Kumite Male -75kg	31	-
Senior Kumite Male -84kg	30	-
Senior kata female	30	-
Senior kata male	25	-
Totals:	330	0

Daily Schedule

Order	Bout	Phase	Weight Category	Corner	Name	Seed	NOC
-------	------	-------	-----------------	--------	------	------	-----

Daily Schedule

- Results

Order	Bout	Start Time	Weight Category	Corner	Seed	Name	NOC	Winner	Result	Decision
-------	------	------------	-----------------	--------	------	------	-----	--------	--------	----------

SENIOR KUMITE FEMALE +68KG



MOSCOW-KARATE-UNIVERSE INTERNATIONAL ..
ENTRIES BY WEIGHT CATEGORY



Senior Kumite Female +68kg
As of 10 NOV 2024

NOC Code	Gender	Name	Seeding
ALG	F	Dounia Moukhtari	
EGY	F	Gomaa Asmaa	
EGY	F	Haidi Mahgoub	
KAZ	F	BERULTSEVA SOFYA	8
KGZ	F	Ryrenko Ekaterina	
PAK	F	ARZO ARZO	
RUS	F	Dorofeeva Varvara	
RUS	F	Garipova Yana	4
RUS	F	Khalimova Sunita	2
RUS	F	MIRONOVA TATYANA	3
RUS	F	Pipko Daria	1
RUS	F	SHISHOVA KSENIYA	
RUS	F	Tarasova Ekaterina	
TJK	F	Shukurbekova Yasmin	
TUN	F	JEMI CHEHINEZ	16
TUN	F	MSAKNI TESNIM	
TUR	F	HOCAOGLU AKYOL MELTEM	7
UZB	F	NURSEITOVA ANGELINA	









Senior Kumite Female +68kg - Round Robin (each against each)

MOSCOW-KARATE-UNIVERSE INTERNATIONAL 2024, Moscow, RUS

Tatami

Pool

1/6

1	 TARASOVA E. (RUS)	
	#367 / 09.11	2  TARASOVA E. (RUS)
2	 JEMI C. (TUN)	1
3	 TARASOVA E. (RUS)	
	#369 / 09.11	5  TARASOVA E. (RUS)
4	 RYRENKO E. (KGZ)	4
5	 JEMI C. (TUN)	
	#371 / 09.11	5  JEMI C. (TUN)
6	 RYRENKO E. (KGZ)	3

1. TARASOVA EKATERINA (RUS)
2. JEMI CHEHINEZ (TUN)
3. RYRENKO EKATERINA (KGZ)



1. BERULTSEVA SOFYA (KAZ)
2. PIPKO DARIA (RUS)
3. JEMI CHEHINEZ (TUN)
3. MSAKNI TESNIM (TUN)
5. HAIDI MAHGOUB (EGY)
5. SHISHOVA KSENIYA (RUS)
7. KHALIMOVA SUNITA (RUS)
7. HOCAOGLU AKYOL MELTEM (TUR)









Referees:			

Senior Kumite Female +68kg - Round Robin (each against each)

MOSCOW-KARATE-UNIVERSE INTERNATIONAL 2024, Moscow, RUS

Tatami

Pool
2/6

1	 HAIDI M. (EGY)	
	#368 / 09.11	7  HAIDI M. (EGY)
2	 MIRONOVA T. (RUS)	3
3	 HAIDI M. (EGY)	4  HAIDI M. (EGY)
	#370 / 09.11	
4	 SHISHOVA K. (RUS)	3
5	 MIRONOVA T. (RUS)	3  SHISHOVA K. (RUS)
	#372 / 09.11	
6	 SHISHOVA K. (RUS)	7

1. HAIDI MAHGOUB (EGY)
2. SHISHOVA KSENIYA (RUS)
3. MIRONOVA TATYANA (RUS)



1. BERULTSEVA SOFYA (KAZ)
2. PIPKO DARIA (RUS)
3. JEMI CHEHINEZ (TUN)
3. MSAKNI TESNIM (TUN)
5. HAIDI MAHGOUB (EGY)
5. SHISHOVA KSENIYA (RUS)
7. KHALIMOVA SUNITA (RUS)
7. HOCAOGLU AKYOL MELTEM (TUR)

Referees:			







Senior Kumite Female +68kg - Round Robin (each against each)

MOSCOW-KARATE-UNIVERSE INTERNATIONAL 2024, Moscow, RUS

Tatami

Pool

3/6

1	 HOCAOGLU AKYOL M. (TUR)	
	#373 / 09.11	10
2	 ARZO A. (PAK)	2
3	 HOCAOGLU AKYOL M. (TUR)	
	#375 / 09.11	9
4	 KHALIMOVA S. (RUS)	10
5	 ARZO A. (PAK)	
	#377 / 09.11	0
6	 KHALIMOVA S. (RUS)	7

1. KHALIMOVA SUNITA (RUS)
2. HOCAOGLU AKYOL MELTEM (TUR)
3. ARZO ARZO (PAK)



1. BERULTSEVA SOFYA (KAZ)
2. PIPKO DARIA (RUS)
3. JEMI CHEHINEZ (TUN)
3. MSAKNI TESNIM (TUN)
5. HAIDI MAHGOUB (EGY)
5. SHISHOVA KSENIYA (RUS)
7. KHALIMOVA SUNITA (RUS)
7. HOCAOGLU AKYOL MELTEM (TUR)

Referees:			

Senior Kumite Female +68kg - Round Robin (each against each)

MOSCOW-KARATE-UNIVERSE INTERNATIONAL 2024, Moscow, RUS

Tatami

Pool
4/6

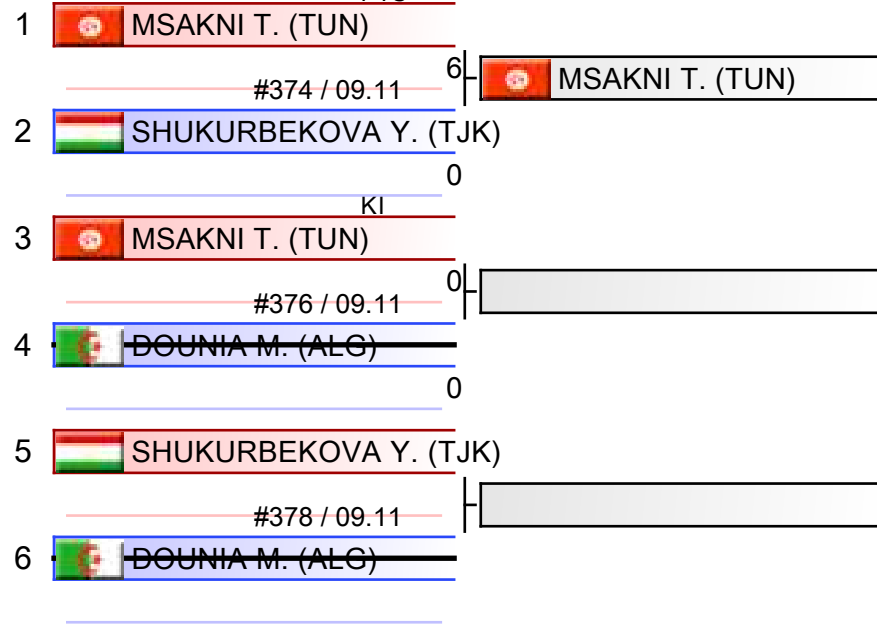

1. MSAKNI TESNIM (TUN)
2. DOUNIA MOUKHTARI (ALG)
3. SHUKURBEKOVA YASMIN (TJK)



1. BERULTSEVA SOFYA (KAZ)
2. PIPKO DARIA (RUS)
3. JEMI CHEHINEZ (TUN)
3. MSAKNI TESNIM (TUN)
5. HAIDI MAHGOUB (EGY)
5. SHISHOVA KSENIYA (RUS)
7. KHALIMOVA SUNITA (RUS)
7. HOCAOGLU AKYOL MELTEM (TUR)









Referees:			

Senior Kumite Female +68kg - Round Robin (each against each)

MOSCOW-KARATE-UNIVERSE INTERNATIONAL 2024, Moscow, RUS

Tatami

Pool
5/6

1	 NURSEITOVA A. (UZB)	#379 / 09.11	0	 GARIPOVA Y. (RUS)
2	 GARIPOVA Y. (RUS)		1	
3	 NURSEITOVA A. (UZB)	#381 / 09.11	1	 NURSEITOVA A. (UZB)
4	 DOROFEEVA V. (RUS)		0	
5	 GARIPOVA Y. (RUS)	#383 / 09.11	2	 GARIPOVA Y. (RUS)
6	 DOROFEEVA V. (RUS)		1	

1. GARIPOVA YANA (RUS)
2. NURSEITOVA ANGELINA (UZB)
3. DOROFEEVA VARVARA (RUS)



1. BERULTSEVA SOFYA (KAZ)
2. PIPKO DARIA (RUS)
3. JEMI CHEHINEZ (TUN)
3. MSAKNI TESNIM (TUN)
5. HAIDI MAHGOUB (EGY)
5. SHISHOVA KSENIYA (RUS)
7. KHALIMOVA SUNITA (RUS)
7. HOCAOGLU AKYOL MELTEM (TUR)

Referees:			

Senior Kumite Female +68kg - Round Robin (each against each)

MOSCOW-KARATE-UNIVERSE INTERNATIONAL 2024, Moscow, RUS

Tatami

Pool
6/6

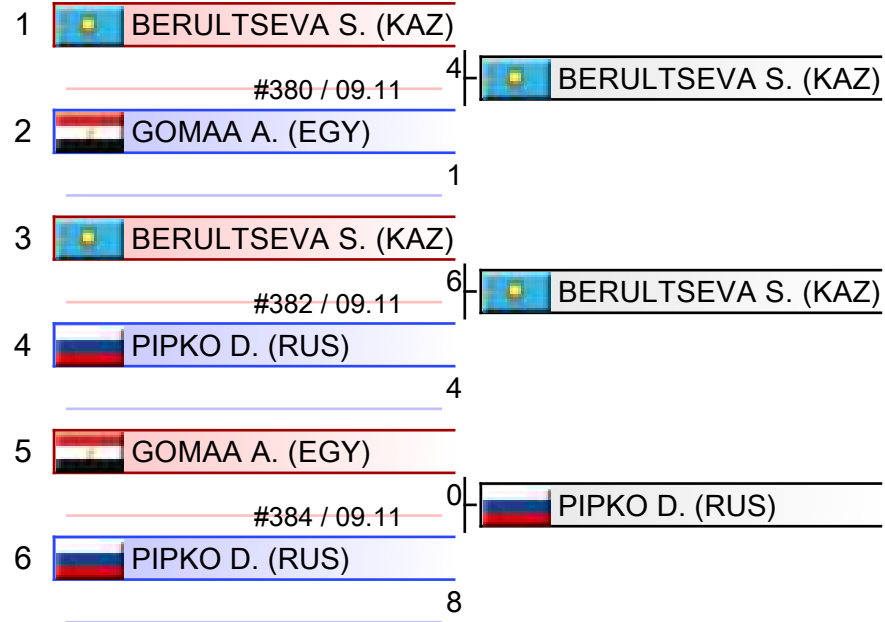

1. BERULTSEVA SOFYA (KAZ)
2. PIPKO DARIA (RUS)
3. GOMAA ASMAA (EGY)



1. BERULTSEVA SOFYA (KAZ)
2. PIPKO DARIA (RUS)
3. JEMI CHEHINEZ (TUN)
3. MSAKNI TESNIM (TUN)
5. HAIDI MAHGOUB (EGY)
5. SHISHOVA KSENIYA (RUS)
7. KHALIMOVA SUNITA (RUS)
7. HOCAOGLU AKYOL MELTEM (TUR)

Referees:			

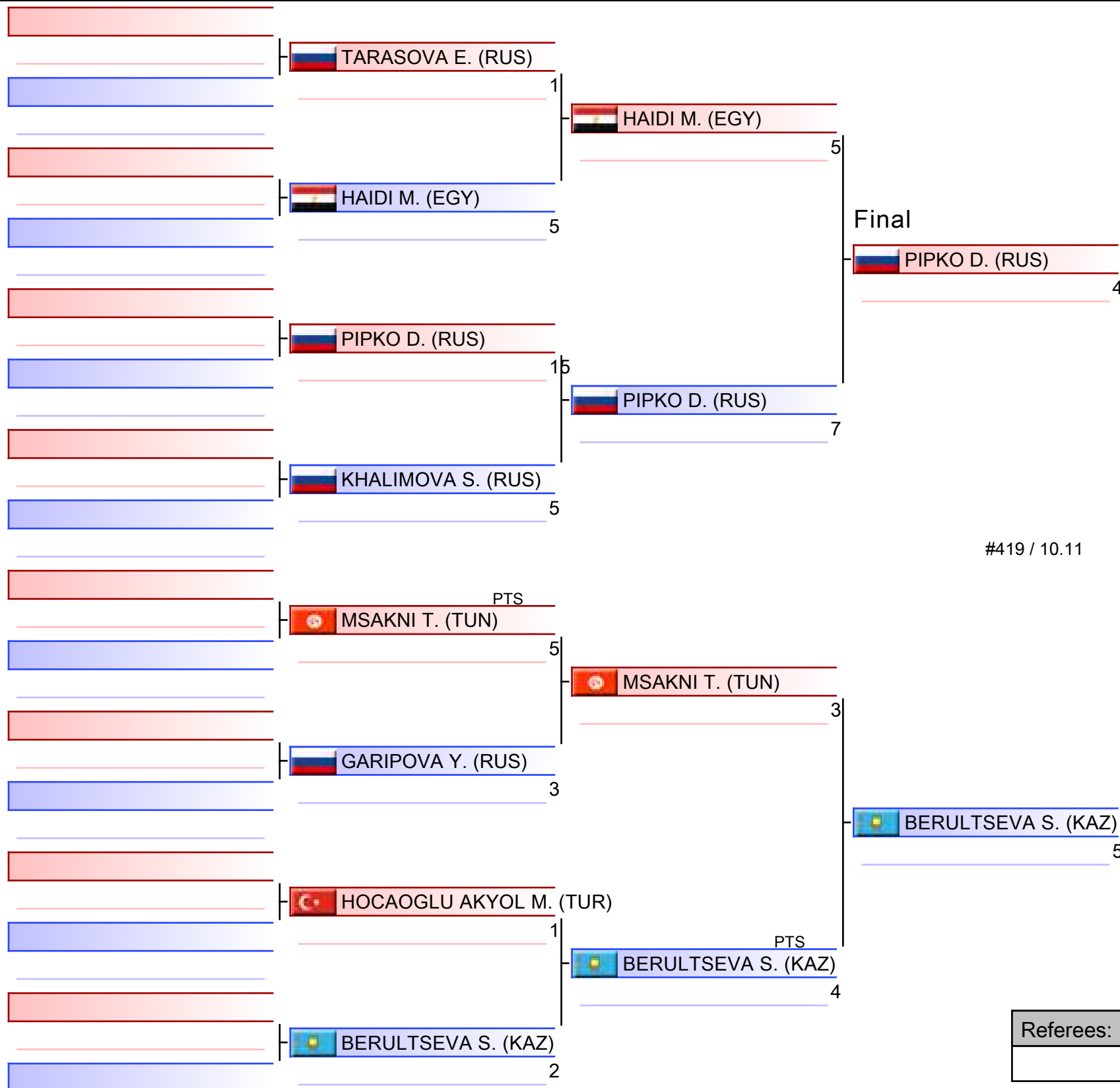

1. BERULTSEVA SOFYA (KAZ)
2. PIPKO DARIA (RUS)
3. JEMI CHEHINEZ (TUN)
3. MSAKNI TESNIM (TUN)
5. HAIDI MAHGOUB (EGY)
5. SHISHOVA KSENIYA (RUS)
7. KHALIMOVA SUNITA (RUS)
7. HOCAOGLU AKYOL MELTEM (TUR)

Referees:			

Senior Kumite Female +68kg

MOSCOW-KARATE-UNIVERSE INTERNATIONAL 2024

2024-11-09

Tatami

2 19:46

Pool

1,2,3,4,5,6

(c)sportdata GmbH & Co KG 2000-2024 (2024-11-10 18:21) v 10.2.0 build 1 (2024-07-20 11:09 CET) License: Online_Event_ID-8474_MOSCOWKARATEUNIVERSEINTERNATIONAL2024 (expire 2024-11-24)

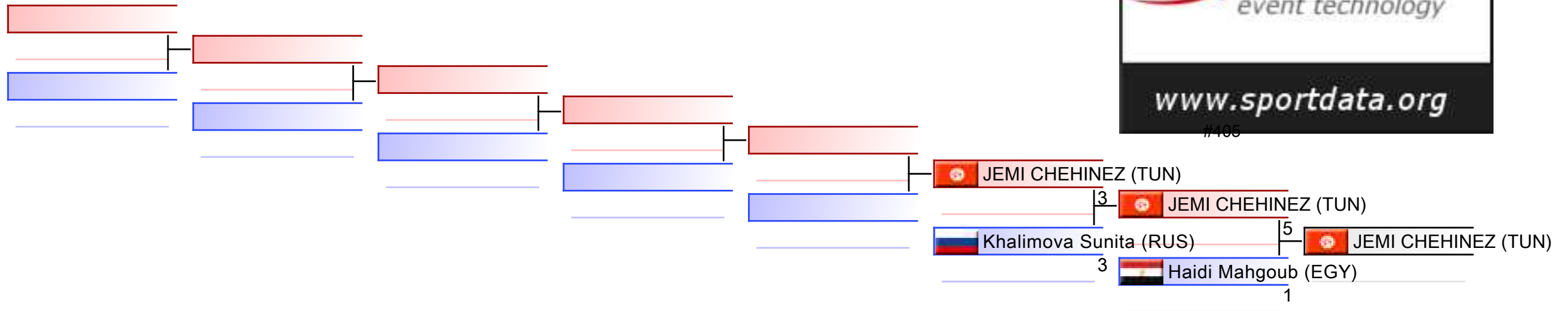

REPECHAGE: (1,2,3,4,5,6)

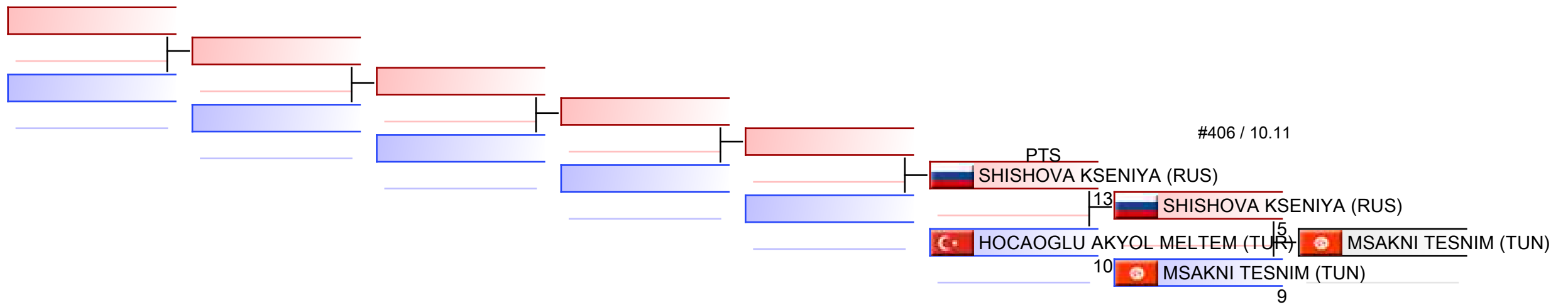

Referees:							
-----------	--	--	--	--	--	--	--



MOSCOW-KARATE-UNIVERSE
INTERNATIONAL 2024 - 2024-11-08



Official Results

Senior Kumite Female +68kg			
1	BERULTSEVA SOFYA		KAZ - KAZAKHSTAN
2	PIPKO DARIA		RUS - RUSSIAN FEDERATION
3	JEMI CHEHINEZ		TUN - TUNISIA
3	MSAKNI TESNIM		TUN - TUNISIA
5	HAIDI MAHGOUB		EGY - EGYPT
5	SHISHOVA KSENIYA		RUS - RUSSIAN FEDERATION
7	KHALIMOVA SUNITA		RUS - RUSSIAN FEDERATION
7	HOCAGLU AKYOL MELTEM		TUR - TURKIYE

SENIOR KUMITE FEMALE -50KG



MOSCOW-KARATE-UNIVERSE INTERNATIONAL ..
ENTRIES BY WEIGHT CATEGORY



Senior Kumite Female -50kg
As of 10 NOV 2024

NOC Code	Gender	Name	Seeding
ALG	F	RAYANE SEKKOUR	
AZE	F	alibayova khumar	
AZE	F	teymurova fidan	16
BLR	F	Barodzich Volha	
BLR	F	Markava Ulyana	
EGY	F	Mahmoud Gana	
KAZ	F	ZHANGBYRBAY MOLDIR	7
KGZ	F	Iarova Dali	
MGL	F	CHINZORIG ENKHZAYA	
MGL	F	NARMANDAKH NARANGOO	
RUS	F	DAVIDOVA VIKTORIYA	
RUS	F	Falkova Anastasia	
RUS	F	Garipova Kamilla	
RUS	F	Grigoreva Elizaveta	1
RUS	F	Ilina Daria	
RUS	F	PETKINA POLINA	
RUS	F	PUGACHEVA DARYA	
RUS	F	Razumnykh Anastasiya	4
RUS	F	SADYKOVA AIGUL	2
RUS	F	SAVKOVSKAYA TATIANA	
RUS	F	Sergeeva Valeriia	3
RUS	F	Sokolova Anastasia	
UAE	F	AL AJMI HAWRAA	
UZB	F	ALIMARDANOVA GULSHAN	15
VEN	F	Salazar Yorgelis	8

Senior Kumite Female -50kg - Round Robin (each against each)

MOSCOW-KARATE-UNIVERSE INTERNATIONAL 2024, Moscow, RUS

Tatami

Pool

1/8

1	DAVIDOVA V. (RUS)	
	#43 / 08.11	1 TEYMUROVA F. (AZE)
2	TEYMUROVA F. (AZE)	4
3	MARKAVA U. (BLR)	
	#44 / 08.11	8 MARKAVA U. (BLR)
4	RAYANE S. (ALG)	8
5	DAVIDOVA V. (RUS)	
	#46 / 08.11	3 DAVIDOVA V. (RUS)
6	MARKAVA U. (BLR)	3
7	RAYANE S. (ALG)	
	#47 / 08.11	2 TEYMUROVA F. (AZE)
8	TEYMUROVA F. (AZE)	3
9	DAVIDOVA V. (RUS)	
	#49 / 08.11	0 RAYANE S. (ALG)
10	RAYANE S. (ALG)	2
11	TEYMUROVA F. (AZE)	
	#50 / 08.11	1 TEYMUROVA F. (AZE)
12	MARKAVA U. (BLR)	5

1. TEYMUROVA FIDAN (AZE)
2. MARKAVA ULYANA (BLR)
3. RAYANE SEKKOUR (ALG)
4. DAVIDOVA VIKTORIYA (RUS)



1. ZHANGBYRBAY MOLDIR (KAZ)
2. GARİPOVA KAMILLA (RUS)
3. TEYMUROVA FIDAN (AZE)
3. SALAZAR YORGELIS (VEN)
5. SADYKOVA AIGUL (RUS)
5. AL AJMI HAWRAA (UAE)
7. MAHMOUD GANA (EGY)
7. GRIGOREVA ELIZAVETA (RUS)

Referees:			









Senior Kumite Female -50kg - Round Robin (each against each)

MOSCOW-KARATE-UNIVERSE INTERNATIONAL 2024, Moscow, RUS

Tatami

Pool

2/8

1	 IAROVA D. (KGZ)	
	#52 / 08.11	4  IAROVA D. (KGZ)
2	 PETKINA P. (RUS)	3
3	 IAROVA D. (KGZ)	2  SERGEEVA V. (RUS)
	#54 / 08.11	
4	 SERGEEVA V. (RUS)	6
	HA	
5	 PETKINA P. (RUS)	4  PETKINA P. (RUS)
	#56 / 08.11	
6	 SERGEEVA V. (RUS)	0

1. PETKINA POLINA (СВЕРДЛОВСКАЯ ОБЛ.)
2. SERGEEVA VALERIIA (МОСКВА)
3. IAROVA DALI ()



1. ZHANGBYRBAY MOLDIR (KAZ)
2. GARİPOVA KAMİLLA (RUS)
3. TEYMUROVA FİDAN (AZE)
3. SALAZAR YORGELIS (VEN)
5. SADYKOVA AIGUL (RUS)
5. AL AJMI HAWRAA (UAE)
7. MAHMOUD GANA (EGY)
7. GRIGOREVA ELIZAVETA (RUS)









Referees:			

Senior Kumite Female -50kg - Round Robin (each against each)

MOSCOW-KARATE-UNIVERSE INTERNATIONAL 2024, Moscow, RUS

Tatami

Pool
3/8

1	 MAHMOUD G. (EGY)	
	#58 / 08.11	7  MAHMOUD G. (EGY)
2	 SOKOLOVA A. (RUS)	1
3	 MAHMOUD G. (EGY)	1  ZHANGBYRBAY M. (KAZ)
	#60 / 08.11	
4	 ZHANGBYRBAY M. (KAZ)	6
5	 SOKOLOVA A. (RUS)	0  ZHANGBYRBAY M. (KAZ)
	#62 / 08.11	
6	 ZHANGBYRBAY M. (KAZ)	2

1. ZHANGBYRBAY MOLDIR (KAZ)
2. MAHMOUD GANA (EGY)
3. SOKOLOVA ANASTASIA (RUS)



1. ZHANGBYRBAY MOLDIR (KAZ)
2. GARİPOVA KAMILLA (RUS)
3. TEYMUROVA FIDAN (AZE)
3. SALAZAR YORGELIS (VEN)
5. SADYKOVA AIGUL (RUS)
5. AL AJMI HAWRAA (UAE)
7. MAHMOUD GANA (EGY)
7. GRIGOREVA ELIZAVETA (RUS)

Referees:			









Senior Kumite Female -50kg - Round Robin (each against each)

MOSCOW-KARATE-UNIVERSE INTERNATIONAL 2024, Moscow, RUS

Tatami

Pool

4/8

1	 NARMANDAKH N. (MGL)	0	 SAVKOVSKAYA T. (RUS)
	#64 / 08.11		
2	 SAVKOVSKAYA T. (RUS)	10	
3	 NARMANDAKH N. (MGL)	0	 SADYKOVA A. (RUS)
	#66 / 08.11		
4	 SADYKOVA A. (RUS)	8	
5	 SAVKOVSKAYA T. (RUS)	0	 SADYKOVA A. (RUS)
	#68 / 08.11		
6	 SADYKOVA A. (RUS)	3	

1. SADYKOVA AIGUL (RUS)
2. SAVKOVSKAYA TATIANA (RUS)
3. NARMANDAKH NARANGOO (MGL)



1. ZHANGBYRBAY MOLDIR (KAZ)
2. GARIPOVA KAMILA (RUS)
3. TEYMUROVA FIDAN (AZE)
3. SALAZAR YORGELIS (VEN)
5. SADYKOVA AIGUL (RUS)
5. AL AJMI HAWRAA (UAE)
7. MAHMOUD GANA (EGY)
7. GRIGOREVA ELIZAVETA (RUS)

Referees:			









Senior Kumite Female -50kg - Round Robin (each against each)

MOSCOW-KARATE-UNIVERSE INTERNATIONAL 2024, Moscow, RUS

Tatami

Pool

5/8

1	 ALIBAYOVA K. (AZE)		
	#59 / 08.11	4	 ALIBAYOVA K. (AZE)
2	 ALIMARDANOVA G. (UZB)	3	
3	 ALIBAYOVA K. (AZE)	8	 ALIBAYOVA K. (AZE)
	#61 / 08.11		
4	 FALKOVA A. (RUS)	0	
5	 ALIMARDANOVA G. (UZB)	9	 ALIMARDANOVA G. (UZB)
	#63 / 08.11		
6	 FALKOVA A. (RUS)	0	

1. ALIBAYOVA KHUMAR (AZE)
2. ALIMARDANOVA GULSHAN (UZB)
3. FALKOVA ANASTASIA (RUS)



1. ZHANGBYRBAY MOLDIR (KAZ)
2. GARIPOVA KAMILLA (RUS)
3. TEYMUROVA FIDAN (AZE)
3. SALAZAR YORGELIS (VEN)
5. SADYKOVA AIGUL (RUS)
5. AL AJMI HAWRAA (UAE)
7. MAHMOUD GANA (EGY)
7. GRIGOREVA ELIZAVETA (RUS)

Referees:			

Senior Kumite Female -50kg - Round Robin (each against each)

MOSCOW-KARATE-UNIVERSE INTERNATIONAL 2024, Moscow, RUS

Tatami

Pool
6/8

1	PUGACHEVA D. (RUS)	
	#45 / 08.11	1 AL AJMI H. (UAE)
2	AL AJMI H. (UAE)	4
3	PUGACHEVA D. (RUS)	
	#48 / 08.11	1 RAZUMNYKH A. (RUS)
4	RAZUMNYKH A. (RUS)	3
5	AL AJMI H. (UAE)	
	#51 / 08.11	9 AL AJMI H. (UAE)
6	RAZUMNYKH A. (RUS)	8

1. AL AJMI HAWRAA (UAE)
2. RAZUMNYKH ANASTASIYA (RUS)
3. PUGACHEVA DARYA (RUS)



1. ZHANGBYRBAY MOLDIR (KAZ)
2. GARIPOVA KAMILLA (RUS)
3. TEYMUROVA FIDAN (AZE)
3. SALAZAR YORGELIS (VEN)
5. SADYKOVA AIGUL (RUS)
5. AL AJMI HAWRAA (UAE)
7. MAHMOUD GANA (EGY)
7. GRIGOREVA ELIZAVETA (RUS)

Referees:			

Senior Kumite Female -50kg - Round Robin (each against each)

MOSCOW-KARATE-UNIVERSE INTERNATIONAL 2024, Moscow, RUS

Tatami

Pool

7/8

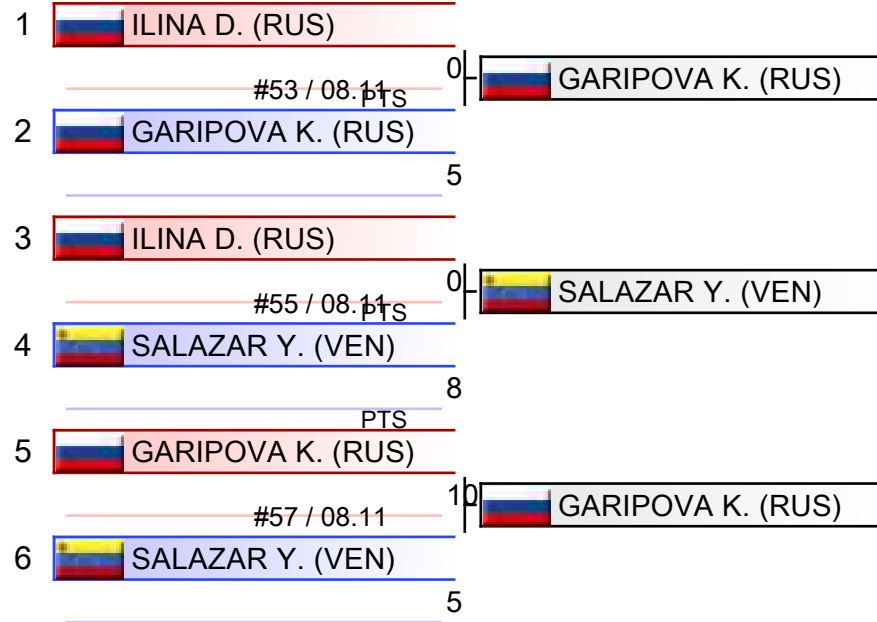

1. GARIPOVA KAMILLA (RUS)
2. SALAZAR YORGELIS (VEN)
3. ILINA DARIA (RUS)



1. ZHANGBYRBAY MOLDIR (KAZ)
2. GARIPOVA KAMILLA (RUS)
3. TEYMUROVA FIDAN (AZE)
3. SALAZAR YORGELIS (VEN)
5. SADYKOVA AIGUL (RUS)
5. AL AJMI HAWRAA (UAE)
7. MAHMOUD GANA (EGY)
7. GRIGOREVA ELIZAVETA (RUS)









Referees:			

Senior Kumite Female -50kg - Round Robin (each against each)

MOSCOW-KARATE-UNIVERSE INTERNATIONAL 2024, Moscow, RUS

Tatami

Pool
8/8

1	 CHINZORIG E. (MGL)	
	#65 / 08.11	1  BARODZICH V. (BLR)
2	 BARODZICH V. (BLR)	3
3	 CHINZORIG E. (MGL)	
	#67 / 08.11	1  GRIGOREVA E. (RUS)
4	 GRIGOREVA E. (RUS)	3
5	 BARODZICH V. (BLR)	
	#69 / 08.11	0  GRIGOREVA E. (RUS)
6	 GRIGOREVA E. (RUS)	8

1. GRIGOREVA ELIZAVETA (RUS)
2. BARODZICH VOLHA (BLR)
3. CHINZORIG ENKHZAYA (MGL)



1. ZHANGBYRBAY MOLDIR (KAZ)
2. GARİPOVA KAMİLLA (RUS)
3. TEYMUROVA FİDAN (AZE)
3. SALAZAR YORGELIS (VEN)
5. SADYKOVA AIGUL (RUS)
5. AL AJMI HAWRAA (UAE)
7. MAHMOUD GANA (EGY)
7. GRIGOREVA ELIZAVETA (RUS)

Referees:			

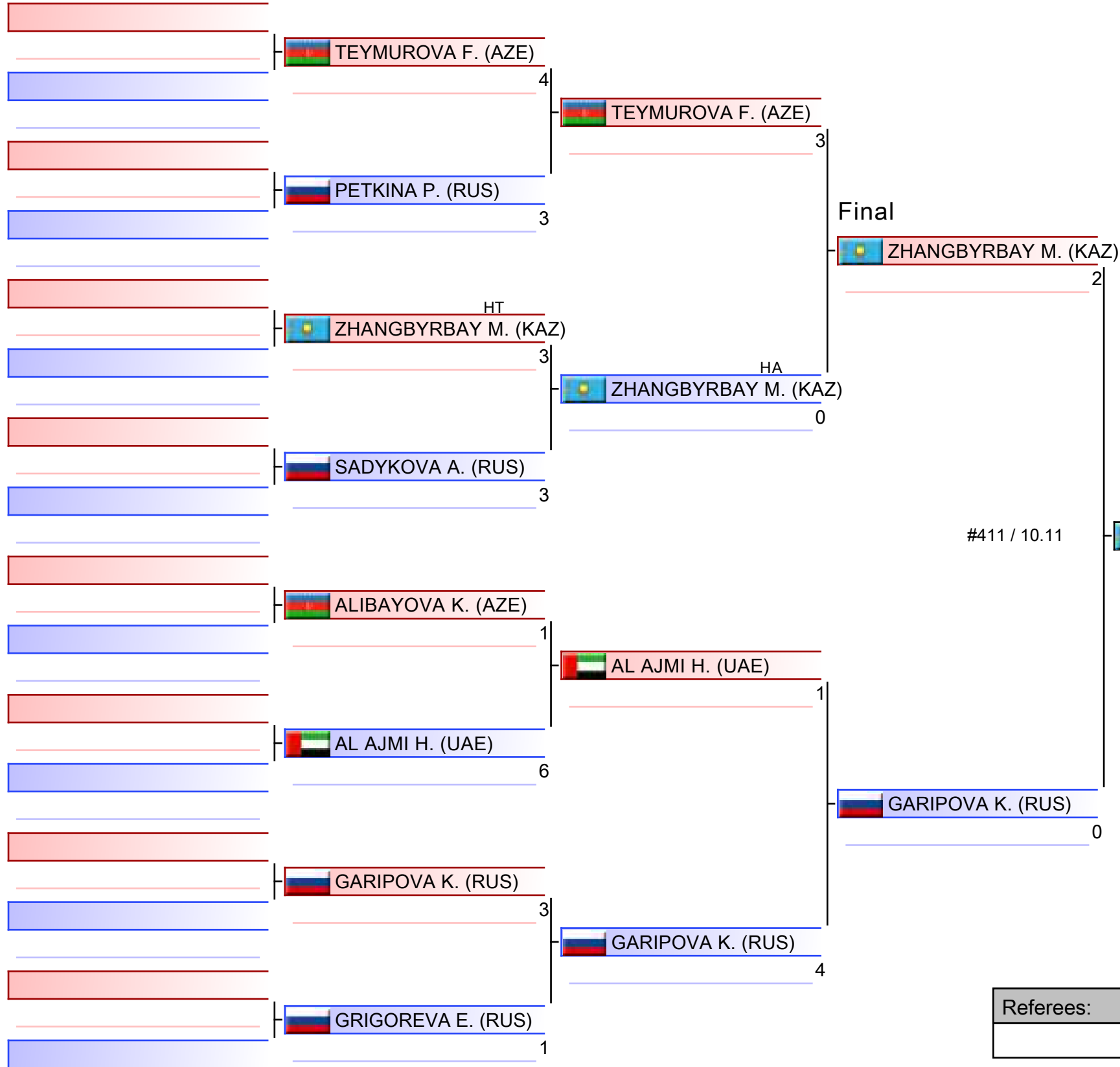

1. ZHANGBYRBAY MOLDIR (KAZ)
2. GARIPOVA KAMILLA (RUS)
3. TEYMUROVA FIDAN (AZE)
3. SALAZAR YORGELIS (VEN)
5. SADYKOVA AIGUL (RUS)
5. AL AJMI HAWRAA (UAE)
7. MAHMOUD GANA (EGY)
7. GRIGOREVA ELIZAVETA (RUS)

Referees:			

Senior Kumite Female -50kg

MOSCOW-KARATE-UNIVERSE INTERNATIONAL 2024

2024-11-08

Tatami
3 20:00

Pool
1,2,3,4,5,6,7,8

(c)sportdata GmbH & Co KG 2000-2024 (2024-11-10 18:21) v 10.2.0 build 1 (2024-07-20 11:09 CET) License: Online_Event_ID-8474_MOSCOWKARATEUNIVERSEINTERNATIONAL2024 (expire 2024-11-24)

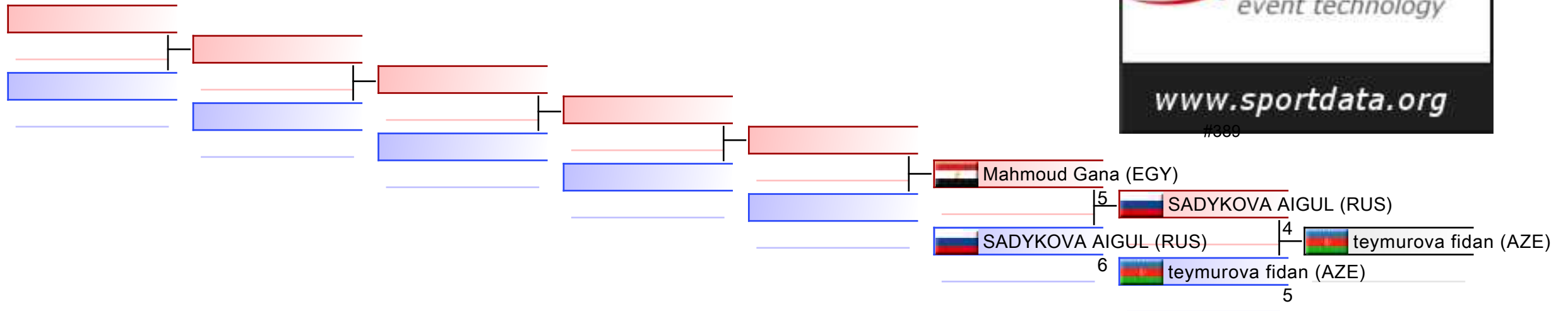

REPECHAGE: (1,2,3,4,5,6,7,8)

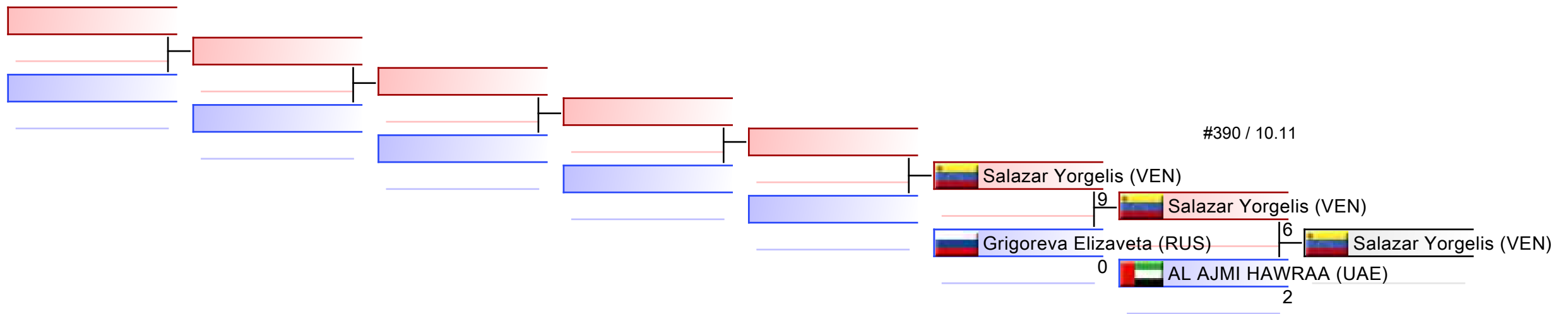

Referees:							
-----------	--	--	--	--	--	--	--



MOSCOW-KARATE-UNIVERSE
INTERNATIONAL 2024 - 2024-11-08



Official Results

Senior Kumite Female -50kg			
1	ZHANGBYRBAY MOLDIR		KAZ - KAZAKHSTAN
2	GARIPOVA KAMILLA		RUS - RUSSIAN FEDERATION
3	TEYMUROVA FIDAN		AZE - AZERBAIJAN
3	SALAZAR YORGELIS		VEN - VENEZUELA
5	SADYKOVA AIGUL		RUS - RUSSIAN FEDERATION
5	AL AJMI HAWRAA		UAE - UNITED ARAB EMIRATES
7	MAHMOUD GANA		EGY - EGYPT
7	GRIGOREVA ELIZAVETA		RUS - RUSSIAN FEDERATION

SENIOR KUMITE FEMALE -55KG



MOSCOW-KARATE-UNIVERSE INTERNATIONAL ..
ENTRIES BY WEIGHT CATEGORY



Senior Kumite Female -55kg
As of 10 NOV 2024

NOC Code	Gender	Name	Seeding
AZE	F	Karimova Suada	
AZE	F	sadigova madina	7
BUL	F	Goranova Ivet	8
CUB	F	Torres Alverd Baurelys de la Caridad	
EGY	F	Attia Mirna	
INA	F	AGUNG SANISTYARANI COK ISTRI	
KAZ	F	Alimanova Madina	
KAZ	F	Samasheva Bella	6
KAZ	F	Ussenova Gulmira	
KAZ	F	YERDAULET ASEMGUL	
RUS	F	Bibikova Anna	
RUS	F	Boiko Anna	
RUS	F	Boradzova Kamila	3
RUS	F	Chernysheva Anna	1
RUS	F	Dimova Valeriia	
RUS	F	Iushkevich Vasilina	
RUS	F	KOSTYUSHKINA ZHANNA	2
RUS	F	LAVROVA POLINA	
RUS	F	PEREVOZCHIKOVA ANNA	4
RUS	F	RUSANOVA VITALIYA	
RUS	F	SAZHINA ARINA	
RUS	F	SMETANINA ANASTASIYA	
RUS	F	Sotyreva Mariya	
RUS	F	Verevkina Mariya	
RUS	F	Vishnyakova Viktoriya	
RUS	F	Zvyagentseva Olga	
TUN	F	ZARRATI CHIRINE	
TUR	F	Ghorbi Nahal	
UZB	F	RAKHIMOVA SEVINCH	

Senior Kumite Female -55kg - Round Robin (each against each)

MOSCOW-KARATE-UNIVERSE INTERNATIONAL 2024, Moscow, RUS

Tatami

Pool

1/8

1	IUSHKEVICH V. (RUS)		
	#118 / 08.11	6	IUSHKEVICH V. (RUS)
2	GHORBI N. (TUR)	1	
3	ZVYAGENTSEVA O. (RUS)		
	#119 / 08.11	2	SAMASHEVA B. (KAZ)
4	SAMASHEVA B. (KAZ)	4	
5	IUSHKEVICH V. (RUS)		
	#121 / 08.11	10	IUSHKEVICH V. (RUS)
6	ZVYAGENTSEVA O. (RUS)	2	
7	SAMASHEVA B. (KAZ)		
	#122 / 08.11	8	SAMASHEVA B. (KAZ)
8	GHORBI N. (TUR)	0	
9	IUSHKEVICH V. (RUS)		
	#124 / 08.11	7	IUSHKEVICH V. (RUS)
10	SAMASHEVA B. (KAZ)	4	
11	GHORBI N. (TUR)		
	#125 / 08.11	0	ZVYAGENTSEVA O. (RUS)
12	ZVYAGENTSEVA O. (RUS)	8	

1. IUSHKEVICH VASILINA (RUS)
2. SAMASHEVA BELLA (KAZ)
3. ZVYAGENTSEVA OLGA (RUS)
4. GHORBI NAHAL (TUR)



1. GORANOVA IVET (BUL)
2. USSENOVA GULMIRA (KAZ)
3. SADIGOVA MADINA (AZE)
3. PEREVOZCHIKOVA ANNA (RUS)
5. IUSHKEVICH VASILINA (RUS)
5. CHERNYSHEVA ANNA (RUS)
7. AGUNG SANISTYARANI COK ISTRY (INA)
7. RAKHIMOVA SEVINCH (UZB)

Referees:			

Senior Kumite Female -55kg - Round Robin (each against each)

MOSCOW-KARATE-UNIVERSE INTERNATIONAL 2024, Moscow, RUS

Tatami

Pool
2/8

1	TORRES ALVERD B. (CUB)	
	#127 / 08.11	3 TORRES ALVERD B. (CUB)
2	VISHNYAKOVA V. (RUS)	
		3
		KO
3	SAZHINA A. (RUS)	
	#128 / 08.11	BORADZOVA K. (RUS)
4	BORADZOVA K. (RUS)	
5	TORRES ALVERD B. (CUB)	
	#131 / 08.11	KO TORRES ALVERD B. (CUB)
6	SAZHINA A. (RUS)	
7	BORADZOVA K. (RUS)	
	#132 / 08.11	7 BORADZOVA K. (RUS)
8	VISHNYAKOVA V. (RUS)	
		1
9	TORRES ALVERD B. (CUB)	
	#135 / 08.11	2 BORADZOVA K. (RUS)
10	BORADZOVA K. (RUS)	
		3
11	VISHNYAKOVA V. (RUS)	
	#136 / 08.11	KO VISHNYAKOVA V. (RUS)
12	SAZHINA A. (RUS)	

1. BORADZOVA KAMILA (RUS)
2. TORRES ALVERD BAURELYS DE LA CARIDAD (CUB)
3. VISHNYAKOVA VIKTORIYA (RUS)
4. SAZHINA ARINA (RUS)



1. GORANOVA IVET (BUL)
2. USSENOVA GULMIRA (KAZ)
3. SADIGOVA MADINA (AZE)
3. PEREVOZCHIKOVA ANNA (RUS)
5. IUSHKEVICH VASILINA (RUS)
5. CHERNYSHEVA ANNA (RUS)
7. AGUNG SANISTYARANI COK ISTRY (INA)
7. RAKHIMOVA SEVINCH (UZB)







Referees:			

Senior Kumite Female -55kg - Round Robin (each against each)

MOSCOW-KARATE-UNIVERSE INTERNATIONAL 2024, Moscow, RUS

Tatami

Pool
3/8

1	 USSENOVA G. (KAZ)	
	#139 / 08.11	3
2	 VEREVKINA M. (RUS)	1
3	 BIBIKOVA A. (RUS)	0
	#140 / 08.11	0
4	 SADIGOVA M. (AZE)	6
5	 USSENOVA G. (KAZ)	5
	#142 / 08.11	5
6	 BIBIKOVA A. (RUS)	0
7	 SADIGOVA M. (AZE)	3
	#143 / 08.11	3
8	 VEREVKINA M. (RUS)	0
9	 USSENOVA G. (KAZ)	6
	#145 / 08.11	6
10	 SADIGOVA M. (AZE)	2
11	 VEREVKINA M. (RUS)	3
	#146 / 08.11	3
12	 BIBIKOVA A. (RUS)	5

1. USSENOVA GULMIRA (KAZ)
2. SADIGOVA MADINA (AZE)
3. BIBIKOVA ANNA (RUS)
4. VEREVKINA MARIYA (RUS)



1. GORANOVA IVET (BUL)
2. USSENOVA GULMIRA (KAZ)
3. SADIGOVA MADINA (AZE)
3. PEREVOZCHIKOVA ANNA (RUS)
5. IUSHKEVICH VASILINA (RUS)
5. CHERNYSHEVA ANNA (RUS)
7. AGUNG SANISTYARANI COK ISTRY (INA)
7. RAKHIMOVA SEVINCH (UZB)

Referees:			









Senior Kumite Female -55kg - Round Robin (each against each)

MOSCOW-KARATE-UNIVERSE INTERNATIONAL 2024, Moscow, RUS

Tatami

Pool

4/8

1	 RUSANOVA V. (RUS)	
	#150 / 08.11	2  AGUNG SANISTYARANI C. (INA)
2	 AGUNG SANISTYARANI C. (INA)	5
3	 RUSANOVA V. (RUS)	
	#153 / 08.11	3  RUSANOVA V. (RUS)
4	 KOSTYUSHKINA Z. (RUS)	2
5	 AGUNG SANISTYARANI C. (INA)	
	#156 / 08.11	2  AGUNG SANISTYARANI C. (INA)
6	 KOSTYUSHKINA Z. (RUS)	0

1. AGUNG SANISTYARANI COK ISTRI (INA)
2. RUSANOVA VITALIYA (RUS)
3. KOSTYUSHKINA ZHANNA (RUS)



1. GORANOVA IVET (BUL)
2. USSENOVA GULMIRA (KAZ)
3. SADIGOVA MADINA (AZE)
3. PEREVOZCHIKOVA ANNA (RUS)
5. IUSHKEVICH VASILINA (RUS)
5. CHERNYSHEVA ANNA (RUS)
7. AGUNG SANISTYARANI COK ISTRI (INA)
7. RAKHIMOVA SEVINCH (UZB)

Referees:			





Senior Kumite Female -55kg - Round Robin (each against each)

MOSCOW-KARATE-UNIVERSE INTERNATIONAL 2024, Moscow, RUS

Tatami

Pool

5/8

1	 ATTIA M. (EGY)	
	#148 / 08.11	1  ATTIA M. (EGY)
2	 LAVROVA P. (RUS)	0
3	 KARIMOVA S. (AZE)	
	#149 / 08.11	6  SMETANINA A. (RUS)
4	 SMETANINA A. (RUS)	6
5	 ATTIA M. (EGY)	
	#151 / 08.11	2  ATTIA M. (EGY)
6	 KARIMOVA S. (AZE)	1
7	 SMETANINA A. (RUS)	
	#152 / 08.11	1  LAVROVA P. (RUS)
8	 LAVROVA P. (RUS)	4
9	 ATTIA M. (EGY)	
	#154 / 08.11	1  SMETANINA A. (RUS)
10	 SMETANINA A. (RUS)	3
11	 LAVROVA P. (RUS)	
	#155 / 08.11	3  LAVROVA P. (RUS)
12	 KARIMOVA S. (AZE)	2

1. SMETANINA ANASTASIYA (RUS)
2. LAVROVA POLINA (RUS)
3. ATTIA MIRNA (EGY)
4. KARIMOVA SUADA (AZE)



1. GORANOVA IVET (BUL)
2. USSENOVA GULMIRA (KAZ)
3. SADIGOVA MADINA (AZE)
3. PEREVOZCHIKOVA ANNA (RUS)
5. IUSHKEVICH VASILINA (RUS)
5. CHERNYSHEVA ANNA (RUS)
7. AGUNG SANISTYARANI COK ISTRY (INA)
7. RAKHIMOVA SEVINCH (UZB)

Referees:			









Senior Kumite Female -55kg - Round Robin (each against each)

MOSCOW-KARATE-UNIVERSE INTERNATIONAL 2024, Moscow, RUS

Tatami

Pool

6/8

1	 BOIKO A. (RUS)	
	#120 / 08.11	2  YERDAULET A. (KAZ)
2	 YERDAULET A. (KAZ)	3
3	 BOIKO A. (RUS)	
	#123 / 08.11	2  PEREVOZCHIKOVA A. (RUS)
4	 PEREVOZCHIKOVA A. (RUS)	7
5	 YERDAULET A. (KAZ)	
	#126 / 08.11	2  PEREVOZCHIKOVA A. (RUS)
6	 PEREVOZCHIKOVA A. (RUS)	8

1. PEREVOZCHIKOVA ANNA (RUS)
2. YERDAULET ASEMGUL (KAZ)
3. BOIKO ANNA (RUS)



1. GORANOVA IVET (BUL)
2. USSENOVA GULMIRA (KAZ)
3. SADIGOVA MADINA (AZE)
3. PEREVOZCHIKOVA ANNA (RUS)
5. IUSHKEVICH VASILINA (RUS)
5. CHERNYSHEVA ANNA (RUS)
7. AGUNG SANISTYARANI COK ISTRY (INA)
7. RAKHIMOVA SEVINCH (UZB)

Referees:			



















Senior Kumite Female -55kg - Round Robin (each against each)

MOSCOW-KARATE-UNIVERSE INTERNATIONAL 2024, Moscow, RUS

Tatami

Pool

7/8

1	 SOTYREVA M. (RUS)	
	#129 / 08.11	1  ALIMANOVA M. (KAZ)
2	 ALIMANOVA M. (KAZ)	2
3	 RAKHIMOVA S. (UZB)	
	#130 / 08.11	0  GORANOVA I. (BUL)
4	 GORANOVA I. (BUL)	6
5	 SOTYREVA M. (RUS)	
	#133 / 08.11	0  RAKHIMOVA S. (UZB)
6	 RAKHIMOVA S. (UZB)	4
7	 GORANOVA I. (BUL)	
	#134 / 08.11	8  GORANOVA I. (BUL)
8	 ALIMANOVA M. (KAZ)	0
9	 SOTYREVA M. (RUS)	
	#137 / 08.11	0  GORANOVA I. (BUL)
10	 GORANOVA I. (BUL)	6
11	 ALIMANOVA M. (KAZ)	
	#138 / 08.11	0  RAKHIMOVA S. (UZB)
12	 RAKHIMOVA S. (UZB)	3

1. GORANOVA IVET (BUL)
2. RAKHIMOVA SEVINCH (UZB)
3. ALIMANOVA MADINA (KAZ)
4. SOTYREVA MARIYA (RUS)



1. GORANOVA IVET (BUL)
2. USSENOVA GULMIRA (KAZ)
3. SADIGOVA MADINA (AZE)
3. PEREVOZCHIKOVA ANNA (RUS)
5. IUSHKEVICH VASILINA (RUS)
5. CHERNYSHEVA ANNA (RUS)
7. AGUNG SANISTYARANI COK ISTRY (INA)
7. RAKHIMOVA SEVINCH (UZB)

Referees:			

Senior Kumite Female -55kg - Round Robin (each against each)

MOSCOW-KARATE-UNIVERSE INTERNATIONAL 2024, Moscow, RUS

Tatami

Pool
8/8

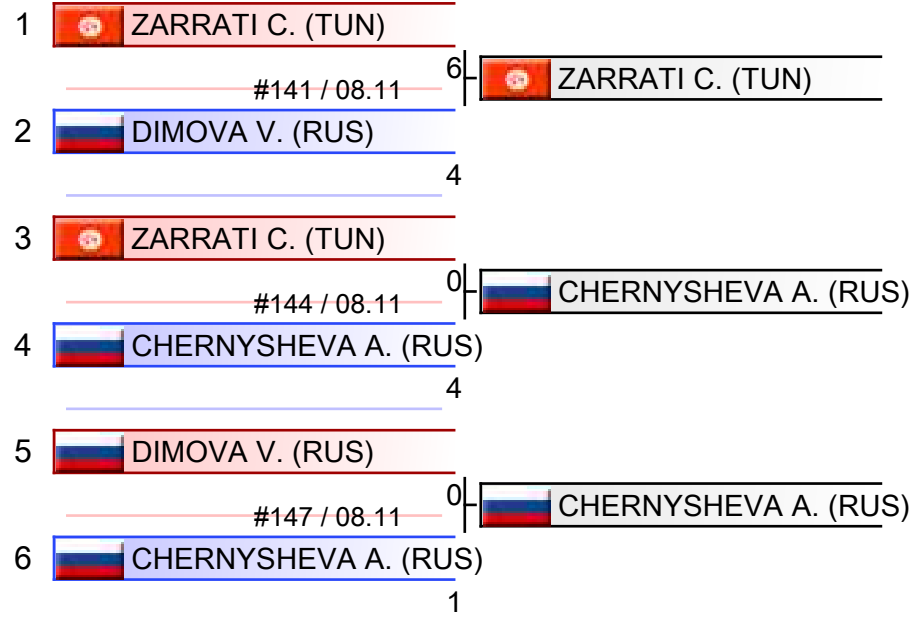

1. CHERNYSHEVA ANNA (RUS)
2. ZARRATI CHIRINE (TUN)
3. DIMOVA VALERIIA (RUS)



1. GORANOVA IVET (BUL)
2. USSENOVA GULMIRA (KAZ)
3. SADIGOVA MADINA (AZE)
3. PEREVOZCHIKOVA ANNA (RUS)
5. IUSHKEVICH VASILINA (RUS)
5. CHERNYSHEVA ANNA (RUS)
7. AGUNG SANISTYARANI COK ISTRY (INA)
7. RAKHIMOVA SEVINCH (UZB)

Referees:			

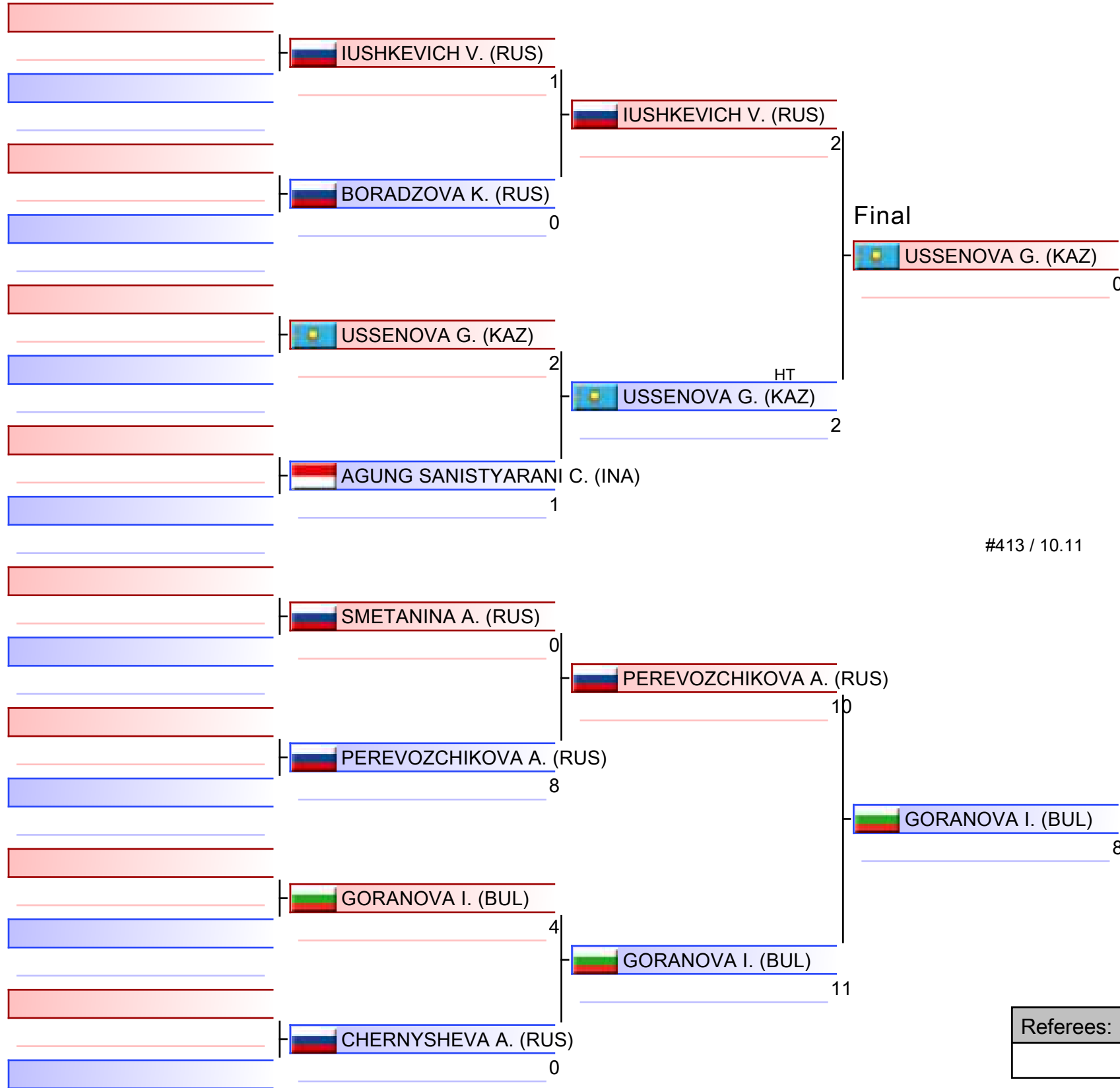

#413 / 10.11

1. GORANOVA IVET (BUL)
2. USSENOVA GULMIRA (KAZ)
3. SADIGOVA MADINA (AZE)
3. PEREVOZCHIKOVA ANNA (RUS)
5. IUSHKEVICH VASILINA (RUS)
5. CHERNYSHEVA ANNA (RUS)
7. AGUNG SANISTYARANI COK ISTRY (INA)
7. RAKHIMOVA SEVINCH (UZB)

Referees:			

Senior Kumite Female -55kg

MOSCOW-KARATE-UNIVERSE INTERNATIONAL 2024

2024-11-08

Tatami
3 20:10

Pool
1,2,3,4,5,6,7,8

(c)sportdata GmbH & Co KG 2000-2024 (2024-11-10 18:21) v 10.2.0 build 1 (2024-07-20 11:09 CET) License: Online_Event_ID-8474_MOSCOWKARATEUNIVERSEINTERNATIONAL2024 (expire 2024-11-24)

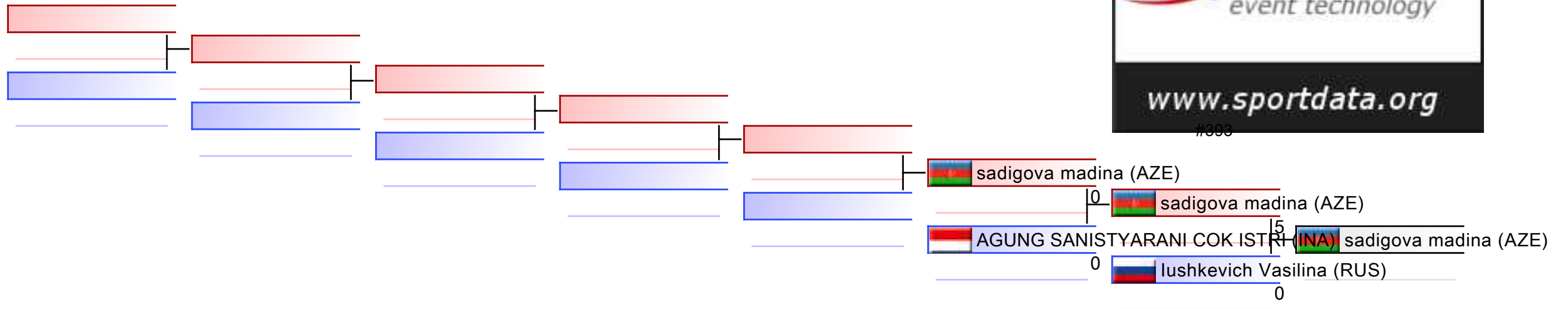

REPECHAGE: (1,2,3,4,5,6,7,8)

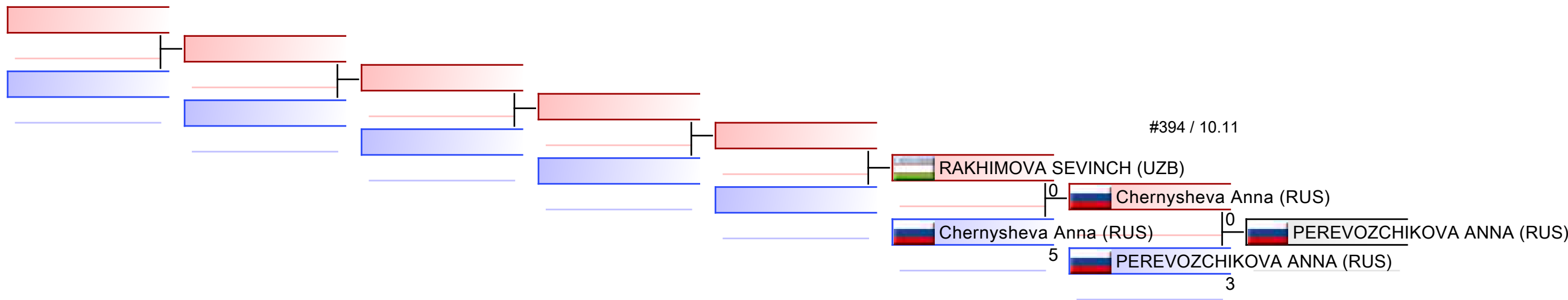

Referees:							
-----------	--	--	--	--	--	--	--



MOSCOW-KARATE-UNIVERSE
INTERNATIONAL 2024 - 2024-11-08



Official Results

Senior Kumite Female -55kg			
1	GORANOVA IVET		BUL - BULGARIA
2	USSENOVA GULMIRA		KAZ - KAZAKHSTAN
3	SADIGOVA MADINA		AZE - AZERBAIJAN
3	PEREVOZCHIKOVA ANNA		RUS - RUSSIAN FEDERATION
5	IUSHKEVICH VASILINA		RUS - RUSSIAN FEDERATION
5	CHERNYSHEVA ANNA		RUS - RUSSIAN FEDERATION
7	AGUNG SANISTYARANI COK ISTRY		INA - INDONESIA
7	RAKHIMOVA SEVINCH		UZB - UZBEKISTAN

SENIOR KUMITE FEMALE -61KG



MOSCOW-KARATE-UNIVERSE INTERNATIONAL ..
ENTRIES BY WEIGHT CATEGORY



Senior Kumite Female -61kg
As of 10 NOV 2024

NOC Code	Gender	Name	Seeding
AZE	F	arabli renata	
BLR	F	Azarava Maryia	
BLR	F	Chystsiakova Varvara	
BLR	F	Konnava Yana	
EGY	F	Tolba Rahma	8
KAZ	F	Bakirova Aizhan	16
KAZ	F	KANAY ASSEL	7
KAZ	F	Tizimbay Nuriya	
PAK	F	GUL MA	
RUS	F	Abramova Valeria	
RUS	F	Basangova Altana	3
RUS	F	BIKMETOVA AIDA	5
RUS	F	Chizhikova Dariya	4
RUS	F	Chupina Anastasiya	1
RUS	F	DEMENEVA VARVARA	
RUS	F	FILIMONOVA ANASTASIYA	
RUS	F	Goretskaya Polina	
RUS	F	Kochieva Alana	6
RUS	F	Rodina Anna	2
RUS	F	Sadovskaya Mariya	
RUS	F	TEPIKINA KSENIIA	
RUS	F	Tsysova Anastasia	
SRB	F	TRIKOS MINA	
TUR	F	Büber Nurbade	
TUR	F	Seyedefereshteh RAZAVI	
UZB	F	Ganieva Dilnoza	
UZB	F	OTABOYEVA SEVINCH UZB02811	



















Senior Kumite Female -61kg - Round Robin (each against each)

MOSCOW-KARATE-UNIVERSE INTERNATIONAL 2024, Moscow, RUS

Tatami

Pool

1/8

1	 GUL M. (PAK)	
	#229 / 09.11	1  BAKIROVA A. (KAZ)
2	 BAKIROVA A. (KAZ)	3
3	 ARABLI R. (AZE)	4  KOCHIEVA A. (RUS)
	#230 / 09.11	12
4	 KOCHIEVA A. (RUS)	
5	 GUL M. (PAK)	7  GUL M. (PAK)
	#232 / 09.11	4
6	 ARABLI R. (AZE)	
7	 KOCHIEVA A. (RUS)	5  BAKIROVA A. (KAZ)
	#233 / 09.11	5
8	 BAKIROVA A. (KAZ)	
9	 GUL M. (PAK)	7  KOCHIEVA A. (RUS)
	#235 / 09.11	8
10	 KOCHIEVA A. (RUS)	
11	 BAKIROVA A. (KAZ)	5  BAKIROVA A. (KAZ)
	#236 / 09.11	1
12	 ARABLI R. (AZE)	

1. BAKIROVA AIZHAN (KAZ)
2. KOCHIEVA ALANA (RUS)
3. GUL MA (PAK)
4. ARABLI RENATA (AZE)



1. AZARAVA MARYIA (BLR)
2. RODINA ANNA (RUS)
3. BASANGOVA ALTANA (RUS)
3. TOLBA RAHMA (EGY)
5. BÜBER NURBADE (TUR)
5. TIZIMBAY NURIYA (KAZ)
7. DEMENEVA VARVARA (RUS)
7. SADOVSKAYA MARIYA (RUS)

Referees:			

Senior Kumite Female -61kg - Round Robin (each against each)

MOSCOW-KARATE-UNIVERSE INTERNATIONAL 2024, Moscow, RUS

Tatami

Pool
2/8

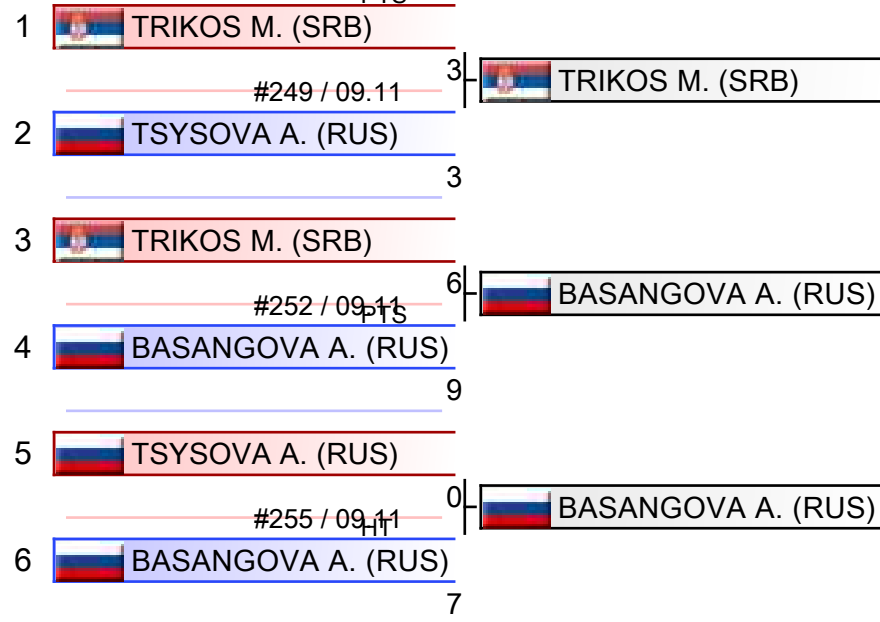

1. BASANGOVA ALTANA (RUS)
2. TRIKOS MINA (SRB)
3. TSYSOVA ANASTASIA (RUS)



1. AZARAVA MARYIA (BLR)
2. RODINA ANNA (RUS)
3. BASANGOVA ALTANA (RUS)
3. TOLBA RAHMA (EGY)
5. BÜBER NURBADE (TUR)
5. TIZIMBAY NURIYA (KAZ)
7. DEMENEVA VARVARA (RUS)
7. SADOVSKAYA MARIYA (RUS)

Referees:			

Senior Kumite Female -61kg - Round Robin (each against each)

MOSCOW-KARATE-UNIVERSE INTERNATIONAL 2024, Moscow, RUS

Tatami

Pool
3/8

1	KONNAVA Y. (BLR)		
	#238 / 09.11	3	GANIEVA D. (UZB)
2	GANIEVA D. (UZB)		
		5	
3	DEMENEVA V. (RUS)		
	#239 / 09.11	2	DEMENEVA V. (RUS)
4	KANAY A. (KAZ)		
		1	
5	KONNAVA Y. (BLR)		
	#241 / 09.11	6	DEMENEVA V. (RUS)
6	DEMENEVA V. (RUS)		
		6	
7	KANAY A. (KAZ)		
	#242 / 09.11	8	KANAY A. (KAZ)
8	GANIEVA D. (UZB)		
		8	
9	KONNAVA Y. (BLR)		
	#244 / 09.11	10	KONNAVA Y. (BLR)
10	KANAY A. (KAZ)		
		4	
11	GANIEVA D. (UZB)		
	#245 / 09.11	2	DEMENEVA V. (RUS)
12	DEMENEVA V. (RUS)		
		4	

1. DEMENEVA VARVARA (RUS)
2. KONNAVA YANA (BLR)
3. GANIEVA DILNOZA (UZB)
4. KANAY ASSEL (KAZ)



1. AZARAVA MARYIA (BLR)
2. RODINA ANNA (RUS)
3. BASANGOVA ALTANA (RUS)
3. TOLBA RAHMA (EGY)
5. BÜBER NURBADE (TUR)
5. TIZIMBAY NURIYA (KAZ)
7. DEMENEVA VARVARA (RUS)
7. SADOVSKAYA MARIYA (RUS)

Referees:			

Senior Kumite Female -61kg - Round Robin (each against each)

MOSCOW-KARATE-UNIVERSE INTERNATIONAL 2024, Moscow, RUS

Tatami

Pool

4/8

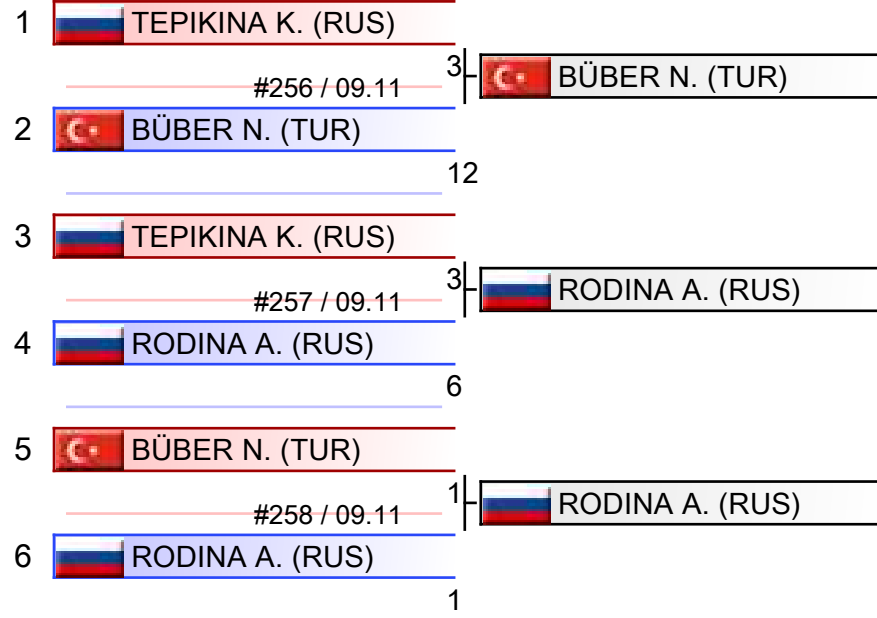

1. RODINA ANNA (RUS)
2. BÜBER NURBADE (TUR)
3. TEPIKINA KSENIIA (RUS)



1. AZARAVA MARYIA (BLR)
2. RODINA ANNA (RUS)
3. BASANGOVA ALTANA (RUS)
3. TOLBA RAHMA (EGY)
5. BÜBER NURBADE (TUR)
5. TIZIMBAY NURIYA (KAZ)
7. DEMENEVA VARVARA (RUS)
7. SADOVSKAYA MARIYA (RUS)

Referees:			

Senior Kumite Female -61kg - Round Robin (each against each)

MOSCOW-KARATE-UNIVERSE INTERNATIONAL 2024, Moscow, RUS

Tatami

Pool

5/8

1	FILIMONOVA A. (RUS)	
	#247 / 09.11	
2	TIZIMBAY N. (KAZ)	
	PTS	
3	AZARAVA M. (BLR)	6
	#248 / 09.11	
4	BIKMETOVA A. (RUS)	4
	KI	
5	FILIMONOVA A. (RUS)	
	#250 / 09.11	
6	AZARAVA M. (BLR)	
7	BIKMETOVA A. (RUS)	1
	#251 / 09.11	
8	TIZIMBAY N. (KAZ)	7
	PTS	
9	FILIMONOVA A. (RUS)	
	#253 / 09.11	
10	BIKMETOVA A. (RUS)	
11	TIZIMBAY N. (KAZ)	0
	#254 / 09.11	
12	AZARAVA M. (BLR)	2

1. AZARAVA MARYIA (BLR)
2. TIZIMBAY NURIYA (KAZ)
3. BIKMETOVA AIDA (RUS)
4. FILIMONOVA ANASTASIYA (RUS)



1. AZARAVA MARYIA (BLR)
2. RODINA ANNA (RUS)
3. BASANGOVA ALTANA (RUS)
3. TOLBA RAHMA (EGY)
5. BÜBER NURBADE (TUR)
5. TIZIMBAY NURIYA (KAZ)
7. DEMENEVA VARVARA (RUS)
7. SADOVSKAYA MARIYA (RUS)









Referees:			

Senior Kumite Female -61kg - Round Robin (each against each)

MOSCOW-KARATE-UNIVERSE INTERNATIONAL 2024, Moscow, RUS

Tatami

Pool
6/8

1	 SEYEDEFERESHTEH R. (TUR)	
	#231 / 09.11	1  SADOVSKAYA M. (RUS)
2	 SADOVSKAYA M. (RUS)	4
3	 SEYEDEFERESHTEH R. (TUR)	
	#234 / 09.11	5  CHIZHIKOVA D. (RUS)
4	 CHIZHIKOVA D. (RUS)	5
5	 SADOVSKAYA M. (RUS)	
	#237 / 09.11	10  SADOVSKAYA M. (RUS)
6	 CHIZHIKOVA D. (RUS)	7

1. SADOVSKAYA MARIYA (RUS)
2. CHIZHIKOVA DARIYA (RUS)
3. SEYEDEFERESHTEH RAZAVI (TUR)



1. AZARAVA MARYIA (BLR)
2. RODINA ANNA (RUS)
3. BASANGOVA ALTANA (RUS)
3. TOLBA RAHMA (EGY)
5. BÜBER NURBADE (TUR)
5. TIZIMBAY NURIYA (KAZ)
7. DEMENEVA VARVARA (RUS)
7. SADOVSKAYA MARIYA (RUS)

Referees:			









Senior Kumite Female -61kg - Round Robin (each against each)

MOSCOW-KARATE-UNIVERSE INTERNATIONAL 2024, Moscow, RUS

Tatami

Pool

7/8

1	 ABRAMOVA V. (RUS)	
	#240 / 09.11	6  ABRAMOVA V. (RUS)
2	 CHYSTSIAKOVA V. (BLR)	0
3	 ABRAMOVA V. (RUS)	1  TOLBA R. (EGY)
	#243 / 09.11	
4	 TOLBA R. (EGY)	9
5	 CHYSTSIAKOVA V. (BLR)	0  TOLBA R. (EGY)
	#246 / 09.11	
6	 TOLBA R. (EGY)	1

1. TOLBA RAHMA (EGY)
2. ABRAMOVA VALERIA (RUS)
3. CHYSTSIAKOVA VARVARA (BLR)



1. AZARAVA MARYIA (BLR)
2. RODINA ANNA (RUS)
3. BASANGOVA ALTANA (RUS)
3. TOLBA RAHMA (EGY)
5. BÜBER NURBADE (TUR)
5. TIZIMBAY NURIYA (KAZ)
7. DEMENEVA VARVARA (RUS)
7. SADOVSKAYA MARIYA (RUS)









Referees:			

Senior Kumite Female -61kg - Round Robin (each against each)

MOSCOW-KARATE-UNIVERSE INTERNATIONAL 2024, Moscow, RUS

Tatami

Pool
8/8

1	 GORETSKAYA P. (RUS)	
	#259 / 09.11	2  OTABOYEVA S. (UZB)
2	 OTABOYEVA S. (UZB)	4
3	 GORETSKAYA P. (RUS)	
	#260 / 09.11	3  GORETSKAYA P. (RUS)
4	 CHUPINA A. (RUS)	2
5	 OTABOYEVA S. (UZB)	
	#261 / 09.11	4  OTABOYEVA S. (UZB)
6	 CHUPINA A. (RUS)	2

1. OTABOYEVA SEVINCH UZB02811 (UZB)
2. GORETSKAYA POLINA (RUS)
3. CHUPINA ANASTASIYA (RUS)



1. AZARAVA MARYIA (BLR)
2. RODINA ANNA (RUS)
3. BASANGOVA ALTANA (RUS)
3. TOLBA RAHMA (EGY)
5. BÜBER NURBADE (TUR)
5. TIZIMBAY NURIYA (KAZ)
7. DEMENEVA VARVARA (RUS)
7. SADOVSKAYA MARIYA (RUS)

Referees:			

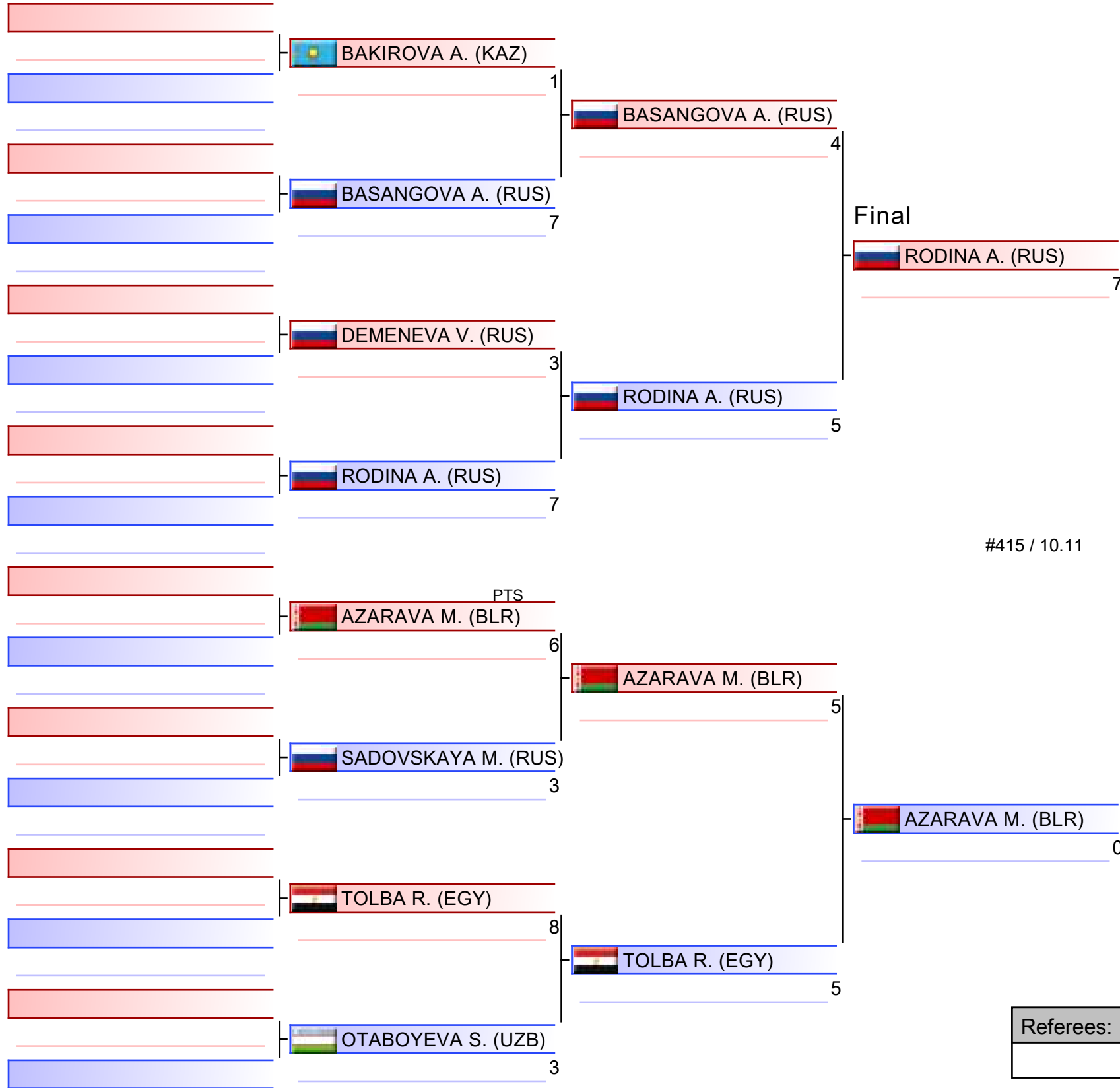

AZARAVA M. (BLR)

1. AZARAVA MARYIA (BLR)
2. RODINA ANNA (RUS)
3. BASANGOVA ALTANA (RUS)
3. TOLBA RAHMA (EGY)
5. BÜBER NURBADE (TUR)
5. TIZIMBAY NURIYA (KAZ)
7. DEMENEVA VARVARA (RUS)
7. SADOVSKAYA MARIYA (RUS)

Referees:			

Senior Kumite Female -61kg

MOSCOW-KARATE-UNIVERSE INTERNATIONAL 2024

2024-11-09

Tatami
1 19:30

Pool
1,2,3,4,5,6,7,8

(c)sportdata GmbH & Co KG 2000-2024 (2024-11-10 18:21) v 10.2.0 build 1 (2024-07-20 11:09 CET) License: Online_Event_ID-8474_MOSCOWKARATEUNIVERSEINTERNATIONAL2024 (expire 2024-11-24)

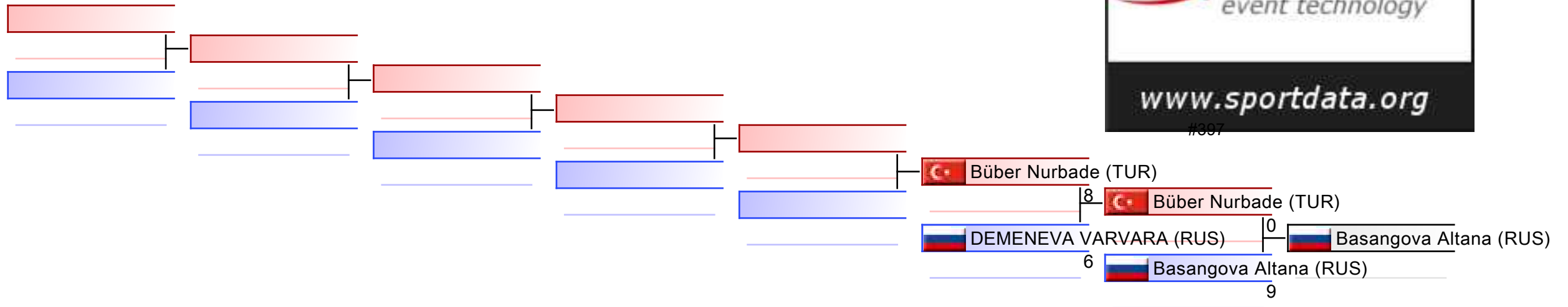

REPECHAGE: (1,2,3,4,5,6,7,8)

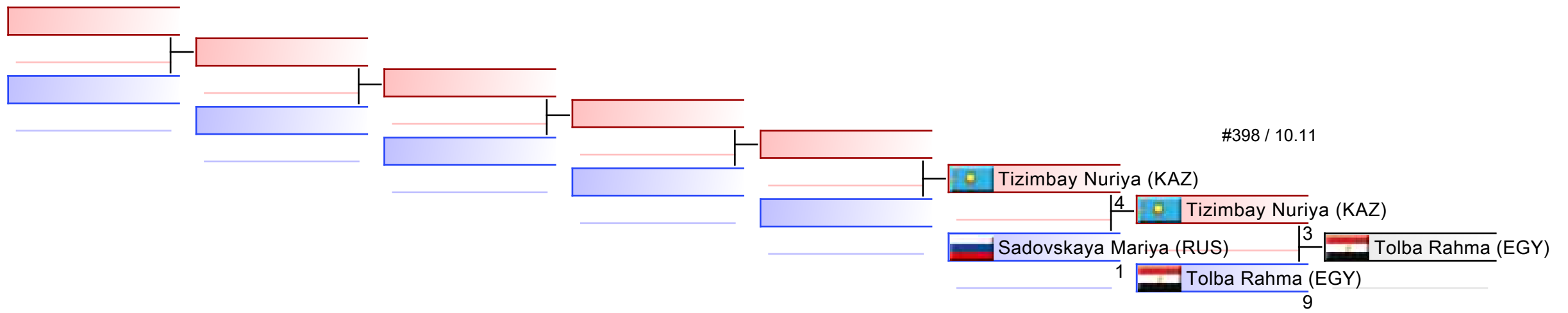

Referees:							
-----------	--	--	--	--	--	--	--



MOSCOW-KARATE-UNIVERSE
INTERNATIONAL 2024 - 2024-11-08



Official Results

Senior Kumite Female -61kg			
1	AZARAVA MARYIA		BLR - BELARUS
2	RODINA ANNA		RUS - RUSSIAN FEDERATION
3	BASANGOVA ALTANA		RUS - RUSSIAN FEDERATION
3	TOLBA RAHMA		EGY - EGYPT
5	BÜBER NURBADE		TUR - TÜRKIYE
5	TIZIMBAY NURIYA		KAZ - KAZAKHSTAN
7	DEMENEVA VARVARA		RUS - RUSSIAN FEDERATION
7	SADOVSKAYA MARIYA		RUS - RUSSIAN FEDERATION

SENIOR KUMITE FEMALE -68KG



MOSCOW-KARATE-UNIVERSE INTERNATIONAL ..
ENTRIES BY WEIGHT CATEGORY



Senior Kumite Female -68kg
As of 10 NOV 2024

NOC Code	Gender	Name	Seeding
AZE	F	Aliyeva Aysu	
BLR	F	Ramaniuk Volha	
EGY	F	Abdelaziz Feryal	16
IND	F	JADHAV BHUVANESHWARI SURESH	
KAZ	F	DARENKAYA DAIYANA	15
KAZ	F	Sagynbek Laura	
RUS	F	Bikmullina Kamilla	2
RUS	F	Bublikova Victoria	
RUS	F	Gadzhieva Victoriya	
RUS	F	Gagieva Snezhana	
RUS	F	Kopylova Darya	
RUS	F	KUDRIAVTSEVA ANNA	7
RUS	F	Lyahova Varvara	
RUS	F	Markovskaya Svetlana	
RUS	F	Meshkova Aleksandra	1
RUS	F	Pustovit Ekaterina	
RUS	F	SEMENOVA MARIYA	8
RUS	F	Surikova Darya	4
RUS	F	VIDENMEER VIKTORIA	
RUS	F	Zakarian Anaida	
RUS	F	Zavgarova Liya	3
SRB	F	ZIVKOVIC TAMARA	
TUN	F	ESSID TESNIME	24
TUN	F	EZZAR WISSAL	
UAE	F	KHASAIF FATMA	
UZB	F	ABDRIMOVA MOHICHEHRA	

Senior Kumite Female -68kg - Round Robin (each against each)

MOSCOW-KARATE-UNIVERSE INTERNATIONAL 2024, Moscow, RUS

Tatami

Pool

1/8

1	GADZHIEVA V. (RUS)	
	#304 / 09.11	0
2	ABDELAZIZ F. (EGY)	0
3	ESSID T. (TUN)	5
	#305 / 09.11	ESSID T. (TUN)
4	VIDENMEER V. (RUS)	1
5	GADZHIEVA V. (RUS)	11
	#307 / 09.11	GADZHIEVA V. (RUS)
6	ESSID T. (TUN)	5
7	VIDENMEER V. (RUS)	0
	#308 / 09.11	ABDELAZIZ F. (EGY)
8	ABDELAZIZ F. (EGY)	9
9	GADZHIEVA V. (RUS)	8
	#310 / 09.11	GADZHIEVA V. (RUS)
10	VIDENMEER V. (RUS)	0
11	ABDELAZIZ F. (EGY)	15
	#311 / 09.11	ABDELAZIZ F. (EGY)
12	ESSID T. (TUN)	5

1. ABDELAZIZ FERYAL (EGY)
2. GADZHIEVA VICTORIYA (RUS)
3. ESSID TESNIME (TUN)
4. VIDENMEER VIKTORIA (RUS)



1. MESHKOVA ALEKSANDRA (RUS)
2. SAGYNBEK LAURA (KAZ)
3. ABDELAZIZ FERYAL (EGY)
3. RAMANIUK VOLHA (BLR)
5. KUDRIAVTSEVA ANNA (RUS)
5. ABDRIKOVA MOHICHEHRA (UZB)
7. BIKMULLINA KAMILLA (RUS)
7. MARKOVSKAYA SVETLANA (RUS)

Referees:			









Senior Kumite Female -68kg - Round Robin (each against each)

MOSCOW-KARATE-UNIVERSE INTERNATIONAL 2024, Moscow, RUS

Tatami

Pool

2/8

1	 KHASAIF F. (UAE)	0	 GAGIEVA S. (RUS)
	#313 / 09.11		
2	 GAGIEVA S. (RUS)	2	
	PTS		
3	 KHASAIF F. (UAE)	3	 KHASAIF F. (UAE)
	#316 / 09.11		
4	 ZAVGAROVA L. (RUS)	2	
	PTS		
5	 GAGIEVA S. (RUS)	7	 GAGIEVA S. (RUS)
	#319 / 09.11		
6	 ZAVGAROVA L. (RUS)	4	

1. GAGIEVA SNEZHANA (RUS)
2. KHASAIF FATMA (UAE)
3. ZAVGAROVA LIYA (RUS)



1. MESHKOVA ALEKSANDRA (RUS)
2. SAGYNBEK LAURA (KAZ)
3. ABDELAZIZ FERYAL (EGY)
3. RAMANIUK VOLHA (BLR)
5. KUDRIAVTSEVA ANNA (RUS)
5. ABDRIKOVA MOHICHEHRA (UZB)
7. BIKMULLINA KAMILLA (RUS)
7. MARKOVSKAYA SVETLANA (RUS)







Referees:			

Senior Kumite Female -68kg - Round Robin (each against each)

MOSCOW-KARATE-UNIVERSE INTERNATIONAL 2024, Moscow, RUS

Tatami

Pool
3/8

1	 SAGYNBEK L. (KAZ)	
	#322 / 09.11	3
2	 ZAKARIAN A. (RUS)	
	PTS	2
3	 SAGYNBEK L. (KAZ)	
	#324 / 09.11	4
4	 KUDRIAVTSEVA A. (RUS)	
		4
5	 ZAKARIAN A. (RUS)	
	#326 / 09.11	1
6	 KUDRIAVTSEVA A. (RUS)	
		5

1. SAGYNBEK LAURA (KAZ)
2. KUDRIAVTSEVA ANNA (RUS)
3. ZAKARIAN ANAIDA (RUS)



1. MESHKOVA ALEKSANDRA (RUS)
2. SAGYNBEK LAURA (KAZ)
3. ABDELAZIZ FERYAL (EGY)
3. RAMANIUK VOLHA (BLR)
5. KUDRIAVTSEVA ANNA (RUS)
5. ABDRIKOVA MOHICHEHRA (UZB)
7. BIKMULLINA KAMILLA (RUS)
7. MARKOVSKAYA SVETLANA (RUS)

Referees:			







Senior Kumite Female -68kg - Round Robin (each against each)

MOSCOW-KARATE-UNIVERSE INTERNATIONAL 2024, Moscow, RUS

Tatami

Pool

4/8

1	 PUSTOVIT E. (RUS)	
	#328 / 09.11	
2	 JADHAV B. (IND)	
3	 PUSTOVIT E. (RUS)	
	#330 / 09.11	
4	 BIKMULLINA K. (RUS)	
5	 JADHAV B. (IND)	
	#332 / 09.11	2
6	 BIKMULLINA K. (RUS)	
		5

1. BIKMULLINA KAMILLA (RUS)
2. JADHAV BHUVANESHWARI SURESH (IND)
3. PUSTOVIT EKATERINA (RUS)



1. MESHKOVA ALEKSANDRA (RUS)
2. SAGYNBEK LAURA (KAZ)
3. ABDELAZIZ FERYAL (EGY)
3. RAMANIUK VOLHA (BLR)
5. KUDRIAVTSEVA ANNA (RUS)
5. ABDRIKOVA MOHICHEHRA (UZB)
7. BIKMULLINA KAMILLA (RUS)
7. MARKOVSKAYA SVETLANA (RUS)

Referees:			

Senior Kumite Female -68kg - Round Robin (each against each)

MOSCOW-KARATE-UNIVERSE INTERNATIONAL 2024, Moscow, RUS

Tatami

Pool
5/8

1	EZZAR W. (TUN)	
	#314 / 09.11	2 DARENSKAYA D. (KAZ)
2	DARENSKAYA D. (KAZ)	6
3	ALIYEVA A. (AZE)	
	#315 / 09.11	4 LYAHOVA V. (RUS)
4	LYAHOVA V. (RUS)	3
	PTS	
5	EZZAR W. (TUN)	
	#317 / 09.11	9 EZZAR W. (TUN)
6	ALIYEVA A. (AZE)	5
7	LYAHOVA V. (RUS)	
	#318 / 09.11	2 DARENSKAYA D. (KAZ)
8	DARENSKAYA D. (KAZ)	3
	PTS	
9	EZZAR W. (TUN)	
	#320 / 09.11	5 EZZAR W. (TUN)
10	LYAHOVA V. (RUS)	3
	PTS	
11	DARENSKAYA D. (KAZ)	
	#321 / 09.11	5 DARENSKAYA D. (KAZ)
12	ALIYEVA A. (AZE)	1

1. DARENSKAYA DAIYANA (KAZ)
2. EZZAR WISSAL (TUN)
3. LYAHOVA VARVARA (RUS)
4. ALIYEVA AYSU (AZE)



1. MESHKOVA ALEKSANDRA (RUS)
2. SAGYNBEK LAURA (KAZ)
3. ABDELAZIZ FERYAL (EGY)
3. RAMANIUK VOLHA (BLR)
5. KUDRIAVTSEVA ANNA (RUS)
5. ABDRIIMOVA MOHICHEHRA (UZB)
7. BIKMULLINA KAMILLA (RUS)
7. MARKOVSKAYA SVETLANA (RUS)









Referees:			

Senior Kumite Female -68kg - Round Robin (each against each)

MOSCOW-KARATE-UNIVERSE INTERNATIONAL 2024, Moscow, RUS

Tatami

Pool
6/8

1	 BUBLIKOVA V. (RUS)	
	#306 / 09.11	5  RAMANIUK V. (BLR)
2	 RAMANIUK V. (BLR)	6
3	 BUBLIKOVA V. (RUS)	10  SURIKOVA D. (RUS)
	#309 / 09.11	
4	 SURIKOVA D. (RUS)	
5	 RAMANIUK V. (BLR)	7  RAMANIUK V. (BLR)
	#312 / 09.11	
6	 SURIKOVA D. (RUS)	2

1. RAMANIUK VOLHA (BLR)
2. SURIKOVA DARYA (RUS)
3. BUBLIKOVA VICTORIA (RUS)



1. MESHKOVA ALEKSANDRA (RUS)
2. SAGYNBEK LAURA (KAZ)
3. ABDELAZIZ FERYAL (EGY)
3. RAMANIUK VOLHA (BLR)
5. KUDRIAVTSEVA ANNA (RUS)
5. ABDRIMOVA MOHICHEHRA (UZB)
7. BIKMULLINA KAMILLA (RUS)
7. MARKOVSKAYA SVETLANA (RUS)

Referees:			









Senior Kumite Female -68kg - Round Robin (each against each)

MOSCOW-KARATE-UNIVERSE INTERNATIONAL 2024, Moscow, RUS

Tatami

Pool

7/8

1	 MARKOVSKAYA S. (RUS)	
	#323 / 09.11	7  MARKOVSKAYA S. (RUS)
2	 ZIVKOVIC T. (SRB)	
	PTS	1
3	 MARKOVSKAYA S. (RUS)	
	#325 / 09.11	4  MARKOVSKAYA S. (RUS)
4	 SEMENOVA M. (RUS)	
	PTS	3
5	 ZIVKOVIC T. (SRB)	
	#327 / 09.11	9  ZIVKOVIC T. (SRB)
6	 SEMENOVA M. (RUS)	
		0

1. MARKOVSKAYA SVETLANA (RUS)
2. ZIVKOVIC TAMARA (SRB)
3. SEMENOVA MARIYA (RUS)



1. MESHKOVA ALEKSANDRA (RUS)
2. SAGYNBEK LAURA (KAZ)
3. ABDELAZIZ FERYAL (EGY)
3. RAMANIUK VOLHA (BLR)
5. KUDRIAVTSEVA ANNA (RUS)
5. ABDRIKOV MOHICHEHRA (UZB)
7. BIKMULLINA KAMILLA (RUS)
7. MARKOVSKAYA SVETLANA (RUS)









Referees:			

Senior Kumite Female -68kg - Round Robin (each against each)

MOSCOW-KARATE-UNIVERSE INTERNATIONAL 2024, Moscow, RUS

Tatami

Pool
8/8

1	 KOPYLOVA D. (RUS)	
	#329 / 09.11	1  ABDRIMOVA M. (UZB)
2	 ABDRIMOVA M. (UZB)	2
3	 KOPYLOVA D. (RUS)	
	#331 / 09.11	1  MESHKOVA A. (RUS)
4	 MESHKOVA A. (RUS)	2
5	 ABDRIMOVA M. (UZB)	
	#333 / 09.11	0  MESHKOVA A. (RUS)
6	 MESHKOVA A. (RUS)	3

1. MESHKOVA ALEKSANDRA (RUS)
2. ABDRIMOVA MOHICHEHRA (UZB)
3. KOPYLOVA DARYA (RUS)



1. MESHKOVA ALEKSANDRA (RUS)
2. SAGYNBEK LAURA (KAZ)
3. ABDELAZIZ FERYAL (EGY)
3. RAMANIUK VOLHA (BLR)
5. KUDRIAVTSEVA ANNA (RUS)
5. ABDRIMOVA MOHICHEHRA (UZB)
7. BIKMULLINA KAMILLA (RUS)
7. MARKOVSKAYA SVETLANA (RUS)

Referees:			

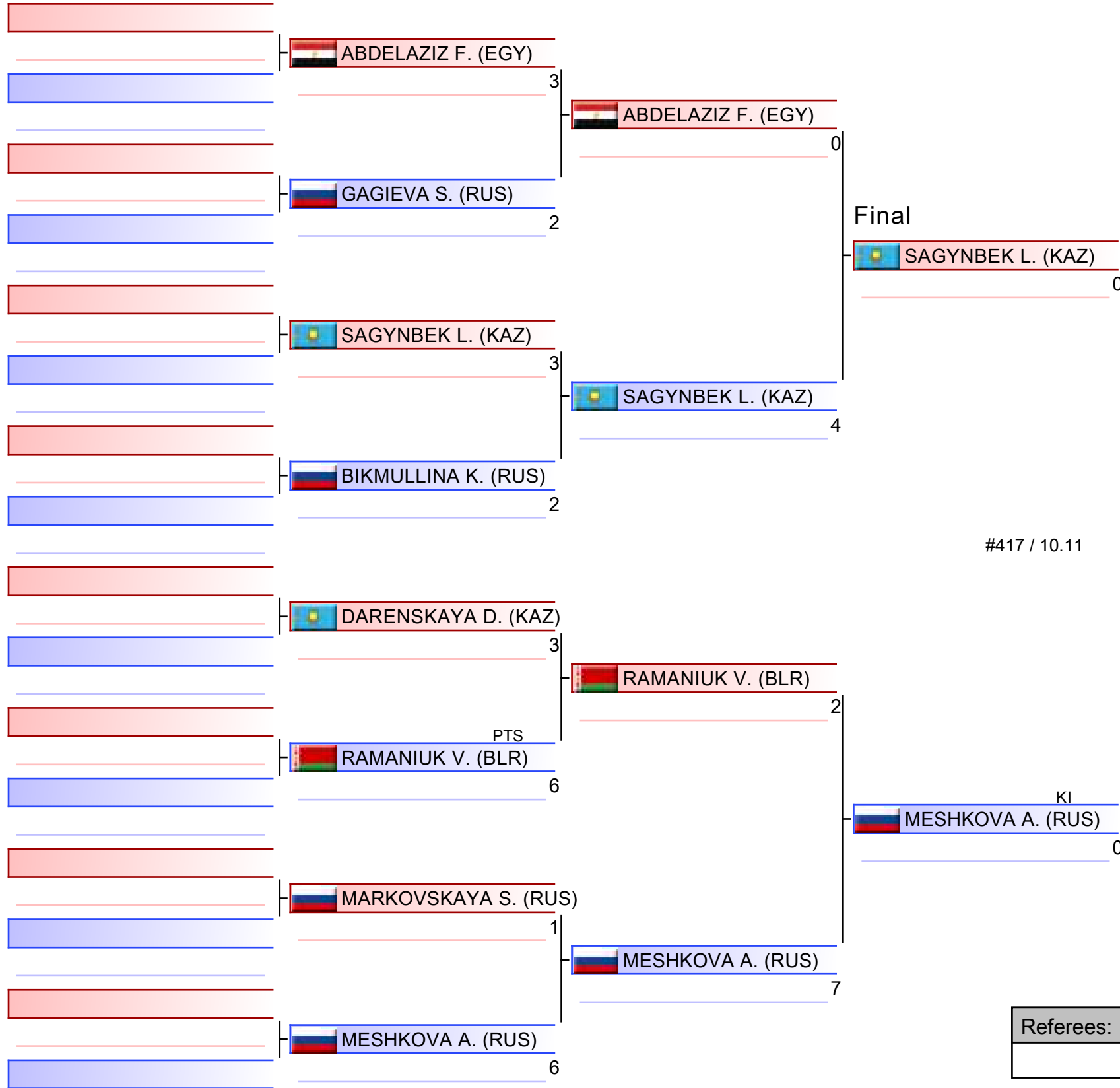

1. MESHKOVA ALEKSANDRA (RUS)
2. SAGYNBEK LAURA (KAZ)
3. ABDELAZIZ FERYAL (EGY)
3. RAMANIUK VOLHA (BLR)
5. KUDRIAVTSEVA ANNA (RUS)
5. ABDRIKOVA MOHICHEHRA (UZB)
7. BIKMULLINA KAMILLA (RUS)
7. MARKOVSKAYA SVETLANA (RUS)

Referees:			

Senior Kumite Female -68kg

MOSCOW-KARATE-UNIVERSE INTERNATIONAL 2024

2024-11-09

Tatami

1 19:38

Pool

1,2,3,4,5,6,7,8

(c)sportdata GmbH & Co KG 2000-2024 (2024-11-10 18:21) v 10.2.0 build 1 (2024-07-20 11:09 CET) License: Online_Event_ID-8474_MOSCOWKARATEUNIVERSEINTERNATIONAL2024 (expire 2024-11-24)

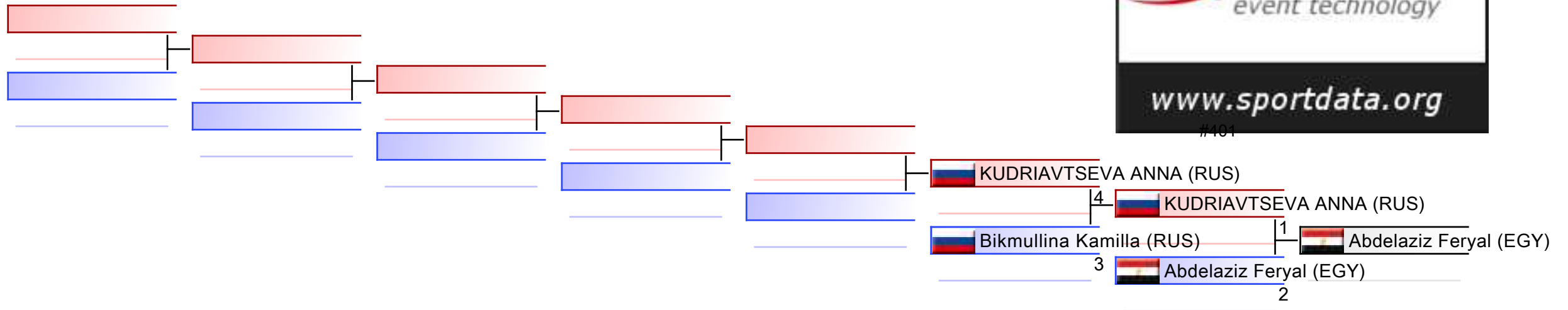

REPECHAGE: (1,2,3,4,5,6,7,8)

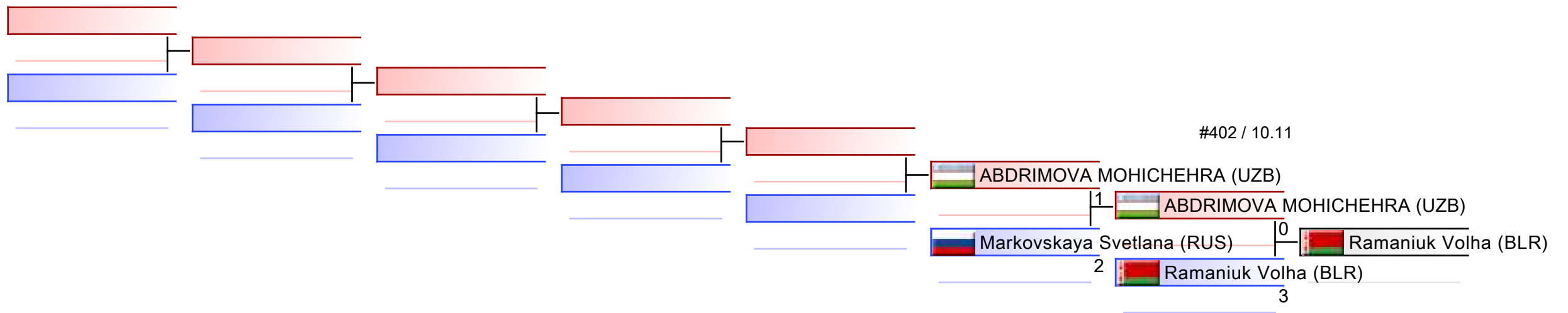

Referees:							
-----------	--	--	--	--	--	--	--



MOSCOW-KARATE-UNIVERSE
INTERNATIONAL 2024 - 2024-11-08



Official Results

Senior Kumite Female -68kg			
1	MESHKOVA ALEKSANDRA		RUS - RUSSIAN FEDERATION
2	SAGYNBEK LAURA		KAZ - KAZAKHSTAN
3	ABDELAZIZ FERYAL		EGY - EGYPT
3	RAMANIUK VOLHA		BLR - BELARUS
5	KUDRIAVTSEVA ANNA		RUS - RUSSIAN FEDERATION
5	ABDRIMOVA MOHICHEHRA		UZB - UZBEKISTAN
7	BIKMULLINA KAMILLA		RUS - RUSSIAN FEDERATION
7	MARKOVSKAYA SVETLANA		RUS - RUSSIAN FEDERATION

SENIOR KUMITE MALE +84KG



MOSCOW-KARATE-UNIVERSE INTERNATIONAL ..
ENTRIES BY WEIGHT CATEGORY



Senior Kumite Male +84kg
As of 10 NOV 2024

NOC Code	Gender	Name	Seeding
AZE	M	Gurbanli Asiman	8
BLR	M	Isakau Anton	
BLR	M	Kudzinou Ivan	
BLR	M	Vodchyts Aliaksei	
IRI	M	ABAZARI SALEH	14
IRI	M	ASHOURI GARMJANI MAHDI	15
IRI	M	GANJZADEH GHOUJEH BEIGLOU MAHDI	
IRI	M	Nemati Mahmoud	
KAZ	M	ANARBKOV DIAS	
KAZ	M	Taizhan Alisher	
RUS	M	Antohii Vasilii	6
RUS	M	BELONOGOV KIRILL	
RUS	M	BUROV VLADISLAV	
RUS	M	Drozdov Maksim	
RUS	M	GOLOVIN MAKAR	1
RUS	M	Gusev Igor	
RUS	M	Kamyshov Daniil	7
RUS	M	KOKOVUROV KONSTANTIN	3
RUS	M	Kovalev Kirill	4
RUS	M	PCHENITCIN ALEKSANDR	2
RUS	M	Ponomarenko Michael	
SEN	M	GUEYE SALIOU	
SRB	M	TRIKOS BOGDAN	
TJK	M	RAKHIMOV FARUKHDZHON	
TUR	M	KILIÇ Emirhan	
UZB	M	ABDULLAEV JAVOKHIRKHON	
UZB	M	ISMATULLAYEV ISLOMBEK	

Senior Kumite Male +84kg - Round Robin (each against each)

MOSCOW-KARATE-UNIVERSE INTERNATIONAL 2024, Moscow, RUS

Tatami

Pool

1/8

1	VODCHYTS A. (BLR)	0	NEMATI M. (IRI)
	#334 / 09.11		
2	NEMATI M. (IRI)	1	
3	GUEYE S. (SEN)	1	GUEYE S. (SEN)
	#335 / 09.11		
4	ANTOHII V. (RUS)	9	
5	VODCHYTS A. (BLR)	1	VODCHYTS A. (BLR)
	#337 / 09.11		
6	GUEYE S. (SEN)	7	
7	ANTOHII V. (RUS)	2	NEMATI M. (IRI)
	#338 / 09.11		
8	NEMATI M. (IRI)	6	
	KI		
9	VODCHYTS A. (BLR)	4	VODCHYTS A. (BLR)
	#340 / 09.11		
10	ANTOHII V. (RUS)	0	
11	NEMATI M. (IRI)	9	NEMATI M. (IRI)
	#341 / 09.11		
12	GUEYE S. (SEN)	2	

1. NEMATI MAHMOUD (IRI)
2. VODCHYTS ALIAKSEI (BLR)
3. GUEYE SALIOU (SEN)
4. ANTOHII VASILII (RUS)



1. ABAZARI SALEH (IRI)
2. ASHOURI GARMJANI MAHDI (IRI)
3. KUDZINAU IVAN (BLR)
3. ANARBEKOV DIAS (KAZ)
5. KOKOVUROV KONSTANTIN (RUS)
5. ISAKAU ANTON (BLR)
7. PCHENITCIN ALEKSANDR (RUS)
7. GUSEV IGOR (RUS)









Referees:			

Senior Kumite Male +84kg - Round Robin (each against each)

MOSCOW-KARATE-UNIVERSE INTERNATIONAL 2024, Moscow, RUS

Tatami

Pool
2/8

1	 ISMATULLAYEV I. (UZB)	
	#336 / 09.11	3  BELONOGOV K. (RUS)
2	 BELONOGOV K. (RUS)	3
3	 ISMATULLAYEV I. (UZB)	
	#339 / 09.11	4  KOKOVUROV K. (RUS)
4	 KOKOVUROV K. (RUS)	5
5	 BELONOGOV K. (RUS)	
	#342 / 09.11	4 
6	 KOKOVUROV K. (RUS)	4

1. KOKOVUROV KONSTANTIN (RUS)
2. BELONOGOV KIRILL (RUS)
3. ISMATULLAYEV ISLOMBEK (UZB)



1. ABAZARI SALEH (IRI)
2. ASHOURI GARMJANI MAHDI (IRI)
3. KUDZINAU IVAN (BLR)
3. ANARBEKOV DIAS (KAZ)
5. KOKOVUROV KONSTANTIN (RUS)
5. ISAKAU ANTON (BLR)
7. PCHENITCIN ALEKSANDR (RUS)
7. GUSEV IGOR (RUS)

Referees:			

Senior Kumite Male +84kg - Round Robin (each against each)

MOSCOW-KARATE-UNIVERSE INTERNATIONAL 2024, Moscow, RUS

Tatami

Pool
3/8

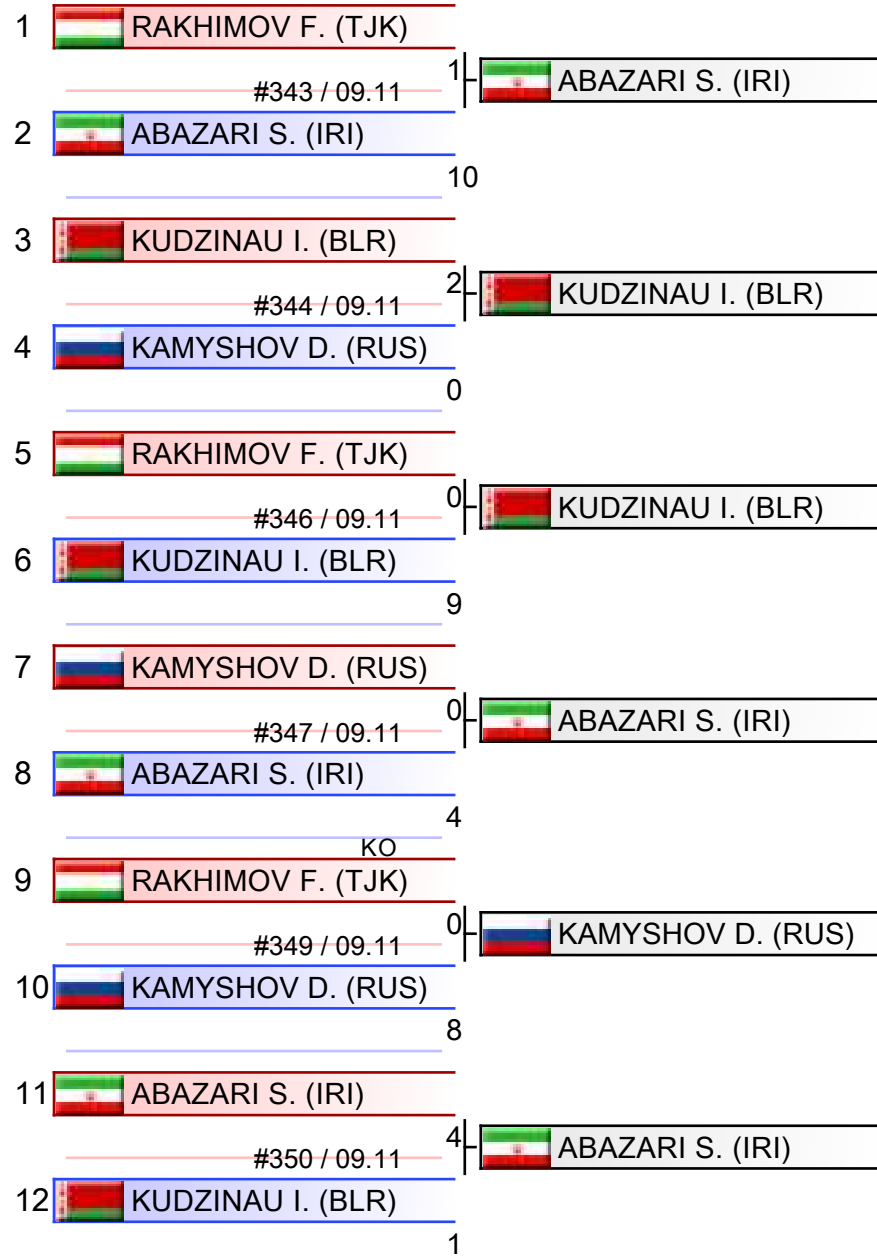

1. ABAZARI SALEH (IRI)
2. KUDZINAU IVAN (BLR)
3. KAMYSHOV DANIIL (RUS)
4. RAKHIMOV FARUKHDZHON (TJK)



1. ABAZARI SALEH (IRI)
2. ASHOURI GARMJANI MAHDI (IRI)
3. KUDZINAU IVAN (BLR)
3. ANARBEKOV DIAS (KAZ)
5. KOKOVUROV KONSTANTIN (RUS)
5. ISAKAU ANTON (BLR)
7. PCHENITCIN ALEKSANDR (RUS)
7. GUSEV IGOR (RUS)

Referees:			









Senior Kumite Male +84kg - Round Robin (each against each)

MOSCOW-KARATE-UNIVERSE INTERNATIONAL 2024, Moscow, RUS

Tatami

Pool

4/8

1	 PONOMARENKO M. (RUS)	
	#345 / 09.11	4  TAIZHAN A. (KAZ)
2	 TAIZHAN A. (KAZ)	9
3	 PONOMARENKO M. (RUS)	
	#348 / 09.11	3  PCHENITCIN A. (RUS)
4	 PCHENITCIN A. (RUS)	6
5	 TAIZHAN A. (KAZ)	
	#351 / 09.11	2  PCHENITCIN A. (RUS)
6	 PCHENITCIN A. (RUS)	7

1. PCHENITCIN ALEKSANDR (RUS)
2. TAIZHAN ALISHER (KAZ)
3. PONOMARENKO MICHAEL (RUS)



1. ABAZARI SALEH (IRI)
2. ASHOURI GARMJANI MAHDI (IRI)
3. KUDZINAU IVAN (BLR)
3. ANARBEOV DIAS (KAZ)
5. KOKOVUROV KONSTANTIN (RUS)
5. ISAKAU ANTON (BLR)
7. PCHENITCIN ALEKSANDR (RUS)
7. GUSEV IGOR (RUS)

Referees:			

Senior Kumite Male +84kg - Round Robin (each against each)

MOSCOW-KARATE-UNIVERSE INTERNATIONAL 2024, Moscow, RUS

Tatami

Pool

5/8

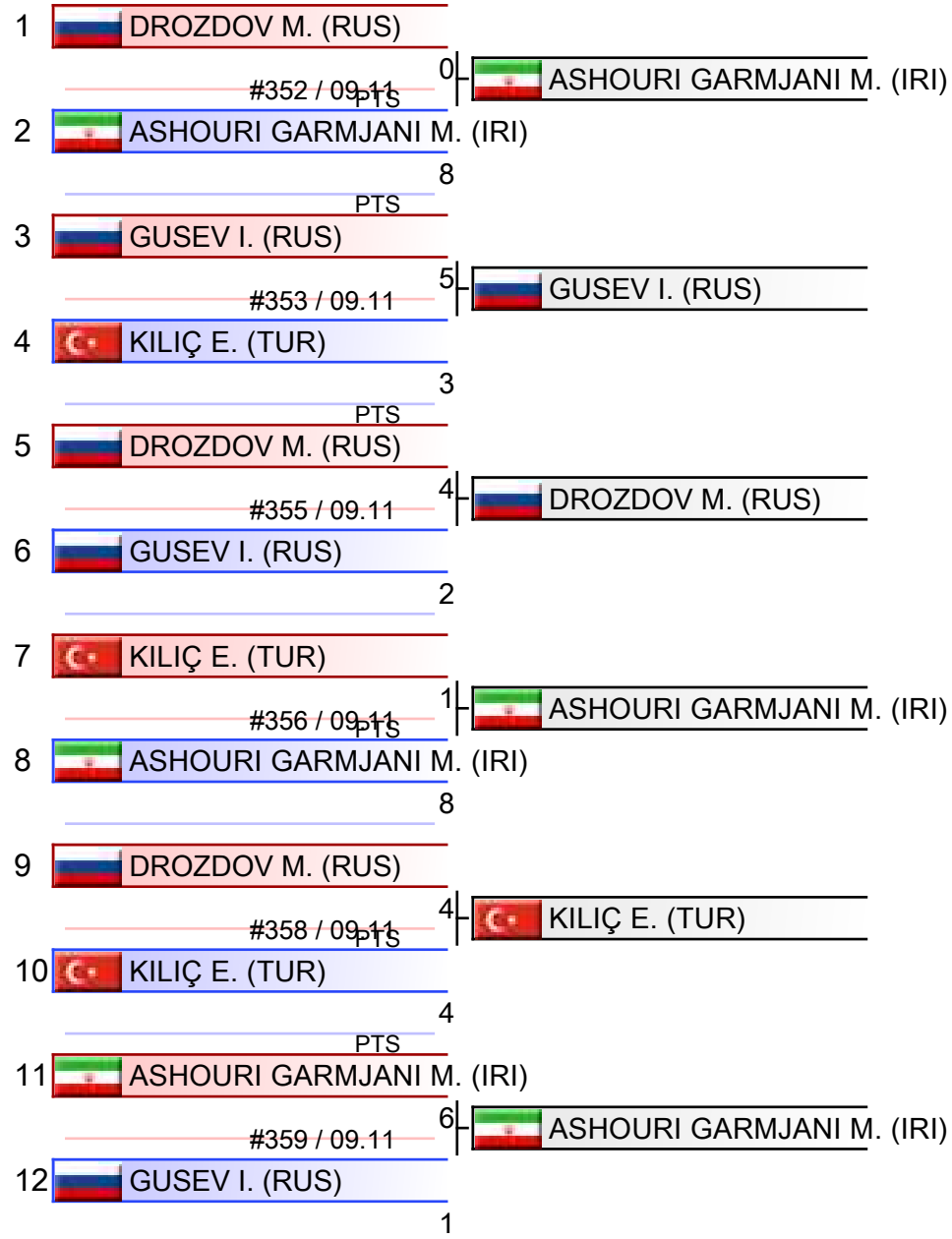

1. ASHOURI GARMJANI MAHDI (IRI)
2. GUSEV IGOR (RUS)
3. DROZDOV MAKSIM (RUS)
4. KILIÇ EMIRHAN (TUR)



1. ABAZARI SALEH (IRI)
2. ASHOURI GARMJANI MAHDI (IRI)
3. KUDZINAU IVAN (BLR)
3. ANARBEKOV DIAS (KAZ)
5. KOKOVUROV KONSTANTIN (RUS)
5. ISAKAU ANTON (BLR)
7. PCHENITCIN ALEKSANDR (RUS)
7. GUSEV IGOR (RUS)







Referees:			

Senior Kumite Male +84kg - Round Robin (each against each)

MOSCOW-KARATE-UNIVERSE INTERNATIONAL 2024, Moscow, RUS

Tatami

Pool
6/8

1	 ISAKAU A. (BLR)	
	#354 / 09.11	3
2	 TRIKOS B. (SRB)	
	PTS	1
3	 ISAKAU A. (BLR)	
	#357 / 09.11	8
4	 KOVALEV K. (RUS)	
		4
5	 TRIKOS B. (SRB)	
	#360 / 09.11	2
6	 KOVALEV K. (RUS)	
		4

1. ISAKAU ANTON (BLR)
2. KOVALEV KIRILL (RUS)
3. TRIKOS BOGDAN (SRB)



1. ABAZARI SALEH (IRI)
2. ASHOURI GARMJANI MAHDI (IRI)
3. KUDZINAU IVAN (BLR)
3. ANARBEKOV DIAS (KAZ)
5. KOKOVUROV KONSTANTIN (RUS)
5. ISAKAU ANTON (BLR)
7. PCHENITCIN ALEKSANDR (RUS)
7. GUSEV IGOR (RUS)

Referees:			









Senior Kumite Male +84kg - Round Robin (each against each)

MOSCOW-KARATE-UNIVERSE INTERNATIONAL 2024, Moscow, RUS

Tatami

Pool

7/8

1	 BUROV V. (RUS)		
	#361 / 09.11	7	 BUROV V. (RUS)
2	 GANJZADEH GHOUJEH BEIGLOU M. (IRI)		
		3	
3	 BUROV V. (RUS)		
	#363 / 09.11	0	 GURBANLI A. (AZE)
4	 GURBANLI A. (AZE)		
		2	
5	 GANJZADEH GHOUJEH BEIGLOU M. (IRI)		
	#365 / 09.11	5	 GURBANLI A. (AZE)
6	 GURBANLI A. (AZE)		
		6	

1. GURBANLI ASIMAN (AZE)
2. BUROV VLADISLAV (RUS)
3. GANJZADEH GHOUJEH BEIGLOU MAHDI (IRI)



1. ABAZARI SALEH (IRI)
2. ASHOURI GARMJANI MAHDI (IRI)
3. KUDZINAU IVAN (BLR)
3. ANARBEOV DIAS (KAZ)
5. KOKOVUROV KONSTANTIN (RUS)
5. ISAKAU ANTON (BLR)
7. PCHENITCIN ALEKSANDR (RUS)
7. GUSEV IGOR (RUS)









Referees:			

Senior Kumite Male +84kg - Round Robin (each against each)

MOSCOW-KARATE-UNIVERSE INTERNATIONAL 2024, Moscow, RUS

Tatami

Pool
8/8

1	 ABDULLAEV J. (UZB)	
	#362 / 09.11	1  ANARBEKOV D. (KAZ)
2	 ANARBEKOV D. (KAZ)	6
3	 ABDULLAEV J. (UZB)	
	#364 / 09.11	2  ABDULLAEV J. (UZB)
4	 GOLOVIN M. (RUS)	0
5	 ANARBEKOV D. (KAZ)	
	#366 / 09.11	1  ANARBEKOV D. (KAZ)
6	 GOLOVIN M. (RUS)	1

1. ANARBEKOV DIAS (KAZ)
2. ABDULLAEV JAVOKHIRKHON (UZB)
3. GOLOVIN MAKAR (RUS)



1. ABAZARI SALEH (IRI)
2. ASHOURI GARMJANI MAHDI (IRI)
3. KUDZINAU IVAN (BLR)
3. ANARBEKOV DIAS (KAZ)
5. KOKOVUROV KONSTANTIN (RUS)
5. ISAKAU ANTON (BLR)
7. PCHENITCIN ALEKSANDR (RUS)
7. GUSEV IGOR (RUS)

Referees:			

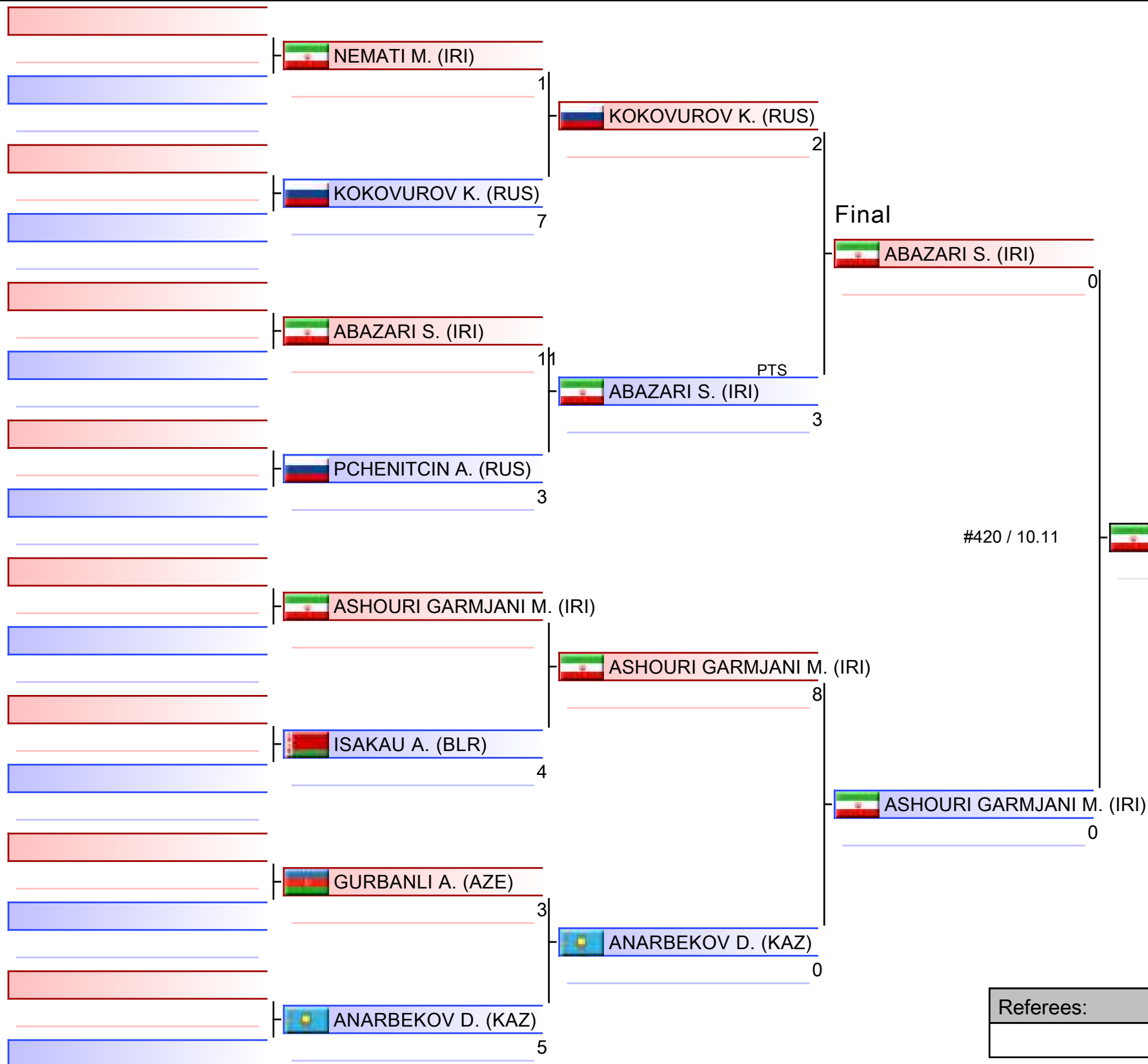

1. ABAZARI SALEH (IRI)
2. ASHOURI GARMJANI MAHDI (IRI)
3. KUDZINAU IVAN (BLR)
3. ANARBEKOV DIAS (KAZ)
5. KOKOVUROV KONSTANTIN (RUS)
5. ISAKAU ANTON (BLR)
7. PCHENITCIN ALEKSANDR (RUS)
7. GUSEV IGOR (RUS)

Referees:			

Senior Kumite Male +84kg

MOSCOW-KARATE-UNIVERSE INTERNATIONAL 2024

2024-11-09

Tatami

3 19:38

Pool

1,2,3,4,5,6,7,8

(c)sportdata GmbH & Co KG 2000-2024 (2024-11-10 18:21) v 10.2.0 build 1 (2024-07-20 11:09 CET) License: Online_Event_ID-8474_MOSCOWKARATEUNIVERSEINTERNATIONAL2024 (expire 2024-11-24)

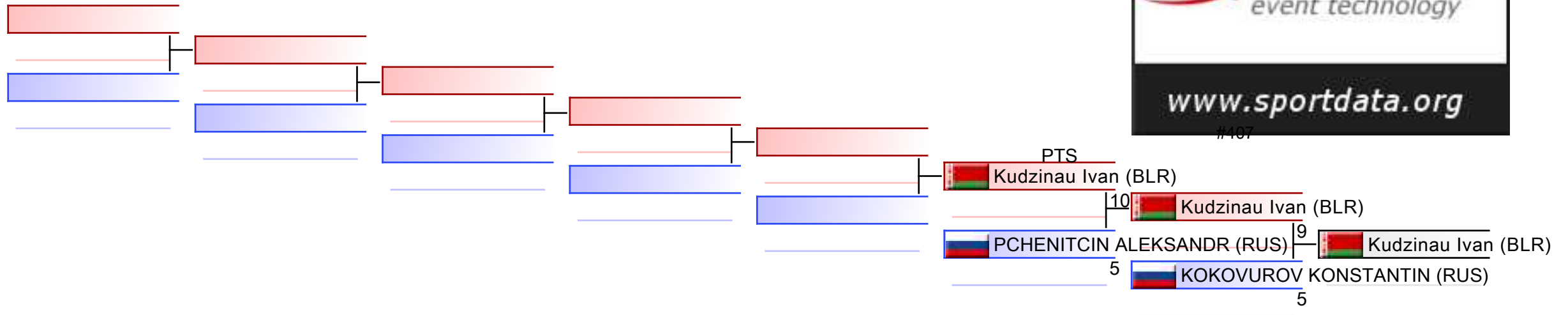

REPECHAGE: (1,2,3,4,5,6,7,8)

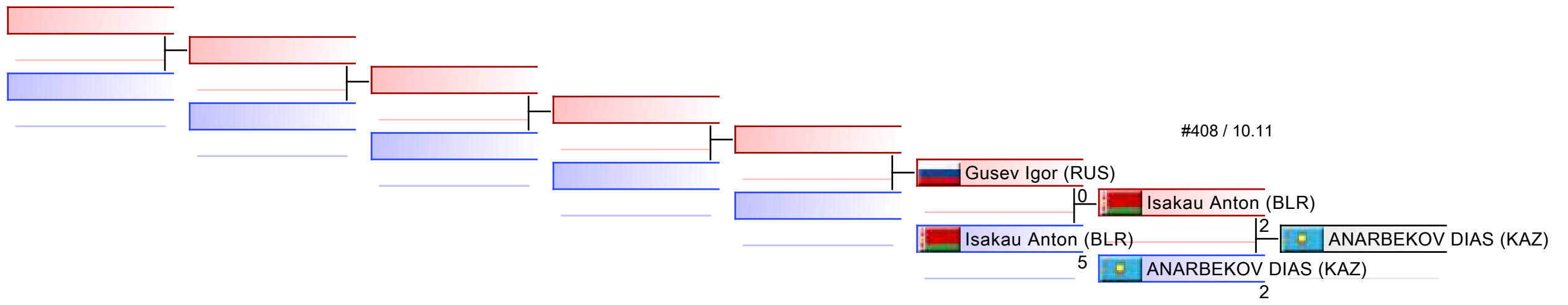

Referees:							
-----------	--	--	--	--	--	--	--



MOSCOW-KARATE-UNIVERSE
INTERNATIONAL 2024 - 2024-11-08



Official Results

Senior Kumite Male +84kg			
1	ABAZARI SALEH		IRI - ISLAMIC REPUBLIC OF IRAN
2	ASHOURI GARMJANI MAHDI		IRI - ISLAMIC REPUBLIC OF IRAN
3	KUDZINAU IVAN		BLR - BELARUS
3	ANARBEKOV DIAS		KAZ - KAZAKHSTAN
5	KOKOVUROV KONSTANTIN		RUS - RUSSIAN FEDERATION
5	ISAKAU ANTON		BLR - BELARUS
7	PCHENITCIN ALEKSANDR		RUS - RUSSIAN FEDERATION
7	GUSEV IGOR		RUS - RUSSIAN FEDERATION

SENIOR KUMITE MALE -60KG



MOSCOW-KARATE-UNIVERSE INTERNATIONAL ..
ENTRIES BY WEIGHT CATEGORY



Senior Kumite Male -60kg
As of 10 NOV 2024

NOC Code	Gender	Name	Seeding
AZE	M	guliyev aminagha	15
AZE	M	savadov farid	24
BLR	M	Kashyrski Maksim	
BLR	M	Prykhozka Pavel	
BLR	M	Vialionda Vadzim	
EGY	M	Mohamed Gaber	
IND	M	PYDIPATI BABI VARMA	
IND	M	SINDHIYA GAURAV	
ITA	M	Sabatino Christian	
KAZ	M	ALPYSBAY KAISAR	8
KAZ	M	BIGABYL ZHOLAMAN	
KAZ	M	Mussa Nurassyl	
KAZ	M	Timraliyev Darkhan	
KAZ	M	Turebek Yelnur	
KUW	M	HASAN NOUH	
MAD	M	RAJAONARISON CHRISTIANFINOANA	
PAK	M	RASHEED MUHAMMAD FARHAN	
RUS	M	BASCHIN EVGENIY	
RUS	M	BOLSHAKOV NIKITA	4
RUS	M	Pakhomov Suleyman	1
RUS	M	SALYNOV ALEKSANDR	3
RUS	M	Satybaldiev Erbol	
RUS	M	Savin Ilya	2
RUS	M	Surikov Artem	
SUI	M	Timmer Eric	16
TJK	M	Sultonov Alisher	
TJK	M	TESHAEV MUHAMMAD	
TUN	M	FERCHICHI IHEB	7
TUN	M	KHALIL KHALIL AHMED	
UZB	M	TURAKHONOV MEKHRIDDIN	

Senior Kumite Male -60kg - Round Robin (each against each)

MOSCOW-KARATE-UNIVERSE INTERNATIONAL 2024, Moscow, RUS

Tatami

Pool
1/8

1	MUSSA N. (KAZ)	
	#1 / 08.11	2 TIMMER E. (SUI)
2	TIMMER E. (SUI)	
		3
3	SAVADOV F. (AZE)	
	#2 / 08.11	3 BASCHIN E. (RUS)
4	BASCHIN E. (RUS)	
		5
5	MUSSA N. (KAZ)	
	#4 / 08.11	2 SAVADOV F. (AZE)
6	SAVADOV F. (AZE)	
		3
7	BASCHIN E. (RUS)	
	#5 / 08.11	3 TIMMER E. (SUI)
8	TIMMER E. (SUI)	
		3
9	MUSSA N. (KAZ)	
	#7 / 08.11	1 BASCHIN E. (RUS)
10	BASCHIN E. (RUS)	
		8
11	TIMMER E. (SUI)	
	#8 / 08.11	3 SAVADOV F. (AZE)
12	SAVADOV F. (AZE)	
		6

1. BASCHIN EVGENIY (RUS)
2. SAVADOV FARID (AZE)
3. TIMMER ERIC (SUI)
4. MUSSA NURASSYL (KAZ)



1. PAKHOMOV SULEYMAN (RUS)
2. FERCHICHI IHEB (TUN)
3. BIGABYL ZHOLAMAN (KAZ)
3. GULIYEV AMINAGHA (AZE)
5. BASCHIN EVGENIY (RUS)
5. SATYBALDIEV ERBOL (RUS)
7. PYDIPATI BABI VARMA (IND)
7. TUREBEK YELNUR (KAZ)

Referees:			

Senior Kumite Male -60kg - Round Robin (each against each)

MOSCOW-KARATE-UNIVERSE INTERNATIONAL 2024, Moscow, RUS

Tatami

Pool
2/8

1	TURAKHONOV M. (UZB)	#10 / 08.11	0	SABATINO C. (ITA)
2	SABATINO C. (ITA)		1	
3	KASHYRSKI M. (BLR)	#11 / 08.11	0	SALYNOV A. (RUS)
4	SALYNOV A. (RUS)		3	
5	TURAKHONOV M. (UZB)	#14 / 08.11	8	TURAKHONOV M. (UZB)
6	KASHYRSKI M. (BLR)		0	
7	SALYNOV A. (RUS)	#15 / 08.11	0	SABATINO C. (ITA)
8	SABATINO C. (ITA)		1	
9	TURAKHONOV M. (UZB)	#18 / 08.11	5	TURAKHONOV M. (UZB)
10	SALYNOV A. (RUS)		1	
11	SABATINO C. (ITA)	#19 / 08.11	4	KASHYRSKI M. (BLR)
12	KASHYRSKI M. (BLR)		4	

1. TURAKHONOV MEKHRIDDIN (UZB)
2. SABATINO CHRISTIAN (ITA)
3. KASHYRSKI MAKSIM (BLR)
4. SALYNOV ALEKSANDR (RUS)



1. PAKHOMOV SULEYMAN (RUS)
2. FERCHICHI IHEB (TUN)
3. BIGABYL ZHOLAMAN (KAZ)
3. GULIYEV AMINAGHA (AZE)
5. BASCHIN EVGENIY (RUS)
5. SATYBALDIEV ERBOL (RUS)
7. PYDIPATI BABI VARMA (IND)
7. TUREBEK YELNUR (KAZ)

Referees:			

Senior Kumite Male -60kg - Round Robin (each against each)

MOSCOW-KARATE-UNIVERSE INTERNATIONAL 2024, Moscow, RUS

Tatami

Pool
3/8

1	SURIKOV A. (RUS)	
	#22 / 08.11	2 BIGABYL Z. (KAZ)
2	BIGABYL Z. (KAZ)	5
3	RAJAONARISON C. (MAD)	
	#23 / 08.11	0 FERCHICHI I. (TUN)
4	FERCHICHI I. (TUN)	7
5	SURIKOV A. (RUS)	
	#25 / 08.11	3 SURIKOV A. (RUS)
6	RAJAONARISON C. (MAD)	3
7	FERCHICHI I. (TUN)	
	#26 / 08.11	3 FERCHICHI I. (TUN)
8	BIGABYL Z. (KAZ)	0
9	SURIKOV A. (RUS)	
	#28 / 08.11	3 FERCHICHI I. (TUN)
10	FERCHICHI I. (TUN)	4
11	BIGABYL Z. (KAZ)	
	#29 / 08.11	8 BIGABYL Z. (KAZ)
12	RAJAONARISON C. (MAD)	0

1. FERCHICHI IHEB (TUN)
2. BIGABYL ZHOLAMAN (KAZ)
3. SURIKOV ARTEM (RUS)
4. RAJAONARISON CHRISTIANFINCANA (MAD)



1. PAKHOMOV SULEYMAN (RUS)
2. FERCHICHI IHEB (TUN)
3. BIGABYL ZHOLAMAN (KAZ)
3. GULIYEV AMINAGHA (AZE)
5. BASCHIN EVGENIY (RUS)
5. SATYBALDIEV ERBOL (RUS)
7. PYDIPATI BABI VARMA (IND)
7. TUREBEK YELNUR (KAZ)

Referees:			

Senior Kumite Male -60kg - Round Robin (each against each)

MOSCOW-KARATE-UNIVERSE INTERNATIONAL 2024, Moscow, RUS

Tatami

Pool
4/8

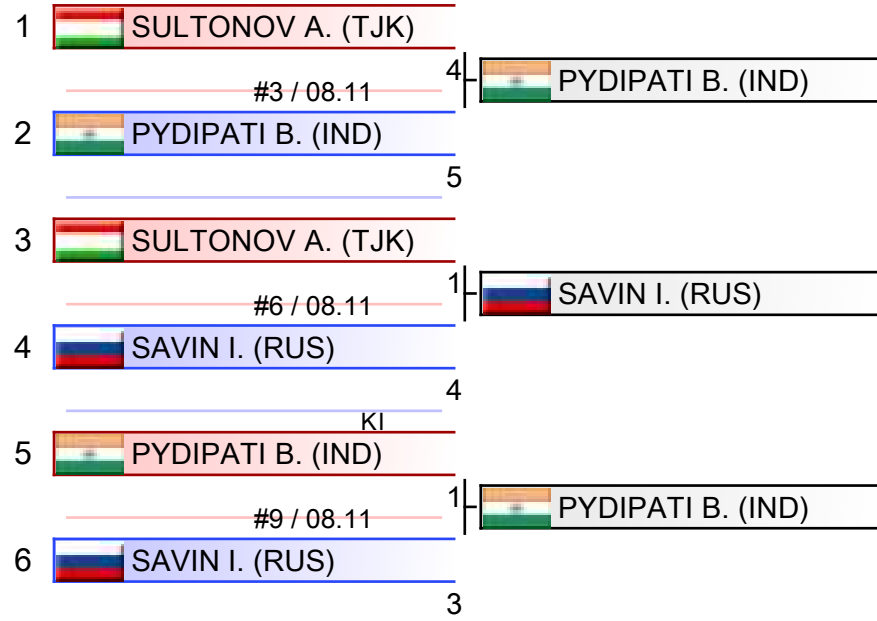

1. PYDIPATI BABI VARMA (IND)
2. SAVIN ILYA (RUS)
3. SULTONOV ALISHER (TJK)



1. PAKHOMOV SULEYMAN (RUS)
2. FERCHICHI IHEB (TUN)
3. BIGABYL ZHOLAMAN (KAZ)
3. GULIYEV AMINAGHA (AZE)
5. BASCHIN EVGENIY (RUS)
5. SATYBALDIEV ERBOL (RUS)
7. PYDIPATI BABI VARMA (IND)
7. TUREBEK YELNUR (KAZ)

Referees:			

Senior Kumite Male -60kg - Round Robin (each against each)

MOSCOW-KARATE-UNIVERSE INTERNATIONAL 2024, Moscow, RUS

Tatami

Pool
5/8

1	KHALIL K. (TUN)	#31 / 08.11	0	GULIYEV A. (AZE)
2	GULIYEV A. (AZE)		4	
3	VIALIONDA V. (BLR)	#32 / 08.11	2	HASAN N. (KUW)
4	HASAN N. (KUW)		11	
5	KHALIL K. (TUN)	#35 / 08.11	9	KHALIL K. (TUN)
6	VIALIONDA V. (BLR)		2	
7	HASAN N. (KUW)	#36 / 08.11	1	GULIYEV A. (AZE)
8	GULIYEV A. (AZE)		2	
9	KHALIL K. (TUN)	#39 / 08.11	6	KHALIL K. (TUN)
10	HASAN N. (KUW)		2	
11	GULIYEV A. (AZE)	#40 / 08.11	3	GULIYEV A. (AZE)
12	VIALIONDA V. (BLR)		2	

1. GULIYEV AMINAGHA (AZE)
2. KHALIL KHALIL AHMED (TUN)
3. HASAN NOUH (KUW)
4. VIALIONDA VADZIM (BLR)



1. PAKHOMOV SULEYMAN (RUS)
2. FERCHICHI IHEB (TUN)
3. BIGABYL ZHOLAMAN (KAZ)
3. GULIYEV AMINAGHA (AZE)
5. BASCHIN EVGENIY (RUS)
5. SATYBALDIEV ERBOL (RUS)
7. PYDIPATI BABI VARMA (IND)
7. TUREBEK YELNUR (KAZ)

Referees:			

Senior Kumite Male -60kg - Round Robin (each against each)

MOSCOW-KARATE-UNIVERSE INTERNATIONAL 2024, Moscow, RUS

Tatami

Pool
6/8

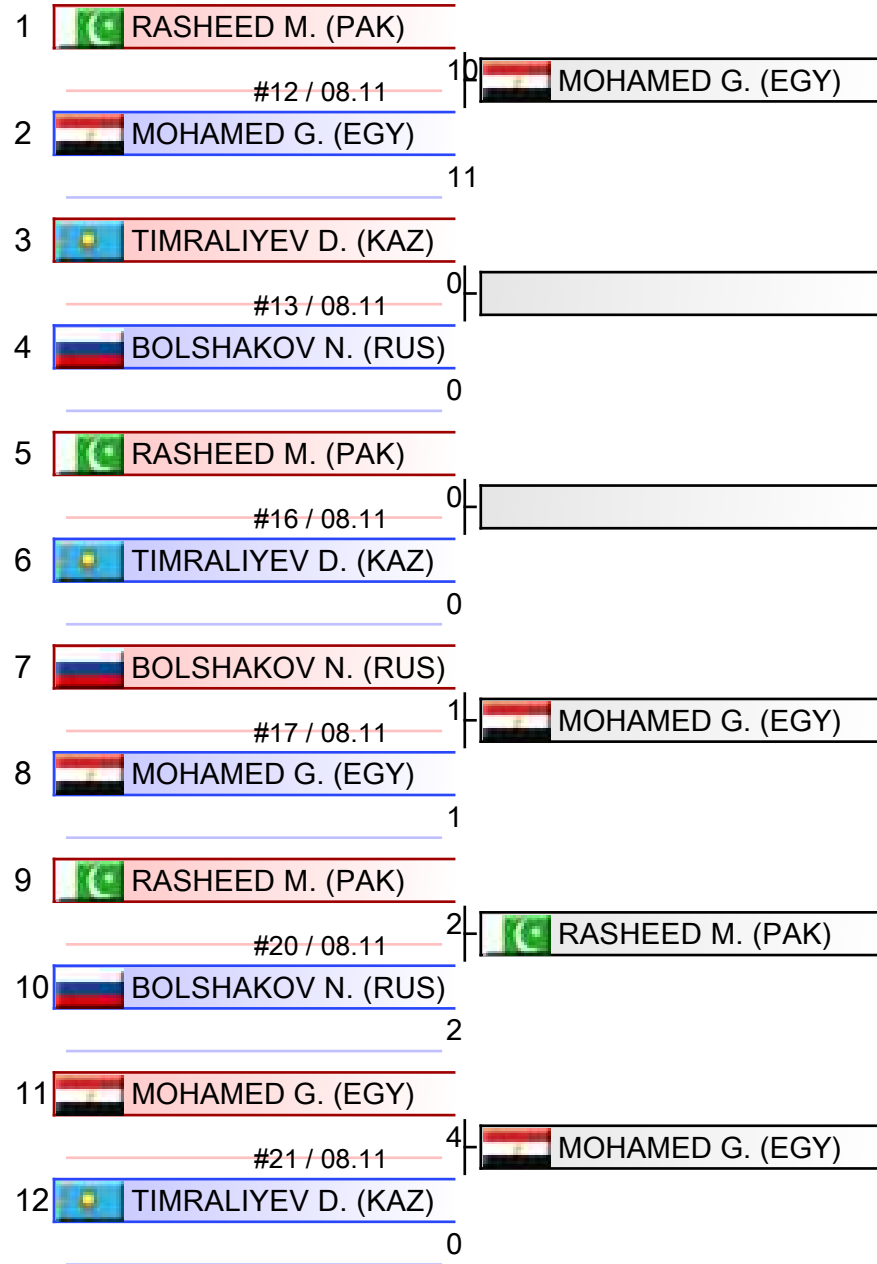

1. MOHAMED GABER (EGY)
2. RASHEED MUHAMMAD FARHAN (PAK)
3. TIMRALIYEV DARKHAN (KAZ)
4. BOLSHAKOV NIKITA (RUS)



1. PAKHOMOV SULEYMAN (RUS)
2. FERCHICHI IHEB (TUN)
3. BIGABYL ZHOLAMAN (KAZ)
3. GULIYEV AMINAGHA (AZE)
5. BASCHIN EVGENIY (RUS)
5. SATYBALDIEV ERBOL (RUS)
7. PYDIPATI BABI VARMA (IND)
7. TUREBEK YELNUR (KAZ)













Referees:			

Senior Kumite Male -60kg - Round Robin (each against each)

MOSCOW-KARATE-UNIVERSE INTERNATIONAL 2024, Moscow, RUS

Tatami

Pool
7/8

1	 SATYBALDIEV E. (RUS)	
	#33 / 08.11	
2	 PRYKHODZKA P. (BLR)	
3	 SINDHIYA G. (IND)	
	#34 / 08.11	8
4	 ALPYSBAY K. (KAZ)	
		9
5	 SATYBALDIEV E. (RUS)	
	#37 / 08.11	3
6	 SINDHIYA G. (IND)	
		1
7	 ALPYSBAY K. (KAZ)	
	#38 / 08.11	
8	 PRYKHODZKA P. (BLR)	
9	 SATYBALDIEV E. (RUS)	
	#41 / 08.11	5
10	 ALPYSBAY K. (KAZ)	
		2
11	 PRYKHODZKA P. (BLR)	
	#42 / 08.11	0
12	 SINDHIYA G. (IND)	
		0

1. SATYBALDIEV ERBOL (RUS)
2. ALPYSBAY KAISAR (KAZ)
3. SINDHIYA GAURAV (IND)
4. PRYKHODZKA PAVEL (BLR)



1. PAKHOMOV SULEYMAN (RUS)
2. FERCHICHI IHEB (TUN)
3. BIGABYL ZHOLAMAN (KAZ)
3. GULIYEV AMINAGHA (AZE)
5. BASCHIN EVGENIY (RUS)
5. SATYBALDIEV ERBOL (RUS)
7. PYDIPATI BABI VARMA (IND)
7. TUREBEK YELNUR (KAZ)









Referees:			

Senior Kumite Male -60kg - Round Robin (each against each)

MOSCOW-KARATE-UNIVERSE INTERNATIONAL 2024, Moscow, RUS

Tatami

Pool
8/8

1	 TUREBEK Y. (KAZ)	
	#24 / 08.11	9  TUREBEK Y. (KAZ)
2	 TESHAEV M. (TJK)	0
3	 TUREBEK Y. (KAZ)	5  PAKHOMOV S. (RUS)
	#27 / 08.11	
4	 PAKHOMOV S. (RUS)	8
5	 TESHAEV M. (TJK)	1  PAKHOMOV S. (RUS)
	#30 / 08.11	
6	 PAKHOMOV S. (RUS)	8

1. PAKHOMOV SULEYMAN (RUS)
2. TUREBEK YELNUR (KAZ)
3. TESHAEV MUHAMMAD (TJK)



1. PAKHOMOV SULEYMAN (RUS)
2. FERCHICHI IHEB (TUN)
3. BIGABYL ZHOLAMAN (KAZ)
3. GULIYEV AMINAGHA (AZE)
5. BASCHIN EVGENIY (RUS)
5. SATYBALDIEV ERBOL (RUS)
7. PYDIPATI BABI VARMA (IND)
7. TUREBEK YELNUR (KAZ)

Referees:			

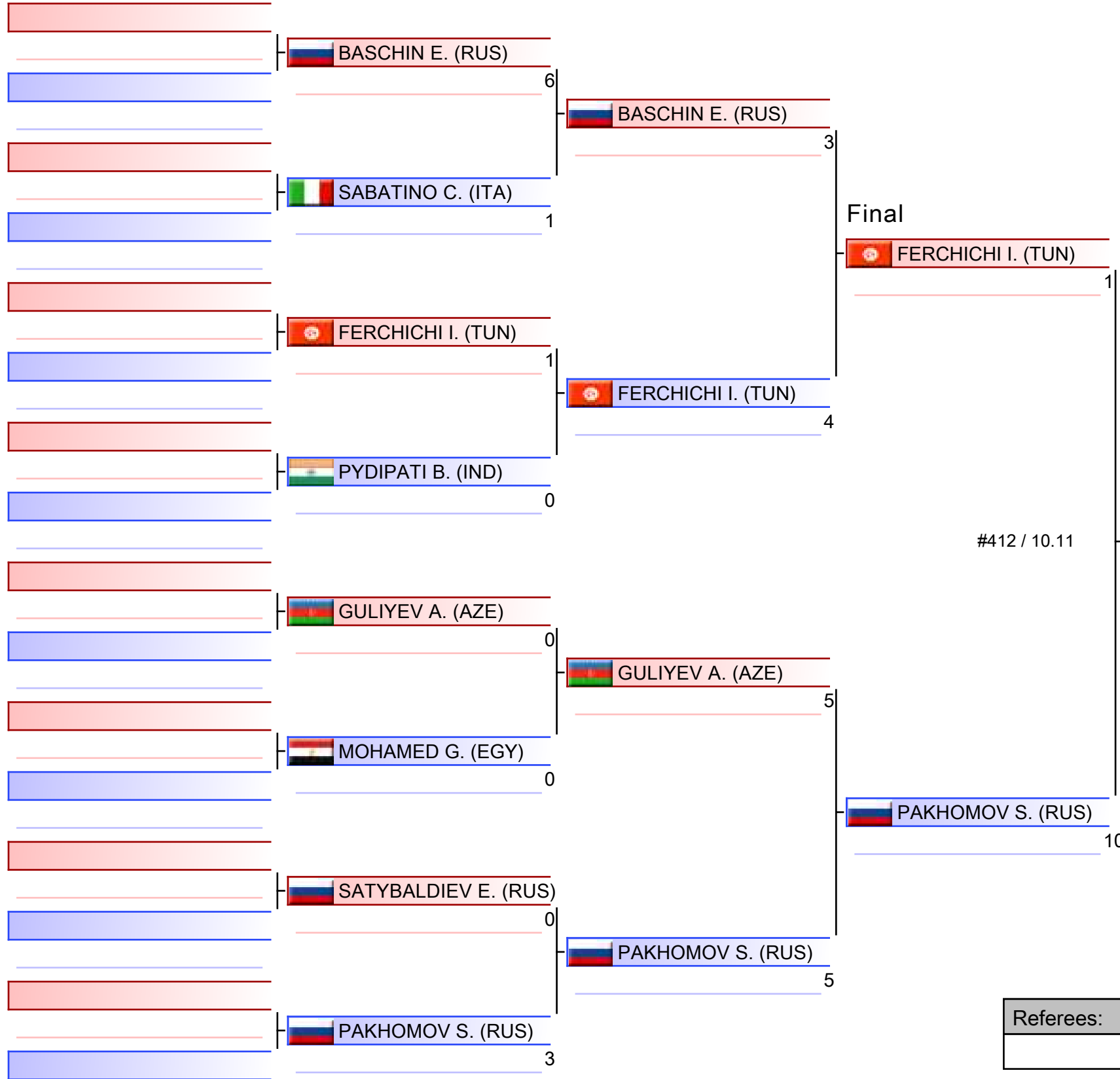

#412 / 10.11

1. PAKHOMOV SULEYMAN (RUS)
2. FERCHICHI IHEB (TUN)
3. BIGABYL ZHOLAMAN (KAZ)
3. GULIYEV AMINAGHA (AZE)
5. BASCHIN EVGENIY (RUS)
5. SATYBALDIEV ERBOL (RUS)
7. PYDIPATI BABI VARMA (IND)
7. TUREBEK YELNUR (KAZ)

Referees:			

Senior Kumite Male -60kg

MOSCOW-KARATE-UNIVERSE INTERNATIONAL 2024

2024-11-08

Tatami
1 20:00

Pool
1,2,3,4,5,6,7,8

(c)sportdata GmbH & Co KG 2000-2024 (2024-11-10 18:21) v 10.2.0 build 1 (2024-07-20 11:09 CET) License: Online_Event_ID-8474_MOSCOWKARATEUNIVERSEINTERNATIONAL2024 (expire 2024-11-24)

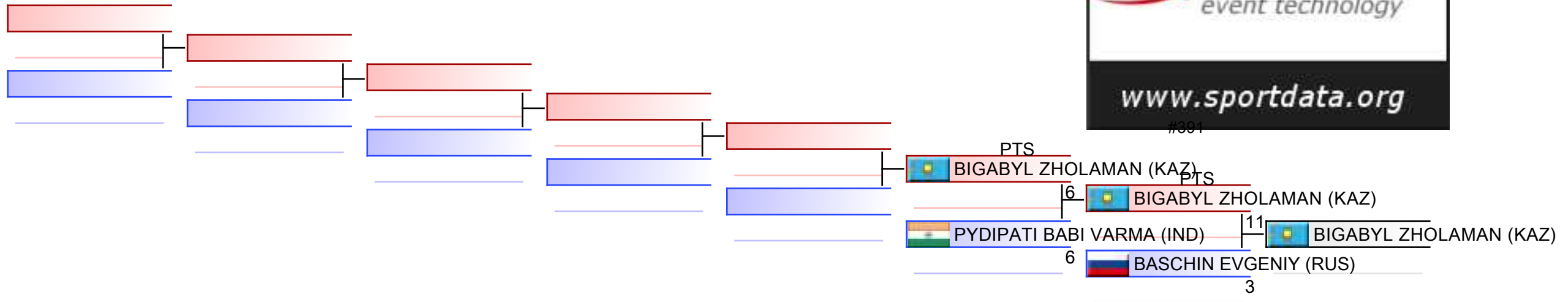

REPECHAGE: (1,2,3,4,5,6,7,8)

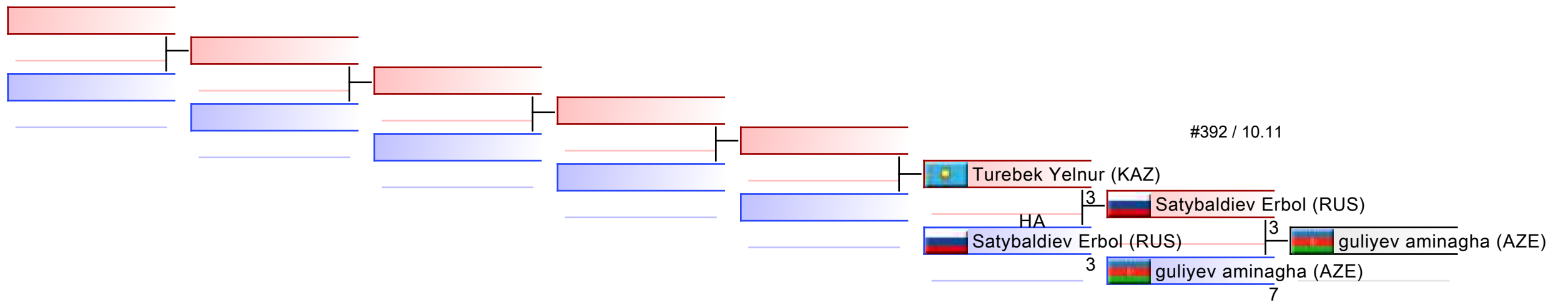

Referees:							
-----------	--	--	--	--	--	--	--



MOSCOW-KARATE-UNIVERSE
INTERNATIONAL 2024 - 2024-11-08



Official Results

Senior Kumite Male -60kg			
1	PAKHOMOV SULEYMAN		RUS - RUSSIAN FEDERATION
2	FERCHICHI IHEB		TUN - TUNISIA
3	BIGABYL ZHOLAMAN		KAZ - KAZAKHSTAN
3	GULIYEV AMINAGHA		AZE - AZERBAIJAN
5	BASCHIN EVGENIY		RUS - RUSSIAN FEDERATION
5	SATYBALDIEV ERBOL		RUS - RUSSIAN FEDERATION
7	PYDIPATI BABI VARMA		IND - INDIA
7	TUREBEK YELNUR		KAZ - KAZAKHSTAN

SENIOR KUMITE MALE -67KG



MOSCOW-KARATE-UNIVERSE INTERNATIONAL ..
ENTRIES BY WEIGHT CATEGORY



Senior Kumite Male -67kg
As of 10 NOV 2024

NOC Code	Gender	Name	Seeding
ARM	M	Harutyunyan Suren	15
AZE	M	mammadli huseyn	13
AZE	M	nuran rzazade	
BLR	M	Bahamolets Mikita	
BLR	M	Krautsou Artsiom	
BLR	M	Markau Matsvei	
BLR	M	Melyokhin Oleg	
BLR	M	Stahouski Arseni	
CIV	M	MEITE IBRAHIMA SY	
EGY	M	Fathy Ebrahim	
IND	M	DAS RUPESH	
ITA	M	De Vivo Gianluca	
ITA	M	Ingenito Angelo	
KAZ	M	ALTYNBEK OLZHAS	
KAZ	M	Tangirbergen Yersultan	
KGZ	M	Baratov Vizit	
KSA	M	HUSSAIN NASHWAN	
PAK	M	DIN SHAMS UD	
RUS	M	Akhmedov Akhmed	2
RUS	M	Danilov Daniil	5
RUS	M	Ilushin Anatoliy	4
RUS	M	Mikhailichenko Danila	7
RUS	M	Ogannisyan Yurik	1
RUS	M	SON EVGENII	8
RUS	M	Spitsin Sergey	3
RUS	M	UKHABOV PAVEL	6
SRB	M	JOKSIC STEFAN	
TJK	M	MASHRABOV SIYOVUSH	
TJK	M	Sharapov Abdulvahob	
TUR	M	YILMAZ Ekrem Altuner	
UZB	M	RASHIDOV ABDUL VAKHKHOB	
UZB	M	RASULOV MANSUR	

Senior Kumite Male -67kg - Round Robin (each against each)

MOSCOW-KARATE-UNIVERSE INTERNATIONAL 2024, Moscow, RUS

Tatami

Pool
1/8

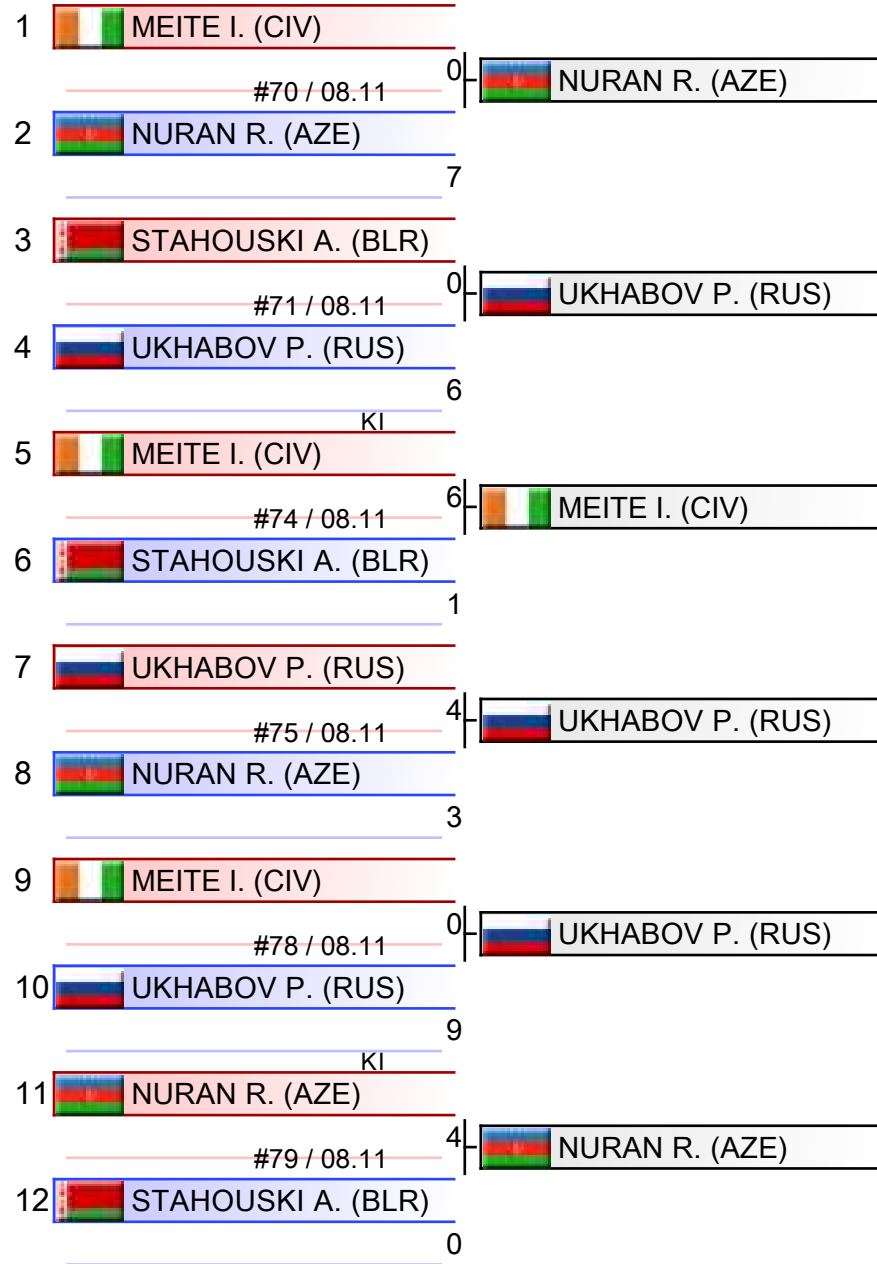

1. UKHABOV PAVEL (RUS)
2. NURAN RZAZADE (AZE)
3. MEITE IBRAHIMA SY (CIV)
4. STAHOUSKI ARSENI (BLR)



1. MIKHAILICHENKO DANILA (RUS)
2. OGANNISYAN YURIK (RUS)
3. UKHABOV PAVEL (RUS)
3. MAMMADLI HUSEYN (AZE)
5. BARATOV VIZIT (KGZ)
5. ILUSHIN ANATOLIY (RUS)
7. AKHMEDOV AKHMED (RUS)
7. RASHIDOV ABDUL VAKHKHOB (UZB)













Referees:			

Senior Kumite Male -67kg - Round Robin (each against each)

MOSCOW-KARATE-UNIVERSE INTERNATIONAL 2024, Moscow, RUS

Tatami

Pool
2/8

1	 KRAUTSOU A. (BLR)	
	#82 / 08.11	0
2	 ALTYNBEK O. (KAZ)	0
3	 JOKSIC S. (SRB)	
	#83 / 08.11	1
4	 SPITSIN S. (RUS)	3
5	 KRAUTSOU A. (BLR)	
	#86 / 08.11	1
6	 JOKSIC S. (SRB)	3
7	 SPITSIN S. (RUS)	
	#87 / 08.11	0
8	 ALTYNBEK O. (KAZ)	0
9	 KRAUTSOU A. (BLR)	
	#90 / 08.11	0
10	 SPITSIN S. (RUS)	1
	PTS	
11	 ALTYNBEK O. (KAZ)	
	#91 / 08.11	4
12	 JOKSIC S. (SRB)	4

1. SPITSIN SERGEY (RUS)
2. ALTYNBEK OLZHAS (KAZ)
3. JOKSIC STEFAN (SRB)
4. KRAUTSOU ARTSIOM (BLR)



1. MIKHAILICHENKO DANILA (RUS)
2. OGANNISYAN YURIK (RUS)
3. UKHABOV PAVEL (RUS)
3. MAMMADLI HUSEYN (AZE)
5. BARATOV VIZIT (KGZ)
5. ILUSHIN ANATOLIY (RUS)
7. AKHMEDOV AKHMED (RUS)
7. RASHIDOV ABDUL VAKHKHOB (UZB)

Referees:			

Senior Kumite Male -67kg - Round Robin (each against each)

MOSCOW-KARATE-UNIVERSE INTERNATIONAL 2024, Moscow, RUS

Tatami

Pool
3/8

1	MELYOKHIN O. (BLR)	
	#94 / 08.11	4 MASHRABOV S. (TJK)
2	MASHRABOV S. (TJK)	7
3	BARATOV V. (KGZ)	
	#95 / 08.11	2 MIKHAILICHENKO D. (RUS)
4	MIKHAILICHENKO D. (RUS)	10
5	MELYOKHIN O. (BLR)	
	#98 / 08.11	1 MELYOKHIN O. (BLR)
6	BARATOV V. (KGZ)	1
7	MIKHAILICHENKO D. (RUS)	
	#99 / 08.11	8 MIKHAILICHENKO D. (RUS)
8	MASHRABOV S. (TJK)	0
9	MELYOKHIN O. (BLR)	
	#102 / 08.11	1 MIKHAILICHENKO D. (RUS)
10	MIKHAILICHENKO D. (RUS)	4
11	MASHRABOV S. (TJK)	
	#103 / 08.11	0 BARATOV V. (KGZ)
12	BARATOV V. (KGZ)	4

1. MIKHAILICHENKO DANILA (RUS)
2. BARATOV VIZIT (KGZ)
3. MASHRABOV SIYOVUSH (TJK)
4. MELYOKHIN OLEG (BLR)



1. MIKHAILICHENKO DANILA (RUS)
2. OGANNISYAN YURIK (RUS)
3. UKHABOV PAVEL (RUS)
3. MAMMADLI HUSEYN (AZE)
5. BARATOV VIZIT (KGZ)
5. ILUSHIN ANATOLIY (RUS)
7. AKHMEDOV AKHMED (RUS)
7. RASHIDOV ABDUL VAKHKHOB (UZB)

Referees:			

Senior Kumite Male -67kg - Round Robin (each against each)

MOSCOW-KARATE-UNIVERSE INTERNATIONAL 2024, Moscow, RUS

Tatami

Pool
4/8

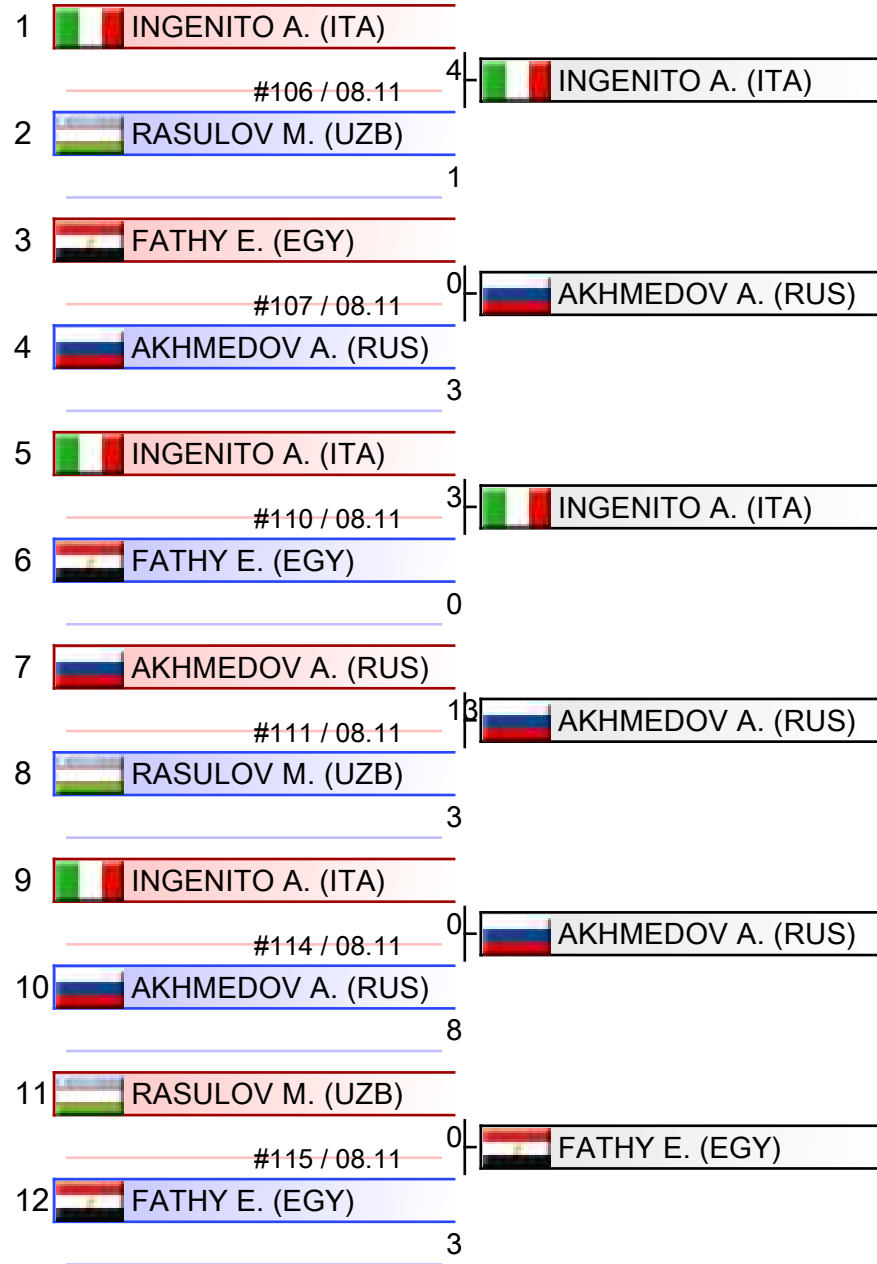

1. AKHMEDOV AKHMED (RUS)
2. INGENITO ANGELO (ITA)
3. FATHY EBRAHIM (EGY)
4. RASULOV MANSUR (UZB)



1. MIKHAILICHENKO DANILA (RUS)
2. OGANNISYAN YURIK (RUS)
3. UKHABOV PAVEL (RUS)
3. MAMMADLI HUSEYN (AZE)
5. BARATOV VIZIT (KGZ)
5. ILUSHIN ANATOLIY (RUS)
7. AKHMEDOV AKHMED (RUS)
7. RASHIDOV ABDUL VAKHKHOB (UZB)

Referees:			

Senior Kumite Male -67kg - Round Robin (each against each)

MOSCOW-KARATE-UNIVERSE INTERNATIONAL 2024, Moscow, RUS

Tatami

Pool
5/8



1. HARUTYUNYAN SUREN (ARM)
2. DAS RUPESH (IND)
3. HUSSAIN NASHWAN (KSA)
4. DANILOV DANIIL (RUS)



1. MIKHAILICHENKO DANILA (RUS)
2. OGANNISYAN YURIK (RUS)
3. UKHABOV PAVEL (RUS)
3. MAMMADLI HUSEYN (AZE)
5. BARATOV VIZIT (KGZ)
5. ILUSHIN ANATOLIY (RUS)
7. AKHMEDOV AKHMED (RUS)
7. RASHIDOV ABDUL VAKHKHOB (UZB)

Referees:			

Senior Kumite Male -67kg - Round Robin (each against each)

MOSCOW-KARATE-UNIVERSE INTERNATIONAL 2024, Moscow, RUS

Tatami

Pool
6/8

1	DIN S. (PAK)		
	#72 / 08.11	3	BAHAMOLETS M. (BLR)
2	BAHAMOLETS M. (BLR)		
		7	
3	YILMAZ E. (TUR)		
	#73 / 08.11	0	ILUSHIN A. (RUS)
4	ILUSHIN A. (RUS)		
		7	
5	DIN S. (PAK)		
	#76 / 08.11	3	YILMAZ E. (TUR)
6	YILMAZ E. (TUR)		
		9	
7	ILUSHIN A. (RUS)		
	#77 / 08.11	3	ILUSHIN A. (RUS)
8	BAHAMOLETS M. (BLR)		
		3	
9	DIN S. (PAK)		
	#80 / 08.11	1	ILUSHIN A. (RUS)
10	ILUSHIN A. (RUS)		
		10	
11	BAHAMOLETS M. (BLR)		
	#81 / 08.11	1	YILMAZ E. (TUR)
12	YILMAZ E. (TUR)		
		8	

1. ILUSHIN ANATOLIY (RUS)
2. YILMAZ EKREM ALTUNER (TUR)
3. BAHAMOLETS MIKITA (BLR)
4. DIN SHAMS UD (PAK)



1. MIKHAILICHENKO DANILA (RUS)
2. OGANNISYAN YURIK (RUS)
3. UKHABOV PAVEL (RUS)
3. MAMMADLI HUSEYN (AZE)
5. BARATOV VIZIT (KGZ)
5. ILUSHIN ANATOLIY (RUS)
7. AKHMEDOV AKHMED (RUS)
7. RASHIDOV ABDUL VAKHKHOB (UZB)

Referees:			

Senior Kumite Male -67kg - Round Robin (each against each)

MOSCOW-KARATE-UNIVERSE INTERNATIONAL 2024, Moscow, RUS

Tatami

Pool
7/8

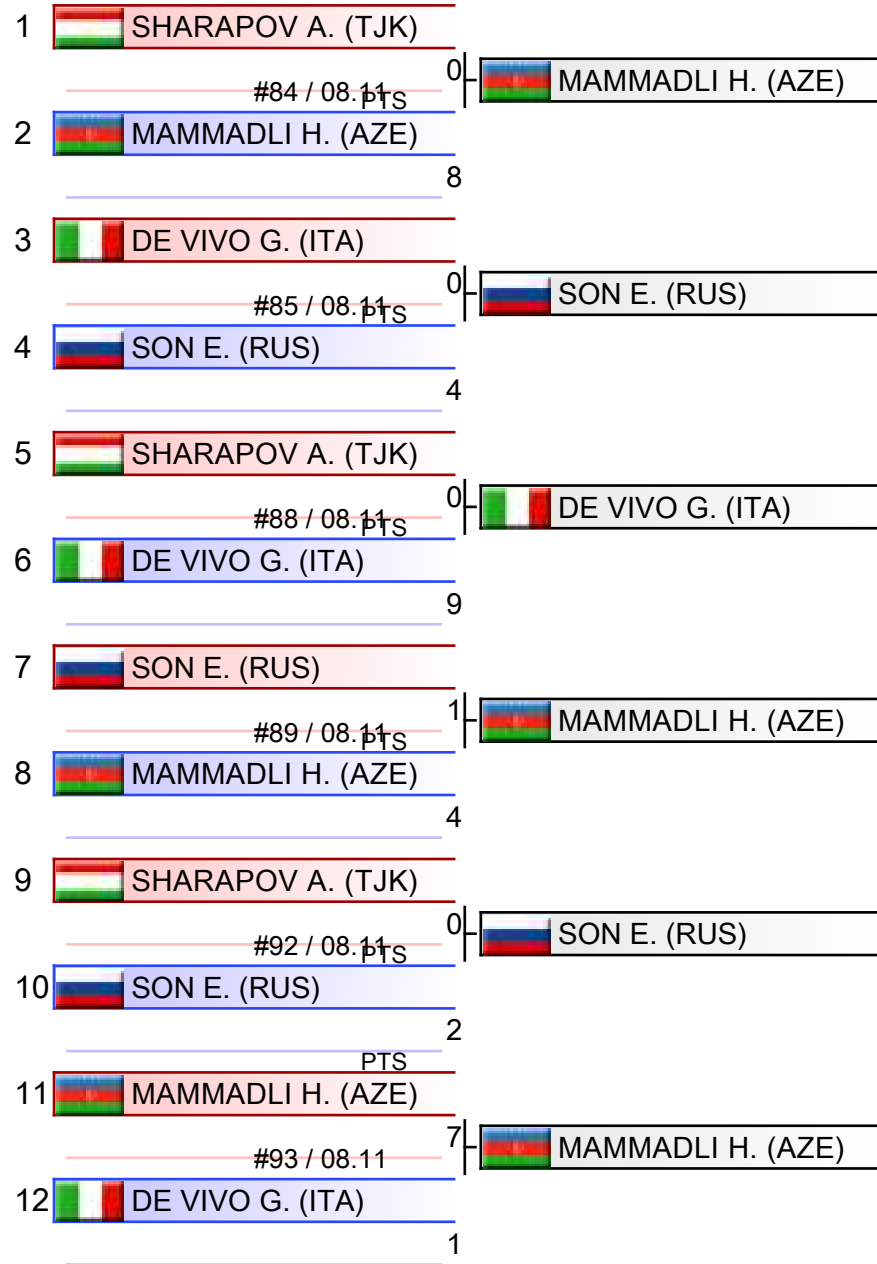

1. MAMMADLI HUSEYN (AZE)
2. SON EVGENII (RUS)
3. DE VIVO GIANLUCA (ITA)
4. SHARAPOV ABDULVAHOB (TJK)



1. MIKHAILICHENKO DANILA (RUS)
2. OGANNISYAN YURIK (RUS)
3. UKHABOV PAVEL (RUS)
3. MAMMADLI HUSEYN (AZE)
5. BARATOV VIZIT (KGZ)
5. ILUSHIN ANATOLIY (RUS)
7. AKHMEDOV AKHMED (RUS)
7. RASHIDOV ABDUL VAKHKHOB (UZB)

Referees:			

Senior Kumite Male -67kg - Round Robin (each against each)

MOSCOW-KARATE-UNIVERSE INTERNATIONAL 2024, Moscow, RUS

Tatami

Pool
8/8

1	RASHIDOV A. (UZB)	#96 / 08.11	10	RASHIDOV A. (UZB)
2	TANGIRBERGEN Y. (KAZ)		0	
3	MARKAU M. (BLR)	#97 / 08.11	0	OGANNISYAN Y. (RUS)
4	OGANNISYAN Y. (RUS)		8	
5	RASHIDOV A. (UZB)	#100 / 08.11	6	RASHIDOV A. (UZB)
6	MARKAU M. (BLR)		0	
7	OGANNISYAN Y. (RUS)	#101 / 08.11	9	OGANNISYAN Y. (RUS)
8	TANGIRBERGEN Y. (KAZ)		0	
9	RASHIDOV A. (UZB)	#104 / 08.11	4	OGANNISYAN Y. (RUS)
10	OGANNISYAN Y. (RUS)		4	
11	TANGIRBERGEN Y. (KAZ)	#105 / 08.11	0	MARKAU M. (BLR)
12	MARKAU M. (BLR)		3	

- OGANNISYAN YURIK (RUS)
- RASHIDOV ABDUL VAKHKHOB (UZB)
- MARKAU MATSVEI (BLR)
- TANGIRBERGEN YERSULTAN (KAZ)



1. MIKHAILICHENKO DANILA (RUS)
2. OGANNISYAN YURIK (RUS)
3. UKHABOV PAVEL (RUS)
3. MAMMADLI HUSEYN (AZE)
5. BARATOV VIZIT (KGZ)
5. ILUSHIN ANATOLIY (RUS)
7. AKHMEDOV AKHMED (RUS)
7. RASHIDOV ABDUL VAKHKHOB (UZB)

Referees:			

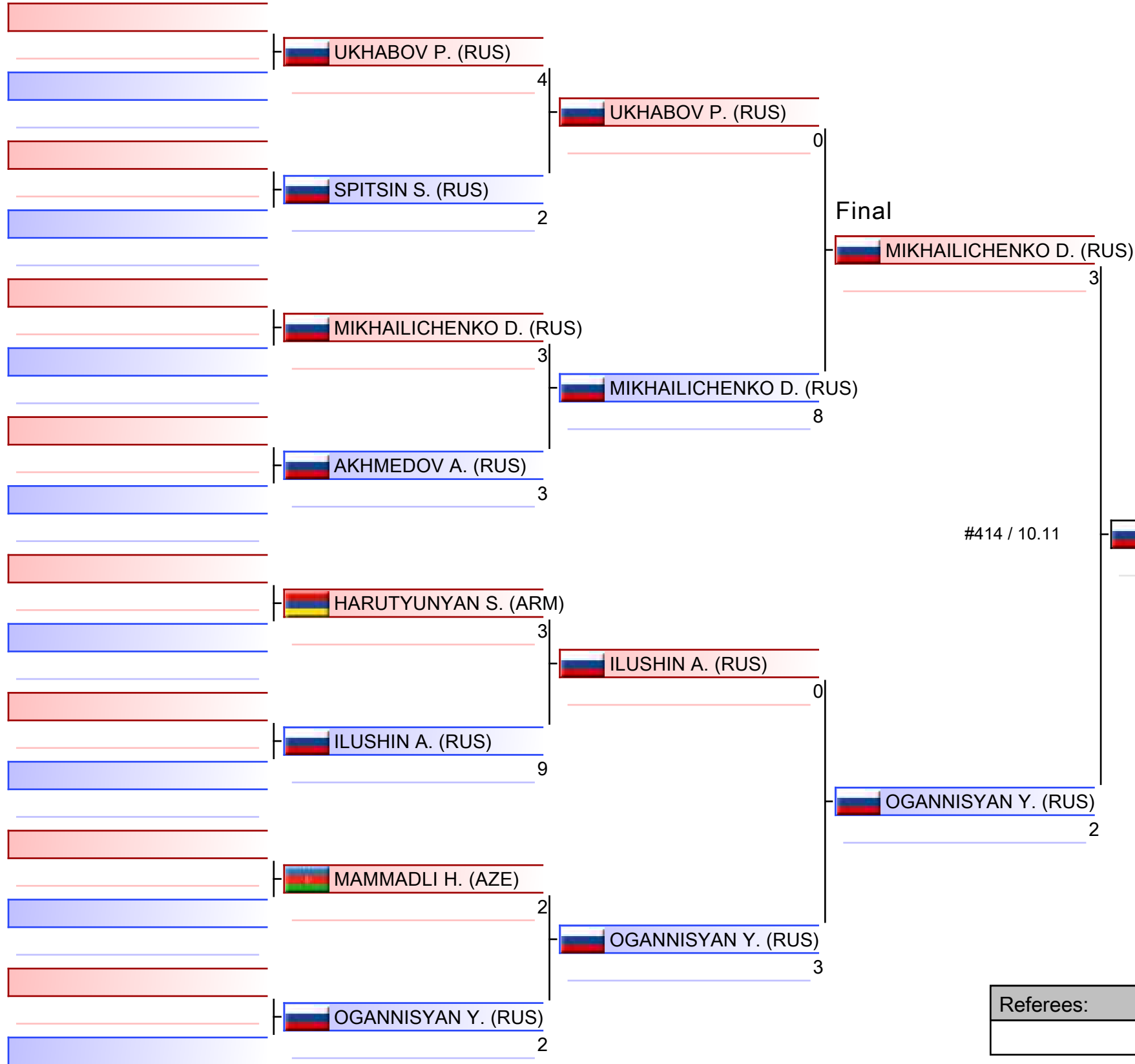

1. MIKHAILICHENKO DANILA (RUS)
2. OGANNISYAN YURIK (RUS)
3. UKHABOV PAVEL (RUS)
3. MAMMADLI HUSEYN (AZE)
5. BARATOV VIZIT (KGZ)
5. ILUSHIN ANATOLIY (RUS)
7. AKHMEDOV AKHMED (RUS)
7. RASHIDOV ABDUL VAKHKHOB (UZB)

Referees:			

Senior Kumite Male -67kg

MOSCOW-KARATE-UNIVERSE INTERNATIONAL 2024

2024-11-08

Tatami
1 20:10

Pool
1,2,3,4,5,6,7,8

(c)sportdata GmbH & Co KG 2000-2024 (2024-11-10 18:21) v 10.2.0 build 1 (2024-07-20 11:09 CET) License: Online_Event_ID-8474_MOSCOWKARATEUNIVERSEINTERNATIONAL2024 (expire 2024-11-24)

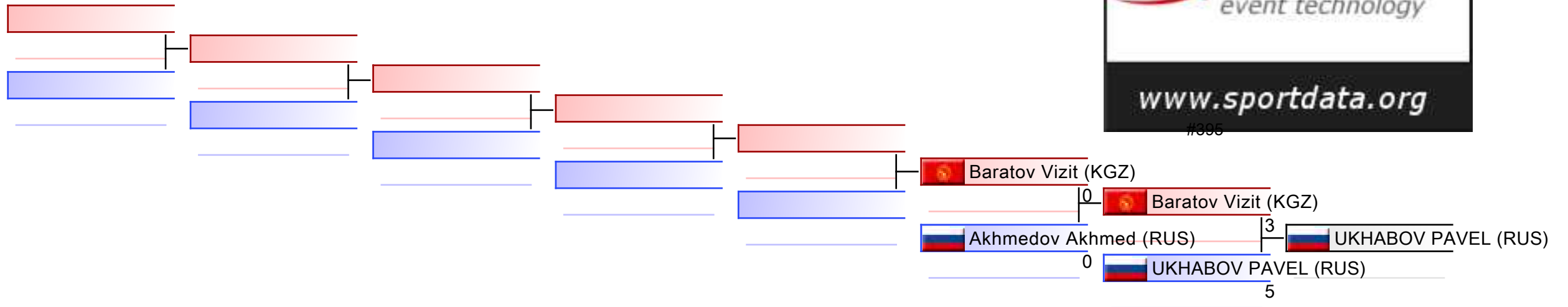

REPECHAGE: (1,2,3,4,5,6,7,8)

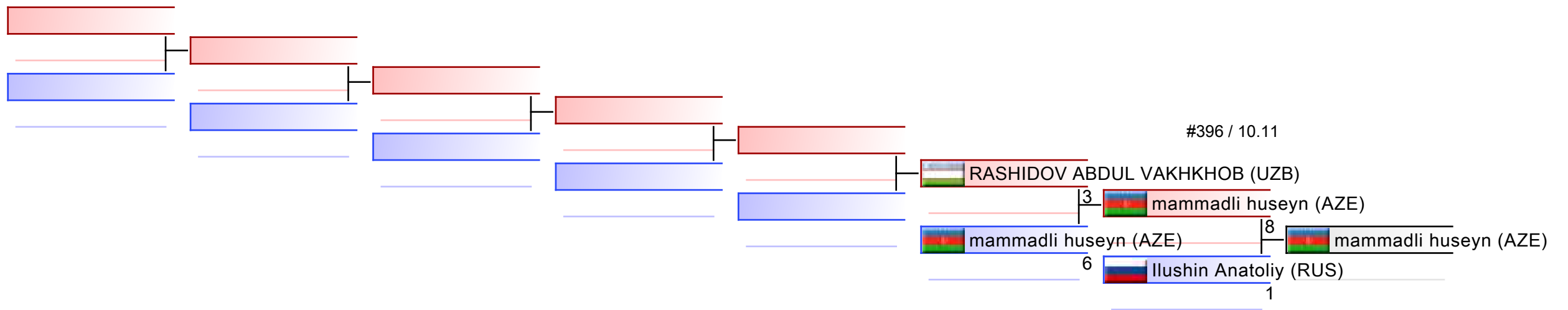

Referees:							
-----------	--	--	--	--	--	--	--



MOSCOW-KARATE-UNIVERSE
INTERNATIONAL 2024 - 2024-11-08



Official Results

Senior Kumite Male -67kg			
1	MIKHAILICHENKO DANILA		RUS - RUSSIAN FEDERATION
2	OGANNISYAN YURIK		RUS - RUSSIAN FEDERATION
3	UKHABOV PAVEL		RUS - RUSSIAN FEDERATION
3	MAMMADLI HUSEYN		AZE - AZERBAIJAN
5	BARATOV VIZIT		KGZ - KYRGYZSTAN
5	ILUSHIN ANATOLIY		RUS - RUSSIAN FEDERATION
7	AKHMEDOV AKHMED		RUS - RUSSIAN FEDERATION
7	RASHIDOV ABDUL VAKHKHOB		UZB - UZBEKISTAN

SENIOR KUMITE MALE -75KG



MOSCOW-KARATE-UNIVERSE INTERNATIONAL ..
ENTRIES BY WEIGHT CATEGORY



Senior Kumite Male -75kg
As of 10 NOV 2024

NOC Code	Gender	Name	Seeding
ALG	M	OUSSAMA ZAID	
ARM	M	Hovhannisyan Robert	
ARM	M	Karyan Hayk	
ARM	M	MAKYAN DAVIT	
BLR	M	Chymbur Raman	
BLR	M	Dubina Mikita	
BLR	M	Kryviankou Daniil	
BLR	M	Nhuyen Devid	
BLR	M	Rysevets Hleb	
BLR	M	Volosov Uladzislau	
EGY	M	Elsawy Aly	6
IND	M	SHARMA PRANAY	
IRI	M	Askaripour Mohammaderfan	16
IRI	M	Nemati Morteza	
IRI	M	SHAHGOL MAHDI	
KAZ	M	AZHIKANOV NURKANAT	8
KAZ	M	BATYRGALI ABILMANSUR	
KAZ	M	Ganiyev Alikhan	
KAZ	M	MUKHAT AIDOS	
KGZ	M	Nurlanov Nazim	
RUS	M	AKHMEDOV RUSTAM	7
RUS	M	Fedin Timofey	11
RUS	M	Gadzhiev Gadzhi	4
RUS	M	Grachev Semen	2
RUS	M	GRETSKIY DANIIL	
RUS	M	Khorsik Egor	3
RUS	M	Makhmudov Oleg	14
RUS	M	Pritmov Alexander	5
RUS	M	SHARAFUTDINOV ERNEST	1
SRB	M	TOPUZOVIC ALEKSANDAR	
UZB	M	MUKHAMMADIYEV KUVONCHBEK	

Senior Kumite Male -75kg - Round Robin (each against each)

MOSCOW-KARATE-UNIVERSE INTERNATIONAL 2024, Moscow, RUS

Tatami

Pool
1/8

1	MAKYAN D. (ARM)	
	#157 / 08.11	1 ASKARIPOUR M. (IRI)
2	ASKARIPOUR M. (IRI)	6
3	RYSEVETS H. (BLR)	
	#158 / 08.11	4 ELSAWY A. (EGY)
4	ELSAWY A. (EGY)	5
	PTS	
5	MAKYAN D. (ARM)	
	#161 / 08.11	9 MAKYAN D. (ARM)
6	RYSEVETS H. (BLR)	1
	PTS	
7	ELSAWY A. (EGY)	
	#162 / 08.11	5 ELSAWY A. (EGY)
8	ASKARIPOUR M. (IRI)	2
9	MAKYAN D. (ARM)	
	#165 / 08.11	0 ELSAWY A. (EGY)
10	ELSAWY A. (EGY)	3
	PTS	
11	ASKARIPOUR M. (IRI)	
	#166 / 08.11	6 ASKARIPOUR M. (IRI)
12	RYSEVETS H. (BLR)	1

1. ELSAWY ALY (EGY)
2. ASKARIPOUR MOHAMMADERFAN (IRI)
3. MAKYAN DAVIT (ARM)
4. RYSEVETS HLEB (BLR)



1. GADZHIEV GADZHI (RUS)
2. ELSAWY ALY (EGY)
3. NEMATI MORTEZA (IRI)
3. SHARAFUTDINOV ERNEST (RUS)
5. ASKARIPOUR MOHAMMADERFAN (IRI)
5. HOVHANNISYAN ROBERT (ARM)
7. MUKHAT AIDOS (KAZ)
7. BATYRGALI ABILMANSUR (KAZ)

Referees:			

Senior Kumite Male -75kg - Round Robin (each against each)

MOSCOW-KARATE-UNIVERSE INTERNATIONAL 2024, Moscow, RUS

Tatami

Pool
2/8

1	NURLANOV N. (KGZ) #169 / 08.11	0	MUKHAT A. (KAZ)
2	MUKHAT A. (KAZ)	2	
3	CHYMBUR R. (BLR) #170 / 08.11	2	KHORSIK E. (RUS)
4	KHORSIK E. (RUS)	3	
5	NURLANOV N. (KGZ) #173 / 08.11	3	NURLANOV N. (KGZ)
6	CHYMBUR R. (BLR)	0	
7	KHORSIK E. (RUS) #174 / 08.11	0	MUKHAT A. (KAZ)
8	MUKHAT A. (KAZ)	2	
9	NURLANOV N. (KGZ) #177 / 08.11	4	NURLANOV N. (KGZ)
10	KHORSIK E. (RUS)	3	
11	MUKHAT A. (KAZ) #178 / 08.11	4	MUKHAT A. (KAZ)
12	CHYMBUR R. (BLR)	2	

1. MUKHAT AIDOS (KAZ)
2. NURLANOV NAZIM (KGZ)
3. KHORSIK EGOR (RUS)
4. CHYMBUR RAMAN (BLR)



1. GADZHIEV GADZHI (RUS)
2. ELSAWY ALY (EGY)
3. NEMATI MORTEZA (IRI)
3. SHARAFUTDINOV ERNEST (RUS)
5. ASKARIPOUR MOHAMMADERFAN (IRI)
5. HOVHANNISYAN ROBERT (ARM)
7. MUKHAT AIDOS (KAZ)
7. BATYRGALI ABILMANSUR (KAZ)

Referees:			

Senior Kumite Male -75kg - Round Robin (each against each)

MOSCOW-KARATE-UNIVERSE INTERNATIONAL 2024, Moscow, RUS

Tatami

Pool
3/8

1	NEMATI M. (IRI)	
	#181 / 08.11	3 NEMATI M. (IRI)
2	MAKHMUDOV O. (RUS)	2
3	MUKHAMMADIYEV K. (UZB)	
	#182 / 08.11	5 MUKHAMMADIYEV K. (UZB)
4	AKHMEDOV R. (RUS)	2
5	NEMATI M. (IRI)	
	#185 / 08.11	3 NEMATI M. (IRI)
6	MUKHAMMADIYEV K. (UZB)	2
7	AKHMEDOV R. (RUS)	
	#186 / 08.11	8 AKHMEDOV R. (RUS)
8	MAKHMUDOV O. (RUS)	0
9	NEMATI M. (IRI)	
	#189 / 08.11	4 NEMATI M. (IRI)
10	AKHMEDOV R. (RUS)	0
11	MAKHMUDOV O. (RUS)	
	#190 / 08.11	1 MUKHAMMADIYEV K. (UZB)
12	MUKHAMMADIYEV K. (UZB)	4

1. NEMATI MORTEZA (IRI)
2. MUKHAMMADIYEV KUVONCHBEK (UZB)
3. AKHMEDOV RUSTAM (RUS)
4. MAKHMUDOV OLEG (RUS)



1. GADZHIEV GADZHI (RUS)
2. ELSAWY ALY (EGY)
3. NEMATI MORTEZA (IRI)
3. SHARAFUTDINOV ERNEST (RUS)
5. ASKARIPOUR MOHAMMADERFAN (IRI)
5. HOVHANNISYAN ROBERT (ARM)
7. MUKHAT AIDOS (KAZ)
7. BATYRGALI ABILMANSUR (KAZ)

Referees:			

Senior Kumite Male -75kg - Round Robin (each against each)

MOSCOW-KARATE-UNIVERSE INTERNATIONAL 2024, Moscow, RUS

Tatami

Pool
4/8

1	GANIYEV A. (KAZ)	#193 / 08.11	3	VOLOSOV U. (BLR)
2	VOLOSOV U. (BLR)		6	
3	OUSSAMA Z. (ALG)	#194 / 08.11	3	OUSSAMA Z. (ALG)
4	GRACHEV S. (RUS)		1	
5	GANIYEV A. (KAZ)	#196 / 08.11	0	OUSSAMA Z. (ALG)
6	OUSSAMA Z. (ALG)		2	
7	GRACHEV S. (RUS)	#197 / 08.11	2	GRACHEV S. (RUS)
8	VOLOSOV U. (BLR)		0	
9	GANIYEV A. (KAZ)	#199 / 08.11	0	GRACHEV S. (RUS)
10	GRACHEV S. (RUS)		1	
11	VOLOSOV U. (BLR)	#200 / 08.11	1	OUSSAMA Z. (ALG)
12	OUSSAMA Z. (ALG)		3	

1. OUSSAMA ZAID (ALG)
2. GRACHEV SEMEN (RUS)
3. VOLOSOV ULADZISLAU (BLR)
4. GANIYEV ALIKHAN (KAZ)



1. GADZHIEV GADZHI (RUS)
2. ELSAWY ALY (EGY)
3. NEMATI MORTEZA (IRI)
3. SHARAFUTDINOV ERNEST (RUS)
5. ASKARIPOUR MOHAMMADERFAN (IRI)
5. HOVHANNISYAN ROBERT (ARM)
7. MUKHAT AIDOS (KAZ)
7. BATYRGALI ABILMANSUR (KAZ)

Referees:			

Senior Kumite Male -75kg - Round Robin (each against each)

MOSCOW-KARATE-UNIVERSE INTERNATIONAL 2024, Moscow, RUS

Tatami

Pool
5/8

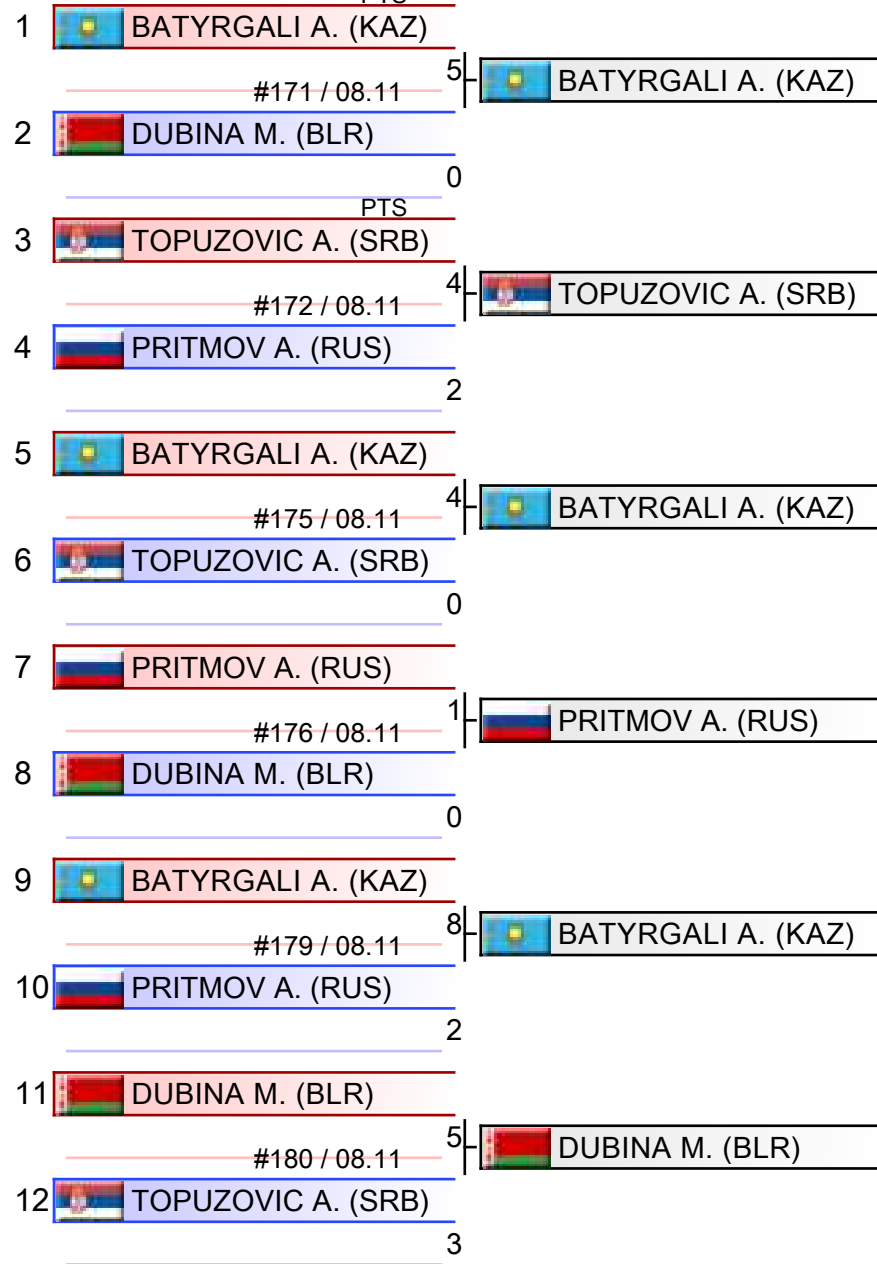

1. BATYRGALI ABILMANSUR (KAZ)
2. TOPUZOVIC ALEKSANDAR (SRB)
3. DUBINA MIKITA (BLR)
4. PRITMOV ALEXANDER (RUS)



1. GADZHIEV GADZHI (RUS)
2. ELSAWY ALY (EGY)
3. NEMATI MORTEZA (IRI)
3. SHARAFUTDINOV ERNEST (RUS)
5. ASKARIPOUR MOHAMMADERFAN (IRI)
5. HOVHANNISYAN ROBERT (ARM)
7. MUKHAT AIDOS (KAZ)
7. BATYRGALI ABILMANSUR (KAZ)

Referees:			

Senior Kumite Male -75kg - Round Robin (each against each)

MOSCOW-KARATE-UNIVERSE INTERNATIONAL 2024, Moscow, RUS

Tatami

Pool
6/8

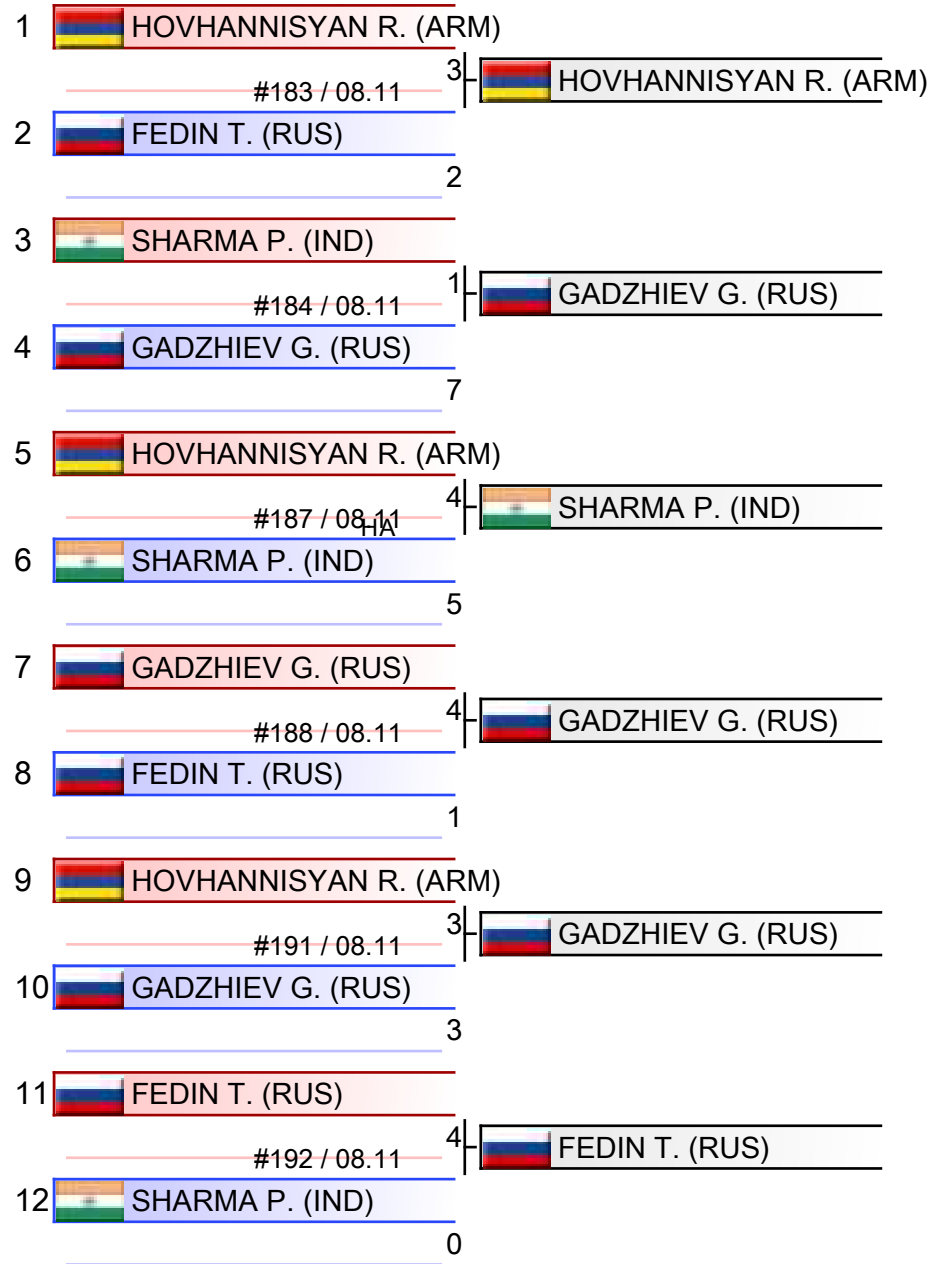

1. GADZHIEV GADZHI (RUS)
2. HOVHANNISYAN ROBERT (ARM)
3. FEDIN TIMOFEY (RUS)
4. SHARMA PRANAY (IND)



1. GADZHIEV GADZHI (RUS)
2. ELSAWY ALY (EGY)
3. NEMATI MORTEZA (IRI)
3. SHARAFUTDINOV ERNEST (RUS)
5. ASKARIPOUR MOHAMMADERFAN (IRI)
5. HOVHANNISYAN ROBERT (ARM)
7. MUKHAT AIDOS (KAZ)
7. BATYRGALI ABILMANSUR (KAZ)

Referees:			

Senior Kumite Male -75kg - Round Robin (each against each)

MOSCOW-KARATE-UNIVERSE INTERNATIONAL 2024, Moscow, RUS

Tatami

Pool
7/8

1	KARYAN H. (ARM)	
	#159 / 08.11	4
2	GRETSKIY D. (RUS)	
		5
3	KRYVIANKOU D. (BLR)	
	#160 / 08.11	2
4	AZHIKANOV N. (KAZ)	
		5
5	KARYAN H. (ARM)	
	#163 / 08.11	1
6	KRYVIANKOU D. (BLR)	
		5
7	AZHIKANOV N. (KAZ)	
	#164 / 08.11	5
8	GRETSKIY D. (RUS)	
		7
9	KARYAN H. (ARM)	
	#167 / 08.11	1
10	AZHIKANOV N. (KAZ)	
		2
11	GRETSKIY D. (RUS)	
	#168 / 08.11	9
12	KRYVIANKOU D. (BLR)	
		10

1. GRETSKIY DANIIL (RUS)
2. KRYVIANKOU DANIIL (BLR)
3. AZHIKANOV NURKANAT (KAZ)
4. KARYAN HAYK (ARM)



1. GADZHIEV GADZHI (RUS)
2. ELSAWY ALY (EGY)
3. NEMATI MORTEZA (IRI)
3. SHARAFUTDINOV ERNEST (RUS)
5. ASKARIPOUR MOHAMMADERFAN (IRI)
5. HOVHANNISYAN ROBERT (ARM)
7. MUKHAT AIDOS (KAZ)
7. BATYRGALI ABILMANSUR (KAZ)

Referees:			

Senior Kumite Male -75kg - Round Robin (each against each)

MOSCOW-KARATE-UNIVERSE INTERNATIONAL 2024, Moscow, RUS

Tatami

Pool
8/8

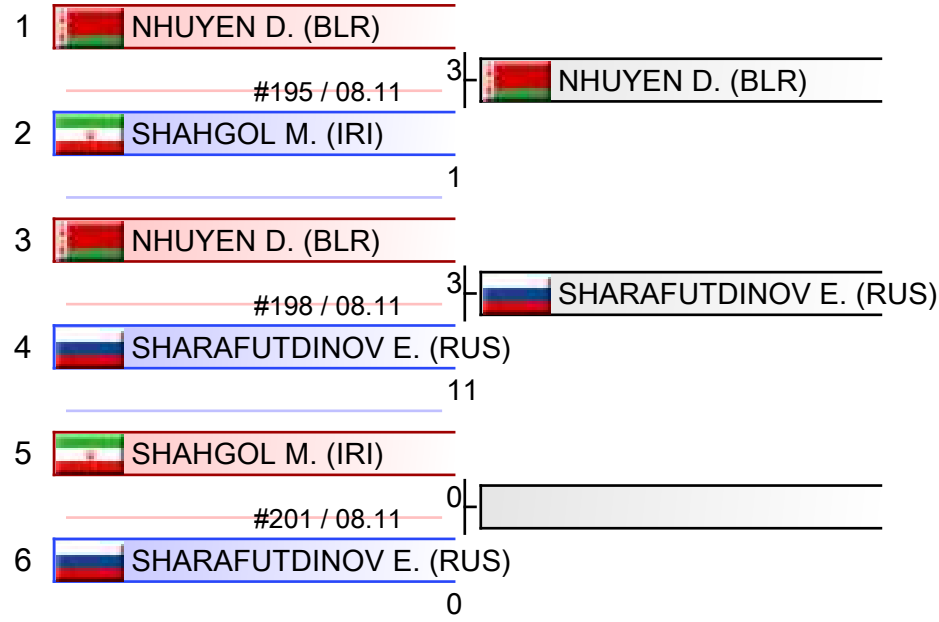

1. SHARAFUTDINOV ERNEST (RUS)
2. NHUYEN DEVID (BLR)
3. SHAHGOL MAHDI (IRI)



1. GADZHIEV GADZHI (RUS)
2. ELSAWY ALY (EGY)
3. NEMATI MORTEZA (IRI)
3. SHARAFUTDINOV ERNEST (RUS)
5. ASKARIPOUR MOHAMMADERFAN (IRI)
5. HOVHANNISYAN ROBERT (ARM)
7. MUKHAT AIDOS (KAZ)
7. BATYRGALI ABILMANSUR (KAZ)

Referees:			

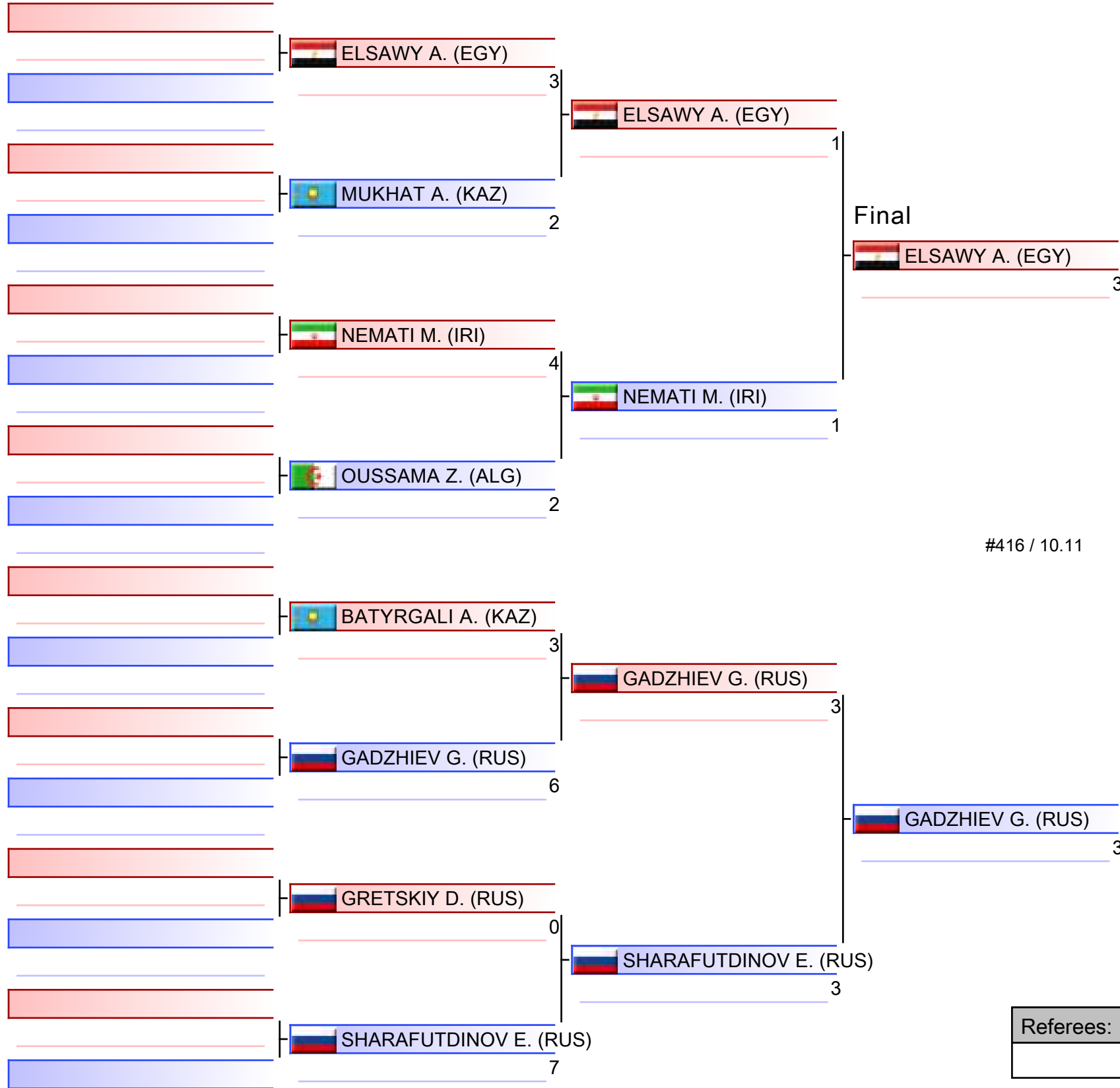

1. GADZHIEV GADZHI (RUS)
2. ELSAWY ALY (EGY)
3. NEMATI MORTEZA (IRI)
3. SHARAFUTDINOV ERNEST (RUS)
5. ASKARIPOUR MOHAMMADERFAN (IRI)
5. HOVHANNISYAN ROBERT (ARM)
7. MUKHAT AIDOS (KAZ)
7. BATYRGALI ABILMANSUR (KAZ)

Referees:			

Senior Kumite Male -75kg

MOSCOW-KARATE-UNIVERSE INTERNATIONAL 2024

2024-11-08

Tatami
2 20:20

Pool
1,2,3,4,5,6,7,8

(c)sportdata GmbH & Co KG 2000-2024 (2024-11-10 18:21) v 10.2.0 build 1 (2024-07-20 11:09 CET) License: Online_Event_ID-8474_MOSCOWKARATEUNIVERSEINTERNATIONAL2024 (expire 2024-11-24)

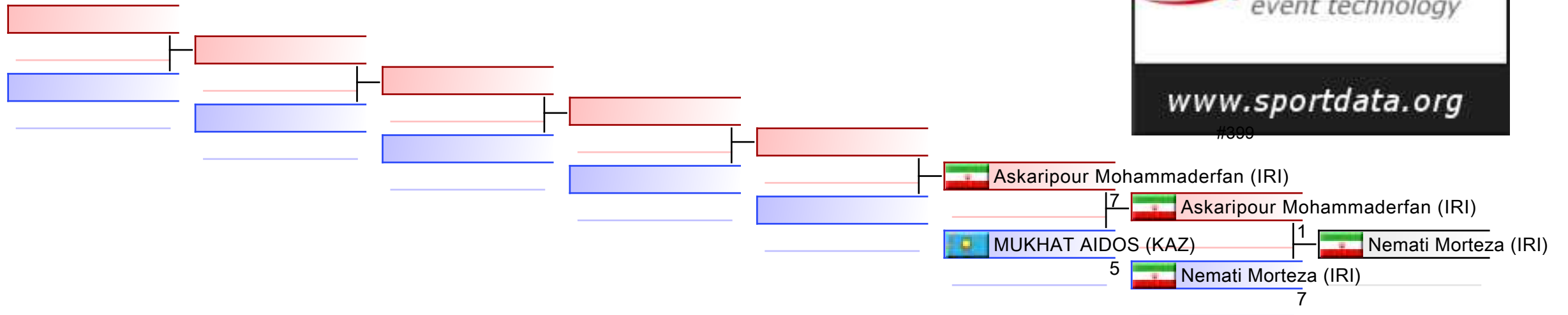

REPECHAGE: (1,2,3,4,5,6,7,8)

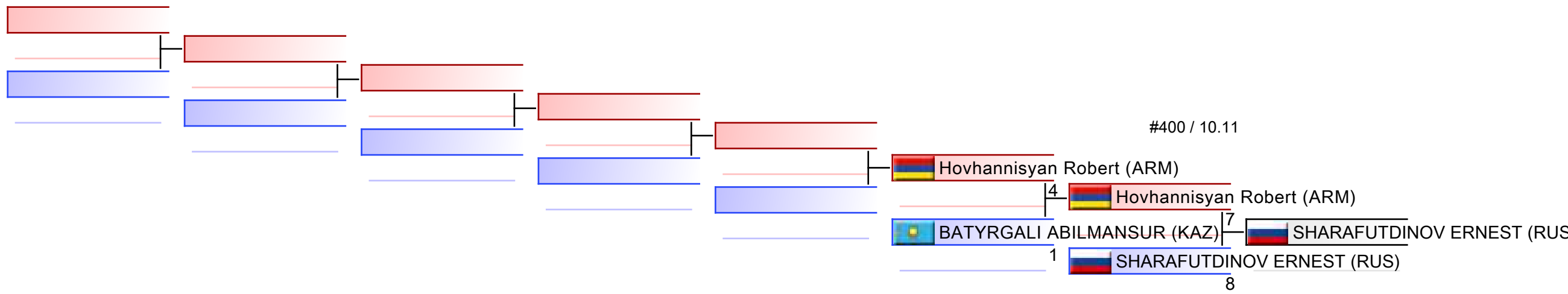

Referees:							
-----------	--	--	--	--	--	--	--



MOSCOW-KARATE-UNIVERSE
INTERNATIONAL 2024 - 2024-11-08



Official Results

Senior Kumite Male -75kg			
1	GADZHIEV GADZHI		RUS - RUSSIAN FEDERATION
2	ELSAWY ALY		EGY - EGYPT
3	NEMATI MORTEZA		IRI - ISLAMIC REPUBLIC OF IRAN
3	SHARAFUTDINOV ERNEST		RUS - RUSSIAN FEDERATION
5	ASKARIPOUR MOHAMMADERFAN		IRI - ISLAMIC REPUBLIC OF IRAN
5	HOVHANNISYAN ROBERT		ARM - ARMENIA
7	MUKHAT AIDOS		KAZ - KAZAKHSTAN
7	BATYRGALI ABILMANSUR		KAZ - KAZAKHSTAN

SENIOR KUMITE MALE -84KG



MOSCOW-KARATE-UNIVERSE INTERNATIONAL ..
ENTRIES BY WEIGHT CATEGORY



Senior Kumite Male -84kg
As of 10 NOV 2024

NOC Code	Gender	Name	Seeding
ALG	M	MOHAMED EL AMINE SELLOUM	
ARM	M	Nersisyan Gor	15
AZE	M	hasanov turgut	
BLR	M	Kiryievich Mikita	
BLR	M	Sachkouski Hleb	
BLR	M	Sakhvon Mikita	
EGY	M	BADAWY YOUSSEF	8
INA	M	YUSTISIO HUGGIES	
IRI	M	Asgari ghoncheh Bahman	6
IRI	M	HEYDARIYASAVOLI ALIREZA	
IRI	M	KHODABAKHSHI MAHDI	11
KAZ	M	TARNAKIN NIKITA	
KAZ	M	Ul'bek Dias	
KAZ	M	YULDASHEV DANIYAR	12
KGZ	M	Iliasov Mukhammed	
RUS	M	ANTONYAN ARUTYUN	7
RUS	M	Bobrov Egor	4
RUS	M	Gabeliia Zurab	
RUS	M	GASPARYAN EDUARD	1
RUS	M	Guglevatyi Dmitriy	
RUS	M	Ivanian Enriko	
RUS	M	Kireev Egor	
RUS	M	Kurmanov Konshau-Biy	2
RUS	M	PETRAKOV DANIIL	3
RUS	M	Sisin Alexandr	
SRB	M	BREZANCIC VLADIMIR	
SUI	M	Gindre Maxime	
UAE	M	KHUDHAIR ZAYED	
UZB	M	NAMOZOV SHUKHRATJON	
VEN	M	Martinez Edgar	

Senior Kumite Male -84kg - Round Robin (each against each)

MOSCOW-KARATE-UNIVERSE INTERNATIONAL 2024, Moscow, RUS

Tatami

Pool
1/8

1	IVANIAN E. (RUS)	
	#262 / 09.11	6 IVANIAN E. (RUS)
2	ILIASOV M. (KGZ)	5
3	MARTÍNEZ E. (VEN)	
	#263 / 09.11	3 ASGARI GHONCHEH B. (IRI)
4	ASGARI GHONCHEH B. (IRI)	5
5	IVANIAN E. (RUS)	
	#266 / 09.11	1 MARTÍNEZ E. (VEN)
6	MARTÍNEZ E. (VEN)	2
7	ASGARI GHONCHEH B. (IRI)	
	#267 / 09.11	9 ASGARI GHONCHEH B. (IRI)
8	ILIASOV M. (KGZ)	0
9	IVANIAN E. (RUS)	
	#270 / 09.11	0 ASGARI GHONCHEH B. (IRI)
10	ASGARI GHONCHEH B. (IRI)	8
11	ILIASOV M. (KGZ)	
	#271 / 09.11	2 MARTÍNEZ E. (VEN)
12	MARTÍNEZ E. (VEN)	5

1. ASGARI GHONCHEH BAHMAN (IRI)
2. MARTÍNEZ EDGAR (VEN)
3. IVANIAN ENRIKO (RUS)
4. ILIASOV MUKHAMMED (KGZ)



1. TARNAKIN NIKITA (KAZ)
2. ANTONYAN ARUTYUN (RUS)
3. YULDASHEV DANIYAR (KAZ)
3. BADAWY YOUSSEF (EGY)
5. GUGLEVATYI DMITRIY (RUS)
5. KHODABAKHSHI MAHDI (IRI)
7. HEYDARIYASAVOLI ALIREZA (IRI)
7. BREZANCIC VLADIMIR (SRB)

Referees:			

Senior Kumite Male -84kg - Round Robin (each against each)

MOSCOW-KARATE-UNIVERSE INTERNATIONAL 2024, Moscow, RUS

Tatami

Pool
2/8

1	SACHKOUSKI H. (BLR)	#274 / 09.11	3	YULDASHEV D. (KAZ)
2	YULDASHEV D. (KAZ)		7	
3	MOHAMED EL AMINE S. (ALG)	#275 / 09.11	2	PETRAKOV D. (RUS)
4	PETRAKOV D. (RUS)		5	
5	SACHKOUSKI H. (BLR)	#278 / 09.11	7	SACHKOUSKI H. (BLR)
6	MOHAMED EL AMINE S. (ALG)		2	
7	PETRAKOV D. (RUS)	#279 / 09.11	1	YULDASHEV D. (KAZ)
8	YULDASHEV D. (KAZ)		5	
9	SACHKOUSKI H. (BLR)	#282 / 09.11	7	SACHKOUSKI H. (BLR)
10	PETRAKOV D. (RUS)		0	
11	YULDASHEV D. (KAZ)	#283 / 09.11	3	YULDASHEV D. (KAZ)
12	MOHAMED EL AMINE S. (ALG)		1	

1. YULDASHEV DANIYAR (KAZ)
2. SACHKOUSKI HLEB (BLR)
3. PETRAKOV DANIIL (RUS)
4. MOHAMED EL AMINE SELLOUM (ALG)



1. TARNAKIN NIKITA (KAZ)
2. ANTONYAN ARUTYUN (RUS)
3. YULDASHEV DANIYAR (KAZ)
3. BADAWY YOUSSEF (EGY)
5. GUGLEVATYI DMITRIY (RUS)
5. KHODABAKHSHI MAHDI (IRI)
7. HEYDARIYASAVOLI ALIREZA (IRI)
7. BREZANCIC VLADIMIR (SRB)

Referees:			

Senior Kumite Male -84kg - Round Robin (each against each)

MOSCOW-KARATE-UNIVERSE INTERNATIONAL 2024, Moscow, RUS

Tatami

Pool
3/8

1	 HEYDARIYASAVOLI A. (IRI)	
	#286 / 09.11	3
2	 NAMOZOV S. (UZB)	
	PTS	2
3	 KIRYIEVICH M. (BLR)	
	#287 / 09.11	3
4	 ANTONYAN A. (RUS)	
	PTS	1
5	 HEYDARIYASAVOLI A. (IRI)	
	#289 / 09.11	3
6	 KIRYIEVICH M. (BLR)	
	PTS	3
7	 ANTONYAN A. (RUS)	
	#290 / 09.11	4
8	 NAMOZOV S. (UZB)	
	PTS	4
9	 HEYDARIYASAVOLI A. (IRI)	
	#292 / 09.11	1
10	 ANTONYAN A. (RUS)	
	PTS	5
11	 NAMOZOV S. (UZB)	
	#293 / 09.11	4
12	 KIRYIEVICH M. (BLR)	
	PTS	4

1. ANTONYAN ARUTYUN (RUS)
2. HEYDARIYASAVOLI ALIREZA (IRI)
3. KIRYIEVICH MIKITA (BLR)
4. NAMOZOV SHUKHRATJON (UZB)



1. TARNAKIN NIKITA (KAZ)
2. ANTONYAN ARUTYUN (RUS)
3. YULDASHEV DANIYAR (KAZ)
3. BADAWY YOUSSEF (EGY)
5. GUGLEVATYI DMITRIY (RUS)
5. KHODABAKHSHI MAHDI (IRI)
7. HEYDARIYASAVOLI ALIREZA (IRI)
7. BREZANCIC VLADIMIR (SRB)

Referees:			

Senior Kumite Male -84kg - Round Robin (each against each)

MOSCOW-KARATE-UNIVERSE INTERNATIONAL 2024, Moscow, RUS

Tatami

Pool
4/8

1	GINDRE M. (SUI)	0	GUGLEVATYI D. (RUS)
	#297 / 09.11		
2	GUGLEVATYI D. (RUS)	3	
3	GINDRE M. (SUI)	1	KURMANOV K. (RUS)
	#300 / 09.11		
4	KURMANOV K. (RUS)	4	
5	GUGLEVATYI D. (RUS)	4	GUGLEVATYI D. (RUS)
	#303 / 09.11		
6	KURMANOV K. (RUS)	1	

1. GUGLEVATYI DMITRIY (RUS)
2. KURMANOV KONSHAU-BIY (RUS)
3. GINDRE MAXIME (SUI)



1. TARNAKIN NIKITA (KAZ)
2. ANTONYAN ARUTYUN (RUS)
3. YULDASHEV DANIYAR (KAZ)
3. BADAWY YOUSSEF (EGY)
5. GUGLEVATYI DMITRIY (RUS)
5. KHODABAKHSHI MAHDI (IRI)
7. HEYDARIYASAVOLI ALIREZA (IRI)
7. BREZANCIC VLADIMIR (SRB)

Referees:			

Senior Kumite Male -84kg - Round Robin (each against each)

MOSCOW-KARATE-UNIVERSE INTERNATIONAL 2024, Moscow, RUS

Tatami

Pool
5/8

1	KIREEV E. (RUS)	0	NERSISYAN G. (ARM)
	#264 / 09.11		
2	NERSISYAN G. (ARM)	8	
3	BREZANCIC V. (SRB)	1	TARNAKIN N. (KAZ)
	#265 / 09.11		
4	TARNAKIN N. (KAZ)	9	
5	KIREEV E. (RUS)	2	BREZANCIC V. (SRB)
	#268 / 09.11		
6	BREZANCIC V. (SRB)	2	
7	TARNAKIN N. (KAZ)	1	TARNAKIN N. (KAZ)
	#269 / 09.11		
8	NERSISYAN G. (ARM)	13	
9	KIREEV E. (RUS)	0	TARNAKIN N. (KAZ)
	#272 / 09.11		
10	TARNAKIN N. (KAZ)	7	
11	NERSISYAN G. (ARM)	1	BREZANCIC V. (SRB)
	#273 / 09.11		
12	BREZANCIC V. (SRB)	10	

1. TARNAKIN NIKITA (KAZ)
2. BREZANCIC VLADIMIR (SRB)
3. NERSISYAN GOR (ARM)
4. KIREEV EGOR (RUS)



1. TARNAKIN NIKITA (KAZ)
2. ANTONYAN ARUTYUN (RUS)
3. YULDASHEV DANIYAR (KAZ)
3. BADAWY YOUSSEF (EGY)
5. GUGLEVATYI DMITRIY (RUS)
5. KHODABAKHSHI MAHDI (IRI)
7. HEYDARIYASAVOLI ALIREZA (IRI)
7. BREZANCIC VLADIMIR (SRB)

Referees:			

Senior Kumite Male -84kg - Round Robin (each against each)

MOSCOW-KARATE-UNIVERSE INTERNATIONAL 2024, Moscow, RUS

Tatami

Pool
6/8

1	HASANOV T. (AZE)	#276 / 09.11	2	KHODABAKHSHI M. (IRI)
2	KHODABAKHSHI M. (IRI)		2	
3	YUSTISIO H. (INA)	#277 / 09.11	9	YUSTISIO H. (INA)
4	BOBROV E. (RUS)		9	
5	HASANOV T. (AZE)	#280 / 09.11	7	HASANOV T. (AZE)
6	YUSTISIO H. (INA)		4	
7	BOBROV E. (RUS)	#281 / 09.11	0	KHODABAKHSHI M. (IRI)
8	KHODABAKHSHI M. (IRI)		5	
9	HASANOV T. (AZE)	#284 / 09.11	5	HASANOV T. (AZE)
10	BOBROV E. (RUS)		4	
11	KHODABAKHSHI M. (IRI)	#285 / 09.11	5	KHODABAKHSHI M. (IRI)
12	YUSTISIO H. (INA)		1	

1. KHODABAKHSHI MAHDI (IRI)
2. HASANOV TURGUT (AZE)
3. YUSTISIO HUGGIES (INA)
4. BOBROV EGOR (RUS)



1. TARNAKIN NIKITA (KAZ)
2. ANTONYAN ARUTYUN (RUS)
3. YULDASHEV DANIYAR (KAZ)
3. BADAWY YOUSSEF (EGY)
5. GUGLEVATYI DMITRIY (RUS)
5. KHODABAKHSHI MAHDI (IRI)
7. HEYDARIYASAVOLI ALIREZA (IRI)
7. BREZANCIC VLADIMIR (SRB)

Referees:			

Senior Kumite Male -84kg - Round Robin (each against each)

MOSCOW-KARATE-UNIVERSE INTERNATIONAL 2024, Moscow, RUS

Tatami

Pool
7/8

1	SISIN A. (RUS)	
	#295 / 09.11	6 SAKHVON M. (BLR)
2	SAKHVON M. (BLR)	7
3	KHUDHAIR Z. (UAE)	0 BADAWEY Y. (EGY)
	#296 / 09.11	
4	BADAWEY Y. (EGY)	3
5	SISIN A. (RUS)	1 SISIN A. (RUS)
	#298 / 09.11	
6	KHUDHAIR Z. (UAE)	1
7	BADAWEY Y. (EGY)	1 BADAWEY Y. (EGY)
	#299 / 09.11	
8	SAKHVON M. (BLR)	4
9	SISIN A. (RUS)	0
	#301 / 09.11	
10	BADAWEY Y. (EGY)	0
11	SAKHVON M. (BLR)	0
	#302 / 09.11	
12	KHUDHAIR Z. (UAE)	0

1. BADAWEY YOUSSEF (EGY)
2. SAKHVON MIKITA (BLR)
3. SISIN ALEXANDR (RUS)
4. KHUDHAIR ZAYED (UAE)



1. TARNAKIN NIKITA (KAZ)
2. ANTONYAN ARUTYUN (RUS)
3. YULDASHEV DANIYAR (KAZ)
3. BADAWEY YOUSSEF (EGY)
5. GUGLEVATYI DMITRIY (RUS)
5. KHODABAKHSHI MAHDI (IRI)
7. HEYDARIYASAVOLI ALIREZA (IRI)
7. BREZANCIC VLADIMIR (SRB)

Referees:			

Senior Kumite Male -84kg - Round Robin (each against each)

MOSCOW-KARATE-UNIVERSE INTERNATIONAL 2024, Moscow, RUS

Tatami

Pool
8/8

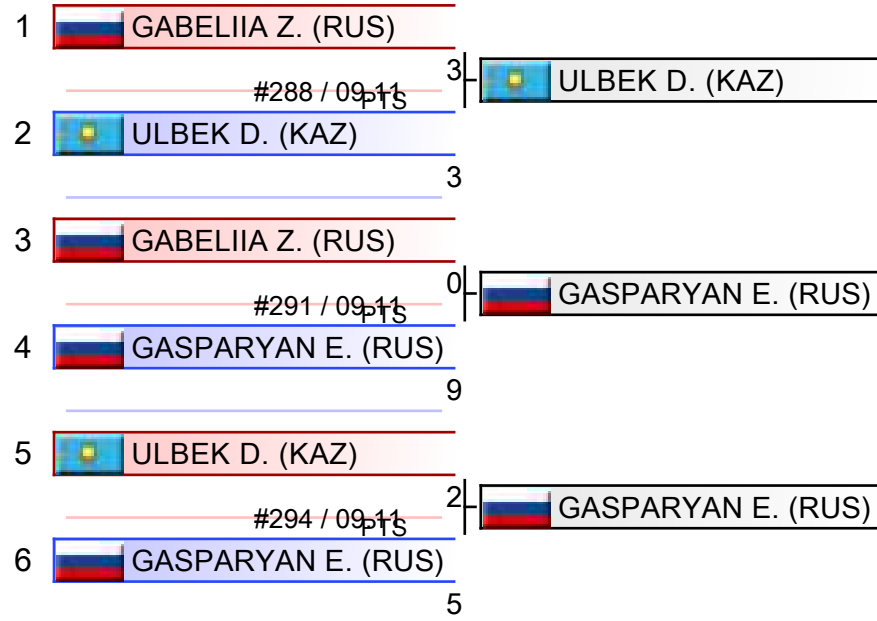

1. GASPARYAN EDUARD (RUS)
2. ULBEK DIAS (KAZ)
3. GABELIIA ZURAB (RUS)



1. TARNAKIN NIKITA (KAZ)
2. ANTONYAN ARUTYUN (RUS)
3. YULDASHEV DANIYAR (KAZ)
3. BADAWY YOUSSEF (EGY)
5. GUGLEVATYI DMITRIY (RUS)
5. KHODABAKHSHI MAHDI (IRI)
7. HEYDARIYASAVOLI ALIREZA (IRI)
7. BREZANCIC VLADIMIR (SRB)

Referees:			

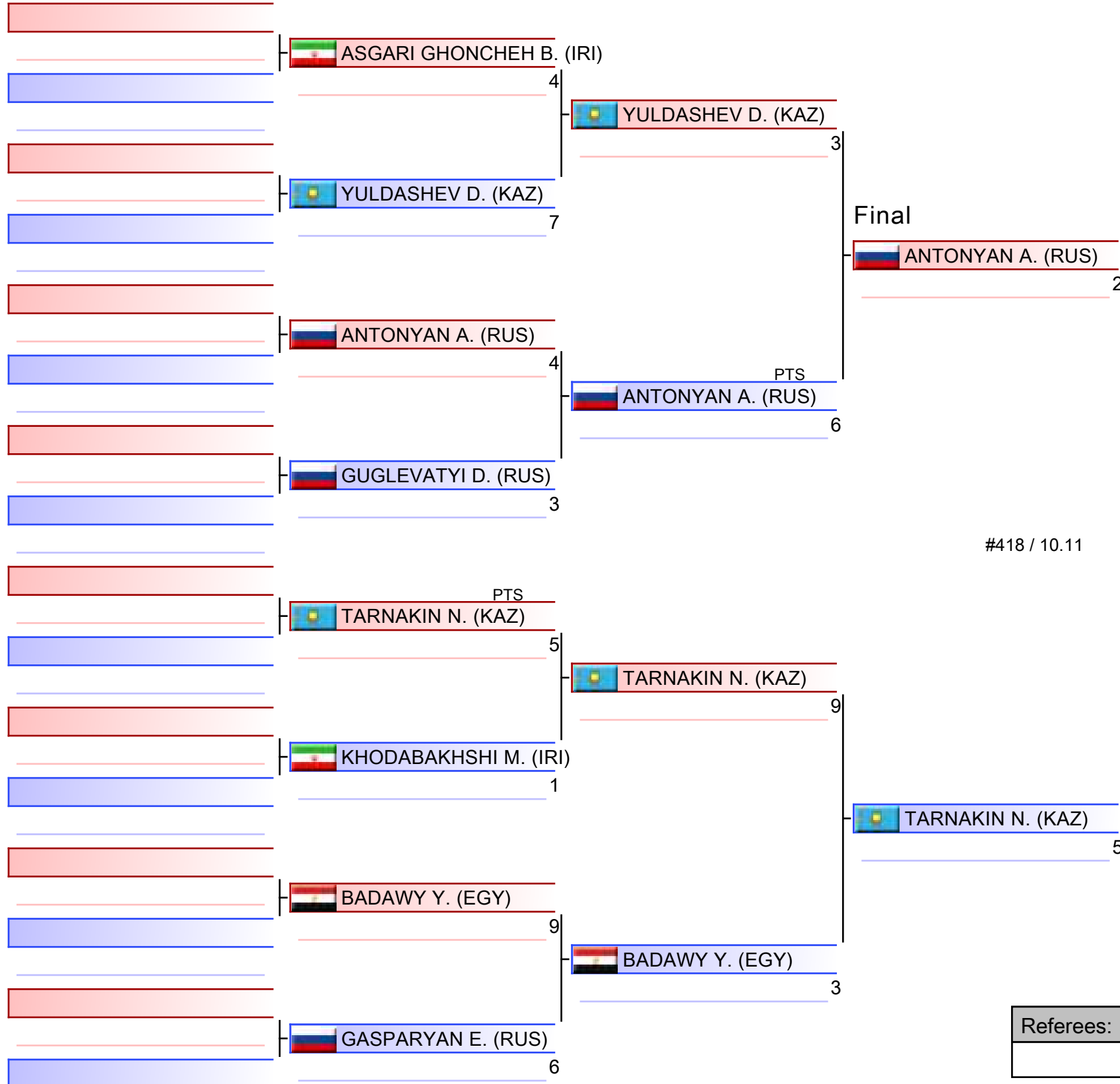

#418 / 10.11

1. TARNAKIN NIKITA (KAZ)
2. ANTONYAN ARUTYUN (RUS)
3. YULDASHEV DANIYAR (KAZ)
3. BADAWY YOUSSEF (EGY)
5. GUGLEVATYI DMITRIY (RUS)
5. KHODABAKHSHI MAHDI (IRI)
7. HEYDARIYASAVOLI ALIREZA (IRI)
7. BREZANCIC VLADIMIR (SRB)

Referees:			

Senior Kumite Male -84kg

MOSCOW-KARATE-UNIVERSE INTERNATIONAL 2024

2024-11-09

Tatami
3 19:30

Pool
1,2,3,4,5,6,7,8

(c)sportdata GmbH & Co KG 2000-2024 (2024-11-10 18:21) v 10.2.0 build 1 (2024-07-20 11:09 CET) License: Online_Event_ID-8474_MOSCOWKARATEUNIVERSEINTERNATIONAL2024 (expire 2024-11-24)

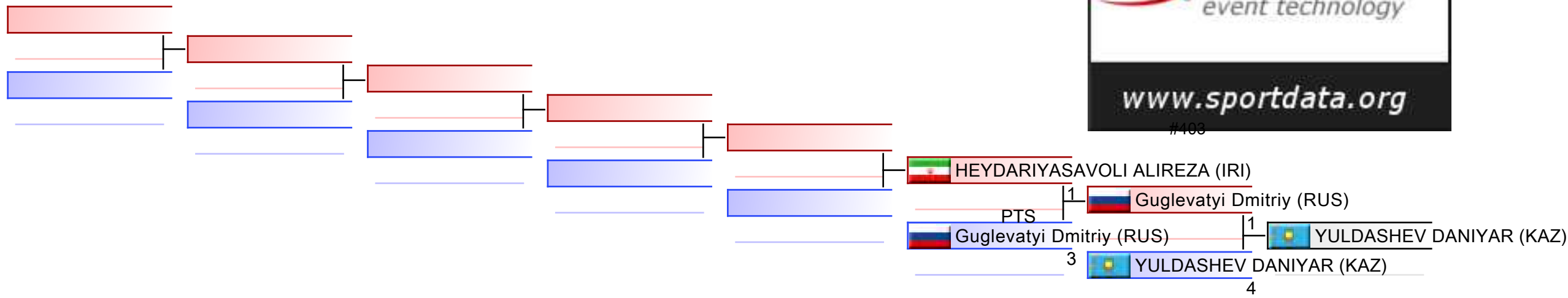

REPECHAGE: (1,2,3,4,5,6,7,8)

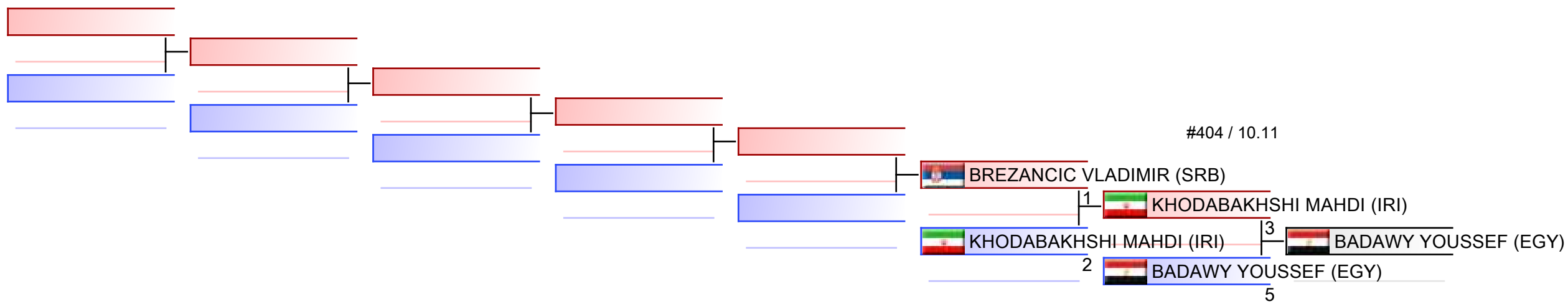

Referees:							
-----------	--	--	--	--	--	--	--



MOSCOW-KARATE-UNIVERSE
INTERNATIONAL 2024 - 2024-11-08



Official Results

Senior Kumite Male -84kg			
1	TARNAKIN NIKITA		KAZ - KAZAKHSTAN
2	ANTONYAN ARUTYUN		RUS - RUSSIAN FEDERATION
3	YULDASHEV DANIYAR		KAZ - KAZAKHSTAN
3	BADAWY YOUSSEF		EGY - EGYPT
5	GUGLEVATYI DMITRIY		RUS - RUSSIAN FEDERATION
5	KHODABAKHSHI MAHDI		IRI - ISLAMIC REPUBLIC OF IRAN
7	HEYDARIYASAVOLI ALIREZA		IRI - ISLAMIC REPUBLIC OF IRAN
7	BREZANCIC VLADIMIR		SRB - SERBIA

SENIOR KATA FEMALE



MOSCOW-KARATE-UNIVERSE INTERNATIONAL ..
ENTRIES BY WEIGHT CATEGORY



Senior kata female
As of 10 NOV 2024

NOC Code	Gender	Name	Seeding
AZE	F	neda rezai	
BLR	F	Baravik Veranika	2
BLR	F	Bucha Uliya	
BLR	F	Fiadosava Katsiaryna	
BLR	F	Hrachova Palina	
BLR	F	Hryneuskaya Alisa	
BLR	F	Kolb Alesia	
BLR	F	Mukha Palina	
BLR	F	Rolia Milena	
BLR	F	Rudzenchanka Viktoryia	4
CHI	F	De La Paz Carol	3
EGY	F	Nourhan Sewidan	
IND	F	SINGHI MESOM	5
RUS	F	ARKHIPOVA SVETLANA	
RUS	F	BUMAGINA KIRA	
RUS	F	FEDOROVA EKATERINA	
RUS	F	GORYACHEVA EKATERINA	9
RUS	F	GUSEVA POLINA	
RUS	F	Kokareva Kseniya	
RUS	F	KOTLYAROVA POLINA	12
RUS	F	LENNIK ALEKSANDRA	14
RUS	F	MIROSHNICHENKO ANNA	
RUS	F	NOVICHIKHINA ELENA	15
RUS	F	Perminova Yulianna	
RUS	F	Shcherbina Anna	16
RUS	F	Tarasova Angelina	
RUS	F	TULYAKOVA DARYA	11
RUS	F	VARLAMOVA EKATERINA	13
RUS	F	ZOTOVA MARIYA	10
UZB	F	TURAKULOVA DURDONA	1

















Senior kata female - Round Robin (each against each)

MOSCOW-KARATE-UNIVERSE INTERNATIONAL 2024, Moscow, RUS

Tatami

Pool

1/8

1	 HRYNEUSKAYA A. (BLR)	047 Kururunfa	2090	 SHCHERBINA A. (RUS)
2	 SHCHERBINA A. (RUS)	061 Nipaipo	2230	
3	 NEDA R. (AZE)	001 Anan	2220	 NEDA R. (AZE)
4	 FEDOROVA E. (RUS)	047 Kururunfa	2140	
5	 HRYNEUSKAYA A. (BLR)	097 Tomari Bassai	2090	 NEDA R. (AZE)
6	 NEDA R. (AZE)	067 Paiku	2200	
7	 FEDOROVA E. (RUS)	064 Ohan Dai	2170	 SHCHERBINA A. (RUS)
8	 SHCHERBINA A. (RUS)	001 Anan	2260	
9	 HRYNEUSKAYA A. (BLR)	068 Papuren	2080	 FEDOROVA E. (RUS)
10	 FEDOROVA E. (RUS)	068 Papuren	2170	
11	 SHCHERBINA A. (RUS)	097 Tomari Bassai	2260	 SHCHERBINA A. (RUS)
12	 NEDA R. (AZE)	092 Suparinpei	2190	

1. SHCHERBINA ANNA (RUS)
2. NEDA REZAI (AZE)
3. FEDOROVA EKATERINA (RUS)
4. HRYNEUSKAYA ALISA (BLR)



1. SHCHERBINA ANNA (RUS)
2. TURAKULOVA DURDONA (UZB)
3. BARAVIK VERANIKA (BLR)
3. SINGHI MESOM (IND)
5. NEDA REZAI (AZE)
5. ROLIA MILENA (BLR)
7. KOTLYAROVA POLINA (RUS)
7. VARLAMOVA EKATERINA (RUS)

Referees:			









Senior kata female - Round Robin (each against each)

MOSCOW-KARATE-UNIVERSE INTERNATIONAL 2024, Moscow, RUS

Tatami

Pool

2/8

1	 BUCHA U. (BLR)	002 Anan Dai	2180	 KOTLYAROVA P. (RUS)
2	 KOTLYAROVA P. (RUS)	030 Heiku	2220	
3	 PERMINOVA Y. (RUS)	068 Papuren	2210	 PERMINOVA Y. (RUS)
4	 DE LA PAZ C. (CHI)	063 Ohan	2120	
5	 BUCHA U. (BLR)	068 Papuren	2190	 PERMINOVA Y. (RUS)
6	 PERMINOVA Y. (RUS)	002 Anan Dai	2290	
7	 DE LA PAZ C. (CHI)	068 Papuren	2180	 KOTLYAROVA P. (RUS)
8	 KOTLYAROVA P. (RUS)	097 Tomari Bassai	2300	
9	 BUCHA U. (BLR)	064 Ohan Dai	2180	 DE LA PAZ C. (CHI)
10	 DE LA PAZ C. (CHI)	092 Suparinpei	2210	
11	 KOTLYAROVA P. (RUS)	001 Anan	2330	 KOTLYAROVA P. (RUS)
12	 PERMINOVA Y. (RUS)	067 Paiku	2250	

1. KOTLYAROVA POLINA (RUS)
2. PERMINOVA YULIANNA (RUS)
3. DE LA PAZ CAROL (CHI)
4. BUCHA ULIYA (BLR)



1. SHCHERBINA ANNA (RUS)
2. TURAKULOVA DURDONA (UZB)
3. BARAVIK VERANIKA (BLR)
3. SINGHI MESOM (IND)
5. NEDA REZAI (AZE)
5. ROLIA MILENA (BLR)
7. KOTLYAROVA POLINA (RUS)
7. VARLAMOVA EKATERINA (RUS)

Referees:			

Senior kata female - Round Robin (each against each)

MOSCOW-KARATE-UNIVERSE INTERNATIONAL 2024, Moscow, RUS

Tatami

Pool
3/8

1	MUKHA P. (BLR) 021 Gojushiho Sho	2180	LENNIK A. (RUS)
2	LENNIK A. (RUS) 047 Kururunfa	2250	
3	ARKHIPOVA S. (RUS) 064 Ohan Dai	2180	NOURHAN S. (EGY)
4	NOURHAN S. (EGY) 092 Suparinpei	2260	
5	MUKHA P. (BLR) 020 Gojushiho Dai	2130	ARKHIPOVA S. (RUS)
6	ARKHIPOVA S. (RUS) 001 Anan	2160	
7	NOURHAN S. (EGY) 002 Anan Dai	2240	LENNIK A. (RUS)
8	LENNIK A. (RUS) 068 Papuren	2260	
9	MUKHA P. (BLR) 099 Unsu	2140	NOURHAN S. (EGY)
10	NOURHAN S. (EGY) 047 Kururunfa	2250	
11	LENNIK A. (RUS) 002 Anan Dai	2250	LENNIK A. (RUS)
12	ARKHIPOVA S. (RUS) 002 Anan Dai	2250	

1. LENNIK ALEKSANDRA (RUS)
2. NOURHAN SEWIDAN (EGY)
3. ARKHIPOVA SVETLANA (RUS)
4. MUKHA PALINA (BLR)



1. SHCHERBINA ANNA (RUS)
2. TURAKULOVA DURDONA (UZB)
3. BARAVIK VERANIKA (BLR)
3. SINGHI MESOM (IND)
5. NEDA REZAI (AZE)
5. ROLIA MILENA (BLR)
7. KOTLYAROVA POLINA (RUS)
7. VARLAMOVA EKATERINA (RUS)

Referees:			









Senior kata female - Round Robin (each against each)

MOSCOW-KARATE-UNIVERSE INTERNATIONAL 2024, Moscow, RUS

Tatami

Pool

4/8

1	 MIROSHNICHENKO A. (RUS)	2040	 ZOTOVA M. (RUS)
	064 Ohan Dai		
2	 ZOTOVA M. (RUS)	2080	
	066 Pachu		
3	 MIROSHNICHENKO A. (RUS)	1970	 BARAVIK V. (BLR)
	002 Anan Dai		
4	 BARAVIK V. (BLR)	2230	
	068 Papuren		
5	 ZOTOVA M. (RUS)	2180	 BARAVIK V. (BLR)
	030 Heiku		
6	 BARAVIK V. (BLR)	2280	
	064 Ohan Dai		

1. BARAVIK VERANIKA (BLR)
2. ZOTOVA MARIYA (RUS)
3. MIROSHNICHENKO ANNA (RUS)



1. SHCHERBINA ANNA (RUS)
2. TURAKULOVA DURDONA (UZB)
3. BARAVIK VERANIKA (BLR)
3. SINGHI MESOM (IND)
5. NEDA REZAI (AZE)
5. ROLIA MILENA (BLR)
7. KOTLYAROVA POLINA (RUS)
7. VARLAMOVA EKATERINA (RUS)

Referees:			



















Senior kata female - Round Robin (each against each)

MOSCOW-KARATE-UNIVERSE INTERNATIONAL 2024, Moscow, RUS

Tatami

Pool

5/8

1	 KOLB A. (BLR)	020 Gojushiho Dai	20	 NOVICHIKHINA E. (RUS)
2	 NOVICHIKHINA E. (RUS)	041 Kanku Sho	2140	
3	 TARASOVA A. (RUS)	061 Nipaipo	21	 SINGHI M. (IND)
4	 SINGHI M. (IND)	068 Papuren	2260	
5	 KOLB A. (BLR)	099 Unsu	2150	 TARASOVA A. (RUS)
6	 TARASOVA A. (RUS)	001 Anan	2180	
7	 SINGHI M. (IND)	092 Suparinpei	2180	 SINGHI M. (IND)
8	 NOVICHIKHINA E. (RUS)	021 Gojushiho Sho	2180	
9	 KOLB A. (BLR)	021 Gojushiho Sho	22	 SINGHI M. (IND)
10	 SINGHI M. (IND)	064 Ohan Dai	2260	
11	 NOVICHIKHINA E. (RUS)	020 Gojushiho Dai	22	 TARASOVA A. (RUS)
12	 TARASOVA A. (RUS)	068 Papuren	2250	



1. SINGHI MESOM (IND)
2. TARASOVA ANGELINA (САРАТОВСКАЯ ОБЛ.)
3. NOVICHIKHINA ELENA (МОСКОВСКАЯ ОБЛ.)
4. KOLB ALESIA (БЕЛАРУСЬ)

1. SHCHERBINA ANNA (RUS)
2. TURAKULOVA DURDONA (UZB)
3. BARAVIK VERANIKA (BLR)
3. SINGHI MESOM (IND)
5. NEDA REZAI (AZE)
5. ROLIA MILENA (BLR)
7. KOTLYAROVA POLINA (RUS)
7. VARLAMOVA EKATERINA (RUS)



















Referees:			

Senior kata female - Round Robin (each against each)

MOSCOW-KARATE-UNIVERSE INTERNATIONAL 2024, Moscow, RUS

Tatami

Pool
6/8

1	 FIADOSAVA K. (BLR)	047 Kururunfa	2240	 TULYAKOVA D. (RUS)
2	 TULYAKOVA D. (RUS)	047 Kururunfa	2290	
3	 GUSEVA P. (RUS)	047 Kururunfa	2280	 RUDZENCHANKA V. (BLR)
4	 RUDZENCHANKA V. (BLR)	068 Papuren	2360	
5	 FIADOSAVA K. (BLR)	068 Papuren	2260	 GUSEVA P. (RUS)
6	 GUSEVA P. (RUS)	001 Anan	2330	
7	 RUDZENCHANKA V. (BLR)	008 Chatanyara Kushanku	2330	 RUDZENCHANKA V. (BLR)
8	 TULYAKOVA D. (RUS)	068 Papuren	2280	
9	 FIADOSAVA K. (BLR)	008 Chatanyara Kushanku	2260	 RUDZENCHANKA V. (BLR)
10	 RUDZENCHANKA V. (BLR)	001 Anan	2370	
11	 TULYAKOVA D. (RUS)	030 Heiku	2320	 GUSEVA P. (RUS)
12	 GUSEVA P. (RUS)	068 Papuren	2380	



1. RUDZENCHANKA VIKTORYIA (BLR)
2. GUSEVA POLINA (RUS)
3. TULYAKOVA DARYA (RUS)
4. FIADOSAVA KATSIARYNA (BLR)

1. SHCHERBINA ANNA (RUS)
2. TURAKULOVA DURDONA (UZB)
3. BARAVIK VERANIKA (BLR)
3. SINGHI MESOM (IND)
5. NEDA REZAI (AZE)
5. ROLIA MILENA (BLR)
7. KOTLYAROVA POLINA (RUS)
7. VARLAMOVA EKATERINA (RUS)

Referees:			

Senior kata female - Round Robin (each against each)

MOSCOW-KARATE-UNIVERSE INTERNATIONAL 2024, Moscow, RUS

Tatami

Pool

7/8

1	HRACHOVA P. (BLR)	020 Gojushiho Dai	2230	VARLAMOVA E. (RUS)
2	VARLAMOVA E. (RUS)	099 Unsu	2270	
3	BUMAGINA K. (RUS)	030 Heiku	2160	KOKAREVA K. (RUS)
4	KOKAREVA K. (RUS)	020 Gojushiho Dai	2240	
5	HRACHOVA P. (BLR)	099 Unsu	2200	HRACHOVA P. (BLR)
6	BUMAGINA K. (RUS)	047 Kururunfa	2170	
7	KOKAREVA K. (RUS)	021 Gojushiho Sho	2220	VARLAMOVA E. (RUS)
8	VARLAMOVA E. (RUS)	021 Gojushiho Sho	2220	
9	HRACHOVA P. (BLR)	021 Gojushiho Sho	2230	KOKAREVA K. (RUS)
10	KOKAREVA K. (RUS)	099 Unsu	2250	
11	VARLAMOVA E. (RUS)	020 Gojushiho Dai	2260	VARLAMOVA E. (RUS)
12	BUMAGINA K. (RUS)	097 Tomari Bassai	2160	

1. VARLAMOVA EKATERINA (RUS)
2. KOKAREVA KSENIYA (RUS)
3. HRACHOVA PALINA (BLR)
4. BUMAGINA KIRA (RUS)



1. SHCHERBINA ANNA (RUS)
2. TURAKULOVA DURDONA (UZB)
3. BARAVIK VERANIKA (BLR)
3. SINGHI MESOM (IND)
5. NEDA REZAI (AZE)
5. ROLIA MILENA (BLR)
7. KOTLYAROVA POLINA (RUS)
7. VARLAMOVA EKATERINA (RUS)

Referees:			









Senior kata female - Round Robin (each against each)

MOSCOW-KARATE-UNIVERSE INTERNATIONAL 2024, Moscow, RUS

Tatami

Pool

8/8

1	 ROLIA M. (BLR)	020 Gojushiho Dai	2160	 ROLIA M. (BLR)
2	 GORYACHEVA E. (RUS)	021 Gojushiho Sho	2080	
3	 ROLIA M. (BLR)	021 Gojushiho Sho	2150	 TURAKULOVA D. (UZB)
4	 TURAKULOVA D. (UZB)	008 Chatanyara Kushanku	2200	
5	 GORYACHEVA E. (RUS)	020 Gojushiho Dai	2150	 TURAKULOVA D. (UZB)
6	 TURAKULOVA D. (UZB)	047 Kururunfa	2240	

1. TURAKULOVA DURDONA (UZB)
2. ROLIA MILENA (BLR)
3. GORYACHEVA EKATERINA (RUS)



1. SHCHERBINA ANNA (RUS)
2. TURAKULOVA DURDONA (UZB)
3. BARAVIK VERANIKA (BLR)
3. SINGHI MESOM (IND)
5. NEDA REZAI (AZE)
5. ROLIA MILENA (BLR)
7. KOTLYAROVA POLINA (RUS)
7. VARLAMOVA EKATERINA (RUS)

Referees:			

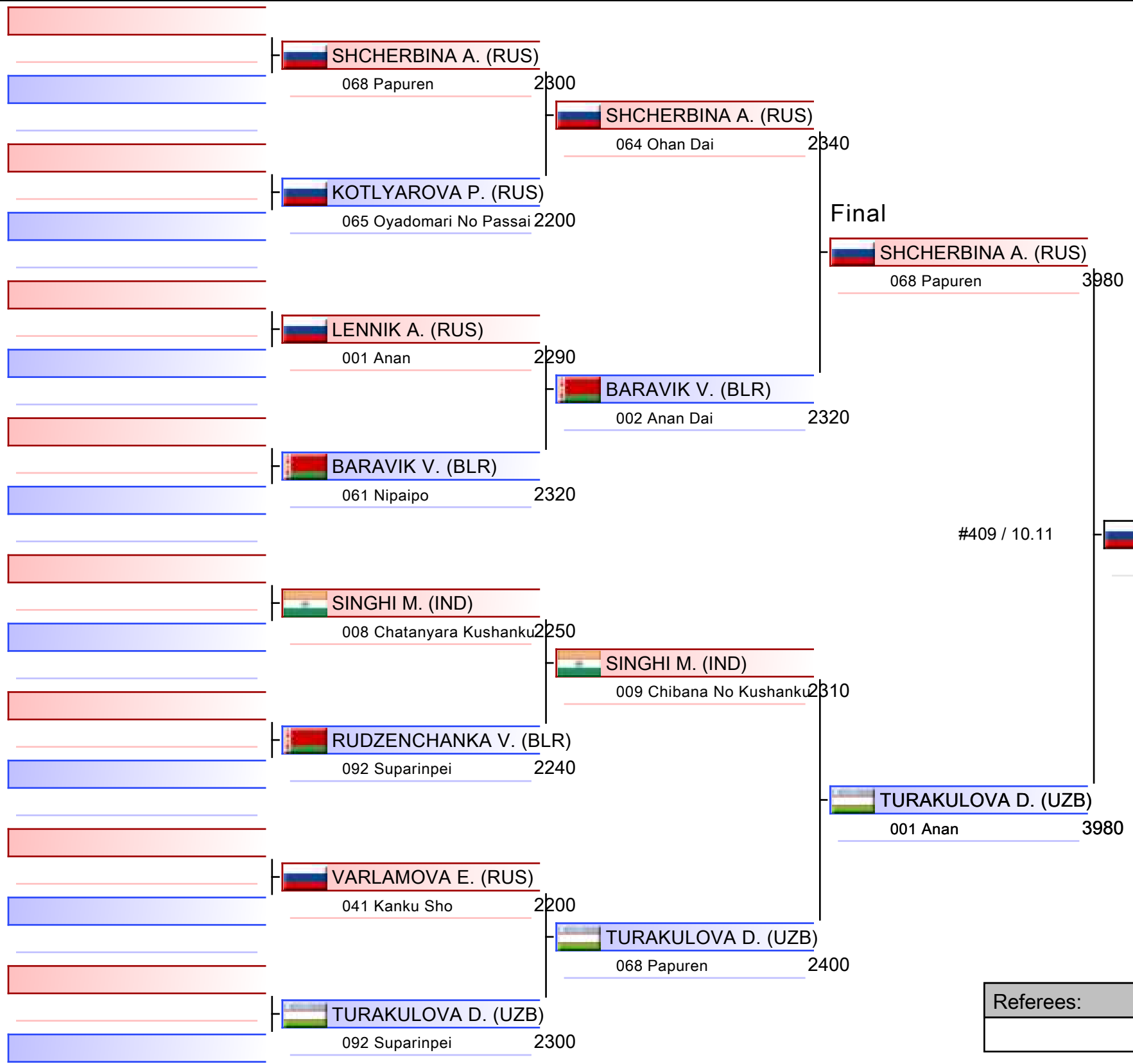

- | |
|------------------------------|
| 1. SHCHERBINA ANNA (RUS) |
| 2. TURAKULOVA DURDONA (UZB) |
| 3. BARAVIK VERANIKA (BLR) |
| 3. SINGHI MESOM (IND) |
| 5. NEDA REZAI (AZE) |
| 5. ROLIA MILENA (BLR) |
| 7. KOTLYAROVA POLINA (RUS) |
| 7. VARLAMOVA EKATERINA (RUS) |

Referees:			

Senior kata female

MOSCOW-KARATE-UNIVERSE INTERNATIONAL 2024

Tatami

Pool

1,2,3,4,5,6,7,8

(c)sportdata GmbH & Co KG 2000-2024 (2024-11-10 18:21) v 10.2.0 build 1 (2024-07-20 11:09 CET) License: Online_Event_ID-8474_MOSCOWKARATEUNIVERSEINTERNATIONAL2024 (expire 2024-11-24)

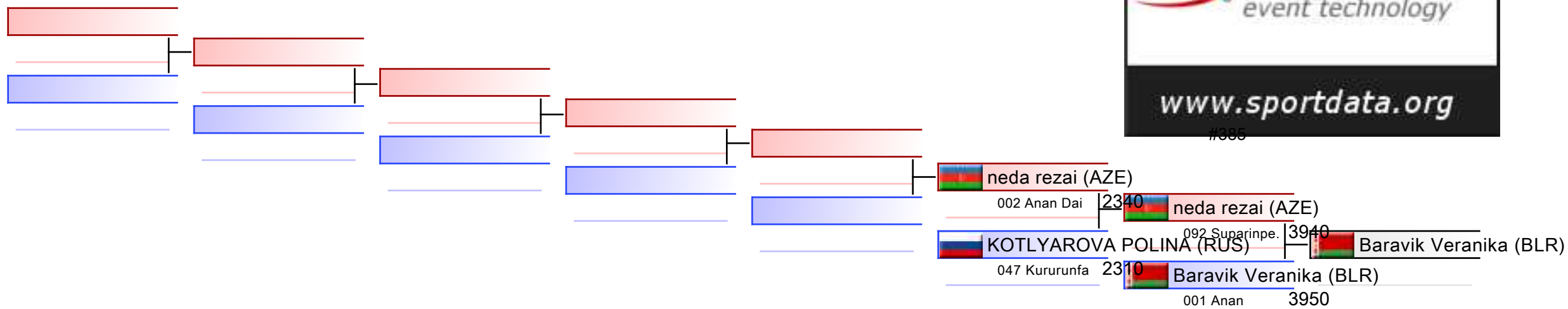

REPECHAGE: (1,2,3,4,5,6,7,8)

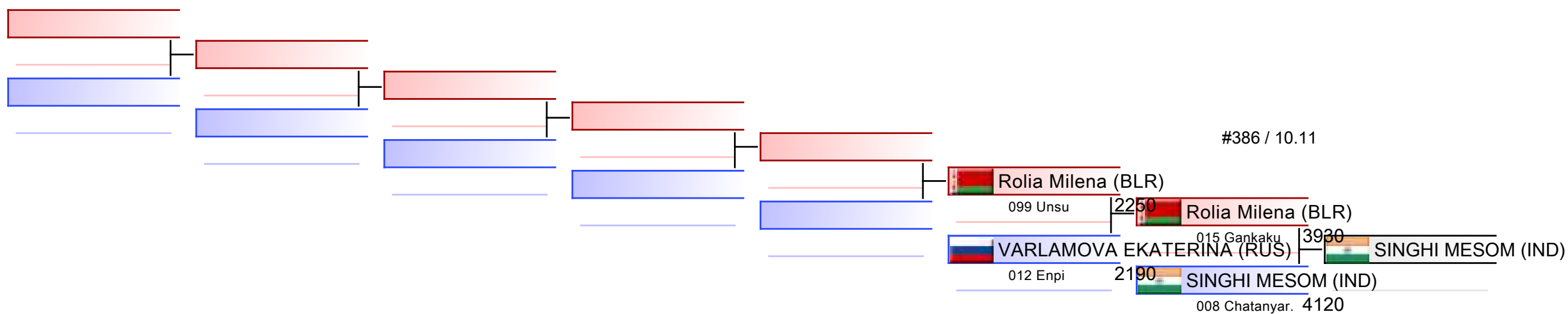

Referees:							
-----------	--	--	--	--	--	--	--



MOSCOW-KARATE-UNIVERSE
INTERNATIONAL 2024 - 2024-11-08



Official Results

Senior kata female			
1	SHCHERBINA ANNA		RUS - RUSSIAN FEDERATION
2	TURAKULOVA DURDONA		UZB - UZBEKISTAN
3	BARAVIK VERANIKA		BLR - BELARUS
3	SINGHI MESOM		IND - INDIA
5	NEDA REZAI		AZE - AZERBAIJAN
5	ROLIA MILENA		BLR - BELARUS
7	KOTLYAROVA POLINA		RUS - RUSSIAN FEDERATION
7	VARLAMOVA EKATERINA		RUS - RUSSIAN FEDERATION

SENIOR KATA MALE



MOSCOW-KARATE-UNIVERSE INTERNATIONAL ..
ENTRIES BY WEIGHT CATEGORY



Senior kata male
As of 10 NOV 2024

NOC Code	Gender	Name	Seeding
ALG	M	SALAH EDDINE SEKKOUR	4
ARM	M	Mkhitaryan Mikhayil	
AZE	M	heydarov roman	1
BLR	M	Antsimonik Ivan	
BLR	M	Bareika Maksim	3
CIV	M	KONE NERIME ZIE JOSPIN	
IND	M	NATH ARJUN	
KAZ	M	Kateshov Madi	2
RUS	M	ANUCHIN PAVEL	14
RUS	M	BAKIROV VARISHAN	16
RUS	M	BELYKH VALERIY	11
RUS	M	BRANTOV DANILA	
RUS	M	KACHESOV GEORGII	9
RUS	M	KIM VALENTIN	15
RUS	M	Popov Egor	13
RUS	M	SAVVIN NIKOLAI	
RUS	M	SERGEEV IVAN	
RUS	M	Sidorenko Denis	
RUS	M	STARILOV ARTEM	
RUS	M	SUTYAGIN KONSTANTIN	12
RUS	M	ZHURAVLEV MAKSIM	10
SRI	M	CHAMINDA SISIRA KUMARA AHANGAMA WITHANAGE	
UAE	M	MOHAMED ABDULGHANI	6
UZB	M	Soyibjonov Sanjarbek	
UZB	M	VOISOV UMIDJON	



















Senior kata male - Round Robin (each against each)

MOSCOW-KARATE-UNIVERSE INTERNATIONAL 2024, Moscow, RUS

Tatami

Pool

1/8

1	 MKHITARYAN M. (ARM)	099 Unsu #202 / 09.11	2180	 BAKIROV V. (RUS)
2	 BAKIROV V. (RUS)	020 Gojushiho Dai	2270	
3	 VOISOV U. (UZB)	021 Gojushiho Sho #203 / 09.11	2180	 MOHAMED A. (UAE)
4	 MOHAMED A. (UAE)	021 Gojushiho Sho	2170	
5	 MKHITARYAN M. (ARM)	020 Gojushiho Dai #205 / 09.11	2190	 MKHITARYAN M. (ARM)
6	 VOISOV U. (UZB)	099 Unsu	2120	
7	 MOHAMED A. (UAE)	041 Kanku Sho #206 / 09.11	2220	 BAKIROV V. (RUS)
8	 BAKIROV V. (RUS)	041 Kanku Sho	2310	
9	 MKHITARYAN M. (ARM)	021 Gojushiho Sho #208 / 09.11	2280	 MKHITARYAN M. (ARM)
10	 MOHAMED A. (UAE)	015 Gankaku	2150	
11	 BAKIROV V. (RUS)	015 Gankaku #209 / 09.11	2350	 BAKIROV V. (RUS)
12	 VOISOV U. (UZB)	015 Gankaku	2120	

1. BAKIROV VARISHAN (RUS)
2. MKHITARYAN MIKHAYIL (ARM)
3. MOHAMED ABDULGHANI (UAE)
4. VOISOV UMIDJON (UZB)



1. BAKIROV VARISHAN (RUS)
2. HEYDAROV ROMAN (AZE)
3. ANUCHIN PAVEL (RUS)
3. ANTSIMONIK IVAN (BLR)
5. BAREIKA MAKSIM (BLR)
5. KACHESOV GEORGII (RUS)
7. MKHITARYAN MIKHAYIL (ARM)
7. NATH ARJUN (IND)

Referees:			









Senior kata male - Round Robin (each against each)

MOSCOW-KARATE-UNIVERSE INTERNATIONAL 2024, Moscow, RUS

Tatami

Pool

2/8

1	 SERGEEV I. (RUS)	092 Suparjpei #211 / 09.11	2270	 SUTYAGIN K. (RUS)
2	 SUTYAGIN K. (RUS)	020 Gojushiho Dai	2330	
3	 SERGEEV I. (RUS)	002 Anan Dai #213 / 09.11	2250	 BAREIKA M. (BLR)
4	 BAREIKA M. (BLR)	068 Papuren	2280	
5	 SUTYAGIN K. (RUS)	099 Unsu #215 / 09.11	2320	 BAREIKA M. (BLR)
6	 BAREIKA M. (BLR)	002 Anan Dai	2340	

1. BAREIKA MAKSIM (BLR)
2. SUTYAGIN KONSTANTIN (RUS)
3. SERGEEV IVAN (RUS)



1. BAKIROV VARISHAN (RUS)
2. HEYDAROV ROMAN (AZE)
3. ANUCHIN PAVEL (RUS)
3. ANTSIMONIK IVAN (BLR)
5. BAREIKA MAKSIM (BLR)
5. KACHESOV GEORGII (RUS)
7. MKHITARYAN MIKHAYIL (ARM)
7. NATH ARJUN (IND)

Referees:			









Senior kata male - Round Robin (each against each)

MOSCOW-KARATE-UNIVERSE INTERNATIONAL 2024, Moscow, RUS

Tatami

Pool

3/8

1	 KONE N. (CIV)	068 Papuren #217 / 09.11	2270	 ANUCHIN P. (RUS)	2210
2	 ANUCHIN P. (RUS)	066 Pachu	2270		
3	 KONE N. (CIV)	092 Suparinpei #219 / 09.11	2150	 SAVVIN N. (RUS)	2160
4	 SAVVIN N. (RUS)	020 Gojushiho Dai	2190		
5	 ANUCHIN P. (RUS)	047 Kururunfa #221 / 09.11	2290	 ANUCHIN P. (RUS)	2290
6	 SAVVIN N. (RUS)	021 Gojushiho Sho	2120		

1. ANUCHIN PAVEL (RUS)
2. SAVVIN NIKOLAI (RUS)
3. KONE NERIME ZIE JOSPIN (CIV)



1. BAKIROV VARISHAN (RUS)
2. HEYDAROV ROMAN (AZE)
3. ANUCHIN PAVEL (RUS)
3. ANTSIMONIK IVAN (BLR)
5. BAREIKA MAKSIM (BLR)
5. KACHESOV GEORGII (RUS)
7. MKHITARYAN MIKHAYIL (ARM)
7. NATH ARJUN (IND)

Referees:			









Senior kata male - Round Robin (each against each)

MOSCOW-KARATE-UNIVERSE INTERNATIONAL 2024, Moscow, RUS

Tatami

Pool

4/8

1	 STARILOV A. (RUS)	001 Anan #223 / 09.11	2210	 ZHURAVLEV M. (RUS)
2	 ZHURAVLEV M. (RUS)	020 Gojushiho Dai	2300	
3	 STARILOV A. (RUS)	097 Tomari Bassai #225 / 09.11	2210	 KATESHOV M. (KAZ)
4	 KATESHOV M. (KAZ)	001 Anan	2300	
5	 ZHURAVLEV M. (RUS)	021 Gojushiho Sho #227 / 09.11	2280	 ZHURAVLEV M. (RUS)
6	 KATESHOV M. (KAZ)	020 Gojushiho Dai	2210	

1. ZHURAVLEV MAKSIM (RUS)
2. KATESHOV MADI (KAZ)
3. STARILOV ARTEM (RUS)



1. BAKIROV VARISHAN (RUS)
2. HEYDAROV ROMAN (AZE)
3. ANUCHIN PAVEL (RUS)
3. ANTSIMONIK IVAN (BLR)
5. BAREIKA MAKSIM (BLR)
5. KACHESOV GEORGII (RUS)
7. MKHITARYAN MIKHAYIL (ARM)
7. NATH ARJUN (IND)

Referees:			









Senior kata male - Round Robin (each against each)

MOSCOW-KARATE-UNIVERSE INTERNATIONAL 2024, Moscow, RUS

Tatami

Pool

5/8

1	 ANTSIMONIK I. (BLR)	099 Unsu #204 / 09.11	2170	 ANTSIMONIK I. (BLR)
2	 KIM V. (RUS)	020 Gojushiho Dai	2070	
3	 ANTSIMONIK I. (BLR)	020 Gojushiho Dai #207 / 09.11	2220	 ANTSIMONIK I. (BLR)
4	 SOYIBJONOV S. (UZB)	099 Unsu	2100	
5	 KIM V. (RUS)	012 Enpi #210 / 09.11	2280	 KIM V. (RUS)
6	 SOYIBJONOV S. (UZB)	015 Gankaku	2080	

1. ANTSIMONIK IVAN (BLR)
2. KIM VALENTIN (RUS)
3. SOYIBJONOV SANJARBEK (UZB)



1. BAKIROV VARISHAN (RUS)
2. HEYDAROV ROMAN (AZE)
3. ANUCHIN PAVEL (RUS)
3. ANTSIMONIK IVAN (BLR)
5. BAREIKA MAKSIM (BLR)
5. KACHESOV GEORGII (RUS)
7. MKHITARYAN MIKHAYIL (ARM)
7. NATH ARJUN (IND)

Referees:			









Senior kata male - Round Robin (each against each)

MOSCOW-KARATE-UNIVERSE INTERNATIONAL 2024, Moscow, RUS

Tatami

Pool

6/8

1	 BRANTOV D. (RUS)	021 Gojushiho Sho #212 / 09.11	2250	 BRANTOV D. (RUS)
2	 BELYKH V. (RUS)	002 Anan Dai	2220	
3	 BRANTOV D. (RUS)	020 Gojushiho Dai #214 / 09.11	2290	 SALAH EDDINE S. (ALG)
4	 SALAH EDDINE S. (ALG)	020 Gojushiho Dai	2360	
5	 BELYKH V. (RUS)	001 Anan #216 / 09.11	2240	 SALAH EDDINE S. (ALG)
6	 SALAH EDDINE S. (ALG)	021 Gojushiho Sho	2290	

1. SALAH EDDINE SEKKOUR (ALG)
2. BRANTOV DANILA (RUS)
3. BELYKH VALERIY (RUS)



1. BAKIROV VARISHAN (RUS)
2. HEYDAROV ROMAN (AZE)
3. ANUCHIN PAVEL (RUS)
3. ANTSIMONIK IVAN (BLR)
5. BAREIKA MAKSIM (BLR)
5. KACHESOV GEORGII (RUS)
7. MKHITARYAN MIKHAYIL (ARM)
7. NATH ARJUN (IND)

Referees:			









Senior kata male - Round Robin (each against each)

MOSCOW-KARATE-UNIVERSE INTERNATIONAL 2024, Moscow, RUS

Tatami

Pool

7/8

1	 NATH A. (IND)	068 Papuren #218 / 09.11	2210	 NATH A. (IND)
2	 POPOV E. (RUS)	002 Anan Dai	2170	
3	 NATH A. (IND)	064 Ohan Dai #220 / 09.11	2220	 NATH A. (IND)
4	 SIDORENKO D. (RUS)	021 Gojushiho Sho	2100	
5	 POPOV E. (RUS)	063 Ohan #222 / 09.11	2220	 POPOV E. (RUS)
6	 SIDORENKO D. (RUS)	041 Kanku Sho	2080	

1. NATH ARJUN (IND)
2. POPOV EGOR (RUS)
3. SIDORENKO DENIS (RUS)



1. BAKIROV VARISHAN (RUS)
2. HEYDAROV ROMAN (AZE)
3. ANUCHIN PAVEL (RUS)
3. ANTSIMONIK IVAN (BLR)
5. BAREIKA MAKSIM (BLR)
5. KACHESOV GEORGII (RUS)
7. MKHITARYAN MIKHAYIL (ARM)
7. NATH ARJUN (IND)

Referees:			









Senior kata male - Round Robin (each against each)

MOSCOW-KARATE-UNIVERSE INTERNATIONAL 2024, Moscow, RUS

Tatami

Pool

8/8

1	 CHAMINDA SISIRA KUMARA A. (SRI)	015 Gankaku #224 / 09.11	1840	 KACHESOV G. (RUS)
2	 KACHESOV G. (RUS)	047 Kururunfa	2240	
3	 CHAMINDA SISIRA KUMARA A. (SRI)	006 Bassai Dai #226 / 09.11	1850	 HEYDAROV R. (AZE)
4	 HEYDAROV R. (AZE)	091 Sochin	2360	
5	 KACHESOV G. (RUS)	083 Seipai #228 / 09.11	2210	 HEYDAROV R. (AZE)
6	 HEYDAROV R. (AZE)	099 Unsu	2350	

1. HEYDAROV ROMAN (AZE)
2. KACHESOV GEORGII (RUS)
3. CHAMINDA SISIRA KUMARA AHANGAMA WITHANAGE (SRI)



1. BAKIROV VARISHAN (RUS)
2. HEYDAROV ROMAN (AZE)
3. ANUCHIN PAVEL (RUS)
3. ANTSIMONIK IVAN (BLR)
5. BAREIKA MAKSIM (BLR)
5. KACHESOV GEORGII (RUS)
7. MKHITARYAN MIKHAYIL (ARM)
7. NATH ARJUN (IND)

Referees:			

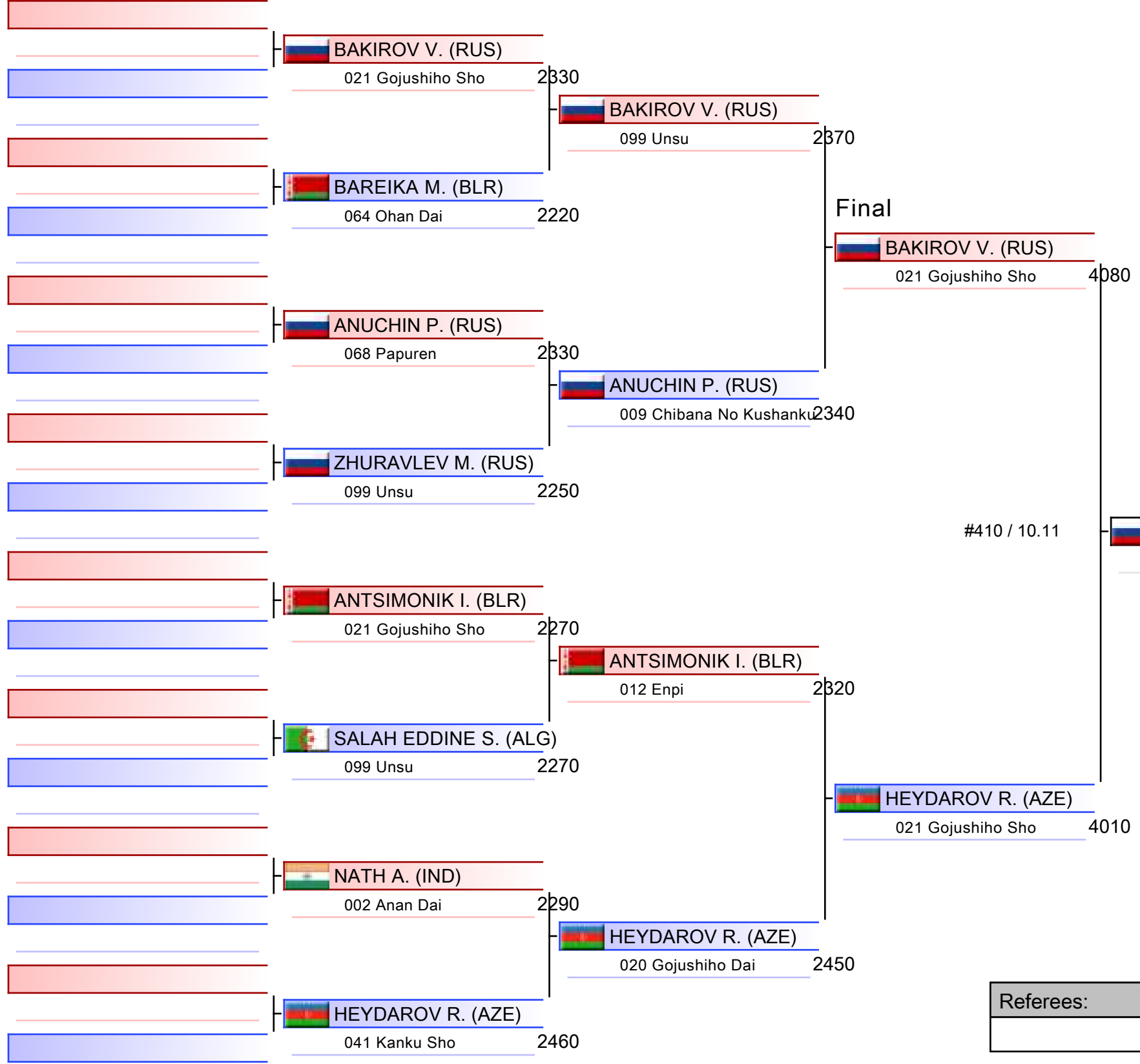

1. BAKIROV VARISHAN (RUS)
2. HEYDAROV ROMAN (AZE)
3. ANUCHIN PAVEL (RUS)
3. ANTSIMONIK IVAN (BLR)
5. BAREIKA MAKSYM (BLR)
5. KACHESOV GEORGII (RUS)
7. MKHITARYAN MIKHAYIL (ARM)
7. NATH ARJUN (IND)

Referees:			

Senior kata male

MOSCOW-KARATE-UNIVERSE INTERNATIONAL 2024

2024-11-09

Tatami

2 10:47

Pool

1,2,3,4,5,6,7,8

(c)sportdata GmbH & Co KG 2000-2024 (2024-11-10 18:21) v 10.2.0 build 1 (2024-07-20 11:09 CET) License: Online_Event_ID-8474_MOSCOWKARATEUNIVERSEINTERNATIONAL2024 (expire 2024-11-24)

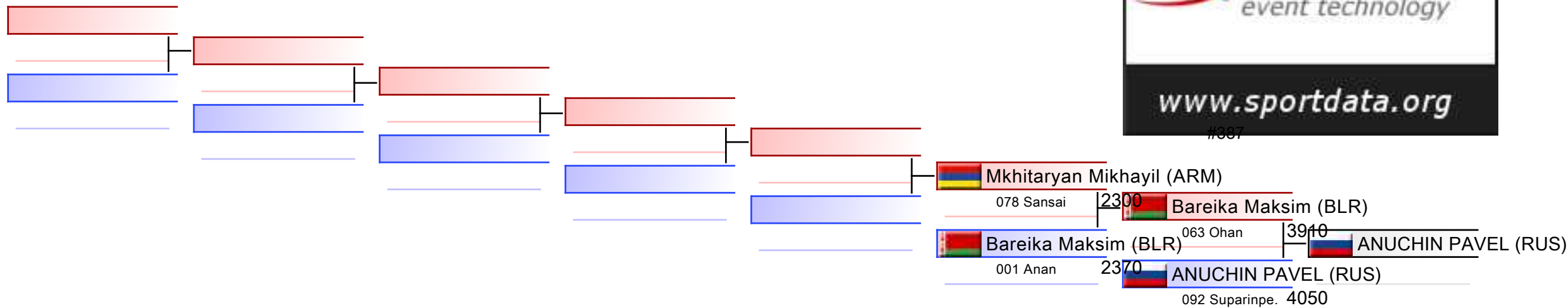

REPECHAGE: (1,2,3,4,5,6,7,8)

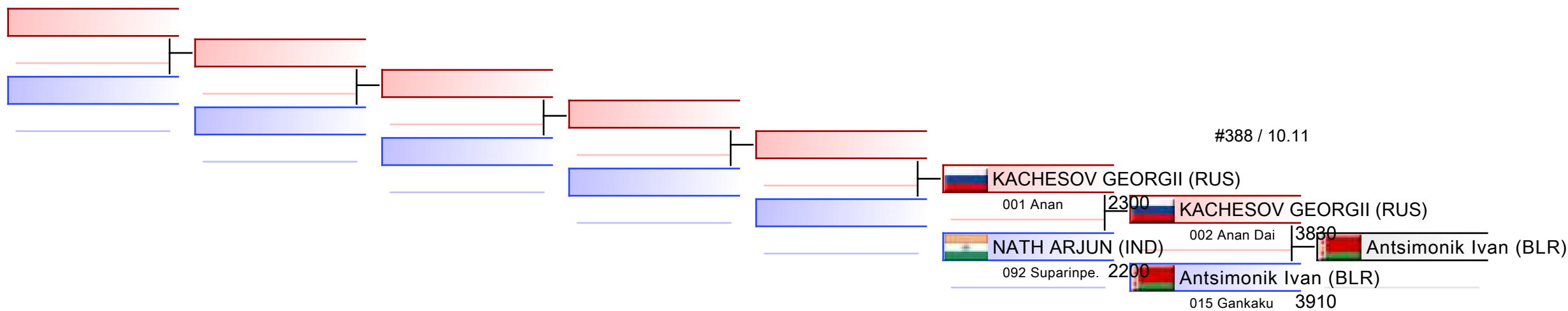

Referees:							
-----------	--	--	--	--	--	--	--



MOSCOW-KARATE-UNIVERSE
INTERNATIONAL 2024 - 2024-11-08



Official Results

Senior kata male			
1	BAKIROV VARISHAN		RUS - RUSSIAN FEDERATION
2	HEYDAROV ROMAN		AZE - AZERBAIJAN
3	ANUCHIN PAVEL		RUS - RUSSIAN FEDERATION
3	ANTSIMONIK IVAN		BLR - BELARUS
5	BAREIKA MAKSIM		BLR - BELARUS
5	KACHESOV GEORGII		RUS - RUSSIAN FEDERATION
7	MKHITARYAN MIKHAYIL		ARM - ARMENIA
7	NATH ARJUN		IND - INDIA



MOSCOW-KARATE-UNIVERSE
INTERNATIONAL 2024 - 2024-11-08



Official Results

Senior Kumite Female -50kg			
1	ZHANGBYRBAY MOLDIR		KAZ - KAZAKHSTAN
2	GARIPOVA KAMILLA		RUS - RUSSIAN FEDERATION
3	TEYMUROVA FIDAN		AZE - AZERBAIJAN
3	SALAZAR YORGELIS		VEN - VENEZUELA
5	SADKOVA AIGUL		RUS - RUSSIAN FEDERATION
5	AL AJMI HAWRAA		UAE - UNITED ARAB EMIRATES
7	MAHMOUD GANA		EGY - EGYPT
7	GRIGOREVA ELIZAVETA		RUS - RUSSIAN FEDERATION

Senior Kumite Female -55kg			
1	GORANOVA IVET		BUL - BULGARIA
2	USSENOVA GULMIRA		KAZ - KAZAKHSTAN
3	SADIGOVA MADINA		AZE - AZERBAIJAN
3	PEREVOZCHIKOVA ANNA		RUS - RUSSIAN FEDERATION
5	IUSHKEVICH VASILINA		RUS - RUSSIAN FEDERATION
5	CHERNYSHEVA ANNA		RUS - RUSSIAN FEDERATION
7	AGUNG SANISTYARANI COK ISTRI		INA - INDONESIA
7	RAKHIMOVA SEVINCH		UZB - UZBEKISTAN

Senior Kumite Female -61kg			
1	AZARAVA MARYIA		BLR - BELARUS
2	RODINA ANNA		RUS - RUSSIAN FEDERATION
3	BASANGOVA ALTANA		RUS - RUSSIAN FEDERATION
3	TOLBA RAHMA		EGY - EGYPT
5	BÜBER NURBADE		TUR - TURKIYE
5	TIZIMBAY NURIYA		KAZ - KAZAKHSTAN
7	DEMENEVA VARVARA		RUS - RUSSIAN FEDERATION
7	SADOVSKAYA MARIYA		RUS - RUSSIAN FEDERATION

Senior Kumite Female -68kg			
1	MESHKOVA ALEKSANDRA		RUS - RUSSIAN FEDERATION
2	SAGYNBEK LAURA		KAZ - KAZAKHSTAN
3	ABDELAZIZ FERYAL		EGY - EGYPT
3	RAMANIUK VOLHA		BLR - BELARUS
5	KUDRIAVTSEVA ANNA		RUS - RUSSIAN FEDERATION
5	ABDRIMOVA MOHICHEHRA		UZB - UZBEKISTAN
7	BIKMULLINA KAMILLA		RUS - RUSSIAN FEDERATION
7	MARKOVSKAYA SVETLANA		RUS - RUSSIAN FEDERATION

Senior Kumite Female +68kg			
1	BERULTSEVA SOFYA		KAZ - KAZAKHSTAN
2	PIPKO DARIA		RUS - RUSSIAN FEDERATION
3	JEMI CHEHINEZ		TUN - TUNISIA
3	MSAKNI TESNIM		TUN - TUNISIA
5	HAI DI MAHGOUB		EGY - EGYPT



MOSCOW-KARATE-UNIVERSE
INTERNATIONAL 2024 - 2024-11-08



Official Results

5	SHISHOVA KSENIYA		RUS - RUSSIAN FEDERATION	
7	KHALIMOVA SUNITA		RUS - RUSSIAN FEDERATION	
7	HOCAOGLU AKYOL MELTEM		TUR - TURKIYE	

Senior Kumite Male +84kg

1	ABAZARI SALEH		IRI - ISLAMIC REPUBLIC OF IRAN	
2	ASHOURI GARMJANI MAHDI		IRI - ISLAMIC REPUBLIC OF IRAN	
3	KUDZINAU IVAN		BLR - BELARUS	
3	ANARBEKOV DIAS		KAZ - KAZAKHSTAN	
5	KOKOVUROV KONSTANTIN		RUS - RUSSIAN FEDERATION	
5	ISAKAU ANTON		BLR - BELARUS	
7	PCHENITCIN ALEKSANDR		RUS - RUSSIAN FEDERATION	
7	GUSEV IGOR		RUS - RUSSIAN FEDERATION	

Senior Kumite Male -60kg

1	PAKHOMOV SULEYMAN		RUS - RUSSIAN FEDERATION	
2	FERCHICHI IHEB		TUN - TUNISIA	
3	BIGABYL ZHOLAMAN		KAZ - KAZAKHSTAN	
3	GULIYEV AMINAGHA		AZE - AZERBAIJAN	
5	BASCHIN EVGENIY		RUS - RUSSIAN FEDERATION	
5	SATYBALDIEV ERBOL		RUS - RUSSIAN FEDERATION	
7	PYDIPATI BABI VARMA		IND - INDIA	
7	TUREBEK YELNUR		KAZ - KAZAKHSTAN	

Senior Kumite Male -67kg

1	MIKHAILICHENKO DANILA		RUS - RUSSIAN FEDERATION	
2	OGANNISYAN YURIK		RUS - RUSSIAN FEDERATION	
3	UKHABOV PAVEL		RUS - RUSSIAN FEDERATION	
3	MAMMADLI HUSEYN		AZE - AZERBAIJAN	
5	BARATOV VIZIT		KGZ - KYRGYZSTAN	
5	ILUSHIN ANATOLIY		RUS - RUSSIAN FEDERATION	
7	AKHMEDOV AKHMED		RUS - RUSSIAN FEDERATION	
7	RASHIDOV ABDUL VAKHKHOB		UZB - UZBEKISTAN	

Senior Kumite Male -75kg

1	GADZHIEV GADZHI		RUS - RUSSIAN FEDERATION	
2	ELSAWY ALY		EGY - EGYPT	
3	NEMATI MORTEZA		IRI - ISLAMIC REPUBLIC OF IRAN	
3	SHARAFUTDINOV ERNEST		RUS - RUSSIAN FEDERATION	
5	ASKARIPOUR MOHAMMADERFAN		IRI - ISLAMIC REPUBLIC OF IRAN	
5	HOVHANNISYAN ROBERT		ARM - ARMENIA	
7	MUKHAT AIDOS		KAZ - KAZAKHSTAN	
7	BATYRGALI ABILMANSUR		KAZ - KAZAKHSTAN	

Senior Kumite Male -84kg

1	TARNAKIN NIKITA		KAZ - KAZAKHSTAN	
2	ANTONYAN ARUTYUN		RUS - RUSSIAN FEDERATION	



MOSCOW-KARATE-UNIVERSE
INTERNATIONAL 2024 - 2024-11-08



Official Results

3	YULDASHEV DANIYAR		KAZ - KAZAKHSTAN	
3	BADAWY YOUSSEF		EGY - EGYPT	
5	GUGLEVATYI DMITRIY		RUS - RUSSIAN FEDERATION	
5	KHODABAKHSHI MAHDI		IRI - ISLAMIC REPUBLIC OF IRAN	
7	HEYDARIYASAVOLI ALIREZA		IRI - ISLAMIC REPUBLIC OF IRAN	
7	BREZANCIC VLADIMIR		SRB - SERBIA	

Senior kata female

1	SHCHERBINA ANNA		RUS - RUSSIAN FEDERATION	
2	TURAKULOVA DURDONA		UZB - UZBEKISTAN	
3	BARAVIK VERANIKA		BLR - BELARUS	
3	SINGHI MESOM		IND - INDIA	
5	NEDA REZAI		AZE - AZERBAIJAN	
5	ROLIA MILENA		BLR - BELARUS	
7	KOTLYAROVA POLINA		RUS - RUSSIAN FEDERATION	
7	VARLAMOVA EKATERINA		RUS - RUSSIAN FEDERATION	

Senior kata male











1	BAKIROV VARISHAN		RUS - RUSSIAN FEDERATION	
2	HEYDAROV ROMAN		AZE - AZERBAIJAN	
3	ANUCHIN PAVEL		RUS - RUSSIAN FEDERATION	
3	ANTSIMONIK IVAN		BLR - BELARUS	
5	BAREIKA MAKSIM		BLR - BELARUS	
5	KACHESOV GEORGII		RUS - RUSSIAN FEDERATION	
7	MKHITARYAN MIKHAYIL		ARM - ARMENIA	
7	NATH ARJUN		IND - INDIA	



MOSCOW-KARATE-UNIVERSE
INTERNATIONAL 2024 - 2024-11-08



Medals - Nation

Rank	Nation	1. Place	2. Place	3. Place
1	 RUSSIAN FEDERATION, RUS	6	5	5
2	 KAZAKHSTAN, KAZ	3	2	3
3	 ISLAMIC REPUBLIC OF IRAN, IRI	1	1	1
4	 BELARUS, BLR	1	0	4
5	 BULGARIA, BUL	1	0	0
6	 AZERBAIJAN, AZE	0	1	4
7	 EGYPT, EGY	0	1	3
8	 TUNISIA, TUN	0	1	2
9	 UZBEKISTAN, UZB	0	1	0
10	 VENEZUELA, VEN	0	0	1
	 INDIA, IND	0	0	1