



General catalogue | 2019/2020

EMC-SOLUTIONS
FASTENING SYSTEMS

„HEBOTEC stands for special properties, such as: innovative power, ingenuity, diligence, business thinking and reliability. All that experience from the first minute of our partnership.“

Product lines and contents

EMC-SOLUTIONS

05	System specification
06 - 07	Attenuation of conductance
08 - 10	Shield clamp HSK, Multi, Big
11	Shield clamp with integrated strain relief
12	Shield clamp with strain relief on clip foot
13 - 16	HEBOCLIP with clip foot
17 - 19	HEBOCLIP for busbar
20	HEBOCLIP for direct assembly
21	Shield clamp with open slotted hole
22 - 23	Shield clamp for direct assembly
24	HEBOCLIP clamp assembly with strain relief
25 - 26	HEBOCLIP for perforated plate
27	Shield clamp with mounting adapter for C-rails
28	Shield clamp riveted on earthing tape
29	HEBOSET Set of assorted fittings
30 - 31	Customised shield connections
32 - 33	Earthing tapes
34	Customised earthing tapes
35	Shielding braid
36 - 37	HEBOPRESS Cable lugs, tools
38	Patch panel for network cabinets EMC-conform
39	Busbar support for 35 mm DIN rail
40	Cable fixing plate
41	Supports for 35 mm DIN rail and busbar
42	Shield connection for busbar
43	Shielding clamp with spring
44	Grounding clamp

FASTENING SYSTEMS

46 - 47	M8-/M12-Mounting clip
48	M17-/M23-Mounting bracket Big
49	Hook-and-loop tape
50	Hook-and-loop cable tie
51	Hook-and-loop strap
52 - 53	HEBOFIX base for hook-and-loop tape KBS, Big
54 - 56	HEBOFIX base for aluminium profiles
57 - 59	HEBOFIX 45 base for aluminium profiles
60	HEBOFIX 45 base for Rittal-VX25
61	HEBOFIX base self-adhesive
62 - 63	HEBOFIX base for C-rail
64	HEBOFIX base with mounting adapter for C-rail
65	HEBOFIX base for 35 mm DIN rail
66	HEBOFIX base with expanding rivet
67	HEBOFIX Maintenance Box
68	HEBOFIX Mounting accessories for HEBOFIX base
69	Hook-and-loop fastener
70 - 71	Clip foot for 35 mm DIN rail
72	Mounting adapter for C-rail

PRODUCT LINE

EMC-solutions

In engine, plant and switch board construction, control and performance components are increasingly complex. As a result, a well thought-out EMC-concept gains in importance. HEBOTEC products for earthing cable shields meet the requirements of low bleeder resistance at high frequencies.

HEBOTEC products are characterised by exceptionally easy handling. Furthermore, we supply customised system solutions.

System specifications

EXTENSIVE SHIELD CONTACT



ADVANTAGES

- // resilience ensures constant contact with the cable shield
- // high conductance due to surface coating
- // extensive cable shield contact allows low-voltage discharging resistance even at high frequencies

HEBOCLIP-SYSTEM – TOOL-FREE ASSEMBLY

The HEBOCLIP brackets for mounting directly, on 35 mm DIN rails or on busbars can be assembled with the suitable shield clamps without using tools. The shield clamps are available in different sizes with a clamping range of 1.5 to 30 mm. A small slot screwdriver suffices to dismantle the shield clamp.

ASSEMBLY OF THE SHIELD CLAMP WITH THE HEBOCLIP



- 1 Place shield clamp in position
- 2 Clip in
- 3 Dismantling

HOW TO MOUNT A HEBOCLIP ONTO A 10 X 3 MM BUSBAR



- 1 Snap on the HEBOCLIP
- 2 Clip the chosen shield clamp into place
- 3 Press the cable shield into the HEBOCLIP
- 4 Reduce strain using cable ties

ADVANTAGES

- // for universal use with 35 mm DIN rails, busbars or for direct mounting
- // tool-free assembly
- // shield clamps are available in various sizes
- // especially flexible
- // cost-saving through reduction of stock parts

Attenuation of conductance HEBOCLIP-System

ATTENUATION OF CONDUCTANCE

The attenuation of conductance indicates by how many dB the existing interferences on the cable shield are attenuated by the shield contact.

A value of 20 dB results in an interference reduction of 90%, a value of 40 dB in a reduction of even 99%. The HEBOCLIP-system offers excellent attenuation of conductance for all assembly modes.

HHZ-2 EQUIPPED WITH HSK 6-8

The HEBOCLIP for tool-free assembly on 35 mm DIN rails.



HDZ EQUIPPED WITH HSK 6-8

The HEBOCLIP for direct assembly.



HSZ EQUIPPED WITH HSK 6-8

The HEBOCLIP for tool-free assembly on 10 x 3 mm busbars.

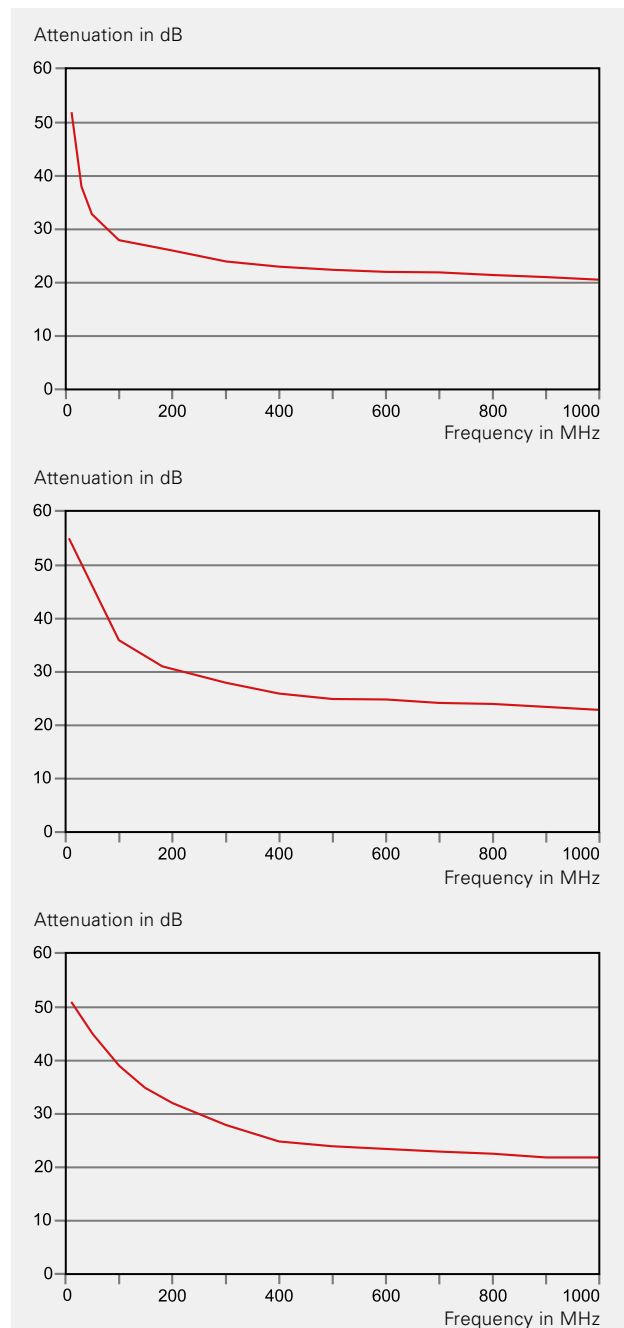

HSDZ EQUIPPED WITH HSK 6-8

The HEBOCLIP Duo for tool-free assembly on 10 x 3 mm busbars.

**HSKB 16 - 35 DIRECT ASSEMBLY**

The shield clamp for large diameters, directly mounted onto the mounting rail.

**HSKB-S 16 - 35 ON CLIP-FOOT**

The shield clamp for large diameters, mounted on clip-foot for tool-free assembly on 35 mm DIN rails.

**HSKB-F 35 - 65 WITH FLAT TAPE CONNECTOR**

The shield clamp for large diameters, for assembly with flexible flat tape connector.

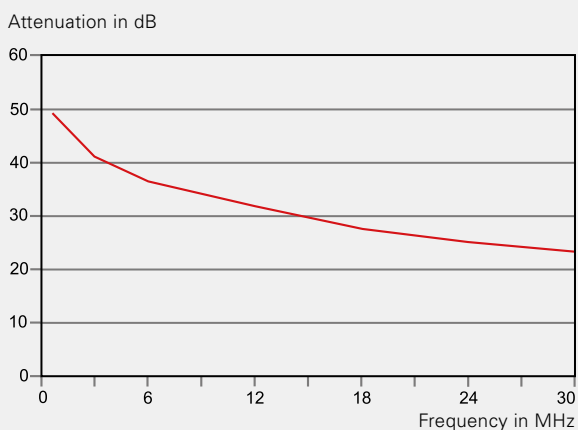
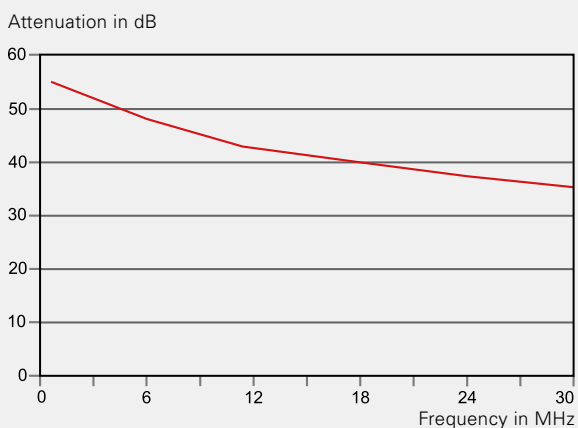
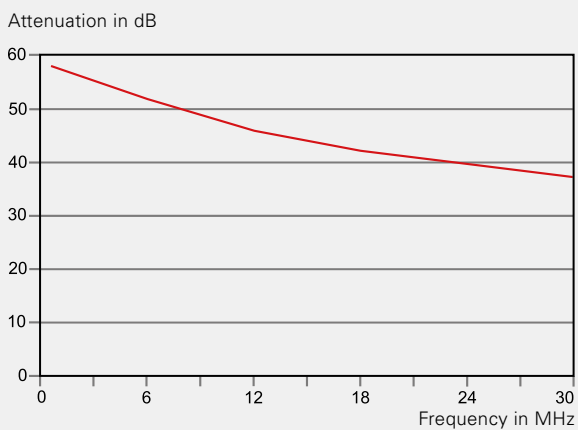
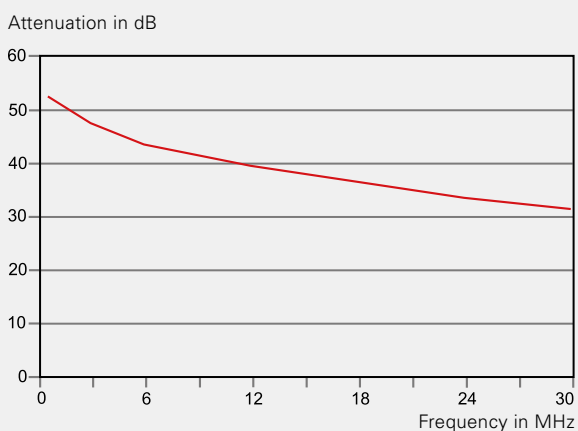

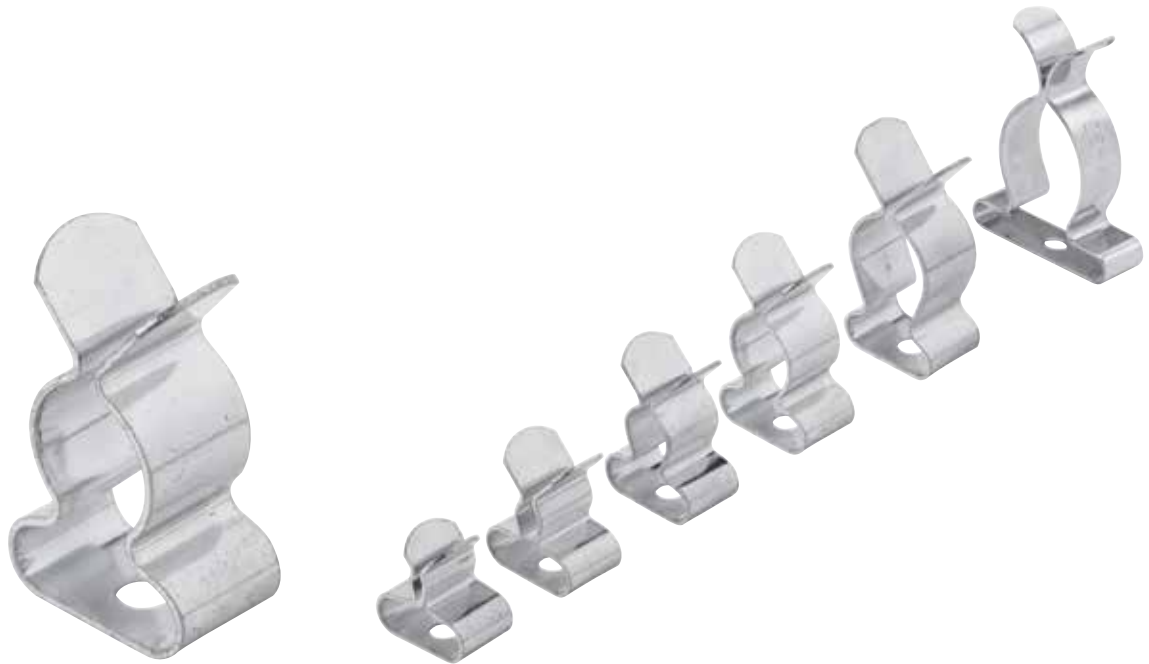

Shield clamp

PRODUCT DESCRIPTION

By simply pushing the stripped cable in the shield clamp, there is a permanently high and continuous spring pressure of the cable shield.

The contact areas are large, assuring a very good derivation of interference currents.

The HSK shield clamps can be used with the various HEBOCLIPs for assembling 35 mm DIN rails, busbars or direct mounting. The installation of the appropriate shield clamp for the particular cable diameter can be done by tool-free clipping.

ADVANTAGES

- // permanently high and continuous spring pressure on the cable shield
- // high conductivity

- // very good derivation of high-frequency interferences
- // the six sizes from 1.5 mm to 30 mm shield range can be snapped onto the HEBOCLIP without tools

TECHNICAL DATA

Material: galvanised spring steel

ACCESSORIES

- // HEBOCLIP for 35 mm DIN rails
- // HEBOCLIP for direct assembly
- // HEBOCLIP for busbars
- // HEBOCLIP clamp assembly

SHIELD CLAMP			
ITEM DESCRIPTION	ORDER NO.	SHIELD DIAMETER	PU
HSK 1,5-3	1010-001	1.5-3 mm	25
HSK 3-6	1010-002	3-6 mm	25
HSK 6-8	1010-003	6-8 mm	25
HSK 8-11	1010-004	8-11 mm	25
HSK 11-16	1010-005	11-16 mm	25
HSK 17-30	1010-017	17-30 mm	25



Shield clamp Multi

PRODUCT DESCRIPTION

The shield clamp Multi differs from the common shield clamp by the special form of both clamp clips. Due to the resilience of the brackets, a very large clamping range is achieved.

By simply pushing the stripped cable into the shield clamp, the constant spring pressure achieves a good contact surface.

Thereby, because of the extensive contact, a greater reliable conductance of interfering currents is made possible.

The shield clamp Multi can be used with the various HEBOCLIPs for assembly with 35 mm DIN rails, busbars or for direct mounting. The assembly of the suitable shield clamp for a particular cable diameter can be effected by tool-free mounting.

ADVANTAGES

- // fewer stock items due to the large clamping range
- // permanently high and continuous spring pressure on the cable shield
- // high conductance
- // excellent derivation of high-frequency interferences
- // the two sizes can be installed onto the HEBOCLIP without tools

TECHNICAL DATA

Material: galvanised spring steel

ACCESSORIES

- // HEBOCLIP for 35 mm DIN rails
- // HEBOCLIP for direct assembly
- // HEBOCLIP for busbars
- // HEBOCLIP clamp assembly

SHIELD CLAMP MULTI

ITEM DESCRIPTION	ORDER NO.	SHIELD DIAMETER	PU
HSKM 3-12	1011-001	3-12 mm	25
HSKM 7-18	1011-002	7-18 mm	25



Shield clamp BIG for large diameters

PRODUCT DESCRIPTION

The shield clamp BIG for large diameters features a wide clamping range, thus allows an excellent contact of cable shields with large diameters.

The stripped cable has to be pressed into the shield clamp. The spring pressure of the clamp offers constant contact with the cable shield.

The shield clamp is available for direct assembly with an M4 screw, with clip foot for assembly onto a 35 mm DIN rail and with a flexible flat tape connector with a length of 50 mm. The accessory component mounting adapter allows the assembly onto C-rails.

ADVANTAGES

- // wide clamping range
- // constant contact with cable shield due to spring pressure
- // high conductance
- // flexible earth connection

TECHNICAL DATA

Material: galvanised spring steel, nickle-plated spring steel, tin-plated copper

ACCESSORIES

- // mounting adapter for C-rails

SHIELD CLAMP BIG FOR DIRECT ASSEMBLY

ITEM DESCRIPTION	ORDER NO.	SHIELD DIAMETER	PU
HSKB 16-35	1012-001	16-35 mm	5
HSKB 35-65	1012-002	35-65 mm	5

SHIELD CLAMP BIG WITH CLIP FOOT

ITEM DESCRIPTION	ORDER NO.	SHIELD DIAMETER	PU
HSKB-S 16-35	1012-011	16-35 mm	5
HSKB-S 35-65	1012-012	35-65 mm	5

SHIELD CLAMP BIG WITH FLAT TAPE CONNECTOR 50 MM

ITEM DESCRIPTION	ORDER NO.	SHIELD DIAMETER	PU
HSKB-F 16-35	1012-021	16-35 mm	5
HSKB-F 35-65	1012-022	35-65 mm	5



Shield clamp with integrated strain relief

PRODUCT DESCRIPTION

The shield clamp with integrated strain relief is suitable for contacting cable shields, which are returned over the cable coating and are locked by a shrinking tube and a conducting metal strip. By simply pushing the stripped cable in the shield clamp, there is a permanently high and continuous spring pressure on the cable shield. The contact areas are large, assuring a very good derivation of interference current. The strain relief is realized by incurved spikes.

ADVANTAGES

- // integrated strain relief
- // permanently high and continuous spring pressure on the cable shield
- // essential higher clamping force
- // high conductivity
- // very good derivation of high-frequency interferences

TECHNICAL DATA

Material: galvanised spring steel

SHIELD CLAMP WITH INTEGRATED STRAIN RELIEF

ITEM DESCRIPTION	ORDER NO.	SHIELD DIAMETER	PU
HSKZ 11-18	1014-005	11-18 mm, 2 x 3.1 mm boring	25



Shield clamp with strain relief on clip foot

PRODUCT DESCRIPTION

The shield clamp with integrated strain relief on clip foot can be snapped onto 35 mm Din rails without tools.

The cable shield should be turned back over the cable coating and be secured by a shrinking tube and a conducting metal strip.

By simply pushing the stripped cable in the shield clamp, a permanently high and continuous spring pressure on the cable shield ensures a safe contact. The strain relief is realized by incurved spikes.

ADVANTAGES

- // tool-free assembly on 35 mm Din rail
- // integrated strain relief
- // permanently high and continuous spring pressure on the cable shield
- // essential higher clamping force
- // high conductivity
- // very good derivation of high-frequency interferences

TECHNICAL DATA

Material: galvanised spring steel

SHIELD CLAMP WITH STRAIN RELIEF ON CLIP FOOT			
ITEM DESCRIPTION	ORDER NO.	SHIELD DIAMETER	PU
SKZH 11-18	1031-025	11-18 mm	10



HEBOCLIP with clip foot

PRODUCT DESCRIPTION

The HEBOCLIP for 35 mm DIN rails serves as a universal carrier for shield clamps with a clamp diameter of 1.5 mm to 30 mm.

Simply snap the clip foot onto the rail, snap the chosen shield clamp into place and push the cable shield into the shield clamp. The alternative, using a strain relief bracket, provides the possibility of assembling with the help of a cable tie.

ADVANTAGES

- // tool-free assembly on 35 mm DIN rails
- // universal bracket for shield clamps with a clamping range of 1.5 mm to 30 mm

- // fewer stock items needed
- // strain relief with cable tie with HHZ-2

TECHNICAL DATA

Material: galvanised spring steel, nickle-plated spring steel

ACCESSORIES

- // Shield clamp
- // Shield clamp Multi

HEBOCLIP WITH CLIP FOOT

ITEM DESCRIPTION	ORDER NO.	DETAILED DESCRIPTION	PU
HHZ-2	1020-020	with strain relief	10
HH-2	1020-021	without strain relief	10



Shield clamp on clip foot

PRODUCT DESCRIPTION

The shield clamp on clip foot can be snapped onto a 35 mm DIN rail without the use of tools. Just press the cable shield into the shield clamp to achieve a safe contact.

ADVANTAGES

- // easy, tool-free assembly
- // constant contact with cable shield due to spring pressure

// excellent conductance of high-frequency interferences

TECHNICAL DATA

Material: galvanised spring steel, nickle-plated spring steel

SHIELD CLAMP ON CLIP FOOT			
ITEM DESCRIPTION	ORDER NO.	SHIELD DIAMETER	PU
SKH 1,5–3	1030-001	1,5–3 mm	10
SKH 3–6	1030-002	3–6 mm	10
SKH 6–8	1030-003	6–8 mm	10
SKH 8–11	1030-004	8–11 mm	10
SKH 11–16	1030-005	11–16 mm	10
SKH 17–30	1030-006	17–30 mm	10
SKH 3–12	1030-011	3–12 mm, Shield clamp Multi	10
SKH 7–18	1030-012	7–18 mm, Shield clamp Multi	10



Shield clamp on clip foot with strain relief

PRODUCT DESCRIPTION

The shield clamp on clip foot can be snapped onto a 35 mm DIN rail without the use of tools. Just press the cable shield into the shield clamp to achieve a safe contact. The strain relief provides the possibility of reducing strain on the cable sheath by using a cable tie.

ADVANTAGES

- // easy, tool-free assembly
- // constant contact with cable shield due to spring pressure

- // excellent conductance of high-frequency interferences
- // strain relief by using a cable tie on the cable sheath

TECHNICAL DATA

Material: galvanised spring steel, nickle-plated spring steel

SHIELD CLAMP ON CLIP FOOT WITH STRAIN RELIEF

ITEM DESCRIPTION	ORDER NO.	SHIELD DIAMETER	PU
SKHZ 1,5-3	1031-001	1,5-3 mm	10
SKHZ 3-6	1031-002	3-6 mm	10
SKHZ 6-8	1031-003	6-8 mm	10
SKHZ 8-11	1031-004	8-11 mm	10
SKHZ 11-16	1031-005	11-16 mm	10
SKHZ 17-30	1031-006	17-30 mm	10
SKHZ 3-12	1031-011	3-12 mm, Shield clamp Multi	10
SKHZ 7-18	1031-012	7-18 mm, Shield clamp Multi	10



Shield clamp with double-sided strain relief

PRODUCT DESCRIPTION

The shield clamp on clip foot can be snapped onto 35 mm DIN rail without tools. Just press the cable into the shield clamp to achieve a safe contact.

The double-sided strain relief provides the particularly safe possibility of reducing strain on both sides of the cable sheath by using cable ties.

ADVANTAGES

// tool-free assembly on 35 mm Din rail

// constant contact with cable shield due to spring pressure

// excellent conductance of high-frequency interferences

// strain relief on both sides of the cable shield by using cable ties

TECHNICAL DATA

Material: galvanised spring steel

SHIELD CALMP WITH DOUBLE-SIDED STRAIN RELIEF			
ITEM DESCRIPTION	ORDER NO.	SHIELD DIAMETER	PU
SKHZZ 1,5-3	1032-001	1,5-3 mm	10
SKHZZ 3-6	1032-002	3-6 mm	10
SKHZZ 6-8	1032-003	6-8 mm	10
SKHZZ 8-11	1032-004	8-11 mm	10
SKHZZ 11-16	1032-005	11-16 mm	10
SKHZZ 17-30	1032-006	17-30 mm	10
SKHZZ 3-12	1032-011	3-12 mm	10
SKHZZ 7-18	1032-012	7-18 mm	10



HEBOCLIP for busbar

PRODUCT DESCRIPTION

The HEBOCLIP for busbar serves as a universal carrier for shield clamps with a clamp diameter of 1.5 mm to 16 mm.

Simply snap on the 10 x 3 mm busbar and then lock the appropriate shield clamp into place. Push the cable shield into the shield clamp.

The 10 x 1.5 mm type can be used to snap directly onto casing parts with a material thickness of 1.5 mm.

ADVANTAGES

- // tool-free assembly on 10 x 3 mm busbars
- // 10 x 1.5 mm design to be used e.g. for busbars, integrated within a casing box

- // for shield clamps with a clamping range of 1.5 to 16 mm
- // smaller range of items due to the variable mounting combinations
- // fewer stock items needed
- // very compact design
- // strain relief with cable tie using the HSZ

TECHNICAL DATA

Material: galvanised spring steel

ACCESSORIES

- // Shield clamp
- // Shield clamp Multi
- // HEBOSET set of assorted fittings
- // Busbar 10 x 3 x 1.000mm

HEBOCLIP FOR BUSBAR

ITEM DESCRIPTION	ORDER NO.	DETAILED DESCRIPTION	PU
HSZ 3	1024-001	for busbar 10 x 3, with strain relief	10
HSZ 1,5	1024-002	for busbar 10 x 1.5, with strain relief	10
HS 3	1024-011	for busbar 10 x 3, without strain relief	10
HS 1,5	1024-012	for busbar 10 x 1.5, without strain relief	10
Busbar 10 x 3	1046-001	length 1.000 mm	5



HEBOCLIP Uno for busbar or sheet edge

PRODUCT DESCRIPTION

Snap the HEBOCLIP Uno into place on the 10 x 3 mm busbar or sheet edge and push the cable shield into the shield clamp. A secure hold is achieved because of the special profile.

The clip is also available for 10 x 1.5 mm busbars or varying sheet thickness.

ADVANTAGES

- // tool-free assembly on 10 x 3 mm busbar or sheet metal edging
- // extremely compact design

- // strain relief using the HSDZ with cable tie
- // also available for 10 x 1.5 mm busbars
- // additional sizes available on demand

TECHNICAL DATA

Material: galvanised spring steel

ACCESSORIES

- // Busbar 10 x 3 x 1.000mm

HEBOCLIP UNO FOR BUSBAR WITH STRAIN RELIEF

ITEM DESCRIPTION	ORDER NO.	SHIELD DIAMETER	PU
HSEZ 1,5-3	1025-111	1,5-3 mm, with strain relief	10
HSEZ 3-6	1025-112	3-6 mm, with strain relief	10
HSEZ 6-8	1025-113	6-8 mm, with strain relief	10
HSEZ 8-11	1025-114	8-11 mm, with strain relief	10
HSEZ 11-16	1025-115	11-16 mm, with strain relief	10
HSEZ 17-30	1025-116	17-30 mm, with strain relief	10
HSEZ 3-12	1025-118	3-12 mm, with strain relief	10
HSEZ 7-18	1025-119	7-18 mm, with strain relief	10

HEBOCLIP UNO FOR BUSBAR WITHOUT STRAIN RELIEF

ITEM DESCRIPTION	ORDER NO.	SHIELD DIAMETER	PU
HSE 1,5-3	1025-121	1,5-3 mm	10
HSE 3-6	1025-122	3-6 mm	10
HSE 6-8	1025-123	6-8 mm	10
HSE 8-11	1025-124	8-11 mm	10
HSE 11-16	1025-125	11-16 mm	10
HSE 17-30	1025-126	17-30 mm	10
HSE 3-12	1025-128	3-12 mm	10
HSE 7-18	1025-129	7-18 mm	10
Busbar 10 x 3	1046-001	length 1.000 mm	5



HEBOCLIP Duo for busbar or sheet edge

PRODUCT DESCRIPTION

Simply snap the HEBOCLIP Duo for busbar onto the 10 x 3 mm busbar or sheet edge and then push the cable shield into the shield clamp. The special shape offers a secure hold.

By joining several HEBOCLIPs Duo together, an extremely compact support plate for several cables can be assembled.

The clip is also available for 10 x 1.5 mm busbars or sheet edge.

ADVANTAGES

- // tool-free assembly on 10 x 3 mm busbar or sheet edge
- // extremely compact design
- // strain relief with cable tie using the HSDZ
- // also available for 10 x 1.5 mm busbars or sheet edge

TECHNICAL DATA

Material: galvanised spring steel

ACCESSORIES

- // Busbar 10 x 3 x 1.000mm

HEBOCLIP DUO FOR BUSBAR WITH STRAIN RELIEF

ITEM DESCRIPTION	ORDER NO.	SHIELD DIAMETER	PU
HSDZ 1.5-3	1025-011	1.5 - 3 mm, with strain relief	10
HSDZ 3-6	1025-012	3-6 mm, with strain relief	10
HSDZ 6-8	1025-013	6-8 mm, with strain relief	10
HSDZ 3-12	1025-014	3-12 mm, with strain relief	10

HEBOCLIP DUO FOR BUSBAR WITHOUT STRAIN RELIEF

ITEM DESCRIPTION	ORDER NO.	SHIELD DIAMETER	PU
HSD 1.5-3	1025-021	1.5-3 mm	10
HSD 3-6	1025-022	3-6 mm	10
HSD 6-8	1025-023	6-8 mm	10
HSD 3-12	1025-024	3-12 mm	10
Busbar 10 x 3	1046-001	length 1.000 mm	5



HEBOCLIP for direct assembly

PRODUCT DESCRIPTION

The HEBOCLIP for direct assembly serves as a universal carrier for shield clamps with a clamp diameter of 1.5 mm to 30 mm.

For example, it can be screwed directly onto the mounting plate. Snap the chosen shield clamp into the clip and push the cable shield into the shield clamp.

ADVANTAGES

- // direct assembly with an M4 or M5 screw
- // universal bracket for shield clamps with a clamping range of 1.5 mm to 30 mm

- // smaller range of items due to the variable mounting combinations
- // fewer stock items needed
- // very compact design
- // strain relief with cable tie with HDZ

TECHNICAL DATA

Material: galvanised spring steel

ACCESSORIES

- // Shield clamp
- // Shield clamp Multi
- // HEBOSET set of assorted fittings

HEBOCLIP FOR DIRECT ASSEMBLY			
ITEM DESCRIPTION	ORDER NO.	DETAILED DESCRIPTION	PU
HDZ 4	1022-001	boring for M4, with strain relief	10
HDZ 5	1022-002	boring for M5, with strain relief	10
HD 4	1022-021	boring for M4, without strain relief	10
HD 5	1022-022	boring for M5, without strain relief	10



Shield clamp with open slotted hole

PRODUCT DESCRIPTION

The shield clamp with open slotted hole can be screwed directly, for example, onto the mounting plate. The open slotted hole of the SKDL is simply pushed under the screw which then is tightened. Simply push the cable shield into the shield clamp in order to achieve secure contact.

ADVANTAGES

- // direct assembly with an M4 screw
- // easy to mount and loosen due to open slotted hole
- // mounting onto C-rail with a mounting adapter as an accessory part

// very compact design

- // small range of items due to the shield clamp Multi
- // strain relief by using a cable tie on the cable sheath
- // additional sizes available on demand

TECHNICAL DATA

Material: galvanised spring steel

ACCESSORIES

- // Mounting adapter for C-rails

SHIELD CLAMP FOR DIRECT MOUNTING WITH OPEN SLOTTED HOLE

ITEM DESCRIPTION	ORDER NO.	SHIELD DIAMETER	PU
SKDL 3-12	1022-511	3-12 mm	10
SKDL 7-18	1022-512	7-18 mm	10
SKDL 17-30	1022-516	17-30 mm	10

SHIELD CLAMP FOR DIRECT MOUNTING WITH OPEN SLOTTED HOLE AND STRAIN RELIEF

ITEM DESCRIPTION	ORDER NO.	SHIELD DIAMETER	PU
SKDLZ 3-12	1022-531	3-12 mm	10
SKDLZ 7-18	1022-532	7-18 mm	10
SKDLZ 17-30	1022-536	17-30 mm	10



Shield clamp for direct assembly

PRODUCT DESCRIPTION

The shield clamp for direct assembly can be screwed directly, for example, onto the mounting plate. Simply push the cable shield into shield clamp in order to achieve secure contact.

// very compact design

// small range of items due to the shield clamp Multi

TECHNICAL DATA

Material: galvanised spring steel

ADVANTAGES

// direct assembly with an M4 or M5 screw

// mounting onto a C-rail with a mounting adapter as an accessory part

ACCESSORIES

// Mounting adapter for C-rails

SHIELD CLAMP FOR DIRECT ASSEMBLY			
ITEM DESCRIPTION	ORDER NO.	DETAILED DESCRIPTION	PU
SKD 4 1,5–3	1022-301	M4, shield diameter 1,5–3 mm	10
SKD 4 3–6	1022-302	M4, shield diameter 3–6 mm	10
SKD 4 6–8	1022-303	M4, shield diameter 6–8 mm	10
SKD 4 8–11	1022-304	M4, shield diameter 8–11 mm	10
SKD 4 11–16	1022-305	M4, shield diameter 11–16 mm	10
SKD 4 17–30	1022-306	M4, shield diameter 17–30 mm	10
SKD 4 3–12	1022-311	M4, shield diameter 3–12 mm	10
SKD 4 7–18	1022-312	M4, shield diameter 7–18 mm	10
SKD 5 1,5–3	1022-321	M5, shield diameter 1,5–3 mm	10
SKD 5 3–6	1022-322	M5, shield diameter 3–6 mm	10
SKD 5 6–8	1022-323	M5, shield diameter 6–8 mm	10
SKD 5 8–11	1022-324	M5, shield diameter 8–11 mm	10
SKD 5 11–16	1022-325	M5, shield diameter 11–16 mm	10
SKD 5 17–30	1022-326	M5, shield diameter 17–30 mm	10
SKD 5 3–12	1022-331	M5, shield diameter 3–12 mm	10
SKD 5 7–18	1022-332	M5, shield diameter 7–18 mm	10
C16/4 SKD	3011-210	Mounting adapter for C-rail, M4	10



Shield clamp for direct assembly with strain relief

PRODUCT DESCRIPTION

The shield clamp for direct assembly can be screwed directly, for example, onto the mounting plate. Simply push the cable shield into the shield clamp in order to achieve secure contact.

The strain relief clamp offers the possibility of reducing strain on the cable sheath by using a cable binder.

ADVANTAGES

- // direct assembly with an M4 or M5 screw
- // mounting onto a C-rail with a mounting adapter as an accessory part

// very compact design

// small range of items due to the shield clamp Multi

// strain relief by using a cable tie on the cable sheath

TECHNICAL DATA

Material: galvanised spring steel

ACCESSORIES

// Mounting adapter for C-rails

SHIELD CLAMP FOR DIRECT ASSEMBLY WITH STRAIN RELIEF

ITEM DESCRIPTION	ORDER NO.	DETAILED DESCRIPTION	PU
SKDZ 4 1,5-3	1022-201	M4, shield diameter 1,5-3 mm	10
SKDZ 4 3-6	1022-202	M4, shield diameter 3-6 mm	10
SKDZ 4 6-8	1022-203	M4, shield diameter 6-8 mm	10
SKDZ 4 8-11	1022-204	M4, shield diameter 8-11 mm	10
SKDZ 4 11-16	1022-205	M4, shield diameter 11-16 mm	10
SKDZ 4 17-30	1022-206	M4, shield diameter 17-30 mm	10
SKDZ 4 3-12	1022-211	M4, shield diameter 3-12 mm	10
SKDZ 4 7-18	1022-212	M4, shield diameter 7-18 mm	10
SKDZ 5 1,5-3	1022-221	M5, shield diameter 1,5-3 mm	10
SKDZ 5 3-6	1022-222	M5, shield diameter 3-6 mm	10
SKDZ 5 6-8	1022-223	M5, shield diameter 6-8 mm	10
SKDZ 5 8-11	1022-224	M5, shield diameter 8-11 mm	10
SKDZ 5 11-16	1022-225	M5, shield diameter 11-16 mm	10
SKDZ 5 17-30	1022-226	M5, shield diameter 17-30 mm	10
SKDZ 5 3-12	1022-231	M5, shield diameter 3-12 mm	10
SKDZ 5 7-18	1022-232	M5, shield diameter 7-18 mm	10
C16/4 SKD	3011-210	Mounting adapter for C-rail, M4	10

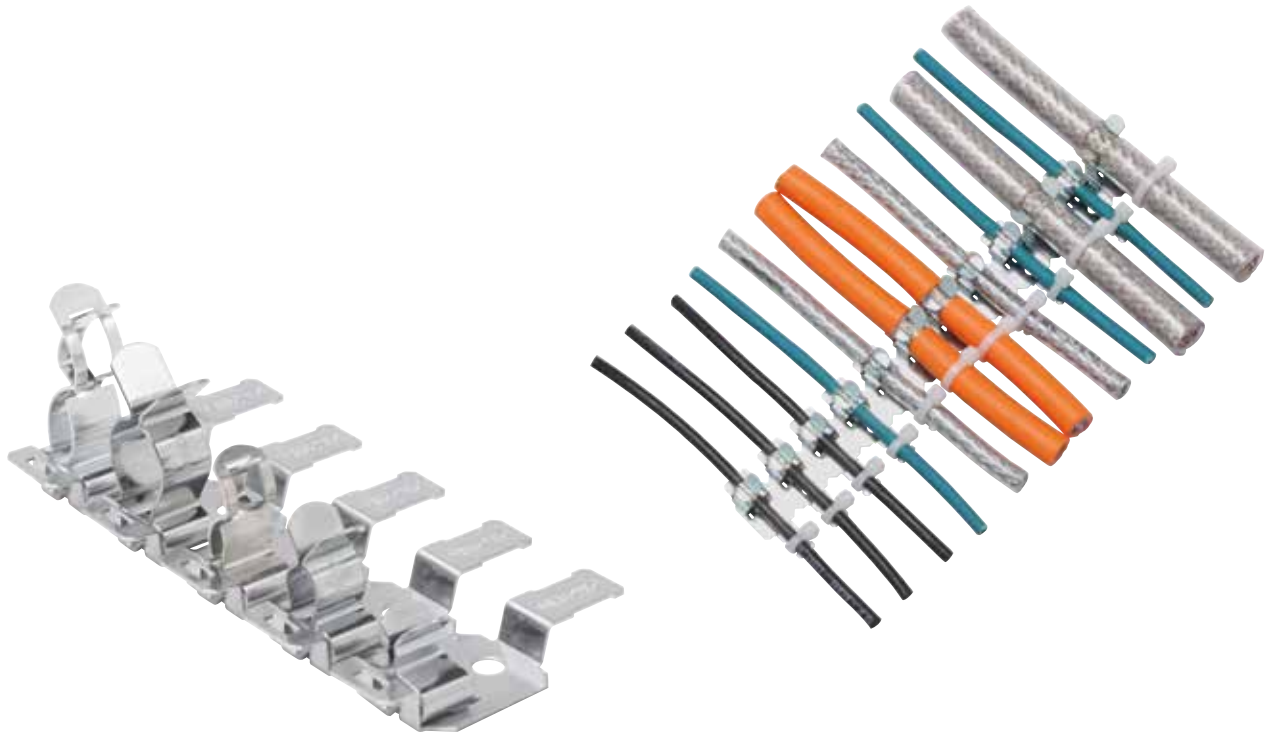

HEBOCLIP clamp assembly with strain relief

PRODUCT DESCRIPTION

The HEBOCLIP clamp assembly for direct mounting serves as a universal carrier for up to 12 shield clamps with a clamp diameter of 1.5 mm to 16 mm. The clamp assembly can be shortened to the required amount by breaking unwanted clips off at the predetermined breaking points. It is then attached using screws.

ADVANTAGES

- // connects up to 12 shield clamps per clamp assembly
- // space-saving assembly on the mounting plate
- // universal carrier for shield clamps with a clamping range of 1.5 mm to 16 mm

- // breaking points allow an adaptation to the required number of cables
- // fewer stock items needed
- // very compact design
- // strain relief with cable tie

TECHNICAL DATA

Material: galvanised spring steel

ACCESSORIES

- // Shield clamp
- // Shield clamp Multi
- // HEBOSET set of assorted fittings

HEBOCLIP CLAMP ASSEMBLY WITH STRAIN RELIEF

ITEM DESCRIPTION	ORDER NO.	DETAILED DESCRIPTION	PU
HRDZ 4	1040-001	boring for M4, with strain relief	5
HRDZ 5	1040-002	boring for M5, with strain relief	5



HEBOCLIP with strain relief for perforated plate

PRODUCT DESCRIPTION

The HEBOCLIP for perforated plate serves as a universal carrier for shield clamps ranging from a diameter of 1.5 mm to 30 mm.

It can be snapped onto existing perforated plates with a material thickness of 1.5 mm to 3 mm without the use of tools. Simply snap the adequate shield clamp onto the clip and push the cable shield into place.

ADVANTAGES

- // tool-free assembly on the perforated plate
- // universal carrier for shield clamps with clamping ranges from 1.5 mm to 30 mm

- // fewer stock items
- // extremely compact design
- // strain relief by using a cable tie on the cable sheath

TECHNICAL DATA

Material: galvanised spring steel

ACCESSORIES

- // Shield clamp
- // Shield clamp Multi
- // HEBOSET set of assorted fittings

HEBOCLIP WITH STRAIN RELIEF FOR PERFORATED PLATE

ITEM DESCRIPTION	ORDER NO.	DETAILED DESCRIPTION	PU
HLZ 8/12	1035-024	for perforations 8 x 8 mm, web mesh 4 mm, hole spacing 28 mm	10
HLZ 8/10	1035-022	for perforations 8 x 8 mm, web mesh 2 mm, hole spacing 42 mm	10



Shield clamp for perforated plate with strain relief

PRODUCT DESCRIPTION

The shield clamp for perforated plate can be snapped onto existing perforated plates with a material thickness of 1.5 mm to 3 mm and a perforation of 8 x 8 mm without the use of tools.

To assure safe contact, the cable shield simply has to be pushed into the shield clamp.

The strain relief provides the possibility of strain relief of the cable sheath by using a cable tie.

ADVANTAGES

- // tool-free assembly on the perforated plate
- // wide clamping range
- // fewer stock items
- // extremely compact design
- // strain relief by using a cable binder on the cable sheath

TECHNICAL DATA

Material: galvanised spring steel

SHIELD CLAMP FOR PERFORATED PLATE WITH STRAIN RELIEF			
ITEM DESCRIPTION	ORDER NO.	DETAILED DESCRIPTION	PU
SKLZ 8/12 3-12	1035-042	for shield diameter 3-12 mm, hole spacing 28 mm	10
SKLZ 8/12 7-18	1035-044	for shield diameter 7-18 mm, hole spacing 28 mm	10
SKLZ 8/12 17-30	1035-046	for shield diameter 17-30 mm, hole spacing 28 mm	10
SKLZ 8/10 3-12	1035-052	for shield diameter 3-12 mm, hole spacing 42 mm	10
SKLZ 8/10 7-18	1035-054	for shield diameter 7-18 mm, hole spacing 42 mm	10
SKLZ 8/10 17-30	1035-056	for shield diameter 17-30 mm, hole spacing 42 mm	10



Shield clamp with mounting adapter for C-rails

PRODUCT DESCRIPTION

The shield clamp for C-rails can be assembled with a 90° turn into C-rail profiles with a 16 mm slot. With the assistance of the M4-fastening screw the mounting adapter is pinched into the C-rail. Simply push the cable shield into shield clamp in order to achieve secure contact. The strain relief provides the possibility of reducing strain on the cable sheath by using a cable tie.

ADVANTAGES

- // small range of items due to the Shield clamp Multi
- // strain relief by using a cable tie on the cable sheath
- // very compact design

TECHNICAL DATA

Material: galvanised spring steel

SHIELD CLAMP WITH MOUNTING ADAPTER FOR C-RAILS

ITEM DESCRIPTION	ORDER NO.	DETAILED DESCRIPTION	PU
SKDZ 4 1,5-3 C16	1037-001	M4, shield diameter 1,5-3 mm	10
SKDZ 4 3-6 C16	1037-002	M4, shield diameter 3-6 mm	10
SKDZ 4 6-8 C16	1037-003	M4, shield diameter 6-8 mm	10
SKDZ 4 8-11 C16	1037-004	M4, shield diameter 8-11 mm	10
SKDZ 4 11-16 C16	1037-005	M4, shield diameter 11-16 mm	10
SKDZ 4 17-30 C16	1037-006	M4, shield diameter 17-30 mm	10
SKDZ 4 3-12 C16	1037-011	M4, shield diameter 3-12 mm	10
SKDZ 4 7-18 C16	1037-012	M4, shield diameter 7-18 mm	10

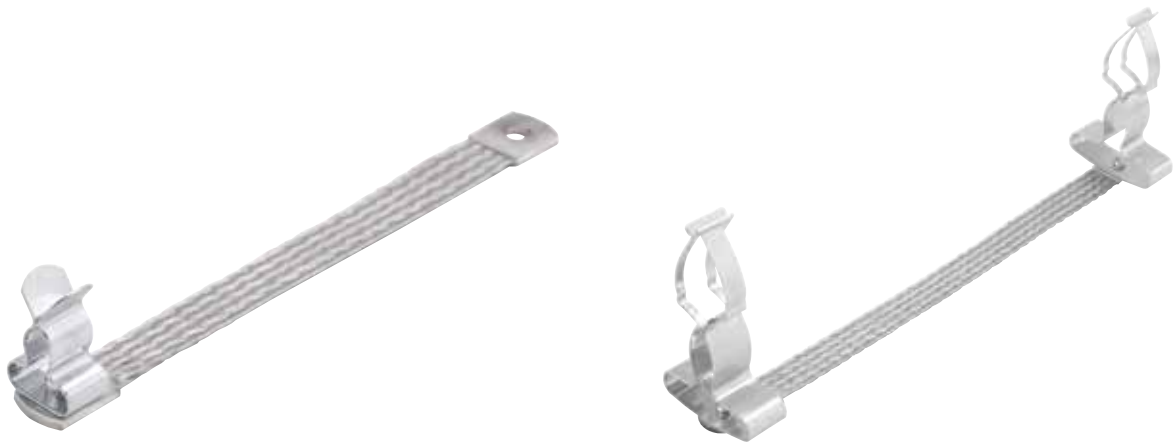

Shield clamp riveted on earthing tape

PRODUCT DESCRIPTION

The shield clamp riveted on earthing tape allows an excellent large contact of cable shields and derivation of interference currents via a flexible earthing tape.

The shield clamp is fixed on the cable shield due to its great clamping force and optimally adapts to the cable routing. Optionally, the shield clamp can be secured with cable tie by a strain relief bar.

Optimal solutions can not always be achieved with standardized shield connections.

We will gladly find the perfect solution for you. With us you can freely choose the shield clamp and earthing tape in length, cross section and hole diameter.

ADVANTAGES

- // technical and economical optimally adapted to your requirements
- // for small and large quantities
- // flexible earth connection

SHIELD CLAMP RIVETED ON EARTHING TAPE			
ITEM DESCRIPTION	ORDER-NO.	DETAILED DESCRIPTION	PU
HSKM 3-12 FE 06 100 06	1010-133	shield diameter 3–12 mm, 6 mm ² , 100 mm, M6	10
HSKM 7-18 FE 10 200 08	1010-134	shield diameter 7–18 mm, 10 mm ² , 200 mm, M8	10
HSK XX-XX FE XX XXX XX	XXXX-XXX	freely selectable	50



HEBOSET Set of assorted fittings

PRODUCT DESCRIPTION

With HEBOSET you always have the right shield clamp and carrier at hand. We would be pleased to provide a special assortment to fit your specific needs.

// all-purpose usage

// set box in sturdy workshop design

// set box individually filled to reflect your requirements

CONTENT HEBOSET SMALL

// 15 x shield clamp HSK 1.5–3

// 15 x shield clamp HSK 3–6

// 15 x shield clamp HSK 6–8

// 15 x shield clamp HSK 8–11

// 5 x shield clamp HSKM 3–12

// 5 x shield clamp HSKM 7–18

// 10 x HEBOCLIP with clip foot HHZ-2

// 10 x HEBOCLIP for direct mounting HDZ 4

// 10 x HEBOCLIP for busbar HSZ 3

// 3 x HEBOCLIP clamp assembly for direct mounting HRDZ 4

// 3 x HEBOCLIP Duo 3–6

// 3 x HEBOCLIP Duo 6–8

CONTENT HEBOSET BIG

// 25 x shield clamp HSK 1.5–3

// 25 x shield clamp HSK 3–6

// 25 x shield clamp HSK 6–8

// 25 x shield clamp HSK 8–11

// 15 x shield clamp HSK 11–16

// 20 x shield clamp HSKM 3–12

// 10 x shield clamp HSKM 7–18

// 10 x HEBOCLIP with clip foot HHZ-2

// 20 x HEBOCLIP for direct mounting HDZ 4

// 20 x HEBOCLIP for busbar HSZ 3

// 3 x HEBOCLIP clamp assembly for direct mounting HRDZ 4

// 5 x HEBOCLIP Duo 1,5–3

// 5 x HEBOCLIP Duo 3–6

// 5 x HEBOCLIP Duo 6–8

// 3 x HEBOCLIP Duo 3–12

ADVANTAGES

// all parts are clearly arranged

HEBOSET SET OF ASSORTED FITTINGS

ITEM DESCRIPTION	ORDER NO.	PU
HEBOSET small	1029-001	1
HEBOSET big	1029-002	1
HEBOSET customised	1029-xxx	3



Customised shield connections

PRODUCT DESCRIPTION

Standard shield connections often do not provide ideal solutions.

We are able to present practical assembly solutions for all requirements. Such an offer would be according to your demand, even in small quantities, without you having to waive the proven advantages of the HEBOCLIP-system.

EXAMPLES

Picture 1:

This shield clamp is being pressed onto the cable shield and remains stable due to the high clamping force. A short earth connection can be constructed using a braided wire to the pre-assembled crimp connection.

Picture 2:

The shield clamp on mounting bracket is used for the assembly on a 4 mm stud bolt on a control panel door. A second possibility is a cable holder affixed with a bolt-setting tool directly onto a steel construction.

Picture 3:

Shield clamp with HEBOCLIP and special surface coating.

Picture 4:

This shield connection is fixed with the multi-purpose clamp onto a cylindrical component. The cable shield of a sensor cable will make contact with the shield clamp.

Picture 5:

The shield clamps mounted on a sheet metal mounting bracket enables an ideal adaptation to the mechanical measurements.

Picture 6:

This picture shows the HEBOCLIP-System mounted on a shielding plate for 24-pin connection plates. The HEBOCLIPs can be equipped with shield clamps according to specific requirements.

Picture 7:

The Shield clamp Multi used in this shield plate enables particularly flexible assembly.

Picture 8:

Specially developed bracket for mounting profiles equipped with the HEBOCLIP system.

ADVANTAGES

- // technically and economically ideal solutions, made according to your demands
- // for small and large scale production series



5



4



6



7



8



Earthing tapes

PRODUCT DESCRIPTION

Earthing tapes made of flexible copper conductors with seamless pressed sleeves and holes for metric screws.

- // lowest contact resistance
- // high tensile strength and durability
- // a huge variety of earthing tapes with different lengths, cross sections and holes
- // special sizes upon request

ADVANTAGES

- // seamless pressed sleeves
- // the best conduction of high-frequency interference

TECHNICAL DATA

Material: tin-coated copper

EARTHING TAPE			
ITEM DESCRIPTION	ORDER NO.	DETAILED DESCRIPTION	PU
Earthing tape	5-KT004010004	4 mm ² , 100 mm, M4	10
Earthing tape	5-KT006010004	6 mm ² , 100 mm, M4	10
Earthing tape	5-KT006010006	6 mm ² , 100 mm, M6	10
Earthing tape	5-KT006012006	6 mm ² , 120 mm, M6	10
Earthing tape	5-KT006015006	6 mm ² , 150 mm, M6	10
Earthing tape	5-KT006020004	6 mm ² , 200 mm, M4	10
Earthing tape	5-KT006020006	6 mm ² , 200 mm, M6	10
Earthing tape	5-KT006030006	6 mm ² , 300 mm, M6	10
Earthing tape	5-KT006035006	6 mm ² , 350 mm, M6	10
Earthing tape	5-KT006040006	6 mm ² , 400 mm, M6	10
Earthing tape	5-KT006050006	6 mm ² , 500 mm, M6	10
Earthing tape	5-KT006060006	6 mm ² , 600 mm, M6	10
Earthing tape	5-KT010010006	10 mm ² , 100 mm, M6	10
Earthing tape	5-KT010010008	10 mm ² , 100 mm, M8	10
Earthing tape	5-KT010015006	10 mm ² , 150 mm, M6	10
Earthing tape	5-KT010015008	10 mm ² , 150 mm, M8	10
Earthing tape	5-KT010020006	10 mm ² , 200 mm, M6	10
Earthing tape	5-KT010020008	10 mm ² , 200 mm, M8	10
Earthing tape	5-KT01002000608	10 mm ² , 200 mm, M6–M8	10
Earthing tape	5-KT010025006	10 mm ² , 250 mm, M6	10
Earthing tape	5-KT010030006	10 mm ² , 300 mm, M6	10
Earthing tape	5-KT010030008	10 mm ² , 300 mm, M8	10
Earthing tape	5-KT01003000608	10 mm ² , 300 mm, M6–M8	10
Earthing tape	5-KT010035006	10 mm ² , 350 mm, M6	10
Earthing tape	5-KT010040006	10 mm ² , 400 mm, M6	10
Earthing tape	5-KT010040008	10 mm ² , 400 mm, M8	10

EARTHING TAPE			
ITEM DESCRIPTION	ORDER NO.	DETAILED DESCRIPTION	PU
Earthing tape	5-KT010050006	10 mm ² , 500 mm, M6	10
Earthing tape	5-KT010050008	10 mm ² , 500 mm, M8	10
Earthing tape	5-KT010060006	10 mm ² , 600 mm, M6	10
Earthing tape	5-KT016010006	16 mm ² , 100 mm, M6	10
Earthing tape	5-KT016010008	16 mm ² , 100 mm, M8	10
Earthing tape	5-KT016015006	16 mm ² , 150 mm, M6	10
Earthing tape	5-KT016015008	16 mm ² , 150 mm, M8	10
Earthing tape	5-KT01601500608	16 mm ² , 150 mm, M6–M8	10
Earthing tape	5-KT016020006	16 mm ² , 200 mm, M6	10
Earthing tape	5-KT016020008	16 mm ² , 200 mm, M8	10
Earthing tape	5-KT01602000608	16 mm ² , 200 mm, M6–M8	10
Earthing tape	5-KT016025008	16 mm ² , 250 mm, M8	10
Earthing tape	5-KT016030006	16 mm ² , 300 mm, M6	10
Earthing tape	5-KT016030008	16 mm ² , 300 mm, M8	10
Earthing tape	5-KT01603000608	16 mm ² , 300 mm, M6–M8	10
Earthing tape	5-KT016035008	16 mm ² , 350 mm, M8	10
Earthing tape	5-KT016040006	16 mm ² , 400 mm, M6	10
Earthing tape	5-KT016040008	16 mm ² , 400 mm, M8	10
Earthing tape	5-KT016050006	16 mm ² , 500 mm, M6	10
Earthing tape	5-KT016050008	16 mm ² , 500 mm, M8	10
Earthing tape	5-KT016060008	16 mm ² , 600 mm, M8	10
Earthing tape	5-KT016080008	16 mm ² , 800 mm, M8	10
Earthing tape	5-KT016150008	16 mm ² , 1,500 mm, M8	10
Earthing tape	5-KT025010008	25 mm ² , 100 mm, M8	10
Earthing tape	5-KT025010010	25 mm ² , 100 mm, M10	10
Earthing tape	5-KT025015008	25 mm ² , 150 mm, M8	10
Earthing tape	5-KT025015010	25 mm ² , 150 mm, M10	10
Earthing tape	5-KT025020006	25 mm ² , 200 mm, M6	10
Earthing tape	5-KT025020008	25 mm ² , 200 mm, M8	10
Earthing tape	5-KT025020010	25 mm ² , 200 mm, M10	10
Earthing tape	5-KT025025008	25 mm ² , 250 mm, M8	10
Earthing tape	5-KT025025010	25 mm ² , 250 mm, M10	10
Earthing tape	5-KT025030008	25 mm ² , 300 mm, M8	10
Earthing tape	5-KT025030010	25 mm ² , 300 mm, M10	10
Earthing tape	5-KT025030012	25 mm ² , 300 mm, M12	10
Earthing tape	5-KT025035010	25 mm ² , 350 mm, M10	10
Earthing tape	5-KT025040006	25 mm ² , 400 mm, M6	10
Earthing tape	5-KT025040008	25 mm ² , 400 mm, M8	10
Earthing tape	5-KT025040010	25 mm ² , 400 mm, M10	10
Earthing tape	5-KT025050008	25 mm ² , 500 mm, M8	10
Earthing tape	5-KT025060008	25 mm ² , 600 mm, M8	10
Earthing tape	5-KT025070008	25 mm ² , 700 mm, M8	10
Earthing tape	5-KT025100008	25 mm ² , 1,000 mm, M8	10
Earthing tape	5-KT035040008	35 mm ² , 400 mm, M8	10
Earthing tape	5-KT050025010	50 mm ² , 250 mm, M10	10
Earthing tape	5-KT050030008	50 mm ² , 300 mm, M8	10
Earthing tape	5-KT050040008	50 mm ² , 400 mm, M8	10
Earthing tape	5-KT070030010	70 mm ² , 300 mm, M10	10
Earthing tape	5-KT070050010	70 mm ² , 500 mm, M10	10
Earthing tape on reel	5-KO-0040-10	4 mm ² , 50 m	1
Earthing tape on reel	5-KO-0060-10	6 mm ² , 50 m	1
Earthing tape on reel	5-KO-0100-20	10 mm ² , 25 m	1
Earthing tape on reel	5-KO-0160-20	16 mm ² , 25 m	1
Earthing tape on reel	5-KO-0250-20	25 mm ² , 25 m	1

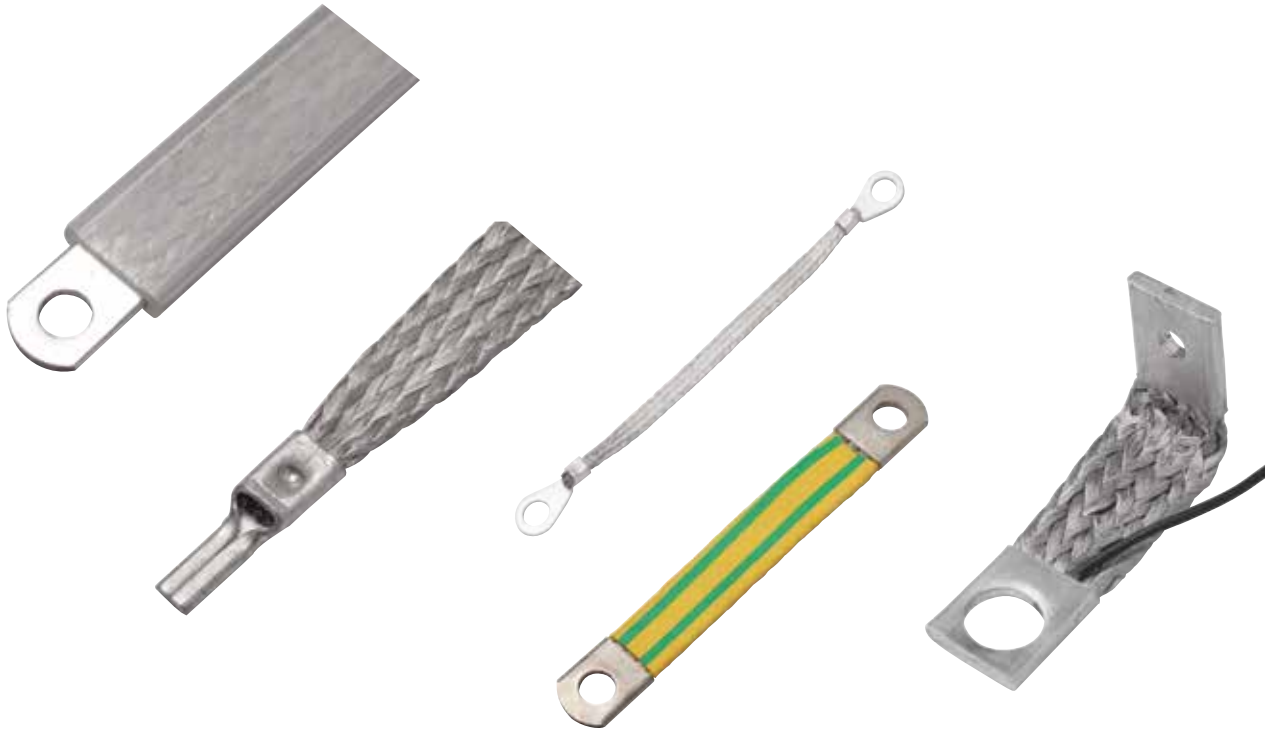

Customised earthing tapes

PRODUCT DESCRIPTION

Standard earthing tapes do not always provide the ideal solution. We are able to offer earthing tapes - even for small batches - which are based on your needs and practical-related requirements.

We can adapt the conducting material, dimensions and contact surface as well as the insulation in order to suit your individual demand.

ADVANTAGES

- // perfect technical and economical adaptations to meet your requirements
- // for small and large batches

TECHNICAL DATA

Materials: blank copper, tin-plated copper, aluminium, stainless steel

Please contact our customer service department with your requests.



Shielding braid

PRODUCT DESCRIPTION

Shielding braid of tin-plated copper wires is perfectly suited to protect pipes and cables from interfering influences from electric fields.

ADVANTAGES

- // high coverage
- // very good shielding effect

TECHNICAL DATA

Material: tin-plated copper
Temperature range: -50 °C up to 200 °C

SHIELDING BRAID			
ITEM DESCRIPTION	ORDER NO.	EXTENDABLE MIN - MAX	PU
Shielding braid	2050-001	6-12 mm	100 m
Shielding braid	2050-002	8-16 mm	100 m
Shielding braid	2050-003	15-30 mm	100 m
Shielding braid	2050-004	24- 48 mm	100 m



HEBOPRESS Cable lugs

PRODUCT DESCRIPTION

HEBOPRESS Cable lugs for use with endless HEBOTEC earthing tape on reel provides a unique way to design the dimensions of earthing tapes individually. With this technology, the optimal properties of flat conductors in terms of electromagnetic compatibility is maintained.

ADVANTAGES

// very good derivation of high-frequency interference currents

// small contact resistance
// production according to your requirements

TECHNICAL DATA

Material: copper ETP tinned

ACCESSORIES

// press inserts and tools
// Earthing tape on reel

HEBOPRESS CABLE LUGS			
ITEM DESCRIPTION	ORDER NO.	DIMENSION	PU
HPK 10-6	2040-011	10 mm ² , M6	10
HPK 10-8	2040-012	10 mm ² , M8	10
HPK 10-10	2040-013	10 mm ² , M10	10
HPK 16-6	2040-001	16 mm ² , M6	10
HPK 16-8	2040-002	16 mm ² , M8	10
HPK 16-10	2040-003	16 mm ² , M10	10
Earthing tape on reel	5-KO-0100-20	10 mm ² , 25 m	1
Earthing tape on reel	5-KO-0160-20	16 mm ² , 25 m	1



HEBOPRESS tools

PRODUCT DESCRIPTION

It is very easy using HEBOPRESS tools to produce individualised earthing tapes.

Both, the hand press and the rechargeable battery press can be equipped with standard inserts, e.g. for circular cable-lugs.

ASSEMBLY INSTRUCTIONS

- // Place inserts into press
- // Cut earthing tape from the reel to desired length
- // Push HEBOPRESS earthing tape cable-lugs onto the terminal of earthing tape
- // Grout HEBOPRESS earthing tape cable-lug

HEBOPRESS TOOLS			
ITEM DESCRIPTION	ORDER NO.	MEASUREMENTS	PU
Press insert 16	2040-032	for 16 mm ²	1
Press insert 10	2040-033	for 10 mm ²	1
Earthing tape scissors	2040-041	for cutting earthing tape to size	1
Hand press	2040-042		1
Rechargeable battery press	2040-043		1



Patch panel for network cabinets, EMC-conform

PRODUCT DESCRIPTION

The Patch panel for network cabinets which conform with the EMC standards is designed for industrial operating conditions. It consists of a 19" distribution panel for 24 x RJ 45 modules. The cable shield is optimally contacted using shield clamps.

The strain relief provide the possibility of individual strain relief of the cable sheath by using a cable tie.

ADVANTAGES

- // EMC-conform
- // tool-free assembly
- // both-sided earth bolt for connection of an earthing tape

// constant contact with cable shield due to spring pressure

// strain relief by using a cable tie on the cable sheath

TECHNICAL DATA

Material: galvanised sheet steel, galvanised spring steel, front surface light grey (RAL 7035), powder-coated

ACCESSORIES

- // Earthing tapes

PATCH PANEL FOR NETWORK CABINETS, EMC-CONFORM

ITEM DESCRIPTION	ORDER NO.	DETAILED DESCRIPTION	PU
Patch panel	1060-001	for 24 x RJ 45 modules	1

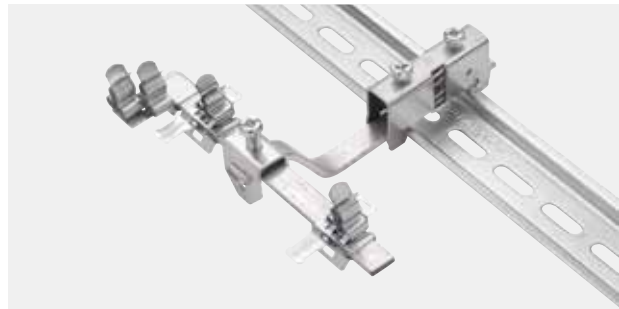
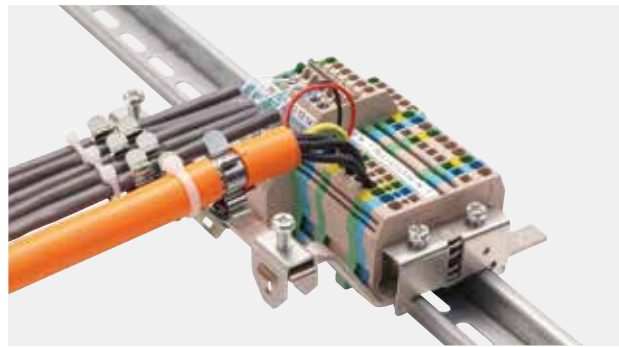
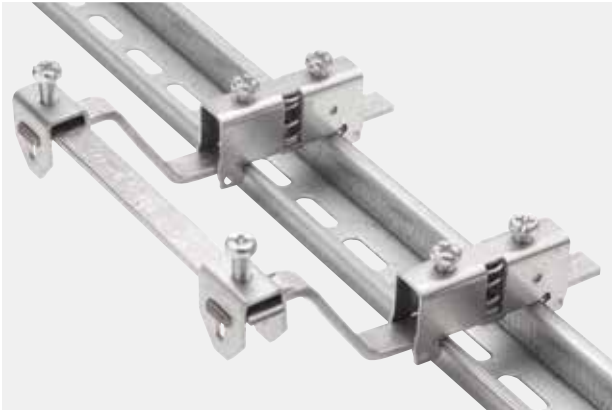

Busbar support for 35 mm DIN rail

PRODUCT DESCRIPTION

A 10 x 3 mm busbar can be assembled variably in regard to height, width as well as the distance from the connections of the devices.

By combining the HEBOCLIPs HS(Z) and HSD(Z) and the shield clamps HSK(M), a great variety of possibilities exists which ensures a constantly excellent conductance of high-frequency interferences.

ADVANTAGES

- // variable assembly regarding to width, height and distance from the connections of the devices
- // use of standard busbars 10 x 3 mm

- // highly flexible
- // high packing density

TECHNICAL DATA

Material: galvanised steel, tin-plated copper

ACCESSORIES

- // HEBOCLIP for busbar
- // HEBOCLIP Uno for busbar
- // HEBOCLIP Duo for busbar
- // Shield clamp
- // Busbar 10 x 3 x 1.000 mm
- // HEBOSET Set of assorted fittings

BUSBAR SUPPORT FOR 35 MM DIN RAIL

ITEM DESCRIPTION	ORDER NO.	DETAILED DESCRIPTION	PU
SH	1092-001	Busbar support	10
SV	1092-002	Busbar connector	10
SSG	1092-003	Busbar, curved, see sketch	10
SSTH-Set	1092-004	set of 2 x SH, 2 x SV, 2 x SSG	1
Busbar 10 x 3	1046-001	length 1.000 mm	5

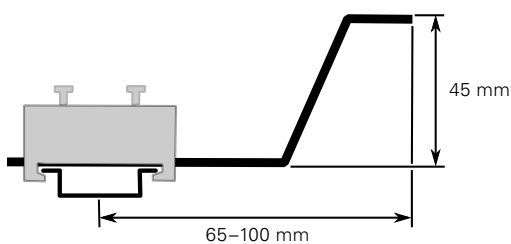

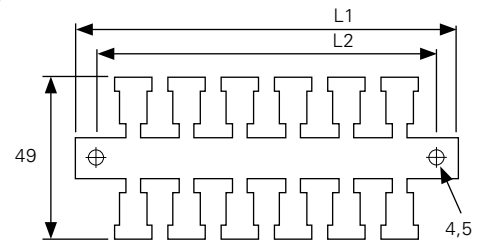
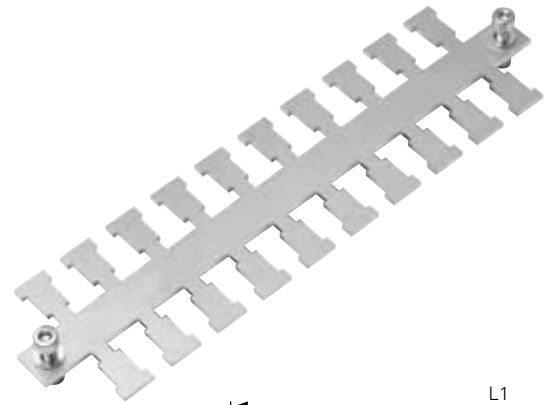
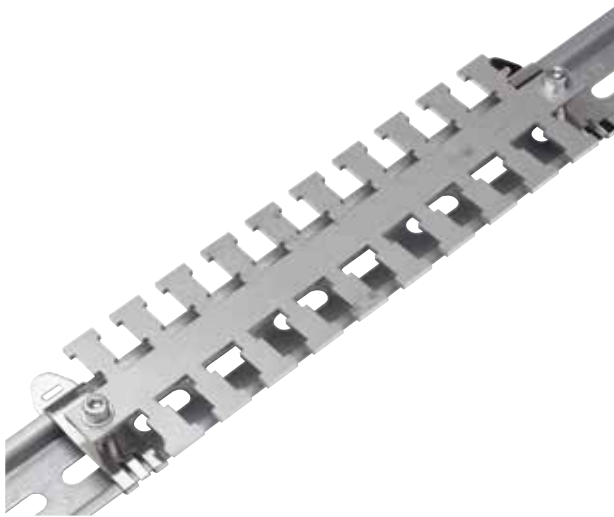

Cable fixing plate

PRODUCT DESCRIPTION

The cable fixing plate KAL is suitable for strain relief through cable ties or hook-and-loop tape and derivation of high-frequency interferences on cable shields. The KAL is available for direct mounting, with distance sleeves or clip feet for 35 mm DIN rails.

TECHNICAL DATA

Material: stainless steel, KAL 59 galvanised steel

ACCESSORIES

- // Clip foot for 35 mm DIN rail, M4
- // Spacer 8 mm with screw M4

CABLE FIXING PLATE

ITEM DESCRIPTION	ORDER NO.	NUMBER OF TEETH	L1	L2	PU
KAL-2	1041-031	2	50.5 mm	37.5 mm	10
KAL-4	1041-032	4	83.5 mm	70.5 mm	10
KAL-6	1041-033	6	116.5 mm	103.5 mm	10
KAL-8	1041-034	8	149.5 mm	136.5 mm	10
KAL-10	1041-035	10	182.5 mm	169.5 mm	10
KAL-29	1041-037	29	494.5 mm	481.5 mm	10
KAL-59	1041-038	59	990.0 mm	978.0 mm	10

CABLE FIXING PLATE ASSEMBLED ON CLIP-FOOT

ITEM DESCRIPTION	ORDER NO.	NUMBER OF TEETH	L1	L2	PU
KAL-SF 2	1041-001	2	50.5 mm	37.5 mm	10
KAL-SF 4	1041-002	4	83.5 mm	70.5 mm	10
KAL-SF 6	1041-003	6	116.5 mm	103.5 mm	10
KAL-SF 8	1041-004	8	149.5 mm	136.5 mm	10
KAL-SF 10	1041-005	10	182.5 mm	169.5 mm	10
Clip foot single	1030-020				25

CABLE FIXING PLATE WITH SPACER AND SCREW M4

ITEM DESCRIPTION	ORDER NO.	NUMBER OF TEETH	L1	L2	PU
KAL-DH 2	1041-010	2	50.5 mm	37.5 mm	10
KAL-DH 4	1041-011	4	83.5 mm	70.5 mm	10
KAL-DH 6	1041-012	6	116.5 mm	103.5 mm	10
KAL-DH 8	1041-013	8	149.5 mm	136.5 mm	10
KAL-DH 10	1041-014	10	182.5 mm	169.5 mm	10
Spacer 8 mm	1041-021				25



Supports for 35 mm DIN rail and busbar

PRODUCT DESCRIPTION

For easy mounting of busbars and 35 mm DIN rails. There are various supports available. To fix with an M6 screw.

ADVANTAGES

- // Depending on the application and installation conditions there are several supports available.
- // The support MSD even allows the assembly of two rails.

TECHNICAL DATA

thread M6
Material: galvanised steel

ACCESSORIES

// Busbar 10 x 3 x 1.000 mm

SUPPORTS FOR 35 MM DIN RAIL AND BUSBAR			
ITEM DESCRIPTION	ORDER NO.	MEASUREMENTS L X W X H	PU
MSA-49	1046-010	80 x 20 x 49 mm	10
MSA-68	1046-011	80 x 20 x 68 mm	10
MSA-88	1046-012	80 x 20 x 88 mm	10
MSB-20	1046-020	80 x 20 x 20 mm	10
MSB-30	1046-021	80 x 20 x 30 mm	10
MSB-50	1046-022	80 x 20 x 50 mm	10
MSB-90	1046-023	80 x 20 x 90 mm	10
MSC-40	1046-030	40 x 18 x 40 mm	10
MSC-53	1046-031	40 x 18 x 53 mm	10
MSD-49	1046-040	80 x 20 x 49 mm	10
Busbar 10 x 3	1046-001	length 1.000 mm	5



Shield connection for busbar

PRODUCT DESCRIPTION

The shield connection for busbar SKS is suitable for the easy contacting of cable shields. Through the tool-free assembly and fastening via knurled screw, cable shields with a diameter from 2 mm to 35 mm can be contacted also subsequently.

ADVANTAGES

// wide clamping range

TECHNICAL DATA

Material: galvanised steel

ACCESSOIRES

// busbar 10 x 3 x 1.000 mm

SHIELD CONNECTION FOR BUSBAR			
ITEM DESCRIPTION	ORDER NO.	CLAMPING RANGE	PU
SKS 2-5	1043-001	2-5 mm	10
SKS 3-8	1043-002	3-8 mm	10
SKS 3-14	1043-003	3-14 mm	10
SKS 3-20	1043-004	3-20 mm	10
SKS 5-28	1043-005	5-28 mm	10
SKS 20-35	1043-006	20-35 mm	10
Busbar 10 x 3	1046-001	length 1.000 mm	5



Shielding clamp with spring

PRODUCT DESCRIPTION

The Shielding clamp with spring is used for the connection of cable shields with the ground level.

The clamp is available for direct mounting, assembly on busbar or 35 mm DIN rails.

ADVANTAGES

- // through spring pressure steady contact to the cable shield
- // wide clamping range

TECHNICAL DATA

Material: galvanised steel

ACCESSORIES

- // Clip foot for 35 mm DIN rail, M4
- // Busbar 10 x 3 x 1.000 mm

SHIELDING CLAMP WITH SPRING AND CLIP FOOT

ITEM DESCRIPTION	ORDER NO.	SHIELD DIAMETER	PU
SF-SK 3-8	1042-001	3-8 mm	10
SF-SK 4-13,5	1042-002	4-13,5 mm	10
SF-SK 10-20	1042-003	10-20 mm	10
SF-SK 15-32	1042-004	15-32 mm	10
Clip foot M4	1030-020		25

SHIELDING CLAMP FOR DIRECT MOUNTING

ITEM DESCRIPTION	ORDER NO.	SHIELD DIAMETER	PU
SK 3-8	1042-011	3-8 mm	10
SK 4-13,5	1042-012	4-13,5 mm	10
SK 10-20	1042-013	10-20 mm	10
SK 15-32	1042-014	15-32 mm	10

SHIELDING CLAMP FOR BUSBAR

ITEM DESCRIPTION	ORDER NO.	SHIELD DIAMETER	PU
SKO 3-8	1042-021	3-8 mm	10
SKO 4-13,5	1042-022	4-13,5 mm	10
SKO 10-20	1042-023	10-20 mm	10
SKO 15-32	1042-024	15-32 mm	10
Busbar 10 x 3	1046-001	length 1.000 mm	5



Grounding clamp

PRODUCT DESCRIPTION

The EMC grounding clamps with one or two fastening lugs can be used as shield contact directly on the mounting plate or at the electrical equipment.

These open grounding clamps stand out due to their easy and problem-free handling.

ADVANTAGES

// universally usable

TECHNICAL DATA

Material: galvanised steel

GROUNDING CLAMP WITH 1 FASTENING FLAP			
ITEM DESCRIPTION	ORDER NO.	CLAMPING RANGE, SCREW	PU
ESE 7	1044-010	5.5–7.0 mm, M6	100
ESE 9	1044-011	7.0–9.0 mm, M6	100
ESE 13	1044-012	9.5–13.0 mm, M6	100
ESE 15,5	1044-013	13.0–15.5 mm, M6	100
ESE 19	1044-014	15.5–19.0 mm, M6	100
ESE 23	1044-015	20.0–23.0 mm, M8	100
ESE 26	1044-016	23.0–26.0 mm, M8	100
ESE 28,5	1044-017	26.0–28.5 mm, M8	100
ESE 31	1044-018	28.5–31.0 mm, M8	100
ESE 33	1044-019	31.0–33.0 mm, M8	100

GROUNDING CLAMP WITH 2 FASTENING FLAPS			
ITEM DESCRIPTION	ORDER NO.	CLAMPING RANGE, SCREW	PU
ESD 7	1044-030	5.5–7.0 mm, M5	100
ESD 9	1044-031	7.0–9.0 mm, M5	100
ESD 13	1044-032	9.5–13.0 mm, M5	100
ESD 15,5	1044-033	13.0–15.5 mm, M5	100
ESD 19	1044-034	15.5–19.0 mm, M5	100
ESD 23	1044-035	20.0–23.0 mm, M6	100
ESD 26	1044-036	23.0–26.0 mm, M6	100
ESD 28,5	1044-037	26.0–28.5 mm, M6	100
ESD 31	1044-038	28.5–31.0 mm, M6	100
ESD 33	1044-039	31.0–33.0 mm, M6	100

PRODUCT LINE

Fastening systems

An increasing number of flexible and multi-purpose fastening systems is required for the cabling of machines and facilities.

The repeatedly reusable HEBOTEC products satisfy these needs.

Furthermore, HEBOTEC also offers solutions using self-extinguishing materials according to the Flammability Test UL94.

These products have been approved by many automobile manufacturers.



M8-/M12-Mounting clip for direct assembly stackable

PRODUCT DESCRIPTION

The Mounting clip for direct assembly serves as an installation support for the secure fixing of industrial connectors. It is available in two sizes for M8 or M12 connectors. The clip can be mounted with a cylinder screw. Following this, the M8 or M12 connector is simply pressed in from above.

It should be ensured that the gap of the connector is positioned in the middle of the clip. Nubs in the material dip into the gap and prevent the connectors from moving in the longitudinal direction.

The different sizes are stackable by a dovetail joint.

ADVANTAGES

- // easy handling
- // good holding force
- // universally applicable
- // stackable clip
- // high stability
- // prevention of longitudinal movement

TECHNICAL DATA

Material: PPO, self-extinguishing according to UL94-V0

ACCESSORIES

- // mounting accessories

M8-/M12-MOUNTING CLIP FOR DIRECT ASSEMBLY STACKABLE			
ITEM DESCRIPTION	ORDER NO.	DETAILED DESCRIPTION	PU
SHD 8 4	3014-102	for M8 connectors, for boring M4	10
SHD 12 4	3014-104	for M12 connectors, for boring M4	10
SHD 12 5	3014-114	for M12 connectors, for boring M5	10



M12-Mounting clip with clamping foot for C11-rails

PRODUCT DESCRIPTION

The Mounting clip for C11-rails with material thickness of 1.5 mm serves as an installation help for the secure fixing of M12 connectors. The clamping foot can be assembled by a 90° turn into the rabbet of C11-rails, afterwards the M12 connector is simply pressed in from above.

ADVANTAGES

- // easy handling
- // good holding force
- // universally applicable
- // simple mounting without tools into C11-rails
- // high stability

TECHNICAL DATA

Material: PPO, self-extinguishing according to UL94-V0

M12-MOUNTING CLIP WITH CLAMPING FOOT FOR C11-RAIL

ITEM DESCRIPTION	ORDER NO.	DETAILED DESCRIPTION	PU
SHK 12 C11	3014-124	for M12 connectors, for C11-rails	10

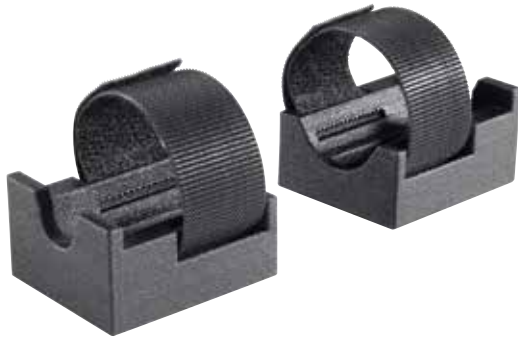

M17-/M23-Mounting bracket Big

PRODUCT DESCRIPTION

The mounting bracket Big for direct assembly serves as an installation help for the secure fixing of M17- and M23-connectors. Two brackets can be mounted with a M6 cylinder screw to insert the connector between the stops of the brackets. Following this the hook-and-loop tape is strapped around the connector, then plugged through the duct of the bracket and fastened. To simplify the exact assembling, the bracket possesses an integrated alignment help at the bottom side. It dips into a optional second drilling on the mounting surface with 3mm diameter. When not using the drilling, the alignment help disappears in the bracket during assembly.

ADVANTAGES

- // easy handling
- // good holding force
- // integrated alignment help
- // self-extinguishing according to UL94-V0

TECHNICAL DATA

Material mounting bracket:
polyamid, reinforced with glass fibre, self-extinguishing according to UL94-V0

Material hook-and-loop tape:
polypropylene, self-extinguishing according to UL94-V2

M17-/M23-MOUNTING BRACKET BIG WITH HOOK-AND-LOOP TAPE

ITEM DESCRIPTION	ORDER NO.	DIMENSION	PU
SHBD 17/23 6	3014-210-145	boring for M6, set consists of two brackets	5

HOLE PATTERN

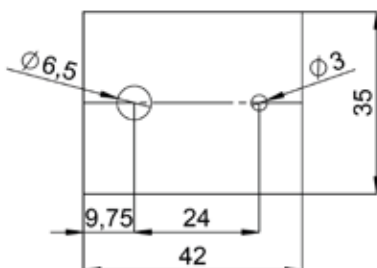



Hook-and-loop tape

PRODUCT DESCRIPTION

Hook-and-loop tape of polypropylene in high quality can be reused hundreds of times.

The tapes are perfect for bundeling, organisation and protection of cables and wires.

ADVANTAGES

- // cable bundles can be extended easily
- // self-extinguishing according to UL94-V2
- // hook-and-loop tape on reel can be cut to the required length

- // reduced risk of injury compared to use of cut off cable binder

TECHNICAL DATA

Material: polypropylene
reusable hundreds of times

ACCESSORIES

- // HEBOFIX base for hook-and-loop tape

HOOK-AND-LOOP TAPE ON REEL TO CUT TO SIZE, SELF-EXTINGUISHING ACCORDING TO UL94-V2

ITEM DESCRIPTION	ORDER NO.	DIMENSION	PU
Hook-and-loop tape on reel FRT	11-KE07015FRT	7.5 mm	15 m
Hook-and-loop tape on reel FRT	11-KE10025FRT	10 mm	25 m
Hook-and-loop tape on reel FRT	11-KE13025FRT	13 mm	25 m
Hook-and-loop tape on reel FRT	11-KE16025FRT	16 mm	25 m
Hook-and-loop tape on reel FRT	11-KE20025FRT	20 mm	25 m
Hook-and-loop tape on reel FRT	11-KE25025FRT	25 mm	25 m
Hook-and-loop tape on reel FRT	11-KE30025FRT	30 mm	25 m



Hook-and-loop cable tie

PRODUCT DESCRIPTION

Hook-and-loop tape of polypropylene in high quality can be reused hundreds of times.

The tapes are perfect for bundeling, organisation and protection of cables and wires.

ADVANTAGES

- // cable bundles can be extended easily
- // self-extinguishing according to UL94-V2

- // hook-and-loop cable ties on reel are perforated to ease tearing off
- // reduced risk of injuries compared to the use of cut off cable ties

TECHNICAL DATA

Material: polypropylene
reusable hundreds of times

HOOK-AND-LOOP CABLE TIE, SELF-EXTINGUISHING ACCORDING TO UL94-V2			
ITEM DESCRIPTION	ORDER NO.	DIMENSION	PU
Hook-and-loop cable tie on reel FRT	11-KK13200FRT	7 x 200 mm	750 pcs
Hook-and-loop cable tie on reel FRT	11-KK20150FRT	13 x 150 mm	1000 pcs
Hook-and-loop cable tie on reel FRT	11-KK20200FRT	13 x 200 mm	750 pcs
Hook-and-loop cable tie on reel FRT	11-KK20330FRT	13 x 330 mm	450 pcs
Hook-and-loop cable tie on reel FRT	11-KK25300FRT	16 x 300 mm	500 pcs



Hook-and-loop strap

PRODUCT DESCRIPTION

Hook-and-loop tape with welded plastic eyelet in high quality, can be reused hundreds of times. The hook-and-loop straps are perfect for bundeling, organization and protection of cables and wires.

With the loop side facing outside the strap is pulled through the eyelet, then tightened back and securely fixated on the hook side.

ADVANTAGES

- // cable bundles can be extended easily
- // self-extinguishing according to UL94-V2
- // easy handling
- // reusable

TECHNICAL DATA

Material: polypropylene
reusable hundreds of times

HOOK-AND-LOOP STRAP, SELF-EXTINGUISHING ACCORDING TO UL94-V2

ITEM DESCRIPTION	ORDER NO.	DIMENSION	PU
Hook-and-loop strap	3020-201	20 x 170 mm	10 pcs
Hook-and-loop strap	3020-202	20 x 200 mm	10 pcs
Hook-and-loop strap	3020-203	20 x 300 mm	10 pcs
Hook-and-loop strap	3020-204	20 x 400 mm	10 pcs
Hook-and-loop strap	3020-205	20 x 500 mm	10 pcs
Hook-and-loop strap	3020-206	20 x 600 mm	10 pcs



HEBOFIX base for hook-and-loop tape

PRODUCT DESCRIPTION

The base for hook-and-loop fasteners serves as installation support and provides minimal damage during attachment of pipes, cables and tubes. The base can be equipped, free of tools, with our hook-and-loop tapes in variable lengths.

The base is available for both, direct assembly with flat-head screw or with the mounting accessories for assembly onto C-rails and profile grooves.

ADVANTAGES

- // variable length of the hook-and-loop tape, or already assembled with hook-and-loop tape
- // provides a tangle-free and protective cable installation

// reusable

// cable bundles can be extended easily

// easy handling

// reduced risk of injuries compared to the use of cut off cable ties

TECHNICAL DATA

Material: polyamide, reinforced with glass fibre, self-extinguishing according to UL94-V0

ACCESSORIES

// hook-and-loop tape on reel

// mounting accessories

HEBOFIX BASE FOR DIRECT ASSEMBLY FOR HOOK-AND-LOOP TAPE

ITEM DESCRIPTION	ORDER NO.	DETAILED DESCRIPTION	PU
KBS 4-20 7,5	3011-001	clamping range 4-20 mm, hook-and-loop tape 7.5 mm, M4	10
KBS 4-20 10	3011-002	clamping range 4-20 mm, hook-and-loop tape 10 mm, M4	10
KBS 8-35 20	3011-004	clamping range 8-35 mm, hook-and-loop tape 20 mm, M4 or M5	10
KBS 10-60 20	3011-006	clamping range 10-60 mm, hook-and-loop tape 20 mm, M4 or M5	10

HEBOFIX BASE FOR DIRECT ASSEMBLY EQUIPPED WITH HOOK-AND-LOOP TAPE

ITEM DESCRIPTION	ORDER NO.	DETAILED DESCRIPTION	PU
KBS-KE 4-20	3011-001-150	clamping range 4-20 mm, hook-and-loop tape 150 x 7.5 mm, M4	10
KBS-KE 4-20	3011-002-150	clamping range 4-20 mm, hook-and-loop tape 150 x 10 mm, M4	10
KBS-KE 8-35	3011-004-180	clamping range 8-35 mm, hook-and-loop tape 180 x 20 mm, M4 or M5	10
KBS-KE 10-60	3011-006-200	clamping range 10-60 mm, hook-and-loop tape 200 x 20 mm, M4 or M5	10



HEBOFIX base Big for hook-and-loop tape

PRODUCT DESCRIPTION

The base for hook-and-loop fasteners serves as installation support which prevents damage during attachment of pipes, cables and tubes. The base can be equipped, free of tools, with our hook-and-loop tapes in variable lengths.

The base is available for both, direct assembly with an M6 cylinder screw or using the mounting accessories for assembly onto a profile groove.

ADVANTAGES

- // variable length of the hook-and-loop tape, or already equipped with hook-and-loop tape
- // provides a tangle-free and protective cable installation

- // reusable
- // cable bundles can be extended easily
- // easy handling
- // reduced risk of injuries compared to the use of cut off cable ties

TECHNICAL DATA

Material: polyamide, reinforced with glass fibre, self-extinguishing according to UL94-V0

ACCESSORIES

- // hook-and-loop tape on reel
- // mounting accessories

HEBOFIX BASE BIG FOR DIRECT ASSEMBLY FOR HOOK-AND-LOOP TAPE

ITEM DESCRIPTION	ORDER NO.	DETAILED DESCRIPTION	PU
KBS 20-100 30	3011-010	clamping range 20-100 mm, hook-and-loop tape 30 mm, M6	10

HEBOFIX BASE BIG FOR DIRECT ASSEMBLY, EQUIPPED WITH HOOK-AND-LOOP TAPE

ITEM DESCRIPTION	ORDER NO.	DETAILED DESCRIPTION	PU
KBS-KE 20-100 30	3011-010-300	clamping range 20-100 mm, hook-and-loop tape 300 x 30 mm, M6	10

HEBOFIX BIG MOUNTING PROCEDURE





HEBOFIX base for aluminium profiles

PRODUCT DESCRIPTION

The base for hook-and-loop fasteners with clamping foot serves as a gentle installation support of lines, cables and hoses on aluminium profiles.

The clamping foot can be assembled by a 90° turn into the rabbet of aluminium profiles or by pushing into a boring. After that the base can be assembled with our hook-and-loop tape in variable length.

ADVANTAGES

- // simple mounting without tools into popular aluminium profiles
- // variable length of the hook-and-loop tape, or already equipped with hook-and-loop tape

- // provides a tangle-free and protective cable installation
- // reusable
- // cable bundles can be extended easily
- // easy handling
- // reduced risk of injuries compared to use of cut off cable ties

TECHNICAL DATA

Material: polyamide, reinforced with glass fibre, self-extinguishing according to UL94-V0

ACCESSORIES

- // hook-and-loop tape on reel

MOUNTING PROCEDURE FOR HEBOFIX BASE FOR ALUMINIUM PROFILE





HEBOFIX BASE FOR ITEM-PROFILE WITH 8 MM-RABBET

ITEM DESCRIPTION	ORDER NO.	DETAILED DESCRIPTION	PU
KBS-I8 4-20 10	3011-102	clamping range 4-20 mm, hook-and-loop tape 75 mm and 10 mm	10
KBS-I8 8-35 20	3011-104	clamping range 8-35 mm, hook-and-loop tape 20 mm	10
KBS-I8 10-60 20	3011-106	clamping range 10-60 mm, hook-and-loop tape 20 mm	10

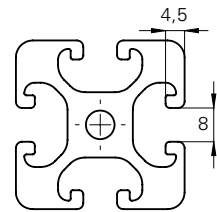

HEBOFIX BASE FOR ITEM-PROFILE WITH 8 MM-RABBET, EQUIPPED WITH HOOK-AND-LOOP TAPE

ITEM DESCRIPTION	ORDER NO.	DETAILED DESCRIPTION	PU
KBS-I8 4-20 10	3011-102-150	clamping range 4-20 mm, hook-and-loop tape 150 x 10 mm	10
KBS-I8 8-35 20	3011-104-180	clamping range 8-35 mm, hook-and-loop tape 180 x 20 mm	10
KBS-I8 10-60 20	3011-106-200	clamping range 10-60 mm, hook-and-loop tape 200 x 20 mm	10

HEBOFIX BASE FOR BOSCH-PROFILE WITH 8 MM-RABBET

ITEM DESCRIPTION	ORDER NO.	DETAILED DESCRIPTION	PU
KBS-B8 4-20 10	3011-112	clamping range 4-20 mm, hook-and-loop tape 75 mm and 10 mm	10
KBS-B8 8-35 20	3011-114	clamping range 8-35 mm, hook-and-loop tape 20 mm	10
KBS-B8 10-60 20	3011-116	clamping range 10-60 mm, hook-and-loop tape 20 mm	10

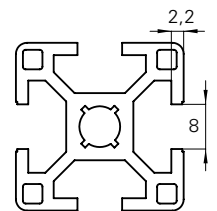

HEBOFIX BASE FOR BOSCH-PROFILE WITH 8 MM-RABBET, EQUIPPED WITH HOOK-AND-LOOP TAPE

ITEM DESCRIPTION	ORDER NO.	DETAILED DESCRIPTION	PU
KBS-B8 4-20 10	3011-112-150	clamping range 4-20 mm, hook-and-loop tape 150 x 10 mm	10
KBS-B8 8-35 20	3011-114-180	clamping range 8-35 mm, hook-and-loop tape 180 x 20 mm	10
KBS-B8 10-60 20	3011-116-200	clamping range 10-60 mm, hook-and-loop tape 200 x 20 mm	10



HEBOFIX BASE FOR BOSCH-PROFILE WITH 10 MM-RABBET			
ITEM DESCRIPTION	ORDER NO.	DETAILED DESCRIPTION	PU
KBS-B10 4-20 10	3011-122	clamping range 4-20 mm, hook-and-loop tape 75 mm and 10 mm	10
KBS-B10 8-35 20	3011-124	clamping range 8-35 mm, hook-and-loop tape 20 mm	10
KBS-B10 10-60 20	3011-126	clamping range 10-60 mm, hook-and-loop tape 20 mm	10

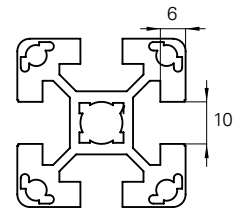

HEBOFIX BASE FOR BOSCH-PROFILE WITH 10 MM-RABBET, EQUIPPED WITH HOOK-AND-LOOP TAPE			
ITEM DESCRIPTION	ORDER NO.	DETAILED DESCRIPTION	PU
KBS-B10 4-20 10	3011-122-150	clamping range 4-20 mm, hook-and-loop tape 150 x 10 mm	10
KBS-B10 8-35 20	3011-124-180	clamping range 8-35 mm, hook-and-loop tape 180 x 20 mm	10
KBS-B10 10-60 20	3011-126-200	clamping range 10-60 mm, hook-and-loop tape 200 x 20 mm	10

HEBOFIX BASE FOR EGT-PROFILE WITH 11 MM-BORING			
ITEM DESCRIPTION	ORDER NO.	DETAILED DESCRIPTION	PU
KBS-EGT 4-20 10	3011-132	clamping range 4-20 mm, hook-and-loop tape 75 mm and 10 mm	100
KBS-EGT 8-35 20	3011-134	clamping range 8-35 mm, hook-and-loop tape 20 mm	100
KBS-EGT 10-60 20	3011-136	clamping range 10-60 mm, hook-and-loop tape 20 mm	100

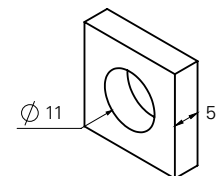

HEBOFIX BASE FOR EGT-PROFILE WITH 11 MM-BORING, EQUIPPED WITH HOOK-AND-LOOP TAPE			
ITEM DESCRIPTION	ORDER NO.	DETAILED DESCRIPTION	PU
KBS-EGT 4-20 10	3011-132-150	clamping range 4-20 mm, hook-and-loop tape 150 x 10 mm	100
KBS-EGT 8-35 20	3011-134-180	clamping range 8-35 mm, hook-and-loop tape 180 x 20 mm	100
KBS-EGT 10-60 20	3011-136-200	clamping range 10-60 mm, hook-and-loop tape 200 x 20 mm	100



HEBOFIX 45 base for aluminium profiles

PRODUCT DESCRIPTION

The base for hook-and-loop fasteners with clamping foot serves as a gentle installation support of lines, cables and hoses. The clamping foot can be assembled by a 45° turn right or left into the rabbet of aluminium profiles. After that the base can be assembled with our hook-and-loop tape in variable length.

ADVANTAGES

- // simple mounting without tools into popular aluminium profiles
- // through a 45° turn possible cable installation parallel or across to the profiles
- // variable length of the hook-and-loop tape, or already equipped with hook-and-loop tape

- // provides a tangle-free and protective cable installation
- // reusable
- // cable bundles can be extended easily
- // easy handling
- // reduced risk of injuries compared to use of cut off cable ties

TECHNICAL DATA

Material: polyamide, reinforced with glass fibre, self-extinguishing according to UL94-V0

ACCESSORIES

- // hook-and-loop tape on reel

HEBOFIX 45 MOUNTING PROCEDURE



HEBOFIX 45 BASE FOR ITEM-PROFILE WITH 8 MM-RABBET

ITEM DESCRIPTION	ORDER NO.	DETAILED DESCRIPTION	PU
KBS-I8M 4-20 10	3011-162	clamping range 4-20 mm, hook-and-loop tape 7.5 mm and 10 mm	10
KBS-I8M 8-35 20	3011-164	clamping range 8-35 mm, hook-and-loop tape 20 mm	10
KBS-I8M 10-60 20	3011-166	clamping range 10-60 mm, hook-and-loop tape 20 mm	10

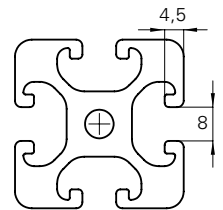

HEBOFIX 45 BASE FOR ITEM-PROFILE WITH 8 MM-RABBET, EQUIPPED WITH HOOK-AND-LOOP TAPE

ITEM DESCRIPTION	ORDER NO.	DETAILED DESCRIPTION	PU
KBS-I8M 4-20 10	3011-162-150	clamping range 4-20 mm, hook-and-loop tape 150 x 10 mm	10
KBS-I8M 8-35 20	3011-164-180	clamping range 8-35 mm, hook-and-loop tape 180 x 20 mm	10
KBS-I8M 10-60 20	3011-166-200	clamping range 10-60 mm, hook-and-loop tape 200 x 20 mm	10

HEBOFIX 45 BASE FOR BOSCH-PROFILE WITH 8 MM-RABBET

ITEM DESCRIPTION	ORDER NO.	DETAILED DESCRIPTION	PU
KBS-B8M 4-20 10	3011-172	clamping range 4-20 mm, hook-and-loop tape 7.5 mm and 10 mm	10
KBS-B8M 8-35 20	3011-174	clamping range 8-35 mm, hook-and-loop tape 20 mm	10
KBS-B8M 10-60 20	3011-176	clamping range 10-60 mm, hook-and-loop tape 20 mm	10

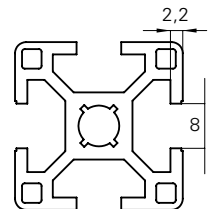

HEBOFIX 45 BASE FOR BOSCH-PROFILE WITH 8 MM-RABBET, EQUIPPED WITH HOOK-AND-LOOP TAPE

ITEM DESCRIPTION	ORDER NO.	DETAILED DESCRIPTION	PU
KBS-B8M 4-20 10	3011-172-150	clamping range 4-20 mm, hook-and-loop tape 150 x 10 mm	10
KBS-B8M 8-35 20	3011-174-180	clamping range 8-35 mm, hook-and-loop tape 180 x 20 mm	10
KBS-B8M 10-60 20	3011-176-200	clamping range 10-60 mm, hook-and-loop tape 200 x 20 mm	10

HEBOFIX 45 BASE FOR BOSCH-PROFILE WITH 10 MM-RABBET

ITEM DESCRIPTION	ORDER NO.	DETAILED DESCRIPTION	PU
KBS-B10M 4-20 10	3011-182	clamping range 4-20 mm, hook-and-loop tape 7.5 mm and 10 mm	10
KBS-B10M 8-35 20	3011-184	clamping range 8-35 mm, hook-and-loop tape 20 mm	10
KBS-B10M 10-60 20	3011-186	clamping range 10-60 mm, hook-and-loop tape 20 mm	10

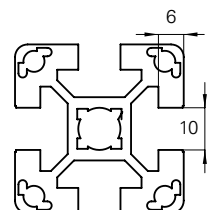

HEBOFIX 45 BASE FOR BOSCH-PROFILE WITH 10 MM-RABBET, EQUIPPED WITH HOOK-AND-LOOP TAPE

ITEM DESCRIPTION	ORDER NO.	DETAILED DESCRIPTION	PU
KBS-B10M 4-20 10	3011-182-150	clamping range 4-20 mm, hook-and-loop tape 150 x 10 mm	10
KBS-B10M 8-35 20	3011-184-180	clamping range 8-35 mm, hook-and-loop tape 180 x 20 mm	10
KBS-B10M 10-60 20	3011-186-200	clamping range 10-60 mm, hook-and-loop tape 200 x 20 mm	10

HEBOFIX 45 BASE FOR MINITEC30

ITEM DESCRIPTION	ORDER NO.	DETAILED DESCRIPTION	PU
KBS-MI8M 4-20 10	3011-142	clamping range 4-20 mm, hook-and-loop tape 7.5 mm and 10 mm	10
KBS-MI8M 8-35 20	3011-144	clamping range 8-35 mm, hook-and-loop tape 20 mm	10
KBS-MI8M 10-60 20	3011-146	clamping range 10-60 mm, hook-and-loop tape 20 mm	10

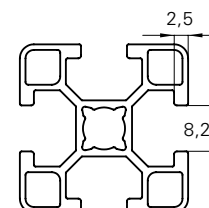

HEBOFIX 45 BASE FOR MINITEC30, EQUIPPED WITH HOOK-AND-LOOP TAPE

ITEM DESCRIPTION	ORDER NO.	DETAILED DESCRIPTION	PU
KBS-MI8M 4-20 10	3011-142-150	clamping range 4-20 mm, hook-and-loop tape 150 x 10 mm	10
KBS-MI8M 8-35 20	3011-144-180	clamping range 8-35 mm, hook-and-loop tape 180 x 20 mm	10
KBS-MI8M 10-60 20	3011-146-200	clamping range 10-60 mm, hook-and-loop tape 200 x 20 mm	10

HEBOFIX 45 BASE FOR MINITEC45

ITEM DESCRIPTION	ORDER NO.	DETAILED DESCRIPTION	PU
KBS-I8M 4-20 10	3011-162	clamping range 4-20 mm, hook-and-loop tape 7.5 mm and 10 mm	10
KBS-I8M 8-35 20	3011-164	clamping range 8-35 mm, hook-and-loop tape 20 mm	10
KBS-I8M 10-60 20	3011-166	clamping range 10-60 mm, hook-and-loop tape 20 mm	10

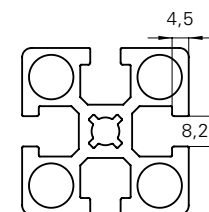

HEBOFIX 45 BASE FOR MINITEC45, EQUIPPED WITH HOOK-AND-LOOP TAPE

ITEM DESCRIPTION	ORDER NO.	DETAILED DESCRIPTION	PU
KBS-I8M 4-20 10	3011-162-150	clamping range 4-20 mm, hook-and-loop tape 150 x 10 mm	10
KBS-I8M 8-35 20	3011-164-180	clamping range 8-35 mm, hook-and-loop tape 180 x 20 mm	10
KBS-I8M 10-60 20	3011-166-200	clamping range 10-60 mm, hook-and-loop tape 200 x 20 mm	10

HEBOFIX 45 BASE FOR MAYTEC PG16/PG40

ITEM DESCRIPTION	ORDER NO.	DETAILED DESCRIPTION	PU
KBS-MA8M 4-20 10	3011-152	clamping range 4-20 mm, hook-and-loop tape 7.5 mm and 10 mm	10
KBS-MA8M 8-35 20	3011-154	clamping range 8-35 mm, hook-and-loop tape 20 mm	10
KBS-MA8M 10-60 20	3011-156	clamping range 10-60 mm, hook-and-loop tape 20 mm	10

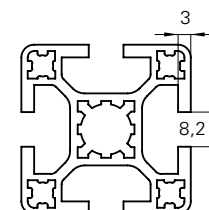

HEBOFIX 45 BASE FOR MAYTEC PG16/PG40, EQUIPPED WITH HOOK-AND-LOOP TAPE

ITEM DESCRIPTION	ORDER NO.	DETAILED DESCRIPTION	PU
KBS-MA8M 4-20 10	3011-152-150	clamping range 4-20 mm, hook-and-loop tape 150 x 10 mm	10
KBS-MA8M 8-35 20	3011-154-180	clamping range 8-35 mm, hook-and-loop tape 180 x 20 mm	10
KBS-MA8M 10-60 20	3011-156-200	clamping range 10-60 mm, hook-and-loop tape 200 x 20 mm	10

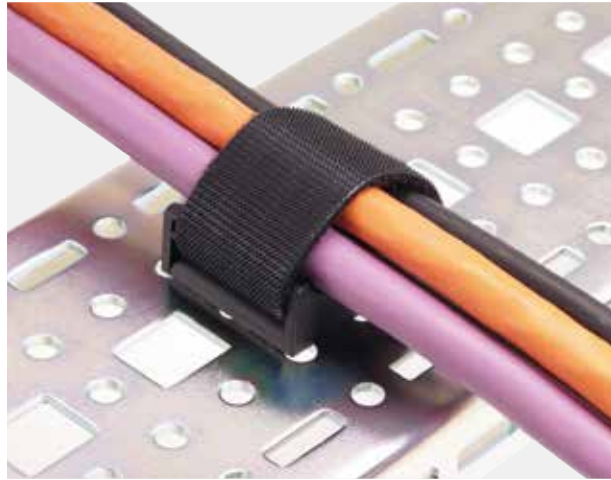

HEBOFIX 45 base for Rittal-VX25

PRODUCT DESCRIPTION

The base for hook-and-loop fasteners with clamping foot serves as a gentle installation support of lines, cables and hoses. The clamping foot can be assembled by a 45° turn right or left into the Rittal-VX25 (12.5 mm x 10.5 mm). After that the base can be assembled with our hook-and-loop tape in variable length.

- // provides a tangle-free and protective cable installation
- // reusable
- // cable bundles can be extended easily
- // easy handling
- // reduced risk of injuries compared to use of cut off cable ties

ADVANTAGES

- // simple mounting without tools into Rittal-VX25 (12.5 mm x 10.5 mm)
- // through a 45° turn possible cable installation parallel or across to the bar
- // variable length of the hook-and-loop tape, or already equipped with hook-and-loop tape

TECHNICAL DATA

Material: polyamide, reinforced with glass fibre, self-extinguishing according to UL94-V0

ACCESSORIES

- // hook-and-loop tape on reel

HEBOFIX 45 BASE FOR RITTAL-VX25			
ITEM DESCRIPTION	ORDER NO.	DETAILED DESCRIPTION	PU
KBS-RM 4-20 10	3011-252	clamping range 4-20 mm, hook-and-loop tape 7.5 mm and 10 mm	10
KBS-RM 8-35 20	3011-254	clamping range 8-35 mm, hook-and-loop tape 20 mm	10

HEBOFIX 45 BASE FOR RITTAL-VX25, EQUIPPED WITH HOOK-AND-LOOP TAPE			
ITEM DESCRIPTION	ORDER NO.	DETAILED DESCRIPTION	PU
KBS-RM 4-20 10	3011-252-150	clamping range 4-20 mm, hook-and-loop tape 150 x 10 mm	10
KBS-RM 8-35 20	3011-254-180	clamping range 8-35 mm, hook-and-loop tape 180 x 20 mm	10

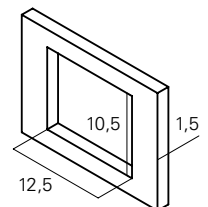



HEBOFIX base self-adhesive

PRODUCT DESCRIPTION

The self-adhesive base for hook-and-loop fasteners serves as a gentle installation support of lines, cables and hoses. The base can be mounted on the desired surface with the bond area. After that the base can be equipped with our hook-and-loop tape in variable length.

ADVANTAGES

- // simple, tool-free mounting
- // variable length of the hook-and-loop tape, or already equipped with hook-and-loop tape
- // provides a tangle-free and protective cable installation
- // polyurethan-foam to compensate existing irregularities or tolerances of the surface

TECHNICAL DATA

Base: polyamide, reinforced with glass fibre, self-extinguishing according to UL94-V0
Adhesive: acrylate

ACCESSORIES

- // hook-and-loop tape on reel

ASSEMBLY INSTRUCTIONS

- // clean surface properly and fat-free
- // remove protection cover in one piece
- // optimal adhesive power by pressing the base with >150N shortly

HEBOFIX BASE SELF-ADHESIVE

ITEM DESCRIPTION	ORDER NO.	DETAILED DESCRIPTION	PU
KBS-K 4-20 10	3011-362	clamping range 4-20 mm, hook-and-loop tape 7.5 mm and 10 mm	10
KBS-K 8-35 20	3011-364	clamping range 8-35 mm, hook-and-loop tape 20 mm	10

HEBOFIX BASE SELF-ADHESIVE, EQUIPPED WITH HOOK-AND-LOOP TAPE

ITEM DESCRIPTION	ORDER NO.	DETAILED DESCRIPTION	PU
KBS-K 4-20 10	3011-362-150	clamping range 4-20 mm, hook-and-loop tape 150 x 10 mm	10
KBS-K 8-35 20	3011-364-180	clamping range 8-35 mm, hook-and-loop tape 180 x 20 mm	10



HEBOFIX base for C-rail

PRODUCT DESCRIPTION

The base for hook-and-loop fasteners with clamping foot serves as a gentle installation support of lines, cables and hoses on C-rails. The clamping foot can be assembled tool-free by a 90° turn into the slot of C-rails. After that the base can be equipped with our hook-and-loop tape in variable length.

- // provides a tangle-free and protective cable installation
- // reusable
- // cable bundles can be extended easily
- // easy handling
- // budget-friendly
- // available for material thickness of 1.5 mm and 2 mm

ADVANTAGES

- // tool-free assembly
- // simple mounting into C-rails with 11 mm and 16 mm slot
- // variable length of the hook-and-loop tape, or already equipped with hook-and-loop tape

TECHNICAL DATA

Material: polyamide, reinforced with glass fibre, self-extinguishing according to UL94-V0

ACCESSORIES

- // hook-and-loop tape on reel

HEBOFIX BASE FOR C11-RAIL MATERIAL THICKNESS 1.5 MM			
ITEM DESCRIPTION	ORDER NO.	DETAILED DESCRIPTION	PU
KBS-C11 1,5 8-35 20	3011-504	clamping range 8–35 mm, hook-and-loop tape 20 mm	10
KBS-C11 1,5 10-60 20	3011-506	clamping range 10–60 mm, hook-and-loop tape 20 mm	10

HEBOFIX BASE FOR C11-RAIL MATERIAL THICKNESS 1.5 MM, EQUIPPED WITH HOOK-AND-LOOP TAPE			
ITEM DESCRIPTION	ORDER NO.	DETAILED DESCRIPTION	PU
KBS-C11 1,5 8-35 20	3011-504-180	clamping range 8–35 mm, hook-and-loop tape 180 x 20 mm	10
KBS-C11 1,5 10-60 20	3011-506-200	clamping range 10–60 mm, hook-and-loop tape 200 x 20 mm	10

HEBOFIX BASE FOR C11-RAIL MATERIAL THICKNESS 2 MM

ITEM DESCRIPTION	ORDER NO.	DETAILED DESCRIPTION	PU
KBS-C11 2,0 8-35 20	3011-514	clamping range 8-35 mm, hook-and-loop tape 20 mm	10
KBS-C11 2,0 10-60 20	3011-516	clamping range 10-60 mm, hook-and-loop tape 20 mm	10

HEBOFIX BASE FOR C11-RAIL MATERIAL THICKNESS 2 MM, EQUIPPED WITH HOOK-AND-LOOP TAPE

ITEM DESCRIPTION	ORDER NO.	DETAILED DESCRIPTION	PU
KBS-C11 2,0 8-35 20	3011-514-180	clamping range 8-35 mm, hook-and-loop tape 180 x 20 mm	10
KBS-C11 2,0 10-60 20	3011-516-200	clamping range 10-60 mm, hook-and-loop tape 200 x 20 mm	10

HEBOFIX BASE FOR C16-RAIL MATERIAL THICKNESS 1.5 MM

ITEM DESCRIPTION	ORDER NO.	DETAILED DESCRIPTION	PU
KBS-C16 1,5 8-35 20	3011-274	clamping range 8-35 mm, hook-and-loop tape 20 mm	10
KBS-C16 1,5 10-60 20	3011-276	clamping range 10-60 mm, hook-and-loop tape 20 mm	10

HEBOFIX BASE FOR C16-RAIL MATERIAL THICKNESS 1.5 MM, EQUIPPED WITH HOOK-AND-LOOP TAPE

ITEM DESCRIPTION	ORDER NO.	DETAILED DESCRIPTION	PU
KBS-C16 1,5 8-35 20	3011-274-180	clamping range 8-35 mm, hook-and-loop tape 180 x 20 mm	10
KBS-C16 1,5 10-60 20	3011-276-200	clamping range 10-60 mm, hook-and-loop tape 200 x 20 mm	10

HEBOFIX BASE FOR C16-RAIL MATERIAL THICKNESS 2 MM

ITEM DESCRIPTION	ORDER NO.	DETAILED DESCRIPTION	PU
KBS-C16 2,0 8-35 20	3011-284	clamping range 8-35 mm, hook-and-loop tape 20 mm	10
KBS-C16 2,0 10-60 20	3011-286	clamping range 10-60 mm, hook-and-loop tape 20 mm	10

HEBOFIX BASE FOR C16-RAIL MATERIAL THICKNESS 2 MM, EQUIPPED WITH HOOK-AND-LOOP TAPE

ITEM DESCRIPTION	ORDER NO.	DETAILED DESCRIPTION	PU
KBS-C16 2,0 8-35 20	3011-284-180	clamping range 8-35 mm, hook-and-loop tape 180 x 10 mm	10
KBS-C16 2,0 10-60 20	3011-286-200	clamping range 10-60 mm, hook-and-loop tape 200 x 20 mm	10



HEBOFIX base with mounting adapter for C-rail

PRODUCT DESCRIPTION

The base for hook-and-loop fasteners for C-rails serves as a gentle installation support of lines, cables and hoses on C-rails.

The base can be assembled by a 90° turn into C-rail profiles with an 11 mm or 16 mm port. The base can be secured onto the C-rail by tightening the screw.

ADVANTAGES

- // easy 90° mounting, secured with screw
- // variable length of the hook-and-loop tape, or already equipped with hook-and-loop tape
- // provides a tangle-free and protective cable installation

// reusable

// cable bundles can be extended easily

// easy handling

// suitable for all material thickness

TECHNICAL DATA

Material: galvanised steel,
polyamid reinforced with glass fibre,
self-extinguishing according to UL94-V0
polypropylene

ACCESSORIES

// hook-and-loop tape on reel

HEBOFIX BASE FOR C-RAIL

ITEM DESCRIPTION	ORDER NO.	DETAILED DESCRIPTION	PU
KBS 4–20 GM C11 10	3011-232	clamping range 4–20 mm, hook-and-loop tape 10 mm, C11-rail	10
KBS 8–35 GM C11 20	3011-234	clamping range 8–35 mm, hook-and-loop tape 20 mm, C11-rail	10
KBS 10–60 GM C11 20	3011-236	clamping range 10–60 mm, hook-and-loop tape 20 mm, C11-rail	10
KBS 4–20 C16 10	3011-022	clamping range 4–20 mm, hook-and-loop tape 10 mm, C16-rail	10
KBS 8–35 C16 20	3011-024	clamping range 8–35 mm, hook-and-loop tape 20 mm, C16-rail	10
KBS 10–60 C16 20	3011-026	clamping range 10–60 mm, hook-and-loop tape 20 mm, C16-rail	10
KBS 20–100 GM C11/16	3011-030	cl. r. 20–100 mm, hook-and-loop tape 30 mm, C11/C16-rail, 2 x M6	10

HEBOFIX BASE FOR C-RAIL, EQUIPPED WITH HOOK-AND-LOOP TAPE

ITEM DESCRIPTION	ORDER NO.	DETAILED DESCRIPTION	PU
KBS 4–20 GM C11 10	3011-232-150	clamping range 4–20 mm, hook-and-loop tape 150 x 10 mm, C11-rail	10
KBS 8–35 GM C11 20	3011-234-180	clamping range 8–35 mm, hook-and-loop tape 180 x 20 mm, C11-rail	10
KBS 10–60 GM C11 20	3011-236-200	clamping range 10–60 mm, hook-and-loop tape 200 x 20 mm, C11-rail	10
KBS 4–20 C16 10	3011-022-150	clamping range 4–20 mm, hook-and-loop tape 150 x 10 mm, C16-rail	10
KBS 8–35 C16 20	3011-024-180	clamping range 8–35 mm, hook-and-loop tape 180 x 20 mm, C16-rail	10
KBS 10–60 C16 20	3011-026-200	clamping range 10–60 mm, hook-and-loop tape 200 x 20 mm, C16-rail	10
KBS 20–100 GM C11/16	3011-030-300	cl. r. 20–100 mm, hook-and-loop tape 300 x 30 mm, C11/C16-rail, 2 x M6	10



HEBOFIX base for 35 mm DIN rail

PRODUCT DESCRIPTION

The base for hook-and-loop fasteners serves as a gentle installation support of lines, cables and hoses. With the clip foot the base can be snapped on a 35 mm DIN rail. After that the base can be equipped with our hook-and-loop tape in variable length.

ADVANTAGES

- // simple mounting without tools onto DIN rails
- // variable length of the hook-and-loop tape, or already equipped with hook-and-loop tape
- // provides a tangle-free and protective cable installation
- // reusable

- // cable bundles can be extended easily
- // easy handling
- // reduced risk of injuries compared to use of cut off cable ties

TECHNICAL DATA

Material: polyamide, reinforced with glass fibre, self-extinguishing according to UL94-V0

ACCESSORIES

- // hook-and-loop tape on reel

HEBOFIX BASE FOR DIN RAIL

ITEM DESCRIPTION	ORDER NO.	DETAILED DESCRIPTION	PU
KBS-H 4-20 10	3011-042	clamping range 4-20 mm, hook-and-loop tape 7.5 and 10 mm	10
KBS-H 8-35 20	3011-044	clamping range 8-35 mm, hook-and-loop tape 20 mm	10
KBS-H 10-60 20	3011-046	clamping range 10-60 mm, hook-and-loop tape 20 mm	10

HEBOFIX BASE FOR DIN RAIL, EQUIPPED WITH HOOK-AND-LOOP TAPE

ITEM DESCRIPTION	ORDER NO.	DETAILED DESCRIPTION	PU
KBS-H 4-20 10	3011-042-150	clamping range 4-20 mm, hook-and-loop tape 150 x 10 mm	10
KBS-H 8-35 20	3011-044-180	clamping range 8-35 mm, hook-and-loop tape 180 x 20 mm	10
KBS-H 10-60 20	3011-046-200	clamping range 10-60 mm, hook-and-loop tape 200 x 20 mm	10



HEBOFIX base with expanding rivet

PRODUCT DESCRIPTION

The HEBOFIX base serves as an installation support and provides minimal damage during attachment of pipes, cables and tubes. By using the added expanding rivet the base can be mounted directly into borings of metal sheets. After that the base can be equipped, free of tools, with our hook-and-loop tape in variable lengths.

ADVANTAGES

- // easy mounting on metal sheets with borings
- // variable length of the hook-and-loop tape
- // provides a tangle-free and protective cable installation
- // reusable

- // cable bundles can be extended easily
- // easy handling
- // reduced risk of injuries compared to use of cut off cable ties

TECHNICAL DATA

Material: polyamid reinforced with glass fibre, self-extinguishing according to UL94-V0

ACCESSORIES

- // hook-and-loop tape on reel

HEBOFIX BASE WITH EXPANDING RIVET			
ITEM DESCRIPTION	ORDER NO.	DETAILED DESCRIPTION	PU
KBS-SN 4-20 10	3011-572	clamping range 4-20 mm, with expanding rivet 4 mm	10
KBS-SN 8-35 20	3011-574	clamping range 8-35 mm, with expanding rivet 5 mm	10
Expanding rivet 4	3011-340	Expanding rivet 4 mm	100
Expanding rivet 5	3011-344	Expanding rivet 5 mm	100



HEBOFIX Maintenance Box

PRODUCT DESCRIPTION

With the HEBOFIX Maintenance Box, you always have the fitting HEBOFIX base and the appropriate hook-and-loop tape close at hand.

The box is equipped with HEBOFIX bases for the clamping areas 4 - 20 mm, 8 - 35 mm, 10 - 60 mm and 20 - 100 mm for direct mounting and also clamping feet for aluminium profiles.

The matching hook-and-loop tapes in the widths of 10 mm, 20 mm and 30 mm on reel are also included.

The hook-and-loop tape, coming in the high-quality FRT-version according to UL94-V2, can easily be cut to the desired length.

ADVANTAGES

- // all parts are clearly arranged
- // set box in sturdy workshop design
- // universally usable
- // hook-and-loop tape self-extinguishing according to UL94-V2

CONTENT

- // HEBOFIX base with clamping foot for aluminium profiles
- // HEBOFIX base for direct mounting
- // hook-and-loop tape in the widths of 10 mm, 20 mm and 30 mm
- // mounting adapters and sliding nuts for mounting on C-rails

HEBOFIX MAINTENANCE BOX

ITEM DESCRIPTION	ORDER NO.	DETAILED DESCRIPTION	PU
HEBOFIX BOX B8 B10 I8	3029-002	Maintenance Box Bosch / Item mixed	1
HEBOFIX BOX I8M	3029-004	Maintenance Box Item 8 mm rabbet	1
HEBOFIX BOX B8M B10M	3029-006	Maintenance Box Bosch 8 mm and 10 mm rabbet	1
HEBOFIX BOX D	3029-010	Maintenance Box direct assembly	1
HEBOFIX BOX xxx	3029-xxx	Maintenance Box customised	3



Mounting accessories for HEBOFIX base

PRODUCT DESCRIPTION

The accessories for HEBOFIX base for hook-and-loop tape allows mounting the base onto a variety of mounting rails.

ADVANTAGES

- // can be combined with the HEBOFIX base for hook-and-loop tape
- // self-anchoring slot nut with balls and springs

// mounting adapter for C-rails for 90° mounting

// clip-foot for tool-free assembly onto a 35 mm DIN rail

TECHNICAL DATA

Material: galvanised steel,
nickle-plated steel

MOUNTING ACCESSORIES FOR HEBOFIX BASE FOR HOOK-AND-LOOP TAPE			
ITEM DESCRIPTION	ORDER NO.	DETAILED DESCRIPTION	PU
C11/5 GM	3011-308	sliding nut M5 for C-rail 11 mm	10
C16/4 KBS 20	3011-204	mounting adapter for C-rail 16mm for KBS 8–35, KBS 10–60, M4	10
C16/4 HSKB 16	3011-206	mounting adapter for C-rail 16mm for KBS 4–20, M4	10
Slot nut 8, M4	3011-301	slot nut for 8 mm profile groove, M4	10
Slot nut 8, M5	3011-305	slot nut for 8 mm profile groove, M5	10
Slot nut 8, M6	3011-306	slot nut for 8 mm profile groove, M6	10
Clip foot M4	1030-020	clip foot for 35 mm DIN rail, M4	25
Clip foot M5	1030-022	clip foot for 35 mm DIN rail, M5	25



Hook-and-loop fastener

PRODUCT DESCRIPTION

The hook-and-loop fastener is used for a safe and gentle attachment of pipes, cables and hoses. The fastener is available for direct mounting with an M5-screw or for a second use with integrated clamp mechanism for profiles with a 10 mm slot width.

ADVANTAGES

- // self-extinguishing fasteners according to UL94-V2
- // cable bundles can be extended easily

- // easy handling
- // reduced risk of injuries compared to the use of cut off cable ties

TECHNICAL DATA

Material: base made of polyamide, reinforced with glass fibre
hook-and-loop tape self-extinguishing according to UL94-V2

HOOK-AND-LOOP FASTENER			
ITEM DESCRIPTION	ORDER NO.	DIMENSION	PU
KBH 6-20	3010-001	clamping range 6-20 mm	10
KBH 6-35	3010-002	clamping range 6-35 mm	10
KBH 6-60	3010-003	clamping range 6-60 mm	10
KBHP 6-20	3010-004	clamping range 6-20 mm, for profile slot 10 mm	10
KBHP 6-35	3010-005	clamping range 6-35 mm, for profile slot 10 mm	10
KBHP 6-60	3010-006	clamping range 6-60 mm, for profile slot 10 mm	10



Clip foot for 35 mm DIN rail

PRODUCT DESCRIPTION

The clip foot can be snapped onto a 35 mm DIN rail without the use of tools.

A small slot screwdriver suffices to dismantle the shield clamp.

The clip foot serves as a universal multi-equipment carrier for assembly on 35 mm DIN rails. It is available in single and double design, also with various bore diameters and threads.

ADVANTAGES

- // high conductance
- // suitable clip foot for each individual application

TECHNICAL DATA

Material: nickle-plated spring steel

CLIP FOOT FOR 35 MM DIN RAIL			
ITEM DESCRIPTION	ORDER NO.	DETAILED DESCRIPTION	PU
Clip foot M4	1030-020	with thread boring for M4	25
Clip foot 4	1030-021	with boring 3.9 mm	25
Clip foot M5	1030-022	with thread boring for M5	25
Clip foot double M4	1030-025	double, with thread boring for M4	25
Clip foot double M5	1030-026	double, with thread boring for M5	25



Clip foot Multi for 35 mm DIN rail

PRODUCT DESCRIPTION

The clip foot Multi can be snapped onto a 35 mm DIN rail without the use of tools. A small slot screwdriver suffices to dismantle.

The clip foot Multi serves as a universal multi-equipment carrier for assembly on 35 mm DIN rails. It is in two widths and each with M4 or M5 thread available. Due to the flat shape, a good contact surface and a good holding force on the DIN rail is achieved.

ADVANTAGES

- // high clamping forces
- // high conductance
- // suitable clip foot for each individual application

TECHNICAL DATA

Material: galvanised spring steel

CLIP FOOT MULTI FOR 35 MM DIN RAIL			
ITEM DESCRIPTION	ORDER NO.	DETAILED DESCRIPTION	PU
HSF 13 M4	1030-054	width 13mm, boring for M4	25
HSF 13 M5	1030-055	width 13mm, boring for M5	25
HSF 15 M4	1030-044	width 15mm, boring for M4	25
HSF 15 M5	1030-045	width 15mm, boring for M5	25



Mounting adapter for C-rail

PRODUCT DESCRIPTION

The mounting adapter serves as a universal device carrier for mounting onto C-rails.

It can be used by a 90° turn into the C-rail profile with a 16 mm port. The mounting adapter can be secured by tightening a M4 screw. In connection with HEBOTEC products, the mounting adapter is available with the appropriate twist-protection.

ADVANTAGES

- // easy 90° turn mounting
- // high conductivity
- // good contact surface on the C-rail
- // twist-protection available

TECHNICAL DATA

Material: galvanised steel

MOUNTING ADAPTER FOR C-RAIL			
ITEM DESCRIPTION	ORDER NO.	DETAILED DESCRIPTION	PU
C16/4	3011-202	without twist-protection, M4	10
C16/4 KBS 20	3011-204	with twist-protection for KBS 8–35, KBS 10–60, -M4	10
C16/4 HSKB 16	3011-206	with twist-protection for shield clamp Big HSKB 16–35, KBS 4–20, M4	10
C16/4 HSKB 35	3011-208	with twist-protection for shield clamp Big HSKB 35–65, M4	10
C16/4 SKD	3011-210	with twist-protection for shield clamp SKD, SKDZ, M4	10

Für Ihre Notizen

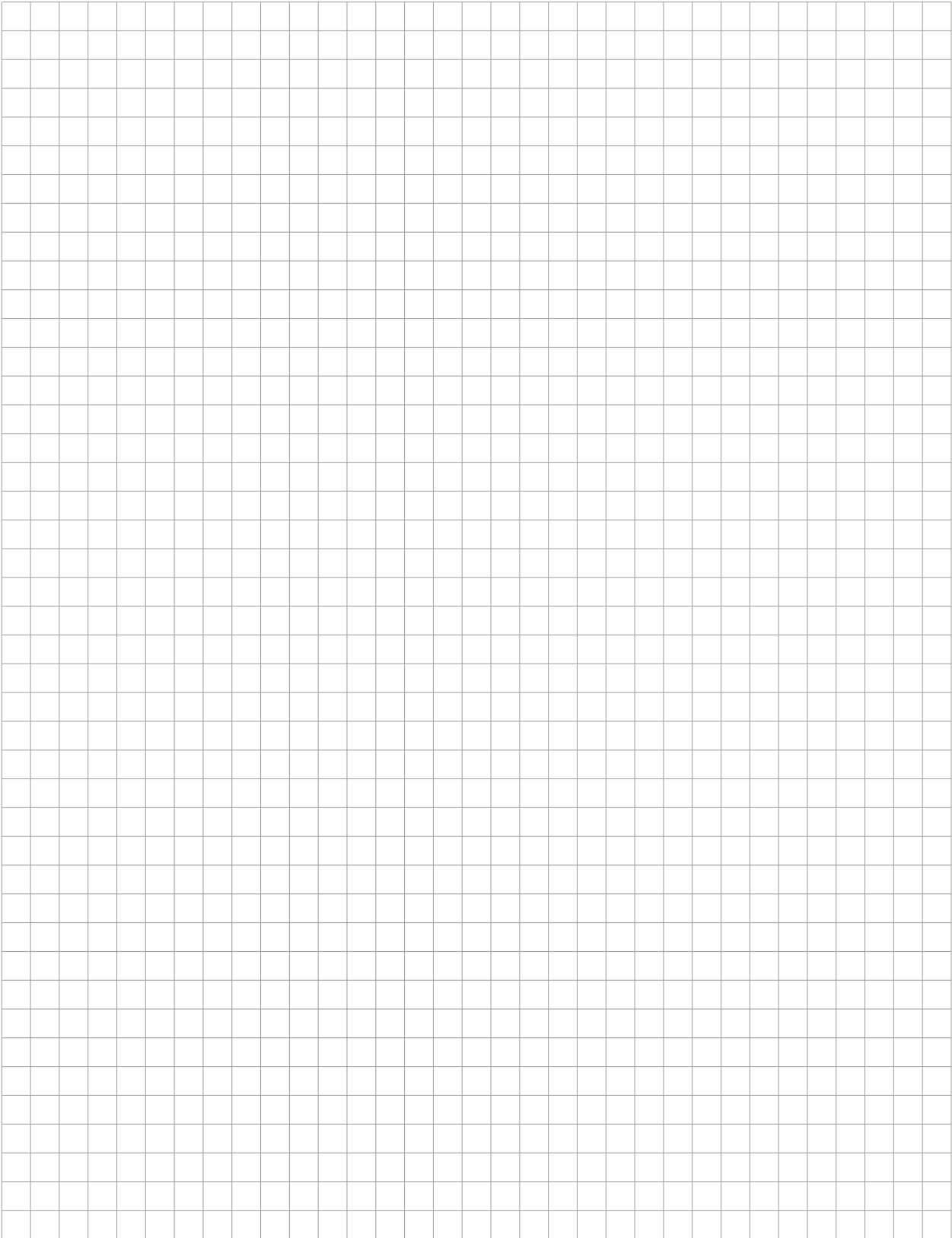

Für Ihre Notizen



REPRESENTED BY



HEBOTEC

HEBOTEC GmbH
Ulrichstraße 21
72116 Moessingen
Germany

fon +49 (0) 74 73 – 95 346-0
fax +49 (0) 74 73 – 95 346-99
mail info@hebotec.de
internet www.hebotec.de