

EMC cable glands with moving spring contact

EMC 3 Cable Glands Brass

M32x1,5 / 15,0-21,0mm / TL=8,0mm

BMEM-E4

- Specially designed EMC protective cable glands.
- Long-lasting contact by high definition contact spring.
- Moving spring contact offers reduced risk of sheath damage.
- Easy assembly: install cable gland - prepare cable sheath - insert cable - tighten cap.
- High quality strain relief and sealing, reliable performance for EMC applications.
- Up-to-date international approvals.

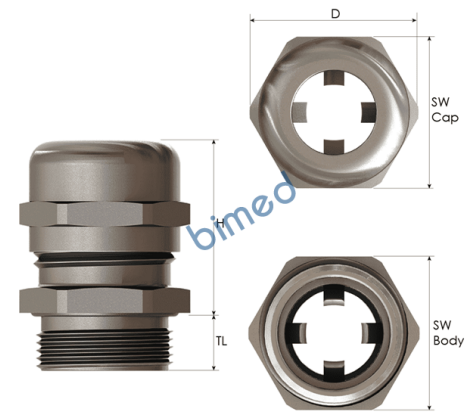

Images might not be representative of the actual colour, size or shape of the product listed



TYPE 4X



File Number	Standard
VDE_40039349	DIN EN 62444
E199260	UL514B, CSA22.2 No 18.3-12, CSA22.2 No 94.2-15 UL50E
TAE00003WY	EN62444
GOST	

Technical Details		
Material	Body , Cap	Brass Nickel plated
	Seal	CR (Chloroprene)
	Clamping Insert	PA 6 (Polyamide 6)
	Contact Spring	Special Copper Alloy
	O-Ring	NBR
Ingress Protection Rating	IP 68 - 5 Bar, 30 min	
UL Environmental Rating	TYPE 4X acc. to UL 50E	
Flammability	V2 according to UL94	
Operating Temperature	Permanent	Intermittent
	-20 °C to +100 °C	-40 °C to +150 °C
Thread Type	Metric EN 60423 Other thread types also available upon request.	
Cable Type	Shielded	
Accessories	EMC Lock nuts	
	Dome plugs	
	Gaskets (Washers)	
Remarks	In compliance with DIN EN 62444.	
	We recommend the use of lock nuts and gaskets to ensure IP rating for - rough surfaces or through holes.	
	Some approvals do not cover all sizes.	
	O-ring available in Metric and PG threads as a standard. For NPT - threads O-ring available upon request.	
	Accessories must be ordered separately.	
	Other lock nut types also available upon request.	
Outer	Thread Size (Male)	M32x1,5
	Thread Length (TL)	8,0 mm
	Ø (D)	37,5 mm
Clamping Range Outer Sheath Ø min - max		15,0 - 21,0 mm
Shield Diameter Ø min-max		13,5 - 19,0 mm
Spanner Width	Cap	34 mm
	Body	34 mm
max. Height (H)	38,0 mm	
Part Number	BMEM-E4	

