



# RESULTS BOOK

KARATE1 PREMIER LEAGUE - CAIRO  
2024

2024.04.19 - 2024.04.21

CAIRO

EGYPT, EGY

## TABLE OF CONTENTS

NUMBER OF ENTRIES .....	3
ENTRYLIST .....	5
ENTRYLIST BY WEIGHT CATEGORY .....	14
STATISTICS .....	24
FEMALE KATA .....	25
FEMALE KUMITE -50 KG .....	38
FEMALE KUMITE -55 KG .....	51
FEMALE KUMITE -61 KG .....	64
FEMALE KUMITE -68 KG .....	77
FEMALE KUMITE 68+ KG .....	90
MALE KATA .....	103
MALE KUMITE -60 KG .....	116
MALE KUMITE -67 KG .....	129
MALE KUMITE -75 KG .....	142
MALE KUMITE -84 KG .....	155
MALE KUMITE 84+ KG .....	168
OFFICIAL RESULTS .....	181





# Karate1 Premier League - Cairo 2024

EGYPT  
Cairo

2024.04.19 - 2024.04.21



## NUMBER OF ENTRIES

#	Code	Country	Male Entries	Female Entries	Total Entries	Total Athletes
1		ALB ALBANIA	2	0	2	2
2		ALG ALGERIA	3	4	7	7
3		ARM ARMENIA	0	1	1	1
4		AUT AUSTRIA	1	3	4	4
5		AZE AZERBAIJAN	8	2	10	10
6		BEL BELGIUM	3	3	6	6
7		BIH BOSNIA AND HERZEGOVINA	2	1	3	3
8		BRA BRAZIL	1	1	2	2
9		CAN CANADA	1	1	2	2
10		CHI CHILE	4	4	8	8
11		TPE CHINESE TAIPEI	1	1	2	2
12		COL COLOMBIA	1	1	2	2
13		CRO CROATIA	3	6	9	9
14		CUR CURACAO	1	0	1	1
15		CYP CYPRUS	1	2	3	3
16		CZE CZECH REPUBLIC	0	1	1	1
17		EGY EGYPT	12	16	28	28
18		ESA EL SALVADOR	0	1	1	1
19		ENG ENGLAND	1	1	2	2
20		FIN FINLAND	2	1	3	3
21		FRA FRANCE	8	9	17	17
22		GEO GEORGIA	4	0	4	4
23		GER GERMANY	3	11	14	14
24		GRE GREECE	4	6	10	10
25		GUA GUATEMALA	0	1	1	1
26		HKG HONG KONG, CHINA	2	5	7	7
27		HUN HUNGARY	2	0	2	2
28		INA INDONESIA	0	2	2	2
29		ITA ITALY	23	17	40	40
30		JPN JAPAN	17	15	32	32
31		JOR JORDAN	7	1	8	8
32		KAZ KAZAKHSTAN	6	6	12	12
33		KUW KUWAIT	5	0	5	5
34		LAT LATVIA	1	1	2	2
35		LBA LIBYA	1	0	1	1
36		LUX LUXEMBOURG	0	1	1	1
37		MAS MALAYSIA	0	1	1	1
38		MNE MONTENEGRO	1	0	1	1
39		MAR MOROCCO	2	4	6	6
40		NED NETHERLANDS	2	3	5	5
41		MKD NORTH MACEDONIA	2	1	3	3
42		PER PERU	0	1	1	1
43		POL POLAND	2	2	4	4
44		POR PORTUGAL	1	2	3	3
45		PUR PUERTO RICO	0	1	1	1
46		ROU ROMANIA	2	0	2	2















# Karate1 Premier League - Cairo 2024

EGYPT  
Cairo

2024.04.19 - 2024.04.21



## NUMBER OF ENTRIES

#	Code	Country	Male Entries	Female Entries	Total Entries	Total Athletes
47	 KSA	SAUDI ARABIA	2	0	2	2
48	 SCO	SCOTLAND	0	1	1	1
49	 SVK	SLOVAKIA	3	5	8	8
50	 ESP	SPAIN	1	8	9	9
51	 SWE	SWEDEN	2	1	3	3
52	 SUI	SWITZERLAND	2	5	7	7
53	 TUN	TUNISIA	0	3	3	3
54	 TUR	TURKIYE	15	10	25	25
55	 UKR	UKRAINE	14	7	21	21
56	 UAE	UNITED ARAB EMIRATES	0	2	2	2
57	 USA	UNITED STATES	5	2	7	7
58	 VEN	VENEZUELA	0	1	1	1
<b>Totals:</b>			186	185	371	371



# Karate1 Premier League - Cairo 2024



## ENTRIES BY NOC

As of 21 APR 2024

NOC Code	Gender	Name	Date Of Birth	Event	Seed
ALB	M	Arifi Orges	25 JUL 1995	Male Kumite -60 Kg	22
	M	GASHI MELOS	28 MAI 2003	Male Kumite -84 Kg	15
ALG	M	DAIKHI HOCINE	21 SEP 1996	Male Kumite 84+ Kg	15
	M	MIDOUNE FALLEH	17 SEP 2003	Male Kumite -84 Kg	16
	M	ZAID OUSSAMA	03 FEB 2000	Male Kumite -75 Kg	17
	F	ABOURICHE LOUIZA	04 APR 2003	Female Kumite -55 Kg	7
	F	OUDIRA CHAIMA	02 JUN 2004	Female Kumite 68+ Kg	21
	F	OUIKENE CYLIA	07 SEP 2003	Female Kumite -50 Kg	20
	F	Sekkour Rayane	18 JAN 2001	Female Kumite -50 Kg	29
ARM	F	MAKYAN ANITA	03 FEB 2000	Female Kumite -68 Kg	25
AUT	M	POKORNY STEFAN	14 NOC 1991	Male Kumite -75 Kg	13
	F	TOPALOVIC LEJLA	03 JAN 2001	Female Kumite -61 Kg	21
	F	VUKOVIC MARINA	04 FEB 2003	Female Kumite -68 Kg	27
	F	ZILLER LORA	24 AUG 1999	Female Kumite 68+ Kg	32
AZE	M	AGHALARZADE TURAL	06 JUL 1993	Male Kumite -67 Kg	5
	M	AGHAYEV FARID	18 JUL 2002	Male Kumite -75 Kg	20
	M	GULIYEV AMINAGHA	18 SEP 2002	Male Kumite -60 Kg	17
	M	GURBANLI ASIMAN	10 AUG 1992	Male Kumite 84+ Kg	11
	M	HASANOV TURGUT	07 SEP 1993	Male Kumite -84 Kg	24
	M	OSMANLI OSMAN	07 MAR 2003	Male Kumite 84+ Kg	24
	M	RZAZADE NURAN	28 JUL 2002	Male Kumite -67 Kg	14
	M	SAVADOV FARID	09 MAR 2005	Male Kumite -60 Kg	10
	F	SADIGOVA MADINA	01 JUN 2001	Female Kumite -55 Kg	13
	F	TEYMUROVA FIDAN	02 JAN 2000	Female Kumite -50 Kg	11
BEL	M	ABDELMALKI AMIN	15 FEB 2006	Male Kumite -67 Kg	23
	M	ABDELMALKI ANASS	10 APR 2003	Male Kumite -60 Kg	15
	M	MAHAUDEN QUENTIN	12 MAR 2001	Male Kumite -75 Kg	3
	F	AJARAY MARYAM	07 JAN 2003	Female Kumite -61 Kg	7
	F	MANCA CHIARA	31 JUL 2004	Female Kata	19
	F	MULOLO OPHELIE	29 SEP 1999	Female Kumite 68+ Kg	18
BIH	M	BOSTANDZIC ANES	01 JUN 2004	Male Kumite 84+ Kg	3
	M	TURULJA HAMZA	09 AUG 2001	Male Kumite -75 Kg	14
	F	KRESIC STEFANI	10 MAI 2001	Female Kumite 68+ Kg	6
BRA	M	FIGUEIRA VINICIUS	15 APR 1991	Male Kumite -67 Kg	16
	F	KUMIZAKI VALERIA	15 APR 1985	Female Kumite -55 Kg	17
CAN	M	MIRI YASSIN	05 MAI 2004	Male Kumite -60 Kg	32
	F	FURUMOTO-DESHAIES HANA	21 MAI 1996	Female Kumite -55 Kg	5
CHI	M	FREIRE FUENTES TOMAS	06 MAI 2003	Male Kumite -67 Kg	26
	M	RODRIGUEZ FUENTES MATIAS	02 OCT 1996	Male Kumite -75 Kg	18
	M	ROJAS RODRIGO	11 JUN 1990	Male Kumite 84+ Kg	7
	M	VILLALON RUIZ ENRIQUE	04 FEB 2001	Male Kumite -60 Kg	25
	F	GONZALEZ LAVIN JAVIERA	13 OCT 1996	Female Kumite 68+ Kg	28
	F	TORO MENESES VALENTINA	17 FEB 2000	Female Kumite -55 Kg	8
	F	VEGA ROJAS FERNANDA	23 AUG 2002	Female Kumite -50 Kg	30



# Karate1 Premier League - Cairo 2024



## ENTRIES BY NOC

As of 21 APR 2024

NOC Code	Gender	Name	Date Of Birth	Event	Seed
CHI	F	VELOZO ANASTASIIA	02 APR 1996	Female Kumite -68 Kg	30
TPE	M	SHIH CHENG-CHUNG	13 AUG 2000	Male Kumite -67 Kg	8
	F	KU TSUI-PING	13 OCT 1995	Female Kumite -55 Kg	3
COL	M	FORERO JUAN DAVID	06 DEC 1993	Male Kumite -60 Kg	21
	F	CARDENAS BALCAZAR SOFIA	11 NOC 2004	Female Kumite -50 Kg	18
CRO	M	GARIBOVIC ENES	22 APR 1996	Male Kumite -84 Kg	11
	M	KVESIC ANDJELO	08 JUN 1995	Male Kumite 84+ Kg	4
	M	KVESIC IVAN	13 OCT 1996	Male Kumite -84 Kg	10
	F	BECIROVIC SADEA	23 AUG 2000	Female Kumite -68 Kg	11
	F	CACKO MIA	17 JUL 2005	Female Kumite -61 Kg	26
	F	LESJAK LUCIJA	30 NOC 1999	Female Kumite 68+ Kg	7
	F	PEHAR JELENA	27 FEB 2000	Female Kumite -50 Kg	16
	F	SGARDELLI EMA	27 MAR 2004	Female Kumite -50 Kg	5
	F	VUKOJA LEA	19 JUN 2001	Female Kumite -68 Kg	15
CUR	M	Timmermans Rob	21 MAI 1996	Male Kumite 84+ Kg	5
CYP	M	STYLIANOU MATHAIOS	06 SEP 1997	Male Kumite 84+ Kg	25
	F	GIAMOUKI THEODOSIA	07 NOC 1998	Female Kumite 68+ Kg	14
	F	KONTOU IRENE	17 OCT 2003	Female Kumite -50 Kg	14
CZE	F	MISKOVA VERONIKA	03 DEC 1992	Female Kata	17
EGY	M	Abdelaziz Abdalla	29 MAR 1999	Male Kumite -75 Kg	1
	M	Abdelgawad ABDALLA HESHAM	02 SEP 2000	Male Kumite -75 Kg	15
	M	Aboukora Amr Alaa	18 NOC 2000	Male Kumite -60 Kg	11
	M	Aly Zyad	02 MAI 2000	Male Kumite -60 Kg	30
	M	Badawy Mahmoud	01 JUL 1998	Male Kumite 84+ Kg	29
	M	Badawy Youssef	06 AUG 2001	Male Kumite -84 Kg	2
	M	Elmasry Ahmed	10 NOC 1998	Male Kumite 84+ Kg	18
	M	Elsawy Ali	16 FEB 1995	Male Kumite -67 Kg	15
	M	FARAG YOUSSEF	17 NOC 2005	Male Kumite -75 Kg	22
	M	KHALIL MAHMOUD GALAL	15 AUG 1999	Male Kumite 84+ Kg	28
	M	Mahmoud Taha tarek	20 SEP 2000	Male Kumite 84+ Kg	1
	M	MOHAMED HAZEM	17 SEP 2002	Male Kumite 84+ Kg	22
	F	ABDELAZIZ FERYAL	16 FEB 1999	Female Kumite -68 Kg	18
	F	Allam Asmaa	15 AUG 2000	Female Kata	32
	F	ALY GANNA	01 OCT 2005	Female Kumite -50 Kg	12
	F	ALY NOURSIN	12 JAN 2002	Female Kumite -61 Kg	15
	F	Attia Mirna	14 AUG 2000	Female Kumite -55 Kg	28
	F	EIEzaby Mariam	22 MAR 2007	Female Kata	23
	F	ELMEDANY OLA	13 JUN 1998	Female Kumite -68 Kg	16
	F	Hassan Salma	15 FEB 2001	Female Kumite -55 Kg	29
	F	HELMY HABIBA	03 DEC 2000	Female Kumite 68+ Kg	22
	F	HENDY HADIR	20 JUL 1996	Female Kumite -68 Kg	31
	F	Hesham Aya	12 FEB 1998	Female Kata	21
	F	Khamis Jana1	20 DEC 2005	Female Kata	27
	F	OKILA MENNA SHAABAN	25 MAI 2000	Female Kumite 68+ Kg	4
	F	SALAMA REEM AHMED	19 DEC 1999	Female Kumite -50 Kg	1



## Karate1 Premier League - Cairo 2024



### ENTRIES BY NOC

As of 21 APR 2024

NOC Code	Gender	Name	Date Of Birth	Event	Seed
EGY	F	Yasser Nagham	26 NOC 2003	Female Kumite -50 Kg	32
	F	ZEINELABDIN MAYAR	05 FEB 2004	Female Kumite -68 Kg	24
ESA	F	IZAGUIRRE GABRIELLA	02 AUG 2002	Female Kumite -50 Kg	13
ENG	M	Wilson Joby	19 MAI 1993	Male Kumite -67 Kg	29
	F	Walters Rochelle	21 MAR 2000	Female Kumite 68+ Kg	16
FIN	M	Kulovuori Bjorn	12 JUN 2000	Male Kumite -84 Kg	21
	M	Mantere Niko	05 OCT 1999	Male Kumite -84 Kg	23
	F	Keinanen Titta	28 OCT 1993	Female Kumite 68+ Kg	29
FRA	M	ABDESSELEM RAYBAK	16 AUG 2001	Male Kumite -84 Kg	19
	M	BERTHON ENZO	10 APR 2000	Male Kumite -75 Kg	4
	M	CIZO KILIAN	06 JUL 2000	Male Kumite -75 Kg	26
	M	LE THANH LIEM	20 APR 1998	Male Kumite -75 Kg	25
	M	MARQUES Adrien	27 SEP 2002	Male Kumite -84 Kg	30
	M	MEZIANE Rayyan	10 JUN 2002	Male Kumite -60 Kg	8
	M	NGOAN Franck	18 MAI 2000	Male Kata	20
	M	TAS SAMI	05 OCT 2000	Male Kumite -60 Kg	29
	F	AGIER ALIZEE	07 JUL 1994	Female Kumite -68 Kg	4
	F	AVAZERI LEA	11 JUN 1998	Female Kumite -61 Kg	13
	F	CHARIF ASSMA	09 OCT 2002	Female Kumite -55 Kg	22
	F	FERACCI Alexandra	10 OCT 1992	Female Kata	28
	F	GARCIA NANCY	15 MAR 1996	Female Kumite 68+ Kg	27
	F	PEA Clemence	09 APR 2003	Female Kumite 68+ Kg	26
	F	Sivert Laura	27 MAR 1997	Female Kumite -61 Kg	12
	F	SOMBE Thalya	21 OCT 2003	Female Kumite -68 Kg	2
F	TAILY Helvetia	11 APR 1999	Female Kata	10	
GEO	M	GELASHVILI MERABI	07 NOC 2004	Male Kumite 84+ Kg	12
	M	KIPAROIDZE KHVICHIA	30 AUG 1997	Male Kumite -84 Kg	26
	M	PONIAVA VALIKO	03 MAI 2004	Male Kumite -75 Kg	27
	M	TKEBUCHAVA DAVID	24 JUN 1988	Male Kumite -60 Kg	20
GER	M	HAAS FLORIAN	16 FEB 2000	Male Kumite -60 Kg	12
	M	OEZDEMIR MUHAMMED	30 APR 2004	Male Kumite -67 Kg	10
	M	SEKOT NIKOLAI	03 JUL 2004	Male Kumite 84+ Kg	14
	F	BITSCH MIA	12 JAN 2004	Female Kumite -55 Kg	4
	F	BUGUR GIZEM	27 NOC 1998	Female Kumite -55 Kg	10
	F	Bugur Seden	18 AUG 2002	Female Kumite -50 Kg	21
	F	HUBRICH SHARA	15 SEP 1997	Female Kumite -50 Kg	6
	F	JAY SHIRLEY	27 AUG 2007	Female Kata	14
	F	JUETTNER JASMIN	22 MAI 1993	Female Kata	18
	F	KHAMIS REEM	07 DEC 2002	Female Kumite -61 Kg	2
	F	KNEER JOHANNA	25 DEC 1997	Female Kumite 68+ Kg	10
	F	LUECKE AMELIE	20 JUL 2003	Female Kumite 68+ Kg	9
	F	SCHROETER MADELEINE	10 DEC 1999	Female Kumite -68 Kg	7
F	Stamer Selina	17 JAN 1999	Female Kumite 68+ Kg	25	
GRE	M	BALLOTIS GEORGIOS	07 MAR 2005	Male Kumite -67 Kg	20
	M	MASTROGIANNIS KONSTANTINOS	27 DEC 2000	Male Kumite -84 Kg	6



# Karate1 Premier League - Cairo 2024



## ENTRIES BY NOC

As of 21 APR 2024

NOC Code	Gender	Name	Date Of Birth	Event	Seed
GRE	M	NIKOPOULOS ATHANASIOS	27 MAI 1998	Male Kumite 84+ Kg	16
	M	XENOS CHRISTOS-STEFANOS	21 MAR 2000	Male Kumite -60 Kg	1
	F	CHRYSOPOULOU KONSTANTINA	23 JUL 2004	Female Kumite -61 Kg	11
	F	PEPPA KONSTANTINA-EVANGELIA	08 SEP 2000	Female Kumite -68 Kg	23
	F	Stoli Maria	16 FEB 1999	Female Kumite -55 Kg	9
	F	TSIAKMAKI ATHINA	10 JUL 2007	Female Kata	20
	F	TZILIA STYLIANI-ELENI	02 APR 2004	Female Kumite -50 Kg	24
	F	XENOU GEORGIA ARCHONTIA	10 JUN 1997	Female Kata	13
GUA	F	MORALES CHAVEZ BARBARA MICHELLE	19 FEB 1998	Female Kumite -50 Kg	31
HKG	M	CHAU KA HIM	27 JUL 2000	Male Kumite -60 Kg	27
	M	HUNG HO WAI HOWARD	04 DEC 1992	Male Kata	19
	F	LAU MO SHEUNG GRACE	19 OCT 1991	Female Kata	1
	F	LO SUM MAN	03 JUL 2001	Female Kata	26
	F	TUNG YEE YIN	01 APR 1988	Female Kata	24
	F	WONG CHEUK LEE	07 OCT 1993	Female Kumite -68 Kg	22
	F	WONG SZE MAN	22 NOC 1992	Female Kata	22
HUN	M	Bardos Adam	02 AUG 2004	Male Kata	25
	M	NAGY BOTOND	06 DEC 1994	Male Kata	12
INA	F	AGUNG SANISTYARANI COK ISTRY	31 DEC 1994	Female Kumite -55 Kg	16
	F	ZEFANYA CEYCO GEORGIA	24 JUN 1999	Female Kumite -68 Kg	3
ITA	M	AVANZINI MATTEO	30 APR 2004	Male Kumite 84+ Kg	9
	M	CIANI MICHELE	24 JUL 1998	Male Kumite 84+ Kg	31
	M	CRESCENZO ANGELO	05 AUG 1993	Male Kumite -60 Kg	2
	M	DE VIVO DANIELE	18 JAN 2003	Male Kumite -75 Kg	12
	M	DE VIVO GIANLUCA	16 AUG 1992	Male Kumite -67 Kg	4
	M	FIORE MATTEO	23 OCT 2002	Male Kumite -84 Kg	9
	M	Forino Alessandro	21 APR 2000	Male Kumite 84+ Kg	30
	M	Gallo Gianluca	20 DEC 1996	Male Kata	28
	M	Gentile Samuele	07 DEC 1998	Male Kumite -60 Kg	28
	M	GHINAMI ALESSIO	11 JUN 2002	Male Kata	11
	M	GHISLANDI MICHAEL	21 MAR 1999	Male Kumite 84+ Kg	21
	M	Grazia Manuel	28 OCT 2002	Male Kata	26
	M	GRECO DANILO	27 MAI 1999	Male Kumite -60 Kg	23
	M	Iannuzzi Mario	27 OCT 2005	Male Kumite -75 Kg	29
	M	Luciano Carmine	19 DEC 2001	Male Kumite -60 Kg	14
	M	MARESCA LUCA	28 DEC 1993	Male Kumite -67 Kg	12
	M	marino simone	08 DEC 1996	Male Kumite 84+ Kg	26
	M	MARTINA MICHELE	18 NOC 1996	Male Kumite -84 Kg	3
	M	Mazzoleni Fabio	15 APR 2000	Male Kumite 84+ Kg	20
	M	Panagia Giuseppe	09 JAN 1999	Male Kata	31
M	Pietromarchi Lorenzo	07 APR 1998	Male Kumite -75 Kg	7	
M	Polsinelli Guido	06 OCT 2004	Male Kata	30	
M	Rossi Joseph	08 JUN 1999	Male Kumite -75 Kg	24	
F	AGUS ASIA	31 OCT 2001	Female Kumite -50 Kg	10	





# Karate1 Premier League - Cairo 2024



## ENTRIES BY NOC

As of 21 APR 2024

NOC Code	Gender	Name	Date Of Birth	Event	Seed
ITA	F	amato carolina	14 SEP 2000	Female Kata	30
	F	ANGELUCCI GIULIA	06 AUG 2000	Female Kumite -61 Kg	24
	F	Bodei Pamela	29 JUN 2001	Female Kumite -68 Kg	17
	F	BRUNORI VERONICA	14 SEP 2000	Female Kumite -55 Kg	11
	F	Casale Carola	07 NOC 1998	Female Kata	25
	F	COLLETTI EMMA	26 JAN 2006	Female Kumite -50 Kg	22
	F	D ONOFRIO TERRYANA	28 JAN 1997	Female Kata	6
	F	DESIDERIO ANNA PIA	19 DEC 2005	Female Kumite -68 Kg	19
	F	FERRACUTI CLIO	10 OCT 1996	Female Kumite 68+ Kg	3
	F	Lallo viola	23 MAI 1996	Female Kumite -55 Kg	27
	F	Mancinelli Syria	22 JUN 2001	Female Kumite -55 Kg	18
	F	Mangiacapra Alessandra	10 JUL 1999	Female Kumite -61 Kg	28
	F	MARTURANO IRENE	09 JUL 2005	Female Kumite -61 Kg	23
	F	PERFETTO ERMINIA	09 JUN 1995	Female Kumite -50 Kg	3
	F	SEMERARO SILVIA	02 MAI 1996	Female Kumite -68 Kg	5
F	STASI LINDA	02 FEB 1999	Female Kumite 68+ Kg	31	
JPN	M	ABE SAKICHI	05 DEC 2002	Male Kata	8
	M	ETO JUNYA	13 FEB 1999	Male Kumite -84 Kg	13
	M	FUNADA AOI	20 JUL 2001	Male Kata	7
	M	HASHIMOTO HIROMU	01 MAI 2000	Male Kumite -60 Kg	3
	M	Ikeda Ryusei	31 DEC 1998	Male Kata	6
	M	Kikuchi Ryonosuke	26 JUL 1999	Male Kata	5
	M	MACHIDA YASUHIRO	02 AUG 1998	Male Kata	13
	M	Mori Yuta	28 APR 1994	Male Kumite -84 Kg	29
	M	Moto Kazumasa	24 AUG 1995	Male Kata	4
	M	Moto Ryuji	19 JUN 1997	Male Kata	14
	M	Nakano Soichiro	02 MAR 1998	Male Kumite -67 Kg	11
	M	Nishiyama Kakeru	20 AUG 1995	Male Kata	1
	M	Sakiyama Yusei	28 AUG 1999	Male Kumite -75 Kg	11
	M	Sato Yuki	25 DEC 1998	Male Kata	17
	M	Shimada Rikito	25 DEC 1999	Male Kumite -84 Kg	5
	M	Suzuki Shunji	11 SEP 1998	Male Kumite -75 Kg	23
	M	Yoshimura Fumiya	15 AUG 1998	Male Kumite 84+ Kg	10
	F	Azuma Saeko	10 JAN 2001	Female Kata	11
	F	hisami Nakaji	06 OCT 2003	Female Kata	12
	F	KAMA TSUBASA	10 DEC 2003	Female Kumite -68 Kg	6
	F	Kujuro Yuki	15 JUL 1999	Female Kumite -61 Kg	10
	F	MISHIMA KIRI	27 OCT 2000	Female Kata	4
	F	OHUCHI MIRISA	11 JAN 2002	Female Kata	2
	F	Ono Maho	09 FEB 1999	Female Kata	5
	F	SAWAE YUZUKI	21 APR 2000	Female Kumite 68+ Kg	5
	F	SHIMA AIRI	12 DEC 2000	Female Kumite -55 Kg	6
	F	Shimada Sarara	05 JUL 2001	Female Kumite -61 Kg	5
F	Shimizu Natsuki	29 JUL 1997	Female Kata	15	
F	TSUTSUMI SARA	29 MAR 2003	Female Kumite -50 Kg	25	
F	YAMADA NODOKA	29 SEP 2002	Female Kata	16	
F	Yatoji akira	22 FEB 1999	Female Kumite -55 Kg	19	
F	YATOJI AYUMI	27 MAI 1997	Female Kumite -68 Kg	20	



# Karate1 Premier League - Cairo 2024



## ENTRIES BY NOC

As of 21 APR 2024

NOC Code	Gender	Name	Date Of Birth	Event	Seed
JOR	M	ABU ALHAIJA Kareem	10 MAI 2007	Male Kata	29
	M	ALJAFARI MOHAMMAD	02 FEB 2004	Male Kumite -84 Kg	1
	M	ALMASATFA ABDEL RAHMAN	26 MAI 1996	Male Kumite -67 Kg	1
	M	GHAITH AFEEF	22 NOC 2002	Male Kumite -67 Kg	6
	M	HAMMAD ABDALLAH	15 NOC 2001	Male Kumite -60 Kg	9
	M	MASARWEH HASAN	07 SEP 2002	Male Kumite -75 Kg	10
	M	SHAQRAH OMAR	13 MAI 2002	Male Kumite -60 Kg	19
	F	ALDROUS JOUD	10 JUL 2003	Female Kumite -68 Kg	26
	KAZ	M	ALPYSBAY KAISAR	11 DEC 1995	Male Kumite -60 Kg
M		AMIRALI DIDAR	22 FEB 1996	Male Kumite -67 Kg	2
M		ANARBEKOV DIAS	06 JUN 2003	Male Kumite 84+ Kg	17
M		AZHIKANOV NURKANAT	23 FEB 2001	Male Kumite -75 Kg	9
M		TIMRALIYEV DARKHAN	06 SEP 2000	Male Kumite -60 Kg	24
M		YULDASHEV DANİYAR	03 SEP 1996	Male Kumite -84 Kg	12
F		BERULTSEVA SOFYA	06 NOC 2000	Female Kumite 68+ Kg	1
F		KANAY ASSEL	25 MAI 2001	Female Kumite -61 Kg	4
F		Samasheva Bella	22 SEP 2004	Female Kumite -55 Kg	25
F		USSENOVA GULMIRA	11 SEP 1999	Female Kumite -55 Kg	2
F		ZHANGBYRBAY MOLDIR	18 MAI 1997	Female Kumite -50 Kg	2
F	Zhaxybayeva Venera	15 DEC 2004	Female Kumite -68 Kg	29	
KUW	M	ALMOSAWI SAYED MOHAMMED	12 MAI 1995	Male Kata	21
	M	ALMOSAWI SAYED SALMAN	12 MAI 1995	Male Kata	24
	M	ALOTAIBI MOHAMMAD	04 SEP 2002	Male Kumite -67 Kg	24
	M	HUSSAIN MOHAMMAD	02 SEP 1996	Male Kata	16
	M	SHAABAN ABDULLAH	12 JUN 1994	Male Kumite -60 Kg	4
LAT	M	Stepanovs Arturs	09 DEC 2003	Male Kumite -67 Kg	25
	F	MUIZNIECE MARIJA LUIZE	18 OCT 2001	Female Kumite -55 Kg	12
LBA	M	ABUDABOUS MOHAMED	07 DEC 2002	Male Kumite -75 Kg	16
LUX	F	WARLING JENNIFER	25 MAR 1994	Female Kumite -55 Kg	15
MAS	F	CHANDRAN SHAHMALARANI	12 DEC 1998	Female Kumite -50 Kg	15
MNE	M	MALOVIC NIKOLA	04 MAR 1997	Male Kumite -84 Kg	14
MAR	M	OUBAYA SAID	28 MAI 2003	Male Kumite -67 Kg	3
	M	SRITI MEHDI	28 SEP 2003	Male Kumite -84 Kg	18
	F	CHAJAI FATIMA-ZAHRA	26 JUN 2001	Female Kumite -61 Kg	8
	F	EDDARHRI MAROUA	10 JUL 2005	Female Kumite 68+ Kg	12
	F	ELHAYTI CHAIMAE	08 MAI 2001	Female Kumite -50 Kg	9
	F	EN-NESRYR AYA	29 APR 2000	Female Kata	8
NED	M	Najdi Issam	30 SEP 2001	Male Kumite 84+ Kg	19
	M	Timmermans Brian	15 SEP 1997	Male Kumite -84 Kg	7
	F	Creemers Ingrid	28 OCT 1996	Female Kumite 68+ Kg	17
	F	SNEL LYNN	14 MAI 1998	Female Kumite -68 Kg	28
	F	YALCIN Samina	21 JUN 2005	Female Kumite -50 Kg	27
MKD	M	Spasenovski Petar	02 APR 1998	Male Kumite -84 Kg	25
	M	ZABORSKI PETAR	20 SEP 1997	Male Kumite -75 Kg	19



## Karate1 Premier League - Cairo 2024



### ENTRIES BY NOC

As of 21 APR 2024

NOC Code	Gender	Name	Date Of Birth	Event	Seed
MKD	F	KOSTOVSKA VERONIKA	07 SEP 1999	Female Kumite -61 Kg	20
PER	F	Grande Alexandra	05 FEB 1990	Female Kumite -61 Kg	19
POL	M	DZIUDA DOMINIK	22 JUN 2005	Male Kumite -67 Kg	22
	M	FLORCZAK MICHAL	24 FEB 2004	Male Kumite -84 Kg	20
	F	DANISZEWSKA JULIA	22 SEP 2004	Female Kumite 68+ Kg	11
	F	DRONCHANKA KSENIYA	10 FEB 2005	Female Kumite -55 Kg	21
POR	M	GONCALVES GUILHERME	06 MAI 2005	Male Kumite -67 Kg	7
	F	CRUZ ANA	29 SEP 1994	Female Kata	9
	F	Rodrigues Catarina	29 NOC 2000	Female Kumite -50 Kg	23
PUR	F	FONSECA ROMERO JANESSA MICHELLE	30 MAI 2001	Female Kumite -68 Kg	21
ROU	M	COMANESCU PETRU	24 MAR 2004	Male Kata	27
	M	GOGOLOSI BOGDAN MARIAN FLORIN	08 SEP 1995	Male Kumite -60 Kg	16
KSA	M	ALQAHTANI SULTAN	07 JUN 2005	Male Kumite -60 Kg	18
	M	SUFYANI SANAD	08 JAN 2003	Male Kumite 84+ Kg	6
SCO	F	JUNNER NIAMH	03 JAN 2002	Female Kumite 68+ Kg	19
SVK	M	HRCKA ROMAN	02 DEC 2003	Male Kata	22
	M	IMRICH DOMINIK	17 OCT 1998	Male Kumite -60 Kg	13
	M	Smoliga Julian Enrik	20 APR 1999	Male Kumite -84 Kg	27
	F	KRIVDOVA SARA	14 DEC 2002	Female Kumite -68 Kg	9
	F	KVASNICOVA NINA	04 JUL 2005	Female Kumite -55 Kg	14
	F	SUCHANKOVA INGRIDA	08 FEB 1993	Female Kumite -61 Kg	9
	F	VANUSANIKOVA JANA	25 FEB 2000	Female Kata	31
	F	VARGOVA NATALIA	11 APR 2003	Female Kumite -50 Kg	4
ESP	M	Perez Luque Victor	06 FEB 1988	Male Kumite -84 Kg	31
	F	FERNANDEZ OSORIO CARLOTA	20 AUG 1995	Female Kumite -61 Kg	29
	F	GOMEZ MORALES NADIA	10 APR 1997	Female Kumite -50 Kg	7
	F	NIETO MEJIAS MARIA ISABEL	25 AUG 1999	Female Kumite -68 Kg	8
	F	PINILLA SANCHEZ ALBA	16 FEB 2001	Female Kumite -50 Kg	26
	F	RODRIGUEZ LOREDO EVA	30 SEP 2005	Female Kumite -50 Kg	19
	F	TORRES GARCIA MARIA	22 JUL 1997	Female Kumite 68+ Kg	2
	F	VIZUETE OLIVENZA MIREIA	25 AUG 2005	Female Kumite -50 Kg	17
	F	ZUNIGA GARCIA INDIRA	04 SEP 1999	Female Kumite -61 Kg	17
SWE	M	HAAG RICKY	06 MAI 2003	Male Kumite -75 Kg	21
	M	NOORI NEMATOLLAH	21 OCT 2002	Male Kumite -60 Kg	31
	F	NILSSON ANNA-JOHANNA	23 AUG 1998	Female Kumite -61 Kg	14
SUI	M	PISINO NOAH TONY	23 OCT 1997	Male Kumite -67 Kg	19
	M	UJIHARA YUKI	13 JAN 2001	Male Kata	15
	F	Bonjour Pauline	01 MAI 1999	Female Kumite 68+ Kg	23
	F	KAUFMANN FABIENNE	20 JAN 1997	Female Kumite 68+ Kg	8
	F	QUIRICI ELENA	16 FEB 1994	Female Kumite -68 Kg	1
	F	Radjenovic Nina	24 AUG 1998	Female Kumite -61 Kg	25
	F	SCHAERER MAYA	22 MAR 1998	Female Kumite -55 Kg	23



# Karate1 Premier League - Cairo 2024



## ENTRIES BY NOC

As of 21 APR 2024

NOC Code	Gender	Name	Date Of Birth	Event	Seed
TUN	F	EZZAR wissal	30 OCT 2002	Female Kumite -68 Kg	12
	F	JEMI CHEHINEZ	29 APR 1997	Female Kumite 68+ Kg	13
	F	mahjoub wafa	19 MAI 2001	Female Kumite -61 Kg	3
TUR	M	AKTAS UGUR	10 OCT 1995	Male Kumite -84 Kg	28
	M	ARSLAN HASAN	26 JUN 2002	Male Kumite -84 Kg	8
	M	BULUT ENES	07 FEB 2001	Male Kumite -75 Kg	6
	M	GUNDOG UMUT EREN	29 APR 2004	Male Kumite 84+ Kg	23
	M	HALICI MERT	20 APR 2004	Male Kumite -60 Kg	7
	M	KAYALI FURKAN	02 JAN 2000	Male Kumite 84+ Kg	13
	M	KURT ENES FATIH	26 FEB 2005	Male Kumite -67 Kg	9
	M	OZDEMIR ENES	09 MAR 2002	Male Kata	18
	M	OZER OMER ABDURRAHIM	08 MAR 2000	Male Kumite -67 Kg	13
	M	SAMDAN ERAY	25 JUL 1997	Male Kumite -60 Kg	5
	M	SEN FATIH	01 MAR 1998	Male Kumite 84+ Kg	8
	M	SOFUOGLU ALI	03 JUN 1995	Male Kata	3
	M	UYGUR BURAK	14 APR 1995	Male Kumite -67 Kg	21
	M	YILMAZ EKREM ALTUNER	27 DEC 2001	Male Kumite -67 Kg	27
	M	YURUR OMER FARUK	16 JAN 2004	Male Kumite -75 Kg	8
	F	AKSOY SUDENUR	05 JAN 2004	Female Kumite -68 Kg	10
	F	BOZAN DILARA	28 MAR 1997	Female Kata	7
	F	ELTEMUR EDA	11 APR 1999	Female Kumite -68 Kg	13
	F	GABALLA ZEYNA	27 JAN 2004	Female Kumite 68+ Kg	20
	F	GOZUTOK GULBAHAR	02 JAN 2002	Female Kumite -61 Kg	16
F	HOCAOGLU AKYOL MELTEM	15 JAN 1992	Female Kumite 68+ Kg	24	
F	im zumra rezzan	02 JAN 2003	Female Kumite -55 Kg	24	
F	UYGUR FATMA	24 JAN 2003	Female Kumite 68+ Kg	30	
F	YAKAN TUBA	08 JAN 1991	Female Kumite -55 Kg	1	
F	YENEN FATMA NAZ	29 AUG 2001	Female Kumite -61 Kg	6	
UKR	M	CHERNIAIEV OLEKSANDR	10 NOC 2002	Male Kumite -75 Kg	28
	M	CHOBOTAR VALERII	27 JUL 1993	Male Kumite -84 Kg	4
	M	FEDOROV YAROSLAV	05 JUN 2004	Male Kata	23
	M	FILIPOV NIKITA	12 MAR 2002	Male Kumite -60 Kg	26
	M	Karas Oleksandr	23 MAR 1999	Male Kumite -75 Kg	30
	M	Naida Valentyn	14 FEB 2000	Male Kumite -67 Kg	28
	M	PAK HNAT	12 JUL 1995	Male Kumite -67 Kg	18
	M	Pitsul Heorhii	03 MAI 2005	Male Kumite -75 Kg	5
	M	SONNYKH VALERII	10 JUN 1997	Male Kumite -84 Kg	17
	M	TALIBOV RYZVAN	20 JAN 1998	Male Kumite 84+ Kg	2
	M	TOROSHANKO ANDRII	31 MAI 1998	Male Kumite -84 Kg	22
	M	TSYMBAL KOSTIANTYN	26 JUL 1993	Male Kumite -84 Kg	32
	M	YANOVSKYI DAVYD	02 JUL 2004	Male Kumite -67 Kg	17
	M	ZAPLITNYI ANDRII	13 JUL 2001	Male Kumite -75 Kg	2
	F	PALASHEVSKA YULIIA	07 APR 2001	Female Kumite -50 Kg	8
	F	PROTSENKO ANNA	19 JAN 1999	Female Kumite -55 Kg	26
F	RUSU YULIA	04 FEB 2005	Female Kumite 68+ Kg	15	
F	SEROGINA ANITA	16 JAN 1990	Female Kumite -61 Kg	1	
F	SHOLOHOVA OLEKSANDRA	12 JAN 2001	Female Kumite -61 Kg	18	



## Karate1 Premier League - Cairo 2024



### ENTRIES BY NOC

As of 21 APR 2024

NOC Code	Gender	Name	Date Of Birth	Event	Seed
UKR	F	SIELIEMENIEVA ELINA	16 MAI 2003	Female Kumite -68 Kg	14
	F	Yervacheva Darya	26 DEC 2004	Female Kumite -61 Kg	27
UAE	F	alajmi Hawraa	23 JAN 1996	Female Kumite -50 Kg	28
	F	alameri Sarah	29 SEP 2001	Female Kumite -61 Kg	22
USA	M	AKDE EVANGELOS	09 SEP 2005	Male Kumite -67 Kg	30
	M	CHINEN REY	13 NOC 1999	Male Kata	9
	M	Sagilyan Eduard	25 APR 2004	Male Kumite 84+ Kg	27
	M	Torres Gutierrez Ariel	06 NOC 1997	Male Kata	2
	M	Tozaki Gakuji	15 AUG 1991	Male Kata	10
	F	ALLEN TRINITY	22 FEB 2001	Female Kumite -55 Kg	20
	F	Kokumai Sakura	02 OCT 1992	Female Kata	3
VEN	F	ARMADA RUIZ ANDREA	12 JAN 2000	Female Kata	29



Karate1 Premier League - Cairo 2024  
**ENTRIES BY WEIGHT CATEGORY**



**Female Kata**

As of 21 APR 2024

NOC Code	Gender	Name	Seeding
BEL	F	MANCA CHIARA	19
CZE	F	MISKOVA VERONIKA	17
EGY	F	Allam Asmaa	32
EGY	F	EIEzaby Mariam	23
EGY	F	Hesham Aya	21
EGY	F	Khamis Jana1	27
FRA	F	FERACCI Alexandra	28
FRA	F	TAILY Helvetia	10
GER	F	JAY SHIRLEY	14
GER	F	JUETTNER JASMIN	18
GRE	F	TSIAKMAKI ATHINA	20
GRE	F	XENOU GEORGIA ARCHONTIA	13
HKG	F	LAU MO SHEUNG GRACE	1
HKG	F	LO SUM MAN	26
HKG	F	TUNG YEE YIN	24
HKG	F	WONG SZE MAN	22
ITA	F	amato carolina	30
ITA	F	Casale Carola	25
ITA	F	D ONOFRIO TERRYANA	6
JPN	F	Azuma Saeko	11
JPN	F	hisami Nakaji	12
JPN	F	MISHIMA KIRI	4
JPN	F	OHUCHI MIRISA	2
JPN	F	Ono Maho	5
JPN	F	Shimizu Natsuki	15
JPN	F	YAMADA NODOKA	16
MAR	F	EN-NESYRY AYA	8
POR	F	CRUZ ANA	9
SVK	F	VANUSANIKOVA JANA	31
TUR	F	BOZAN DILARA	7
USA	F	Kokumai Sakura	3
VEN	F	ARMADA RUIZ ANDREA	29

**Female Kumite -50 Kg**

As of 21 APR 2024

NOC Code	Gender	Name	Seeding
ALG	F	OUIKENE CYLIA	20
ALG	F	Sekkour Rayane	29
AZE	F	TEYMUROVA FIDAN	11
CHI	F	VEGA ROJAS FERNANDA	30
COL	F	CARDENAS BALCAZAR SOFIA	18
CRO	F	PEHAR JELENA	16
CRO	F	SGARDELLI EMA	5
CYP	F	KONTOU IRENE	14



Karate1 Premier League - Cairo 2024  
**ENTRIES BY WEIGHT CATEGORY**



**Female Kumite -50 Kg**

As of 21 APR 2024

NOC Code	Gender	Name	Seeding
EGY	F	ALY GANNA	12
EGY	F	SALAMA REEM AHMED	1
EGY	F	Yasser Nagham	32
ESA	F	IZAGUIRRE GABRIELLA	13
ESP	F	GOMEZ MORALES NADIA	7
ESP	F	PINILLA SANCHEZ ALBA	26
ESP	F	RODRIGUEZ LOREDO EVA	19
ESP	F	VIZUETE OLIVENZA MIREIA	17
GER	F	Bugur Seden	21
GER	F	HUBRICH SHARA	6
GRE	F	TZILIA STYLIANI-ELENI	24
GUA	F	MORALES CHAVEZ BARBARA MICHELLE	31
ITA	F	AGUS ASIA	10
ITA	F	COLLETTI EMMA	22
ITA	F	PERFETTO ERMINIA	3
JPN	F	TSUTSUMI SARA	25
KAZ	F	ZHANGBYRBAY MOLDIR	2
MAR	F	ELHAYTI CHAIMAE	9
MAS	F	CHANDRAN SHAHMALARANI	15
NED	F	YALCIN Samina	27
POR	F	Rodrigues Catarina	23
SVK	F	VARGOVA NATALIA	4
UAE	F	alajmi Hawraa	28
UKR	F	PALASHEVSKA YULIIA	8

**Female Kumite -55 Kg**

As of 21 APR 2024

NOC Code	Gender	Name	Seeding
ALG	F	ABOURICHE LOUIZA	7
AZE	F	SADIGOVA MADINA	13
BRA	F	KUMIZAKI VALERIA	17
CAN	F	FURUMOTO-DESHAIES HANA	5
CHI	F	TORO MENESES VALENTINA	8
EGY	F	Attia Mirna	28
EGY	F	Hassan Salma	29
FRA	F	CHARIF ASSMA	22
GER	F	BITSCH MIA	4
GER	F	BUGUR GIZEM	10
GRE	F	Stoli Maria	9
INA	F	AGUNG SANISTYARANI COK ISTRI	16
ITA	F	BRUNORI VERONICA	11
ITA	F	Lallo viola	27
ITA	F	Mancinelli Syria	18
JPN	F	SHIMA AIRI	6



Karate1 Premier League - Cairo 2024  
**ENTRIES BY WEIGHT CATEGORY**



**Female Kumite -55 Kg**

As of 21 APR 2024

NOC Code	Gender	Name	Seeding
JPN	F	Yatoji akira	19
KAZ	F	Samasheva Bella	25
KAZ	F	USSENOVA GULMIRA	2
LAT	F	MUIZNIECE MARIJA LUIZE	12
LUX	F	WARLING JENNIFER	15
POL	F	DRONCHANKA KSENIYA	21
SUI	F	SCHAERER MAYA	23
SVK	F	KVASNICOVA NINA	14
TPE	F	KU TSUI-PING	3
TUR	F	im zumra rezzan	24
TUR	F	YAKAN TUBA	1
UKR	F	PROTSENKO ANNA	26
USA	F	ALLEN TRINITY	20

**Female Kumite -61 Kg**

As of 21 APR 2024

NOC Code	Gender	Name	Seeding
AUT	F	TOPALOVIC LEJLA	21
BEL	F	AJARAY MARYAM	7
CRO	F	CACKO MIA	26
EGY	F	ALY NOURSIN	15
ESP	F	FERNANDEZ OSORIO CARLOTA	29
ESP	F	ZUNIGA GARCIA INDIRA	17
FRA	F	AVAZERI LEA	13
FRA	F	Sivert Laura	12
GER	F	KHAMIS REEM	2
GRE	F	CHRYSOPOULOU KONSTANTINA	11
ITA	F	ANGELUCCI GIULIA	24
ITA	F	Mangiacapra Alessandra	28
ITA	F	MARTURANO IRENE	23
JPN	F	Kujuro Yuki	10
JPN	F	Shimada Sarara	5
KAZ	F	KANAY ASSEL	4
MAR	F	CHAJAI FATIMA-ZAHRA	8
MKD	F	KOSTOVSKA VERONIKA	20
PER	F	Grande Alexandra	19
SUI	F	Radjenovic Nina	25
SVK	F	SUCHANKOVA INGRIDA	9
SWE	F	NILSSON ANNA-JOHANNA	14
TUN	F	mahjoub wafa	3
TUR	F	GOZUTOK GULBAHAR	16
TUR	F	YENEN FATMA NAZ	6
UAE	F	alameri Sarah	22
UKR	F	SEROGINA ANITA	1





Karate1 Premier League - Cairo 2024  
**ENTRIES BY WEIGHT CATEGORY**



**Female Kumite -61 Kg**

As of 21 APR 2024

NOC Code	Gender	Name	Seeding
UKR	F	SHOLOHOVA OLEKSANDRA	18
UKR	F	Yervacheva Darya	27

**Female Kumite -68 Kg**

As of 21 APR 2024

NOC Code	Gender	Name	Seeding
ARM	F	MAKYAN ANITA	25
AUT	F	VUKOVIC MARINA	27
CHI	F	VELOZO ANASTASIIA	30
CRO	F	BECIROVIC SADEA	11
CRO	F	VUKOJA LEA	15
EGY	F	ABDELAZIZ FERYAL	18
EGY	F	ELMEDANY OLA	16
EGY	F	HENDY HADIR	31
EGY	F	ZEINELABDIN MAYAR	24
ESP	F	NIETO MEJIAS MARIA ISABEL	8
FRA	F	AGIER ALIZEE	4
FRA	F	SOMBE Thalya	2
GER	F	SCHROETER MADELEINE	7
GRE	F	PEPPA KONSTANTINA-EVANGELIA	23
HKG	F	WONG CHEUK LEE	22
INA	F	ZEFANYA CEYCO GEORGIA	3
ITA	F	Bodei Pamela	17
ITA	F	DESIDERIO ANNA PIA	19
ITA	F	SEMERARO SILVIA	5
JOR	F	ALDROUS JOUD	26
JPN	F	KAMA TSUBASA	6
JPN	F	YATOJI AYUMI	20
KAZ	F	Zhaxybayeva Venera	29
NED	F	SNEL LYNN	28
PUR	F	FONSECA ROMERO JANESEA MICHELLE	21
SUI	F	QUIRICI ELENA	1
SVK	F	KRIVDOVA SARA	9
TUN	F	EZZAR wissal	12
TUR	F	AKSOY SUDENUR	10
TUR	F	ELTEMUR EDA	13
UKR	F	SIELIEMIENIEVA ELINA	14

**Female Kumite 68+ Kg**

As of 21 APR 2024

NOC Code	Gender	Name	Seeding
ALG	F	OUDIRA CHAIMA	21



Karate1 Premier League - Cairo 2024  
**ENTRIES BY WEIGHT CATEGORY**



**Female Kumite 68+ Kg**

As of 21 APR 2024

NOC Code	Gender	Name	Seeding
AUT	F	ZILLER LORA	32
BEL	F	MULOLO OPHELIE	18
BIH	F	KRESIC STEFANI	6
CHI	F	GONZALEZ LAVIN JAVIERA	28
CRO	F	LESJAK LUCIJA	7
CYP	F	GIAMOUKI THEODOSIA	14
EGY	F	HELMY HABIBA	22
EGY	F	OKILA MENNA SHAABAN	4
ENG	F	Walters Rochelle	16
ESP	F	TORRES GARCIA MARIA	2
FIN	F	Keinanen Titta	29
FRA	F	GARCIA NANCY	27
FRA	F	PEA Clemence	26
GER	F	KNEER JOHANNA	10
GER	F	LUECKE AMELIE	9
GER	F	Stamer Selina	25
ITA	F	FERRACUTI CLIO	3
ITA	F	STASI LINDA	31
JPN	F	SAWAE YUZUKI	5
KAZ	F	BERULTSEVA SOFYA	1
MAR	F	EDDARHRI MAROUA	12
NED	F	Creemers Ingrid	17
POL	F	DANISZEWSKA JULIA	11
SCO	F	JUNNER NIAMH	19
SUI	F	Bonjour Pauline	23
SUI	F	KAUFMANN FABIENNE	8
TUN	F	JEMI CHEHINEZ	13
TUR	F	GABALLA ZEYNA	20
TUR	F	HOCAOGLU AKYOL MELTEM	24
TUR	F	UYGUR FATMA	30
UKR	F	RUSU YULIA	15

**Male Kata**

As of 21 APR 2024

NOC Code	Gender	Name	Seeding
FRA	M	NGOAN Franck	20
HKG	M	HUNG HO WAI HOWARD	19
HUN	M	Bardos Adam	25
HUN	M	NAGY BOTOND	12
ITA	M	Gallo Gianluca	28
ITA	M	GHINAMI ALESSIO	11
ITA	M	Grazia Manuel	26
ITA	M	Panagia Giuseppe	31
ITA	M	Polsinelli Guido	30



Karate1 Premier League - Cairo 2024  
**ENTRIES BY WEIGHT CATEGORY**



**Male Kata**

As of 21 APR 2024

NOC Code	Gender	Name	Seeding
JOR	M	ABU ALHAIJA Kareem	29
JPN	M	ABE SAKICHI	8
JPN	M	FUNADA AOI	7
JPN	M	Ikeda Ryusei	6
JPN	M	Kikuchi Ryonosuke	5
JPN	M	MACHIDA YASUHIRO	13
JPN	M	Moto Kazumasa	4
JPN	M	Moto Ryuji	14
JPN	M	Nishiyama Kakeru	1
JPN	M	Sato Yuki	17
KUW	M	ALMOSAWI SAYED MOHAMMED	21
KUW	M	ALMOSAWI SAYED SALMAN	24
KUW	M	HUSSAIN MOHAMMAD	16
ROU	M	COMANESCU PETRU	27
SUI	M	UJIHARA YUKI	15
SVK	M	HRCKA ROMAN	22
TUR	M	OZDEMIR ENES	18
TUR	M	SOFUOGLU ALI	3
UKR	M	FEDOROV YAROSLAV	23
USA	M	CHINEN REY	9
USA	M	Torres Gutierrez Ariel	2
USA	M	Tozaki Gakuji	10

**Male Kumite -60 Kg**

As of 21 APR 2024

NOC Code	Gender	Name	Seeding
ALB	M	Arifi Orges	22
AZE	M	GULIYEV AMINAGHA	17
AZE	M	SAVADOV FARID	10
BEL	M	ABDELMALKI ANASS	15
CAN	M	MIRI YASSIN	32
CHI	M	VILLALON RUIZ ENRIQUE	25
COL	M	FORERO JUAN DAVID	21
EGY	M	Aboukora Amr Alaa	11
EGY	M	Aly Zyad	30
FRA	M	MEZIANE Rayyan	8
FRA	M	TAS SAMI	29
GEO	M	TKEBUCHAVA DAVID	20
GER	M	HAAS FLORIAN	12
GRE	M	XENOS CHRISTOS-STEFANOS	1
HKG	M	CHAU KA HIM	27
ITA	M	CRESCENZO ANGELO	2
ITA	M	Gentile Samuele	28
ITA	M	GRECO DANILO	23



Karate1 Premier League - Cairo 2024  
**ENTRIES BY WEIGHT CATEGORY**



**Male Kumite -60 Kg**

As of 21 APR 2024

NOC Code	Gender	Name	Seeding
ITA	M	Luciano Carmine	14
JOR	M	HAMMAD ABDALLAH	9
JOR	M	SHAQRAH OMAR	19
JPN	M	HASHIMOTO HIROMU	3
KAZ	M	ALPYSBAY KAISAR	6
KAZ	M	TIMRALIYEV DARKHAN	24
KSA	M	ALQAHTANI SULTAN	18
KUW	M	SHAABAN ABDULLAH	4
ROU	M	GOGOLOSI BOGDAN MARIAN FLORIN	16
SVK	M	IMRICH DOMINIK	13
SWE	M	NOORI NEMATOLLAH	31
TUR	M	HALICI MERT	7
TUR	M	SAMDAN ERAY	5
UKR	M	FILIPOV NIKITA	26

**Male Kumite -67 Kg**

As of 21 APR 2024

NOC Code	Gender	Name	Seeding
AZE	M	AGHALARZADE TURAL	5
AZE	M	RZAZADE NURAN	14
BEL	M	ABDELMALKI AMIN	23
BRA	M	FIGUEIRA VINICIUS	16
CHI	M	FREIRE FUENTES TOMAS	26
EGY	M	Elsawy Ali	15
ENG	M	Wilson Joby	29
GER	M	OEZDEMIR MUHAMMED	10
GRE	M	BALLOTIS GEORGIOS	20
ITA	M	DE VIVO GIANLUCA	4
ITA	M	MARESCA LUCA	12
JOR	M	ALMASATFA ABDEL RAHMAN	1
JOR	M	GHAITH AFEEF	6
JPN	M	Nakano Soichiro	11
KAZ	M	AMIRALI DIDAR	2
KUW	M	ALOTAIBI MOHAMMAD	24
LAT	M	Stepanovs Arturs	25
MAR	M	OUBAYA SAID	3
POL	M	DZIUDA DOMINIK	22
POR	M	GONCALVES GUILHERME	7
SUI	M	PISINO NOAH TONY	19
TPE	M	SHIH CHENG-CHUNG	8
TUR	M	KURT ENES FATIH	9
TUR	M	OZER OMER ABDURRAHIM	13
TUR	M	UYGUR BURAK	21
TUR	M	YILMAZ EKREM ALTUNER	27



Karate1 Premier League - Cairo 2024  
**ENTRIES BY WEIGHT CATEGORY**



**Male Kumite -67 Kg**

As of 21 APR 2024

NOC Code	Gender	Name	Seeding
UKR	M	Naida Valentyn	28
UKR	M	PAK HNAT	18
UKR	M	YANOVSKYI DAVYD	17
USA	M	AKDE EVANGELOS	30

**Male Kumite -75 Kg**

As of 21 APR 2024

NOC Code	Gender	Name	Seeding
ALG	M	ZAID OUSSAMA	17
AUT	M	POKORNY STEFAN	13
AZE	M	AGHAYEV FARID	20
BEL	M	MAHAUDEN QUENTIN	3
BIH	M	TURULJA HAMZA	14
CHI	M	RODRIGUEZ FUENTES MATIAS	18
EGY	M	Abdelaziz Abdalla	1
EGY	M	Abdelgawad ABDALLA HESHAM	15
EGY	M	FARAG YOUSSEF	22
FRA	M	BERTHON ENZO	4
FRA	M	CIZO KILIAN	26
FRA	M	LE THANH LIEM	25
GEO	M	PONIAVA VALIKO	27
ITA	M	DE VIVO DANIELE	12
ITA	M	Iannuzzi Mario	29
ITA	M	Pietromarchi Lorenzo	7
ITA	M	Rossi Joseph	24
JOR	M	MASARWEH HASAN	10
JPN	M	Sakiyama Yusei	11
JPN	M	Suzuki Shunji	23
KAZ	M	AZHIKANOV NURKANAT	9
LBA	M	ABUDABOUS MOHAMED	16
MKD	M	ZABORSKI PETAR	19
SWE	M	HAAG RICKY	21
TUR	M	BULUT ENES	6
TUR	M	YURUR OMER FARUK	8
UKR	M	CHERNIAIEV OLEKSANDR	28
UKR	M	Karas Oleksandr	30
UKR	M	Pitsul Heorhii	5
UKR	M	ZAPLITNYI ANDRII	2

**Male Kumite -84 Kg**

As of 21 APR 2024

NOC Code	Gender	Name	Seeding
----------	--------	------	---------



Karate1 Premier League - Cairo 2024  
**ENTRIES BY WEIGHT CATEGORY**



**Male Kumite -84 Kg**

As of 21 APR 2024

NOC Code	Gender	Name	Seeding
ALB	M	GASHI MELOS	15
ALG	M	MIDOUNE FALLEH	16
AZE	M	HASANOV TURGUT	24
CRO	M	GARIBOVIC ENES	11
CRO	M	KVESIC IVAN	10
EGY	M	Badawy Youssef	2
ESP	M	Perez Luque Victor	31
FIN	M	Kulovuori Bjorn	21
FIN	M	Mantere Niko	23
FRA	M	ABDESSELEM RAYBAK	19
FRA	M	MARQUES Adrien	30
GEO	M	KIPAROIDZE KHVICHA	26
GRE	M	MASTROGIANNIS KONSTANTINOS	6
ITA	M	FIORE MATTEO	9
ITA	M	MARTINA MICHELE	3
JOR	M	ALJAFARI MOHAMMAD	1
JPN	M	ETO JUNYA	13
JPN	M	Mori Yuta	29
JPN	M	Shimada Rikito	5
KAZ	M	YULDASHEV DANIYAR	12
MAR	M	SRITI MEHDI	18
MKD	M	Spasenovski Petar	25
MNE	M	MALOVIC NIKOLA	14
NED	M	Timmermans Brian	7
POL	M	FLORCZAK MICHAL	20
SVK	M	Smoliga Julian Enrik	27
TUR	M	AKTAS UGUR	28
TUR	M	ARSLAN HASAN	8
UKR	M	CHOBOTAR VALERII	4
UKR	M	SONNYKH VALERII	17
UKR	M	TOROSHANKO ANDRII	22
UKR	M	TSYMBAL KOSTIANTYN	32

**Male Kumite 84+ Kg**

As of 21 APR 2024

NOC Code	Gender	Name	Seeding
ALG	M	DAIKHI HOCINE	15
AZE	M	GURBANLI ASIMAN	11
AZE	M	OSMANLI OSMAN	24
BIH	M	BOSTANDZIC ANES	3
CHI	M	ROJAS RODRIGO	7
CRO	M	KVESIC ANDJELO	4
CUR	M	Timmermans Rob	5
CYP	M	STYLIANOU MATHAIOS	25



# Karate1 Premier League - Cairo 2024

## ENTRIES BY WEIGHT CATEGORY



### Male Kumite 84+ Kg

As of 21 APR 2024

NOC Code	Gender	Name	Seeding
EGY	M	Badawy Mahmoud	29
EGY	M	Elmasry Ahmed	18
EGY	M	KHALIL MAHMOUD GALAL	28
EGY	M	Mahmoud Taha tarek	1
EGY	M	MOHAMED HAZEM	22
GEO	M	GELASHVILI MERABI	12
GER	M	SEKOT NIKOLAI	14
GRE	M	NIKOPOULOS ATHANASIOS	16
ITA	M	AVANZINI MATTEO	9
ITA	M	CIANI MICHELE	31
ITA	M	Forino Alessandro	30
ITA	M	GHISLANDI MICHAEL	21
ITA	M	marino simone	26
ITA	M	Mazzoleni Fabio	20
JPN	M	Yoshimura Fumiya	10
KAZ	M	ANARBKOV DIAS	17
KSA	M	SUFYANI SANAD	6
NED	M	Najdi Issam	19
TUR	M	GUNDOG UMUT EREN	23
TUR	M	KAYALI FURKAN	13
TUR	M	SEN FATIH	8
UKR	M	TALIBOV RYZVAN	2
USA	M	Sagilyan Eduard	27



# Karate1 Premier League - Cairo 2024



## Statistics

Participating Countries: 58

	Competitors	Entries
Female	185	185
Male	186	186
<b>Total</b>	<b>371</b>	<b>371</b>

### Entries per Category

	Entries	Teams
Female Kata	32	-
Female Kumite -50 Kg	32	-
Female Kumite -55 Kg	29	-
Female Kumite -61 Kg	29	-
Female Kumite -68 Kg	31	-
Female Kumite 68+ Kg	32	-
Male Kata	31	-
Male Kumite -60 Kg	32	-
Male Kumite -67 Kg	30	-
Male Kumite -75 Kg	30	-
Male Kumite -84 Kg	32	-
Male Kumite 84+ Kg	31	-
<b>Totals:</b>	<b>371</b>	<b>0</b>



# FEMALE KATA



# Karate1 Premier League - Cairo 2024

## ENTRIES BY WEIGHT CATEGORY



### Female Kata

As of 21 APR 2024

NOC Code	Gender	Name	Seeding
BEL	F	MANCA CHIARA	19
CZE	F	MISKOVA VERONIKA	17
EGY	F	Allam Asmaa	32
EGY	F	EIEzaby Mariam	23
EGY	F	Hesham Aya	21
EGY	F	Khamis Jana1	27
FRA	F	FERACCI Alexandra	28
FRA	F	TAILY Helvetia	10
GER	F	JAY SHIRLEY	14
GER	F	JUETTNER JASMIN	18
GRE	F	TSIAKMAKI ATHINA	20
GRE	F	XENOU GEORGIA ARCHONTIA	13
HKG	F	LAU MO SHEUNG GRACE	1
HKG	F	LO SUM MAN	26
HKG	F	TUNG YEE YIN	24
HKG	F	WONG SZE MAN	22
ITA	F	amato carolina	30
ITA	F	Casale Carola	25
ITA	F	D ONOFRIO TERRYANA	6
JPN	F	Azuma Saeko	11
JPN	F	hisami Nakaji	12
JPN	F	MISHIMA KIRI	4
JPN	F	OHUCHI MIRISA	2
JPN	F	Ono Maho	5
JPN	F	Shimizu Natsuki	15
JPN	F	YAMADA NODOKA	16
MAR	F	EN-NESYRY AYA	8
POR	F	CRUZ ANA	9
SVK	F	VANUSANIKOVA JANA	31
TUR	F	BOZAN DILARA	7
USA	F	Kokumai Sakura	3
VEN	F	ARMADA RUIZ ANDREA	29

# Female Kata - Round Robin (each against each)

Karate1 Premier League - Cairo 2024, Cairo, EGY

Tatami

Pool

1/8

1	(*10) TAILY H. (FRA)	021 Gojushiho Sho #46 / 19.04	3920	(*16) YAMADA N. (JPN)
2	(*16) YAMADA N. (JPN)	047 Kururunfa	4060	
3	(*21) HESHAM A. (EGY)	020 Gojushiho Dai #47 / 19.04	3950	(*21) HESHAM A. (EGY)
4	(*25) CASALE C. (ITA)	047 Kururunfa	3960	
5	(*16) YAMADA N. (JPN)	045 Kousoukun Dai #50 / 19.04	3950	(*21) HESHAM A. (EGY)
6	(*21) HESHAM A. (EGY)	021 Gojushiho Sho	3990	
7	(*10) TAILY H. (FRA)	020 Gojushiho Dai #51 / 19.04	3900	(*25) CASALE C. (ITA)
8	(*25) CASALE C. (ITA)	092 Suparinpei	4000	
9	(*10) TAILY H. (FRA)	099 Unsu #54 / 19.04	3910	(*21) HESHAM A. (EGY)
10	(*21) HESHAM A. (EGY)	099 Unsu	3950	
11	(*16) YAMADA N. (JPN)	068 Papuren #55 / 19.04	3950	(*25) CASALE C. (ITA)
12	(*25) CASALE C. (ITA)	068 Papuren	4040	



1. HESHAM AYA (EGY)
2. CASALE CAROLA (ITA)
3. YAMADA NODOKA (JPN)
4. TAILY HELVETIA (FRA)

1. MISHIMA KIRI (JPN)
2. ONO MAHO (JPN)
3. LAU MO SHEUNG GRACE (HKG)
3. AZUMA SAEKO (JPN)
5. HESHAM AYA (EGY)
5. SHIMIZU NATSUKI (JPN)
7. OHUCHI MIRISA (JPN)
7. HISAMI NAKAJI (JPN)

\*Seeded



















Referees:			

# Female Kata - Round Robin (each against each)

Karate1 Premier League - Cairo 2024, Cairo, EGY

Tatami

Pool  
2/8

1	 (*20) TSIKMAKI A. (GRE)	 (*29) ARMADA RUIZ A. (VEN)
	068 Papuren #48 / 19.04	3760
2	 (*29) ARMADA RUIZ A. (VEN)	
	064 Ohan Dai	3880
3	 (*5) ONO M. (JPN)	 (*5) ONO M. (JPN)
	068 Papuren #49 / 19.04	4050
4	 (*3) KOKUMAI S. (USA)	
	068 Papuren	3970
5	 (*29) ARMADA RUIZ A. (VEN)	 (*5) ONO M. (JPN)
	068 Papuren #52 / 19.04	3940
6	 (*5) ONO M. (JPN)	
	061 Nipaipo	4110
7	 (*20) TSIKMAKI A. (GRE)	 (*3) KOKUMAI S. (USA)
	009 Chibana No Kushanku #53 / 19.04	3780
8	 (*3) KOKUMAI S. (USA)	
	047 Kururunfa	3900
9	 (*20) TSIKMAKI A. (GRE)	 (*5) ONO M. (JPN)
	002 Anan Dai #56 / 19.04	3820
10	 (*5) ONO M. (JPN)	
	009 Chibana No Kushanku	4100
11	 (*29) ARMADA RUIZ A. (VEN)	 (*3) KOKUMAI S. (USA)
	009 Chibana No Kushanku #57 / 19.04	3850
12	 (*3) KOKUMAI S. (USA)	
	008 Chatanyara Kushanku	4030

1. ONO MAHO (JPN)
2. KOKUMAI SAKURA (USA)
3. ARMADA RUIZ ANDREA (VEN)
4. TSIKMAKI ATHINA (GRE)



1. MISHIMA KIRI (JPN)
2. ONO MAHO (JPN)
3. LAU MO SHEUNG GRACE (HKG)
3. AZUMA SAEKO (JPN)
5. HESHAM AYA (EGY)
5. SHIMIZU NATSUKI (JPN)
7. OHUCHI MIRISA (JPN)
7. HISAMI NAKAJI (JPN)

\*Seeded

Referees:			

# Female Kata - Round Robin (each against each)

Karate1 Premier League - Cairo 2024, Cairo, EGY

Tatami

Pool  
3/8

1	(*19) MANCA C. (BEL)	064 Ohan Dai #112 / 19.04	3790	(*11) AZUMA S. (JPN)
2	(*11) AZUMA S. (JPN)	092 Suparinpei	4050	
3	(*7) BOZAN D. (TUR)	047 Kururunfa #113 / 19.04	4060	(*7) BOZAN D. (TUR)
4	(*24) TUNG Y. (HKG)	064 Ohan Dai	3870	
5	(*11) AZUMA S. (JPN)	009 Chibana No Kushanku #116 / 19.04	4050	(*11) AZUMA S. (JPN)
6	(*7) BOZAN D. (TUR)	008 Chatanyara Kushanku	4020	
7	(*19) MANCA C. (BEL)	068 Papuren #117 / 19.04	3870	(*19) MANCA C. (BEL)
8	(*24) TUNG Y. (HKG)	092 Suparinpei	3820	
9	(*19) MANCA C. (BEL)	008 Chatanyara Kushanku #120 / 19.04	3920	(*7) BOZAN D. (TUR)
10	(*7) BOZAN D. (TUR)	068 Papuren	4080	
11	(*11) AZUMA S. (JPN)	068 Papuren #121 / 19.04	4140	(*11) AZUMA S. (JPN)
12	(*24) TUNG Y. (HKG)	068 Papuren	3920	

1. AZUMA SAEKO (JPN)
2. BOZAN DILARA (TUR)
3. MANCA CHIARA (BEL)
4. TUNG YEE YIN (HKG)



1. MISHIMA KIRI (JPN)
2. ONO MAHO (JPN)
3. LAU MO SHEUNG GRACE (HKG)
3. AZUMA SAEKO (JPN)
5. HESHAM AYA (EGY)
5. SHIMIZU NATSUKI (JPN)
7. OHUCHI MIRISA (JPN)
7. HISAMI NAKAJI (JPN)

\*Seeded

Referees:			



















# Female Kata - Round Robin (each against each)

Karate1 Premier League - Cairo 2024, Cairo, EGY

Tatami

Pool

4/8

1	 (*13) XENOU G. (GRE)	068 Papuren #114 / 19.04	3910	 (*13) XENOU G. (GRE)
2	 (*26) LO S. (HKG)	009 Chibana No Kushanku	3800	
3	 (*28) FERACCI A. (FRA)	092 Suparinpei #115 / 19.04	3840	 (*2) OHUCHI M. (JPN)
4	 (*2) OHUCHI M. (JPN)	098 Unshu	3940	
5	 (*26) LO S. (HKG)	008 Chatanyara Kushanku #118 / 19.04	3870	 (*28) FERACCI A. (FRA)
6	 (*28) FERACCI A. (FRA)	068 Papuren	3970	
7	 (*13) XENOU G. (GRE)	009 Chibana No Kushanku #119 / 19.04	3980	 (*2) OHUCHI M. (JPN)
8	 (*2) OHUCHI M. (JPN)	092 Suparinpei	3980	
9	 (*13) XENOU G. (GRE)	008 Chatanyara Kushanku #122 / 19.04	3990	 (*13) XENOU G. (GRE)
10	 (*28) FERACCI A. (FRA)	009 Chibana No Kushanku	3870	
11	 (*26) LO S. (HKG)	092 Suparinpei #123 / 19.04	3870	 (*2) OHUCHI M. (JPN)
12	 (*2) OHUCHI M. (JPN)	009 Chibana No Kushanku	4080	



1. OHUCHI MIRISA (JPN)
2. XENOU GEORGIA ARCHONTIA (GRE)
3. FERACCI ALEXANDRA (FRA)
4. LO SUM MAN (HKG)

1. MISHIMA KIRI (JPN)
2. ONO MAHO (JPN)
3. LAU MO SHEUNG GRACE (HKG)
3. AZUMA SAEKO (JPN)
5. HESHAM AYA (EGY)
5. SHIMIZU NATSUKI (JPN)
7. OHUCHI MIRISA (JPN)
7. HISAMI NAKAJI (JPN)

\*Seeded

Referees:			

# Female Kata - Round Robin (each against each)

Karate1 Premier League - Cairo 2024, Cairo, EGY

Tatami

Pool  
5/8

1	(*17) MISKOVA V. (CZE)	(*18) JUETTNER J. (GER)
	009 Chibana No Kushanku3740 #184 / 19.04	
2	(*18) JUETTNER J. (GER)	
	092 Suparinpei 3770	
3	(*27) KHAMIS J. (EGY)	(*15) SHIMIZU N. (JPN)
	099 Unsu 3800 #185 / 19.04	
4	(*15) SHIMIZU N. (JPN)	
	047 Kururunfa 4030	
5	(*18) JUETTNER J. (GER)	(*27) KHAMIS J. (EGY)
	020 Gojushiho Dai 3850 #188 / 19.04	
6	(*27) KHAMIS J. (EGY)	
	021 Gojushiho Sho 4010	
7	(*17) MISKOVA V. (CZE)	(*15) SHIMIZU N. (JPN)
	052 Matsumura Bassai 3820 #189 / 19.04	
8	(*15) SHIMIZU N. (JPN)	
	008 Chatanyara Kushanku3970	
9	(*17) MISKOVA V. (CZE)	(*27) KHAMIS J. (EGY)
	068 Papuren 3880 #192 / 19.04	
10	(*27) KHAMIS J. (EGY)	
	020 Gojushiho Dai 3980	
11	(*18) JUETTNER J. (GER)	(*15) SHIMIZU N. (JPN)
	021 Gojushiho Sho 3920 #193 / 19.04	
12	(*15) SHIMIZU N. (JPN)	
	092 Suparinpei 4100	

1. SHIMIZU NATSUKI (JPN)
2. KHAMIS JANA1 (EGY)
3. JUETTNER JASMIN (GER)
4. MISKOVA VERONIKA (CZE)



1. MISHIMA KIRI (JPN)
2. ONO MAHO (JPN)
3. LAU MO SHEUNG GRACE (HKG)
3. AZUMA SAEKO (JPN)
5. HESHAM AYA (EGY)
5. SHIMIZU NATSUKI (JPN)
7. OHUCHI MIRISA (JPN)
7. HISAMI NAKAJI (JPN)

\*Seeded

Referees:			

# Female Kata - Round Robin (each against each)

Karate1 Premier League - Cairo 2024, Cairo, EGY

Tatami

Pool  
6/8

1	(*9) CRUZ A. (POR)	047 Kururunfa #186 / 19.04	3880	(*9) CRUZ A. (POR)
2	(*22) WONG S. (HKG)	068 Papuren	3870	
3	(*23) ELEZABY M. (EGY)	099 Unsu #187 / 19.04	3780	(*4) MISHIMA K. (JPN)
4	(*4) MISHIMA K. (JPN)	068 Papuren	4030	
5	(*22) WONG S. (HKG)	092 Suparinpei #190 / 19.04	3850	(*23) ELEZABY M. (EGY)
6	(*23) ELEZABY M. (EGY)	020 Gojushiho Dai	3890	
7	(*9) CRUZ A. (POR)	068 Papuren #191 / 19.04	3980	(*4) MISHIMA K. (JPN)
8	(*4) MISHIMA K. (JPN)	008 Chatanyara Kushanku	4140	
9	(*9) CRUZ A. (POR)	064 Ohan Dai #194 / 19.04	3880	(*23) ELEZABY M. (EGY)
10	(*23) ELEZABY M. (EGY)	021 Gojushiho Sho	3970	
11	(*22) WONG S. (HKG)	047 Kururunfa #195 / 19.04	3850	(*4) MISHIMA K. (JPN)
12	(*4) MISHIMA K. (JPN)	067 Paiku	4090	



1. MISHIMA KIRI (JPN)
2. ELEZABY MARIAM (EGY)
3. CRUZ ANA (POR)
4. WONG SZE MAN (HKG)

1. MISHIMA KIRI (JPN)
2. ONO MAHO (JPN)
3. LAU MO SHEUNG GRACE (HKG)
3. AZUMA SAEKO (JPN)
5. HESHAM AYA (EGY)
5. SHIMIZU NATSUKI (JPN)
7. OHUCHI MIRISA (JPN)
7. HISAMI NAKAJI (JPN)

\*Seeded

Referees:			



# Female Kata - Round Robin (each against each)

Karate1 Premier League - Cairo 2024, Cairo, EGY

Tatami

Pool

7/8

1	(*32) ALLAM A. (EGY)	020 Gojushiho Dai #250 / 19.04	3890	(*6) D ONOFRIO T. (ITA)
2	(*6) D ONOFRIO T. (ITA)	047 Kururunfa	4000	
3	(*12) HISAMI N. (JPN)	067 Paiku #251 / 19.04	4040	(*12) HISAMI N. (JPN)
4	(*14) JAY S. (GER)	092 Suparinpei	3780	
5	(*6) D ONOFRIO T. (ITA)	068 Papuren #254 / 19.04	4050	(*12) HISAMI N. (JPN)
6	(*12) HISAMI N. (JPN)	068 Papuren	4160	
7	(*32) ALLAM A. (EGY)	021 Gojushiho Sho #255 / 19.04	4000	(*32) ALLAM A. (EGY)
8	(*14) JAY S. (GER)	008 Chatanyara Kushanku	3770	
9	(*32) ALLAM A. (EGY)	099 Unsu #258 / 19.04	3900	(*12) HISAMI N. (JPN)
10	(*12) HISAMI N. (JPN)	046 Kousokun Sho	0	
11	(*6) D ONOFRIO T. (ITA)	065 Oyadomari No Passai #259 / 19.04	4000	(*6) D ONOFRIO T. (ITA)
12	(*14) JAY S. (GER)	002 Anan Dai	3850	



1. HISAMI NAKAJI (JPN)
2. D ONOFRIO TERRYANA (ITA)
3. ALLAM ASMAA (EGY)
4. JAY SHIRLEY (GER)

1. MISHIMA KIRI (JPN)
2. ONO MAHO (JPN)
3. LAU MO SHEUNG GRACE (HKG)
3. AZUMA SAEKO (JPN)
5. HESHAM AYA (EGY)
5. SHIMIZU NATSUKI (JPN)
7. OHUCHI MIRISA (JPN)
7. HISAMI NAKAJI (JPN)

\*Seeded

Referees:			

# Female Kata - Round Robin (each against each)

Karate1 Premier League - Cairo 2024, Cairo, EGY

Tatami

Pool  
8/8

1	(*30) AMATO C. (ITA)	001 Anan #252 / 19.04	3930	(*30) AMATO C. (ITA)
2	(*8) EN-NESYRY A. (MAR)	021 Gojushiho Sho	3820	
3	(*31) VANUSANIKOVA J. (SVK)	061 Nipaipo #253 / 19.04	3670	(*1) LAU M. (HKG)
4	(*1) LAU M. (HKG)	097 Tomari Bassai	4080	
5	(*8) EN-NESYRY A. (MAR)	015 Gankaku #256 / 19.04	3800	(*8) EN-NESYRY A. (MAR)
6	(*31) VANUSANIKOVA J. (SVK)	068 Papuren	3570	
7	(*30) AMATO C. (ITA)	092 Suparinpei #257 / 19.04	3880	(*1) LAU M. (HKG)
8	(*1) LAU M. (HKG)	009 Chibana No Kushanku	3950	
9	(*30) AMATO C. (ITA)	047 Kururunfa #260 / 19.04	3890	(*30) AMATO C. (ITA)
10	(*31) VANUSANIKOVA J. (SVK)	064 Ohan Dai	3630	
11	(*8) EN-NESYRY A. (MAR)	099 Unsu #261 / 19.04	3840	(*1) LAU M. (HKG)
12	(*1) LAU M. (HKG)	092 Suparinpei	4240	



1. LAU MO SHEUNG GRACE (HKG)
2. AMATO CAROLINA (ITA)
3. EN-NESYRY AYA (MAR)
4. VANUSANIKOVA JANA (SVK)

1. MISHIMA KIRI (JPN)
2. ONO MAHO (JPN)
3. LAU MO SHEUNG GRACE (HKG)
3. AZUMA SAEKO (JPN)
5. HESHAM AYA (EGY)
5. SHIMIZU NATSUKI (JPN)
7. OHUCHI MIRISA (JPN)
7. HISAMI NAKAJI (JPN)

\*Seeded

Referees:			

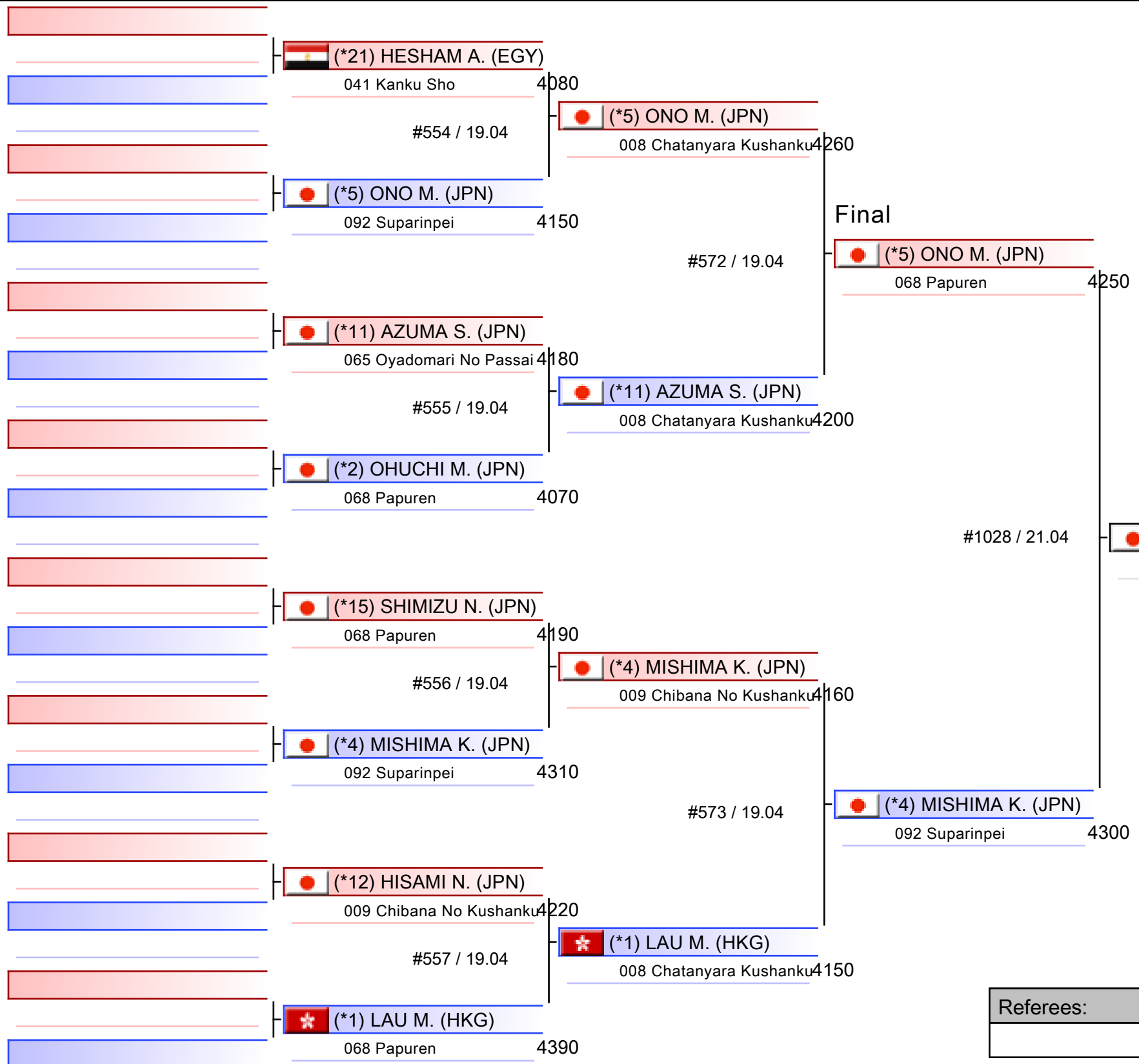

1. MISHIMA KIRI (JPN)
2. ONO MAHO (JPN)
3. LAU MO SHEUNG GRACE (HKG)
3. AZUMA SAEKO (JPN)
5. HESHAM AYA (EGY)
5. SHIMIZU NATSUKI (JPN)
7. OHUCHI MIRISA (JPN)
7. HISAMI NAKAJI (JPN)

\*Seeded

Referees:			

# Female Kata

Karate1 Premier League - Cairo 2024

Tatami

Pool

1,2,3,4,5,6,7,8

(c)sportdata GmbH & Co KG 2000-2024 (2024-04-21 18:26) v 10.2.0 build 1 (2024-04-20 17:58 CET) License: SDIL\_TV-GRAPHICS (expire 2024-12-31)

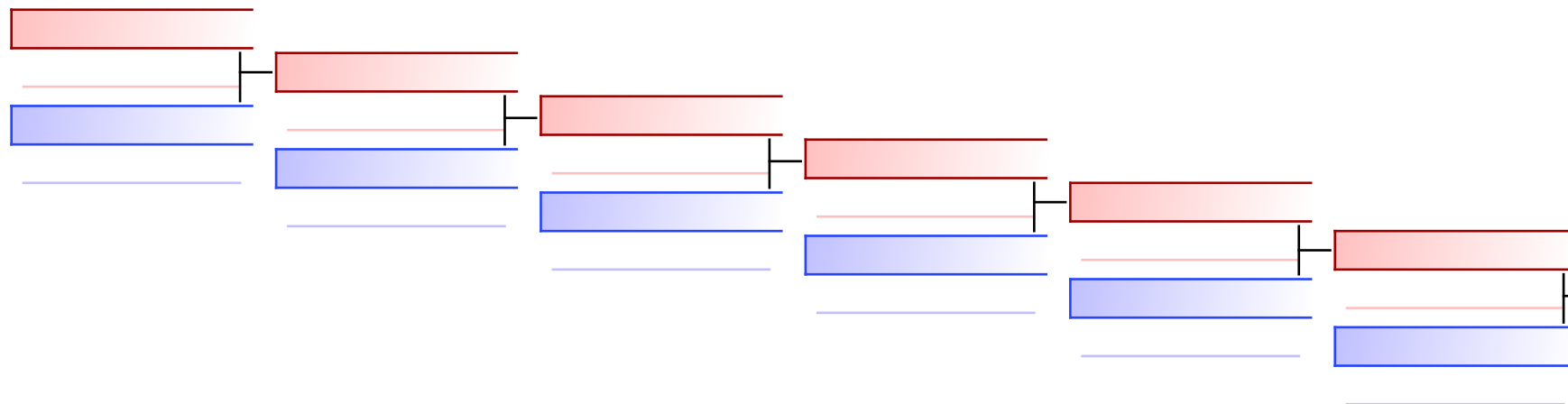

#1008

	Hesham Aya (EGY)	091 Sochin	4130
	Azuma Saeko (JPN)	068 Papuren	4270

## REPECHAGE: (1,2,3,4,5,6,7,8)

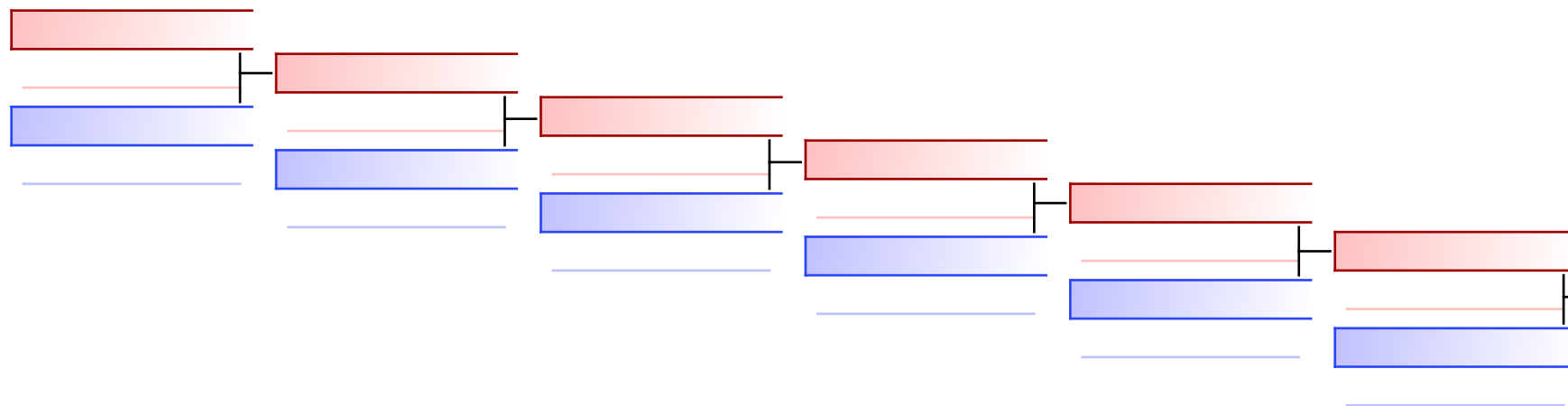

#1009 / 21.04

	Shimizu Natsuki (JPN)	048 Kusanku	4140
	LAU MO SHEUNG GRACE (HKG)	068 Papuren	4410

Referees:							
-----------	--	--	--	--	--	--	--



Karate1 Premier League - Cairo 2024 - 2024-04-19



## Official Results

Female Kata			
1	MISHIMA KIRI		JPN - JAPAN
2	ONO MAHO		JPN - JAPAN
3	LAU MO SHEUNG GRACE		HKG - HONG KONG, CHINA
3	AZUMA SAEKO		JPN - JAPAN
5	HESHAM AYA		EGY - EGYPT
5	SHIMIZU NATSUKI		JPN - JAPAN
7	OHUCHI MIRISA		JPN - JAPAN
7	HISAMI NAKAJI		JPN - JAPAN

# FEMALE KUMITE -50 KG



Karate1 Premier League - Cairo 2024  
**ENTRIES BY WEIGHT CATEGORY**



**Female Kumite -50 Kg**

As of 21 APR 2024

NOC Code	Gender	Name	Seeding
ALG	F	OUIKENE CYLIA	20
ALG	F	Sekkour Rayane	29
AZE	F	TEYMUROVA FIDAN	11
CHI	F	VEGA ROJAS FERNANDA	30
COL	F	CARDENAS BALCAZAR SOFIA	18
CRO	F	PEHAR JELENA	16
CRO	F	SGARDELLI EMA	5
CYP	F	KONTOU IRENE	14
EGY	F	ALY GANNA	12
EGY	F	SALAMA REEM AHMED	1
EGY	F	Yasser Nagham	32
ESA	F	IZAGUIRRE GABRIELLA	13
ESP	F	GOMEZ MORALES NADIA	7
ESP	F	PINILLA SANCHEZ ALBA	26
ESP	F	RODRIGUEZ LOREDO EVA	19
ESP	F	VIZUETE OLIVENZA MIREIA	17
GER	F	Bugur Seden	21
GER	F	HUBRICH SHARA	6
GRE	F	TZILIA STYLIANI-ELENI	24
GUA	F	MORALES CHAVEZ BARBARA MICHELLE	31
ITA	F	AGUS ASIA	10
ITA	F	COLLETTI EMMA	22
ITA	F	PERFETTO ERMINIA	3
JPN	F	TSUTSUMI SARA	25
KAZ	F	ZHANGBYRBAY MOLDIR	2
MAR	F	ELHAYTI CHAIMAE	9
MAS	F	CHANDRAN SHAHMALARANI	15
NED	F	YALCIN Samina	27
POR	F	Rodrigues Catarina	23
SVK	F	VARGOVA NATALIA	4
UAE	F	alajmi Hawraa	28
UKR	F	PALASHEVSKA YULIIA	8

# Female Kumite -50 Kg - Round Robin (each against each)

Karate1 Premier League - Cairo 2024, Cairo, EGY

Tatami

Pool

1/8

1	(*17) VIZUETE OLIVENZA M. (ESP)	5	(*17) VIZUETE OLIVENZA M. (ESP)
	#34 / 19.04		
2	(*30) VEGA ROJAS F. (CHI)	1	
	PTS		
3	(*5) SGARDELLI E. (CRO)	3	(*5) SGARDELLI E. (CRO)
	#35 / 19.04		
4	(*21) BUGUR S. (GER)	0	
5	(*30) VEGA ROJAS F. (CHI)	0	(*5) SGARDELLI E. (CRO)
	#38 / 19.04		
6	(*5) SGARDELLI E. (CRO)	4	
	PTS		
7	(*17) VIZUETE OLIVENZA M. (ESP)	0	(*21) BUGUR S. (GER)
	#39 / 19.04		
8	(*21) BUGUR S. (GER)	3	
9	(*17) VIZUETE OLIVENZA M. (ESP)	3	(*5) SGARDELLI E. (CRO)
	#42 / 19.04		
10	(*5) SGARDELLI E. (CRO)	3	
	PTS		
11	(*30) VEGA ROJAS F. (CHI)	1	(*21) BUGUR S. (GER)
	#43 / 19.04		
12	(*21) BUGUR S. (GER)	3	



1. SGARDELLI EMA (CRO)
2. BUGUR SEDEN (GER)
3. VIZUETE OLIVENZA MIREIA (ESP)
4. VEGA ROJAS FERNANDA (CHI)

1. ALY GANNA (EGY)
2. ZHANGBYRBAY MOLDIR (KAZ)
3. CARDENAS BALCAZAR SOFIA (COL)
3. OUIKENE CYLIA (ALG)
5. SGARDELLI EMA (CRO)
5. TSUTSUMI SARA (JPN)
7. RODRIGUES CATARINA (POR)
7. AGUS ASIA (ITA)

\*Seeded

Referees:			



# Female Kumite -50 Kg - Round Robin (each against each)

Karate1 Premier League - Cairo 2024, Cairo, EGY

Tatami

Pool  
2/8

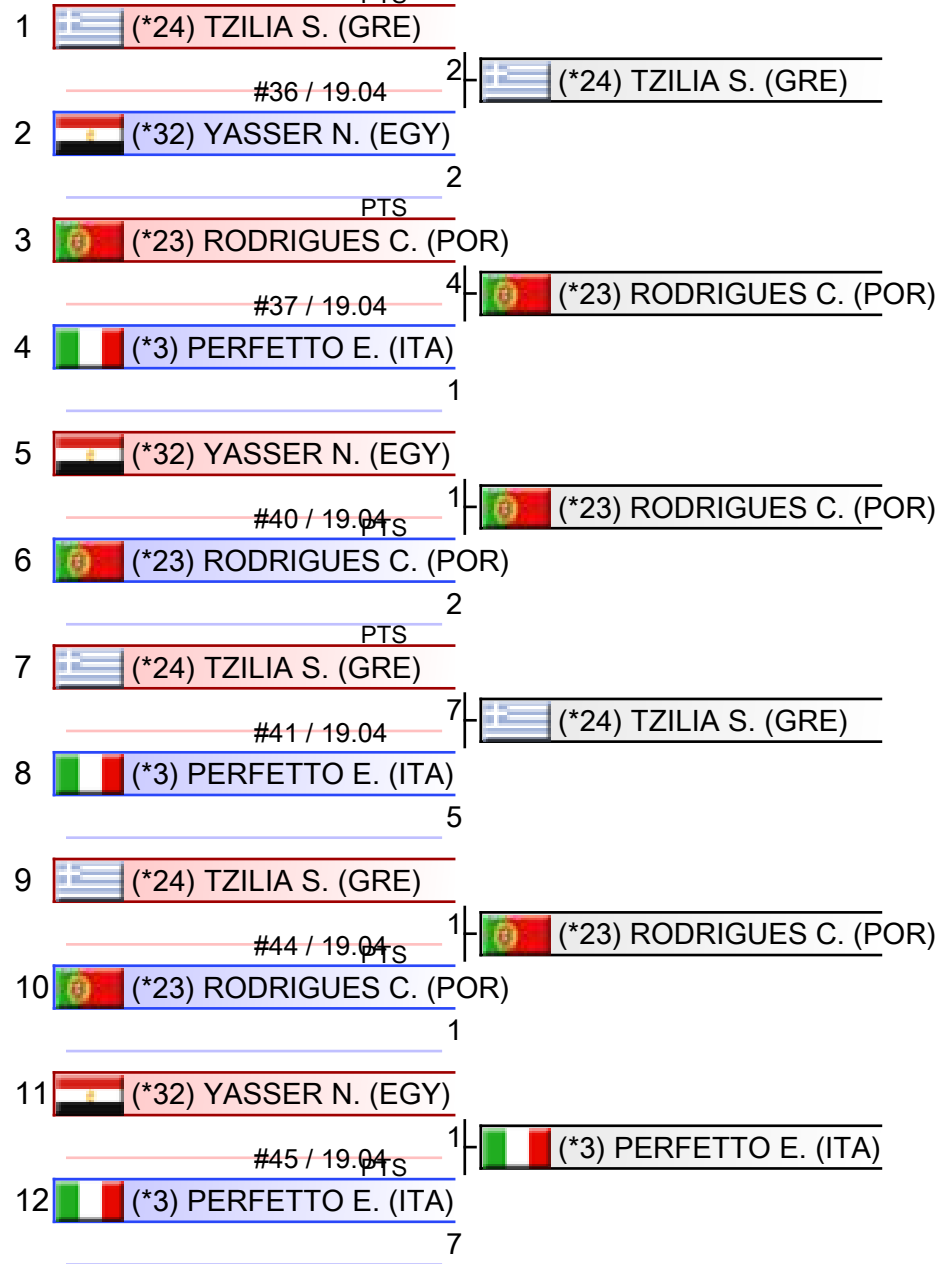

1. RODRIGUES CATARINA (POR)
2. TZILIA STYLIANI-ELENI (GRE)
3. PERFETTO ERMINIA (ITA)
4. YASSER NAGHAM (EGY)



1. ALY GANNA (EGY)
2. ZHANGBYRBAY MOLDIR (KAZ)
3. CARDENAS BALCAZAR SOFIA (COL)
3. OUIKENE CYLIA (ALG)
5. SGARDELLI EMA (CRO)
5. TSUTSUMI SARA (JPN)
7. RODRIGUES CATARINA (POR)
7. AGUS ASIA (ITA)

\*Seeded

Referees:			

# Female Kumite -50 Kg - Round Robin (each against each)

Karate1 Premier League - Cairo 2024, Cairo, EGY

Tatami

Pool  
3/8

1	(*11) TEYMUROVA F. (AZE)	2	(*22) COLLETTI E. (ITA)
	#100 / 19.04		
2	(*22) COLLETTI E. (ITA)	3	
3	(*31) MORALES CHAVEZ B. (GUA)	1	(*20) OUIKENE C. (ALG)
	#101 / 19.04		
4	(*20) OUIKENE C. (ALG)	6	
5	(*22) COLLETTI E. (ITA)	2	(*22) COLLETTI E. (ITA)
	#104 / 19.04		
6	(*31) MORALES CHAVEZ B. (GUA)	0	
7	(*11) TEYMUROVA F. (AZE)	0	(*20) OUIKENE C. (ALG)
	#105 / 19.04		
8	(*20) OUIKENE C. (ALG)	2	
9	(*11) TEYMUROVA F. (AZE)	1	(*11) TEYMUROVA F. (AZE)
	#108 / 19.04		
10	(*31) MORALES CHAVEZ B. (GUA)	0	
11	(*22) COLLETTI E. (ITA)	0	(*20) OUIKENE C. (ALG)
	#109 / 19.04		
12	(*20) OUIKENE C. (ALG)	1	



1. OUIKENE CYLIA (ALG)
2. COLLETTI EMMA (ITA)
3. TEYMUROVA FIDAN (AZE)
4. MORALES CHAVEZ BARBARA MICHELLE (GUA)

1. ALY GANNA (EGY)
2. ZHANGBYRBAY MOLDIR (KAZ)
3. CARDENAS BALCAZAR SOFIA (COL)
3. OUIKENE CYLIA (ALG)
5. SGARDELLI EMA (CRO)
5. TSUTSUMI SARA (JPN)
7. RODRIGUES CATARINA (POR)
7. AGUS ASIA (ITA)

\*Seeded

Referees:			

# Female Kumite -50 Kg - Round Robin (each against each)

Karate1 Premier League - Cairo 2024, Cairo, EGY

Tatami

Pool  
4/8

1	(*16) PEHAR J. (CRO)	#102 / 19.04	1	(*16) PEHAR J. (CRO)
2	(*26) PINILLA SANCHEZ A. (ESP)		0	
3	(*8) PALASHEVSKA Y. (UKR)	#103 / 19.04	0	(*2) ZHANGBYRBAY M. (KAZ)
4	(*2) ZHANGBYRBAY M. (KAZ)		2	
5	(*26) PINILLA SANCHEZ A. (ESP)	#106 / 19.04	0	(*8) PALASHEVSKA Y. (UKR)
6	(*8) PALASHEVSKA Y. (UKR)		2	
7	(*16) PEHAR J. (CRO)	#107 / 19.04	1	(*2) ZHANGBYRBAY M. (KAZ)
8	(*2) ZHANGBYRBAY M. (KAZ)		7	
9	(*16) PEHAR J. (CRO)	#110 / 19.04	3	(*16) PEHAR J. (CRO)
10	(*8) PALASHEVSKA Y. (UKR)		1	
11	(*26) PINILLA SANCHEZ A. (ESP)	#111 / 19.04	0	(*2) ZHANGBYRBAY M. (KAZ)
12	(*2) ZHANGBYRBAY M. (KAZ)		2	

1. ZHANGBYRBAY MOLDIR (KAZ)
2. PEHAR JELENA (CRO)
3. PALASHEVSKA YULIIA (UKR)
4. PINILLA SANCHEZ ALBA (ESP)



1. ALY GANNA (EGY)
2. ZHANGBYRBAY MOLDIR (KAZ)
3. CARDENAS BALCAZAR SOFIA (COL)
3. OUIKENE CYLIA (ALG)
5. SGARDELLI EMA (CRO)
5. TSUTSUMI SARA (JPN)
7. RODRIGUES CATARINA (POR)
7. AGUS ASIA (ITA)

\*Seeded

Referees:			

# Female Kumite -50 Kg - Round Robin (each against each)

Karate1 Premier League - Cairo 2024, Cairo, EGY

Tatami

Pool  
5/8

1	(*18) CARDENAS BALCAZAR S. (COL)	5	(*18) CARDENAS BALCAZAR S. (COL)
	#172 / 19.04		
2	(*19) RODRIGUEZ LOREDO E. (ESP)	4	
	PTS		
3	(*28) ALAJMI H. (UAE)	1	(*28) ALAJMI H. (UAE)
	#173 / 19.04		
4	(*14) KONTOU I. (CYP)	0	
	PTS		
5	(*19) RODRIGUEZ LOREDO E. (ESP)	6	(*28) ALAJMI H. (UAE)
	#176 / 19.04		
6	(*28) ALAJMI H. (UAE)	8	
	PTS		
7	(*18) CARDENAS BALCAZAR S. (COL)	1	(*18) CARDENAS BALCAZAR S. (COL)
	#177 / 19.04		
8	(*14) KONTOU I. (CYP)	0	
	PTS		
9	(*18) CARDENAS BALCAZAR S. (COL)	10	(*18) CARDENAS BALCAZAR S. (COL)
	#180 / 19.04		
10	(*28) ALAJMI H. (UAE)	2	
	PTS		
11	(*19) RODRIGUEZ LOREDO E. (ESP)	2	(*19) RODRIGUEZ LOREDO E. (ESP)
	#181 / 19.04		
12	(*14) KONTOU I. (CYP)	1	
	PTS		



1. CARDENAS BALCAZAR SOFIA (COL)
2. ALAJMI HAWRAA (UAE)
3. RODRIGUEZ LOREDO EVA (ESP)
4. KONTOU IRENE (CYP)

1. ALY GANNA (EGY)
2. ZHANGBYRBAY MOLDIR (KAZ)
3. CARDENAS BALCAZAR SOFIA (COL)
3. OUIKENE CYLIA (ALG)
5. SGARDELLI EMA (CRO)
5. TSUTSUMI SARA (JPN)
7. RODRIGUES CATARINA (POR)
7. AGUS ASIA (ITA)

\*Seeded

Referees:			

# Female Kumite -50 Kg - Round Robin (each against each)

Karate1 Premier League - Cairo 2024, Cairo, EGY

Tatami

Pool  
6/8

1	(*27) YALCIN S. (NED)	0
	#174 / 19.04	
2	(*15) CHANDRAN S. (MAS)	0
	PTS	
3	(*10) AGUS A. (ITA)	3
	#175 / 19.04	(*10) AGUS A. (ITA)
4	(*4) VARGOVA N. (SVK)	1
5	(*15) CHANDRAN S. (MAS)	1
	#178 / 19.04	(*10) AGUS A. (ITA)
6	(*10) AGUS A. (ITA)	3
	PTS	
7	(*27) YALCIN S. (NED)	8
	#179 / 19.04	(*27) YALCIN S. (NED)
8	(*4) VARGOVA N. (SVK)	6
9	(*27) YALCIN S. (NED)	3
	#182 / 19.04	(*10) AGUS A. (ITA)
10	(*10) AGUS A. (ITA)	4
	PTS	
11	(*15) CHANDRAN S. (MAS)	1
	#183 / 19.04	(*4) VARGOVA N. (SVK)
12	(*4) VARGOVA N. (SVK)	2



1. AGUS ASIA (ITA)
2. YALCIN SAMINA (NED)
3. VARGOVA NATALIA (SVK)
4. CHANDRAN SHAHMALARANI (MAS)

1. ALY GANNA (EGY)
2. ZHANGBYRBAY MOLDIR (KAZ)
3. CARDENAS BALCAZAR SOFIA (COL)
3. OUIKENE CYLIA (ALG)
5. SGARDELLI EMA (CRO)
5. TSUTSUMI SARA (JPN)
7. RODRIGUES CATARINA (POR)
7. AGUS ASIA (ITA)

\*Seeded

Referees:			

# Female Kumite -50 Kg - Round Robin (each against each)

Karate1 Premier League - Cairo 2024, Cairo, EGY

Tatami

Pool

7/8



1. ALY GANNA (EGY)
2. HUBRICH SHARA (GER)
3. SEKKOUR RAYANE (ALG)
4. GOMEZ MORALES NADIA (ESP)



1. ALY GANNA (EGY)
2. ZHANGBYRBAY MOLDIR (KAZ)
3. CARDENAS BALCAZAR SOFIA (COL)
3. OUIKENE CYLIA (ALG)
5. SGARDELLI EMA (CRO)
5. TSUTSUMI SARA (JPN)
7. RODRIGUES CATARINA (POR)
7. AGUS ASIA (ITA)

\*Seeded

Referees:			

# Female Kumite -50 Kg - Round Robin (each against each)

Karate1 Premier League - Cairo 2024, Cairo, EGY

Tatami

Pool  
8/8

1	(*13) IZAGUIRRE G. (ESA)	
	#240 / 19.04	1    (*13) IZAGUIRRE G. (ESA)
2	(*9) ELHAYTI C. (MAR)	
	PTS	1
3	(*25) TSUTSUMI S. (JPN)	
	#241 / 19.04	5    (*25) TSUTSUMI S. (JPN)
4	(*1) SALAMA R. (EGY)	
	PTS	4
5	(*9) ELHAYTI C. (MAR)	
	#244 / 19.04	0    (*25) TSUTSUMI S. (JPN)
6	(*25) TSUTSUMI S. (JPN)	
	PTS	3
7	(*13) IZAGUIRRE G. (ESA)	
	#245 / 19.04	2    (*1) SALAMA R. (EGY)
8	(*1) SALAMA R. (EGY)	
	PTS	7
9	(*13) IZAGUIRRE G. (ESA)	
	#248 / 19.04	0    (*25) TSUTSUMI S. (JPN)
10	(*25) TSUTSUMI S. (JPN)	
	PTS	1
11	(*9) ELHAYTI C. (MAR)	
	#249 / 19.04	4    (*9) ELHAYTI C. (MAR)
12	(*1) SALAMA R. (EGY)	
	PTS	3

1. TSUTSUMI SARA (JPN)
2. SALAMA REEM AHMED (EGY)
3. IZAGUIRRE GABRIELLA (ESA)
4. ELHAYTI CHAIMAE (MAR)



1. ALY GANNA (EGY)
2. ZHANGBYRBAY MOLDIR (KAZ)
3. CARDENAS BALCAZAR SOFIA (COL)
3. OUIKENE CYLIA (ALG)
5. SGARDELLI EMA (CRO)
5. TSUTSUMI SARA (JPN)
7. RODRIGUES CATARINA (POR)
7. AGUS ASIA (ITA)

\*Seeded

Referees:			

# Pool winner-Female Kumite -50 Kg

Karate1 Premier League - Cairo 2024, Cairo, EGY

Tatami

Pool

1/1

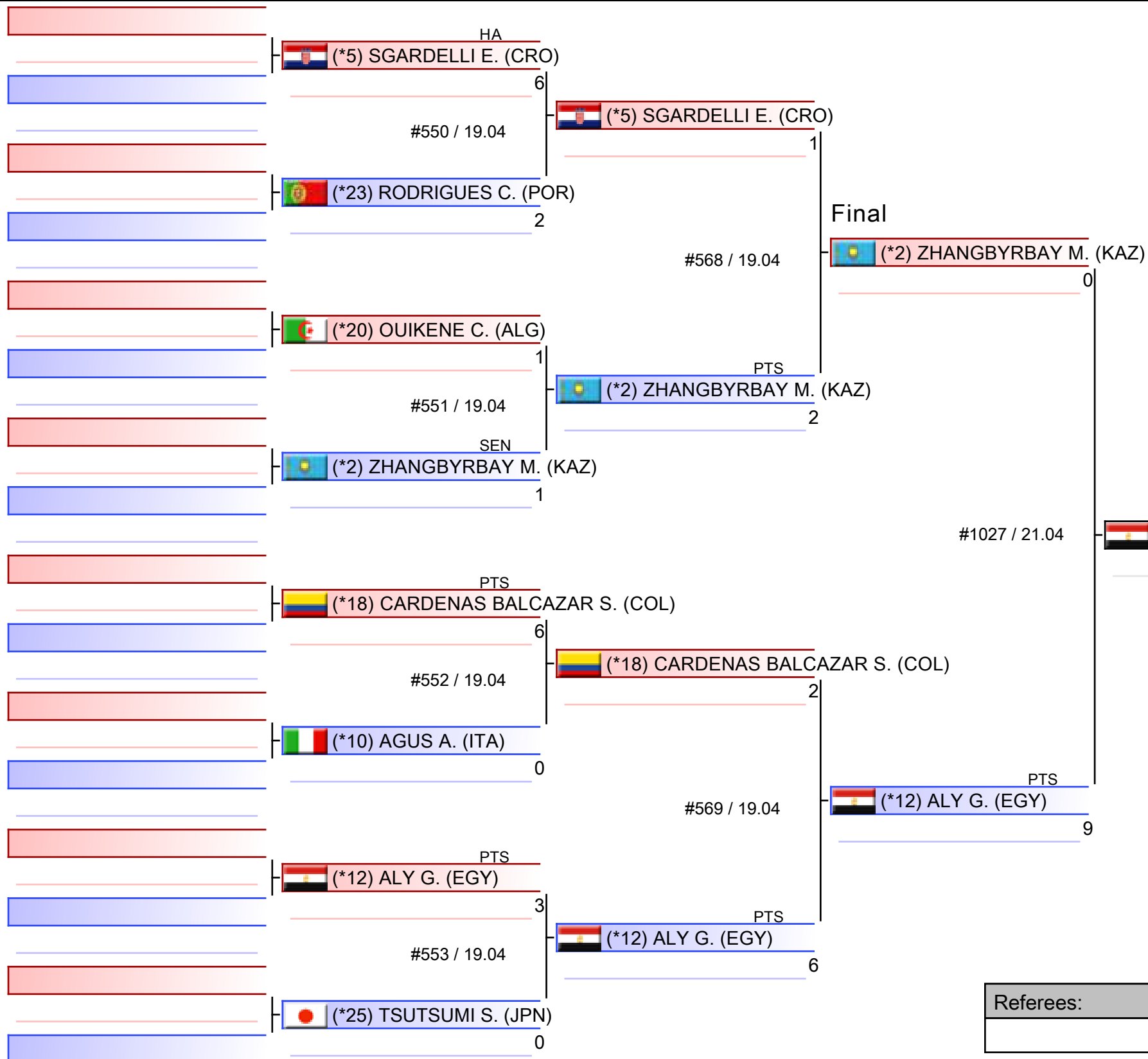

1. ALY GANNA (EGY)
2. ZHANGBYRBAY MOLDIR (KAZ)
3. CARDENAS BALCAZAR SOFIA (COL)
3. OUIKENE CYLIA (ALG)
5. SGARDELLI EMA (CRO)
5. TSUTSUMI SARA (JPN)
7. RODRIGUES CATARINA (POR)
7. AGUS ASIA (ITA)

\*Seeded

Referees:			



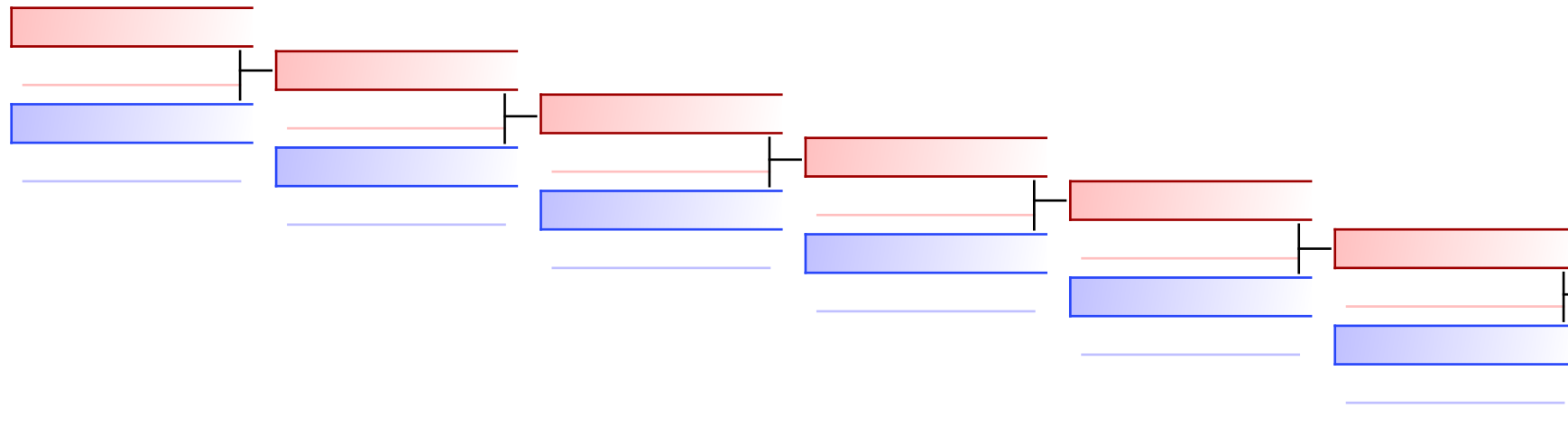

PTS

	OUIKENE CYLIA (ALG)	3
	SGARDELLI EMA (CRO)	0

REPECHAGE: (1,2,3,4,5,6,7,8)

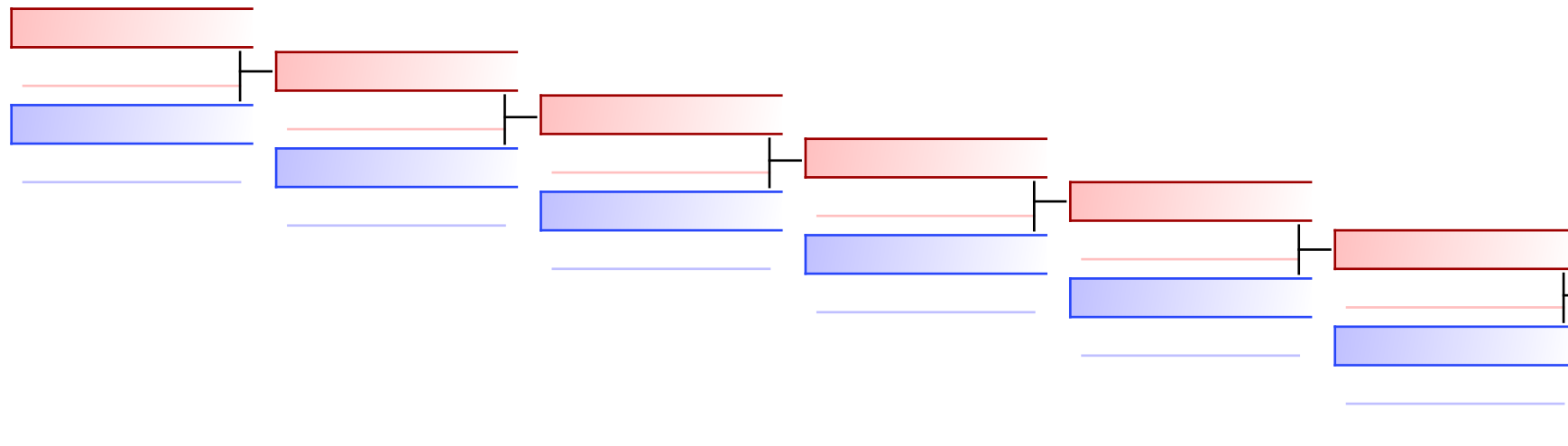

#1007 / 21.04

	TSUTSUMI SARA (JPN)	3
	CARDENAS BALCAZAR SOFIA (COL)	4

PTS

Referees:							
-----------	--	--	--	--	--	--	--



Karate1 Premier League - Cairo 2024 - 2024-04-19



## Official Results

Female Kumite -50 Kg			
1	ALY GANNA		EGY - EGYPT
2	ZHANGBYRBAY MOLDIR		KAZ - KAZAKHSTAN
3	CARDENAS BALCAZAR SOFIA		COL - COLOMBIA
3	OUIKENE CYLIA		ALG - ALGERIA
5	SGARDELLI EMA		CRO - CROATIA
5	TSUTSUMI SARA		JPN - JAPAN
7	RODRIGUES CATARINA		POR - PORTUGAL
7	AGUS ASIA		ITA - ITALY

# FEMALE KUMITE -55 KG



# Karate1 Premier League - Cairo 2024

## ENTRIES BY WEIGHT CATEGORY



### Female Kumite -55 Kg

As of 21 APR 2024

NOC Code	Gender	Name	Seeding
ALG	F	ABOURICHE LOUIZA	7
AZE	F	SADIGOVA MADINA	13
BRA	F	KUMIZAKI VALERIA	17
CAN	F	FURUMOTO-DESHAIES HANA	5
CHI	F	TORO MENESES VALENTINA	8
EGY	F	Attia Mirna	28
EGY	F	Hassan Salma	29
FRA	F	CHARIF ASSMA	22
GER	F	BITSCH MIA	4
GER	F	BUGUR GIZEM	10
GRE	F	Stoli Maria	9
INA	F	AGUNG SANISTYARANI COK ISTRY	16
ITA	F	BRUNORI VERONICA	11
ITA	F	Lallo viola	27
ITA	F	Mancinelli Syria	18
JPN	F	SHIMA AIRI	6
JPN	F	Yatoji akira	19
KAZ	F	Samasheva Bella	25
KAZ	F	USSENOVA GULMIRA	2
LAT	F	MUIZNIECE MARIJA LUIZE	12
LUX	F	WARLING JENNIFER	15
POL	F	DRONCHANKA KSENIYA	21
SUI	F	SCHAERER MAYA	23
SVK	F	KVASNICOVA NINA	14
TPE	F	KU TSUI-PING	3
TUR	F	im zumra rezzan	24
TUR	F	YAKAN TUBA	1
UKR	F	PROTSENKO ANNA	26
USA	F	ALLEN TRINITY	20

# Female Kumite -55 Kg - Round Robin (each against each)

Karate1 Premier League - Cairo 2024, Cairo, EGY

Tatami

Pool  
1/8

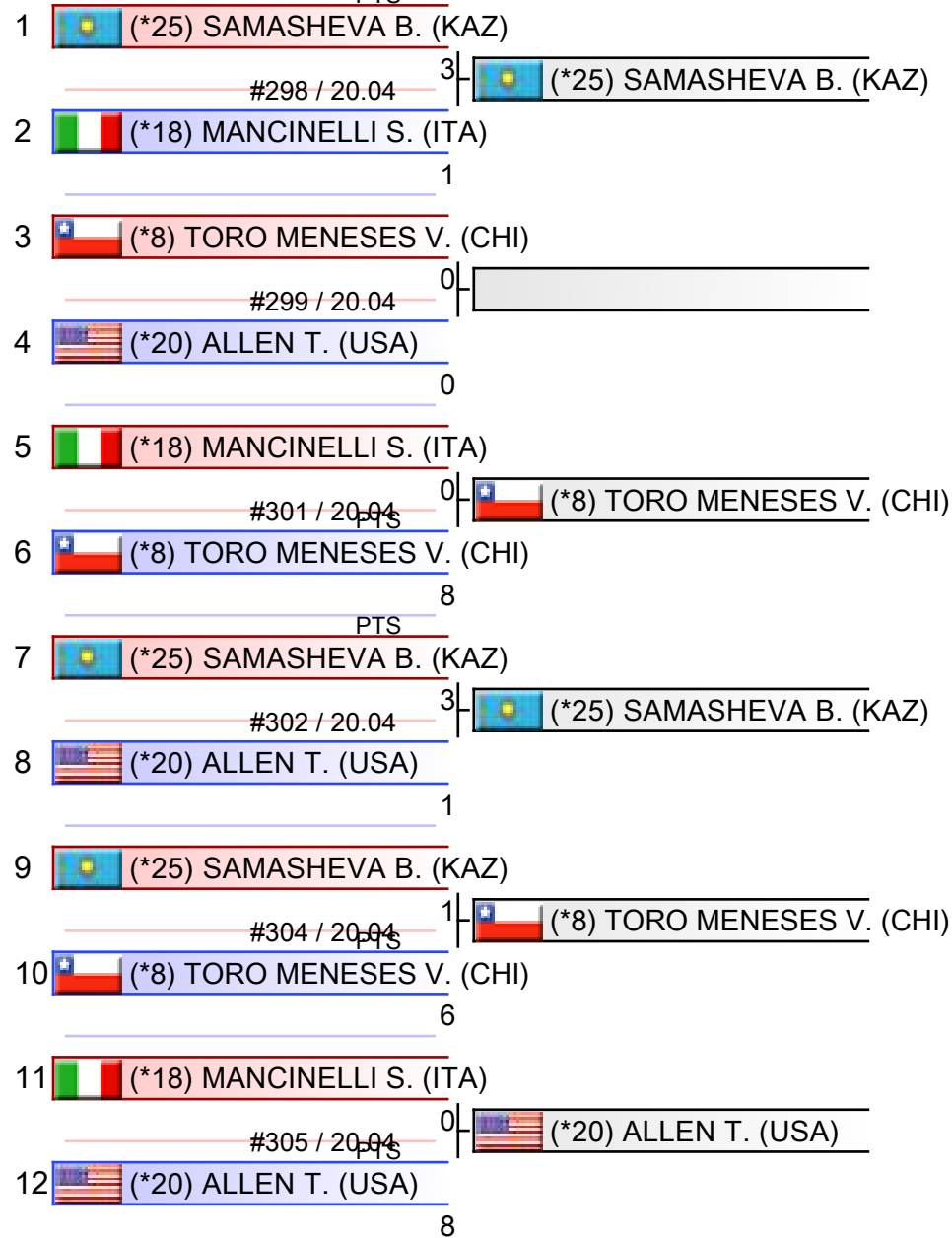

1. TORO MENESES VALENTINA (CHI)
2. SAMASHEVA BELLA (KAZ)
3. ALLEN TRINITY (USA)
4. MANCINELLI SYRIA (ITA)



1. TORO MENESES VALENTINA (CHI)
2. STOLI MARIA (GRE)
3. BRUNORI VERONICA (ITA)
3. LALLO VIOLA (ITA)
5. DRONCHANKA KSENIYA (POL)
5. BITSCH MIA (GER)
7. HASSAN SALMA (EGY)
7. AGUNG SANISTYARANI COK ISTRI (INA)

\*Seeded







Referees:			

# Female Kumite -55 Kg - Round Robin (each against each)

Karate1 Premier League - Cairo 2024, Cairo, EGY

Tatami

Pool  
2/8

1	 (*7) ABOURICHE L. (ALG)	PTS	0
	#300 / 20.04		
2	 (*21) DRONCHANKA K. (POL)	PTS	0
3	 (*7) ABOURICHE L. (ALG)	PTS	0
	#306 / 20.04		
4	 (*3) KU T. (TPE)	PTS	2
5	 (*21) DRONCHANKA K. (POL)	PTS	9
	#303 / 20.04		
6	 (*3) KU T. (TPE)	PTS	1

1. DRONCHANKA KSENIYA (POL)
2. KU TSUI-PING (TPE)
3. ABOURICHE LOUIZA (ALG)



1. TORO MENESES VALENTINA (CHI)
2. STOLI MARIA (GRE)
3. BRUNORI VERONICA (ITA)
3. LALLO VIOLA (ITA)
5. DRONCHANKA KSENIYA (POL)
5. BITSCH MIA (GER)
7. HASSAN SALMA (EGY)
7. AGUNG SANISTYARANI COK ISTRI (INA)

\*Seeded

Referees:			

# Female Kumite -55 Kg - Round Robin (each against each)

Karate1 Premier League - Cairo 2024, Cairo, EGY

Tatami

Pool  
3/8

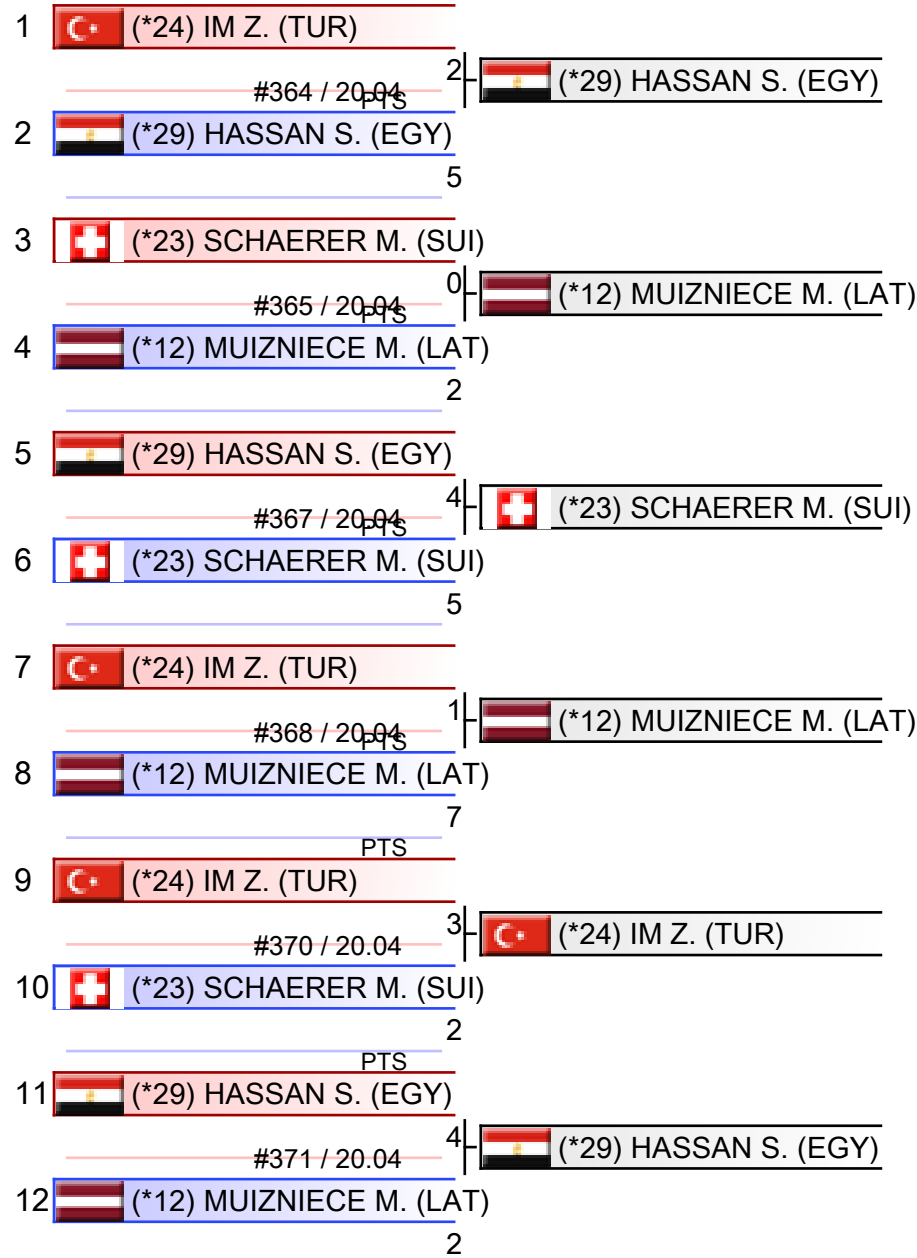

1. HASSAN SALMA (EGY)
2. MUIZNIECE MARIJA LUIZE (LAT)
3. IM ZUMRA REZZAN (TUR)
4. SCHAERER MAYA (SUI)



1. TORO MENESES VALENTINA (CHI)
2. STOLI MARIA (GRE)
3. BRUNORI VERONICA (ITA)
3. LALLO VIOLA (ITA)
5. DRONCHANKA KSENIYA (POL)
5. BITSCH MIA (GER)
7. HASSAN SALMA (EGY)
7. AGUNG SANISTYARANI COK ISTRI (INA)

\*Seeded

Referees:			

# Female Kumite -55 Kg - Round Robin (each against each)

Karate1 Premier League - Cairo 2024, Cairo, EGY

Tatami

Pool

4/8

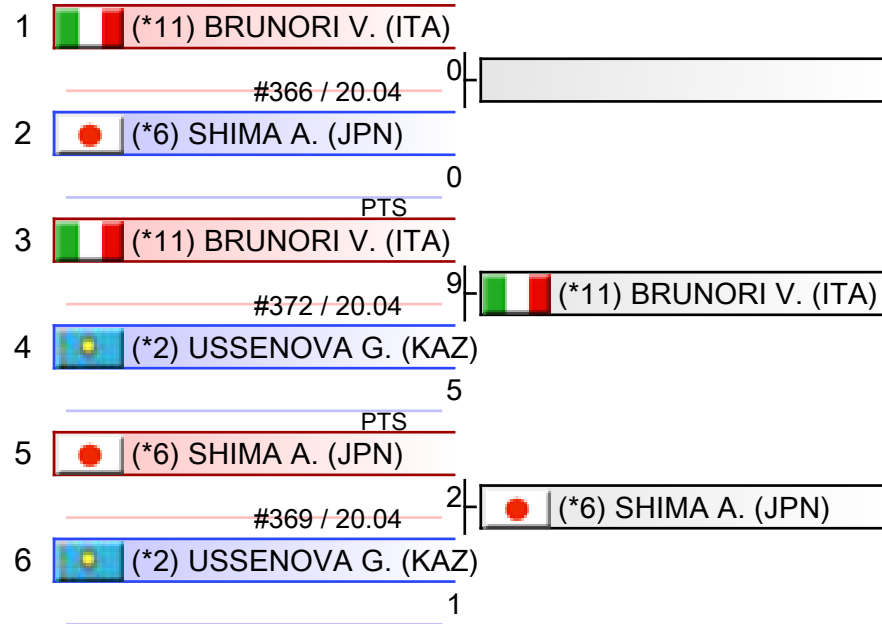

1. BRUNORI VERONICA (ITA)
2. SHIMA AIRI (JPN)
3. USSENOVA GULMIRA (KAZ)



1. TORO MENESES VALENTINA (CHI)
2. STOLI MARIA (GRE)
3. BRUNORI VERONICA (ITA)
3. LALLO VIOLA (ITA)
5. DRONCHANKA KSENIYA (POL)
5. BITSCH MIA (GER)
7. HASSAN SALMA (EGY)
7. AGUNG SANISTYARANI COK ISTRY (INA)

\*Seeded

Referees:			



# Female Kumite -55 Kg - Round Robin (each against each)

Karate1 Premier League - Cairo 2024, Cairo, EGY

Tatami

Pool  
5/8

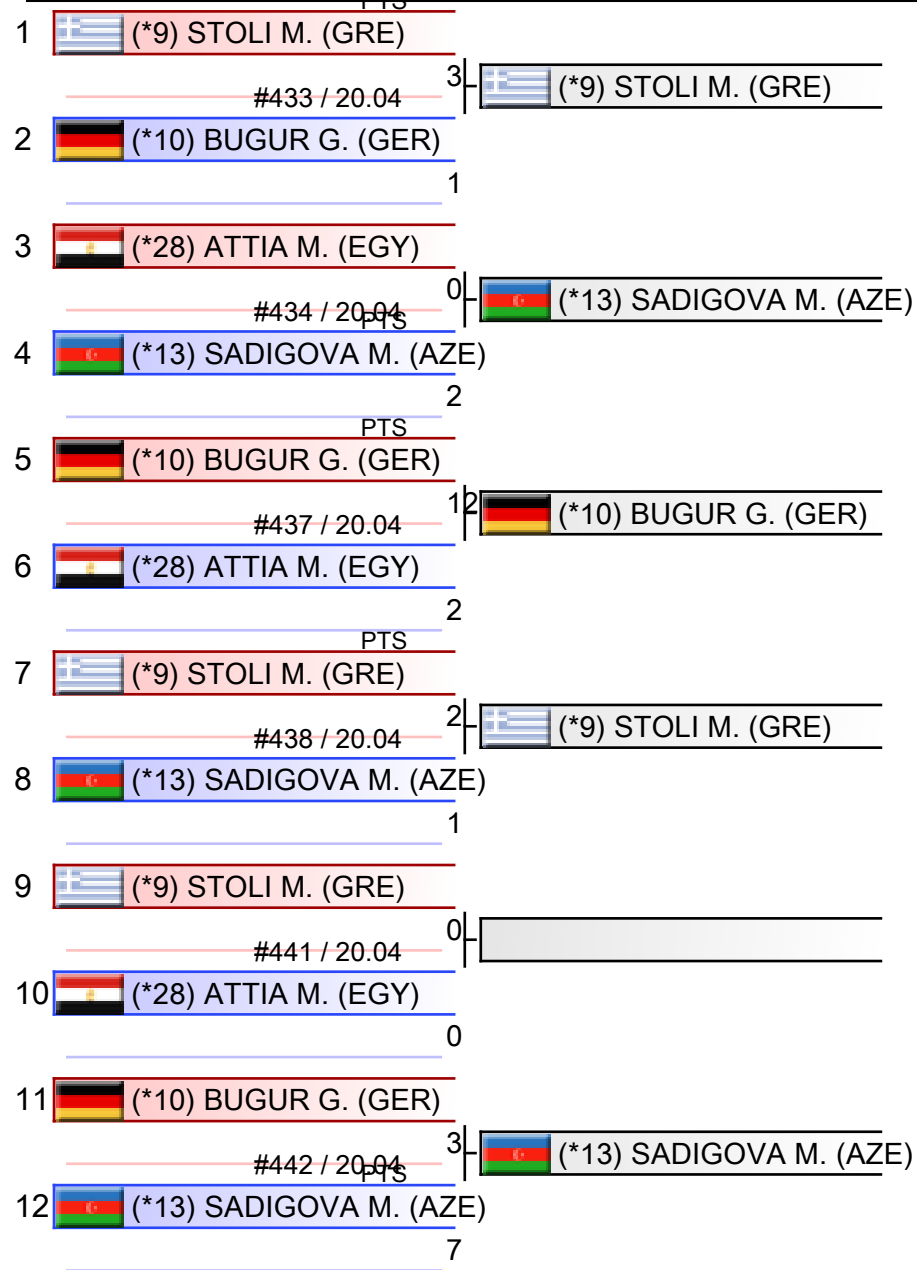

1. STOLI MARIA (GRE)
2. SADIGOVA MADINA (AZE)
3. BUGUR GIZEM (GER)
4. ATTIA MIRNA (EGY)



1. TORO MENESES VALENTINA (CHI)
2. STOLI MARIA (GRE)
3. BRUNORI VERONICA (ITA)
3. LALLO VIOLA (ITA)
5. DRONCHANKA KSENIYA (POL)
5. BITSCH MIA (GER)
7. HASSAN SALMA (EGY)
7. AGUNG SANISTYARANI COK ISTRI (INA)

\*Seeded

Referees:			

# Female Kumite -55 Kg - Round Robin (each against each)

Karate1 Premier League - Cairo 2024, Cairo, EGY

Tatami

Pool  
6/8



1. BITSCH MIA (GER)
2. YATOJI AKIRA (JPN)
3. WARLING JENNIFER (LUX)
4. KVASNICOVA NINA (SVK)



1. TORO MENESES VALENTINA (CHI)
2. STOLI MARIA (GRE)
3. BRUNORI VERONICA (ITA)
3. LALLO VIOLA (ITA)
5. DRONCHANKA KSENIYA (POL)
5. BITSCH MIA (GER)
7. HASSAN SALMA (EGY)
7. AGUNG SANISTYARANI COK ISTRI (INA)

\*Seeded

Referees:			

# Female Kumite -55 Kg - Round Robin (each against each)

Karate1 Premier League - Cairo 2024, Cairo, EGY

Tatami

Pool  
7/8



1. LALLO VIOLA (ITA)
2. FURUMOTO-DESHAIES HANA (CAN)
3. KUMIZAKI VALERIA (BRA)
4. PROTSENKO ANNA (UKR)



1. TORO MENESES VALENTINA (CHI)
2. STOLI MARIA (GRE)
3. BRUNORI VERONICA (ITA)
3. LALLO VIOLA (ITA)
5. DRONCHANKA KSENIYA (POL)
5. BITSCH MIA (GER)
7. HASSAN SALMA (EGY)
7. AGUNG SANISTYARANI COK ISTRI (INA)

\*Seeded

Referees:			

# Female Kumite -55 Kg - Round Robin (each against each)

Karate1 Premier League - Cairo 2024, Cairo, EGY

Tatami

Pool  
8/8

1	(*16) AGUNG SANISTYARANI C. (INA)	
	#501 / 20.04	2    (*16) AGUNG SANISTYARANI C. (INA)
2	(*22) CHARIF A. (FRA)	
	HT	1
3	(*16) AGUNG SANISTYARANI C. (INA)	
	#507 / 20.04	7    (*16) AGUNG SANISTYARANI C. (INA)
4	(*1) YAKAN T. (TUR)	
		4
5	(*22) CHARIF A. (FRA)	
	#504 / 20.04	4    (*1) YAKAN T. (TUR)
6	(*1) YAKAN T. (TUR)	
		5



1. AGUNG SANISTYARANI COK ISTRI (INA)
2. YAKAN TUBA (TUR)
3. CHARIF ASSMA (FRA)

1. TORO MENESES VALENTINA (CHI)
2. STOLI MARIA (GRE)
3. BRUNORI VERONICA (ITA)
3. LALLO VIOLA (ITA)
5. DRONCHANKA KSENIYA (POL)
5. BITSCH MIA (GER)
7. HASSAN SALMA (EGY)
7. AGUNG SANISTYARANI COK ISTRI (INA)

\*Seeded

Referees:			

# Pool winner-Female Kumite -55 Kg

Karate1 Premier League - Cairo 2024, Cairo, EGY

Tatami

Pool  
1/1

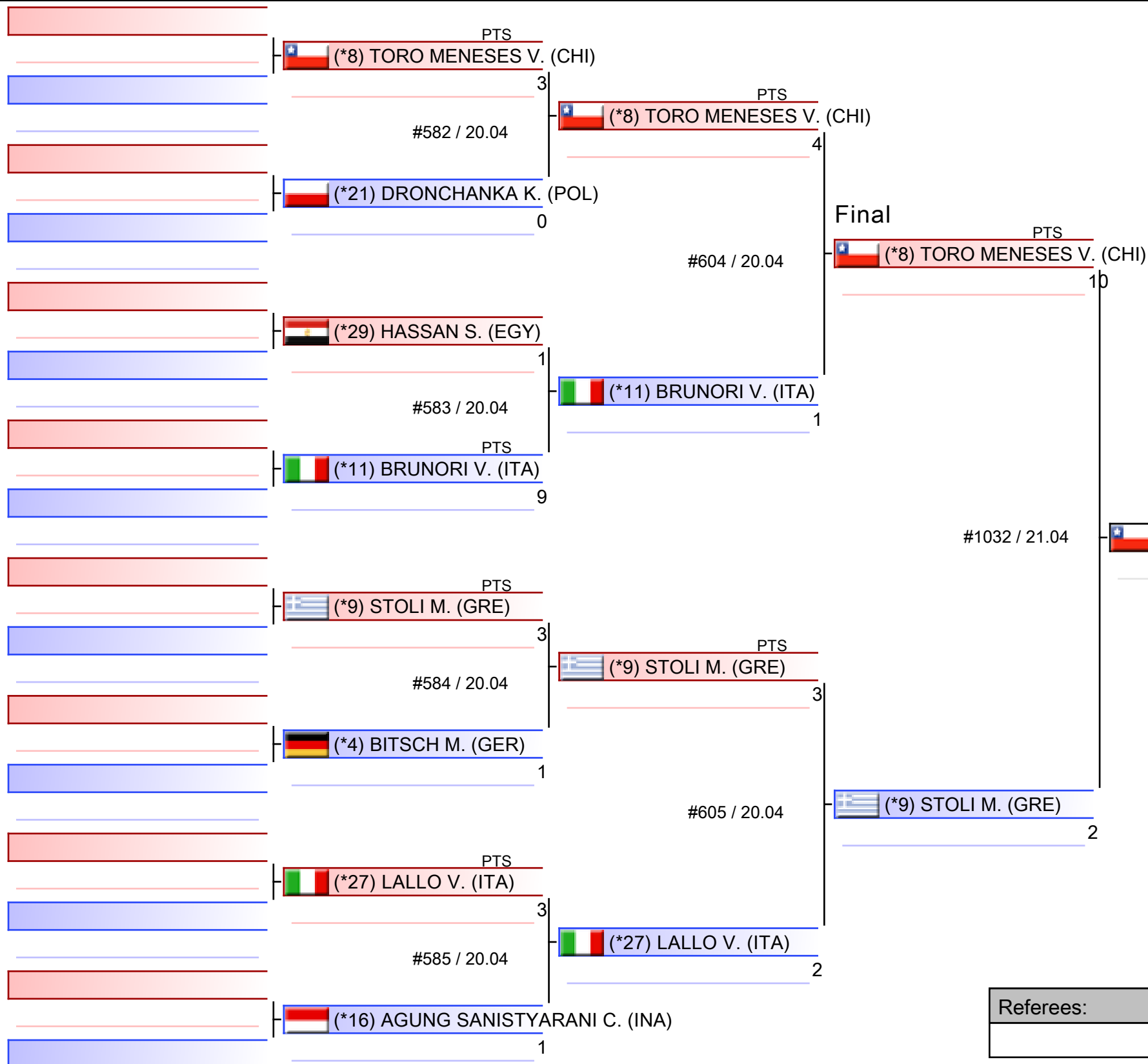

1. TORO MENESES VALENTINA (CHI)
2. STOLI MARIA (GRE)
3. BRUNORI VERONICA (ITA)
3. LALLO VIOLA (ITA)
5. DRONCHANKA KSENIYA (POL)
5. BITSCH MIA (GER)
7. HASSAN SALMA (EGY)
7. AGUNG SANISTYARANI COK ISTRI (INA)

\*Seeded

Referees:			

Female Kumite -55 Kg  
Karate1 Premier League - Cairo 2024

Tatami

Pool  
1,2,3,4,5,6,7,8

(c)sportdata GmbH & Co KG 2000-2024 (2024-04-21 18:26) v 10.2.0 build 1 (2024-04-20 17:58 CET) License: SDIL\_TV-Graphics (expire 2024-12-31)

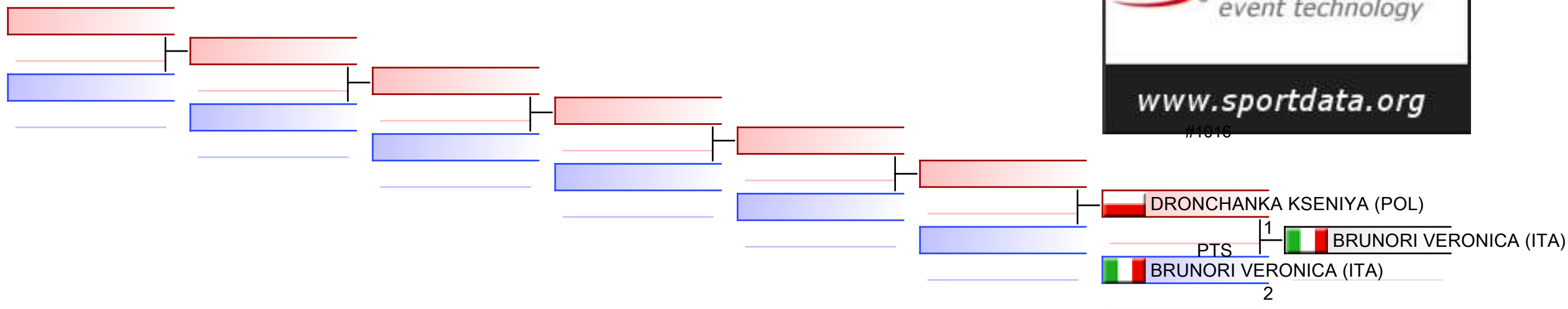

REPECHAGE: (1,2,3,4,5,6,7,8)

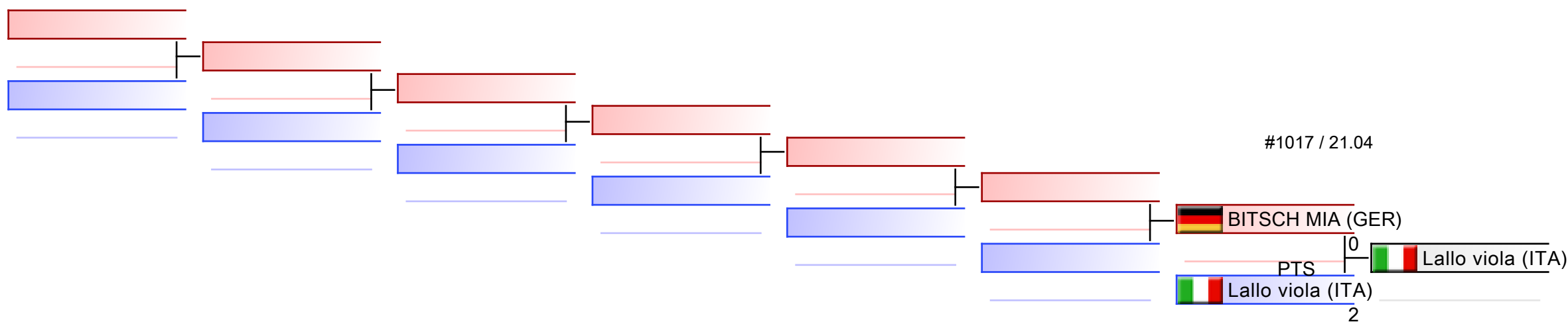

Referees:							
-----------	--	--	--	--	--	--	--



Karate1 Premier League - Cairo 2024 - 2024-04-19



## Official Results

Female Kumite -55 Kg			
1	TORO MENESES VALENTINA		CHI - CHILE
2	STOLI MARIA		GRE - GREECE
3	BRUNORI VERONICA		ITA - ITALY
3	LALLO VIOLA		ITA - ITALY
5	DRONCHANKA KSENIYA		POL - POLAND
5	BITSCH MIA		GER - GERMANY
7	HASSAN SALMA		EGY - EGYPT
7	AGUNG SANISTYARANI COK ISTRY		INA - INDONESIA

# FEMALE KUMITE -61 KG





Karate1 Premier League - Cairo 2024  
**ENTRIES BY WEIGHT CATEGORY**



**Female Kumite -61 Kg**

As of 21 APR 2024

NOC Code	Gender	Name	Seeding
AUT	F	TOPALOVIC LEJLA	21
BEL	F	AJARAY MARYAM	7
CRO	F	CACKO MIA	26
EGY	F	ALY NOURSIN	15
ESP	F	FERNANDEZ OSORIO CARLOTA	29
ESP	F	ZUNIGA GARCIA INDIRA	17
FRA	F	AVAZERI LEA	13
FRA	F	Sivert Laura	12
GER	F	KHAMIS REEM	2
GRE	F	CHRYSOPOULOU KONSTANTINA	11
ITA	F	ANGELUCCI GIULIA	24
ITA	F	Mangiacapra Alessandra	28
ITA	F	MARTURANO IRENE	23
JPN	F	Kujuro Yuki	10
JPN	F	Shimada Sarara	5
KAZ	F	KANAY ASSEL	4
MAR	F	CHAJAI FATIMA-ZAHRA	8
MKD	F	KOSTOVSKA VERONIKA	20
PER	F	Grande Alexandra	19
SUI	F	Radjenovic Nina	25
SVK	F	SUCHANKOVA INGRIDA	9
SWE	F	NILSSON ANNA-JOHANNA	14
TUN	F	mahjoub wafa	3
TUR	F	GOZUTOK GULBAHAR	16
TUR	F	YENEN FATMA NAZ	6
UAE	F	alameri Sarah	22
UKR	F	SEROGINA ANITA	1
UKR	F	SHOLOHOVA OLEKSANDRA	18
UKR	F	Yervacheva Darya	27

# Female Kumite -61 Kg - Round Robin (each against each)

Karate1 Premier League - Cairo 2024, Cairo, EGY

Tatami

Pool

1/8

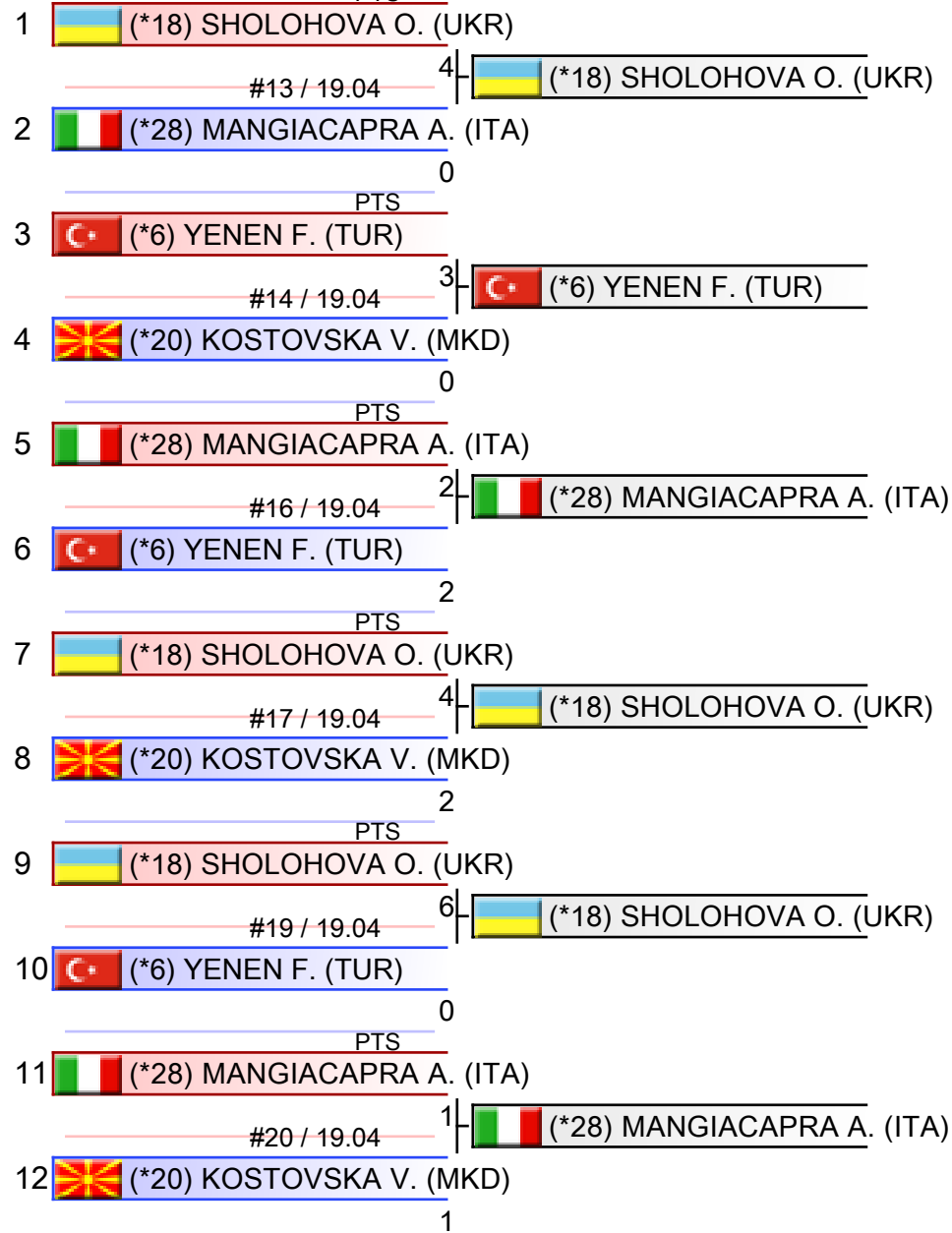

1. SHOLOHOVA OLEKSANDRA (UKR)
2. MANGIACAPRA ALESSANDRA (ITA)
3. YENEN FATMA NAZ (TUR)
4. KOSTOVSKA VERONIKA (MKD)



1. KHAMIS REEM (GER)
2. NILSSON ANNA-JOHANNA (SWE)
3. SHIMADA SARARA (JPN)
3. GRANDE ALEXANDRA (PER)
5. KUJURO YUKI (JPN)
5. RADJENOVIC NINA (SUI)
7. SHOLOHOVA OLEKSANDRA (UKR)
7. SIVERT LAURA (FRA)

\*Seeded

Referees:			

# Female Kumite -61 Kg - Round Robin (each against each)

Karate1 Premier League - Cairo 2024, Cairo, EGY

Tatami

Pool  
2/8

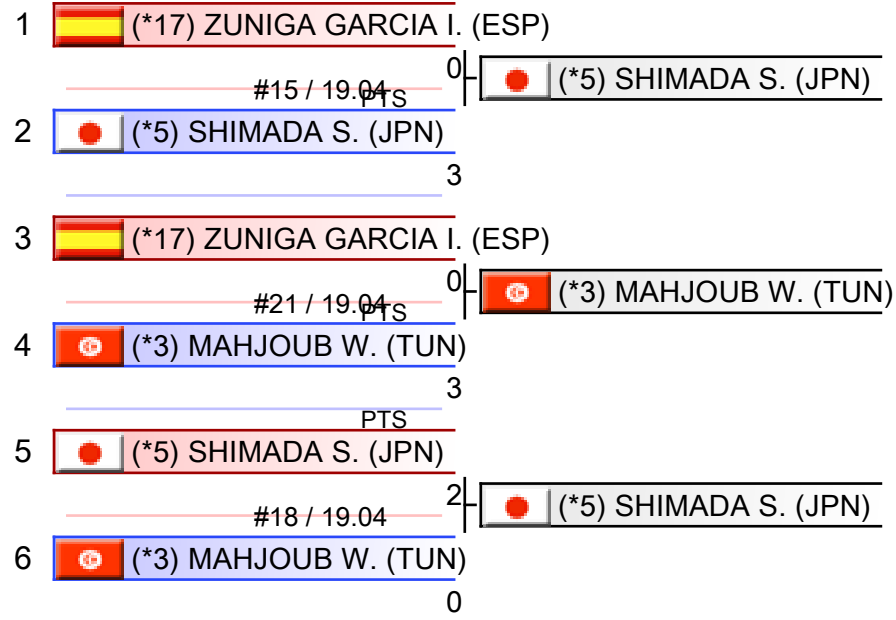

1. SHIMADA SARARA (JPN)
2. MAHJOUB Wafa (TUN)
3. ZUNIGA GARCIA INDIRA (ESP)



1. KHAMIS REEM (GER)
2. NILSSON ANNA-JOHANNA (SWE)
3. SHIMADA SARARA (JPN)
3. GRANDE ALEXANDRA (PER)
5. KUJURO YUKI (JPN)
5. RADJENOVIC NINA (SUI)
7. SHOLOHOVA OLEKSANDRA (UKR)
7. SIVERT LAURA (FRA)

\*Seeded

Referees:			

# Female Kumite -61 Kg - Round Robin (each against each)

Karate1 Premier League - Cairo 2024, Cairo, EGY

Tatami

Pool  
3/8

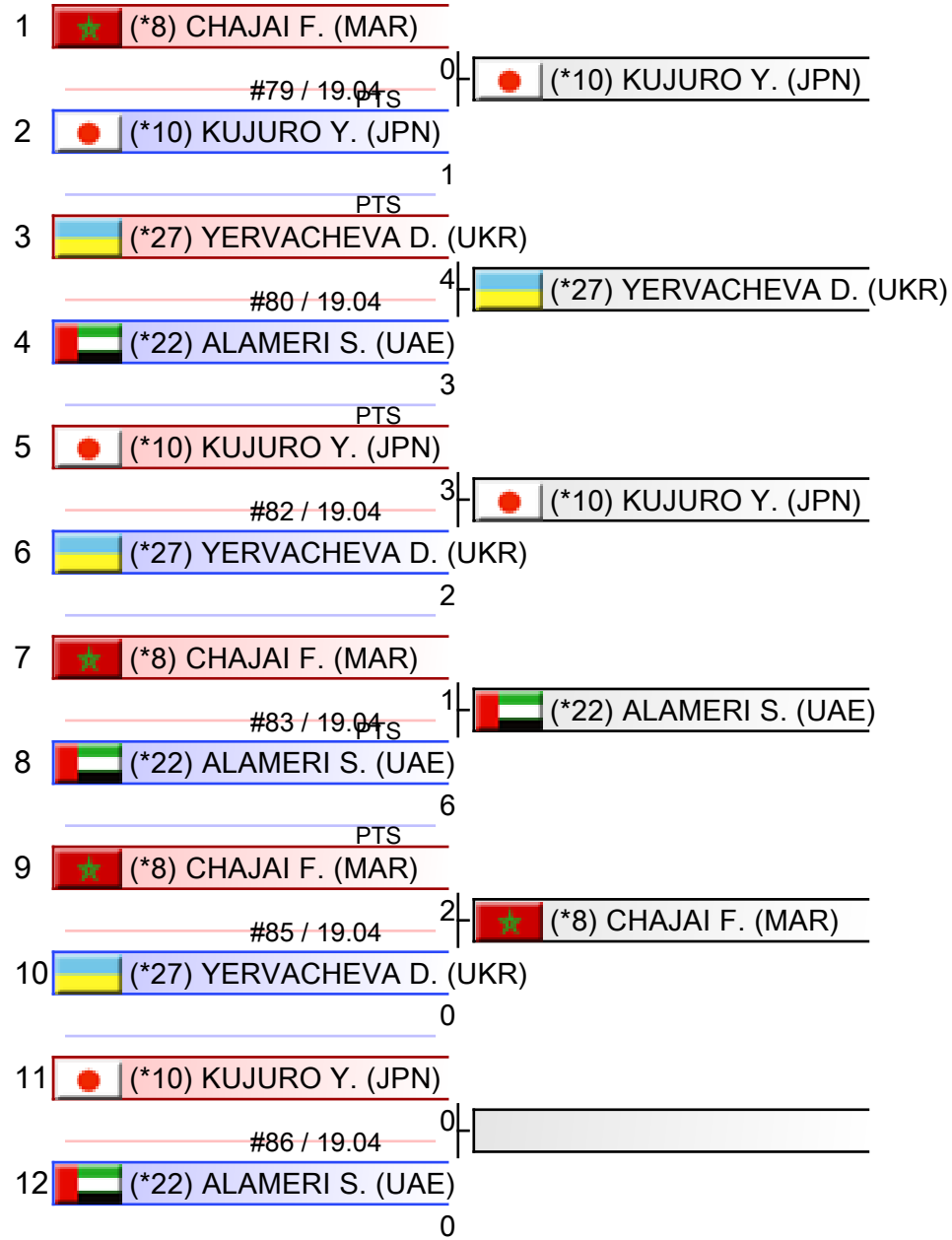

1. KUJURO YUKI (JPN)
2. ALAMERI SARAH (UAE)
3. CHAJAI FATIMA-ZAHRA (MAR)
4. YERVACHEVA DARYA (UKR)



1. KHAMIS REEM (GER)
2. NILSSON ANNA-JOHANNA (SWE)
3. SHIMADA SARARA (JPN)
3. GRANDE ALEXANDRA (PER)
5. KUJURO YUKI (JPN)
5. RADJENOVIC NINA (SUI)
7. SHOLOHOVA OLEKSANDRA (UKR)
7. SIVERT LAURA (FRA)

\*Seeded

Referees:			

# Female Kumite -61 Kg - Round Robin (each against each)

Karate1 Premier League - Cairo 2024, Cairo, EGY

Tatami

Pool  
4/8

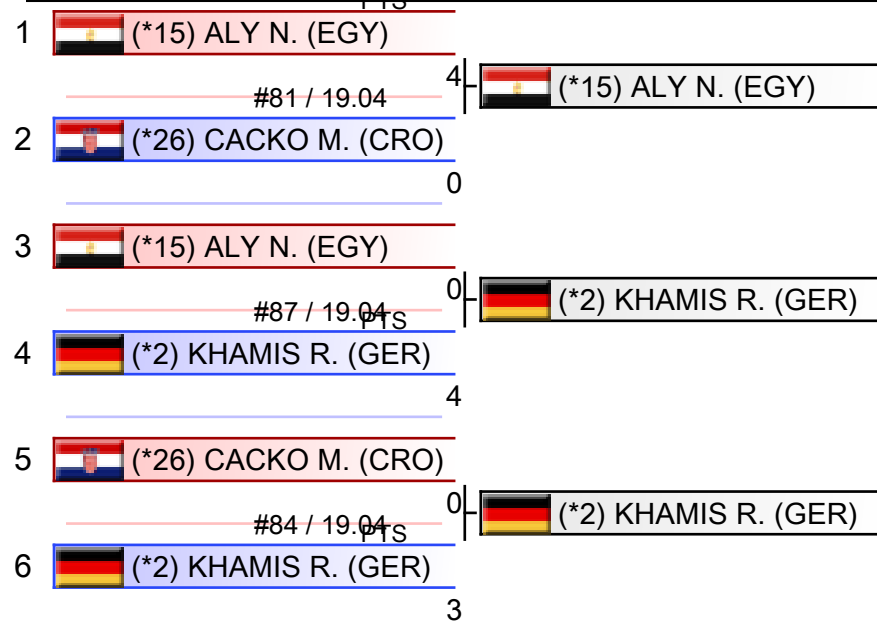

1. KHAMIS REEM (GER)
2. ALY NOURSIN (EGY)
3. CACKO MIA (CRO)



1. KHAMIS REEM (GER)
2. NILSSON ANNA-JOHANNA (SWE)
3. SHIMADA SARARA (JPN)
3. GRANDE ALEXANDRA (PER)
5. KUJURO YUKI (JPN)
5. RADJENOVIC NINA (SUI)
7. SHOLOHOVA OLEKSANDRA (UKR)
7. SIVERT LAURA (FRA)

\*Seeded

Referees:			

# Female Kumite -61 Kg - Round Robin (each against each)

Karate1 Premier League - Cairo 2024, Cairo, EGY

Tatami

Pool  
5/8

1	(*29) FERNANDEZ OSORIO C. (ESP)	
	#148 / 19.04	1    (*14) NILSSON A. (SWE)
2	(*14) NILSSON A. (SWE)	
	PTS	2
3	(*9) SUCHANKOVA I. (SVK)	
	#149 / 19.04	9    (*9) SUCHANKOVA I. (SVK)
4	(*7) AJARAY M. (BEL)	
	PTS	1
5	(*14) NILSSON A. (SWE)	
	#152 / 19.04	2    (*14) NILSSON A. (SWE)
6	(*9) SUCHANKOVA I. (SVK)	
	PTS	0
7	(*29) FERNANDEZ OSORIO C. (ESP)	
	#153 / 19.04	1    (*7) AJARAY M. (BEL)
8	(*7) AJARAY M. (BEL)	
	PTS	2
9	(*29) FERNANDEZ OSORIO C. (ESP)	
	#156 / 19.04	2    (*29) FERNANDEZ OSORIO C. (ESP)
10	(*9) SUCHANKOVA I. (SVK)	
	PTS	2
11	(*14) NILSSON A. (SWE)	
	#157 / 19.04	3    (*14) NILSSON A. (SWE)
12	(*7) AJARAY M. (BEL)	
	PTS	0



1. NILSSON ANNA-JOHANNA (SWE)
2. SUCHANKOVA INGRIDA (SVK)
3. AJARAY MARYAM (BEL)
4. FERNANDEZ OSORIO CARLOTA (ESP)

1. KHAMIS REEM (GER)
2. NILSSON ANNA-JOHANNA (SWE)
3. SHIMADA SARARA (JPN)
3. GRANDE ALEXANDRA (PER)
5. KUJURO YUKI (JPN)
5. RADJENOVIC NINA (SUI)
7. SHOLOHOVA OLEKSANDRA (UKR)
7. SIVERT LAURA (FRA)

\*Seeded

Referees:			

# Female Kumite -61 Kg - Round Robin (each against each)

Karate1 Premier League - Cairo 2024, Cairo, EGY

Tatami

Pool  
6/8



1. GRANDE ALEXANDRA (PER)
2. ANGELUCCI GIULIA (ITA)
3. TOPALOVIC LEJLA (AUT)
4. KANAY ASSEL (KAZ)



1. KHAMIS REEM (GER)
2. NILSSON ANNA-JOHANNA (SWE)
3. SHIMADA SARARA (JPN)
3. GRANDE ALEXANDRA (PER)
5. KUJURO YUKI (JPN)
5. RADJENOVIC NINA (SUI)
7. SHOLOHOVA OLEKSANDRA (UKR)
7. SIVERT LAURA (FRA)

\*Seeded

Referees:			

















# Female Kumite -61 Kg - Round Robin (each against each)

Karate1 Premier League - Cairo 2024, Cairo, EGY

Tatami

Pool

7/8

1	 (*13) AVAZERI L. (FRA)	2	 (*16) GOZUTOK G. (TUR)
	#217 / 19.04		SEN
2	 (*16) GOZUTOK G. (TUR)	2	
3	 (*11) CHRYSOPOULOU K. (GRE)	4	 (*25) RADJENOVIC N. (SUI)
	#218 / 19.04		SEN
4	 (*25) RADJENOVIC N. (SUI)	4	
	PTS		
5	 (*16) GOZUTOK G. (TUR)	3	 (*16) GOZUTOK G. (TUR)
	#220 / 19.04		
6	 (*11) CHRYSOPOULOU K. (GRE)	2	
	PTS		
7	 (*13) AVAZERI L. (FRA)	2	 (*13) AVAZERI L. (FRA)
	#221 / 19.04		
8	 (*25) RADJENOVIC N. (SUI)	0	
9	 (*13) AVAZERI L. (FRA)	2	 (*11) CHRYSOPOULOU K. (GRE)
	#223 / 19.04		PTS
10	 (*11) CHRYSOPOULOU K. (GRE)	4	
11	 (*16) GOZUTOK G. (TUR)	1	 (*25) RADJENOVIC N. (SUI)
	#224 / 19.04		PTS
12	 (*25) RADJENOVIC N. (SUI)	4	



1. RADJENOVIC NINA (SUI)
2. GOZUTOK GULBAHAR (TUR)
3. CHRYSOPOULOU KONSTANTINA (GRE)
4. AVAZERI LEA (FRA)

1. KHAMIS REEM (GER)
2. NILSSON ANNA-JOHANNA (SWE)
3. SHIMADA SARARA (JPN)
3. GRANDE ALEXANDRA (PER)
5. KUJURO YUKI (JPN)
5. RADJENOVIC NINA (SUI)
7. SHOLOHOVA OLEKSANDRA (UKR)
7. SIVERT LAURA (FRA)

\*Seeded

Referees:			



# Female Kumite -61 Kg - Round Robin (each against each)

Karate1 Premier League - Cairo 2024, Cairo, EGY

Tatami

Pool  
8/8

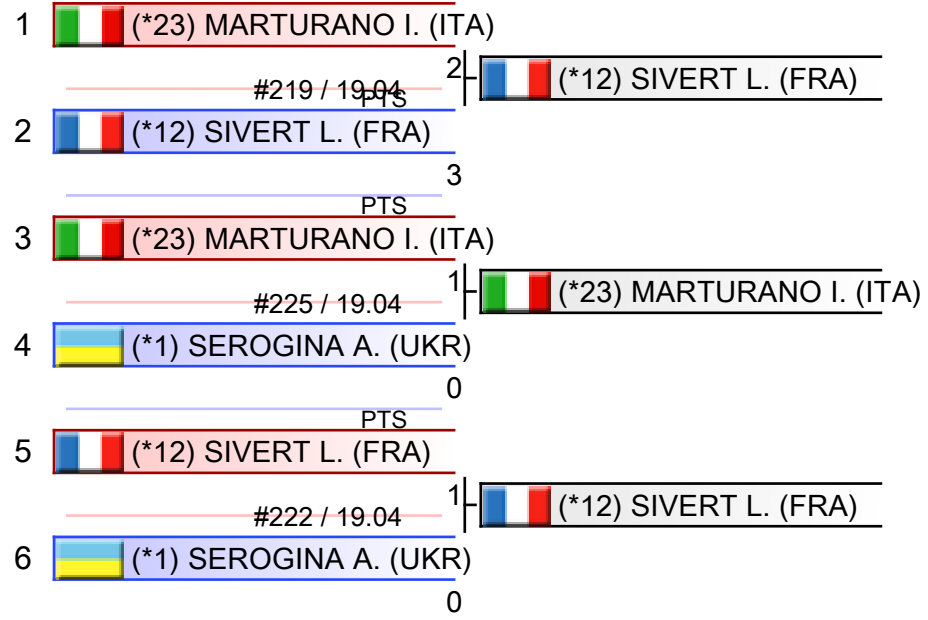

1. SIVERT LAURA (FRA)
2. MARTURANO IRENE (ITA)
3. SEROGINA ANITA (UKR)



1. KHAMIS REEM (GER)
2. NILSSON ANNA-JOHANNA (SWE)
3. SHIMADA SARARA (JPN)
3. GRANDE ALEXANDRA (PER)
5. KUJURO YUKI (JPN)
5. RADJENOVIC NINA (SUI)
7. SHOLOHOVA OLEKSANDRA (UKR)
7. SIVERT LAURA (FRA)

\*Seeded

Referees:			

# Pool winner-Female Kumite -61 Kg

Karate1 Premier League - Cairo 2024, Cairo, EGY

Tatami

Pool  
1/1

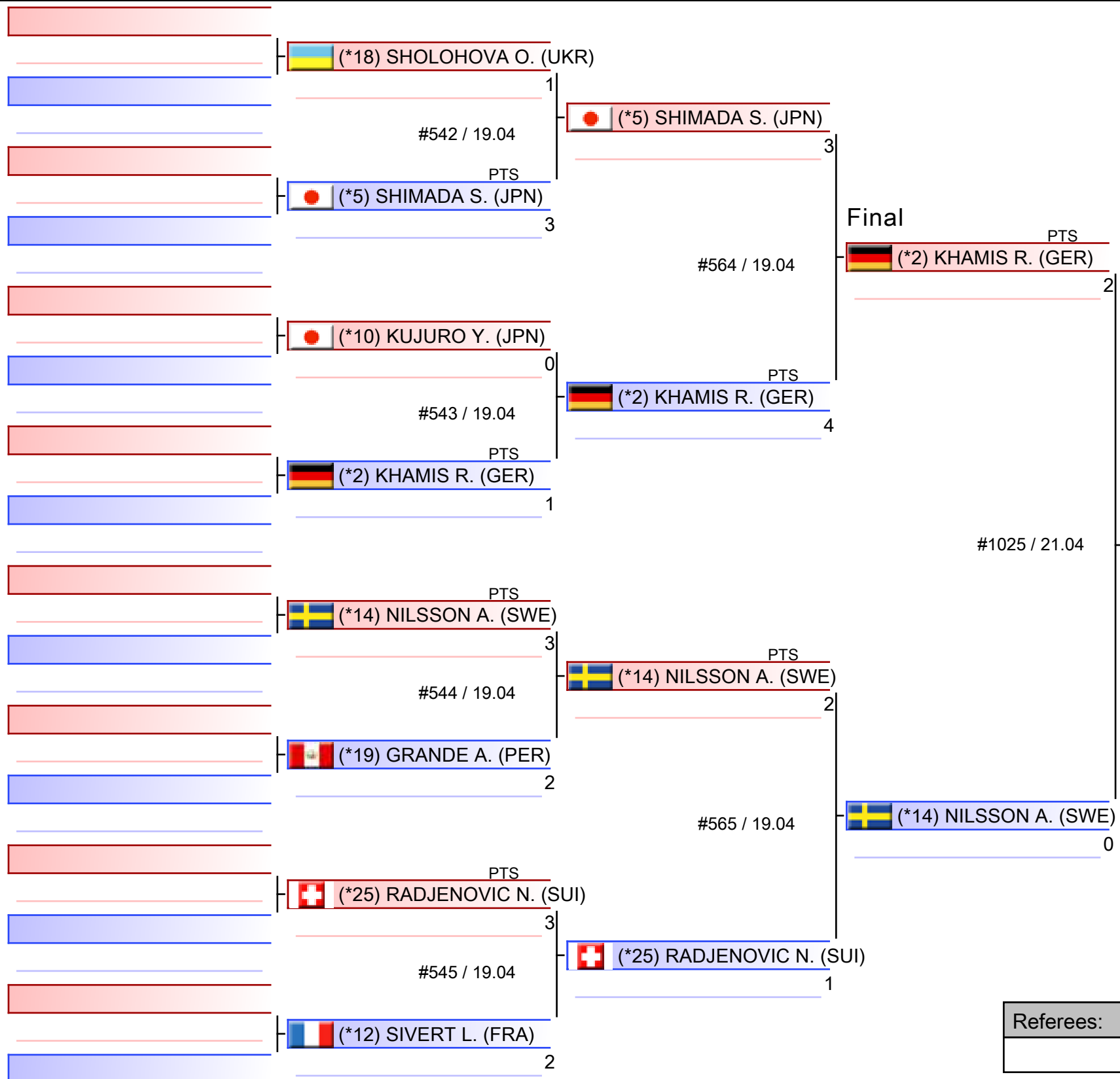

1. KHAMIS REEM (GER)
2. NILSSON ANNA-JOHANNA (SWE)
3. SHIMADA SARARA (JPN)
3. GRANDE ALEXANDRA (PER)
5. KUJURO YUKI (JPN)
5. RADJENOVIC NINA (SUI)
7. SHOLOHOVA OLEKSANDRA (UKR)
7. SIVERT LAURA (FRA)

\*Seeded

Referees:			

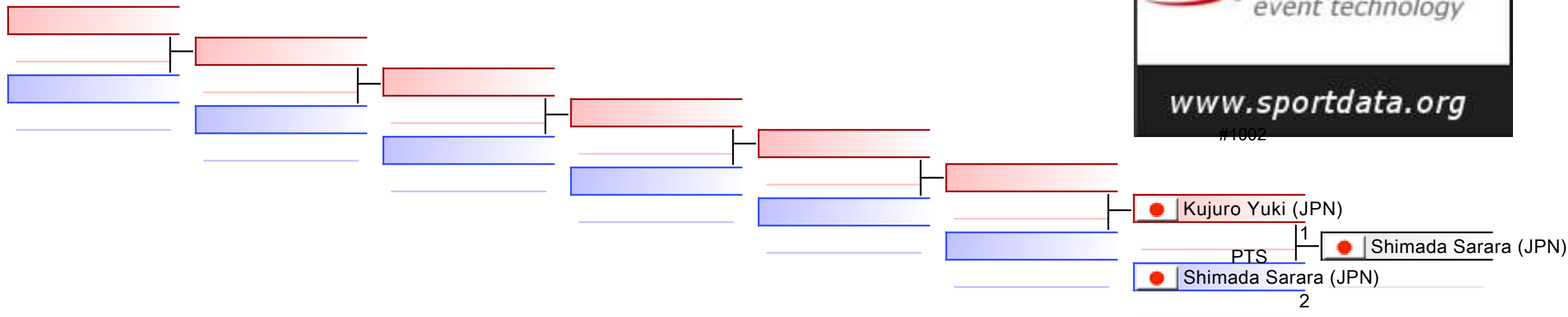

REPECHAGE: (1,2,3,4,5,6,7,8)

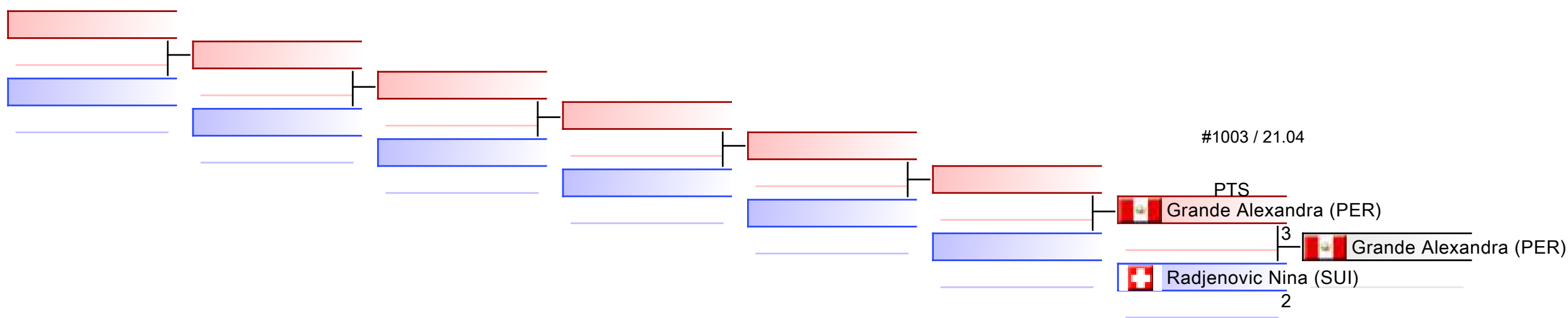







Referees:							
-----------	--	--	--	--	--	--	--



Karate1 Premier League - Cairo 2024 - 2024-04-19



## Official Results

Female Kumite -61 Kg			
1	KHAMIS REEM		GER - GERMANY
2	NILSSON ANNA-JOHANNA		SWE - SWEDEN
3	SHIMADA SARARA		JPN - JAPAN
3	GRANDE ALEXANDRA		PER - PERU
5	KUJURO YUKI		JPN - JAPAN
5	RADJENOVIC NINA		SUI - SWITZERLAND
7	SHOLOHOVA OLEKSANDRA		UKR - UKRAINE
7	SIVERT LAURA		FRA - FRANCE

# FEMALE KUMITE -68 KG



Karate1 Premier League - Cairo 2024  
**ENTRIES BY WEIGHT CATEGORY**



**Female Kumite -68 Kg**

As of 21 APR 2024

NOC Code	Gender	Name	Seeding
ARM	F	MAKYAN ANITA	25
AUT	F	VUKOVIC MARINA	27
CHI	F	VELOZO ANASTASIIA	30
CRO	F	BECIROVIC SADEA	11
CRO	F	VUKOJA LEA	15
EGY	F	ABDELAZIZ FERYAL	18
EGY	F	ELMEDANY OLA	16
EGY	F	HENDY HADIR	31
EGY	F	ZEINELABDIN MAYAR	24
ESP	F	NIETO MEJIAS MARIA ISABEL	8
FRA	F	AGIER ALIZEE	4
FRA	F	SOMBE Thalya	2
GER	F	SCHROETER MADELEINE	7
GRE	F	PEPPA KONSTANTINA-EVANGELIA	23
HKG	F	WONG CHEUK LEE	22
INA	F	ZEFANYA CEYCO GEORGIA	3
ITA	F	Bodei Pamela	17
ITA	F	DESIDERIO ANNA PIA	19
ITA	F	SEMERARO SILVIA	5
JOR	F	ALDROUS JOUD	26
JPN	F	KAMA TSUBASA	6
JPN	F	YATOJI AYUMI	20
KAZ	F	Zhaxybayeva Venera	29
NED	F	SNEL LYNN	28
PUR	F	FONSECA ROMERO JANESSA MICHELLE	21
SUI	F	QUIRICI ELENA	1
SVK	F	KRIVDOVA SARA	9
TUN	F	EZZAR wissal	12
TUR	F	AKSOY SUDENUR	10
TUR	F	ELTEMUR EDA	13
UKR	F	SIELIEMIENIEVA ELINA	14

# Female Kumite -68 Kg - Round Robin (each against each)

Karate1 Premier League - Cairo 2024, Cairo, EGY

Tatami

Pool  
1/8

1	(*7) SCHROETER M. (GER)	3	(*7) SCHROETER M. (GER)
	#274 / 20.04		
2	(*30) VELOZO A. (CHI)	3	
3	(*15) VUKOJA L. (CRO)	6	(*13) ELTEMUR E. (TUR)
	#275 / 20.04		
4	(*13) ELTEMUR E. (TUR)	6	
	PTS		
5	(*30) VELOZO A. (CHI)	4	(*30) VELOZO A. (CHI)
	#278 / 20.04		
6	(*15) VUKOJA L. (CRO)	2	
7	(*7) SCHROETER M. (GER)	2	(*13) ELTEMUR E. (TUR)
	#279 / 20.04		
8	(*13) ELTEMUR E. (TUR)	9	
9	(*7) SCHROETER M. (GER)	3	(*15) VUKOJA L. (CRO)
	#282 / 20.04		
10	(*15) VUKOJA L. (CRO)	5	
11	(*30) VELOZO A. (CHI)	0	(*13) ELTEMUR E. (TUR)
	#283 / 20.04		
12	(*13) ELTEMUR E. (TUR)	3	

1. ELTEMUR EDA (TUR)
2. VUKOJA LEA (CRO)
3. SCHROETER MADELEINE (GER)
4. VELOZO ANASTASIIA (CHI)



1. KAMA TSUBASA (JPN)
2. ELTEMUR EDA (TUR)
3. AKSOY SUDENUR (TUR)
3. NIETO MEJIAS MARIA ISABEL (ESP)
5. ZEFANYA CEYCO GEORGIA (INA)
5. SEMERARO SILVIA (ITA)
7. ABDELAZIZ FERYAL (EGY)
7. BECIROVIC SADEA (CRO)

\*Seeded

Referees:			

# Female Kumite -68 Kg - Round Robin (each against each)

Karate1 Premier League - Cairo 2024, Cairo, EGY

Tatami

Pool  
2/8

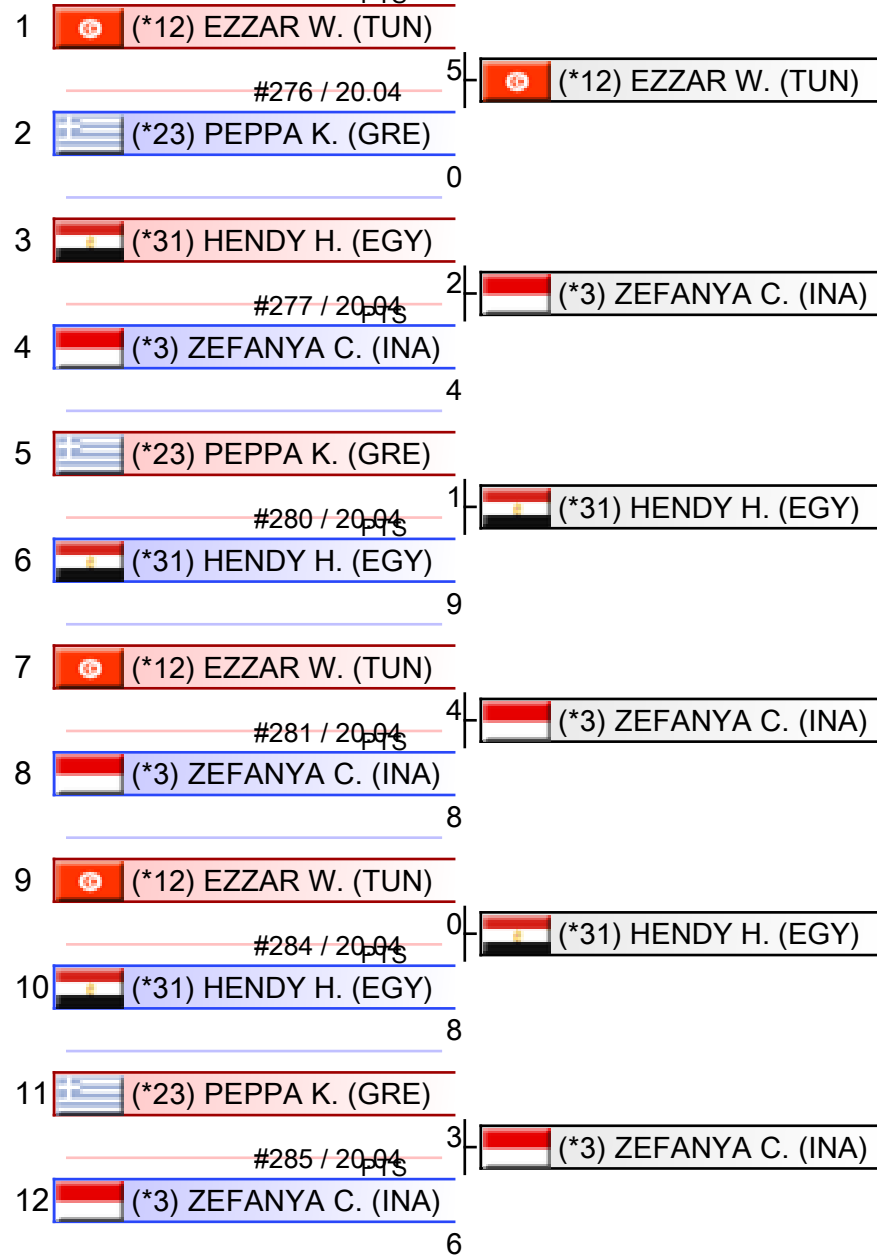

1. ZEFANYA CEYCO GEORGIA (INA)
2. HENDY HADIR (EGY)
3. EZZAR WISSAL (TUN)
4. PEPPA KONSTANTINA-EVANGELIA (GRE)

1. KAMA TSUBASA (JPN)
2. ELTEMUR EDA (TUR)
3. AKSOY SUDENUR (TUR)
3. NIETO MEJIAS MARIA ISABEL (ESP)
5. ZEFANYA CEYCO GEORGIA (INA)
5. SEMERARO SILVIA (ITA)
7. ABDELAZIZ FERYAL (EGY)
7. BECIROVIC SADEA (CRO)

\*Seeded

Referees:			



# Female Kumite -68 Kg - Round Robin (each against each)

Karate1 Premier League - Cairo 2024, Cairo, EGY

Tatami

Pool  
3/8

1	(*28) SNEL L. (NED)	0	(*18) ABDELAZIZ F. (EGY)
	#343 / 20.04		
2	(*18) ABDELAZIZ F. (EGY)	7	
3	(*26) ALDROUS J. (JOR)	1	(*20) YATOJI A. (JPN)
	#344 / 20.04		
4	(*20) YATOJI A. (JPN)	2	
	PTS		
5	(*18) ABDELAZIZ F. (EGY)	9	(*18) ABDELAZIZ F. (EGY)
	#347 / 20.04		
6	(*26) ALDROUS J. (JOR)	0	
7	(*28) SNEL L. (NED)	0	(*20) YATOJI A. (JPN)
	#348 / 20.04		
8	(*20) YATOJI A. (JPN)	1	
	PTS		
9	(*28) SNEL L. (NED)	3	(*28) SNEL L. (NED)
	#351 / 20.04		
10	(*26) ALDROUS J. (JOR)	1	
	PTS		
11	(*18) ABDELAZIZ F. (EGY)	8	(*18) ABDELAZIZ F. (EGY)
	#352 / 20.04		
12	(*20) YATOJI A. (JPN)	0	

1. ABDELAZIZ FERYAL (EGY)
2. YATOJI AYUMI (JPN)
3. SNEL LYNN (NED)
4. ALDROUS JOUD (JOR)



1. KAMA TSUBASA (JPN)
2. ELTEMUR EDA (TUR)
3. AKSOY SUDENUR (TUR)
3. NIETO MEJIAS MARIA ISABEL (ESP)
5. ZEFANYA CEYCO GEORGIA (INA)
5. SEMERARO SILVIA (ITA)
7. ABDELAZIZ FERYAL (EGY)
7. BECIROVIC SADEA (CRO)

\*Seeded

Referees:			

# Female Kumite -68 Kg - Round Robin (each against each)

Karate1 Premier League - Cairo 2024, Cairo, EGY

Tatami

Pool  
4/8

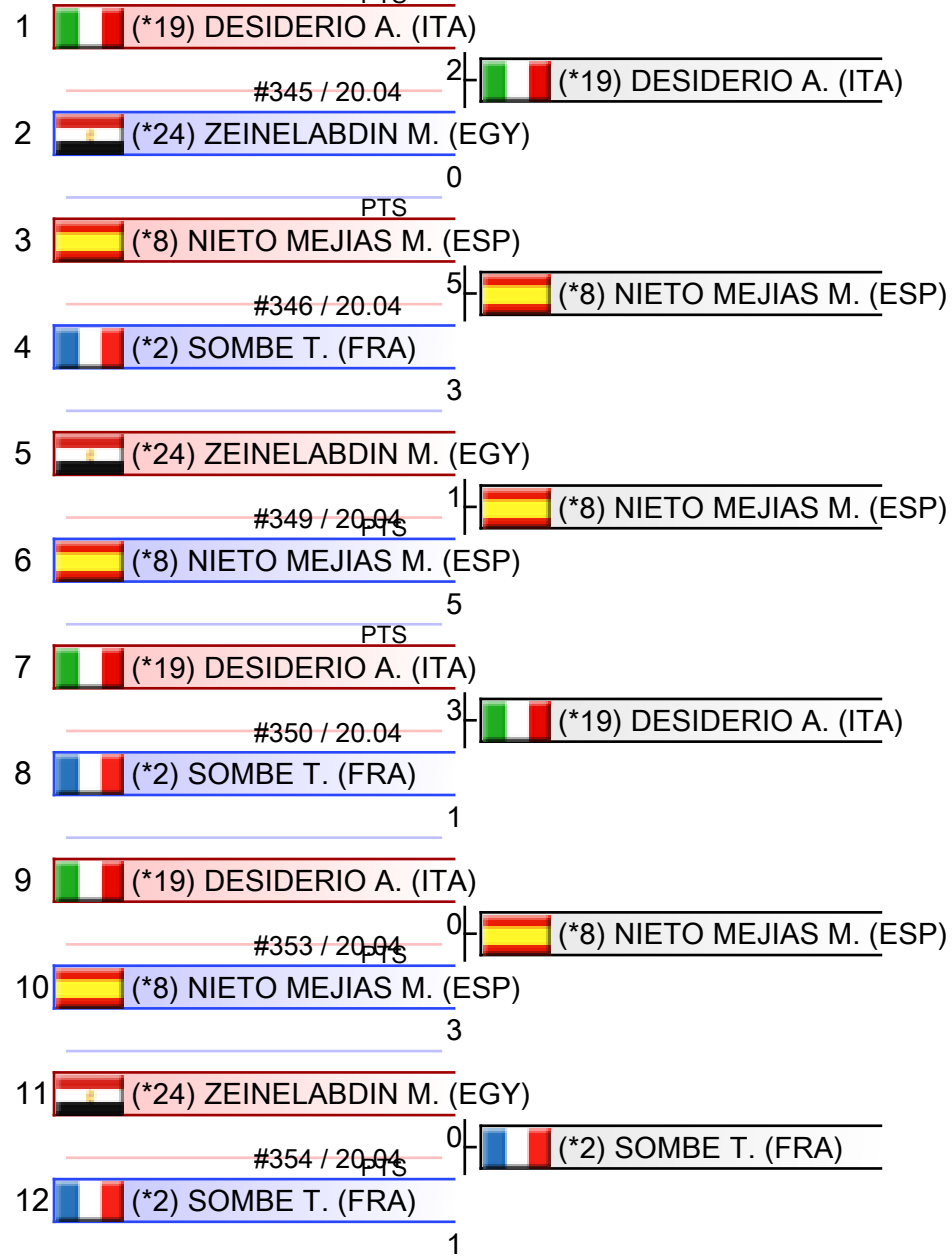

1. NIETO MEJIAS MARIA ISABEL (ESP)
2. DESIDERIO ANNA PIA (ITA)
3. SOMBE THALYA (FRA)
4. ZEINELABDIN MAYAR (EGY)



1. KAMA TSUBASA (JPN)
2. ELTEMUR EDA (TUR)
3. AKSOY SUDENUR (TUR)
3. NIETO MEJIAS MARIA ISABEL (ESP)
5. ZEFANYA CEYCO GEORGIA (INA)
5. SEMERARO SILVIA (ITA)
7. ABDELAZIZ FERYAL (EGY)
7. BECIROVIC SADEA (CRO)

\*Seeded

Referees:			

# Female Kumite -68 Kg - Round Robin (each against each)

Karate1 Premier League - Cairo 2024, Cairo, EGY

Tatami

Pool  
5/8

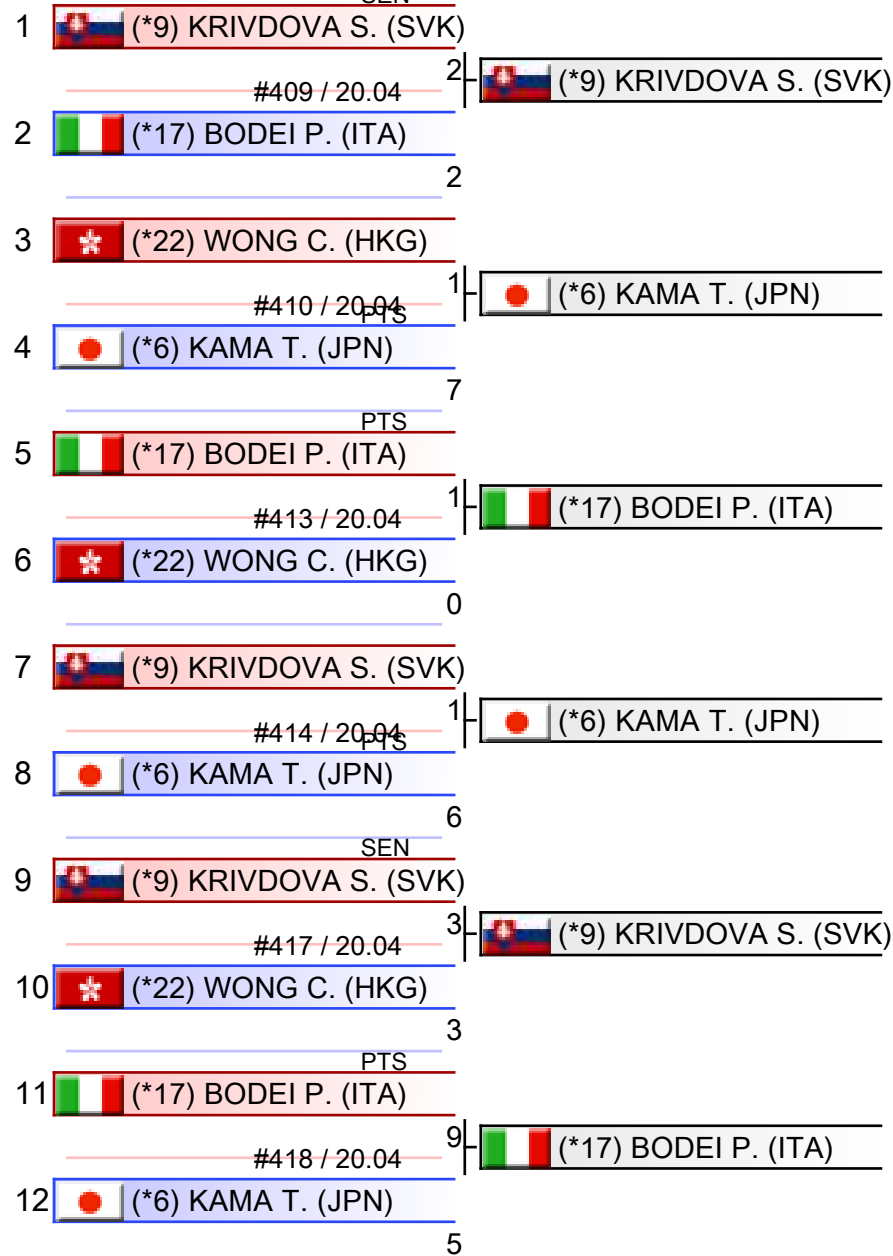

1. KAMA TSUBASA (JPN)
2. KRIVDOVA SARA (SVK)
3. BODEI PAMELA (ITA)
4. WONG CHEUK LEE (HKG)



1. KAMA TSUBASA (JPN)
2. ELTEMUR EDA (TUR)
3. AKSOY SUDENUR (TUR)
3. NIETO MEJIAS MARIA ISABEL (ESP)
5. ZEFANYA CEYCO GEORGIA (INA)
5. SEMERARO SILVIA (ITA)
7. ABDELAZIZ FERYAL (EGY)
7. BECIROVIC SADEA (CRO)

\*Seeded

Referees:			

# Female Kumite -68 Kg - Round Robin (each against each)

Karate1 Premier League - Cairo 2024, Cairo, EGY

Tatami

Pool  
6/8

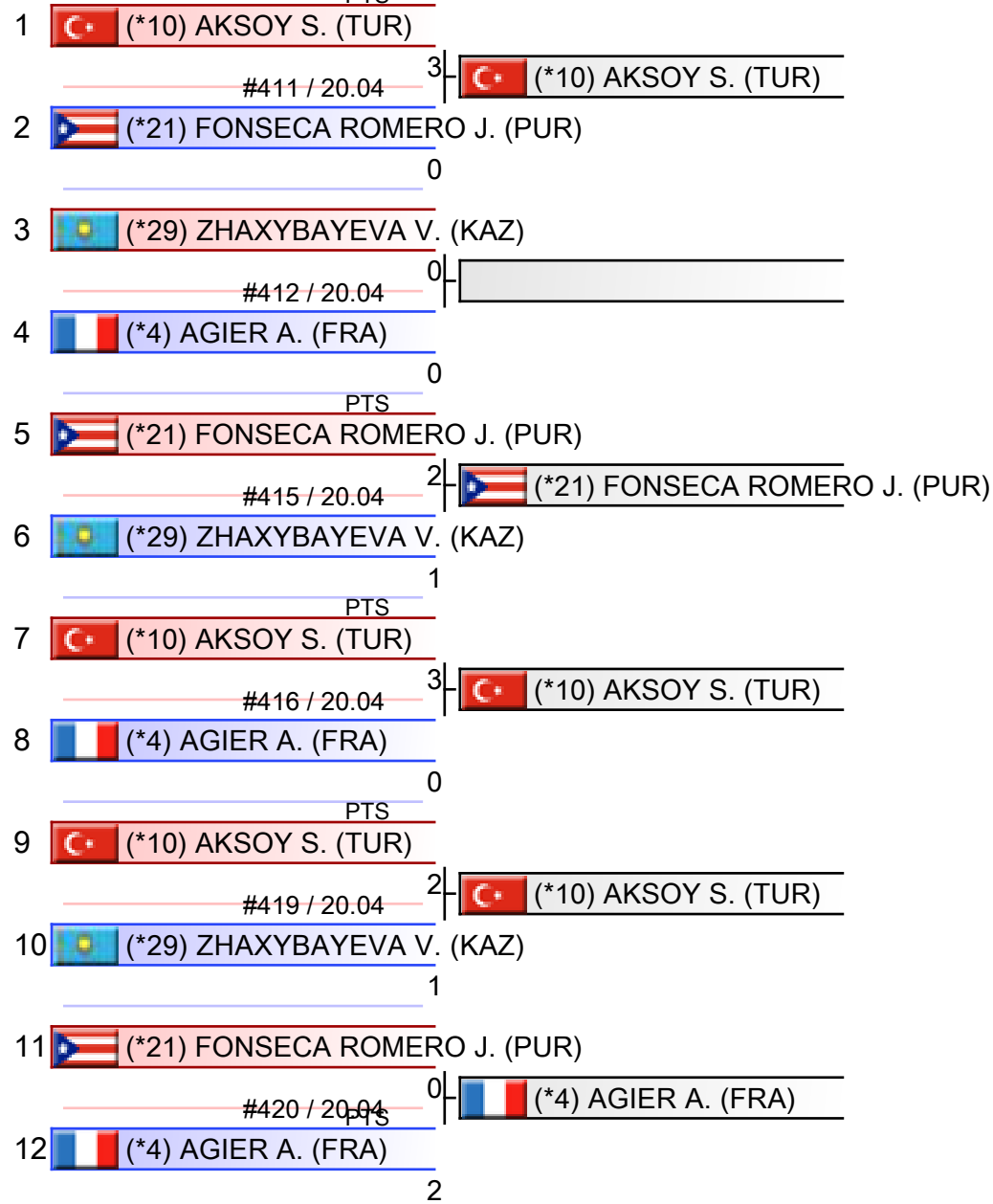

1. AKSOY SUDENUR (TUR)
2. AGIER ALIZEE (FRA)
3. FONSECA ROMERO JANESSA MICHELLE (PUR)
4. ZHAXYBAYEVA VENERA (KAZ)



1. KAMA TSUBASA (JPN)
2. ELTEMUR EDA (TUR)
3. AKSOY SUDENUR (TUR)
3. NIETO MEJIAS MARIA ISABEL (ESP)
5. ZEFANYA CEYCO GEORGIA (INA)
5. SEMERARO SILVIA (ITA)
7. ABDELAZIZ FERYAL (EGY)
7. BECIROVIC SADEA (CRO)

\*Seeded

Referees:			

# Female Kumite -68 Kg - Round Robin (each against each)

Karate1 Premier League - Cairo 2024, Cairo, EGY

Tatami

Pool  
7/8



1. BECIROVIC SADEA (CRO)
2. ELMEDANY OLA (EGY)
3. VUKOVIC MARINA (AUT)
4. MAKYAN ANITA (ARM)



1. KAMA TSUBASA (JPN)
2. ELTEMUR EDA (TUR)
3. AKSOY SUDENUR (TUR)
3. NIETO MEJIAS MARIA ISABEL (ESP)
5. ZEFANYA CEYCO GEORGIA (INA)
5. SEMERARO SILVIA (ITA)
7. ABDELAZIZ FERYAL (EGY)
7. BECIROVIC SADEA (CRO)

\*Seeded

Referees:			

# Female Kumite -68 Kg - Round Robin (each against each)

Karate1 Premier League - Cairo 2024, Cairo, EGY

Tatami

Pool  
8/8

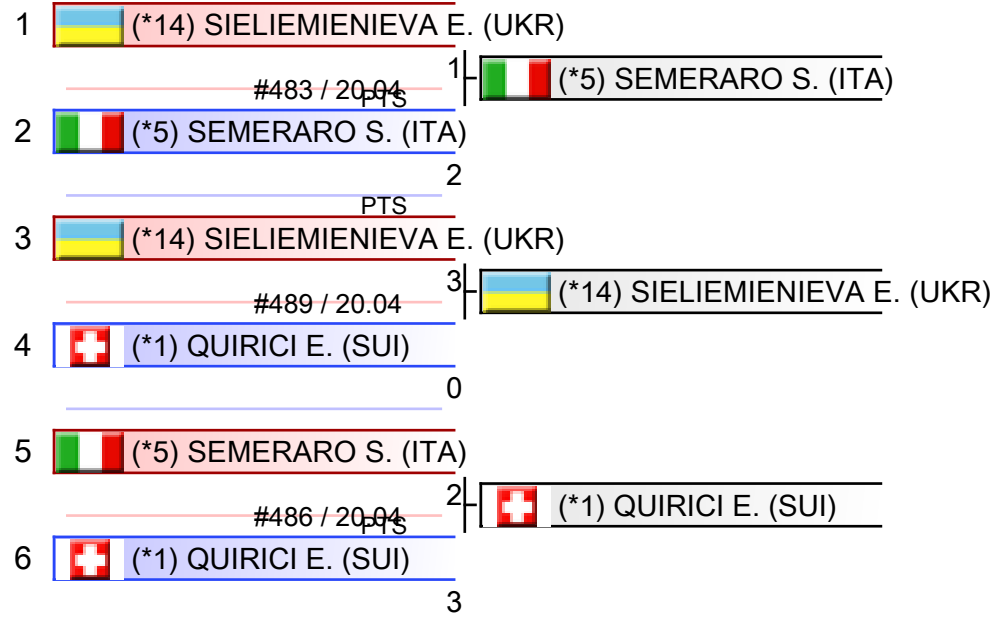

1. SEMERARO SILVIA (ITA)
2. SIELIEMIENIEVA ELINA (UKR)
3. QUIRICI ELENA (SUI)



1. KAMA TSUBASA (JPN)
2. ELTEMUR EDA (TUR)
3. AKSOY SUDENUR (TUR)
3. NIETO MEJIAS MARIA ISABEL (ESP)
5. ZEFANYA CEYCO GEORGIA (INA)
5. SEMERARO SILVIA (ITA)
7. ABDELAZIZ FERYAL (EGY)
7. BECIROVIC SADEA (CRO)

\*Seeded

Referees:			

# Pool winner-Female Kumite -68 Kg

Karate1 Premier League - Cairo 2024, Cairo, EGY

Tatami

Pool  
1/1

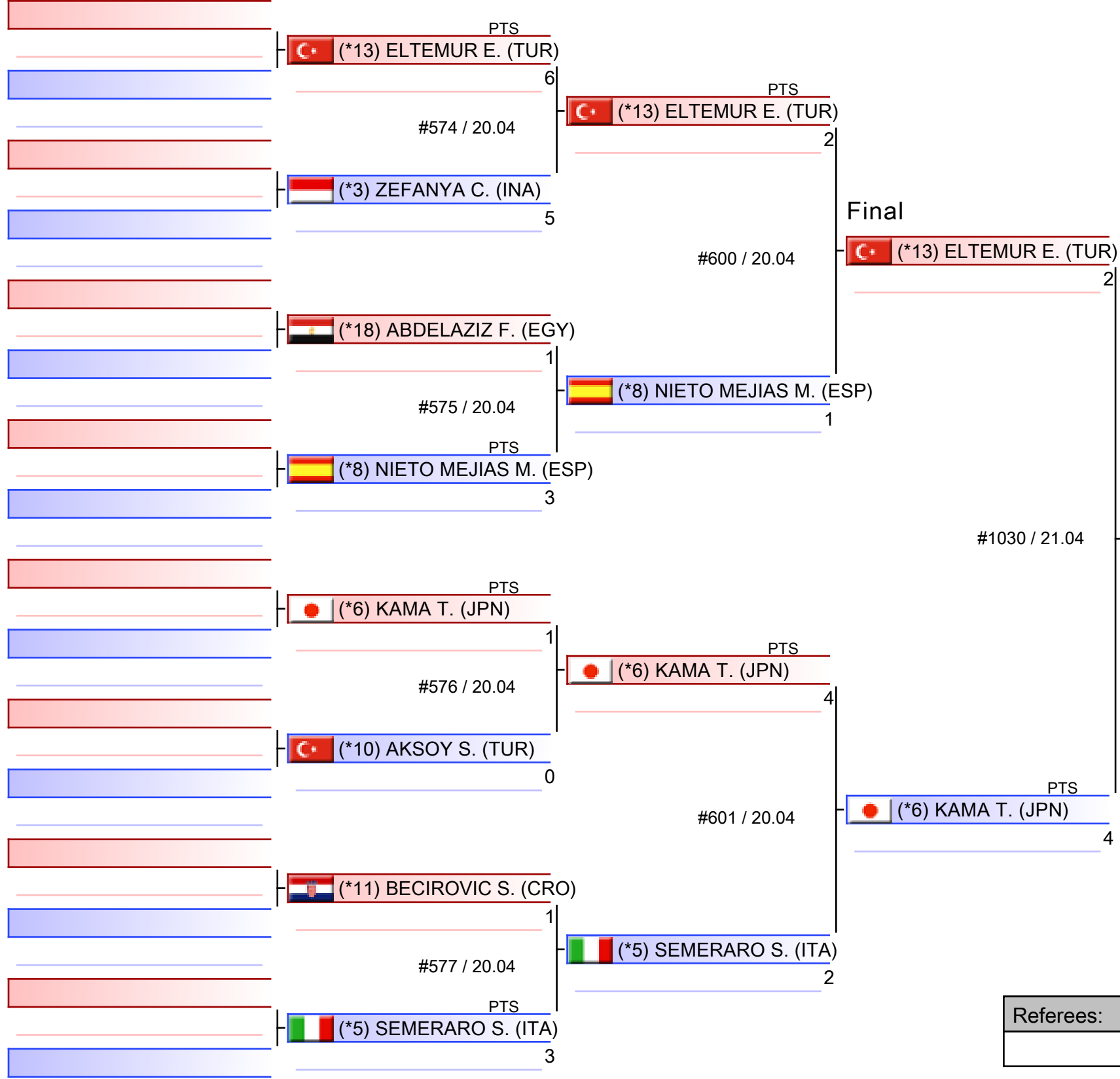

1. KAMA TSUBASA (JPN)
2. ELTEMUR EDA (TUR)
3. AKSOY SUDENUR (TUR)
3. NIETO MEJIAS MARIA ISABEL (ESP)
5. ZEFANYA CEYCO GEORGIA (INA)
5. SEMERARO SILVIA (ITA)
7. ABDELAZIZ FERYAL (EGY)
7. BECIROVIC SADEA (CRO)

\*Seeded

Referees:			

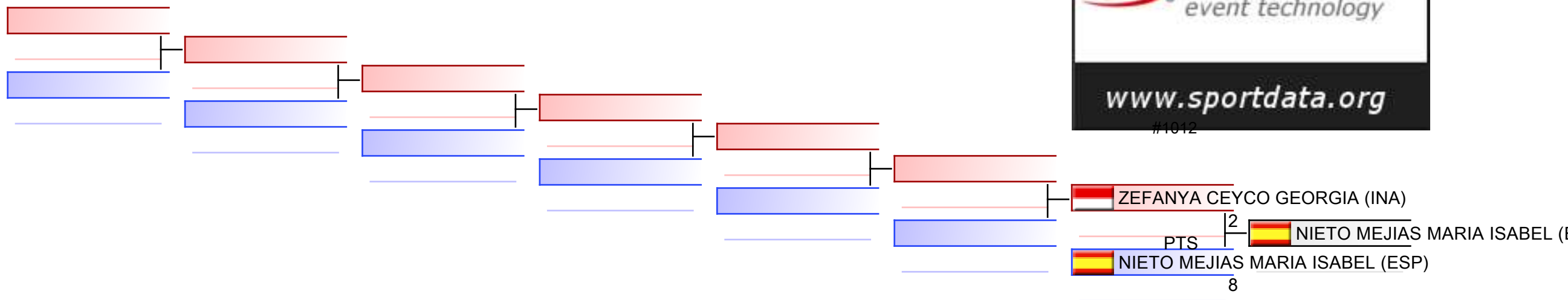

REPECHAGE: (1,2,3,4,5,6,7,8)

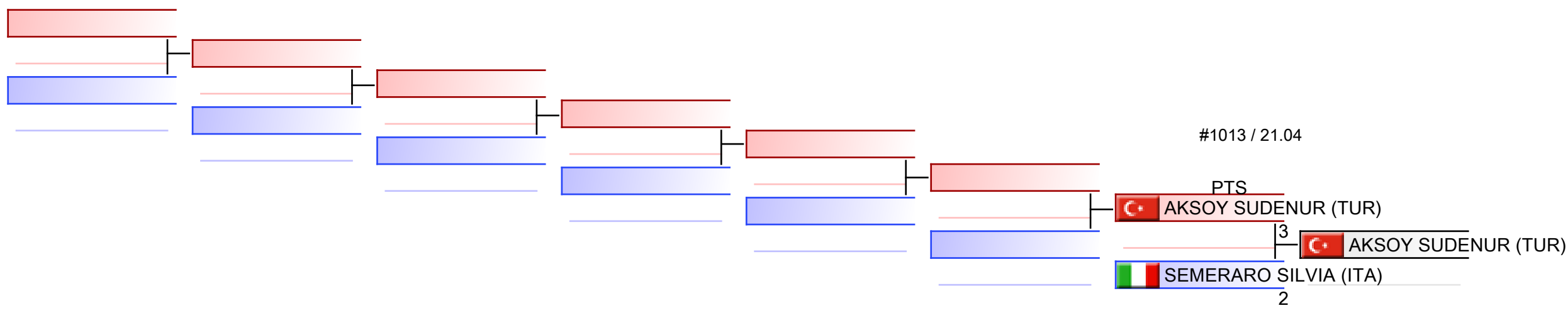

Referees:							
-----------	--	--	--	--	--	--	--





Karate1 Premier League - Cairo 2024 - 2024-04-19



## Official Results

Female Kumite -68 Kg			
1	KAMA TSUBASA		JPN - JAPAN
2	ELTEMUR EDA		TUR - TURKIYE
3	AKSOY SUDENUR		TUR - TURKIYE
3	NIETO MEJIAS MARIA ISABEL		ESP - SPAIN
5	ZEFANYA CEYCO GEORGIA		INA - INDONESIA
5	SEMERARO SILVIA		ITA - ITALY
7	ABDELAZIZ FERYAL		EGY - EGYPT
7	BECIROVIC SADEA		CRO - CROATIA

# FEMALE KUMITE 68+ KG



# Karate1 Premier League - Cairo 2024

## ENTRIES BY WEIGHT CATEGORY



### Female Kumite 68+ Kg

As of 21 APR 2024

NOC Code	Gender	Name	Seeding
ALG	F	OUDIRA CHAIMA	21
AUT	F	ZILLER LORA	32
BEL	F	MULOLO OPHELIE	18
BIH	F	KRESIC STEFANI	6
CHI	F	GONZALEZ LAVIN JAVIERA	28
CRO	F	LESJAK LUCIJA	7
CYP	F	GIAMOUKI THEODOSIA	14
EGY	F	HELMY HABIBA	22
EGY	F	OKILA MENNA SHAABAN	4
ENG	F	Walters Rochelle	16
ESP	F	TORRES GARCIA MARIA	2
FIN	F	Keinanen Titta	29
FRA	F	GARCIA NANCY	27
FRA	F	PEA Clemence	26
GER	F	KNEER JOHANNA	10
GER	F	LUECKE AMELIE	9
GER	F	Stamer Selina	25
ITA	F	FERRACUTI CLIO	3
ITA	F	STASI LINDA	31
JPN	F	SAWAE YUZUKI	5
KAZ	F	BERULTSEVA SOFYA	1
MAR	F	EDDARHRI MAROUA	12
NED	F	Creemers Ingrid	17
POL	F	DANISZEWSKA JULIA	11
SCO	F	JUNNER NIAMH	19
SUI	F	Bonjour Pauline	23
SUI	F	KAUFMANN FABIENNE	8
TUN	F	JEMI CHEHINEZ	13
TUR	F	GABALLA ZEYNA	20
TUR	F	HOCAOGLU AKYOL MELTEM	24
TUR	F	UYGUR FATMA	30
UKR	F	RUSU YULIA	15

# Female Kumite 68+ Kg - Round Robin (each against each)

Karate1 Premier League - Cairo 2024, Cairo, EGY

Tatami

Pool  
1/8

1	(*21) OUDIRA C. (ALG)	2	(*17) CREEMERS I. (NED)
	#319 / 20.04		PTS
2	(*17) CREEMERS I. (NED)		8
3	(*18) MULOLO O. (BEL)	1	(*14) GIAMOUKI T. (CYP)
	#320 / 20.04		PTS
4	(*14) GIAMOUKI T. (CYP)		5
5	(*17) CREEMERS I. (NED)	3	(*18) MULOLO O. (BEL)
	#323 / 20.04		PTS
6	(*18) MULOLO O. (BEL)		6
	PTS		
7	(*21) OUDIRA C. (ALG)	4	(*21) OUDIRA C. (ALG)
	#324 / 20.04		PTS
8	(*14) GIAMOUKI T. (CYP)		3
9	(*21) OUDIRA C. (ALG)	3	(*18) MULOLO O. (BEL)
	#327 / 20.04		PTS
10	(*18) MULOLO O. (BEL)		4
11	(*17) CREEMERS I. (NED)	0	(*14) GIAMOUKI T. (CYP)
	#328 / 20.04		PTS
12	(*14) GIAMOUKI T. (CYP)		2

1. GIAMOUKI THEODOSIA (CYP)
2. MULOLO OPHELIE (BEL)
3. CREEMERS INGRID (NED)
4. OUDIRA CHAIMA (ALG)



1. KNEER JOHANNA (GER)
2. TORRES GARCIA MARIA (ESP)
3. BERULTSEVA SOFYA (KAZ)
3. KEINANEN TITTA (FIN)
5. FERRACUTI CLIO (ITA)
5. JUNNER NIAMH (SCO)
7. GIAMOUKI THEODOSIA (CYP)
7. GARCIA NANCY (FRA)

\*Seeded

Referees:			

# Female Kumite 68+ Kg - Round Robin (each against each)

Karate1 Premier League - Cairo 2024, Cairo, EGY

Tatami

Pool  
2/8

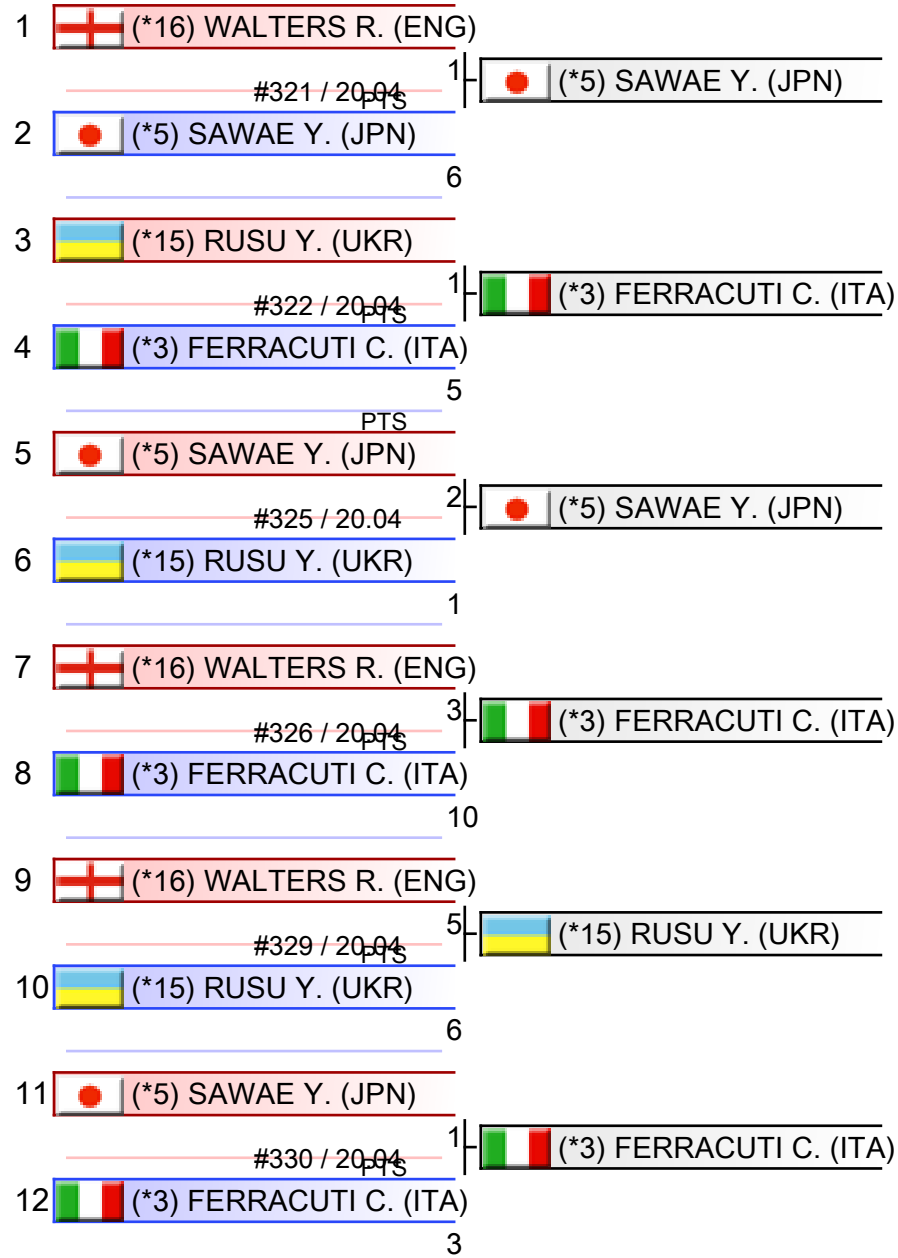

1. FERRACUTI CLIO (ITA)
2. SAWAE YUZUKI (JPN)
3. RUSU YULIA (UKR)
4. WALTERS ROCHELLE (ENG)



1. KNEER JOHANNA (GER)
2. TORRES GARCIA MARIA (ESP)
3. BERULTSEVA SOFYA (KAZ)
3. KEINANEN TITTA (FIN)
5. FERRACUTI CLIO (ITA)
5. JUNNER NIAMH (SCO)
7. GIAMOUKI THEODOSIA (CYP)
7. GARCIA NANCY (FRA)

\*Seeded

Referees:			

# Female Kumite 68+ Kg - Round Robin (each against each)

Karate1 Premier League - Cairo 2024, Cairo, EGY

Tatami

Pool  
3/8

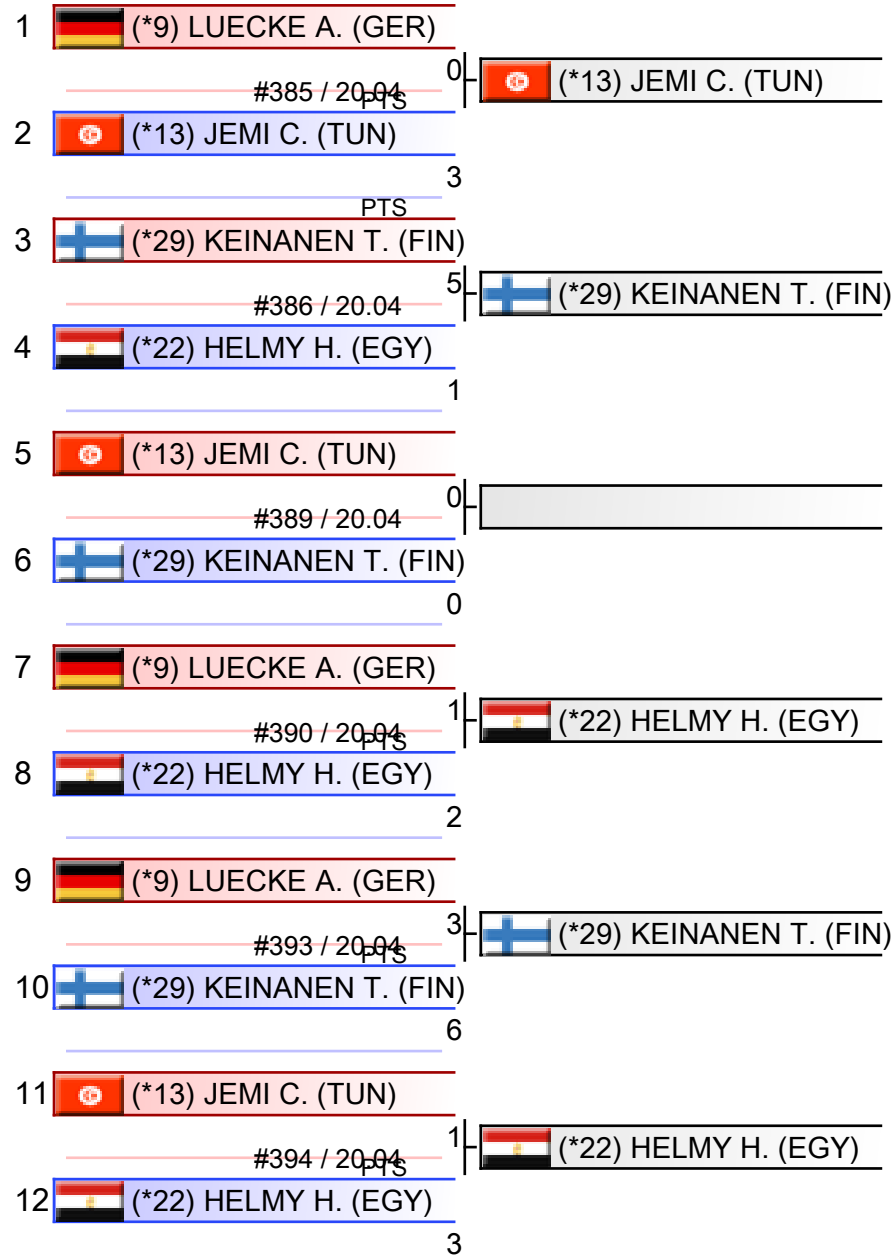

1. KEINANEN TITTA (FIN)
2. HELMY HABIBA (EGY)
3. JEMI CHEHINEZ (TUN)
4. LUECKE AMELIE (GER)



1. KNEER JOHANNA (GER)
2. TORRES GARCIA MARIA (ESP)
3. BERULTSEVA SOFYA (KAZ)
3. KEINANEN TITTA (FIN)
5. FERRACUTI CLIO (ITA)
5. JUNNER NIAMH (SCO)
7. GIAMOUKI THEODOSIA (CYP)
7. GARCIA NANCY (FRA)

\*Seeded

Referees:			

# Female Kumite 68+ Kg - Round Robin (each against each)

Karate1 Premier League - Cairo 2024, Cairo, EGY

Tatami

Pool  
4/8



1. TORRES GARCIA MARIA (ESP)
2. GABALLA ZEYNA (TUR)
3. STASI LINDA (ITA)
4. GONZALEZ LAVIN JAVIERA (CHI)



1. KNEER JOHANNA (GER)
2. TORRES GARCIA MARIA (ESP)
3. BERULTSEVA SOFYA (KAZ)
3. KEINANEN TITTA (FIN)
5. FERRACUTI CLIO (ITA)
5. JUNNER NIAMH (SCO)
7. GIAMOUKI THEODOSIA (CYP)
7. GARCIA NANCY (FRA)

\*Seeded

Referees:			

# Female Kumite 68+ Kg - Round Robin (each against each)

Karate1 Premier League - Cairo 2024, Cairo, EGY

Tatami

Pool  
5/8

1	(*7) LESJAK L. (CRO)		
	#457 / 20.04	3	(*7) LESJAK L. (CRO)
2	(*32) ZILLER L. (AUT)	1	
3	(*25) STAMER S. (GER)	0	(*19) JUNNER N. (SCO)
	#458 / 20.04		
4	(*19) JUNNER N. (SCO)	1	
5	(*32) ZILLER L. (AUT)	3	(*25) STAMER S. (GER)
	#461 / 20.04		
6	(*25) STAMER S. (GER)	3	
7	(*7) LESJAK L. (CRO)	1	(*19) JUNNER N. (SCO)
	#462 / 20.04		
8	(*19) JUNNER N. (SCO)	2	
9	(*7) LESJAK L. (CRO)	1	(*25) STAMER S. (GER)
	#465 / 20.04		
10	(*25) STAMER S. (GER)	2	
11	(*32) ZILLER L. (AUT)	3	(*19) JUNNER N. (SCO)
	#466 / 20.04		
12	(*19) JUNNER N. (SCO)	6	

1. JUNNER NIAMH (SCO)
2. STAMER SELINA (GER)
3. LESJAK LUCIJA (CRO)
4. ZILLER LORA (AUT)



1. KNEER JOHANNA (GER)
2. TORRES GARCIA MARIA (ESP)
3. BERULTSEVA SOFYA (KAZ)
3. KEINANEN TITTA (FIN)
5. FERRACUTI CLIO (ITA)
5. JUNNER NIAMH (SCO)
7. GIAMOUKI THEODOSIA (CYP)
7. GARCIA NANCY (FRA)

\*Seeded

Referees:			



# Female Kumite 68+ Kg - Round Robin (each against each)

Karate1 Premier League - Cairo 2024, Cairo, EGY

Tatami

Pool  
6/8

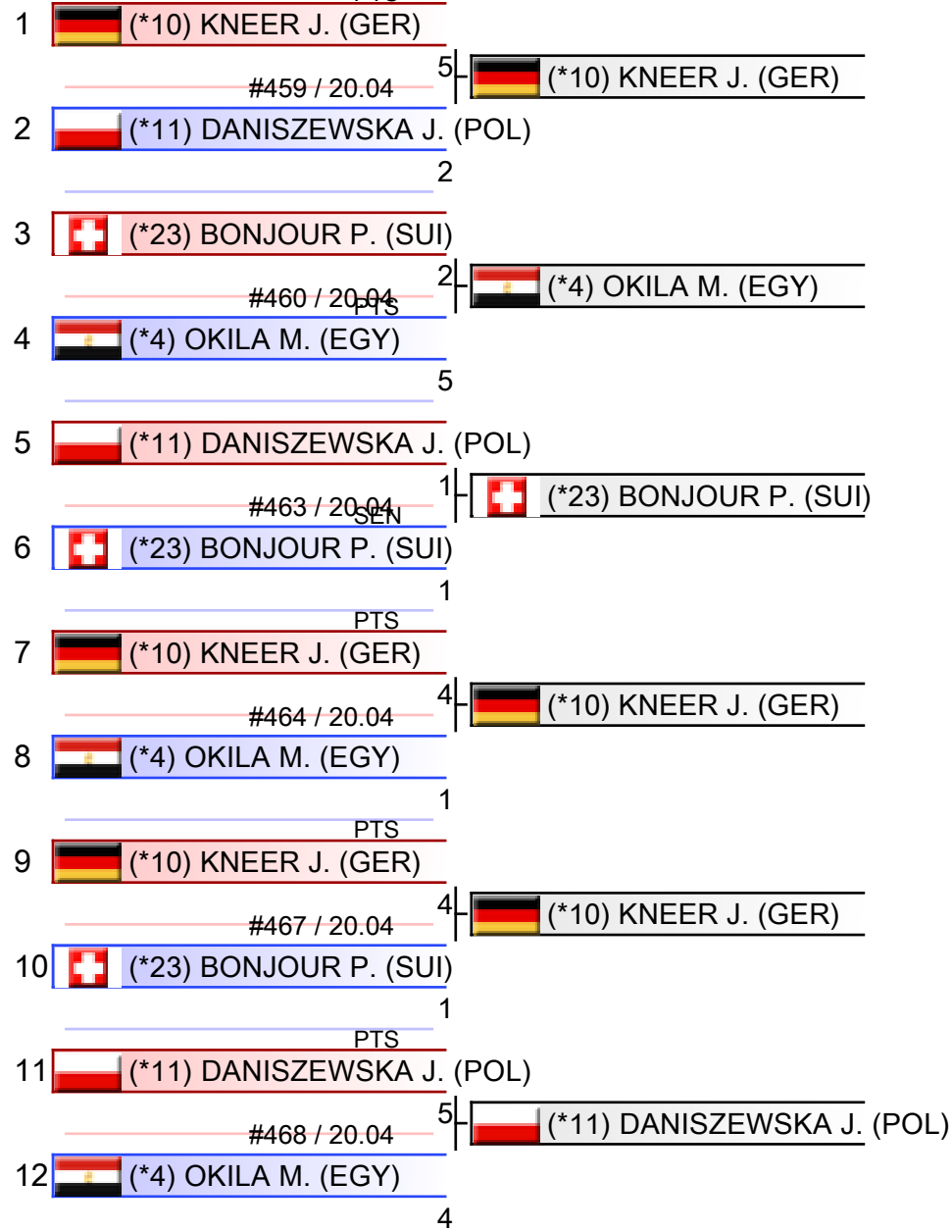

1. KNEER JOHANNA (GER)
2. OKILA MENNA SHAABAN (EGY)
3. BONJOUR PAULINE (SUI)
4. DANISZEWSKA JULIA (POL)



1. KNEER JOHANNA (GER)
2. TORRES GARCIA MARIA (ESP)
3. BERULTSEVA SOFYA (KAZ)
3. KEINANEN TITTA (FIN)
5. FERRACUTI CLIO (ITA)
5. JUNNER NIAMH (SCO)
7. GIAMOUKI THEODOSIA (CYP)
7. GARCIA NANCY (FRA)

\*Seeded

Referees:			

# Female Kumite 68+ Kg - Round Robin (each against each)

Karate1 Premier League - Cairo 2024, Cairo, EGY

Tatami

Pool  
7/8



1. GARCIA NANCY (FRA)
2. HOCAOGLU AKYOL MELTEM (TUR)
3. KRESIC STEFANI (BIH)
4. EDDARHRI MAROUA (MAR)



1. KNEER JOHANNA (GER)
2. TORRES GARCIA MARIA (ESP)
3. BERULTSEVA SOFYA (KAZ)
3. KEINANEN TITTA (FIN)
5. FERRACUTI CLIO (ITA)
5. JUNNER NIAMH (SCO)
7. GIAMOUKI THEODOSIA (CYP)
7. GARCIA NANCY (FRA)

\*Seeded

Referees:			

# Female Kumite 68+ Kg - Round Robin (each against each)

Karate1 Premier League - Cairo 2024, Cairo, EGY

Tatami

Pool  
8/8

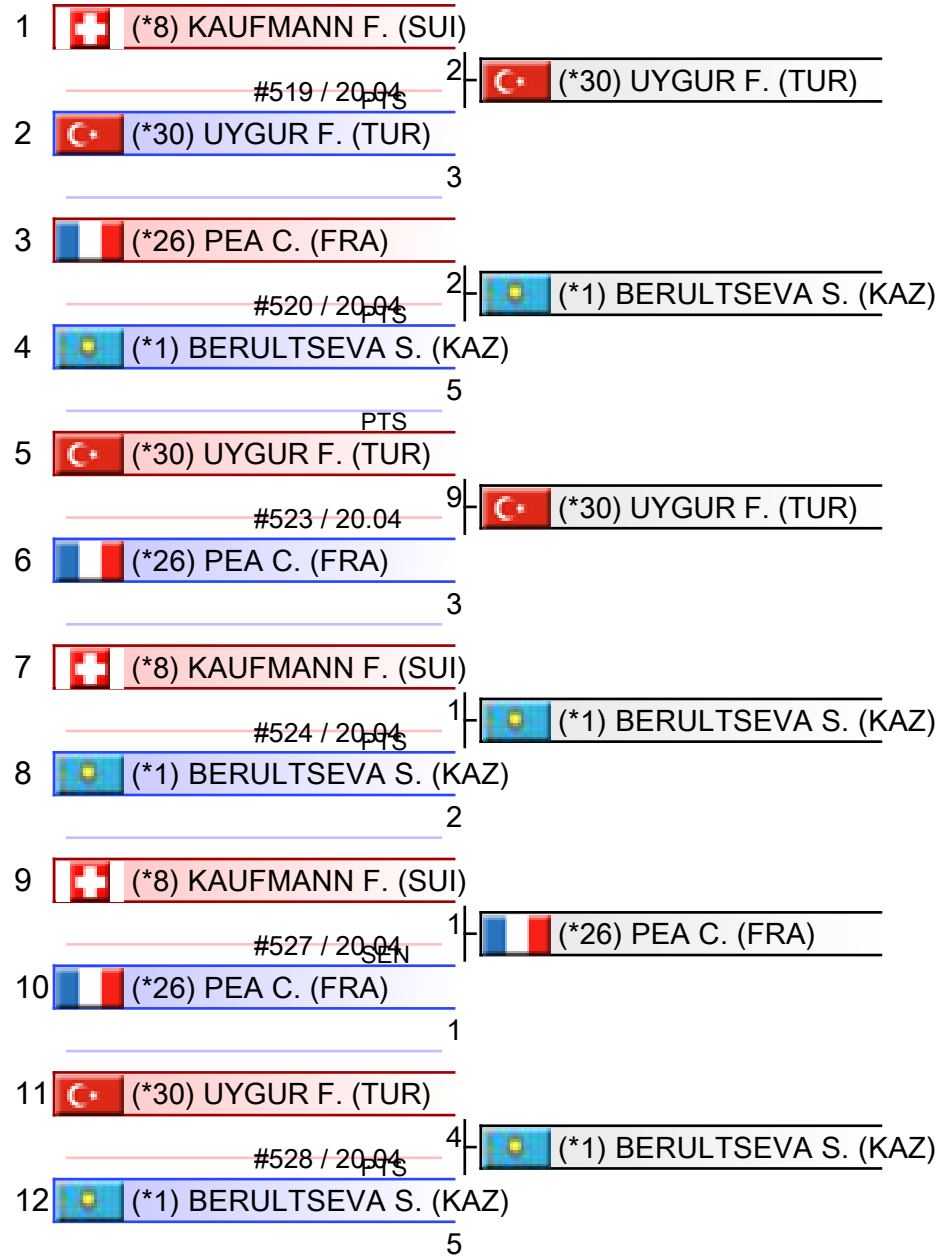

1. BERULTSEVA SOFYA (KAZ)
2. UYGUR FATMA (TUR)
3. PEA CLEMENCE (FRA)
4. KAUFMANN FABIENNE (SUI)



1. KNEER JOHANNA (GER)
2. TORRES GARCIA MARIA (ESP)
3. BERULTSEVA SOFYA (KAZ)
3. KEINANEN TITTA (FIN)
5. FERRACUTI CLIO (ITA)
5. JUNNER NIAMH (SCO)
7. GIAMOUKI THEODOSIA (CYP)
7. GARCIA NANCY (FRA)

\*Seeded

Referees:			

# Pool winner-Female Kumite 68+ Kg

Karate1 Premier League - Cairo 2024, Cairo, EGY

Tatami

Pool

1/1

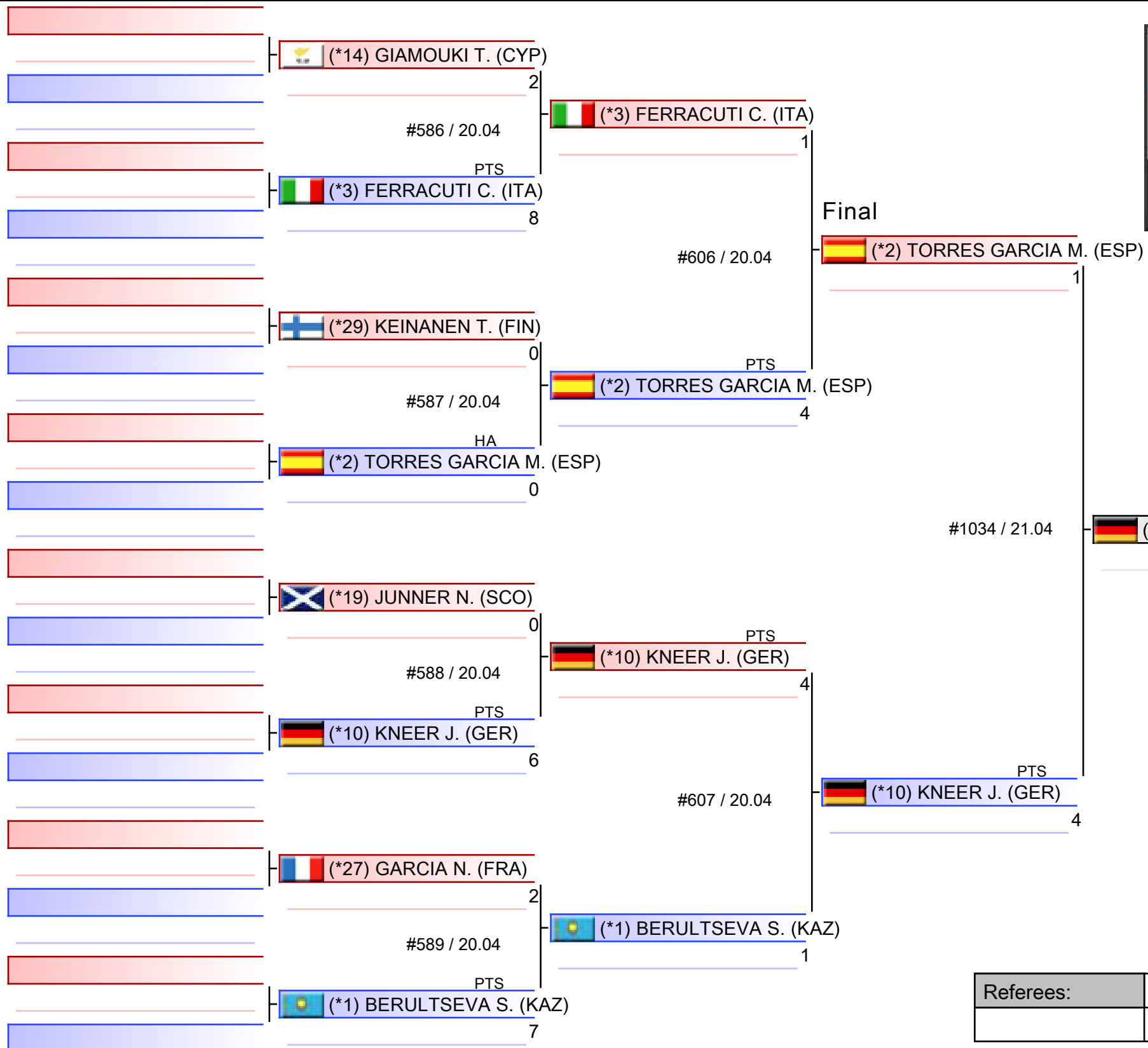

1. KNEER JOHANNA (GER)
2. TORRES GARCIA MARIA (ESP)
3. BERULTSEVA SOFYA (KAZ)
3. KEINANEN TITTA (FIN)
5. FERRACUTI CLIO (ITA)
5. JUNNER NIAMH (SCO)
7. GIAMOUKI THEODOSIA (CYP)
7. GARCIA NANCY (FRA)

\*Seeded

Referees:			

# Female Kumite 68+ Kg

Karate1 Premier League - Cairo 2024

Tatami

Pool

1,2,3,4,5,6,7,8

(c)sportdata GmbH & Co KG 2000-2024 (2024-04-21 18:26) v 10.2.0 build 1 (2024-04-20 17:58 CET) License: SDIL\_TV-GRAPHICS (expire 2024-12-31)

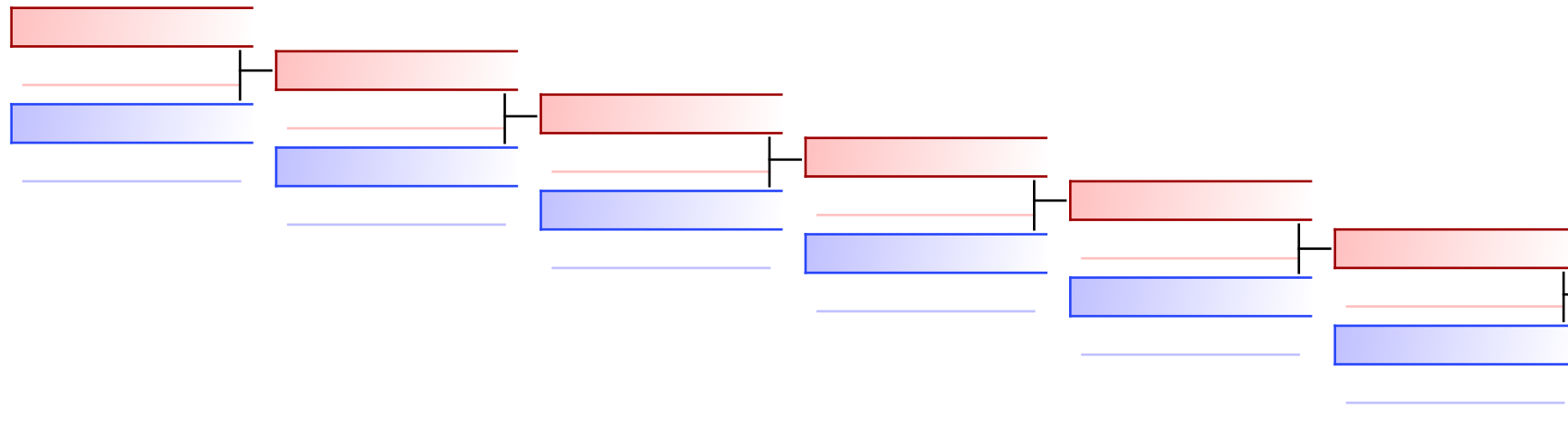

PTS

Keinanen Titta (FIN) 5

FERRACUTI CLIO (ITA) 4

Keinanen Titta (FIN)

## REPECHAGE: (1,2,3,4,5,6,7,8)

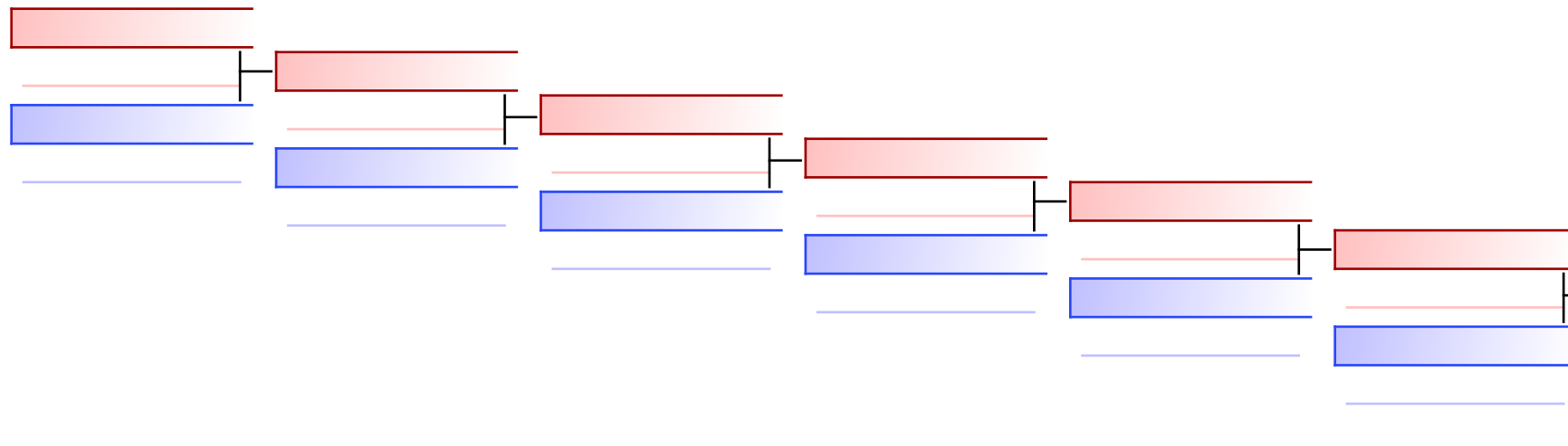

#1021 / 21.04

JUNNER NIAMH (SCO)

PTS

BERULTSEVA SOFYA (KAZ) 0

BERULTSEVA SOFYA (KAZ) 1

Referees:							
-----------	--	--	--	--	--	--	--



Karate1 Premier League - Cairo 2024 - 2024-04-19



## Official Results

Female Kumite 68+ Kg			
1	KNEER JOHANNA		GER - GERMANY
2	TORRES GARCIA MARIA		ESP - SPAIN
3	BERULTSEVA SOFYA		KAZ - KAZAKHSTAN
3	KEINANEN TITTA		FIN - FINLAND
5	FERRACUTI CLIO		ITA - ITALY
5	JUNNER NIAMH		SCO - SCOTLAND
7	GIAMOUKI THEODOSIA		CYP - CYPRUS
7	GARCIA NANCY		FRA - FRANCE

# MALE KATA



# Karate1 Premier League - Cairo 2024

## ENTRIES BY WEIGHT CATEGORY



### Male Kata

As of 21 APR 2024

NOC Code	Gender	Name	Seeding
FRA	M	NGOAN Franck	20
HKG	M	HUNG HO WAI HOWARD	19
HUN	M	Bardos Adam	25
HUN	M	NAGY BOTOND	12
ITA	M	Gallo Gianluca	28
ITA	M	GHINAMI ALESSIO	11
ITA	M	Grazia Manuel	26
ITA	M	Panagia Giuseppe	31
ITA	M	Polsinelli Guido	30
JOR	M	ABU ALHAIJA Kareem	29
JPN	M	ABE SAKICHI	8
JPN	M	FUNADA AOI	7
JPN	M	Ikeda Ryusei	6
JPN	M	Kikuchi Ryonosuke	5
JPN	M	MACHIDA YASUHIRO	13
JPN	M	Moto Kazumasa	4
JPN	M	Moto Ryuji	14
JPN	M	Nishiyama Kakeru	1
JPN	M	Sato Yuki	17
KUW	M	ALMOSAWI SAYED MOHAMMED	21
KUW	M	ALMOSAWI SAYED SALMAN	24
KUW	M	HUSSAIN MOHAMMAD	16
ROU	M	COMANESCU PETRU	27
SUI	M	UJIHARA YUKI	15
SVK	M	HRCKA ROMAN	22
TUR	M	OZDEMIR ENES	18
TUR	M	SOFUOGLU ALI	3
UKR	M	FEDOROV YAROSLAV	23
USA	M	CHINEN REY	9
USA	M	Torres Gutierrez Ariel	2
USA	M	Tozaki Gakuji	10



# Male Kata - Round Robin (each against each)

Karate1 Premier League - Cairo 2024, Cairo, EGY

Tatami

Pool

1/8

1	(*15) UJIHARA Y. (SUI)	047 Kururunfa #307 / 20.04	4060	(*20) NGOAN F. (FRA)
2	(*20) NGOAN F. (FRA)	099 Unsu	4060	
3	(*10) TOZAKI G. (USA)	001 Anan #308 / 20.04	4180	(*14) MOTO R. (JPN)
4	(*14) MOTO R. (JPN)	091 Sochin	4160	
5	(*20) NGOAN F. (FRA)	021 Gojushiho Sho #311 / 20.04	3990	(*10) TOZAKI G. (USA)
6	(*10) TOZAKI G. (USA)	092 Suparinpei	4070	
7	(*15) UJIHARA Y. (SUI)	092 Suparinpei #312 / 20.04	3940	(*14) MOTO R. (JPN)
8	(*14) MOTO R. (JPN)	012 Enpi	4070	
9	(*15) UJIHARA Y. (SUI)	068 Papuren #315 / 20.04	4010	(*10) TOZAKI G. (USA)
10	(*10) TOZAKI G. (USA)	064 Ohan Dai	4150	
11	(*20) NGOAN F. (FRA)	091 Sochin #316 / 20.04	3940	(*14) MOTO R. (JPN)
12	(*14) MOTO R. (JPN)	021 Gojushiho Sho	4120	



1. MOTO RYUJI (JPN)
2. TOZAKI GAKUJI (USA)
3. NGOAN FRANCK (FRA)
4. UJIHARA YUKI (SUI)

1. NISHIYAMA KAKERU (JPN)
2. SOFUOGLU ALI (TUR)
3. FUNADA AOI (JPN)
3. TORRES GUTIERREZ ARIEL (USA)
5. MOTO RYUJI (JPN)
5. ABE SAKICHI (JPN)
7. OZDEMIR ENES (TUR)
7. MOTO KAZUMASA (JPN)

\*Seeded

Referees:			

# Male Kata - Round Robin (each against each)

Karate1 Premier League - Cairo 2024, Cairo, EGY

Tatami

Pool  
2/8

1	(*5) KIKUCHI R. (JPN)	064 Ohan Dai #309 / 20.04	4060	(*5) KIKUCHI R. (JPN)
2	(*23) FEDOROV Y. (UKR)	002 Anan Dai	3930	
3	(*9) CHINEN R. (USA)	068 Papuren #310 / 20.04	4080	(*3) SOFUOGLU A. (TUR)
4	(*3) SOFUOGLU A. (TUR)	091 Sochin	4120	
5	(*23) FEDOROV Y. (UKR)	064 Ohan Dai #313 / 20.04	3970	(*9) CHINEN R. (USA)
6	(*9) CHINEN R. (USA)	002 Anan Dai	4010	
7	(*5) KIKUCHI R. (JPN)	001 Anan #314 / 20.04	4120	(*3) SOFUOGLU A. (TUR)
8	(*3) SOFUOGLU A. (TUR)	020 Gojushiho Dai	4210	
9	(*5) KIKUCHI R. (JPN)	091 Sochin #317 / 20.04	4100	(*9) CHINEN R. (USA)
10	(*9) CHINEN R. (USA)	092 Suparinpei	4130	
11	(*23) FEDOROV Y. (UKR)	001 Anan #318 / 20.04	3950	(*3) SOFUOGLU A. (TUR)
12	(*3) SOFUOGLU A. (TUR)	060 Nijushiho	4150	



1. SOFUOGLU ALI (TUR)
2. CHINEN REY (USA)
3. KIKUCHI RYONOSUKE (JPN)
4. FEDOROV YAROSLAV (UKR)

1. NISHIYAMA KAKERU (JPN)
2. SOFUOGLU ALI (TUR)
3. FUNADA AOI (JPN)
3. TORRES GUTIERREZ ARIEL (USA)
5. MOTO RYUJI (JPN)
5. ABE SAKICHI (JPN)
7. OZDEMIR ENES (TUR)
7. MOTO KAZUMASA (JPN)

\*Seeded

Referees:			

# Male Kata - Round Robin (each against each)

Karate1 Premier League - Cairo 2024, Cairo, EGY

Tatami

Pool  
3/8

1	(*26) GRAZIA M. (ITA)	063 Ohan #373 / 20.04	3850	(*26) GRAZIA M. (ITA)
2	(*29) ABU ALHAIJA K. (JOR)	041 Kanku Sho	3780	
3	(*17) SATO Y. (JPN)	068 Papuren #374 / 20.04	4000	(*18) OZDEMIR E. (TUR)
4	(*18) OZDEMIR E. (TUR)	020 Gojushiho Dai	4050	
5	(*29) ABU ALHAIJA K. (JOR)	021 Gojushiho Sho #377 / 20.04	3770	(*17) SATO Y. (JPN)
6	(*17) SATO Y. (JPN)	001 Anan	4020	
7	(*26) GRAZIA M. (ITA)	002 Anan Dai #378 / 20.04	3900	(*18) OZDEMIR E. (TUR)
8	(*18) OZDEMIR E. (TUR)	021 Gojushiho Sho	4150	
9	(*26) GRAZIA M. (ITA)	064 Ohan Dai #381 / 20.04	3880	(*17) SATO Y. (JPN)
10	(*17) SATO Y. (JPN)	092 Suparinpei	4060	
11	(*29) ABU ALHAIJA K. (JOR)	099 Unsu #382 / 20.04	3650	(*18) OZDEMIR E. (TUR)
12	(*18) OZDEMIR E. (TUR)	091 Sochin	4130	

1. OZDEMIR ENES (TUR)
2. SATO YUKI (JPN)
3. GRAZIA MANUEL (ITA)
4. ABU ALHAIJA KAREEM (JOR)



1. NISHIYAMA KAKERU (JPN)
2. SOFUOGLU ALI (TUR)
3. FUNADA AOI (JPN)
3. TORRES GUTIERREZ ARIEL (USA)
5. MOTO RYUJI (JPN)
5. ABE SAKICHI (JPN)
7. OZDEMIR ENES (TUR)
7. MOTO KAZUMASA (JPN)

\*Seeded

Referees:			

# Male Kata - Round Robin (each against each)

Karate1 Premier League - Cairo 2024, Cairo, EGY

Tatami

Pool

4/8

1	(*31) PANAGIA G. (ITA)	020 Gojushiho Dai #375 / 20.04	3950	(*31) PANAGIA G. (ITA)
2	(*12) NAGY B. (HUN)	067 Paiku	3880	
3	(*13) MACHIDA Y. (JPN)	068 Papuren #376 / 20.04	4120	(*2) TORRES GUTIERREZ A. (USA)
4	(*2) TORRES GUTIERREZ A. (USA)	064 Ohan Dai	4190	
5	(*12) NAGY B. (HUN)	064 Ohan Dai #379 / 20.04	3850	(*13) MACHIDA Y. (JPN)
6	(*13) MACHIDA Y. (JPN)	092 Suparinpei	4130	
7	(*31) PANAGIA G. (ITA)	015 Gankaku #380 / 20.04	3890	(*2) TORRES GUTIERREZ A. (USA)
8	(*2) TORRES GUTIERREZ A. (USA)	047 Kururunfa	4200	
9	(*31) PANAGIA G. (ITA)	021 Gojushiho Sho #383 / 20.04	3870	(*13) MACHIDA Y. (JPN)
10	(*13) MACHIDA Y. (JPN)	002 Anan Dai	4070	
11	(*12) NAGY B. (HUN)	002 Anan Dai #384 / 20.04	4000	(*2) TORRES GUTIERREZ A. (USA)
12	(*2) TORRES GUTIERREZ A. (USA)	063 Ohan	4200	



1. TORRES GUTIERREZ ARIEL (USA)
2. MACHIDA YASUHIRO (JPN)
3. PANAGIA GIUSEPPE (ITA)
4. NAGY BOTOND (HUN)

1. NISHIYAMA KAKERU (JPN)
2. SOFUOGLU ALI (TUR)
3. FUNADA AOI (JPN)
3. TORRES GUTIERREZ ARIEL (USA)
5. MOTO RYUJI (JPN)
5. ABE SAKICHI (JPN)
7. OZDEMIR ENES (TUR)
7. MOTO KAZUMASA (JPN)

\*Seeded

Referees:			

# Male Kata - Round Robin (each against each)

Karate1 Premier League - Cairo 2024, Cairo, EGY

Tatami

Pool

5/8

1	(*28) GALLO G. (ITA)	021 Gojushiho Sho #445 / 20.04	3980	(*19) HUNG H. (HKG)
2	(*19) HUNG H. (HKG)	063 Ohan	4030	
3	(*7) FUNADA A. (JPN)	068 Papuren #446 / 20.04	4080	(*7) FUNADA A. (JPN)
4	(*25) BARDOS A. (HUN)	001 Anan	3790	
5	(*19) HUNG H. (HKG)	009 Chibana No Kushanku #449 / 20.04	3980	(*7) FUNADA A. (JPN)
6	(*7) FUNADA A. (JPN)	098 Unshu	4150	
7	(*28) GALLO G. (ITA)	020 Gojushiho Dai #450 / 20.04	3940	(*28) GALLO G. (ITA)
8	(*25) BARDOS A. (HUN)	064 Ohan Dai	3860	
9	(*28) GALLO G. (ITA)	041 Kanku Sho #453 / 20.04	3790	(*7) FUNADA A. (JPN)
10	(*7) FUNADA A. (JPN)	092 Suparinpei	4130	
11	(*19) HUNG H. (HKG)	064 Ohan Dai #454 / 20.04	3970	(*19) HUNG H. (HKG)
12	(*25) BARDOS A. (HUN)	092 Suparinpei	3830	



1. FUNADA AOI (JPN)
2. HUNG HO WAI HOWARD (HKG)
3. GALLO GIANLUCA (ITA)
4. BARDOS ADAM (HUN)

1. NISHIYAMA KAKERU (JPN)
2. SOFUOGLU ALI (TUR)
3. FUNADA AOI (JPN)
3. TORRES GUTIERREZ ARIEL (USA)
5. MOTO RYUJI (JPN)
5. ABE SAKICHI (JPN)
7. OZDEMIR ENES (TUR)
7. MOTO KAZUMASA (JPN)

\*Seeded

Referees:			

# Male Kata - Round Robin (each against each)

Karate1 Premier League - Cairo 2024, Cairo, EGY

Tatami

Pool  
6/8

1	(*27) COMANESCU P. (ROU)	099 Unsu #447 / 20.04	3970	(*16) HUSSAIN M. (KUW)
2	(*16) HUSSAIN M. (KUW)	020 Gojushiho Dai	3980	
3	(*22) HRCKA R. (SVK)	063 Ohan #448 / 20.04	3870	(*4) MOTO K. (JPN)
4	(*4) MOTO K. (JPN)	091 Sochin	4180	
5	(*16) HUSSAIN M. (KUW)	099 Unsu #451 / 20.04	3970	(*16) HUSSAIN M. (KUW)
6	(*22) HRCKA R. (SVK)	061 Nipaipo	3960	
7	(*27) COMANESCU P. (ROU)	021 Gojushiho Sho #452 / 20.04	4030	(*4) MOTO K. (JPN)
8	(*4) MOTO K. (JPN)	012 Enpi	4190	
9	(*27) COMANESCU P. (ROU)	041 Kanku Sho #455 / 20.04	4030	(*27) COMANESCU P. (ROU)
10	(*22) HRCKA R. (SVK)	068 Papuren	3980	
11	(*16) HUSSAIN M. (KUW)	021 Gojushiho Sho #456 / 20.04	4030	(*4) MOTO K. (JPN)
12	(*4) MOTO K. (JPN)	020 Gojushiho Dai	4140	

1. MOTO KAZUMASA (JPN)
2. HUSSAIN MOHAMMAD (KUW)
3. COMANESCU PETRU (ROU)
4. HRCKA ROMAN (SVK)



1. NISHIYAMA KAKERU (JPN)
2. SOFUOGLU ALI (TUR)
3. FUNADA AOI (JPN)
3. TORRES GUTIERREZ ARIEL (USA)
5. MOTO RYUJI (JPN)
5. ABE SAKICHI (JPN)
7. OZDEMIR ENES (TUR)
7. MOTO KAZUMASA (JPN)

\*Seeded



















Referees:			

# Male Kata - Round Robin (each against each)

Karate1 Premier League - Cairo 2024, Cairo, EGY

Tatami

Pool  
7/8

1	 (*30) POLSINELLI G. (ITA)	021 Gojushiho Sho #508 / 20.04	4010	 (*6) IKEDA R. (JPN)
2	 (*6) IKEDA R. (JPN)	063 Ohan	4190	
3	 (*24) ALMOSAWI S. (KUW)	021 Gojushiho Sho #509 / 20.04	3980	 (*8) ABE S. (JPN)
4	 (*8) ABE S. (JPN)	001 Anan	4230	
5	 (*6) IKEDA R. (JPN)	002 Anan Dai #511 / 20.04	4190	 (*6) IKEDA R. (JPN)
6	 (*24) ALMOSAWI S. (KUW)	041 Kanku Sho	4010	
7	 (*30) POLSINELLI G. (ITA)	099 Unsu #512 / 20.04	4020	 (*8) ABE S. (JPN)
8	 (*8) ABE S. (JPN)	092 Suparinpei	4260	
9	 (*30) POLSINELLI G. (ITA)	078 Sansai #514 / 20.04	3910	 (*24) ALMOSAWI S. (KUW)
10	 (*24) ALMOSAWI S. (KUW)	099 Unsu	4030	
11	 (*6) IKEDA R. (JPN)	064 Ohan Dai #515 / 20.04	4140	 (*8) ABE S. (JPN)
12	 (*8) ABE S. (JPN)	063 Ohan	4250	



1. ABE SAKICHI (JPN)
2. IKEDA RYUSEI (JPN)
3. ALMOSAWI SAYED SALMAN (KUW)
4. POLSINELLI GUIDO (ITA)

1. NISHIYAMA KAKERU (JPN)
2. SOFUOGLU ALI (TUR)
3. FUNADA AOI (JPN)
3. TORRES GUTIERREZ ARIEL (USA)
5. MOTO RYUJI (JPN)
5. ABE SAKICHI (JPN)
7. OZDEMIR ENES (TUR)
7. MOTO KAZUMASA (JPN)

\*Seeded









Referees:			

# Male Kata - Round Robin (each against each)

Karate1 Premier League - Cairo 2024, Cairo, EGY

Tatami

Pool  
8/8

1	 (*11) GHINAMI A. (ITA)	041 Kanku Sho #510 / 20.04	4110	 (*11) GHINAMI A. (ITA)
2	 (*21) ALMOSAWI S. (KUW)	099 Unsu	3960	
3	 (*11) GHINAMI A. (ITA)	041 Kanku Sho #516 / 20.04	4120	 (*1) NISHIYAMA K. (JPN)
4	 (*1) NISHIYAMA K. (JPN)	090 Shisochin	4300	
5	 (*21) ALMOSAWI S. (KUW)	041 Kanku Sho #513 / 20.04	3920	 (*1) NISHIYAMA K. (JPN)
6	 (*1) NISHIYAMA K. (JPN)	086 Seisan	4280	

1. NISHIYAMA KAKERU (JPN)
2. GHINAMI ALESSIO (ITA)
3. ALMOSAWI SAYED MOHAMMED (KUW)



1. NISHIYAMA KAKERU (JPN)
2. SOFUOGLU ALI (TUR)
3. FUNADA AOI (JPN)
3. TORRES GUTIERREZ ARIEL (USA)
5. MOTO RYUJI (JPN)
5. ABE SAKICHI (JPN)
7. OZDEMIR ENES (TUR)
7. MOTO KAZUMASA (JPN)

\*Seeded

Referees:			



# Pool winner-Male Kata

Karate1 Premier League - Cairo 2024, Cairo, EGY

Tatami

Pool  
1/1

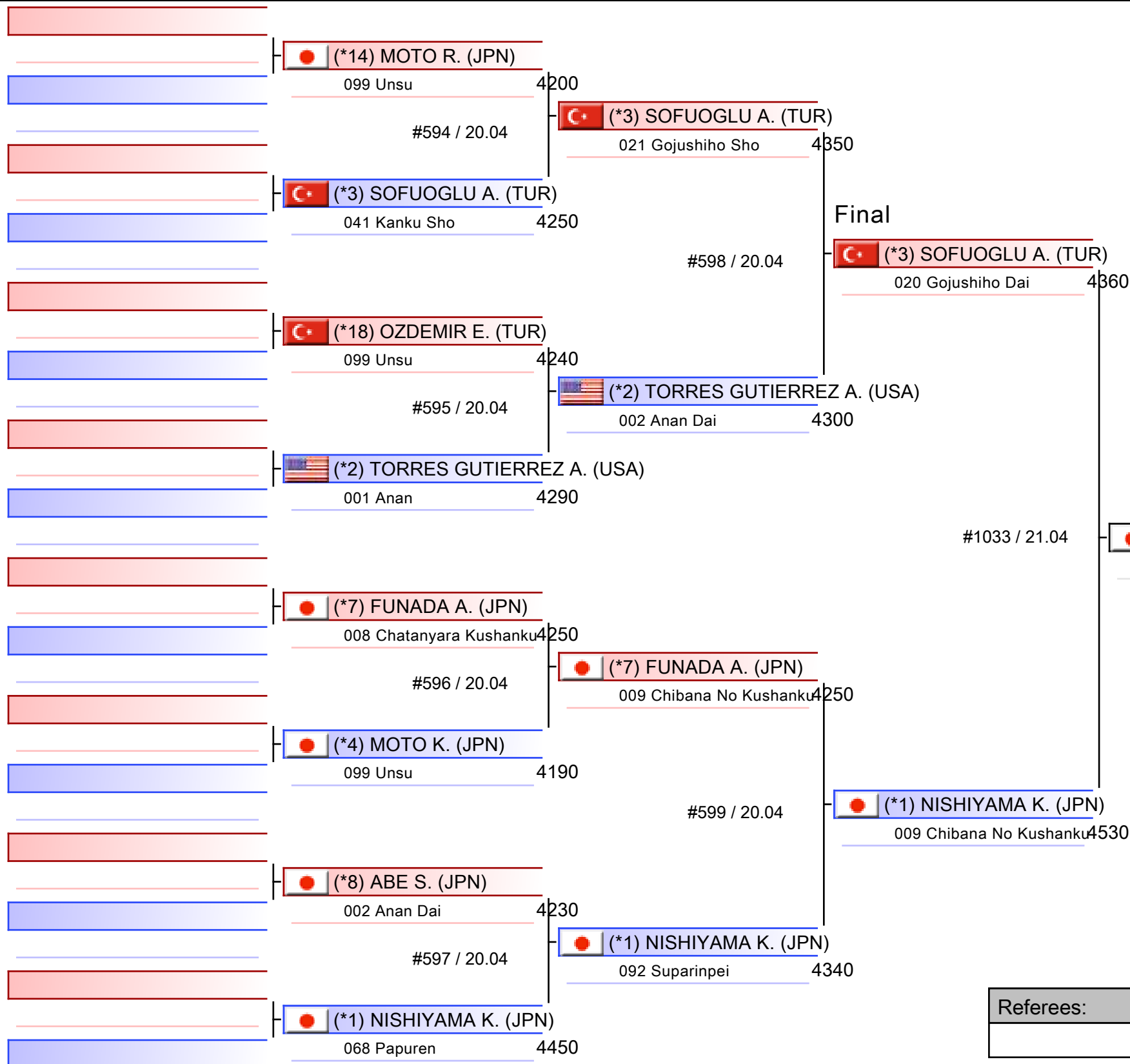

1. NISHIYAMA KAKERU (JPN)
2. SOFUOGLU ALI (TUR)
3. FUNADA AOI (JPN)
3. TORRES GUTIERREZ ARIEL (USA)
5. MOTO RYUJI (JPN)
5. ABE SAKICHI (JPN)
7. OZDEMIR ENES (TUR)
7. MOTO KAZUMASA (JPN)

\*Seeded

Referees:			

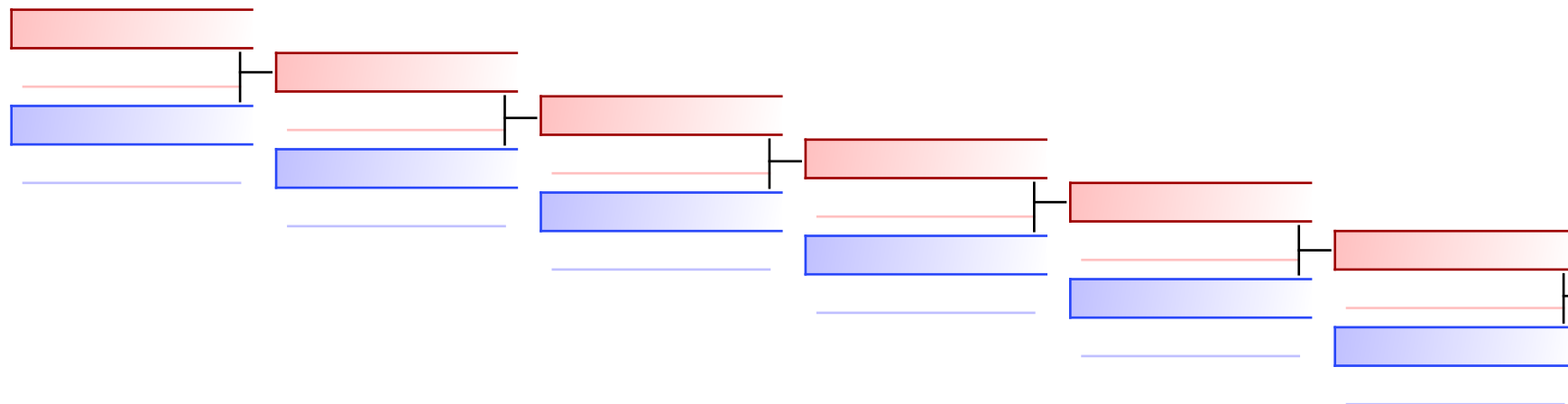

#1018

Moto Ryuji (JPN)	037 Jitte	4240	Torres Gutierrez Ariel (USA)
Torres Gutierrez Ariel (USA)	064 Ohan Dai	4440	

REPECHAGE: (1,2,3,4,5,6,7,8)

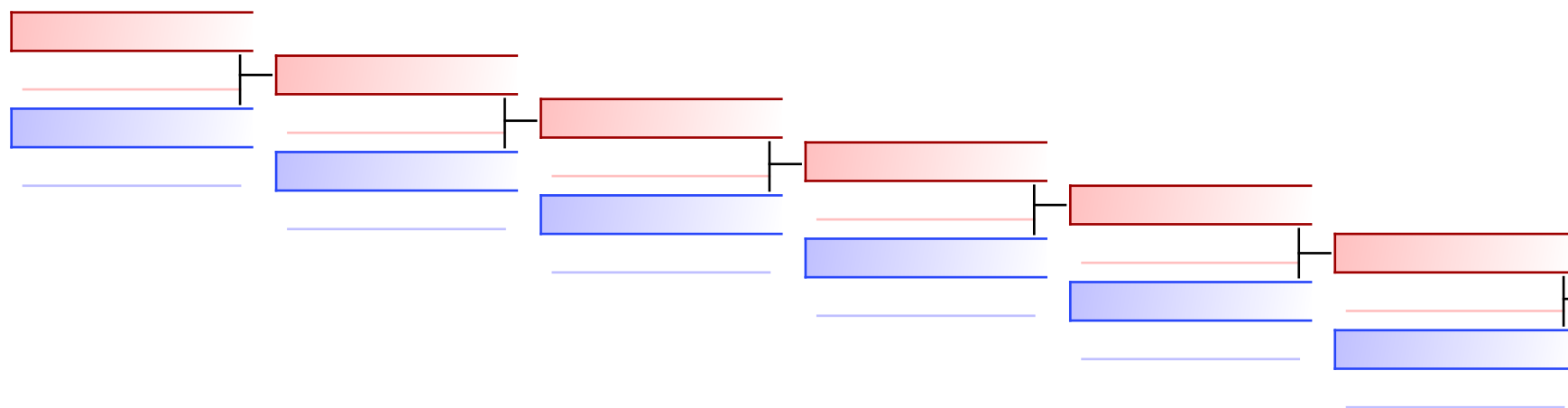

#1019 / 21.04

ABE SAKICHI (JPN)	064 Ohan Dai	4290	FUNADA AOI (JPN)
FUNADA AOI (JPN)	008 Chatanyar.	4320	

Referees:							
-----------	--	--	--	--	--	--	--



Karate1 Premier League - Cairo 2024 - 2024-04-19



## Official Results

Male Kata			
1	NISHIYAMA KAKERU		JPN - JAPAN
2	SOFUOGLU ALI		TUR - TURKIYE
3	FUNADA AOI		JPN - JAPAN
3	TORRES GUTIERREZ ARIEL		USA - UNITED STATES
5	MOTO RYUJI		JPN - JAPAN
5	ABE SAKICHI		JPN - JAPAN
7	OZDEMIR ENES		TUR - TURKIYE
7	MOTO KAZUMASA		JPN - JAPAN

# MALE KUMITE -60 KG



Karate1 Premier League - Cairo 2024  
**ENTRIES BY WEIGHT CATEGORY**



**Male Kumite -60 Kg**

As of 21 APR 2024

NOC Code	Gender	Name	Seeding
ALB	M	Arifi Orges	22
AZE	M	GULIYEV AMINAGHA	17
AZE	M	SAVADOV FARID	10
BEL	M	ABDELMALKI ANASS	15
CAN	M	MIRI YASSIN	32
CHI	M	VILLALON RUIZ ENRIQUE	25
COL	M	FORERO JUAN DAVID	21
EGY	M	Aboukora Amr Alaa	11
EGY	M	Aly Zyad	30
FRA	M	MEZIANE Rayyan	8
FRA	M	TAS SAMI	29
GEO	M	TKEBUCHAVA DAVID	20
GER	M	HAAS FLORIAN	12
GRE	M	XENOS CHRISTOS-STEFANOS	1
HKG	M	CHAU KA HIM	27
ITA	M	CRESCENZO ANGELO	2
ITA	M	Gentile Samuele	28
ITA	M	GRECO DANILLO	23
ITA	M	Luciano Carmine	14
JOR	M	HAMMAD ABDALLAH	9
JOR	M	SHAQRAH OMAR	19
JPN	M	HASHIMOTO HIROMU	3
KAZ	M	ALPYSBAY KAISAR	6
KAZ	M	TIMRALIYEV DARKHAN	24
KSA	M	ALQAHTANI SULTAN	18
KUW	M	SHAABAN ABDULLAH	4
ROU	M	GOGOLOSI BOGDAN MARIAN FLORIN	16
SVK	M	IMRICH DOMINIK	13
SWE	M	NOORI NEMATOLLAH	31
TUR	M	HALICI MERT	7
TUR	M	SAMDAN ERAY	5
UKR	M	FILIPOV NIKITA	26

# Male Kumite -60 Kg - Round Robin (each against each)

Karate1 Premier League - Cairo 2024, Cairo, EGY

Tatami

Pool  
1/8

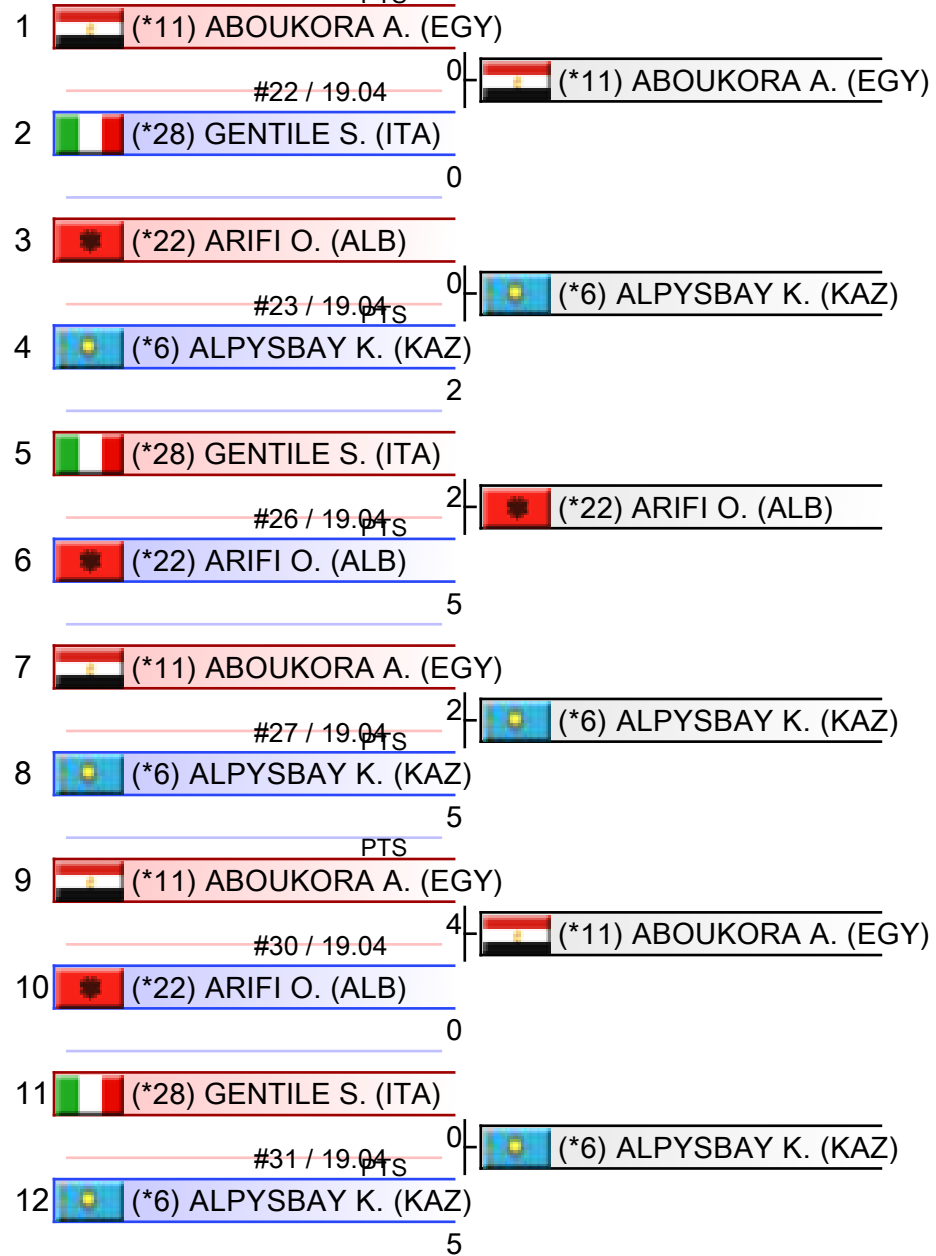

1. ALPYSBAY KAISAR (KAZ)
2. ABOUKORA AMR ALAA (EGY)
3. ARIFI ORGES (ALB)
4. GENTILE SAMUELE (ITA)



1. HAMMAD ABDALLAH (JOR)
2. HASHIMOTO HIROMU (JPN)
3. XENOS CHRISTOS-STEFANOS (GRE)
3. ALPYSBAY KAISAR (KAZ)
5. ALY ZYAD (EGY)
5. SHAABAN ABDULLAH (KUW)
7. GRECO DANILO (ITA)
7. GULIYEV AMINAGHA (AZE)

\*Seeded

Referees:			

# Male Kumite -60 Kg - Round Robin (each against each)

Karate1 Premier League - Cairo 2024, Cairo, EGY

Tatami

Pool  
2/8

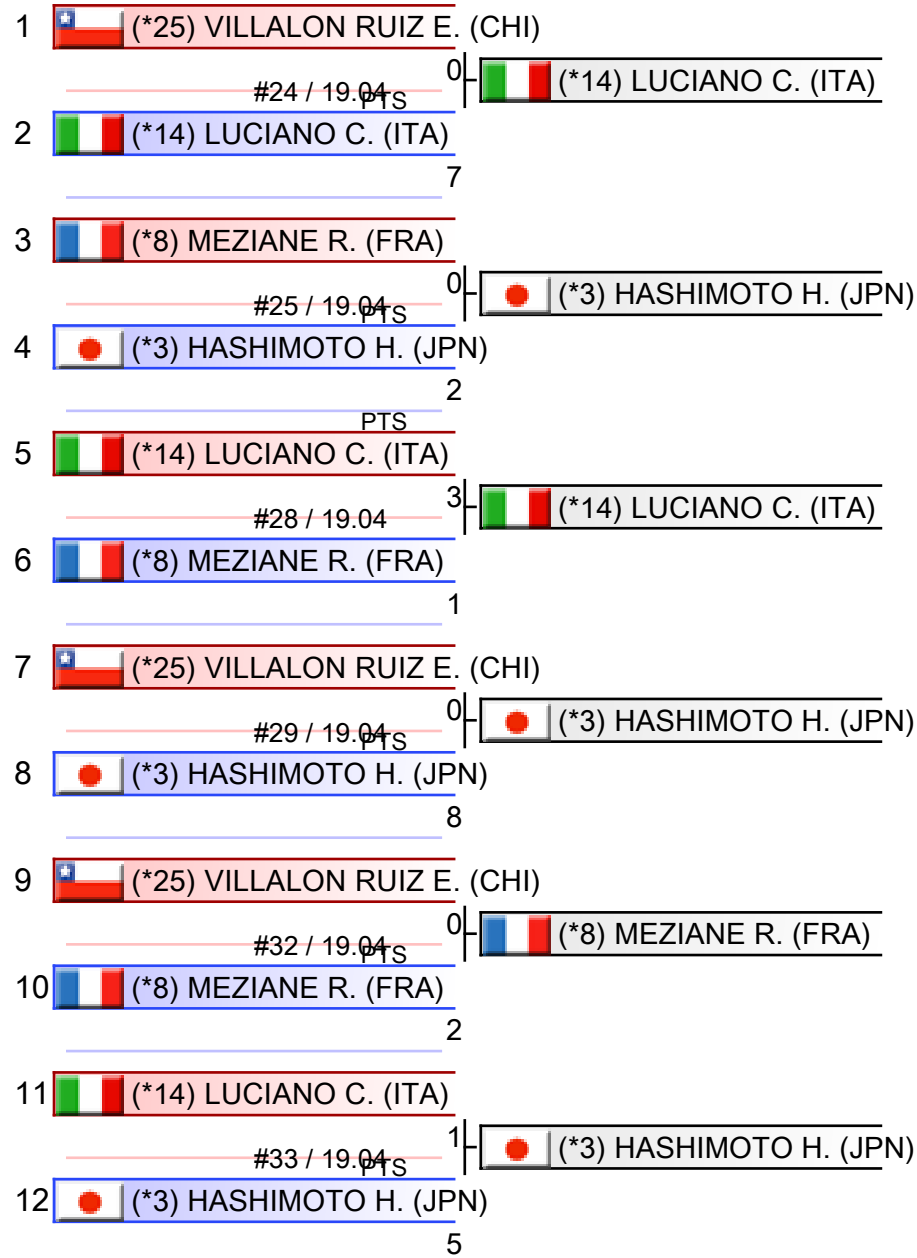

1. HASHIMOTO HIROMU (JPN)
2. LUCIANO CARMINE (ITA)
3. MEZIANE RAYYAN (FRA)
4. VILLALON RUIZ ENRIQUE (CHI)



1. HAMMAD ABDALLAH (JOR)
2. HASHIMOTO HIROMU (JPN)
3. XENOS CHRISTOS-STEFANOS (GRE)
3. ALPYSBAY KAISAR (KAZ)
5. ALY ZYAD (EGY)
5. SHAABAN ABDULLAH (KUW)
7. GRECO DANILO (ITA)
7. GULIYEV AMINAGHA (AZE)

\*Seeded

Referees:			

# Male Kumite -60 Kg - Round Robin (each against each)

Karate1 Premier League - Cairo 2024, Cairo, EGY

Tatami

Pool  
3/8



1. GRECO DANILO (ITA)
2. TIMRALIYEV DARKHAN (KAZ)
3. FILIPOV NIKITA (UKR)
4. ALQAHTANI SULTAN (KSA)



1. HAMMAD ABDALLAH (JOR)
2. HASHIMOTO HIROMU (JPN)
3. XENOS CHRISTOS-STEFANOS (GRE)
3. ALPYSBAY KAISAR (KAZ)
5. ALY ZYAD (EGY)
5. SHAABAN ABDULLAH (KUW)
7. GRECO DANILO (ITA)
7. GULIYEV AMINAGHA (AZE)

\*Seeded

Referees:			



# Male Kumite -60 Kg - Round Robin (each against each)

Karate1 Premier League - Cairo 2024, Cairo, EGY

Tatami

Pool

4/8



1. ALY ZYAD (EGY)
2. CRESCENZO ANGELO (ITA)
3. GOGOLOSI BOGDAN MARIAN FLORIN (ROU)
4. TAS SAMI (FRA)



1. HAMMAD ABDALLAH (JOR)
2. HASHIMOTO HIROMU (JPN)
3. XENOS CHRISTOS-STEFANOS (GRE)
3. ALPYSBAY KAISAR (KAZ)
5. ALY ZYAD (EGY)
5. SHAABAN ABDULLAH (KUW)
7. GRECO DANILO (ITA)
7. GULIYEV AMINAGHA (AZE)

\*Seeded

Referees:			

# Male Kumite -60 Kg - Round Robin (each against each)

Karate1 Premier League - Cairo 2024, Cairo, EGY

Tatami

Pool

5/8

1	(*17) GULIYEV A. (AZE)	0	(*21) FORERO J. (COL)
	#160 / 19.04		
2	(*21) FORERO J. (COL)	8	
3	(*13) IMRICH D. (SVK)	0	(*19) SHAQRAH O. (JOR)
	#161 / 19.04		
4	(*19) SHAQRAH O. (JOR)	3	
5	(*21) FORERO J. (COL)	0	(*13) IMRICH D. (SVK)
	#164 / 19.04		
6	(*13) IMRICH D. (SVK)	1	
	PTS		
7	(*17) GULIYEV A. (AZE)	1	(*17) GULIYEV A. (AZE)
	#165 / 19.04		
8	(*19) SHAQRAH O. (JOR)	0	
	PTS		
9	(*17) GULIYEV A. (AZE)	1	(*17) GULIYEV A. (AZE)
	#168 / 19.04		
10	(*13) IMRICH D. (SVK)	0	
11	(*21) FORERO J. (COL)	5	(*19) SHAQRAH O. (JOR)
	#169 / 19.04		
12	(*19) SHAQRAH O. (JOR)	6	

1. GULIYEV AMINAGHA (AZE)
2. SHAQRAH OMAR (JOR)
3. IMRICH DOMINIK (SVK)
4. FORERO JUAN DAVID (COL)



1. HAMMAD ABDALLAH (JOR)
2. HASHIMOTO HIROMU (JPN)
3. XENOS CHRISTOS-STEFANOS (GRE)
3. ALPYSBAY KAISAR (KAZ)
5. ALY ZYAD (EGY)
5. SHAABAN ABDULLAH (KUW)
7. GRECO DANILO (ITA)
7. GULIYEV AMINAGHA (AZE)

\*Seeded

Referees:			

# Male Kumite -60 Kg - Round Robin (each against each)

Karate1 Premier League - Cairo 2024, Cairo, EGY

Tatami

Pool  
6/8

1	(*32) MIRI Y. (CAN)	
	#162 / 19.04	3    (*7) HALICI M. (TUR)
2	(*7) HALICI M. (TUR)	6
3	(*10) SAVADOV F. (AZE)	
	#163 / 19.04	1    (*4) SHAABAN A. (KUW)
4	(*4) SHAABAN A. (KUW)	0
	PTS	
5	(*7) HALICI M. (TUR)	
	#166 / 19.04	1    (*7) HALICI M. (TUR)
6	(*10) SAVADOV F. (AZE)	0
7	(*32) MIRI Y. (CAN)	
	#167 / 19.04	0
8	(*4) SHAABAN A. (KUW)	0
	SEN	
9	(*32) MIRI Y. (CAN)	
	#170 / 19.04	1    (*32) MIRI Y. (CAN)
10	(*10) SAVADOV F. (AZE)	1
11	(*7) HALICI M. (TUR)	
	#171 / 19.04	3    (*4) SHAABAN A. (KUW)
12	(*4) SHAABAN A. (KUW)	5

1. SHAABAN ABDULLAH (KUW)
2. HALICI MERT (TUR)
3. MIRI YASSIN (CAN)
4. SAVADOV FARID (AZE)



1. HAMMAD ABDALLAH (JOR)
2. HASHIMOTO HIROMU (JPN)
3. XENOS CHRISTOS-STEFANOS (GRE)
3. ALPYSBAY KAISAR (KAZ)
5. ALY ZYAD (EGY)
5. SHAABAN ABDULLAH (KUW)
7. GRECO DANILO (ITA)
7. GULIYEV AMINAGHA (AZE)

\*Seeded

Referees:			

# Male Kumite -60 Kg - Round Robin (each against each)

Karate1 Premier League - Cairo 2024, Cairo, EGY

Tatami

Pool  
7/8

1	(*9) HAMMAD A. (JOR)	PTS	
	#226 / 19.04	2	(*9) HAMMAD A. (JOR)
2	(*15) ABDELMALKI A. (BEL)	1	
3	(*20) TKEBUCHAVA D. (GEO)	PTS	
	#227 / 19.04	1	(*27) CHAU K. (HKG)
4	(*27) CHAU K. (HKG)	3	
5	(*15) ABDELMALKI A. (BEL)	PTS	
	#230 / 19.04	4	(*15) ABDELMALKI A. (BEL)
6	(*20) TKEBUCHAVA D. (GEO)	2	
7	(*9) HAMMAD A. (JOR)	PTS	
	#231 / 19.04	1	(*9) HAMMAD A. (JOR)
8	(*27) CHAU K. (HKG)	9	
9	(*9) HAMMAD A. (JOR)	PTS	
	#234 / 19.04	3	(*9) HAMMAD A. (JOR)
10	(*20) TKEBUCHAVA D. (GEO)	0	
11	(*15) ABDELMALKI A. (BEL)	PTS	
	#235 / 19.04	2	
12	(*27) CHAU K. (HKG)	2	

1. HAMMAD ABDALLAH (JOR)
2. CHAU KA HIM (HKG)
3. ABDELMALKI ANASS (BEL)
4. TKEBUCHAVA DAVID (GEO)



1. HAMMAD ABDALLAH (JOR)
2. HASHIMOTO HIROMU (JPN)
3. XENOS CHRISTOS-STEFANOS (GRE)
3. ALPYSBAY KAISAR (KAZ)
5. ALY ZYAD (EGY)
5. SHAABAN ABDULLAH (KUW)
7. GRECO DANILO (ITA)
7. GULIYEV AMINAGHA (AZE)

\*Seeded

Referees:			

# Male Kumite -60 Kg - Round Robin (each against each)

Karate1 Premier League - Cairo 2024, Cairo, EGY

Tatami

Pool  
8/8

1	(*5) SAMDAN E. (TUR)	4	(*5) SAMDAN E. (TUR)
	#228 / 19.04		
2	(*12) HAAS F. (GER)	0	
3	(*31) NOORI N. (SWE)	0	(*1) XENOS C. (GRE)
	#229 / 19.04		
4	(*1) XENOS C. (GRE)	8	
	PTS		
5	(*12) HAAS F. (GER)	4	(*12) HAAS F. (GER)
	#232 / 19.04		
6	(*31) NOORI N. (SWE)	1	
7	(*5) SAMDAN E. (TUR)	1	(*1) XENOS C. (GRE)
	#233 / 19.04		
8	(*1) XENOS C. (GRE)	2	
	PTS		
9	(*5) SAMDAN E. (TUR)	3	(*5) SAMDAN E. (TUR)
	#236 / 19.04		
10	(*31) NOORI N. (SWE)	1	
11	(*12) HAAS F. (GER)	2	(*1) XENOS C. (GRE)
	#237 / 19.04		
12	(*1) XENOS C. (GRE)	3	



1. XENOS CHRISTOS-STEFANOS (GRE)
2. SAMDAN ERAY (TUR)
3. HAAS FLORIAN (GER)
4. NOORI NEMATOLLAH (SWE)

1. HAMMAD ABDALLAH (JOR)
2. HASHIMOTO HIROMU (JPN)
3. XENOS CHRISTOS-STEFANOS (GRE)
3. ALPYSBAY KAISAR (KAZ)
5. ALY ZYAD (EGY)
5. SHAABAN ABDULLAH (KUW)
7. GRECO DANILO (ITA)
7. GULIYEV AMINAGHA (AZE)

\*Seeded

Referees:			

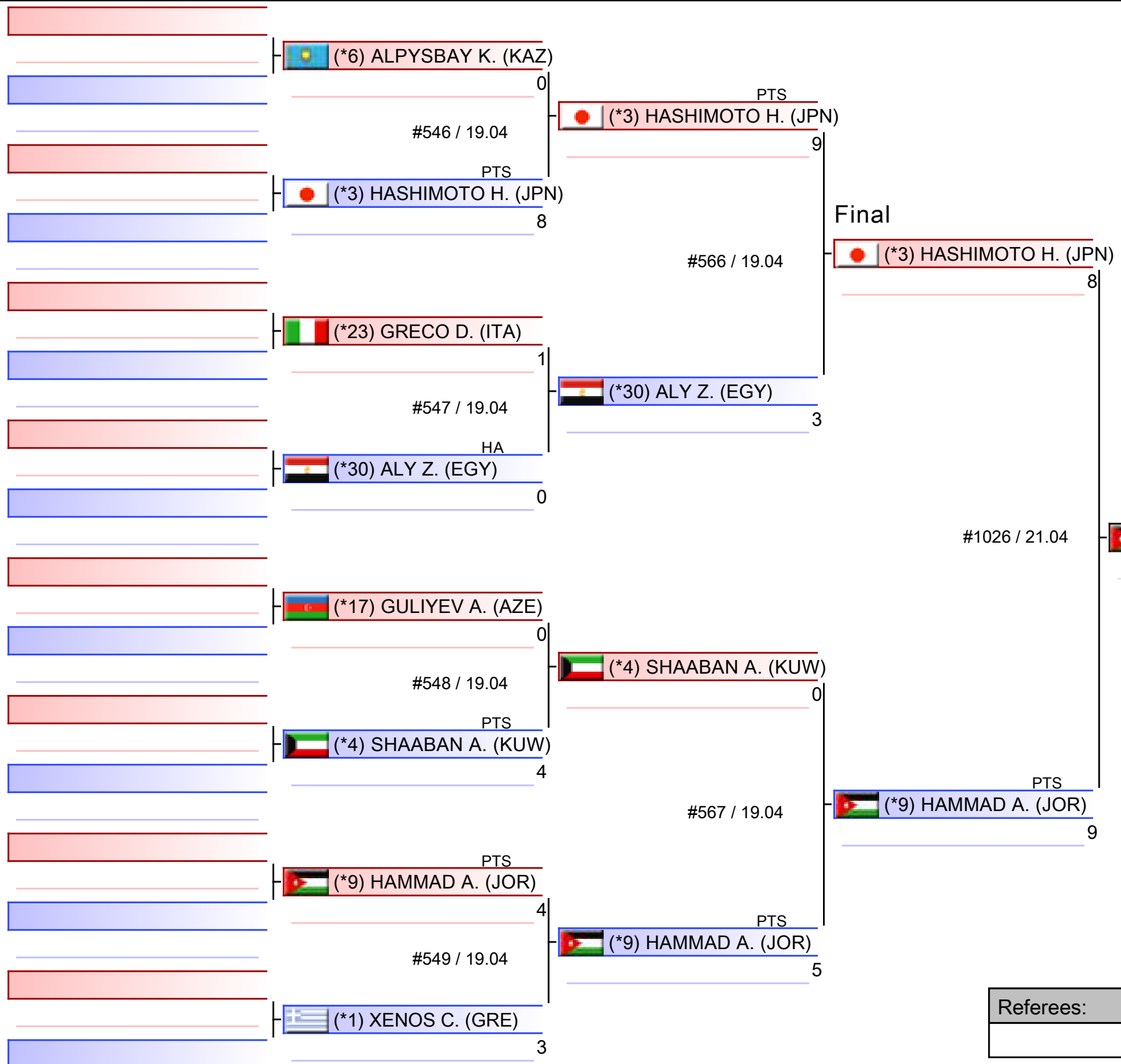

1. HAMMAD ABDALLAH (JOR)
2. HASHIMOTO HIROMU (JPN)
3. XENOS CHRISTOS-STEFANOS (GRE)
3. ALPYSBAY KAISAR (KAZ)
5. ALY ZYAD (EGY)
5. SHAABAN ABDULLAH (KUW)
7. GRECO DANILLO (ITA)
7. GULIYEV AMINAGHA (AZE)

\*Seeded

Referees:			

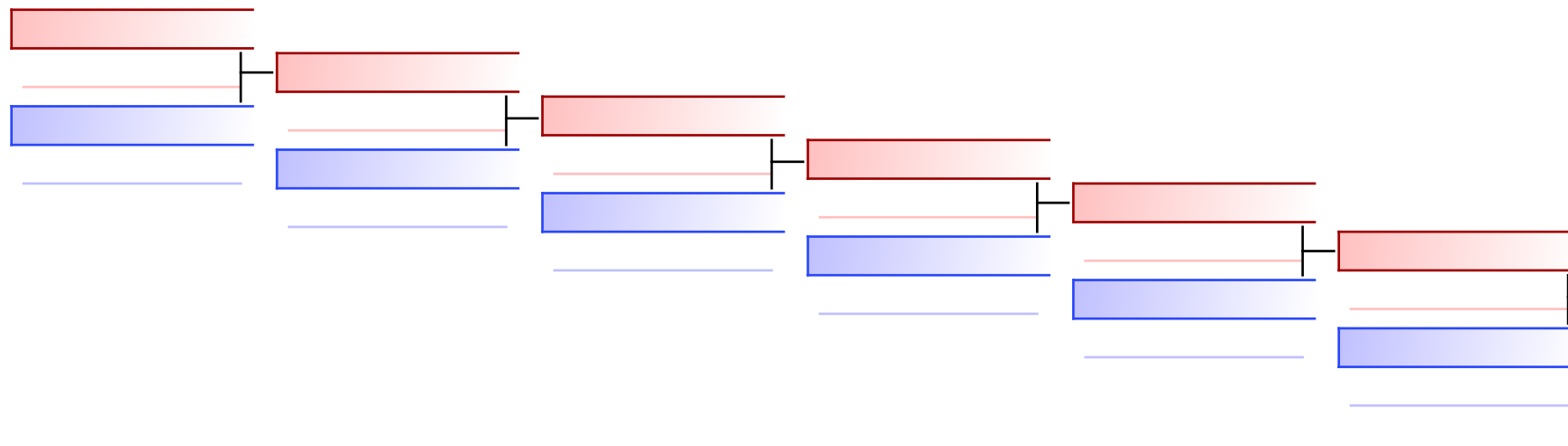

#1004

KI

ALPYSBAY KAISAR (KAZ) 0

Aly Zyad (EGY) 0

ALPYSBAY KAISAR (KAZ)

REPECHAGE: (1,2,3,4,5,6,7,8)

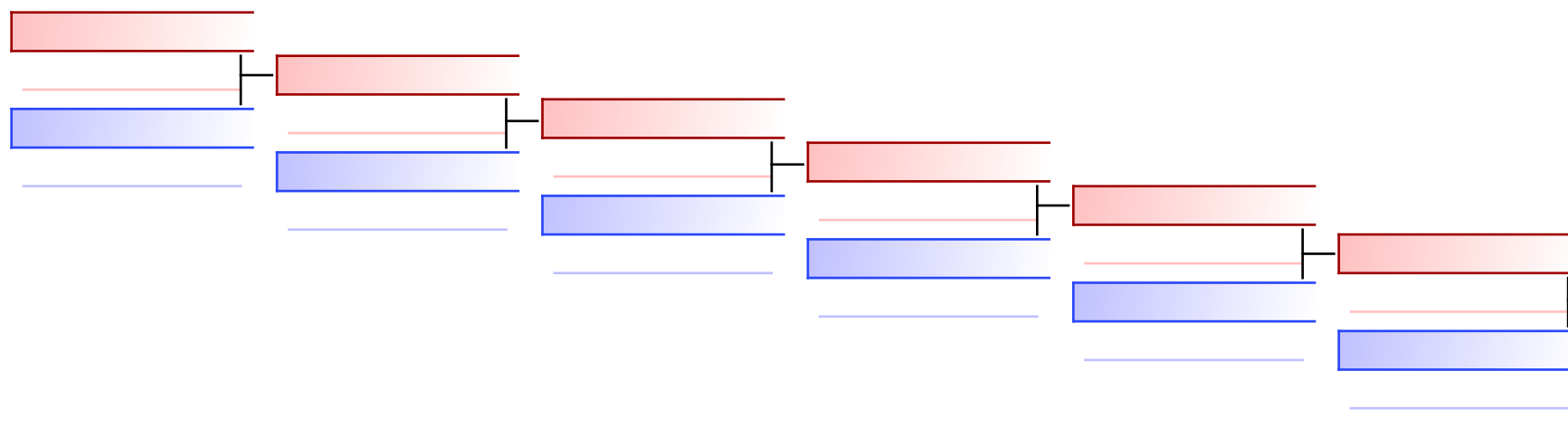

#1005 / 21.04

PTS

XENOS CHRISTOS-STEFANOS (GRE) 5

SHAABAN ABDULLAH (KUW) 3

XENOS CHRISTOS-STEFANOS (GRE)

Referees:							
-----------	--	--	--	--	--	--	--



Karate1 Premier League - Cairo 2024 - 2024-04-19



## Official Results

Male Kumite -60 Kg			
1	HAMMAD ABDALLAH		JOR - JORDAN
2	HASHIMOTO HIROMU		JPN - JAPAN
3	XENOS CHRISTOS-STEFANOS		GRE - GREECE
3	ALPYSBAY KAISAR		KAZ - KAZAKHSTAN
5	ALY ZYAD		EGY - EGYPT
5	SHAABAN ABDULLAH		KUW - KUWAIT
7	GRECO DANILO		ITA - ITALY
7	GULIYEV AMINAGHA		AZE - AZERBAIJAN



# MALE KUMITE -67 KG



Karate1 Premier League - Cairo 2024  
**ENTRIES BY WEIGHT CATEGORY**



**Male Kumite -67 Kg**

As of 21 APR 2024

NOC Code	Gender	Name	Seeding
AZE	M	AGHALARZADE TURAL	5
AZE	M	RZAZADE NURAN	14
BEL	M	ABDELMALKI AMIN	23
BRA	M	FIGUEIRA VINICIUS	16
CHI	M	FREIRE FUENTES TOMAS	26
EGY	M	Elsawy Ali	15
ENG	M	Wilson Joby	29
GER	M	OEZDEMIR MUHAMMED	10
GRE	M	BALLOTIS GEORGIOS	20
ITA	M	DE VIVO GIANLUCA	4
ITA	M	MARESCA LUCA	12
JOR	M	ALMASATFA ABDEL RAHMAN	1
JOR	M	GHAITH AFEEF	6
JPN	M	Nakano Soichiro	11
KAZ	M	AMIRALI DIDAR	2
KUW	M	ALOTAIBI MOHAMMAD	24
LAT	M	Stepanovs Arturs	25
MAR	M	OUBAYA SAID	3
POL	M	DZIUDA DOMINIK	22
POR	M	GONCALVES GUILHERME	7
SUI	M	PISINO NOAH TONY	19
TPE	M	SHIH CHENG-CHUNG	8
TUR	M	KURT ENES FATIH	9
TUR	M	OZER OMER ABDURRAHIM	13
TUR	M	UYGUR BURAK	21
TUR	M	YILMAZ EKREM ALTUNER	27
UKR	M	Naida Valentyn	28
UKR	M	PAK HNAT	18
UKR	M	YANOVSKYI DAVYD	17
USA	M	AKDE EVANGELOS	30

# Male Kumite -67 Kg - Round Robin (each against each)

Karate1 Premier League - Cairo 2024, Cairo, EGY

Tatami

Pool  
1/8

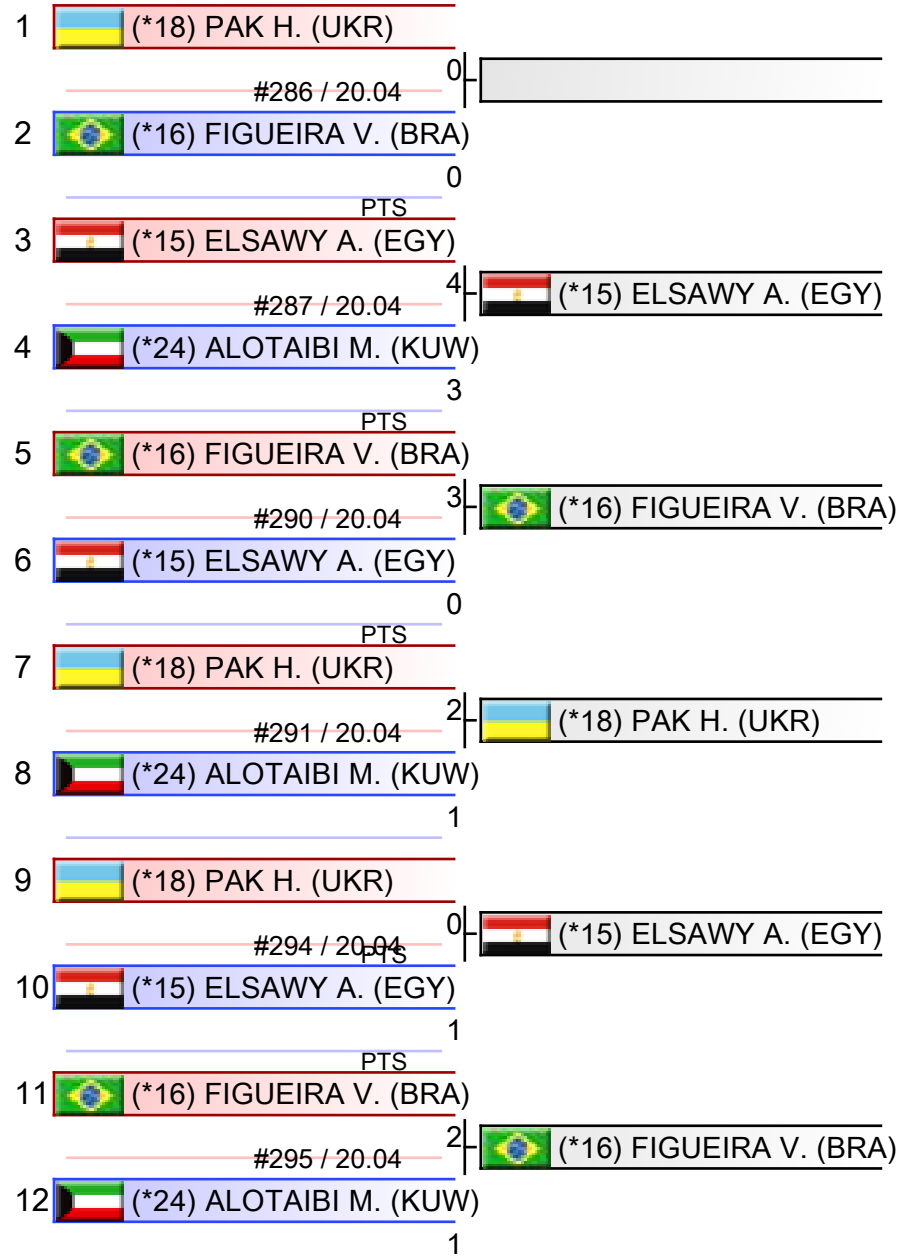

1. FIGUEIRA VINICIUS (BRA)
2. ELSAWY ALI (EGY)
3. PAK HNAT (UKR)
4. ALOTAIBI MOHAMMAD (KUW)



1. ALMASATFA ABDEL RAHMAN (JOR)
2. OUBAYA SAID (MAR)
3. GHAITH AFEEF (JOR)
3. FIGUEIRA VINICIUS (BRA)
5. AMIRALI DIDAR (KAZ)
5. BALIOTIS GEORGIOS (GRE)
7. MARESCA LUCA (ITA)
7. FREIRE FUENTES TOMAS (CHI)

\*Seeded

Referees:			

# Male Kumite -67 Kg - Round Robin (each against each)

Karate1 Premier League - Cairo 2024, Cairo, EGY

Tatami

Pool  
2/8

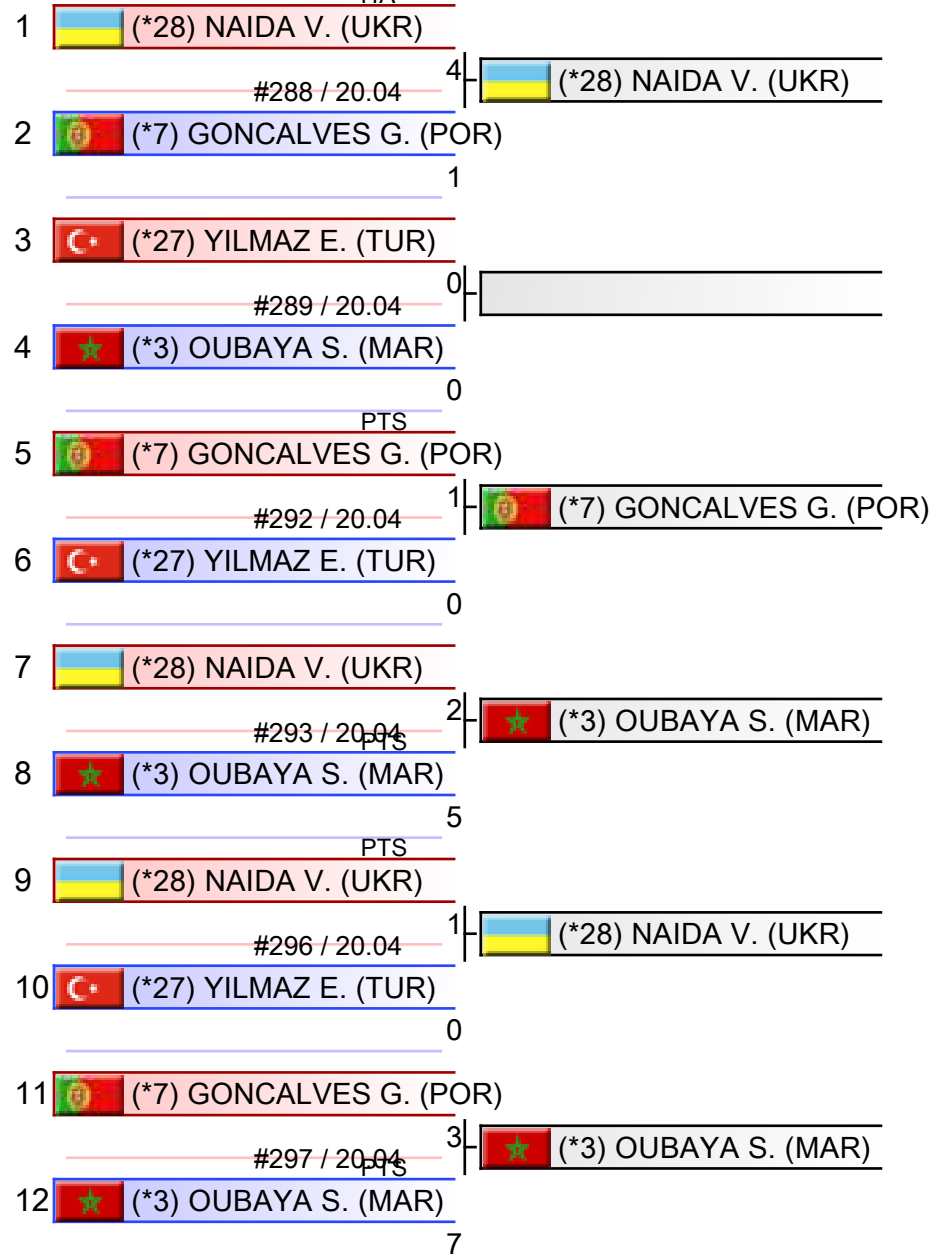

1. OUBAYA SAID (MAR)
2. NAIDA VALENTYN (UKR)
3. GONCALVES GUILHERME (POR)
4. YILMAZ EKREM ALTUNER (TUR)



1. ALMASATFA ABDEL RAHMAN (JOR)
2. OUBAYA SAID (MAR)
3. GHAITH AFEEF (JOR)
3. FIGUEIRA VINICIUS (BRA)
5. AMIRALI DIDAR (KAZ)
5. BALIOTIS GEORGIOS (GRE)
7. MARESCA LUCA (ITA)
7. FREIRE FUENTES TOMAS (CHI)

\*Seeded

Referees:			

# Male Kumite -67 Kg - Round Robin (each against each)

Karate1 Premier League - Cairo 2024, Cairo, EGY

Tatami

Pool  
3/8

1	(*8) SHIH C. (TPE)	#355 / 20.04	1	(*12) MARESCA L. (ITA)
2	(*12) MARESCA L. (ITA)	PTS	3	
3	(*11) NAKANO S. (JPN)	#356 / 20.04	2	(*11) NAKANO S. (JPN)
4	(*29) WILSON J. (ENG)	PTS	0	
5	(*12) MARESCA L. (ITA)	#358 / 20.04	1	(*12) MARESCA L. (ITA)
6	(*11) NAKANO S. (JPN)	PTS	0	
7	(*8) SHIH C. (TPE)	#359 / 20.04	3	(*8) SHIH C. (TPE)
8	(*29) WILSON J. (ENG)	PTS	0	
9	(*8) SHIH C. (TPE)	#361 / 20.04	0	(*11) NAKANO S. (JPN)
10	(*11) NAKANO S. (JPN)	PTS	1	
11	(*12) MARESCA L. (ITA)	#362 / 20.04	1	(*12) MARESCA L. (ITA)
12	(*29) WILSON J. (ENG)	PTS	0	

1. MARESCA LUCA (ITA)
2. NAKANO SOICHIRO (JPN)
3. SHIH CHENG-CHUNG (TPE)
4. WILSON JOBY (ENG)



1. ALMASATFA ABDEL RAHMAN (JOR)
2. OUBAYA SAID (MAR)
3. GHAITH AFEEF (JOR)
3. FIGUEIRA VINICIUS (BRA)
5. AMIRALI DIDAR (KAZ)
5. BALIOTIS GEORGIOS (GRE)
7. MARESCA LUCA (ITA)
7. FREIRE FUENTES TOMAS (CHI)

\*Seeded







Referees:			

# Male Kumite -67 Kg - Round Robin (each against each)

Karate1 Premier League - Cairo 2024, Cairo, EGY

Tatami

Pool  
4/8

1	 (*22) DZIUDA D. (POL)	0
	#357 / 20.04	
2	 (*17) YANOVSKYI D. (UKR)	0
3	 (*22) DZIUDA D. (POL)	0
	#363 / 20.04	
4	 (*2) AMIRALI D. (KAZ)	3
5	 (*17) YANOVSKYI D. (UKR)	0
	#360 / 20.04	
6	 (*2) AMIRALI D. (KAZ)	0

1. AMIRALI DIDAR (KAZ)
2. YANOVSKYI DAVYD (UKR)
3. DZIUDA DOMINIK (POL)



1. ALMASATFA ABDEL RAHMAN (JOR)
2. OUBAYA SAID (MAR)
3. GHAITH AFEEF (JOR)
3. FIGUEIRA VINICIUS (BRA)
5. AMIRALI DIDAR (KAZ)
5. BALIOTIS GEORGIOS (GRE)
7. MARESCA LUCA (ITA)
7. FREIRE FUENTES TOMAS (CHI)

\*Seeded

Referees:			

# Male Kumite -67 Kg - Round Robin (each against each)

Karate1 Premier League - Cairo 2024, Cairo, EGY

Tatami

Pool  
5/8

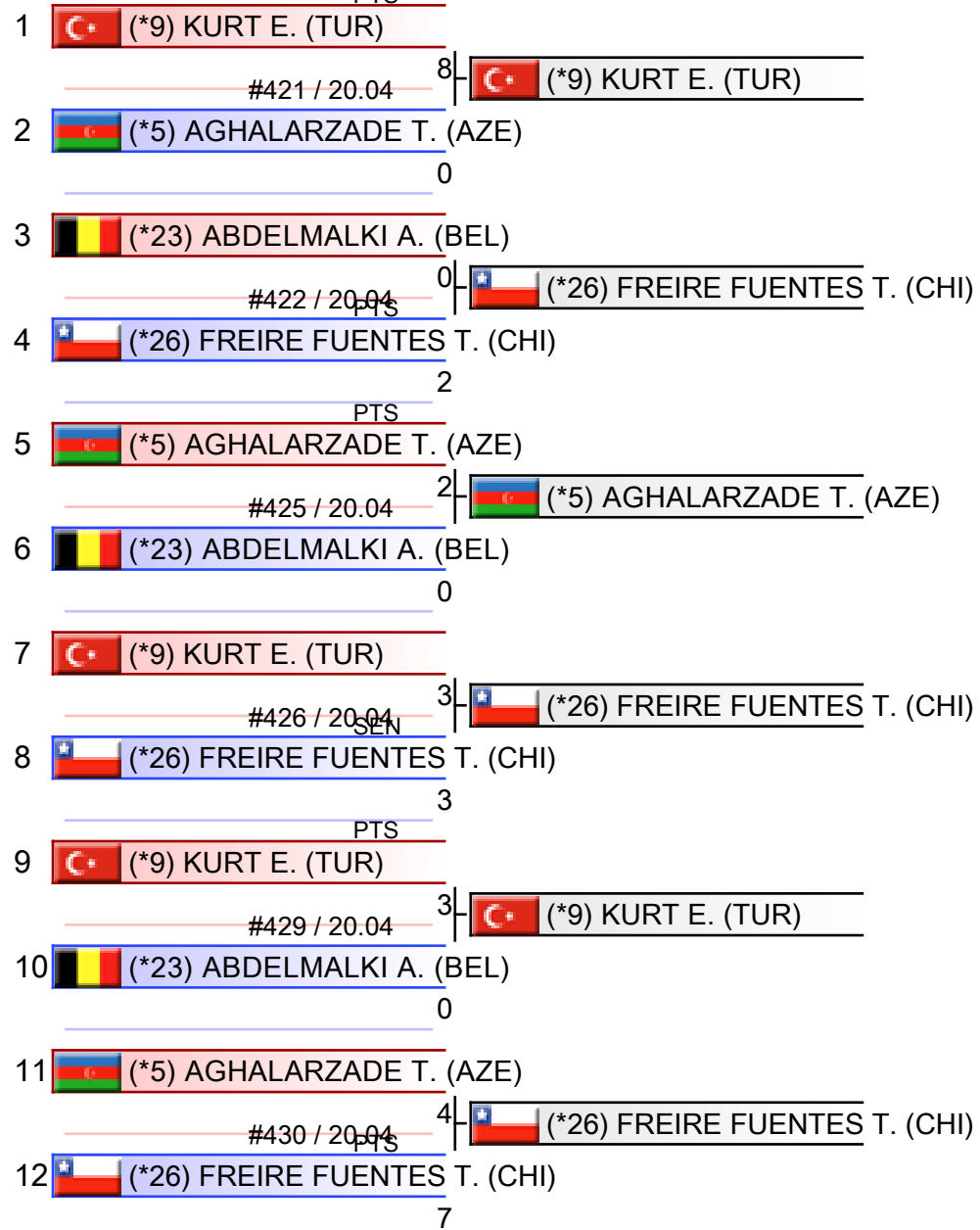

1. FREIRE FUENTES TOMAS (CHI)
2. KURT ENES FATIH (TUR)
3. AGHALARZADE TURAL (AZE)
4. ABDELMALKI AMIN (BEL)



1. ALMASATFA ABDEL RAHMAN (JOR)
2. OUBAYA SAID (MAR)
3. GHAITH AFEEF (JOR)
3. FIGUEIRA VINICIUS (BRA)
5. AMIRALI DIDAR (KAZ)
5. BALIOTIS GEORGIOS (GRE)
7. MARESCA LUCA (ITA)
7. FREIRE FUENTES TOMAS (CHI)

\*Seeded

Referees:			

# Male Kumite -67 Kg - Round Robin (each against each)

Karate1 Premier League - Cairo 2024, Cairo, EGY

Tatami

Pool  
6/8

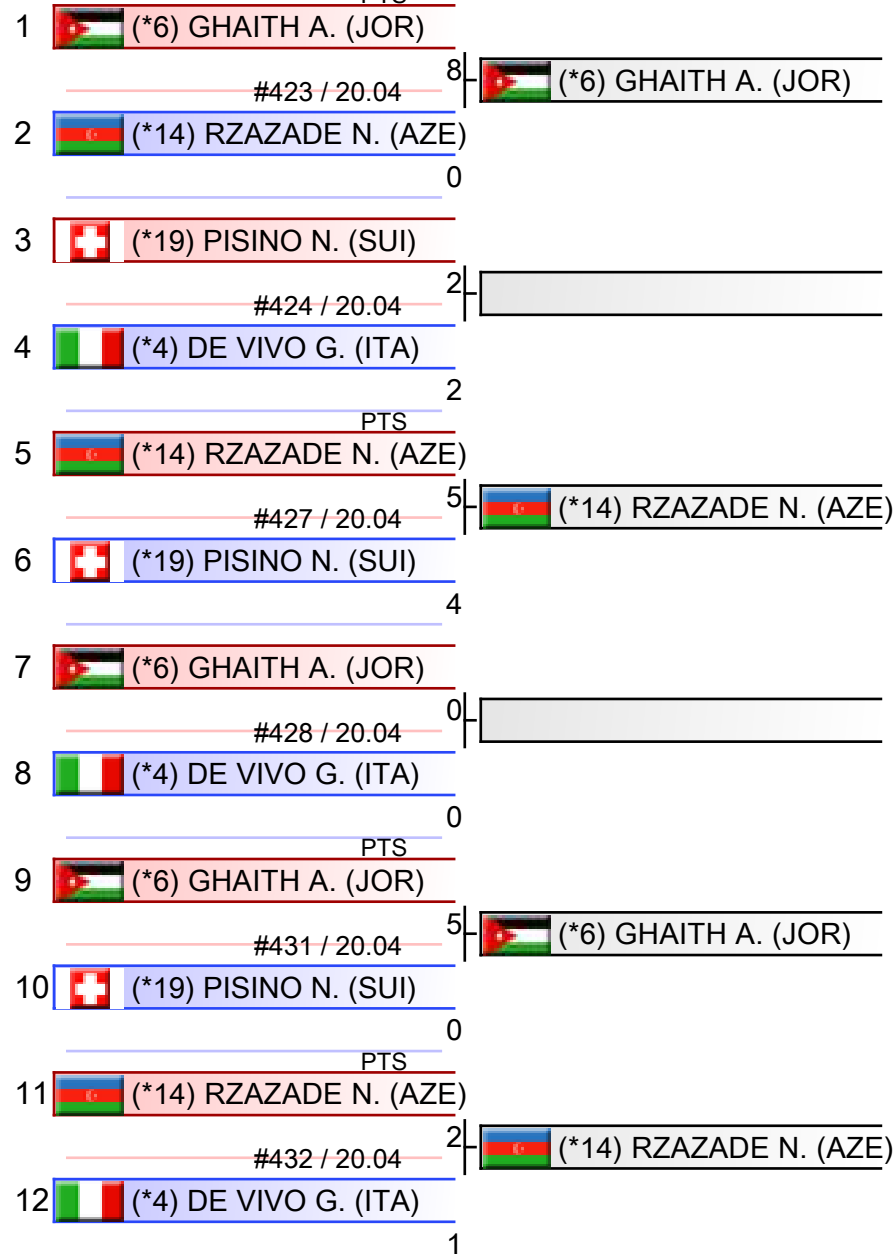

1. GHAITH AFEEF (JOR)
2. RZAZADE NURAN (AZE)
3. PISINO NOAH TONY (SUI)
4. DE VIVO GIANLUCA (ITA)



1. ALMASATFA ABDEL RAHMAN (JOR)
2. OUBAYA SAID (MAR)
3. GHAITH AFEEF (JOR)
3. FIGUEIRA VINICIUS (BRA)
5. AMIRALI DIDAR (KAZ)
5. BALIOTIS GEORGIOS (GRE)
7. MARESCA LUCA (ITA)
7. FREIRE FUENTES TOMAS (CHI)

\*Seeded

Referees:			



# Male Kumite -67 Kg - Round Robin (each against each)

Karate1 Premier League - Cairo 2024, Cairo, EGY

Tatami

Pool  
7/8

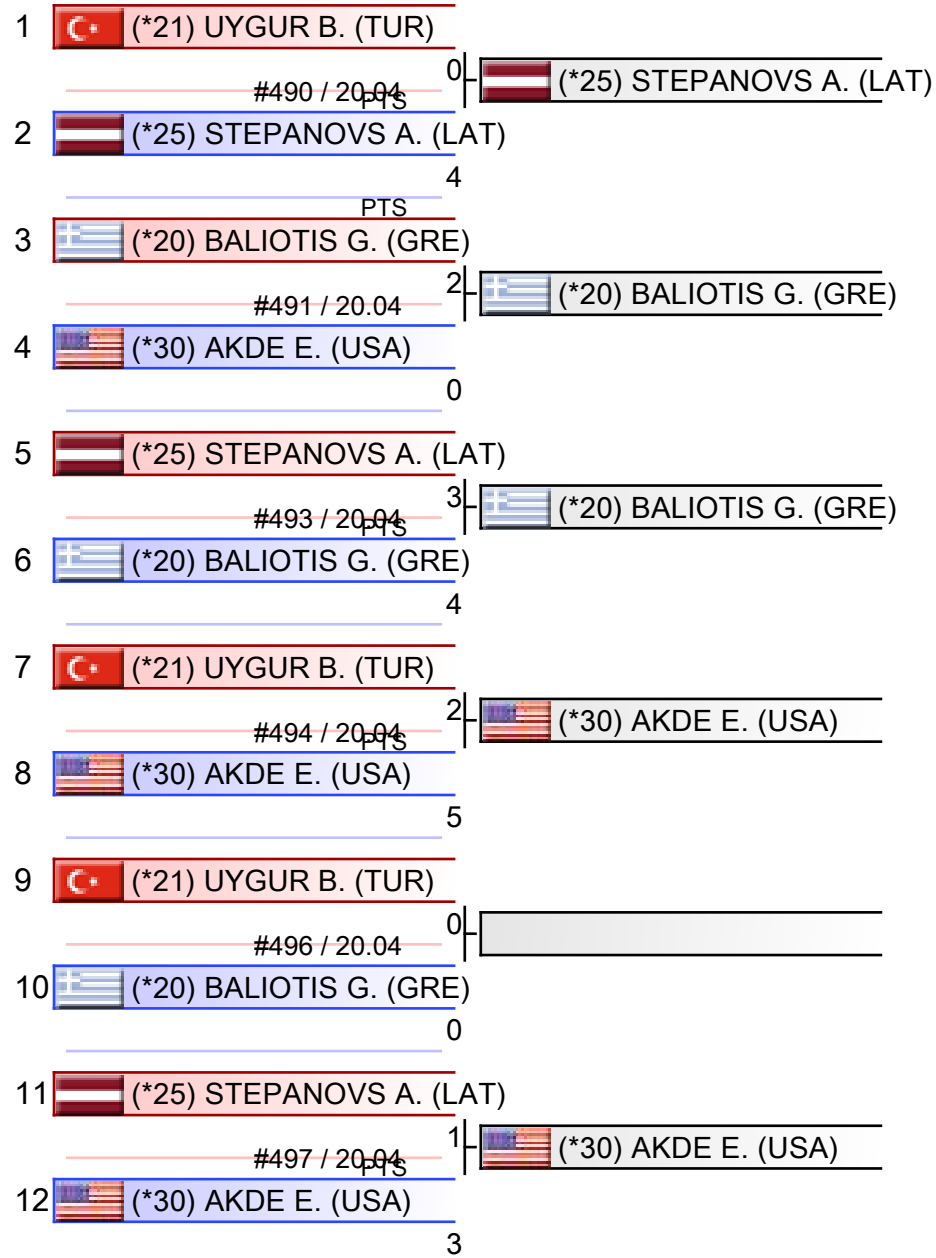

1. BALIOTIS GEORGIOS (GRE)
2. AKDE EVANGELOS (USA)
3. STEPANOVS ARTURS (LAT)
4. UYGUR BURAK (TUR)



1. ALMASATFA ABDEL RAHMAN (JOR)
2. OUBAYA SAID (MAR)
3. GHAITH AFEEF (JOR)
3. FIGUEIRA VINICIUS (BRA)
5. AMIRALI DIDAR (KAZ)
5. BALIOTIS GEORGIOS (GRE)
7. MARESCA LUCA (ITA)
7. FREIRE FUENTES TOMAS (CHI)

\*Seeded

Referees:			

# Male Kumite -67 Kg - Round Robin (each against each)

Karate1 Premier League - Cairo 2024, Cairo, EGY

Tatami

Pool  
8/8

1	(*13) OZER O. (TUR)	
	#492 / 20.04	1    (*13) OZER O. (TUR)
2	(*10) OEZDEMIR M. (GER)	0
3	(*13) OZER O. (TUR)	
	#498 / 20.04	0    (*13) OZER O. (TUR)
4	(*1) ALMASATFA A. (JOR)	0
5	(*10) OEZDEMIR M. (GER)	
	#495 / 20.04	0    (*1) ALMASATFA A. (JOR)
6	(*1) ALMASATFA A. (JOR)	2

1. ALMASATFA ABDEL RAHMAN (JOR)
2. OZER OMER ABDURRAHIM (TUR)
3. OEZDEMIR MUHAMMED (GER)



1. ALMASATFA ABDEL RAHMAN (JOR)
2. OUBAYA SAID (MAR)
3. GHAITH AFEEF (JOR)
3. FIGUEIRA VINICIUS (BRA)
5. AMIRALI DIDAR (KAZ)
5. BALIOTIS GEORGIOS (GRE)
7. MARESCA LUCA (ITA)
7. FREIRE FUENTES TOMAS (CHI)

\*Seeded

Referees:			

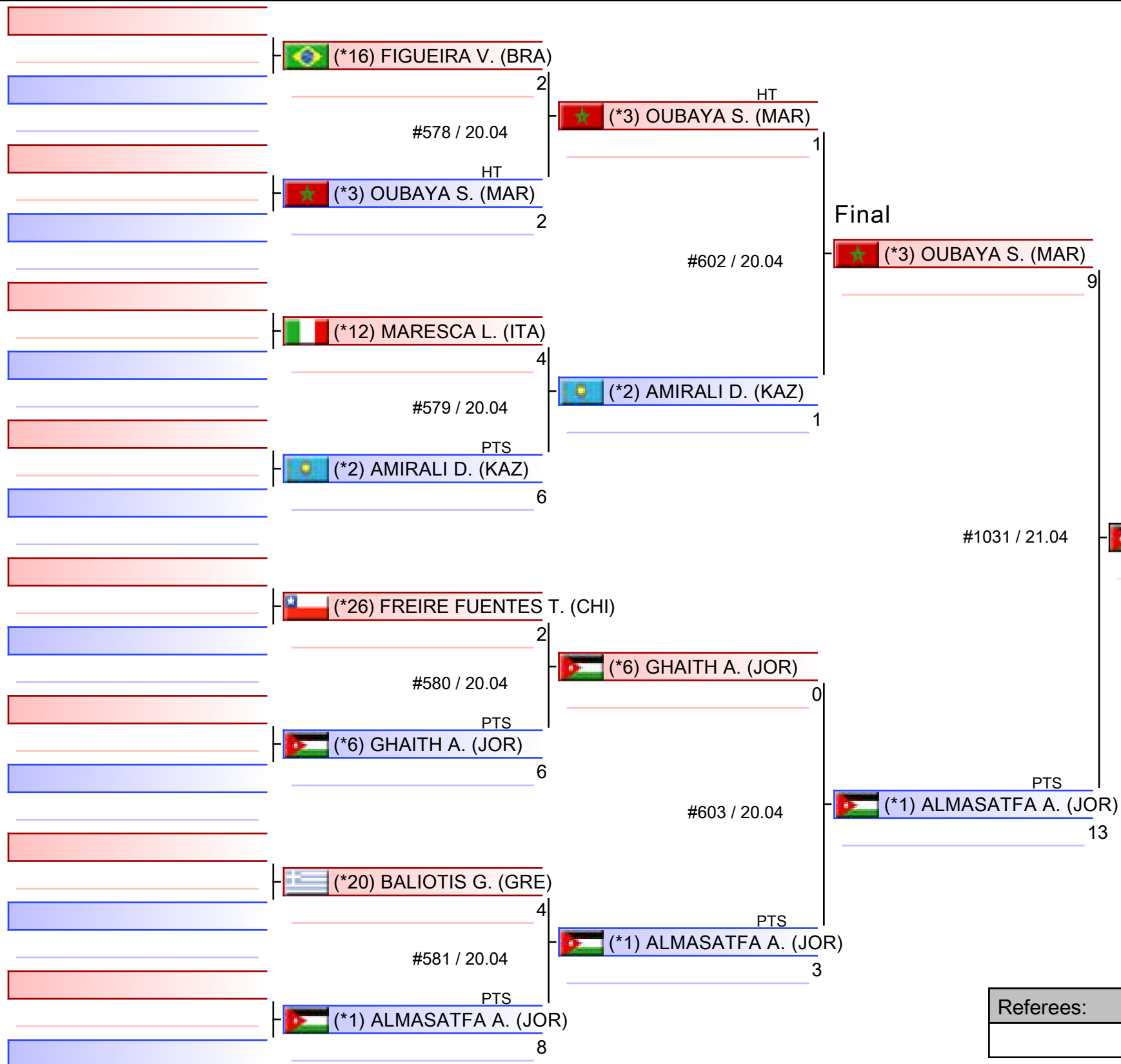

1. ALMASATFA ABDEL RAHMAN (JOR)
2. OUBAYA SAID (MAR)
3. GHAITH AFEEF (JOR)
3. FIGUEIRA VINICIUS (BRA)
5. AMIRALI DIDAR (KAZ)
5. BALIOTIS GEORGIOS (GRE)
7. MARESCA LUCA (ITA)
7. FREIRE FUENTES TOMAS (CHI)

\*Seeded

Referees:			

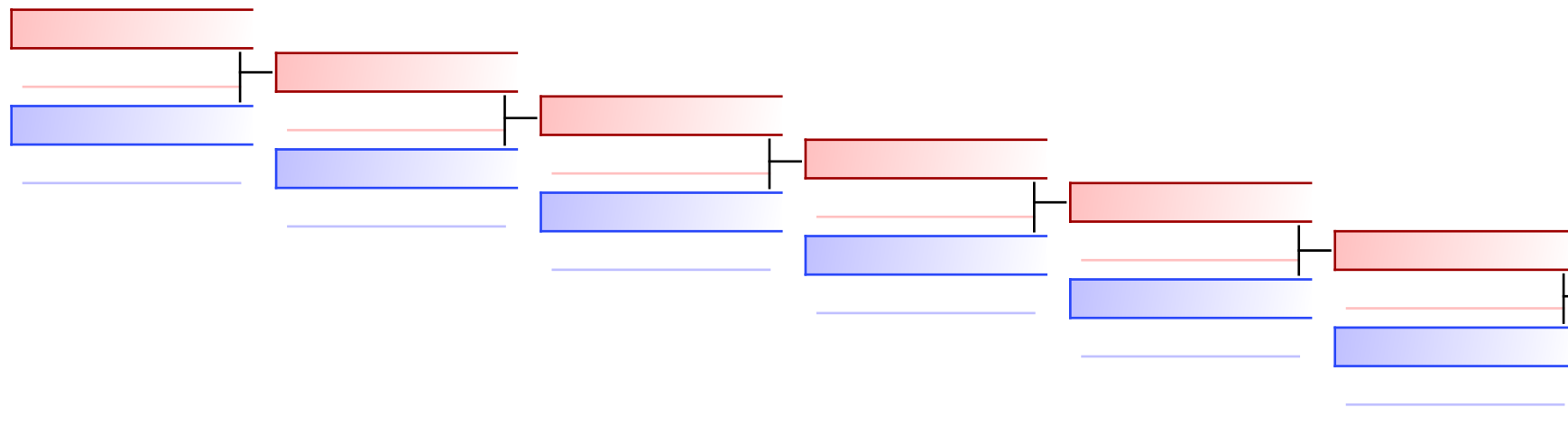

#1014

HT

FIGUEIRA VINICIUS (BRA) 0

FIGUEIRA VINICIUS (BRA)

AMIRALI DIDAR (KAZ) 0

REPECHAGE: (1,2,3,4,5,6,7,8)

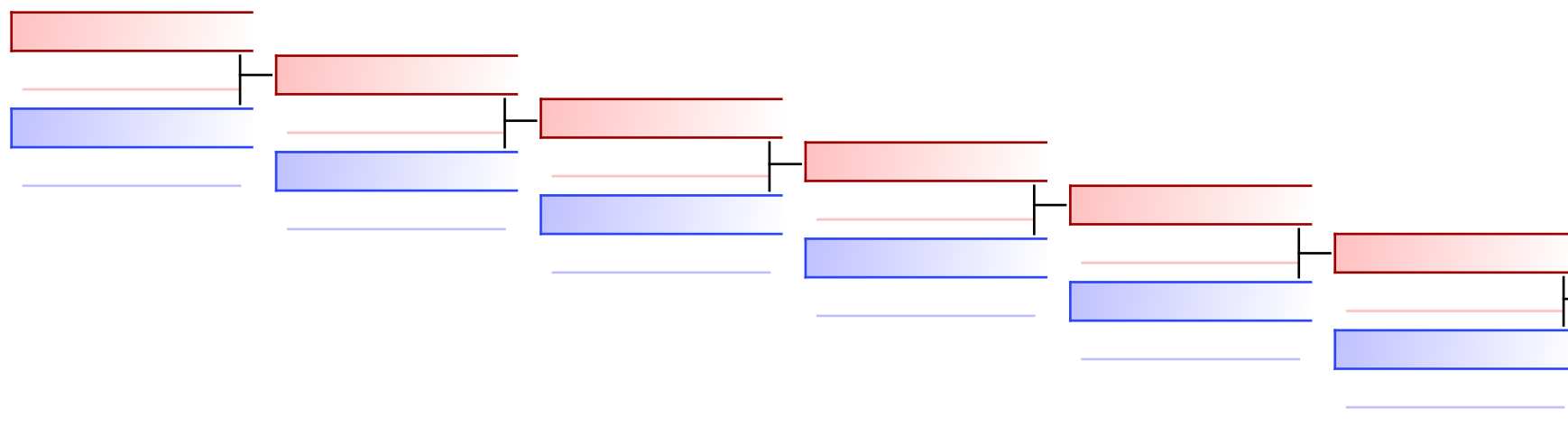

#1015 / 21.04

BALIOTIS GEORGIOS (GRE) 0

PTS GHAITH AFEEF (JOR)

GHAITH AFEEF (JOR) 3

Referees:							
-----------	--	--	--	--	--	--	--



Karate1 Premier League - Cairo 2024 - 2024-04-19



## Official Results

Male Kumite -67 Kg			
1	ALMASATFA ABDEL RAHMAN		JOR - JORDAN
2	OUBAYA SAID		MAR - MOROCCO
3	GHAITH AFEEF		JOR - JORDAN
3	FIGUEIRA VINICIUS		BRA - BRAZIL
5	AMIRALI DIDAR		KAZ - KAZAKHSTAN
5	BALLOTIS GEORGIOS		GRE - GREECE
7	MARESCA LUCA		ITA - ITALY
7	FREIRE FUENTES TOMAS		CHI - CHILE

# MALE KUMITE -75 KG



Karate1 Premier League - Cairo 2024  
**ENTRIES BY WEIGHT CATEGORY**



**Male Kumite -75 Kg**

As of 21 APR 2024

NOC Code	Gender	Name	Seeding
ALG	M	ZAID OUSSAMA	17
AUT	M	POKORNY STEFAN	13
AZE	M	AGHAYEV FARID	20
BEL	M	MAHAUDEN QUENTIN	3
BIH	M	TURULJA HAMZA	14
CHI	M	RODRIGUEZ FUENTES MATIAS	18
EGY	M	Abdelaziz Abdalla	1
EGY	M	Abdelgawad ABDALLA HESHAM	15
EGY	M	FARAG YOUSSEF	22
FRA	M	BERTHON ENZO	4
FRA	M	CIZO KILIAN	26
FRA	M	LE THANH LIEM	25
GEO	M	PONIAVA VALIKO	27
ITA	M	DE VIVO DANIELE	12
ITA	M	Iannuzzi Mario	29
ITA	M	Pietromarchi Lorenzo	7
ITA	M	Rossi Joseph	24
JOR	M	MASARWEH HASAN	10
JPN	M	Sakiyama Yusei	11
JPN	M	Suzuki Shunji	23
KAZ	M	AZHIKANOV NURKANAT	9
LBA	M	ABUDABOVS MOHAMED	16
MKD	M	ZABORSKI PETAR	19
SWE	M	HAAG RICKY	21
TUR	M	BULUT ENES	6
TUR	M	YURUR OMER FARUK	8
UKR	M	CHERNIAIEV OLEKSANDR	28
UKR	M	Karas Oleksandr	30
UKR	M	Pitsul Heorhii	5
UKR	M	ZAPLITNYI ANDRII	2

# Male Kumite -75 Kg - Round Robin (each against each)

Karate1 Premier League - Cairo 2024, Cairo, EGY

Tatami

Pool  
1/8

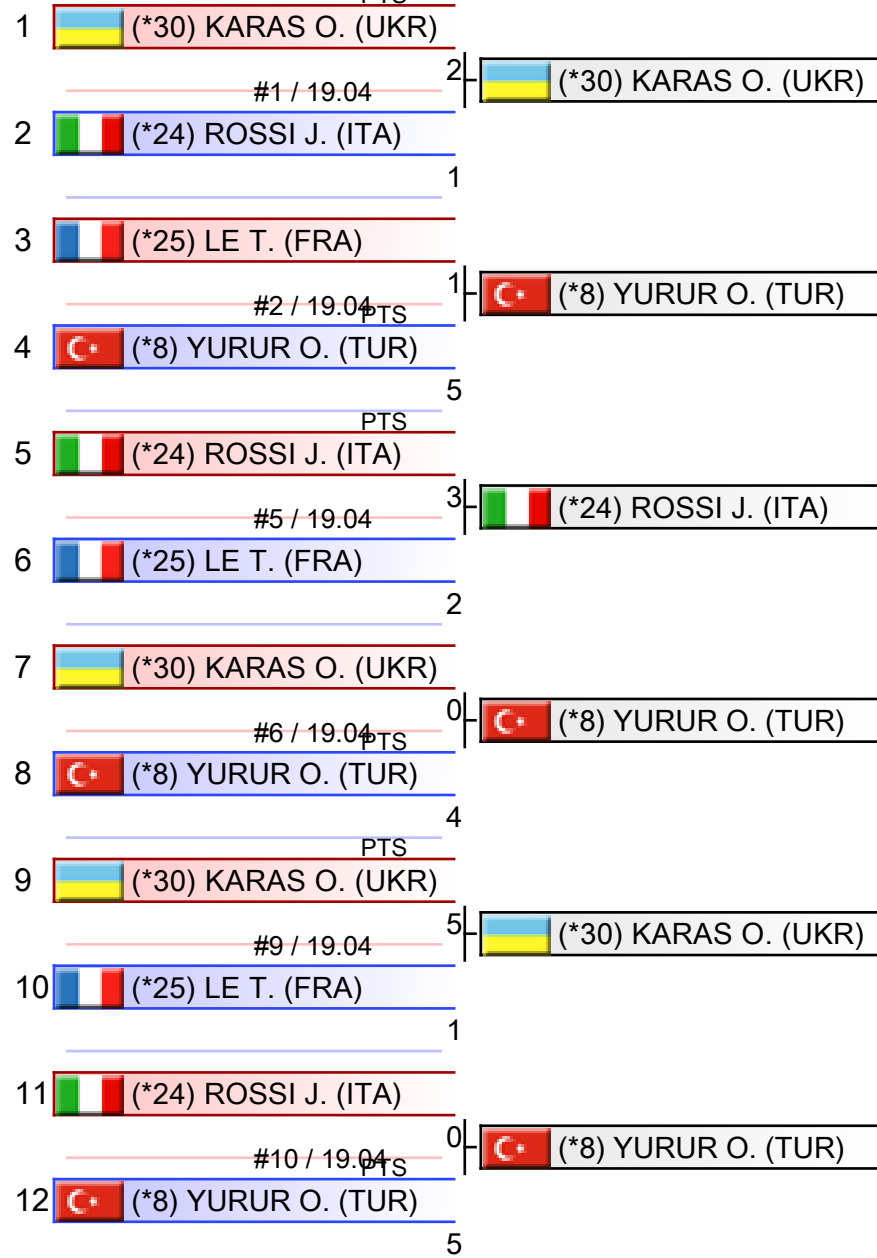

1. YURUR OMER FARUK (TUR)
2. KARAS OLEKSANDR (UKR)
3. ROSSI JOSEPH (ITA)
4. LE THANH LIEM (FRA)



1. ABDELAZIZ ABDALLA (EGY)
2. YURUR OMER FARUK (TUR)
3. BERTHON ENZO (FRA)
3. FARAG YOUSSEF (EGY)
5. SAKIYAMA YUSEI (JPN)
5. TURULJA HAMZA (BIH)
7. ZAPLITNYI ANDRII (UKR)
7. PIETROMARCHI LORENZO (ITA)

\*Seeded

Referees:			



# Male Kumite -75 Kg - Round Robin (each against each)

Karate1 Premier League - Cairo 2024, Cairo, EGY

Tatami

Pool  
2/8

1	(*11) SAKIYAMA Y. (JPN)	#3 / 19.04	1	(*11) SAKIYAMA Y. (JPN)
2	(*6) BULUT E. (TUR)		0	
		PTS		
3	(*13) POKORNY S. (AUT)	#4 / 19.04	6	(*13) POKORNY S. (AUT)
4	(*3) MAHAUDEN Q. (BEL)		3	
		PTS		
5	(*6) BULUT E. (TUR)	#7 / 19.04	2	(*6) BULUT E. (TUR)
6	(*13) POKORNY S. (AUT)		0	
		PTS		
7	(*11) SAKIYAMA Y. (JPN)	#8 / 19.04	6	(*11) SAKIYAMA Y. (JPN)
8	(*3) MAHAUDEN Q. (BEL)		3	
		PTS		
9	(*11) SAKIYAMA Y. (JPN)	#11 / 19.04	0	
10	(*13) POKORNY S. (AUT)		0	
		PTS		
11	(*6) BULUT E. (TUR)	#12 / 19.04	3	(*6) BULUT E. (TUR)
12	(*3) MAHAUDEN Q. (BEL)		1	

1. SAKIYAMA YUSEI (JPN)
2. BULUT ENES (TUR)
3. POKORNY STEFAN (AUT)
4. MAHAUDEN QUENTIN (BEL)



1. ABDELAZIZ ABDALLA (EGY)
2. YURUR OMER FARUK (TUR)
3. BERTHON ENZO (FRA)
3. FARAG YOUSSEF (EGY)
5. SAKIYAMA YUSEI (JPN)
5. TURULJA HAMZA (BIH)
7. ZAPLITNYI ANDRII (UKR)
7. PIETROMARCHI LORENZO (ITA)

\*Seeded

Referees:			

# Male Kumite -75 Kg - Round Robin (each against each)

Karate1 Premier League - Cairo 2024, Cairo, EGY

Tatami

Pool

3/8

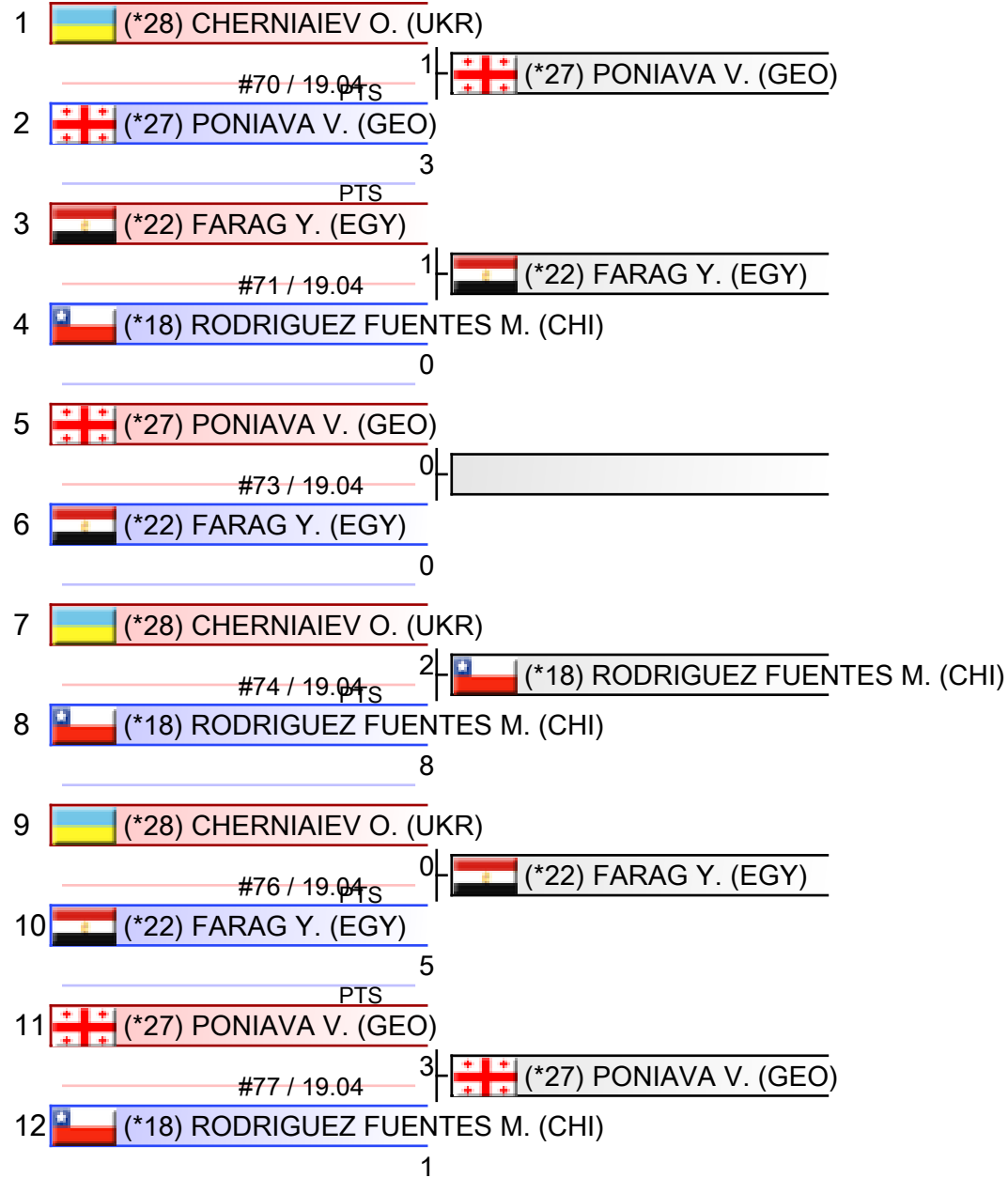

1. FARAG YOUSSEF (EGY)
2. PONIAVA VALIKO (GEO)
3. RODRIGUEZ FUENTES MATIAS (CHI)
4. CHERNIAIEV OLEKSANDR (UKR)



1. ABDELAZIZ ABDALLA (EGY)
2. YURUR OMER FARUK (TUR)
3. BERTHON ENZO (FRA)
3. FARAG YOUSSEF (EGY)
5. SAKIYAMA YUSEI (JPN)
5. TURULJA HAMZA (BIH)
7. ZAPLITNYI ANDRII (UKR)
7. PIETROMARCHI LORENZO (ITA)

\*Seeded







Referees:			

# Male Kumite -75 Kg - Round Robin (each against each)

Karate1 Premier League - Cairo 2024, Cairo, EGY

Tatami

Pool  
4/8

1	 (*21) HAAG R. (SWE)	
	#72 / 19.04	1
2	 (*10) MASARWEH H. (JOR)	
		1
3	 (*21) HAAG R. (SWE)	
	#78 / 19.04	1
4	 (*2) ZAPLITNYI A. (UKR)	
		1
5	 (*10) MASARWEH H. (JOR)	
	#75 / 19.04	1
6	 (*2) ZAPLITNYI A. (UKR)	
		1

1. ZAPLITNYI ANDRII (UKR)
2. MASARWEH HASAN (JOR)
3. HAAG RICKY (SWE)



1. ABDELAZIZ ABDALLA (EGY)
2. YURUR OMER FARUK (TUR)
3. BERTHON ENZO (FRA)
3. FARAG YOUSSEF (EGY)
5. SAKIYAMA YUSEI (JPN)
5. TURULJA HAMZA (BIH)
7. ZAPLITNYI ANDRII (UKR)
7. PIETROMARCHI LORENZO (ITA)

\*Seeded

Referees:			

# Male Kumite -75 Kg - Round Robin (each against each)

Karate1 Premier League - Cairo 2024, Cairo, EGY

Tatami

Pool  
5/8

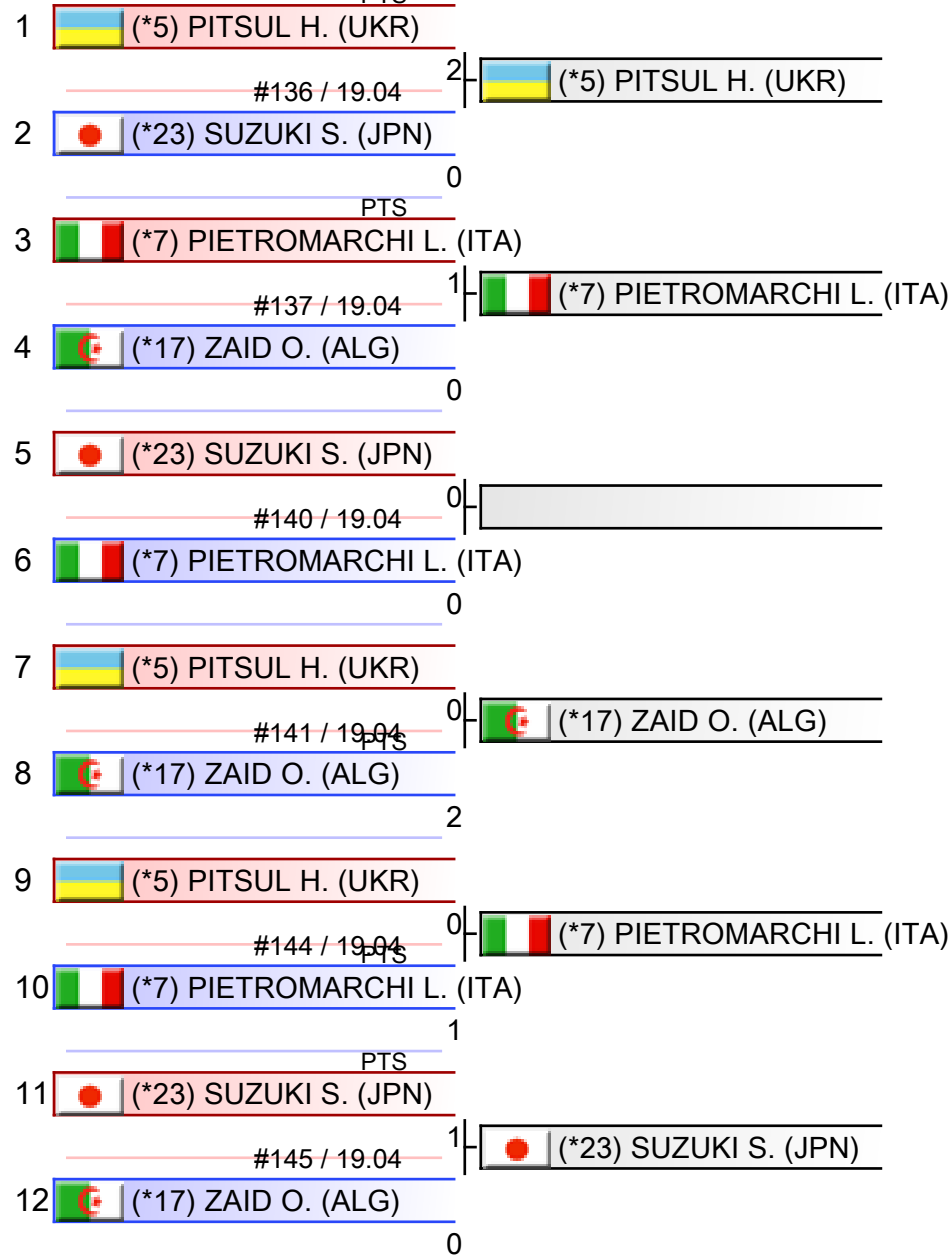

1. PIETROMARCHI LORENZO (ITA)
2. ZAID OUSSAMA (ALG)
3. PITSUL HEORHII (UKR)
4. SUZUKI SHUNJI (JPN)



1. ABDELAZIZ ABDALLA (EGY)
2. YURUR OMER FARUK (TUR)
3. BERTHON ENZO (FRA)
3. FARAG YOUSSEF (EGY)
5. SAKIYAMA YUSEI (JPN)
5. TURULJA HAMZA (BIH)
7. ZAPLITNYI ANDRII (UKR)
7. PIETROMARCHI LORENZO (ITA)

\*Seeded



















Referees:			

# Male Kumite -75 Kg - Round Robin (each against each)

Karate1 Premier League - Cairo 2024, Cairo, EGY

Tatami

Pool  
6/8

1	 (*19) ZABORSKI P. (MKD)	2	 (*19) ZABORSKI P. (MKD)
	#138 / 19.04		
2	 (*16) ABUDABOUS M. (LBA)	1	
3	 (*15) ABDELGAWAD A. (EGY)	2	 (*4) BERTHON E. (FRA)
	#139 / 19.04		
4	 (*4) BERTHON E. (FRA)	4	
5	 (*16) ABUDABOUS M. (LBA)	0	 (*15) ABDELGAWAD A. (EGY)
	#142 / 19.04		
6	 (*15) ABDELGAWAD A. (EGY)	6	
7	 (*19) ZABORSKI P. (MKD)	0	 (*4) BERTHON E. (FRA)
	#143 / 19.04		
8	 (*4) BERTHON E. (FRA)	2	
9	 (*19) ZABORSKI P. (MKD)	1	 (*15) ABDELGAWAD A. (EGY)
	#146 / 19.04		
10	 (*15) ABDELGAWAD A. (EGY)	3	
11	 (*16) ABUDABOUS M. (LBA)	4	 (*4) BERTHON E. (FRA)
	#147 / 19.04		
12	 (*4) BERTHON E. (FRA)	6	



1. BERTHON ENZO (FRA)
2. ABDELGAWAD ABDALLA HESHAM (EGY)
3. ZABORSKI PETAR (MKD)
4. ABUDABOUS MOHAMED (LBA)

1. ABDELAZIZ ABDALLA (EGY)
2. YURUR OMER FARUK (TUR)
3. BERTHON ENZO (FRA)
3. FARAG YOUSSEF (EGY)
5. SAKIYAMA YUSEI (JPN)
5. TURULJA HAMZA (BIH)
7. ZAPLITNYI ANDRII (UKR)
7. PIETROMARCHI LORENZO (ITA)

\*Seeded















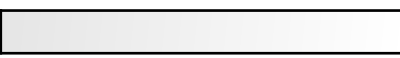

Referees:			

# Male Kumite -75 Kg - Round Robin (each against each)

Karate1 Premier League - Cairo 2024, Cairo, EGY

Tatami

Pool  
7/8

1	 (*14) TURULJA H. (BIH)	
	#208 / 19.04	1    (*14) TURULJA H. (BIH)
2	 (*20) AGHAYEV F. (AZE)	0
	PTS	
3	 (*26) CIZO K. (FRA)	
	#209 / 19.04	2    (*26) CIZO K. (FRA)
4	 (*29) IANNUZZI M. (ITA)	0
5	 (*20) AGHAYEV F. (AZE)	
	#211 / 19.04	2   
6	 (*26) CIZO K. (FRA)	2
	PTS	
7	 (*14) TURULJA H. (BIH)	
	#212 / 19.04	1    (*14) TURULJA H. (BIH)
8	 (*29) IANNUZZI M. (ITA)	0
	PTS	
9	 (*14) TURULJA H. (BIH)	
	#214 / 19.04	1    (*14) TURULJA H. (BIH)
10	 (*26) CIZO K. (FRA)	0
	PTS	
11	 (*20) AGHAYEV F. (AZE)	
	#215 / 19.04	3    (*20) AGHAYEV F. (AZE)
12	 (*29) IANNUZZI M. (ITA)	1

1. TURULJA HAMZA (BIH)
2. AGHAYEV FARID (AZE)
3. CIZO KILIAN (FRA)
4. IANNUZZI MARIO (ITA)



1. ABDELAZIZ ABDALLA (EGY)
2. YURUR OMER FARUK (TUR)
3. BERTHON ENZO (FRA)
3. FARAG YOUSSEF (EGY)
5. SAKIYAMA YUSEI (JPN)
5. TURULJA HAMZA (BIH)
7. ZAPLITNYI ANDRII (UKR)
7. PIETROMARCHI LORENZO (ITA)

\*Seeded

Referees:			

# Male Kumite -75 Kg - Round Robin (each against each)

Karate1 Premier League - Cairo 2024, Cairo, EGY

Tatami

Pool  
8/8

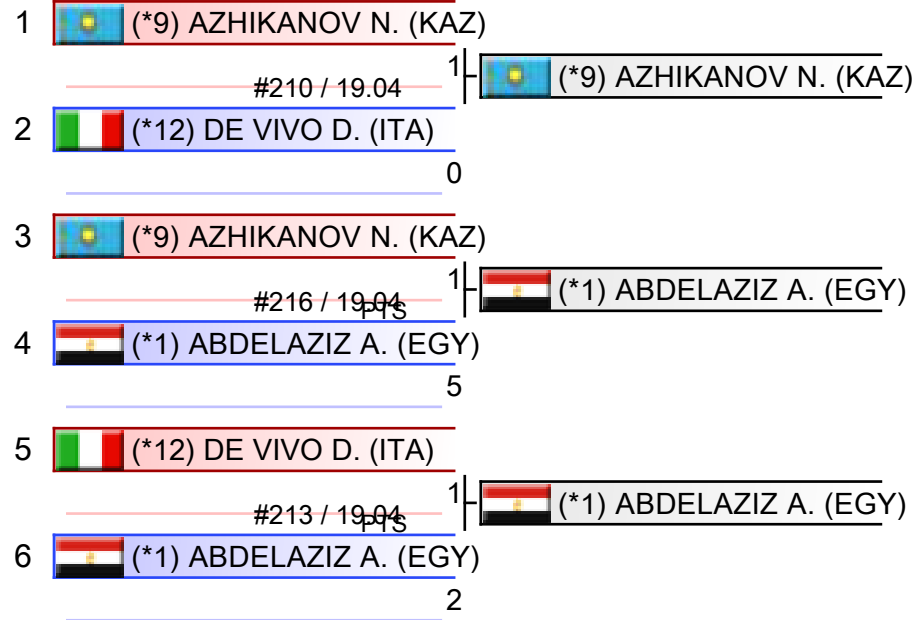

1. ABDELAZIZ ABDALLA (EGY)
2. AZHIKANOV NURKANAT (KAZ)
3. DE VIVO DANIELE (ITA)



1. ABDELAZIZ ABDALLA (EGY)
2. YURUR OMER FARUK (TUR)
3. BERTHON ENZO (FRA)
3. FARAG YOUSSEF (EGY)
5. SAKIYAMA YUSEI (JPN)
5. TURULJA HAMZA (BIH)
7. ZAPLITNYI ANDRII (UKR)
7. PIETROMARCHI LORENZO (ITA)

\*Seeded

Referees:			

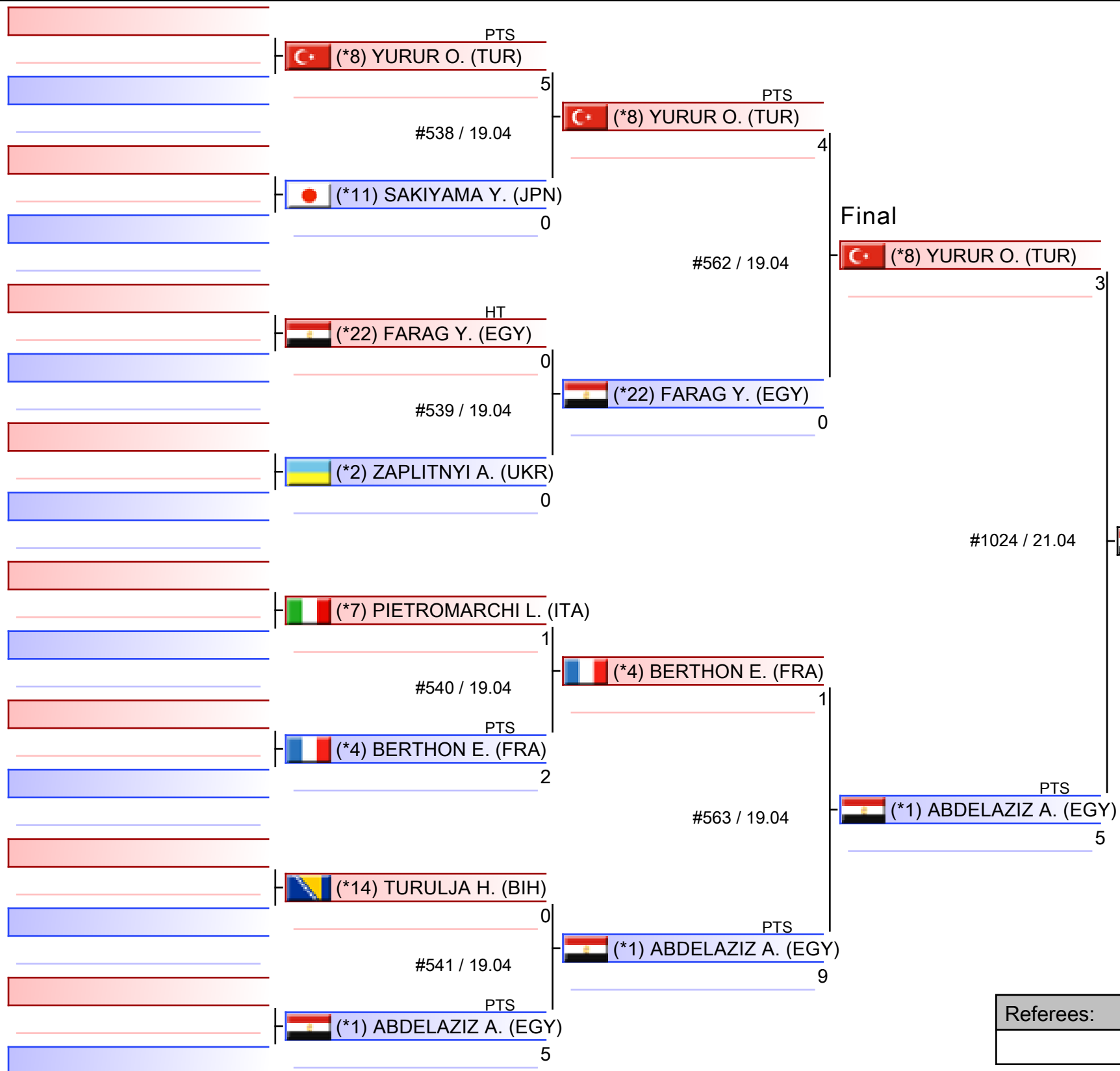

1. ABDELAZIZ ABDALLA (EGY)
2. YURUR OMER FARUK (TUR)
3. BERTHON ENZO (FRA)
3. FARAG YOUSSEF (EGY)
5. SAKIYAMA YUSEI (JPN)
5. TURULJA HAMZA (BIH)
7. ZAPLITNYI ANDRII (UKR)
7. PIETROMARCHI LORENZO (ITA)

\*Seeded

Referees:			



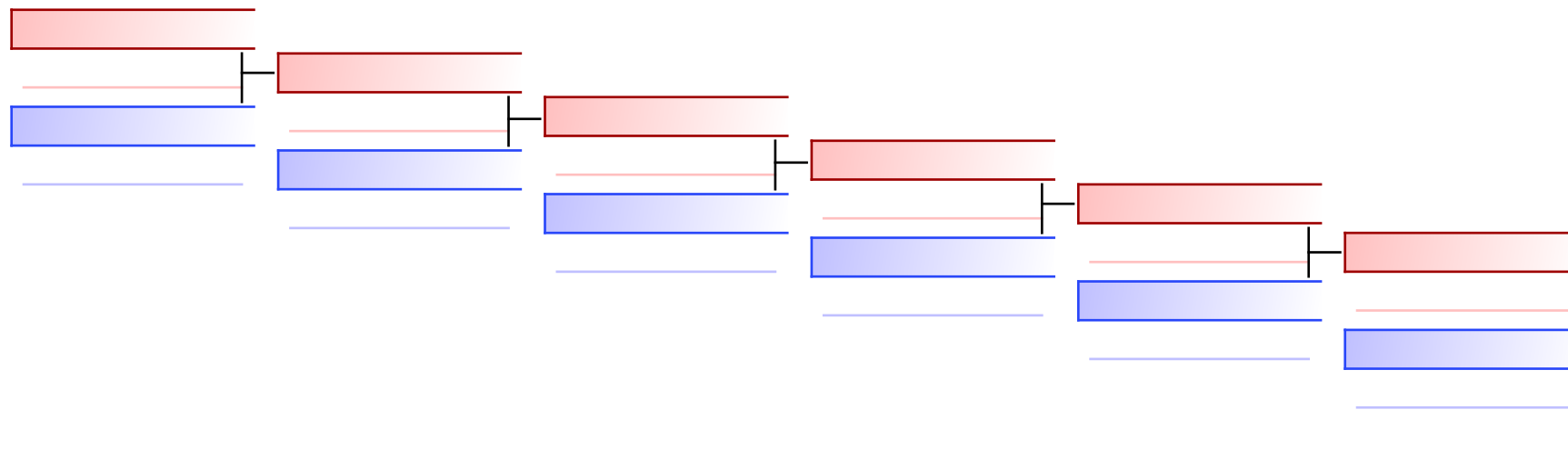

#1000

Sakiyama Yusei (JPN) 1  
 PTS | FARAG YOUSSEF (EGY) 1  
 FARAG YOUSSEF (EGY) 2

REPECHAGE: (1,2,3,4,5,6,7,8)

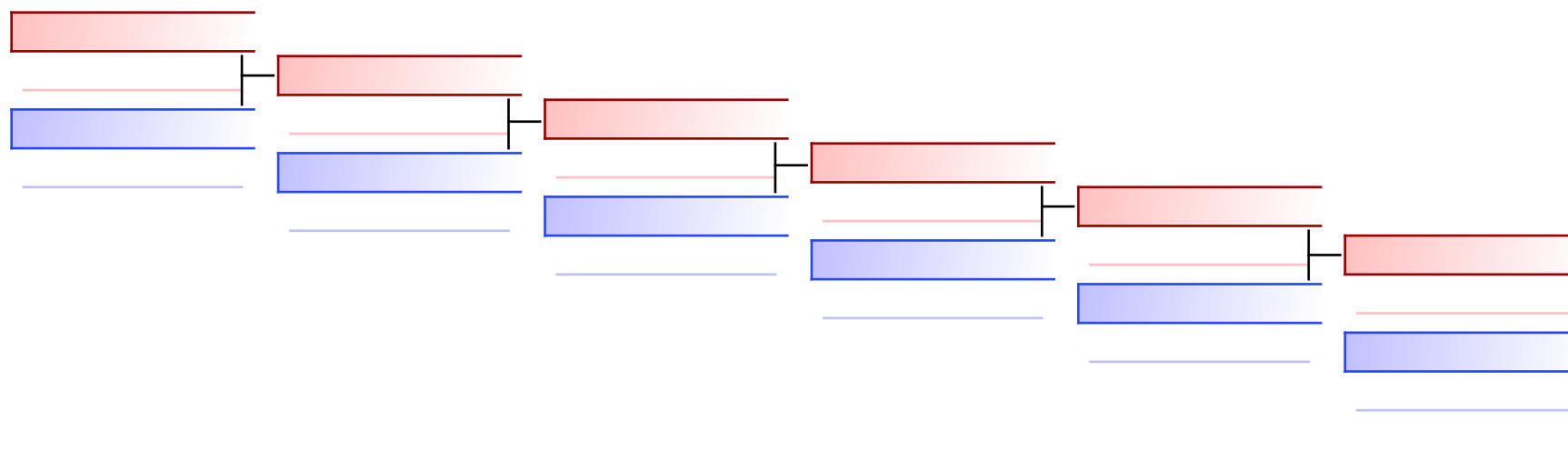

#1001 / 21.04

TURULJA HAMZA (BIH) 2  
 PTS | BERTHON ENZO (FRA) 2  
 BERTHON ENZO (FRA) 4

Referees:							
-----------	--	--	--	--	--	--	--



Karate1 Premier League - Cairo 2024 - 2024-04-19



## Official Results

Male Kumite -75 Kg			
1	ABDELAZIZ ABDALLA		EGY - EGYPT
2	YURUR OMER FARUK		TUR - TURKIYE
3	BERTHON ENZO		FRA - FRANCE
3	FARAG YOUSSEF		EGY - EGYPT
5	SAKIYAMA YUSEI		JPN - JAPAN
5	TURULJA HAMZA		BIH - BOSNIA AND HERZEGOVINA
7	ZAPLITNYI ANDRII		UKR - UKRAINE
7	PIETROMARCHI LORENZO		ITA - ITALY

# MALE KUMITE -84 KG



Karate1 Premier League - Cairo 2024  
**ENTRIES BY WEIGHT CATEGORY**



**Male Kumite -84 Kg**

As of 21 APR 2024

NOC Code	Gender	Name	Seeding
ALB	M	GASHI MELOS	15
ALG	M	MIDOUNE FALLEH	16
AZE	M	HASANOV TURGUT	24
CRO	M	GARIBOVIC ENES	11
CRO	M	KVESIC IVAN	10
EGY	M	Badawy Youssef	2
ESP	M	Perez Luque Victor	31
FIN	M	Kulovuori Bjorn	21
FIN	M	Mantere Niko	23
FRA	M	ABDESSELEM RAYBAK	19
FRA	M	MARQUES Adrien	30
GEO	M	KIPAROIDZE KHVICHA	26
GRE	M	MASTROGIANNIS KONSTANTINOS	6
ITA	M	FIORE MATTEO	9
ITA	M	MARTINA MICHELE	3
JOR	M	ALJAFARI MOHAMMAD	1
JPN	M	ETO JUNYA	13
JPN	M	Mori Yuta	29
JPN	M	Shimada Rikito	5
KAZ	M	YULDASHEV DANIYAR	12
MAR	M	SRITI MEHDI	18
MKD	M	Spasenovski Petar	25
MNE	M	MALOVIC NIKOLA	14
NED	M	Timmermans Brian	7
POL	M	FLORCZAK MICHAL	20
SVK	M	Smoliga Julian Enrik	27
TUR	M	AKTAS UGUR	28
TUR	M	ARSLAN HASAN	8
UKR	M	CHOBOTAR VALERII	4
UKR	M	SONNYKH VALERII	17
UKR	M	TOROSHANKO ANDRII	22
UKR	M	TSYMBAL KOSTIANTYN	32

# Male Kumite -84 Kg - Round Robin (each against each)

Karate1 Premier League - Cairo 2024, Cairo, EGY

Tatami

Pool

1/8

1	(*11) GARIBOVIC E. (CRO)	#58 / 19.04	2	(*11) GARIBOVIC E. (CRO)
2	(*32) TSYMBAL K. (UKR)	0		
		PTS		
3	(*25) SPASENOVSKI P. (MKD)	#59 / 19.04	9	(*25) SPASENOVSKI P. (MKD)
4	(*12) YULDASHEV D. (KAZ)	6		
5	(*32) TSYMBAL K. (UKR)	#62 / 19.04	1	(*25) SPASENOVSKI P. (MKD)
6	(*25) SPASENOVSKI P. (MKD)	4		
		PTS		
7	(*11) GARIBOVIC E. (CRO)	#63 / 19.04	8	(*11) GARIBOVIC E. (CRO)
8	(*12) YULDASHEV D. (KAZ)	0		
9	(*11) GARIBOVIC E. (CRO)	#66 / 19.04	1	(*25) SPASENOVSKI P. (MKD)
10	(*25) SPASENOVSKI P. (MKD)	5		
11	(*32) TSYMBAL K. (UKR)	#67 / 19.04	0	(*12) YULDASHEV D. (KAZ)
12	(*12) YULDASHEV D. (KAZ)	2		

1. SPASENOVSKI PETAR (MKD)
2. GARIBOVIC ENES (CRO)
3. YULDASHEV DANIYAR (KAZ)
4. TSYMBAL KOSTIANTYN (UKR)



1. ALJAFARI MOHAMMAD (JOR)
2. BADAWEY YOUSSEF (EGY)
3. KVESIC IVAN (CRO)
3. SONNYKH VALERII (UKR)
5. FIORE MATTEO (ITA)
5. MIDOUNE FALLEH (ALG)
7. SPASENOVSKI PETAR (MKD)
7. CHOBOTAR VALERII (UKR)

\*Seeded

Referees:			

# Male Kumite -84 Kg - Round Robin (each against each)

Karate1 Premier League - Cairo 2024, Cairo, EGY

Tatami

Pool

2/8

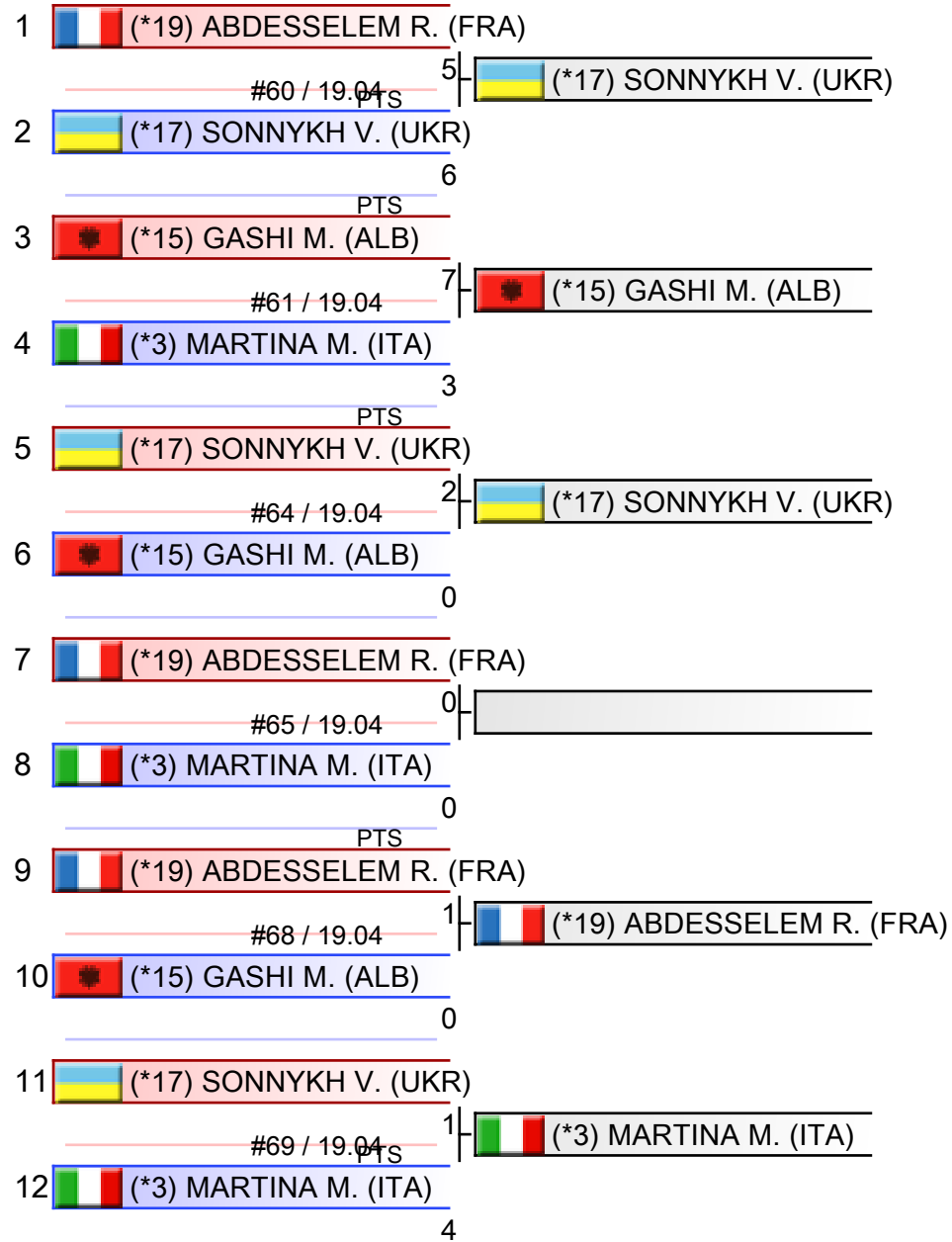

1. SONNYKH VALERII (UKR)
2. GASHI MELOS (ALB)
3. MARTINA MICHELE (ITA)
4. ABDESSELEM RAYBAK (FRA)



1. ALJAFARI MOHAMMAD (JOR)
2. BADAWEY YOUSSEF (EGY)
3. KVESIC IVAN (CRO)
3. SONNYKH VALERII (UKR)
5. FIORE MATTEO (ITA)
5. MIDOUNE FALLEH (ALG)
7. SPASENOVSKI PETAR (MKD)
7. CHOBOTAR VALERII (UKR)

\*Seeded

Referees:			

# Male Kumite -84 Kg - Round Robin (each against each)

Karate1 Premier League - Cairo 2024, Cairo, EGY

Tatami

Pool  
3/8

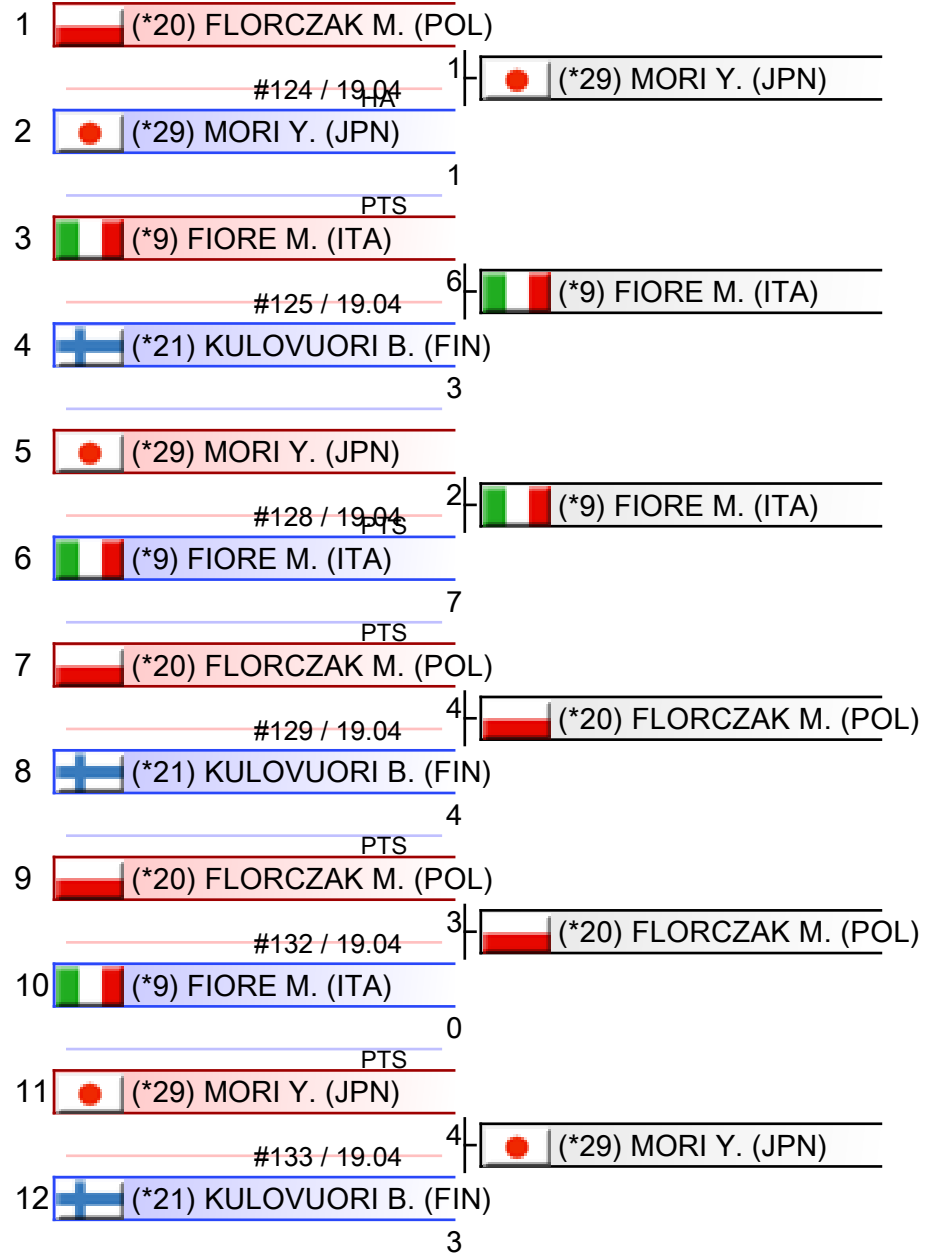

1. FIORE MATTEO (ITA)
2. MORI YUTA (JPN)
3. FLORCZAK MICHAL (POL)
4. KULOVIORI BJORN (FIN)



1. ALJAFARI MOHAMMAD (JOR)
2. BADAWEY YOUSSEF (EGY)
3. KVESIC IVAN (CRO)
3. SONNYKH VALERII (UKR)
5. FIORE MATTEO (ITA)
5. MIDOUNE FALLEH (ALG)
7. SPASENOVSKI PETAR (MKD)
7. CHOBOTAR VALERII (UKR)

\*Seeded

Referees:			

# Male Kumite -84 Kg - Round Robin (each against each)

Karate1 Premier League - Cairo 2024, Cairo, EGY

Tatami

Pool  
4/8

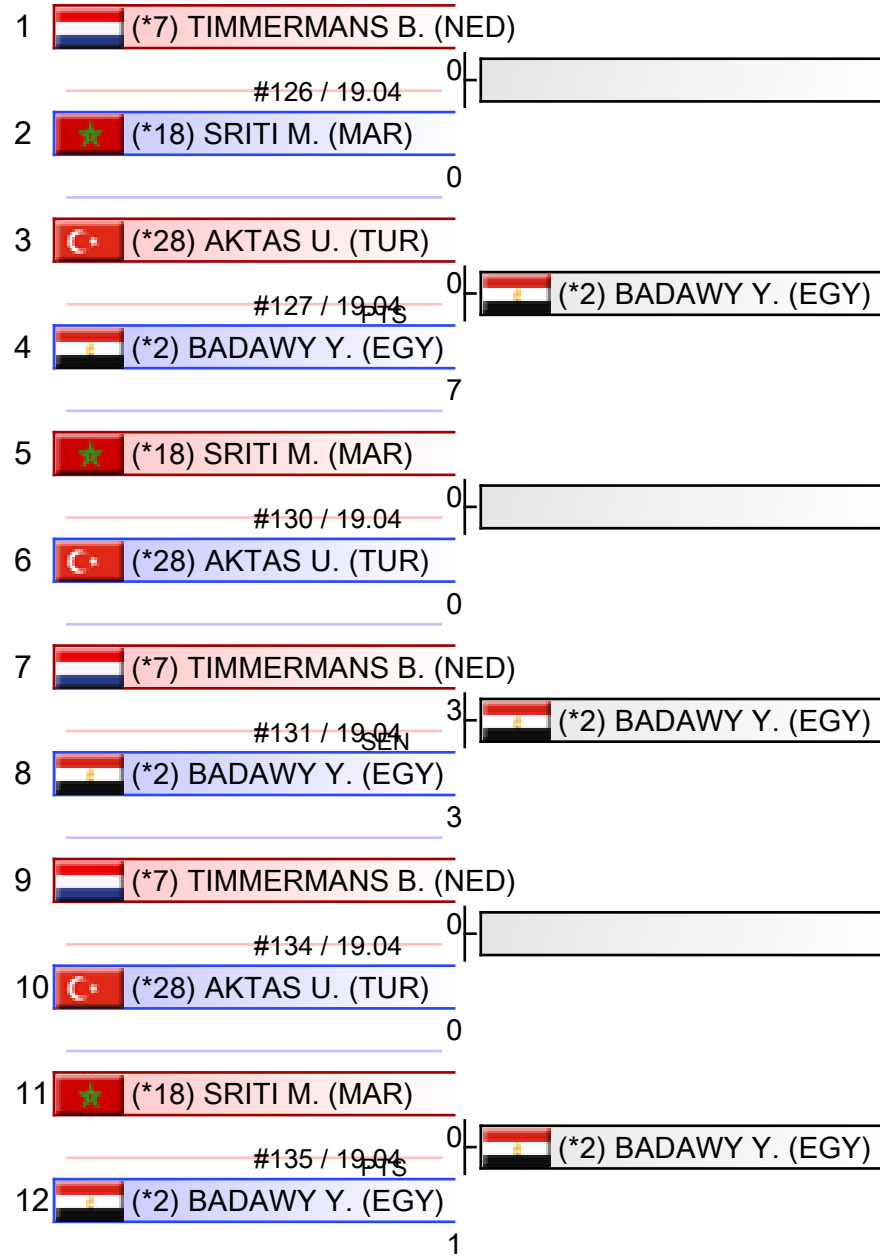

1. BADAWY YOUSSEF (EGY)
2. TIMMERMANS BRIAN (NED)
3. SRITI MEHDI (MAR)
4. AKTAS UGUR (TUR)



1. ALJAFARI MOHAMMAD (JOR)
2. BADAWY YOUSSEF (EGY)
3. KVESIC IVAN (CRO)
3. SONNYKH VALERII (UKR)
5. FIORE MATTEO (ITA)
5. MIDOUNE FALLEH (ALG)
7. SPASENOVSKI PETAR (MKD)
7. CHOBOTAR VALERII (UKR)

\*Seeded

Referees:			



# Male Kumite -84 Kg - Round Robin (each against each)

Karate1 Premier League - Cairo 2024, Cairo, EGY

Tatami

Pool

5/8

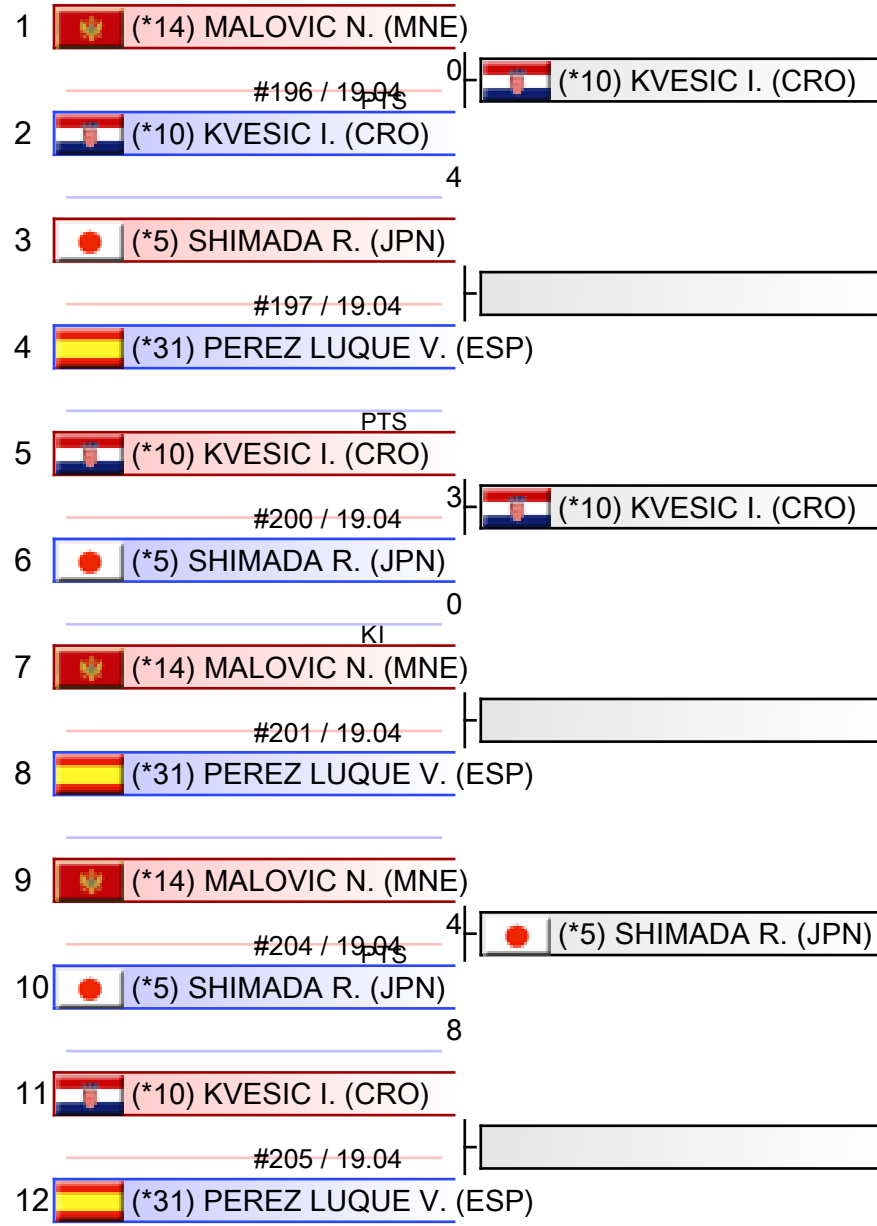

1. KVESIC IVAN (CRO)
2. SHIMADA RIKITO (JPN)
3. MALOVIC NIKOLA (MNE)
4. PEREZ LUQUE VICTOR (ESP)



1. ALJAFARI MOHAMMAD (JOR)
2. BADAWEY YOUSSEF (EGY)
3. KVESIC IVAN (CRO)
3. SONNYKH VALERII (UKR)
5. FIORE MATTEO (ITA)
5. MIDOUNE FALLEH (ALG)
7. SPASENOVSKI PETAR (MKD)
7. CHOBOTAR VALERII (UKR)

\*Seeded

Referees:			

# Male Kumite -84 Kg - Round Robin (each against each)

Karate1 Premier League - Cairo 2024, Cairo, EGY

Tatami

Pool  
6/8



1. CHOBOTAR VALERII (UKR)
2. ARSLAN HASAN (TUR)
3. MARQUES ADRIEN (FRA)
4. MANTERE NIKO (FIN)



1. ALJAFARI MOHAMMAD (JOR)
2. BADAWEY YOUSSEF (EGY)
3. KVESIC IVAN (CRO)
3. SONNYKH VALERII (UKR)
5. FIORE MATTEO (ITA)
5. MIDOUNE FALLEH (ALG)
7. SPASENOVSKI PETAR (MKD)
7. CHOBOTAR VALERII (UKR)

\*Seeded

Referees:			

# Male Kumite -84 Kg - Round Robin (each against each)

Karate1 Premier League - Cairo 2024, Cairo, EGY

Tatami

Pool

7/8

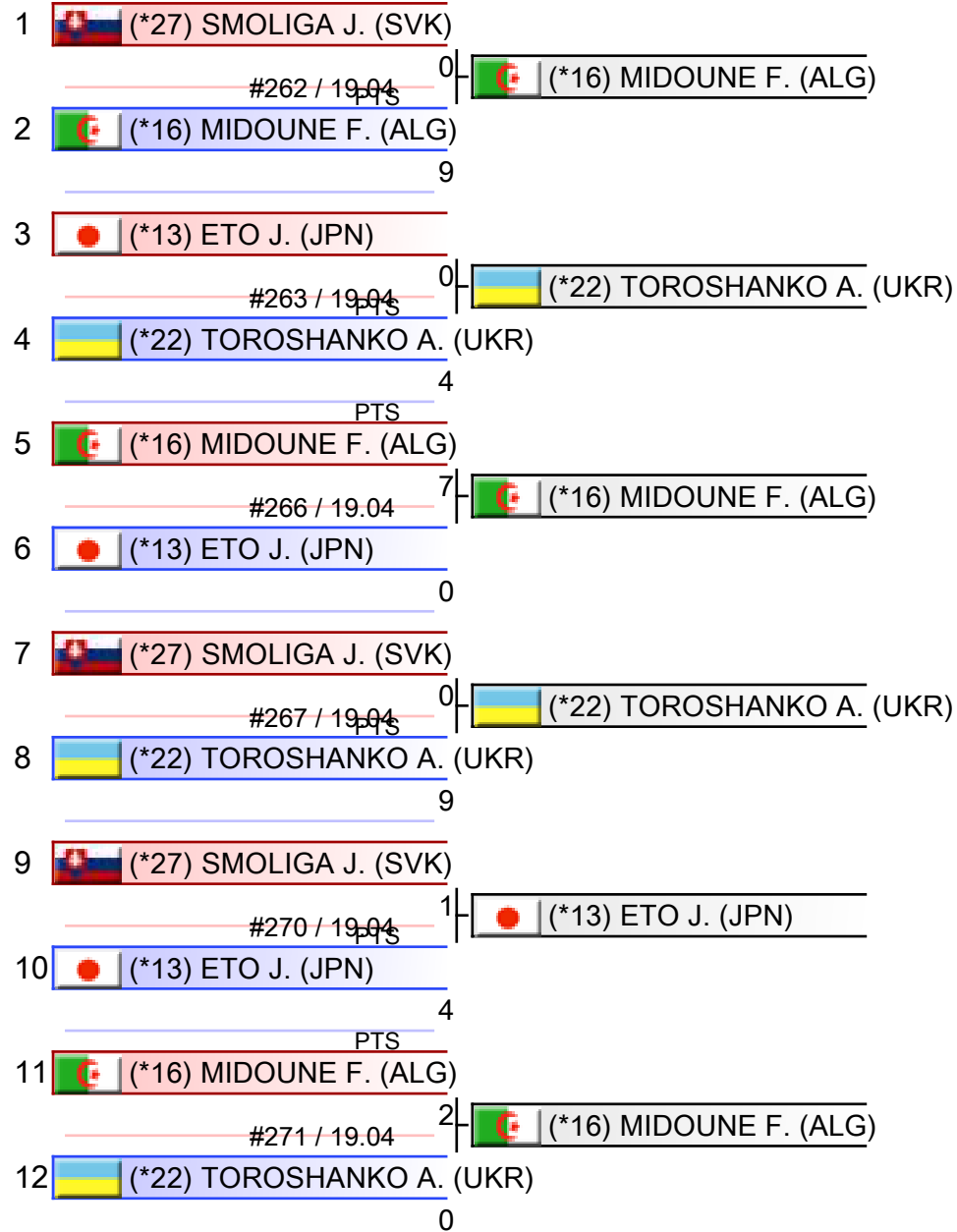

1. MIDOUNE FALLEH (ALG)
2. TOROSHANKO ANDRII (UKR)
3. ETO JUNYA (JPN)
4. SMOLIGA JULIAN ENRIK (SVK)



1. ALJAFARI MOHAMMAD (JOR)
2. BADAWEY YOUSSEF (EGY)
3. KVESIC IVAN (CRO)
3. SONNYKH VALERII (UKR)
5. FIORE MATTEO (ITA)
5. MIDOUNE FALLEH (ALG)
7. SPASENOVSKI PETAR (MKD)
7. CHOBOTAR VALERII (UKR)

\*Seeded

Referees:			

# Male Kumite -84 Kg - Round Robin (each against each)

Karate1 Premier League - Cairo 2024, Cairo, EGY

Tatami

Pool  
8/8

1	(*26) KIPAROIDZE K. (GEO)	PTS	0	(*6) MASTROGIANNIS K. (GRE)
	#264 / 19.04			
2	(*6) MASTROGIANNIS K. (GRE)	PTS	3	
	SEN			
3	(*24) HASANOV T. (AZE)	PTS	3	(*24) HASANOV T. (AZE)
	#265 / 19.04			
4	(*1) ALJAFARI M. (JOR)	PTS	3	
	PTS			
5	(*6) MASTROGIANNIS K. (GRE)	PTS	2	(*6) MASTROGIANNIS K. (GRE)
	#268 / 19.04			
6	(*24) HASANOV T. (AZE)	PTS	0	
7	(*26) KIPAROIDZE K. (GEO)	PTS	1	(*1) ALJAFARI M. (JOR)
	#269 / 19.04			
8	(*1) ALJAFARI M. (JOR)	PTS	5	
9	(*26) KIPAROIDZE K. (GEO)	PTS	2	(*24) HASANOV T. (AZE)
	#272 / 19.04			
10	(*24) HASANOV T. (AZE)	PTS	5	
11	(*6) MASTROGIANNIS K. (GRE)	PTS	0	(*1) ALJAFARI M. (JOR)
	#273 / 19.04			
12	(*1) ALJAFARI M. (JOR)	PTS	3	



1. ALJAFARI MOHAMMAD (JOR)
2. MASTROGIANNIS KONSTANTINOS (GRE)
3. HASANOV TURGUT (AZE)
4. KIPAROIDZE KHVICHA (GEO)

1. ALJAFARI MOHAMMAD (JOR)
2. BADAWEY YOUSSEF (EGY)
3. KVESIC IVAN (CRO)
3. SONNYKH VALERII (UKR)
5. FIORE MATTEO (ITA)
5. MIDOUNE FALLEH (ALG)
7. SPASENOVSKI PETAR (MKD)
7. CHOBOTAR VALERII (UKR)

\*Seeded

Referees:			

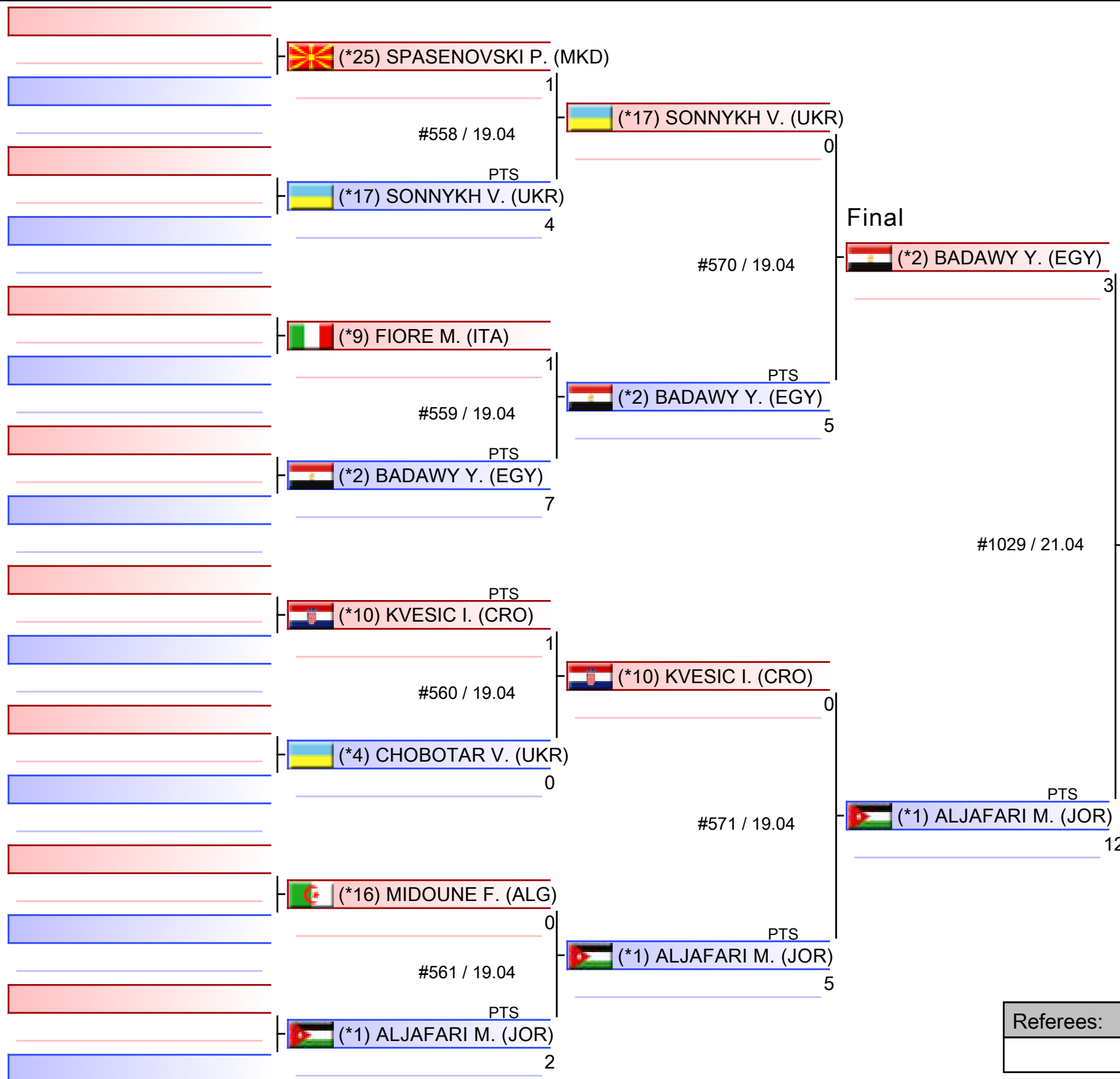

1. ALJAFARI MOHAMMAD (JOR)
2. BADAWEY YOUSSEF (EGY)
3. KVESIC IVAN (CRO)
3. SONNYKH VALERII (UKR)
5. FIORE MATTEO (ITA)
5. MIDOUNE FALLEH (ALG)
7. SPASENOVSKI PETAR (MKD)
7. CHOBOTAR VALERII (UKR)

\*Seeded

Referees:			

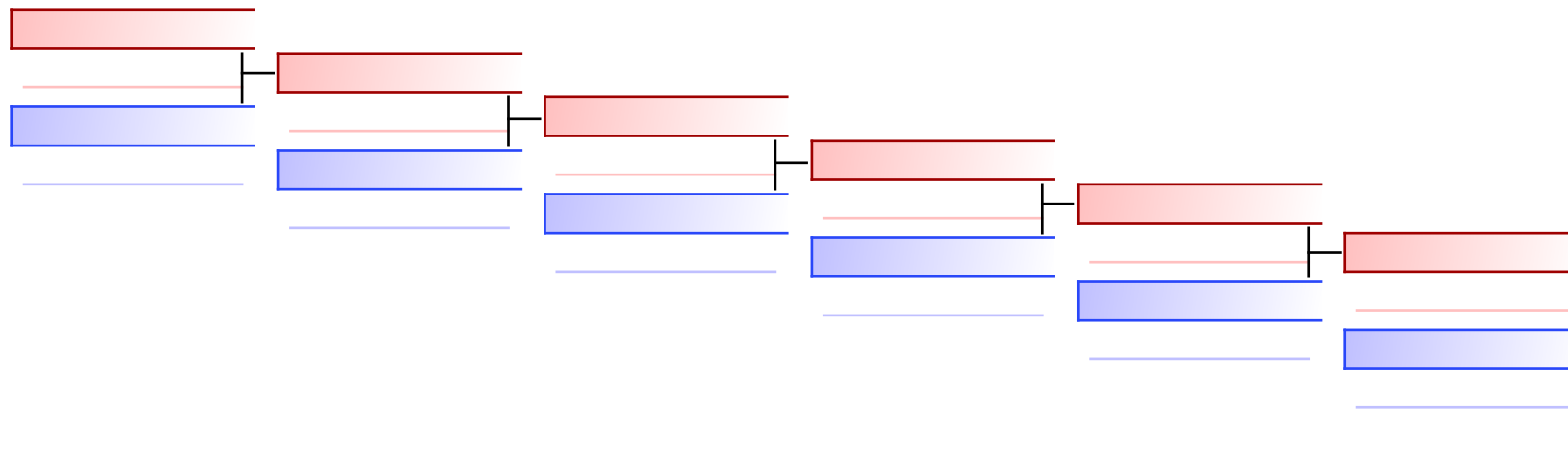

#1010

FIORE MATTEO (ITA)	3
PTS	
SONNYKH VALERII (UKR)	7

REPECHAGE: (1,2,3,4,5,6,7,8)

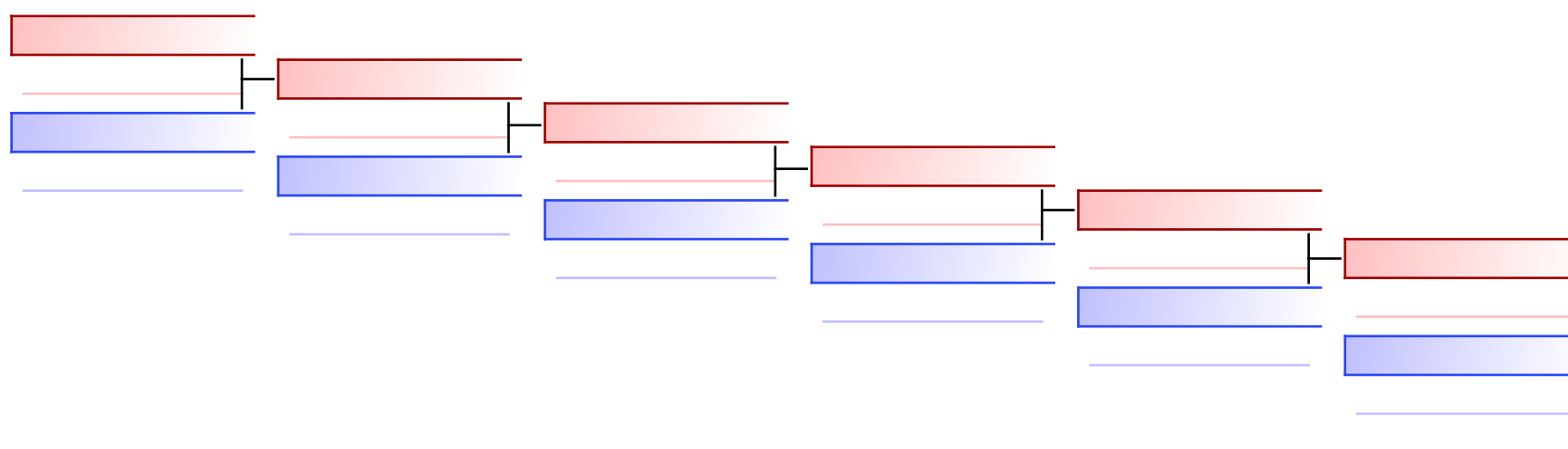

#1011 / 21.04

MIDOUNE FALLEH (ALG)	2
PTS	
KVESIC IVAN (CRO)	4

Referees:							
-----------	--	--	--	--	--	--	--



Karate1 Premier League - Cairo 2024 - 2024-04-19



## Official Results

Male Kumite -84 Kg			
1	ALJAFARI MOHAMMAD		JOR - JORDAN
2	BADAWY YOUSSEF		EGY - EGYPT
3	KVESIC IVAN		CRO - CROATIA
3	SONNYKH VALERII		UKR - UKRAINE
5	FIORE MATTEO		ITA - ITALY
5	MIDOUNE FALLEH		ALG - ALGERIA
7	SPASENOVSKI PETAR		MKD - NORTH MACEDONIA
7	CHOBOTAR VALERII		UKR - UKRAINE

# MALE KUMITE 84+ KG





Karate1 Premier League - Cairo 2024  
**ENTRIES BY WEIGHT CATEGORY**



**Male Kumite 84+ Kg**

As of 21 APR 2024

NOC Code	Gender	Name	Seeding
ALG	M	DAIKHI HOCINE	15
AZE	M	GURBANLI ASIMAN	11
AZE	M	OSMANLI OSMAN	24
BIH	M	BOSTANDZIC ANES	3
CHI	M	ROJAS RODRIGO	7
CRO	M	KVESIC ANDJELO	4
CUR	M	Timmermans Rob	5
CYP	M	STYLIANOU MATHAIOS	25
EGY	M	Badawy Mahmoud	29
EGY	M	Elmasry Ahmed	18
EGY	M	KHALIL MAHMOUD GALAL	28
EGY	M	Mahmoud Taha tarek	1
EGY	M	MOHAMED HAZEM	22
GEO	M	GELASHVILI MERABI	12
GER	M	SEKOT NIKOLAI	14
GRE	M	NIKOPOULOS ATHANASIOS	16
ITA	M	AVANZINI MATTEO	9
ITA	M	CIANI MICHELE	31
ITA	M	Forino Alessandro	30
ITA	M	GHISLANDI MICHAEL	21
ITA	M	marino simone	26
ITA	M	Mazzoleni Fabio	20
JPN	M	Yoshimura Fumiya	10
KAZ	M	ANARBEOV DIAS	17
KSA	M	SUFYANI SANAD	6
NED	M	Najdi Issam	19
TUR	M	GUNDOG UMUT EREN	23
TUR	M	KAYALI FURKAN	13
TUR	M	SEN FATIH	8
UKR	M	TALIBOV RYZVAN	2
USA	M	Sagilyan Eduard	27

# Male Kumite 84+ Kg - Round Robin (each against each)

Karate1 Premier League - Cairo 2024, Cairo, EGY

Tatami

Pool

1/8

1	(*14) SEKOT N. (GER)		
	#331 / 20.04	1	(*24) OSMANLI O. (AZE)
2	(*24) OSMANLI O. (AZE)		
	PTS	3	
3	(*30) FORINO A. (ITA)		
	#332 / 20.04	1	(*12) GELASHVILI M. (GEO)
4	(*12) GELASHVILI M. (GEO)		
	PTS	8	
5	(*24) OSMANLI O. (AZE)		
	#335 / 20.04	2	(*30) FORINO A. (ITA)
6	(*30) FORINO A. (ITA)		
	PTS	3	
7	(*14) SEKOT N. (GER)		
	#336 / 20.04	0	(*12) GELASHVILI M. (GEO)
8	(*12) GELASHVILI M. (GEO)		
	PTS	4	
9	(*14) SEKOT N. (GER)		
	#339 / 20.04	2	(*14) SEKOT N. (GER)
10	(*30) FORINO A. (ITA)		
	PTS	0	
11	(*24) OSMANLI O. (AZE)		
	#340 / 20.04	3	(*24) OSMANLI O. (AZE)
12	(*12) GELASHVILI M. (GEO)		
	PTS	3	

1. OSMANLI OSMAN (AZE)
2. GELASHVILI MERABI (GEO)
3. SEKOT NIKOLAI (GER)
4. FORINO ALESSANDRO (ITA)



1. SUFYANI SANAD (KSA)
2. MAHMOUD TAHA TAREK (EGY)
3. TIMMERMANS ROB (CUR)
3. MOHAMED HAZEM (EGY)
5. OSMANLI OSMAN (AZE)
5. DAIKHI HOCINE (ALG)
7. ROJAS RODRIGO (CHI)
7. GURBANLI ASIMAN (AZE)

\*Seeded

Referees:			

# Male Kumite 84+ Kg - Round Robin (each against each)

Karate1 Premier League - Cairo 2024, Cairo, EGY

Tatami

Pool  
2/8



1. ROJAS RODRIGO (CHI)
2. ELMASRY AHMED (EGY)
3. STYLIANOU MATHAIOS (CYP)
4. BOSTANDZIC ANES (BIH)



1. SUFYANI SANAD (KSA)
2. MAHMOUD TAHA TAREK (EGY)
3. TIMMERMANS ROB (CUR)
3. MOHAMED HAZEM (EGY)
5. OSMANLI OSMAN (AZE)
5. DAIKHI HOCINE (ALG)
7. ROJAS RODRIGO (CHI)
7. GURBANLI ASIMAN (AZE)

\*Seeded

Referees:			

# Male Kumite 84+ Kg - Round Robin (each against each)

Karate1 Premier League - Cairo 2024, Cairo, EGY

Tatami

Pool  
3/8

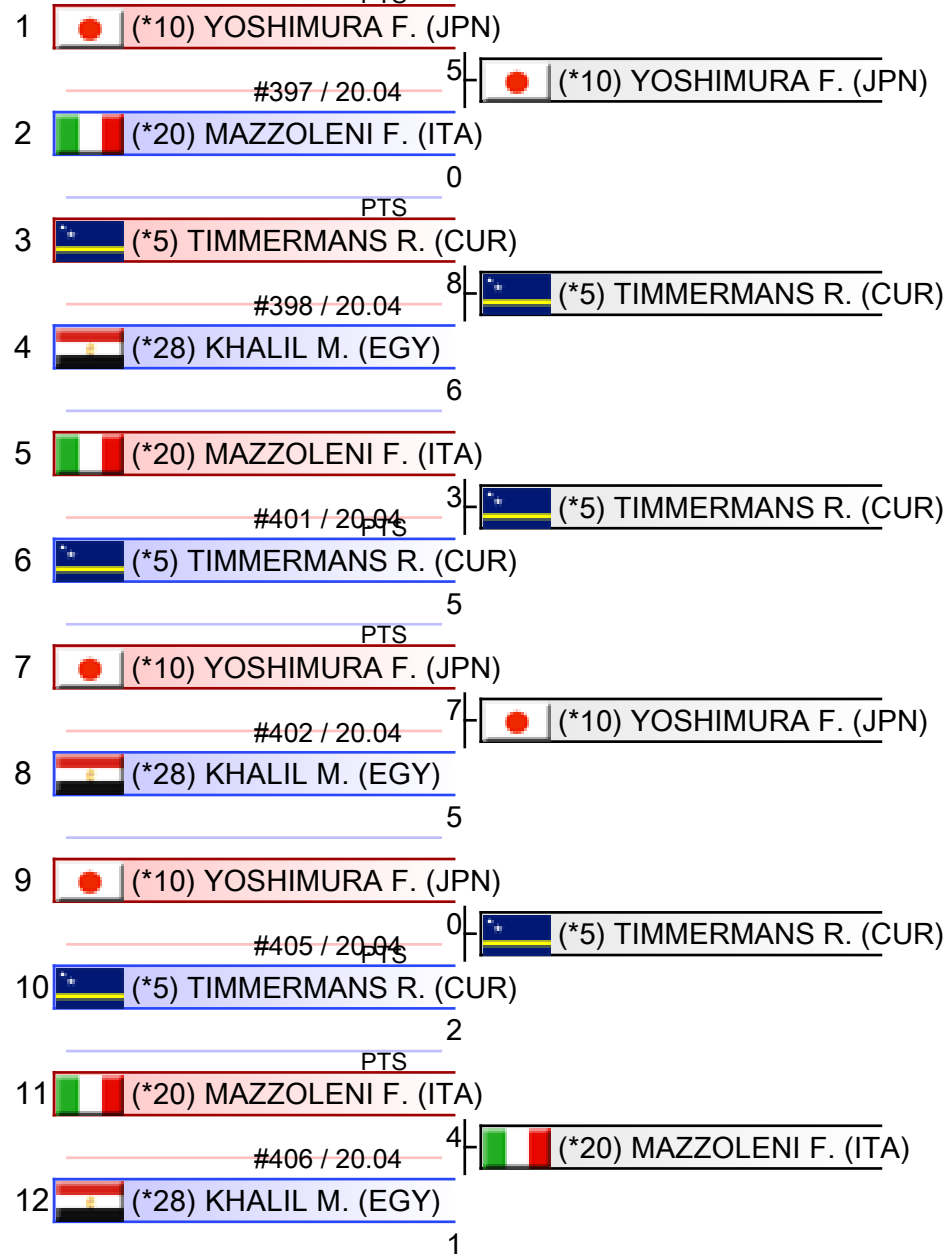

1. TIMMERMANS ROB (CUR)
2. YOSHIMURA FUMIYA (JPN)
3. MAZZOLENI FABIO (ITA)
4. KHALIL MAHMOUD GALAL (EGY)

1. SUFYANI SANAD (KSA)
2. MAHMOUD TAHA TAREK (EGY)
3. TIMMERMANS ROB (CUR)
3. MOHAMED HAZEM (EGY)
5. OSMANLI OSMAN (AZE)
5. DAIKHI HOCINE (ALG)
7. ROJAS RODRIGO (CHI)
7. GURBANLI ASIMAN (AZE)

\*Seeded

Referees:			

# Male Kumite 84+ Kg - Round Robin (each against each)

Karate1 Premier League - Cairo 2024, Cairo, EGY

Tatami

Pool  
4/8

1	(*29) BADAUWY M. (EGY)	#399 / 20.04	1	(*6) SUFYANI S. (KSA)
2	(*6) SUFYANI S. (KSA)		9	
3	(*27) SAGILYAN E. (USA)	#400 / 20.04	2	(*2) TALIBOV R. (UKR)
4	(*2) TALIBOV R. (UKR)		6	
		PTS		
5	(*6) SUFYANI S. (KSA)	#403 / 20.04	1	(*6) SUFYANI S. (KSA)
6	(*27) SAGILYAN E. (USA)		1	
		PTS		
7	(*29) BADAUWY M. (EGY)	#404 / 20.04	4	(*29) BADAUWY M. (EGY)
8	(*2) TALIBOV R. (UKR)		2	
		PTS		
9	(*29) BADAUWY M. (EGY)	#407 / 20.04	1	(*29) BADAUWY M. (EGY)
10	(*27) SAGILYAN E. (USA)		2	
		PTS		
11	(*6) SUFYANI S. (KSA)	#408 / 20.04	2	(*6) SUFYANI S. (KSA)
12	(*2) TALIBOV R. (UKR)		1	

1. SUFYANI SANAD (KSA)
2. BADAUWY MAHMOUD (EGY)
3. TALIBOV RYZVAN (UKR)
4. SAGILYAN EDUARD (USA)



1. SUFYANI SANAD (KSA)
2. MAHMOUD TAHA TAREK (EGY)
3. TIMMERMANS ROB (CUR)
3. MOHAMED HAZEM (EGY)
5. OSMANLI OSMAN (AZE)
5. DAIKHI HOCINE (ALG)
7. ROJAS RODRIGO (CHI)
7. GURBANLI ASIMAN (AZE)

\*Seeded

Referees:			

# Male Kumite 84+ Kg - Round Robin (each against each)

Karate1 Premier League - Cairo 2024, Cairo, EGY

Tatami

Pool

5/8

1	(*8) SEN F. (TUR)	
	#469 / 20.04	2    (*9) AVANZINI M. (ITA)
2	(*9) AVANZINI M. (ITA)	
	PTS	3
3	(*11) GURBANLI A. (AZE)	
	#470 / 20.04	1    (*11) GURBANLI A. (AZE)
4	(*16) NIKOPOULOS A. (GRE)	
		0
5	(*9) AVANZINI M. (ITA)	
	#473 / 20.04	3    (*11) GURBANLI A. (AZE)
6	(*11) GURBANLI A. (AZE)	
		3
7	(*8) SEN F. (TUR)	
	#474 / 20.04	0    (*16) NIKOPOULOS A. (GRE)
8	(*16) NIKOPOULOS A. (GRE)	
		0
9	(*8) SEN F. (TUR)	
	#477 / 20.04	0    (*16) NIKOPOULOS A. (GRE)
10	(*11) GURBANLI A. (AZE)	
		0
	PTS	
11	(*9) AVANZINI M. (ITA)	
	#478 / 20.04	2    (*9) AVANZINI M. (ITA)
12	(*16) NIKOPOULOS A. (GRE)	
		1

1. GURBANLI ASIMAN (AZE)
2. AVANZINI MATTEO (ITA)
3. SEN FATIH (TUR)
4. NIKOPOULOS ATHANASIOS (GRE)



1. SUFYANI SANAD (KSA)
2. MAHMOUD TAHA TAREK (EGY)
3. TIMMERMANS ROB (CUR)
3. MOHAMED HAZEM (EGY)
5. OSMANLI OSMAN (AZE)
5. DAIKHI HOCINE (ALG)
7. ROJAS RODRIGO (CHI)
7. GURBANLI ASIMAN (AZE)

\*Seeded

Referees:			

# Male Kumite 84+ Kg - Round Robin (each against each)

Karate1 Premier League - Cairo 2024, Cairo, EGY

Tatami

Pool  
6/8



1. DAIKHI HOCINE (ALG)
2. KVESIC ANDJELO (CRO)
3. GUNDOG UMUT EREN (TUR)
4. CIANI MICHELE (ITA)



1. SUFYANI SANAD (KSA)
2. MAHMOUD TAHA TAREK (EGY)
3. TIMMERMANS ROB (CUR)
3. MOHAMED HAZEM (EGY)
5. OSMANLI OSMAN (AZE)
5. DAIKHI HOCINE (ALG)
7. ROJAS RODRIGO (CHI)
7. GURBANLI ASIMAN (AZE)

\*Seeded

Referees:			

# Male Kumite 84+ Kg - Round Robin (each against each)

Karate1 Premier League - Cairo 2024, Cairo, EGY

Tatami

Pool

7/8

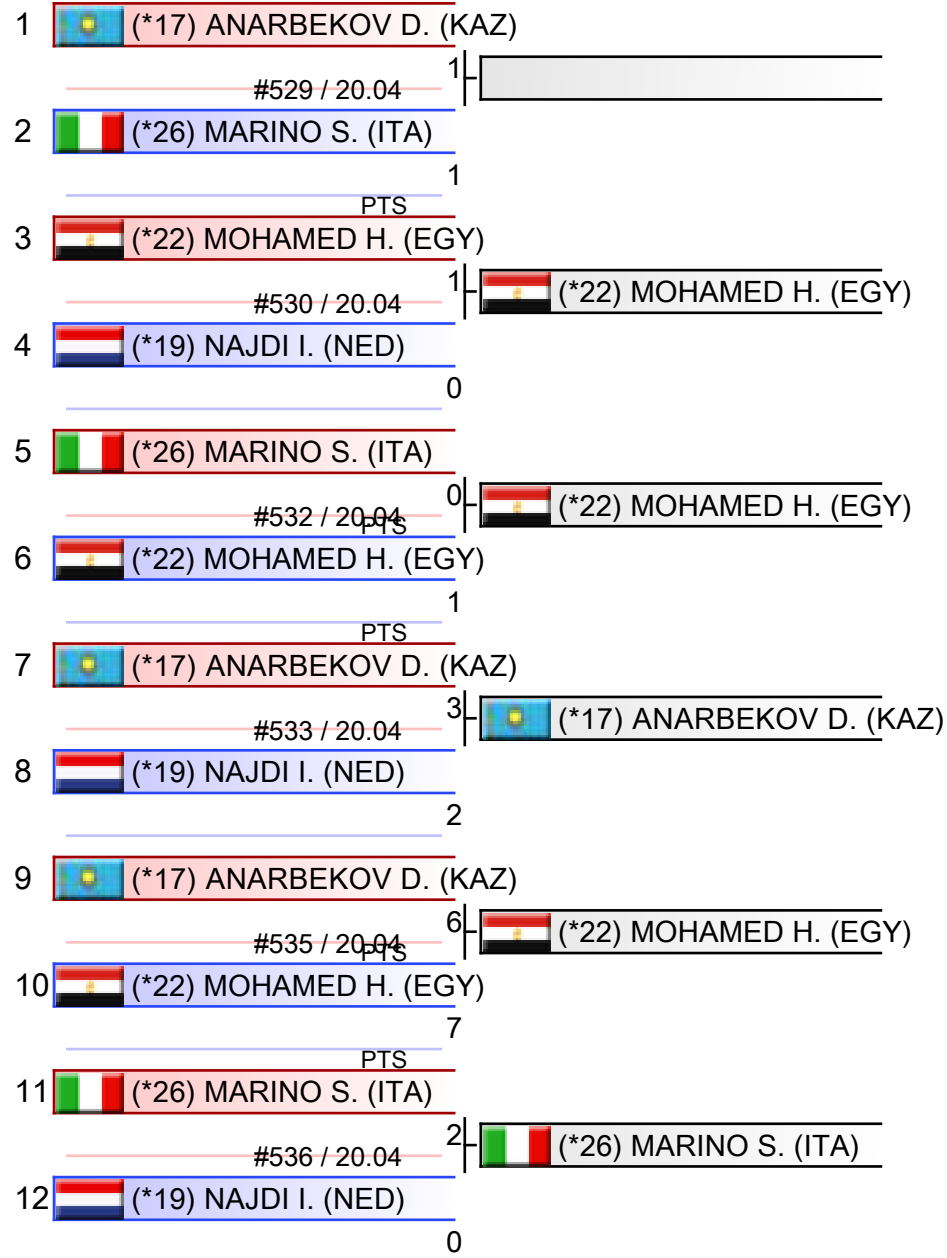

1. MOHAMED HAZEM (EGY)
2. ANARBEOV DIAS (KAZ)
3. MARINO SIMONE (ITA)
4. NAJDI ISSAM (NED)



1. SUFYANI SANAD (KSA)
2. MAHMOUD TAHA TAREK (EGY)
3. TIMMERMANS ROB (CUR)
3. MOHAMED HAZEM (EGY)
5. OSMANLI OSMAN (AZE)
5. DAIKHI HOCINE (ALG)
7. ROJAS RODRIGO (CHI)
7. GURBANLI ASIMAN (AZE)

\*Seeded

Referees:			



# Male Kumite 84+ Kg - Round Robin (each against each)

Karate1 Premier League - Cairo 2024, Cairo, EGY

Tatami

Pool  
8/8

1	(*13) KAYALI F. (TUR)	
	#531 / 20.04	1    (*13) KAYALI F. (TUR)
2	(*21) GHISLANDI M. (ITA)	2
3	(*13) KAYALI F. (TUR)	0    (*1) MAHMOUD T. (EGY)
	#537 / 20.04	
4	(*1) MAHMOUD T. (EGY)	4
5	(*21) GHISLANDI M. (ITA)	0    (*1) MAHMOUD T. (EGY)
	#534 / 20.04	
6	(*1) MAHMOUD T. (EGY)	4

1. MAHMOUD TAHA TAREK (EGY)
2. KAYALI FURKAN (TUR)
3. GHISLANDI MICHAEL (ITA)



1. SUFYANI SANAD (KSA)
2. MAHMOUD TAHA TAREK (EGY)
3. TIMMERMANS ROB (CUR)
3. MOHAMED HAZEM (EGY)
5. OSMANLI OSMAN (AZE)
5. DAIKHI HOCINE (ALG)
7. ROJAS RODRIGO (CHI)
7. GURBANLI ASIMAN (AZE)

\*Seeded

Referees:			

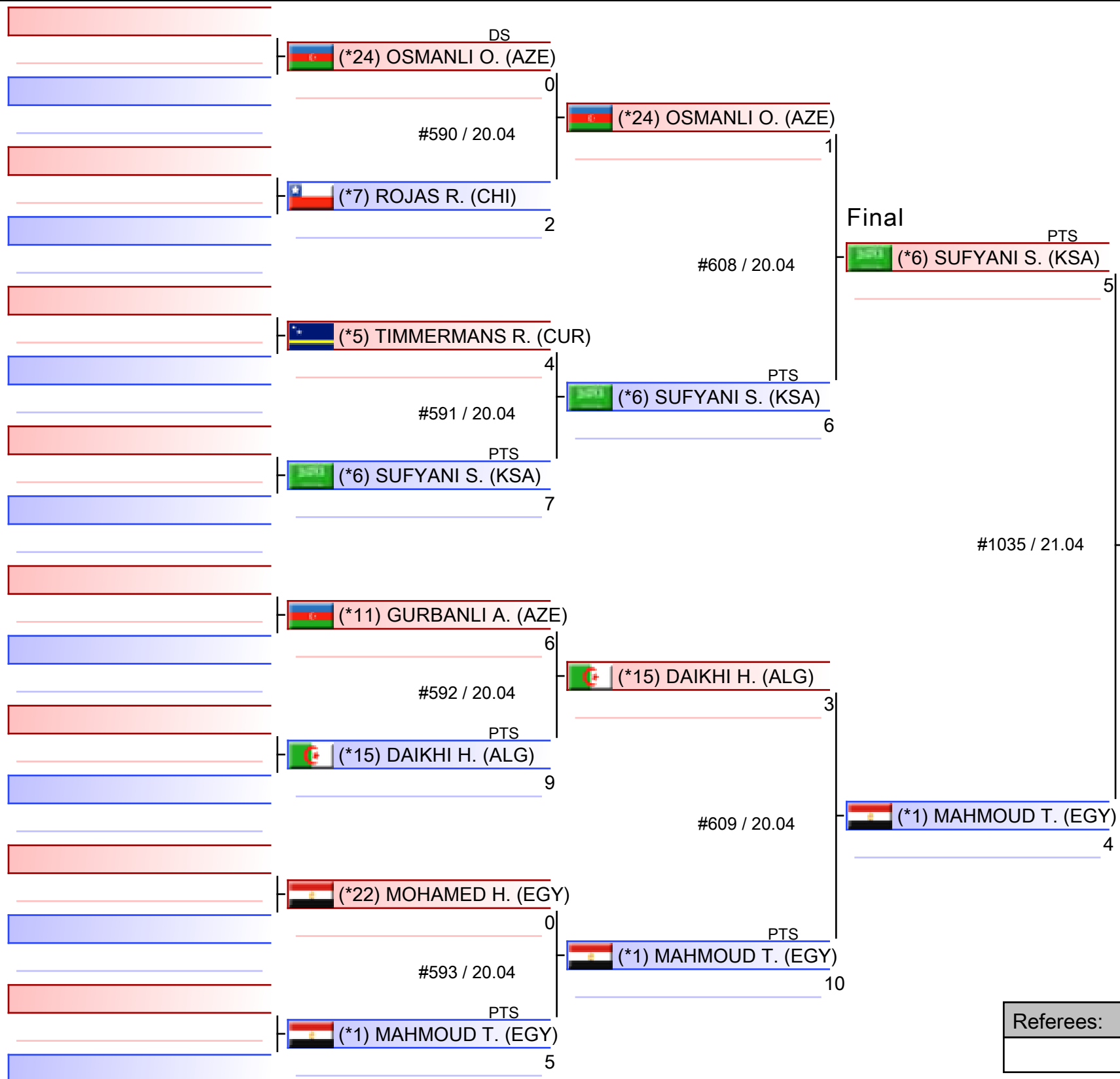

1. SUFYANI SANAD (KSA)
2. MAHMOUD TAHA TAREK (EGY)
3. TIMMERMANS ROB (CUR)
3. MOHAMED HAZEM (EGY)
5. OSMANLI OSMAN (AZE)
5. DAIKHI HOCINE (ALG)
7. ROJAS RODRIGO (CHI)
7. GURBANLI ASIMAN (AZE)

\*Seeded

Referees:			





Karate1 Premier League - Cairo 2024 - 2024-04-19



## Official Results

Male Kumite 84+ Kg			
1	SUFYANI SANAD		KSA - SAUDI ARABIA
2	MAHMOUD TAHA TAREK		EGY - EGYPT
3	TIMMERMANS ROB		CUR - CURACAO
3	MOHAMED HAZEM		EGY - EGYPT
5	OSMANLI OSMAN		AZE - AZERBAIJAN
5	DAIKHI HOCINE		ALG - ALGERIA
7	ROJAS RODRIGO		CHI - CHILE
7	GURBANLI ASIMAN		AZE - AZERBAIJAN



Karate1 Premier League - Cairo 2024 - 2024-04-19



## Official Results

Female Kata			
1	MISHIMA KIRI		JPN - JAPAN
2	ONO MAHO		JPN - JAPAN
3	LAU MO SHEUNG GRACE		HKG - HONG KONG, CHINA
3	AZUMA SAEKO		JPN - JAPAN
5	HESHAM AYA		EGY - EGYPT
5	SHIMIZU NATSUKI		JPN - JAPAN
7	OHUCHI MIRISA		JPN - JAPAN
7	HISAMI NAKAJI		JPN - JAPAN

Female Kumite -50 Kg			
1	ALY GANNA		EGY - EGYPT
2	ZHANGBYRBAY MOLDIR		KAZ - KAZAKHSTAN
3	CARDENAS BALCAZAR SOFIA		COL - COLOMBIA
3	OUIKENE CYLIA		ALG - ALGERIA
5	SGARDELLI EMA		CRO - CROATIA
5	TSUTSUMI SARA		JPN - JAPAN
7	RODRIGUES CATARINA		POR - PORTUGAL
7	AGUS ASIA		ITA - ITALY

Female Kumite -55 Kg			
1	TORO MENESES VALENTINA		CHI - CHILE
2	STOLI MARIA		GRE - GREECE
3	BRUNORI VERONICA		ITA - ITALY
3	LALLO VIOLA		ITA - ITALY
5	DRONCHANKA KSENIYA		POL - POLAND
5	BITSCH MIA		GER - GERMANY
7	HASSAN SALMA		EGY - EGYPT
7	AGUNG SANISTYARANI COK ISTRI		INA - INDONESIA

Female Kumite -61 Kg			
1	KHAMIS REEM		GER - GERMANY
2	NILSSON ANNA-JOHANNA		SWE - SWEDEN
3	SHIMADA SARARA		JPN - JAPAN
3	GRANDE ALEXANDRA		PER - PERU
5	KUJURO YUKI		JPN - JAPAN
5	RADJENOVIC NINA		SUI - SWITZERLAND
7	SHOLOHOVA OLEKSANDRA		UKR - UKRAINE
7	SIVERT LAURA		FRA - FRANCE

Female Kumite -68 Kg			
1	KAMA TSUBASA		JPN - JAPAN
2	ELTEMUR EDA		TUR - TURKIYE
3	AKSOY SUDENUR		TUR - TURKIYE
3	NIETO MEJIAS MARIA ISABEL		ESP - SPAIN
5	ZEFANYA CEYCO GEORGIA		INA - INDONESIA



Karate1 Premier League - Cairo 2024 - 2024-04-19



## Official Results

5	SEMERARO SILVIA		ITA - ITALY	
7	ABDELAZIZ FERYAL		EGY - EGYPT	
7	BECIROVIC SADEA		CRO - CROATIA	

### Female Kumite 68+ Kg

1	KNEER JOHANNA		GER - GERMANY	
2	TORRES GARCIA MARIA		ESP - SPAIN	
3	BERULTSEVA SOFYA		KAZ - KAZAKHSTAN	
3	KEINANEN TITTA		FIN - FINLAND	
5	FERRACUTI CLIO		ITA - ITALY	
5	JUNNER NIAMH		SCO - SCOTLAND	
7	GIAMOUKI THEODOSIA		CYP - CYPRUS	
7	GARCIA NANCY		FRA - FRANCE	

### Male Kata

1	NISHIYAMA KAKERU		JPN - JAPAN	
2	SOFUOGLU ALI		TUR - TURKIYE	
3	FUNADA AOI		JPN - JAPAN	
3	TORRES GUTIERREZ ARIEL		USA - UNITED STATES	
5	MOTO RYUJI		JPN - JAPAN	
5	ABE SAKICHI		JPN - JAPAN	
7	OZDEMIR ENES		TUR - TURKIYE	
7	MOTO KAZUMASA		JPN - JAPAN	

### Male Kumite -60 Kg

1	HAMMAD ABDALLAH		JOR - JORDAN	
2	HASHIMOTO HIROMU		JPN - JAPAN	
3	XENOS CHRISTOS-STEFANOS		GRE - GREECE	
3	ALPYSBAY KAISAR		KAZ - KAZAKHSTAN	
5	ALY ZYAD		EGY - EGYPT	
5	SHAABAN ABDULLAH		KUW - KUWAIT	
7	GRECO DANILO		ITA - ITALY	
7	GULIYEV AMINAGHA		AZE - AZERBAIJAN	

### Male Kumite -67 Kg

1	ALMASATFA ABDEL RAHMAN		JOR - JORDAN	
2	OUBAYA SAID		MAR - MOROCCO	
3	GHAITH AFEEF		JOR - JORDAN	
3	FIGUEIRA VINICIUS		BRA - BRAZIL	
5	AMIRALI DIDAR		KAZ - KAZAKHSTAN	
5	BALLOTIS GEORGIOS		GRE - GREECE	
7	MARESCA LUCA		ITA - ITALY	
7	FREIRE FUENTES TOMAS		CHI - CHILE	

### Male Kumite -75 Kg

1	ABDELAZIZ ABDALLA		EGY - EGYPT	
2	YURUR OMER FARUK		TUR - TURKIYE	



Karate1 Premier League - Cairo 2024 - 2024-04-19



## Official Results

3	BERTHON ENZO		FRA - FRANCE	
3	FARAG YOUSSEF		EGY - EGYPT	
5	SAKIYAMA YUSEI		JPN - JAPAN	
5	TURULJA HAMZA		BIH - BOSNIA AND HERZEGOVINA	
7	ZAPLITNYI ANDRII		UKR - UKRAINE	
7	PIETROMARCHI LORENZO		ITA - ITALY	

### Male Kumite -84 Kg

1	ALJAFARI MOHAMMAD		JOR - JORDAN	
2	BADAWY YOUSSEF		EGY - EGYPT	
3	KVESIC IVAN		CRO - CROATIA	
3	SONNYKH VALERII		UKR - UKRAINE	
5	FIORE MATTEO		ITA - ITALY	
5	MIDOUNE FALLEH		ALG - ALGERIA	
7	SPASENOVSKI PETAR		MKD - NORTH MACEDONIA	
7	CHOBOTAR VALERII		UKR - UKRAINE	

### Male Kumite 84+ Kg

1	SUFYANI SANAD		KSA - SAUDI ARABIA	
2	MAHMOUD TAHA TAREK		EGY - EGYPT	
3	TIMMERMANS ROB		CUR - CURACAO	
3	MOHAMED HAZEM		EGY - EGYPT	
5	OSMANLI OSMAN		AZE - AZERBAIJAN	
5	DAIKHI HOCINE		ALG - ALGERIA	
7	ROJAS RODRIGO		CHI - CHILE	
7	GURBANLI ASIMAN		AZE - AZERBAIJAN	