

RESULTS BOOK

OFFENE UNTERFRÄNKISCHE KARATE
BEZIRKSMEISTERSCHAFT &
NEWCOMER KARATE TURNIER 2024

2024.10.12 - 2024.10.12

HERMASWEG 1 97506 GRAFENRHEINFELD

WWW.SPORTDATA.ORG



TABLE OF CONTENTS

STATISTICS 4
OFFICIAL RESULTS 131
MEDAL STANDING 143

OFFENE UNTERFRÄNKISCHE KARATE BEZIRKS ..

GERMANY
Hermasweg 1 97506 Grafenrheinfeld

2024.10.12 - 2024.10.12

Statistics

Participating Countries: 1

Participating Regions: 1

Participating Team/Clubs: 23

	Competitors	Entries
Female	81	124
Male	92	168
Total	173	292

Entries per Category	Entries	Teams
KATA Jugend männlich	6	-
KATA Jugend weiblich	6	-
KATA Kinder A männlich	6	-
KATA Kinder A weiblich	8	-
KATA Schüler A männlich	4	-
KATA Schüler A weiblich	13	-
KATA Schüler B männlich	6	-
KATA Schüler B weiblich	7	-
KATA TEAM Jugend/Junioren weiblich	-	1
KUMITE Jugend +70kg männlich	3	-
KUMITE Jugend -52kg männlich	3	-
KUMITE Jugend -54kg weiblich	2	-
KUMITE Kinder A -30kg männlich	4	-
KUMITE Schüler B weiblich	3	-
KUMITE TEAM KINDER A/B MÄNNLICH	-	2
Kata Junioren männlich	2	-
Kata Junioren/Leistungsklasse weiblich	5	-
Kata Kinder B mixed	4	-
Kata Leistungsklasse männlich	7	-
Kata Masterklasse weiblich	2	-
Kata Masterklasse Ü30/Ü35 männlich	4	-
Kata Masterklasse Ü45 männlich	5	-
Kata Masterklasse Ü55/Ü65 männlich	4	-
Kata Team Kinder/Schüler mixed	-	3
Kumite Jugend -61/+61 kg weiblich	6	-
Kumite Jugend/Junioren -57kg männlich	4	-
Kumite Junioren weiblich	6	-
Kumite Kinder A -35/+40kg männlich	4	-
Kumite Leistungsklasse -60/-67/-75kg männlich	3	-
Kumite Leistungsklasse -84/+84kg männlich	4	-

OFFENE UNTERFRÄNKISCHE KARATE BEZIRKS ..

GERMANY
Hermasweg 1 97506 Grafenrheinfeld

2024.10.12 - 2024.10.12

Statistics

Kumite Leistungsklasse Allkat. männlich	4	-
Kumite Leistungsklasse Allkat. weiblich	4	-
Kumite Leistungsklasse weiblich +68 kg	2	-
Kumite Leistungsklasse weiblich -68 kg	4	-
Kumite Masterklasse Ü30/Ü35 -80kg männlich	3	-
Kumite Masterklasse Ü45/Ü55/Ü65 +80kg männlich	3	-
Kumite Schüler A -40kg männlich	3	-
Kumite Schüler A -42/-47kg weiblich	4	-
Kumite Schüler A -45kg männlich	4	-
Kumite Schüler A -50/-55kg männlich	2	-
Kumite Schüler A -52/+52kg weiblich	2	-
Kumite Schüler B +38kg männlich	6	-
Kumite Schüler B -32kg männlich	5	-
Kumite Schüler B -38kg männlich	6	-
Kumite Team Jugend/Junioren weiblich	-	3
Kumite Team Leistungsklasse weiblich	-	1
Kumite Team Schüler A&B männlich	-	5
Kumite Team Schüler A&B weiblich	-	2
Newcomer Kata Kinder A 7.-6. Kyu mixed	6	-
Newcomer Kata Kinder A 9.-8.Kyu männlich	5	-
Newcomer Kata Kinder A 9.-8.Kyu weiblich	3	-
Newcomer Kata Kinder B 9.-8.Kyu männlich	3	-
Newcomer Kata Kinder B 9.-8.Kyu weiblich	5	-
Newcomer Kata Schüler A 7.-6. Kyu mixed	4	-
Newcomer Kata Schüler A 9.-8. Kyu mixed	4	-
Newcomer Kata Schüler B 7.-6. Kyu mixed	5	-
Newcomer Kata Schüler B 9.-8.Kyu männlich	7	-
Newcomer Kata Schüler B 9.-8.Kyu weiblich	3	-
Newcomer Kumite Kinder A weiblich	4	-
Newcomer Kumite Kinder A -30 kg männlich	4	-
Newcomer Kumite Kinder A -35 kg männlich	3	-
Newcomer Kumite Kinder A -40/+40kg männlich	2	-
Newcomer Kumite Kinder B -25 kg männlich	2	-
Newcomer Kumite Kinder B weiblich	3	-
Newcomer Kumite Schüler A -40 kg männlich	3	-
Newcomer Kumite Schüler A -45 kg männlich	2	-
Newcomer Kumite Schüler A -50/+55kg männlich	2	-
Newcomer Kumite Schüler A weiblich	4	-
Newcomer Kumite Schüler B +36 kg weiblich	3	-
Newcomer Kumite Schüler B +38 kg männlich	6	-

OFFENE UNTERFRÄNKISCHE KARATE BEZIRKS ..

GERMANY
Hermasweg 1 97506 Grafenrheinfeld

2024.10.12 - 2024.10.12

Statistics

Newcomer Kumite Schüler B -30/-36kg weiblich	2	-
Newcomer Kumite Schüler B -32 kg männlich	2	-
Newcomer Kumite Schüler B -38 kg männlich	5	-
Totals:	275	17

KATA Jugend männlich

OFFENE UNTERFRÄNKISCHE KARATE BEZIRKSMEISTERSCHAFT & NEWCOMER KARATE TURNIER 2024, Hermasweg 1 97506 Grafenrheinfeld, GER

2024-10-12

Tatami
1 13:20

Pool
1/1

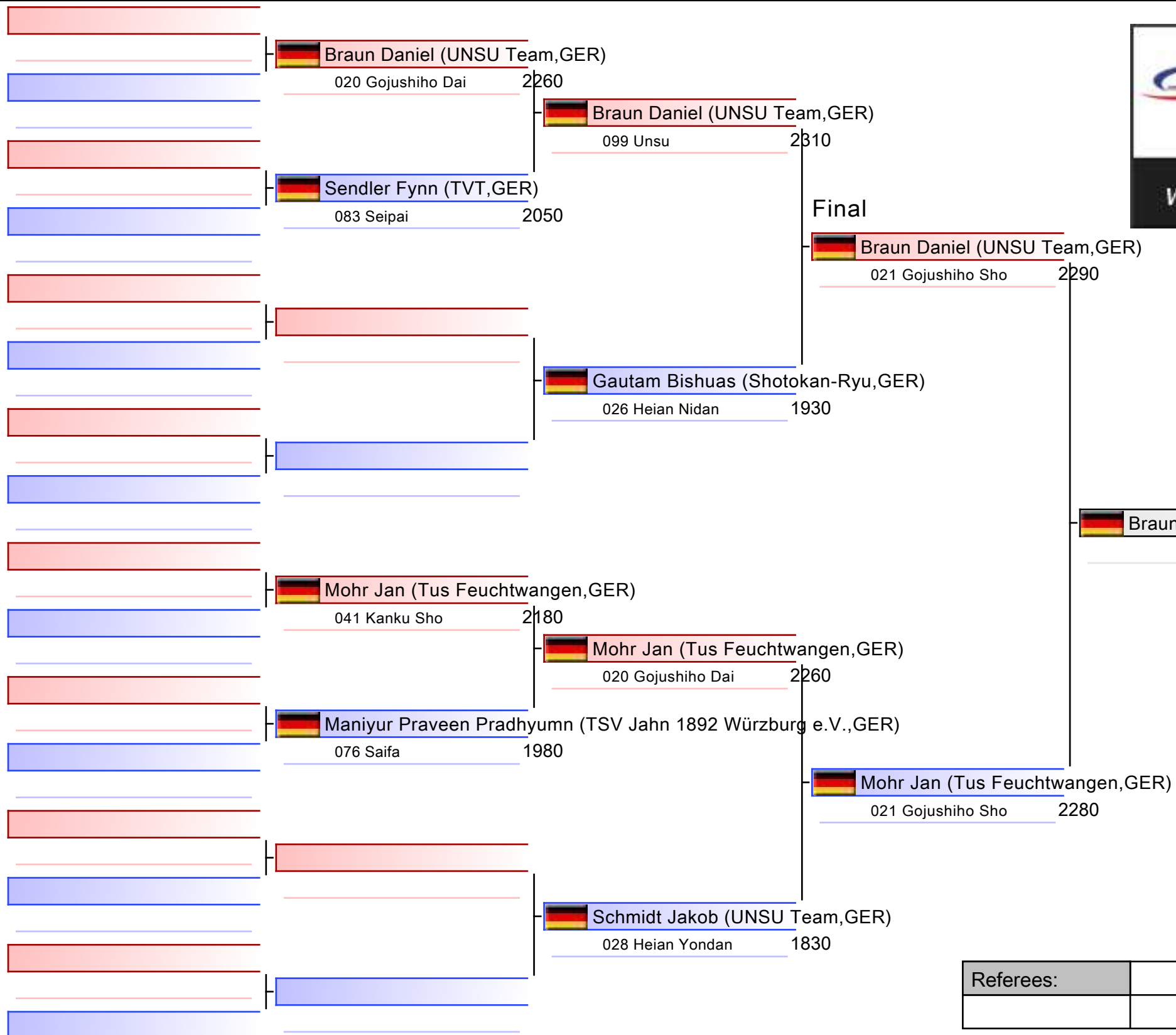

1. BRAUN DANIEL (UNSU TEAM,GER)
2. MOHR JAN (TUS FEUCHTWANGEN,GER)
3. SENDLER FYNN (TVT,GER)
3. MANIYUR PRAVEEN PRADHYUMN (TSV JAHN)
5. GAUTAM BISHUAS (SHOTOKAN-RYU,GER)
5. SCHMIDT JAKOB (UNSU TEAM,GER)

Referees:			

KATA Jugend männlich

OFFENE UNTERFRÄNKISCHE KARATE BEZIRKSMEISTERSCHAFT & NEWCOMER KARATE TURNIER 2024

2024-10-12

Tatami
1 13:35

Pool
1

(c)sportdata GmbH & Co KG 2000-2024 (2024-10-12 18:42) v 10.2.0 build 1 (2024-09-26 10:14 CET) License: Online_Event_ID-8506_OFFENEUNTERFRNKISCHEKARATEBEZIRKSMEISTERSCHAFTNEWCOMERKARATETURNIER2024

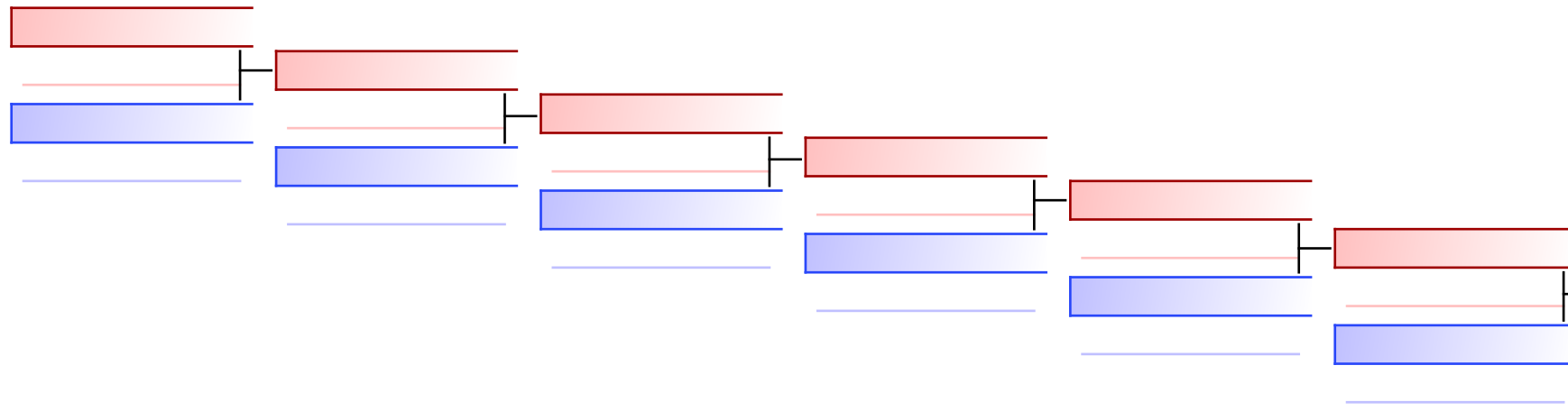

Sendler Fynn (TVT,GER)
082 Seienchin. 1960
 Sendler Fynn (TVT,GER)
 Gautam Bishuas (Shotokan-Ryu,GER)
027 Heian San. 1880

REPECHAGE: (1)

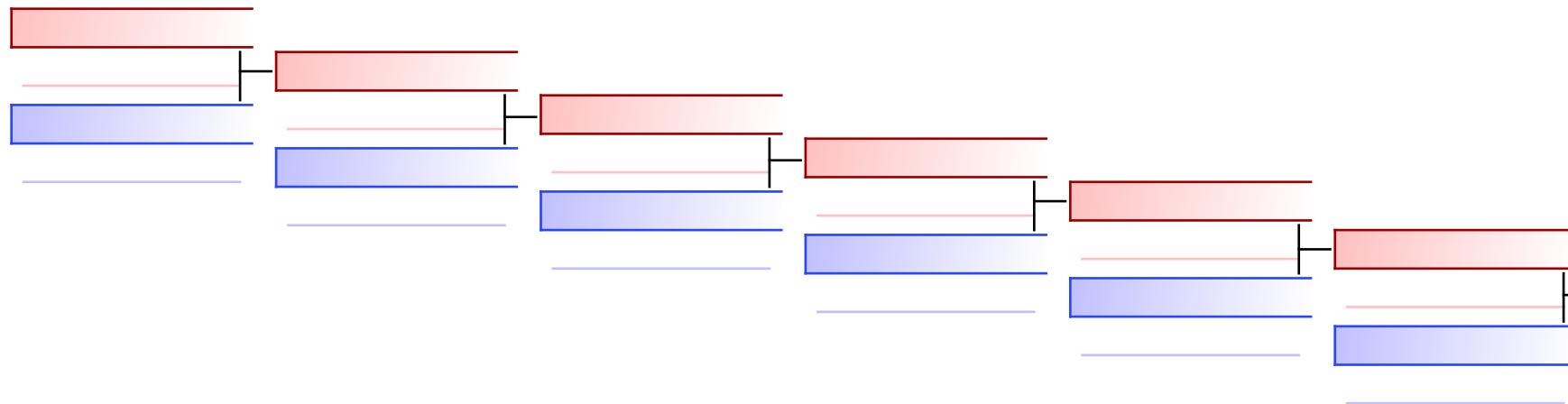

Maniyur Praveen Pradhyumn (TSV Jahn 1892 Würzbur
006 Bassai Da. 1920
 Maniyur Praveen Pradhyumn (TS
 Schmidt Jakob (UNSU Team,GER)
029 Heian God. 1840

Referees:							
-----------	--	--	--	--	--	--	--

KATA Jugend weiblich

OFFENE UNTERFRÄNKISCHE KARATE BEZIRKSMEISTERSCHAFT & NEWCOMER KARATE TURNIER 2024, Hermasweg 1 97506 Grafenrheinfeld, GER

2024-10-12

Tatami
1 12:50

Pool
1/1

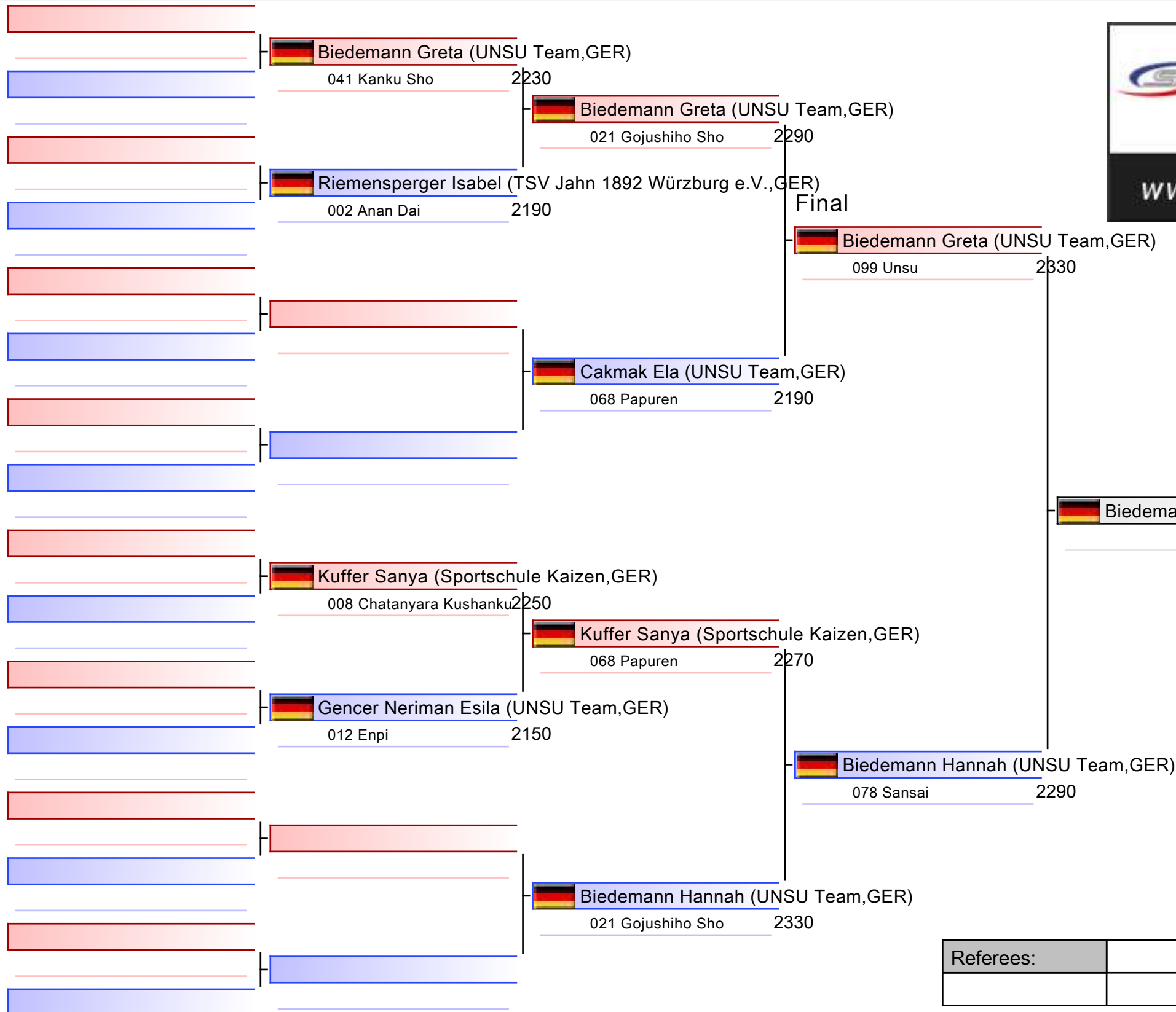

1. BIEDEMANN GRETA (UNSU TEAM,GER)
2. BIEDEMANN HANNAH (UNSU TEAM,GER)
3. KUFFER SANYA (SPORTSCHULE KAIZEN,GER)
3. RIEMENSPERGER ISABEL (TSV JAHN 1892 WÜ)
5. CAKMAK ELA (UNSU TEAM,GER)

Referees:			

KATA Jugend weiblich

OFFENE UNTERFRÄNKISCHE KARATE BEZIRKSMEISTERSCHAFT & NEWCOMER KARATE TURNIER 2024

2024-10-12

Tatami
1 13:05

Pool
1

(c)sportdata GmbH & Co KG 2000-2024 (2024-10-12 18:42) v 10.2.0 build 1 (2024-09-26 10:14 CET) License: Online_Event_ID-8506_OFFENEUNTERFRNKISCHEKARATEBEZIRKSMEISTERSCHAFTNEWCOMERKARATETURNIER2024

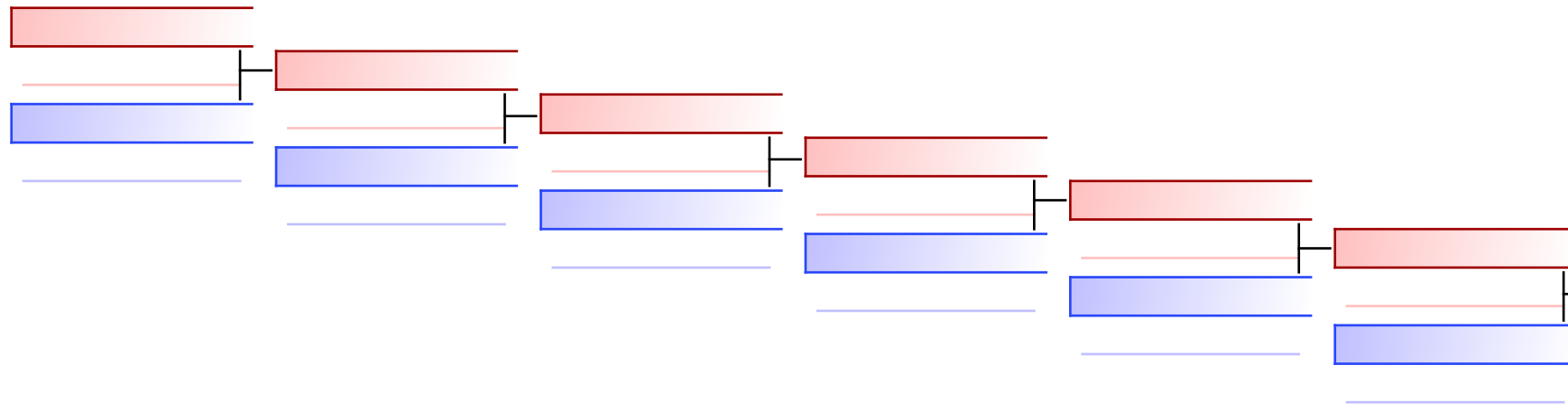

Riemensperger Isabel (TSV Jahn 1892 Würzburg e.V., GER)
092 Suparinpe. 2200

Riemensperger Isabel (TSV Jahn 1892 Würzburg e.V., GER)
092 Suparinpe. 2200

Cakmak Ela (UNSU Team, GER)
008 Chatanyar. 2140

REPECHAGE: (1)

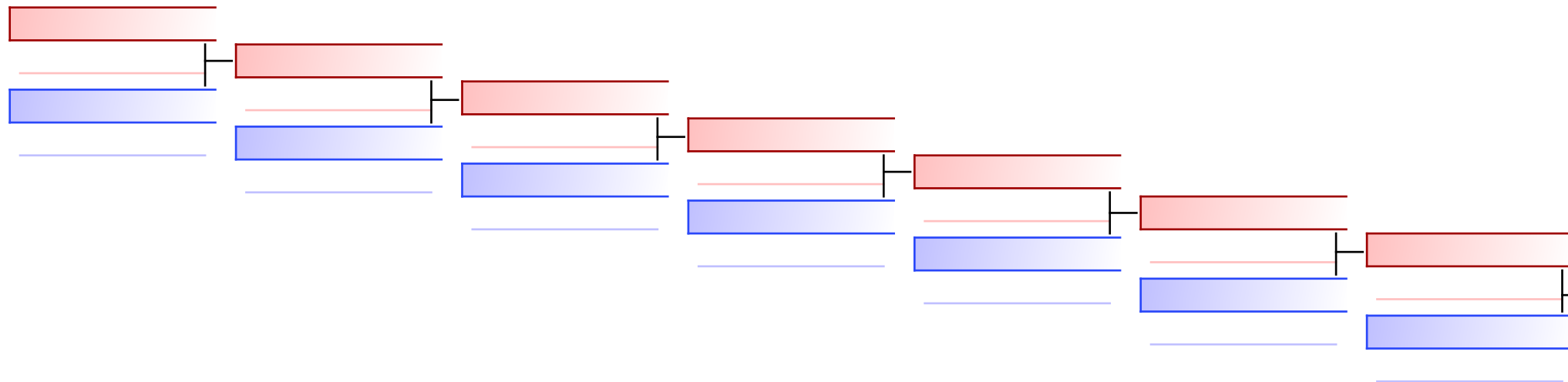

Kuffer Sanya (Sportschule Kaizer)

Referees:							
-----------	--	--	--	--	--	--	--

KATA Kinder A männlich

OFFENE UNTERFRÄNKISCHE KARATE BEZIRKSMEISTERSCHAFT & NEWCOMER KARATE TURNIER 2024, Hermasweg 1 97506 Grafenrheinfeld, GER

2024-10-12

Tatami
1 12:10

Pool
1/1

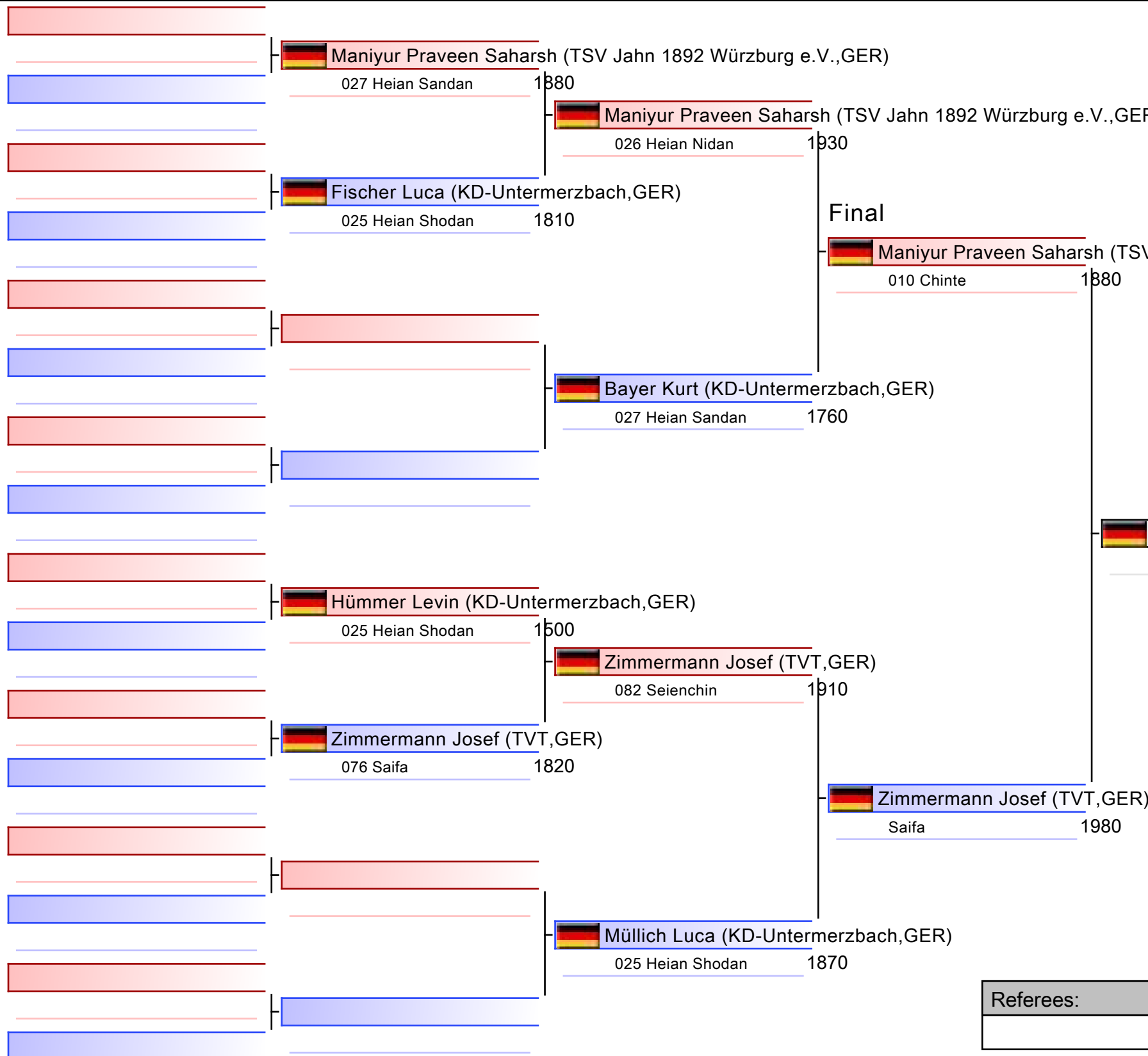

1. ZIMMERMANN JOSEF (TVT,GER)
2. MANIYUR PRAVEEN SAHARSH (TSV JAHN 1892 WÜRZBURG E.V.,GER)
3. FISCHER LUCA (KD-UNTERMERZBACH,GER)
3. MÜLLICH LUCA (KD-UNTERMERZBACH,GER)
5. BAYER KURT (KD-UNTERMERZBACH,GER)
5. HÜMMER LEVIN (KD-UNTERMERZBACH,GER)

Referees:			

KATA Kinder A männlich

OFFENE UNTERFRÄNKISCHE KARATE BEZIRKSMEISTERSCHAFT & NEWCOMER KARATE TURNIER 2024

2024-10-12

Tatami
1 12:25

Pool
1

(c)sportdata GmbH & Co KG 2000-2024 (2024-10-12 18:42) v 10.2.0 build 1 (2024-09-26 10:14 CET) License: Online_Event_ID-8506_OFFENEUNTERFRNKISCHEKARATEBEZIRKSMEISTERSCHAFTNEWCOMERKARATETURNIER2024

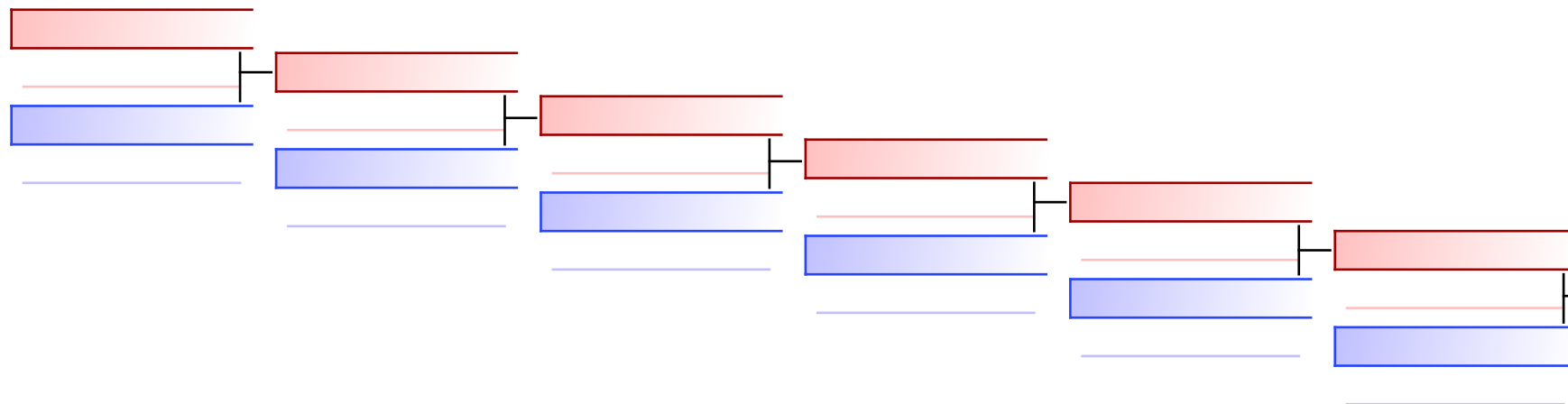

Fischer Luca (KD-Untermerzbach,GER)

025 Heian Sho. 1720

Fischer Luca (KD-Untermerzbach,GER)

Bayer Kurt (KD-Untermerzbach,GER)

028 Heian Yon. 1580

REPECHAGE: (1)

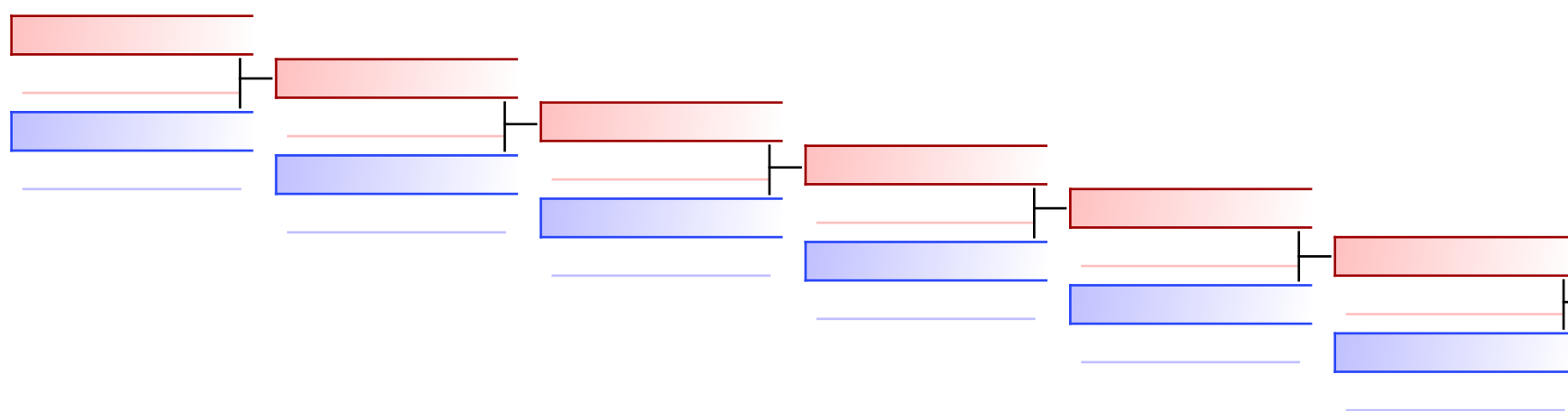

Hümmer Levin (KD-Untermerzbach,GER)

025 Heian Sho. 1530

Müllich Luca (KD-Untermerzbach,GER)

Müllich Luca (KD-Untermerzbach,GER)

025 Heian Sho. 1670

Referees:							
-----------	--	--	--	--	--	--	--

KATA Kinder A weiblich

OFFENE UNTERFRÄNKISCHE KARATE BEZIRKSMEISTERSCHAFT & NEWCOMER KARATE TURNIER 2024, Hermasweg 1 97506 Grafenrheinfeld, GER

2024-10-12

Tatami
1 11:40

Pool
1/1

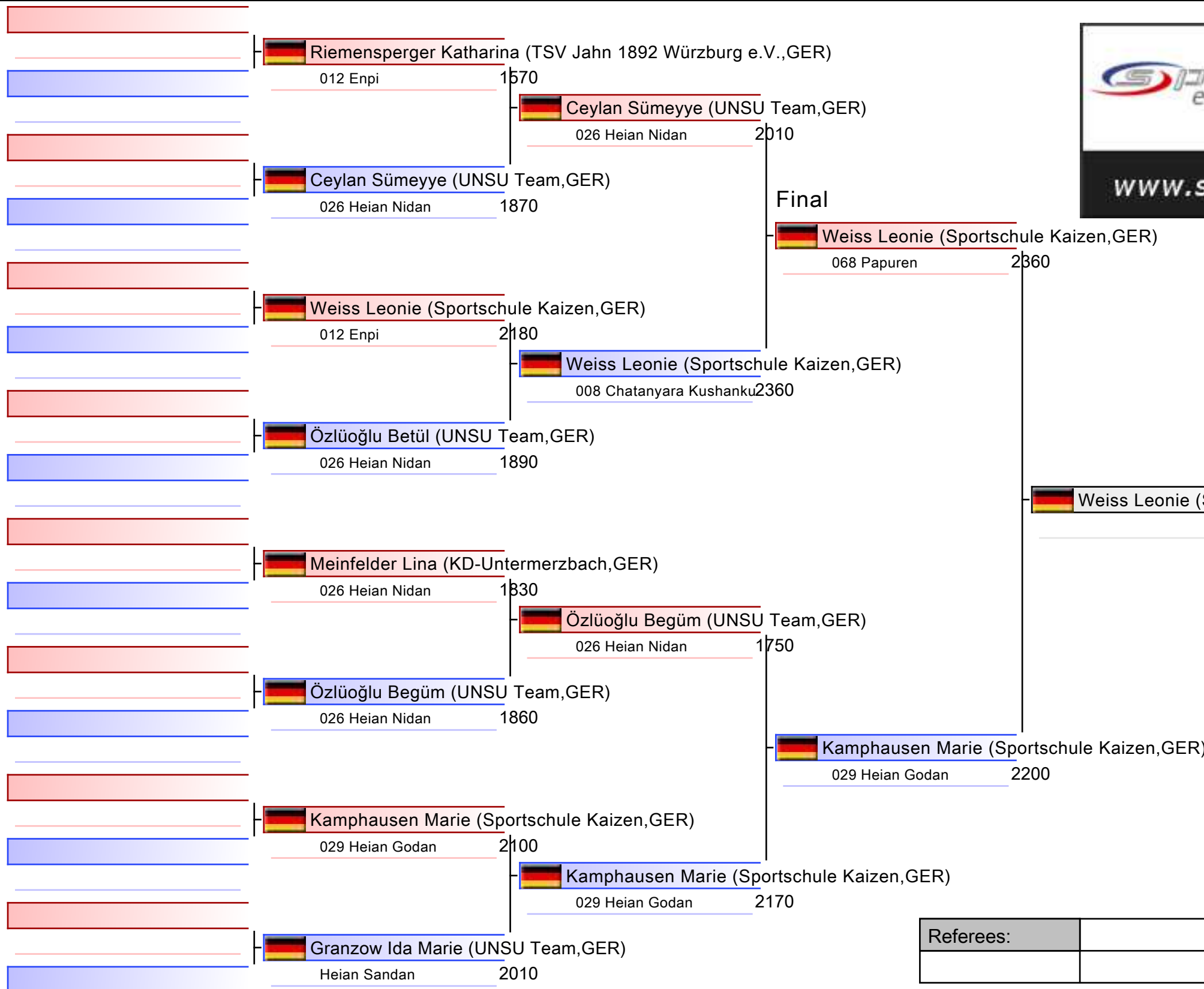

- | |
|---|
| 1. WEISS LEONIE (SPORTSCHULE KAIZEN, GER) |
| 2. KAMPHAUSEN MARIE (SPORTSCHULE KAIZEN, GER) |
| 3. CEYLAN SÜMEYYE (UNSU TEAM, GER) |
| 3. GRANZOW IDA MARIE (UNSU TEAM, GER) |
| 5. ÖZLÜOĞLU BETÜL (UNSU TEAM, GER) |
| 5. ÖZLÜOĞLU BEGÜM (UNSU TEAM, GER) |
| |
| |

Referees:			

KATA Kinder A weiblich

OFFENE UNTERFRÄNKISCHE KARATE BEZIRKSMEISTERSCHAFT & NEWCOMER KARATE TURNIER 2024

2024-10-12

Tatami

1 12:00

Pool

1

(c)sportdata GmbH & Co KG 2000-2024 (2024-10-12 18:42) v 10.2.0 build 1 (2024-09-26 10:14 CET) License: Online_Event_ID-8506_OFFENEUNTERFRNKISCHEKARATEBEZIRKSMEISTERSCHAFTNEWCOMERKARATETURNIER2024

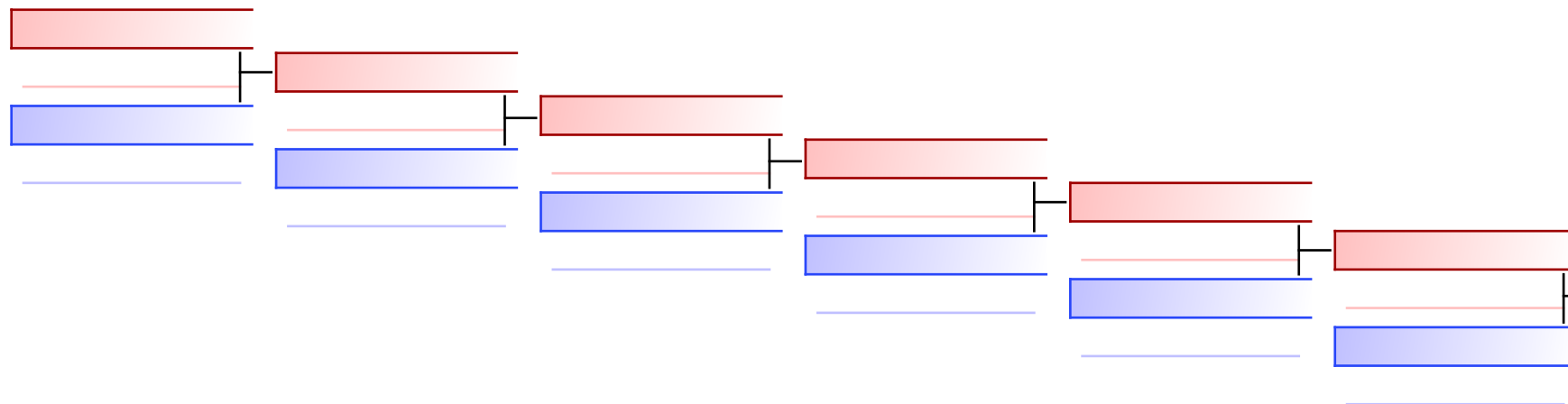

Özlüoğlu Betül (UNSU Team,GER)
026 Heian Nid. 1810

Ceylan Sümeyye (UNSU Team,GER)

Ceylan Sümeyye (UNSU Team,GER)
026 Heian Nid. 1990

REPECHAGE: (1)

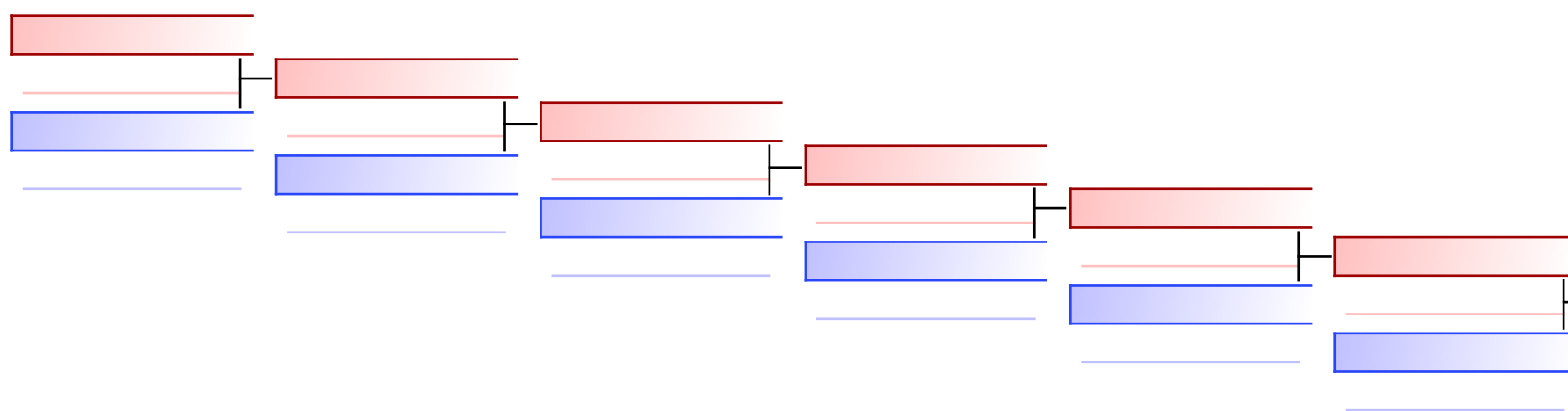

Granzow Ida Marie (UNSU Team,GER)
027 Heian San. 2070

Granzow Ida Marie (UNSU Team,GER)

Özlüoğlu Begüm (UNSU Team,GER)
026 Heian Nid. 1930

Referees:							
-----------	--	--	--	--	--	--	--

KATA Schüler A männlich

OFFENE UNTERFRÄNKISCHE KARATE BEZIRKSMEISTERSCHAFT & NEWCOMER KARATE TURNIER 2024, Hermasweg 1 97506 Grafenrheinfeld, GER

2024-10-12

Tatami
1 12:35

Pool
1/1

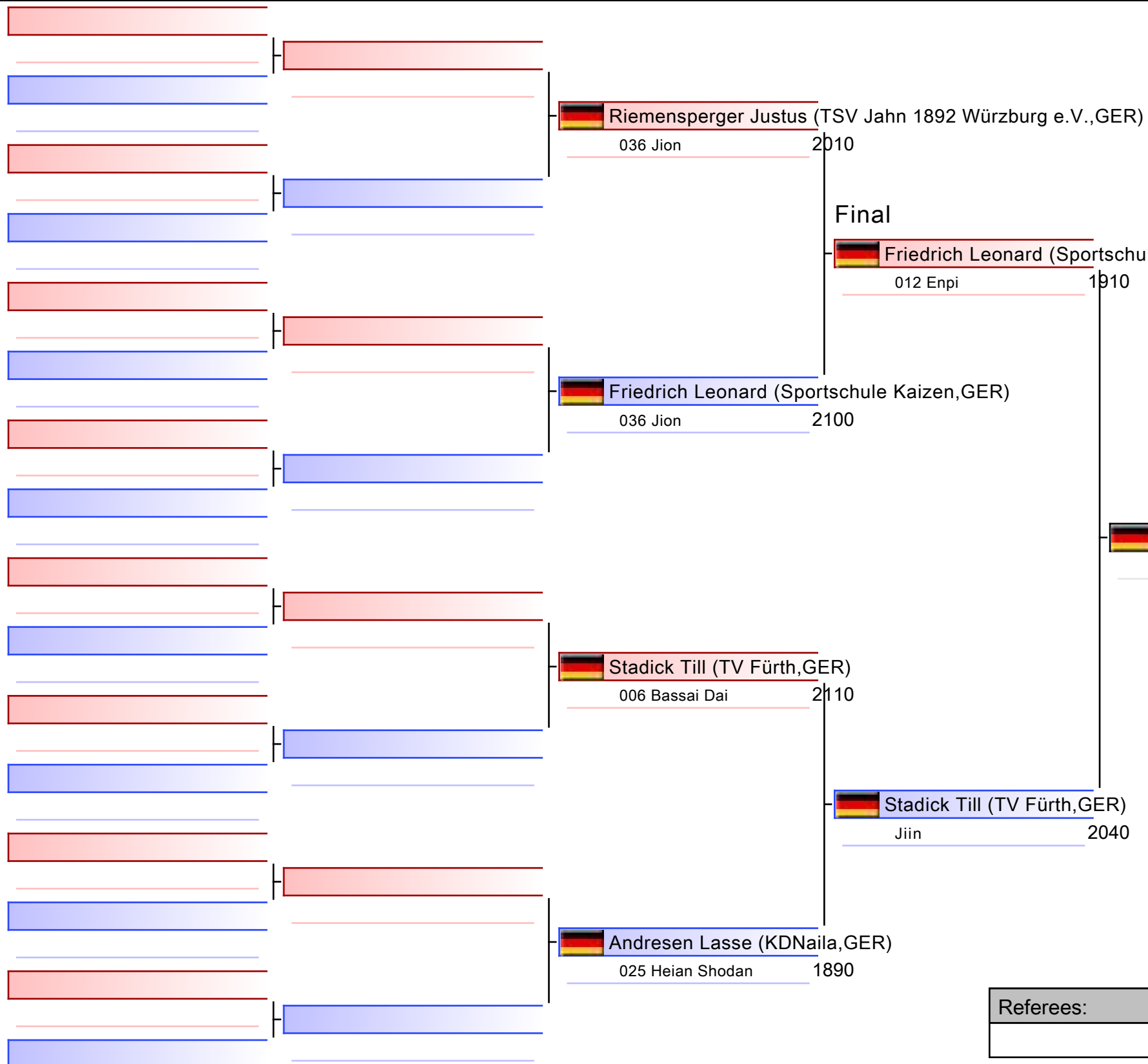

1. STADICK TILL (TV FÜRTH,GER)
2. FRIEDRICH LEONARD (SPORTSCHULE KAIZEN)
3. RIEMENSPERGER JUSTUS (TSV JAHN 1892 WÜRZBURG E.V.,GER)
3. ANDRESEN LASSE (KDNAILA,GER)

Referees:			

KATA Schüler A männlich

OFFENE UNTERFRÄNKISCHE KARATE BEZIRKSMEISTERSCHAFT & NEWCOMER KARATE TURNIER 2024

Tatami

Pool

1

(c)sportdata GmbH & Co KG 2000-2024 (2024-10-12 18:42) v 10.2.0 build 1 (2024-09-26 10:14 CET) License: Online_Event_ID-8506_OFFENEUNTERFRNKISCHEKARATEBEZIRKSMEISTERSCHAFTNEWCOMERKARATETURNIER2024

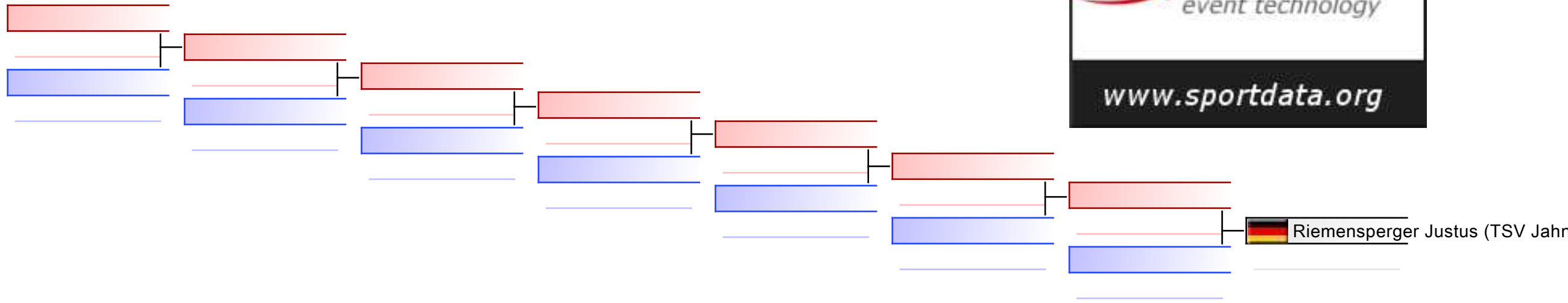

REPECHAGE: (1)

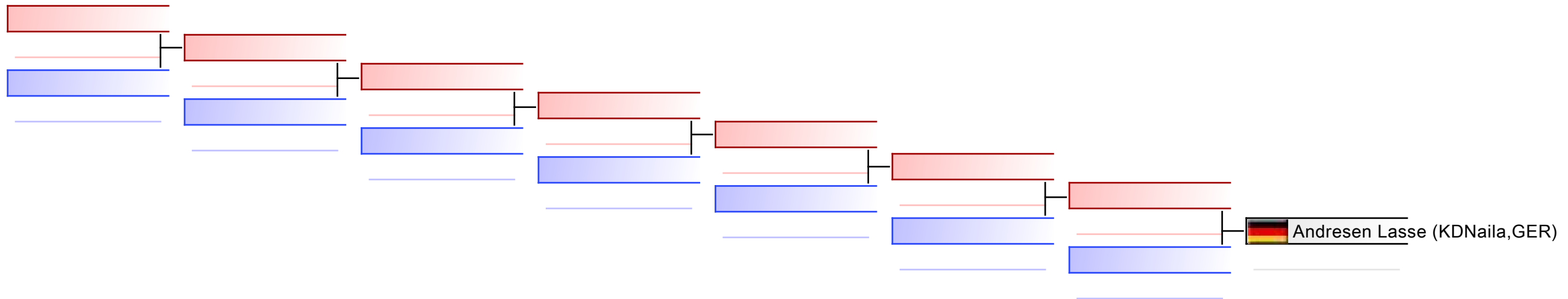

Referees:							
-----------	--	--	--	--	--	--	--

KATA Schüler A weiblich

OFFENE UNTERFRÄNKISCHE KARATE BEZIRKSMEISTERSCHAFT & NEWCOMER KARATE TURNIER 2024, Hermasweg 1 97506 Grafenrheinfeld, GER

2024-10-12

Tatami
3 12:35

Pool
1/1

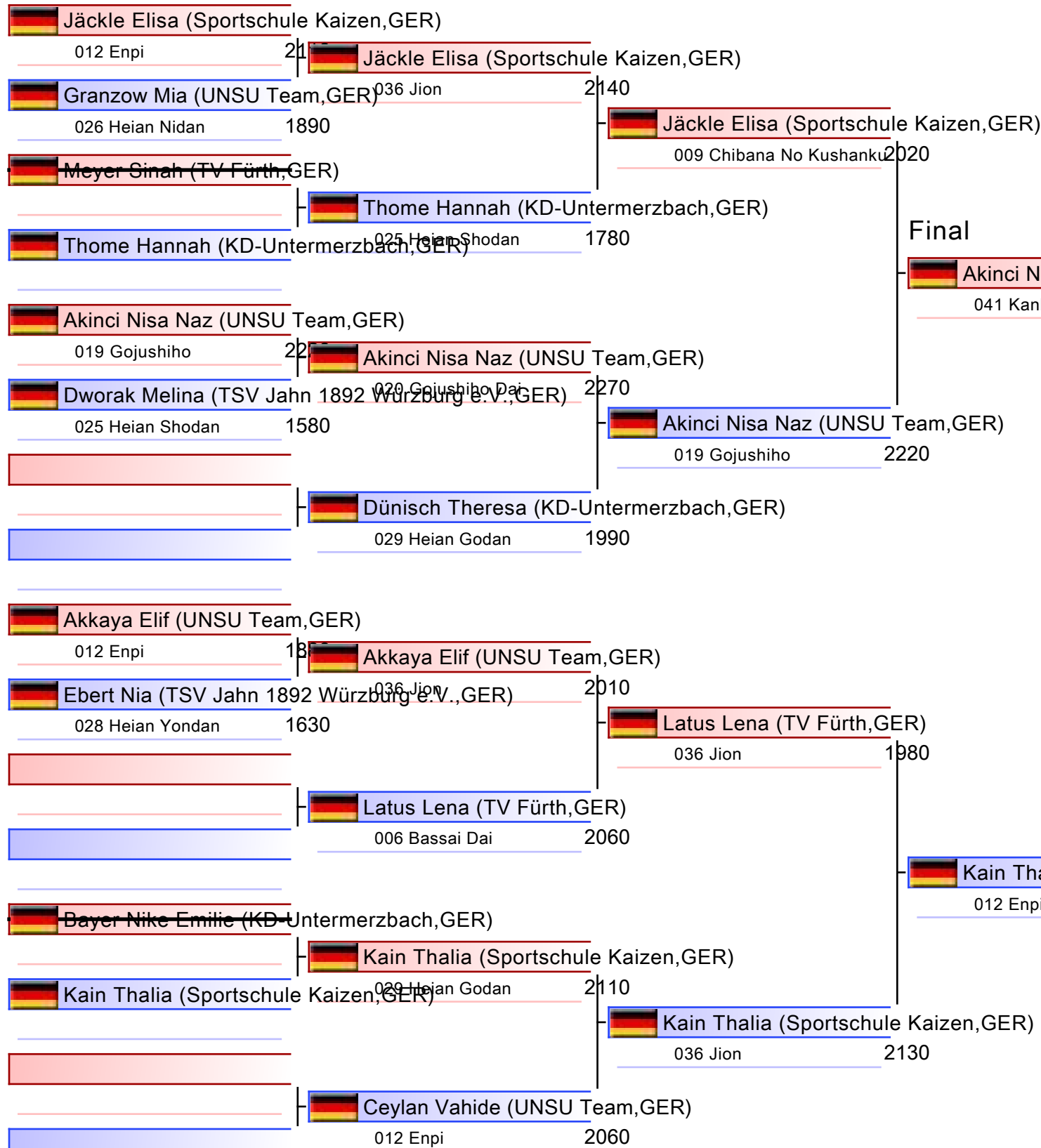

- | |
|--|
| 1. AKINCI NISA NAZ (UNSU TEAM,GER) |
| 2. KAIN THALIA (SPORTSCHULE KAIZEN,GER) |
| 3. JÄCKLE ELISA (SPORTSCHULE KAIZEN,GER) |
| 3. CEYLAN VAHIDE (UNSU TEAM,GER) |
| 5. DÜNISCH THERESA (KD-UNTERMERZBACH,GER) |
| 5. LATUS LENA (TV FÜRTH,GER) |
| 7. DWORAK MELINA (TSV JAHN 1892 WÜRZBURG E.V.,GER) |

Referees:			

KATA Schüler A weiblich

OFFENE UNTERFRÄNKISCHE KARATE BEZIRKSMEISTERSCHAFT & NEWCOMER KARATE TURNIER 2024

2024-10-12

Tatami

3 13:20

Pool

1

(c)sportdata GmbH & Co KG 2000-2024 (2024-10-12 18:42) v 10.2.0 build 1 (2024-09-26 10:14 CET) License: Online_Event_ID-8506_OFFENEUNTERFRNKISCHEKARATEBEZIRKSMEISTERSCHAFTNEWCOMERKARATETURNIER2024

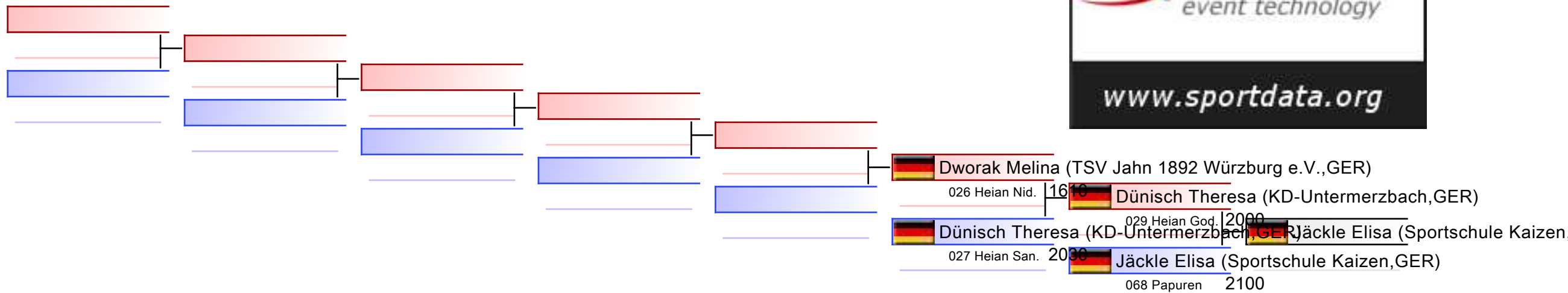

REPECHAGE: (1)

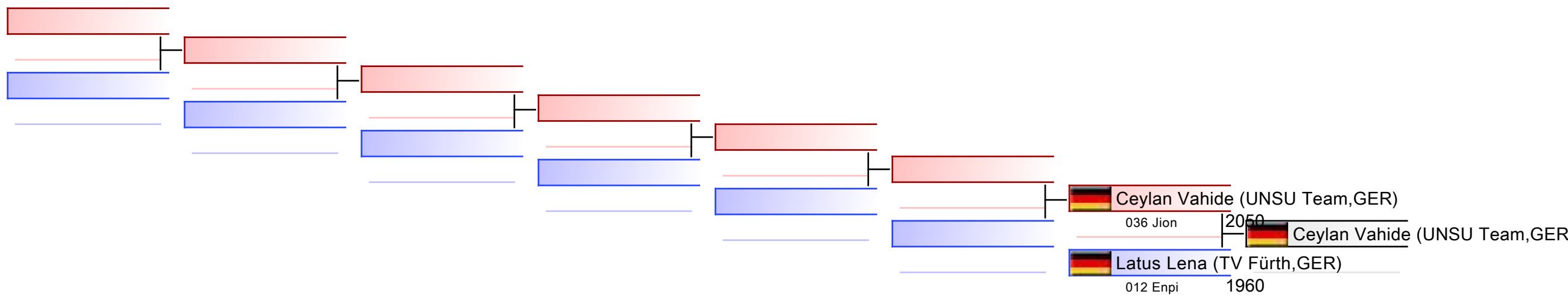

Referees:							
-----------	--	--	--	--	--	--	--

KATA Schüler B männlich

OFFENE UNTERFRÄNKISCHE KARATE BEZIRKSMEISTERSCHAFT & NEWCOMER KARATE TURNIER 2024, Hermasweg 1 97506 Grafenrheinfeld, GER

2024-10-12

Tatami
2 12:05

Pool
1/1

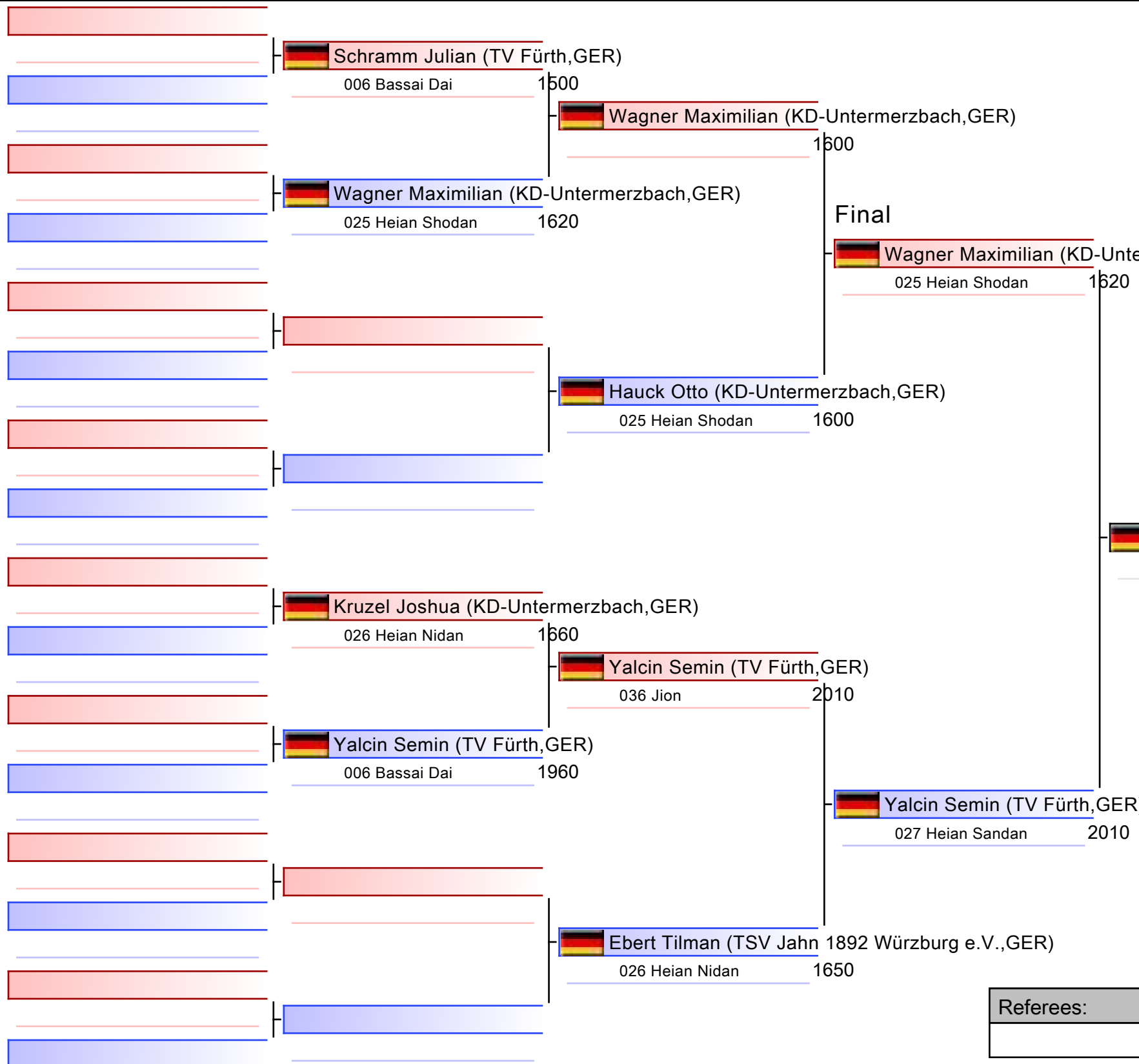

1. YALCIN SEMIN (TV FÜRTH,GER)
2. WAGNER MAXIMILIAN (KD-UNTERMERZBACH,GER)
3. SCHRAMM JULIAN (TV FÜRTH,GER)
3. EBERT TILMAN (TSV JAHN 1892 WÜRZBURG E.V.,GER)
5. HAUCK OTTO (KD-UNTERMERZBACH,GER)
5. KRUZEL JOSHUA (KD-UNTERMERZBACH,GER)

Referees:			

KATA Schüler B männlich

OFFENE UNTERFRÄNKISCHE KARATE BEZIRKSMEISTERSCHAFT & NEWCOMER KARATE TURNIER 2024

2024-10-12

Tatami

2 12:20

Pool

1

(c)sportdata GmbH & Co KG 2000-2024 (2024-10-12 18:43) v 10.2.0 build 1 (2024-09-26 10:14 CET) License: Online_Event_ID-8506_OFFENEUNTERFRNKISCHEKARATEBEZIRKSMEISTERSCHAFTNEWCOMERKARATETURNIER2024

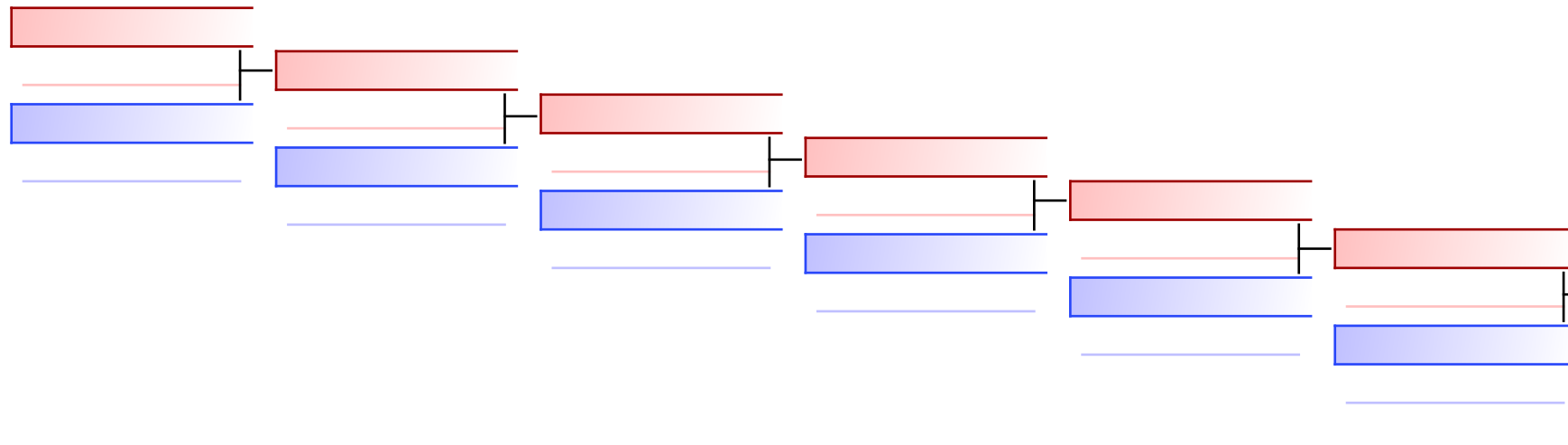

Schramm Julian (TV Fürth,GER)
027 Heian San. 1760
 Schramm Julian (TV Fürth,GER)
 Hauck Otto (KD-Untermerzbach,GER)
1600

REPECHAGE: (1)

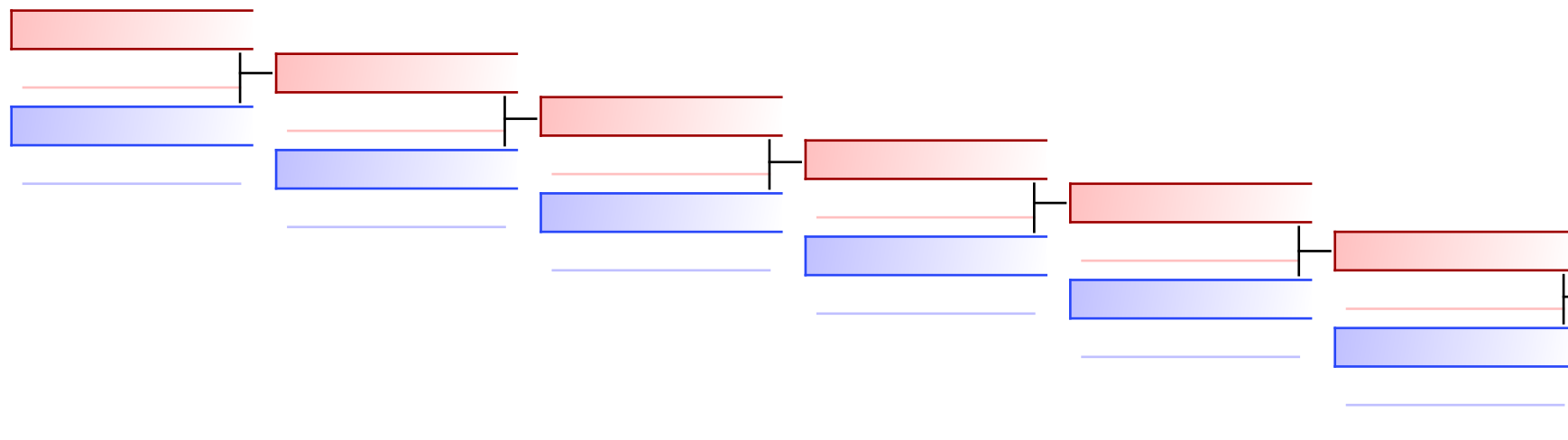

Kruzel Joshua (KD-Untermerzbach,GER)
025 Heian Sho. 1650
 Ebert Tilman (TSV Jahn 1892 Wü)
 Ebert Tilman (TSV Jahn 1892 Würzburg e.V.,GER)
025 Heian Sho. 1690

Referees:							
-----------	--	--	--	--	--	--	--

KATA Schüler B weiblich

OFFENE UNTERFRÄNKISCHE KARATE BEZIRKSMEISTERSCHAFT & NEWCOMER KARATE TURNIER 2024, Hermasweg 1 97506 Grafenrheinfeld, GER

2024-10-12

Tatami
2 11:30

Pool
1/1

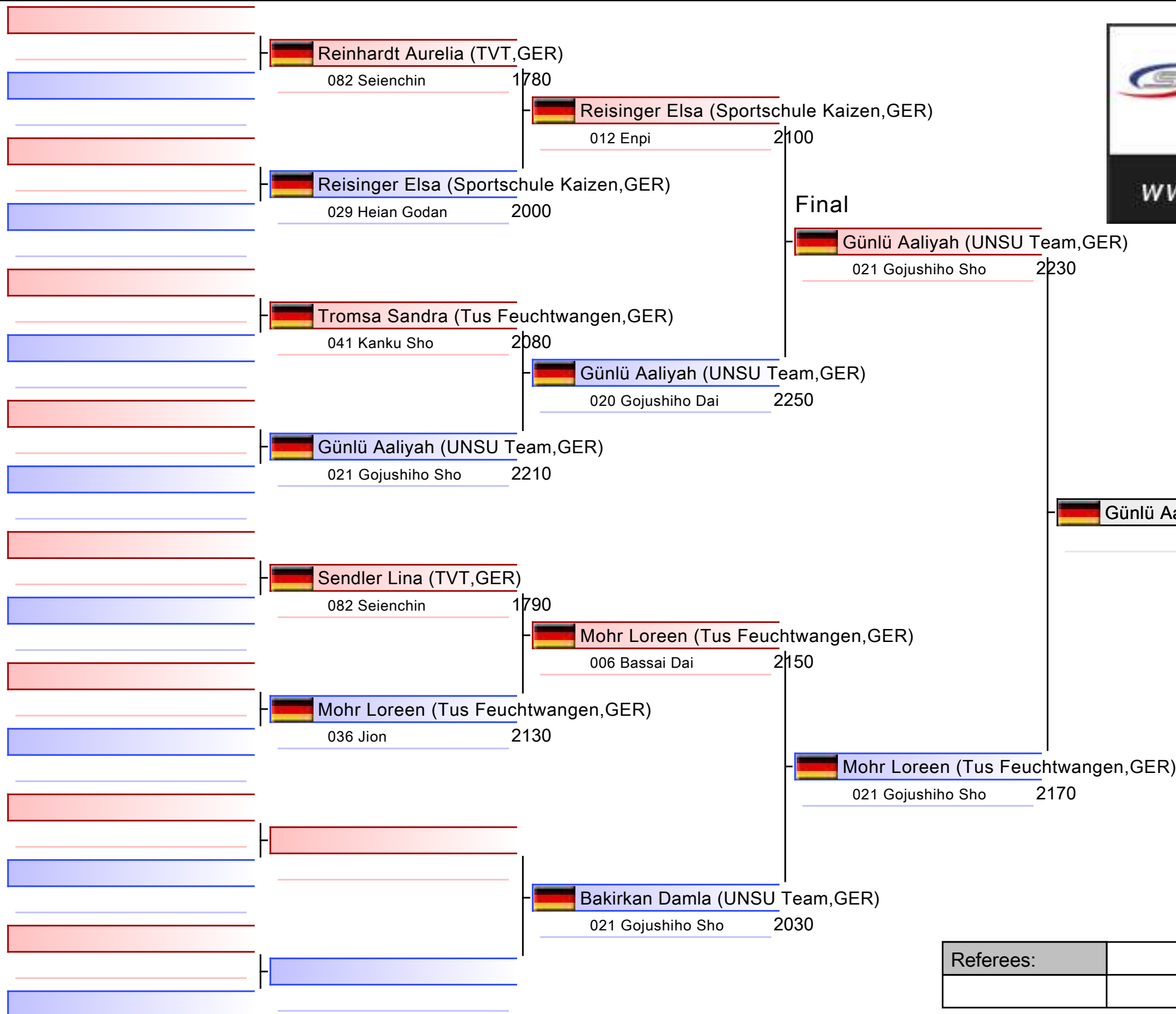

1. GÜNLÜ AALIYAH (UNSU TEAM,GER)
2. MOHR LOREEN (TUS FEUCHTWANGEN,GER)
3. TROMSA SANDRA (TUS FEUCHTWANGEN,GER)
3. BAKIRKAN DAMLA (UNSU TEAM,GER)
5. REISINGER ELSA (SPORTSCHULE KAIZEN,GER)
5. SENDLER LINA (TVT,GER)

Referees:			

KATA Schüler B weiblich

OFFENE UNTERFRÄNKISCHE KARATE BEZIRKSMEISTERSCHAFT & NEWCOMER KARATE TURNIER 2024

2024-10-12

Tatami

2 11:50

Pool

1

(c)sportdata GmbH & Co KG 2000-2024 (2024-10-12 18:43) v 10.2.0 build 1 (2024-09-26 10:14 CET) License: Online_Event_ID-8506_OFFENEUNTERFRNKISCHEKARATEBEZIRKSMEISTERSCHAFTNEWCOMERKARATETURNIER2024

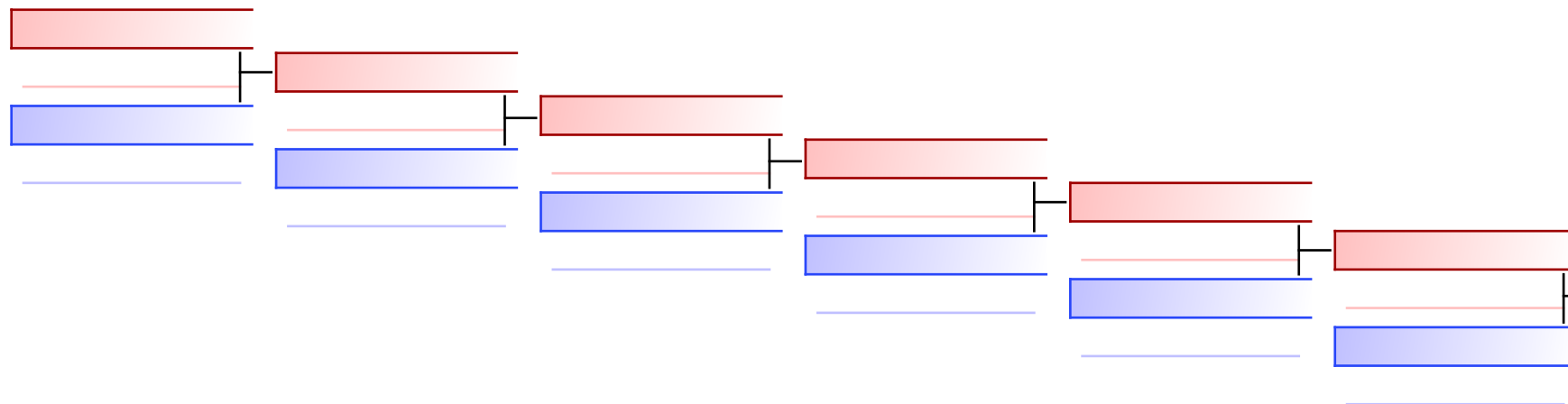

Tromsa Sandra (Tus Feuchtwangen,GER)
036 Jion | 2100
 Tromsa Sandra (Tus Feuchtwang
 Reisinger Elsa (Sportschule Kaizen,GER)
065 Oyadomari. 0

REPECHAGE: (1)

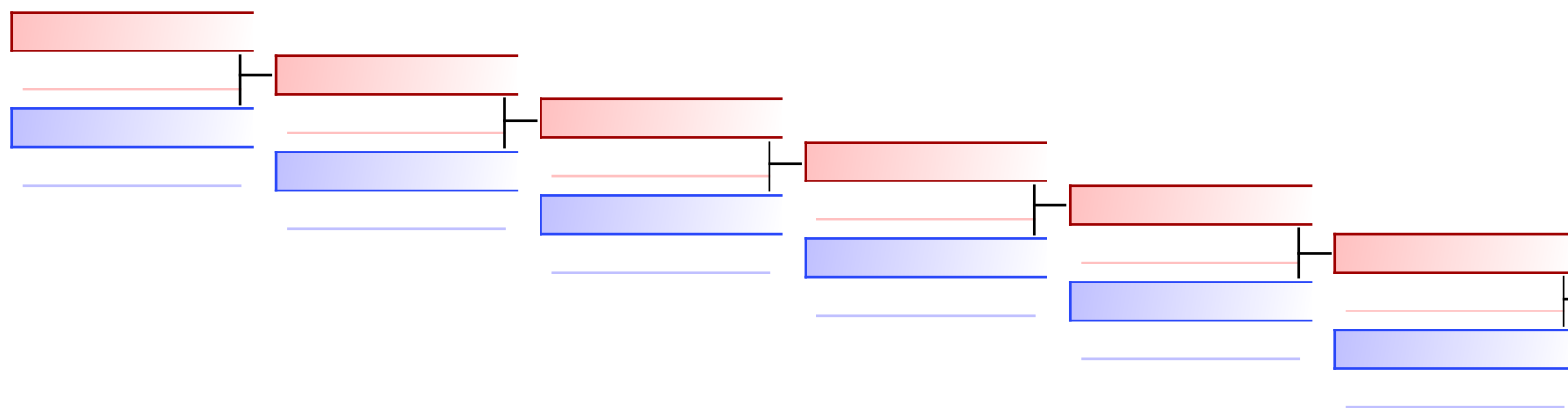

Sandler Lina (TVT,GER)
083 Seipai | 1850
 Bakirkan Damla (UNSU Team,GE
 Bakirkan Damla (UNSU Team,GER)
006 Bassai Da. 1970

Referees:							
-----------	--	--	--	--	--	--	--









KUMITE Jugend +70kg männlich - Round Robin (each against each)

OFFENE UNTERFRÄNKISCHE KARATE BEZIRKSMEISTERSCHAFT & NEWCOMER KARATE TURNIER 2024, Hermasweg 1 97506 Grafenrheinfeld, GER

2024-10-12

Tatami
3 15:35

Pool
1/1

1	 Bail Jonas (Post SV Bamberg,GER)	4	 Krämer Jonas (KD-Untermerzbach,GER)
2	 Krämer Jonas (KD-Untermerzbach,GER)	6	
3	 Bail Jonas (Post SV Bamberg,GER)	3	 Bail Jonas (Post SV Bamberg,GER)
4	 Sell Hannes (Budokan SW,GER)	1	
5	 Krämer Jonas (KD-Untermerzbach,GER)	0	 Sell Hannes (Budokan SW,GER)
6	 Sell Hannes (Budokan SW,GER)	1	



1. BAIL JONAS (POST SV BAMBERG)
2. KRÄMER JONAS (KARATE DOJO UNTERMERZBACH)
3. SELL HANNES (BUDOKAN 72 E.V. SCHWEINFURT)

1. BAIL JONAS (POST SV BAMBERG,GER)
2. KRÄMER JONAS (KD-UNTERMERZBACH,GER)
3. SELL HANNES (BUDOKAN SW,GER)

Referees:			









KUMITE Jugend -52kg männlich - Round Robin (each against each)

OFFENE UNTERFRÄNKISCHE KARATE BEZIRKSMEISTERSCHAFT & NEWCOMER KARATE TURNIER 2024, Hermasweg 1 97506 Grafenrheinfeld, GER

2024-10-12

Tatami
3 15:20

Pool
1/1

1	 Vogl Simon (TV Burglengenfeld,GER)	6	 Vogl Simon (TV Burglengenfeld,GER)
2	 Zeller Jaron (SV Abenberg,GER)	0	
3	 Vogl Simon (TV Burglengenfeld,GER)	4	 Vogl Simon (TV Burglengenfeld,GER)
4	 Canci Domenik (TVK,GER)	3	
5	 Zeller Jaron (SV Abenberg,GER)	0	 Canci Domenik (TVK,GER)
6	 Canci Domenik (TVK,GER)	8	



1. VOGL SIMON (TV BURGLENGENFELD,GER)
2. CANCI DOMENIK (TVK,GER)
3. ZELLER JARON (SV ABENBERG,GER)

Referees:			

KUMITE Jugend -54kg weiblich

OFFENE UNTERFRÄNKISCHE KARATE BEZIRKSMEISTERSCHAFT & NEWCOMER KARATE TURNIER 2024, Hermasweg 1 97506 Grafenheinfeld, GER

Tatami

Pool

1/1

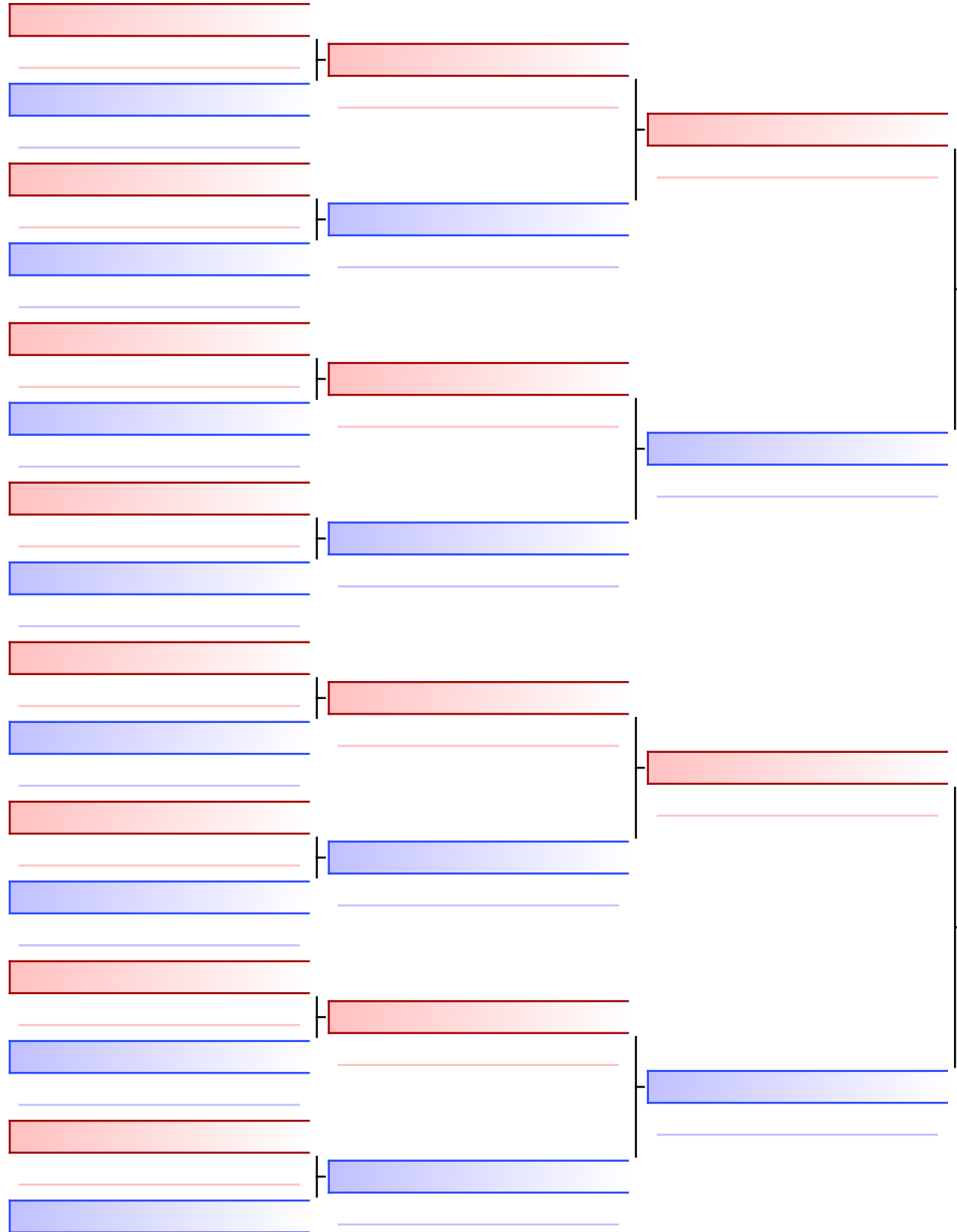

Final

Müller Theresia (HAB,GER)
5

Morina Lona (Budokan SW,GER)

Morina Lona (Budokan SW,GER)
5

1. MORINA LONA (BUDOKAN SW,GER)
2. MÜLLER THERESIA (HAB,GER)

Referees:			

KUMITE Kinder A -30kg männlich

OFFENE UNTERFRÄNKISCHE KARATE BEZIRKSMEISTERSCHAFT & NEWCOMER KARATE TURNIER 2024, Hermasweg 1 97506 Grafenheinfeld, GER

2024-10-12

Tatami
3 14:00

Pool
1/1

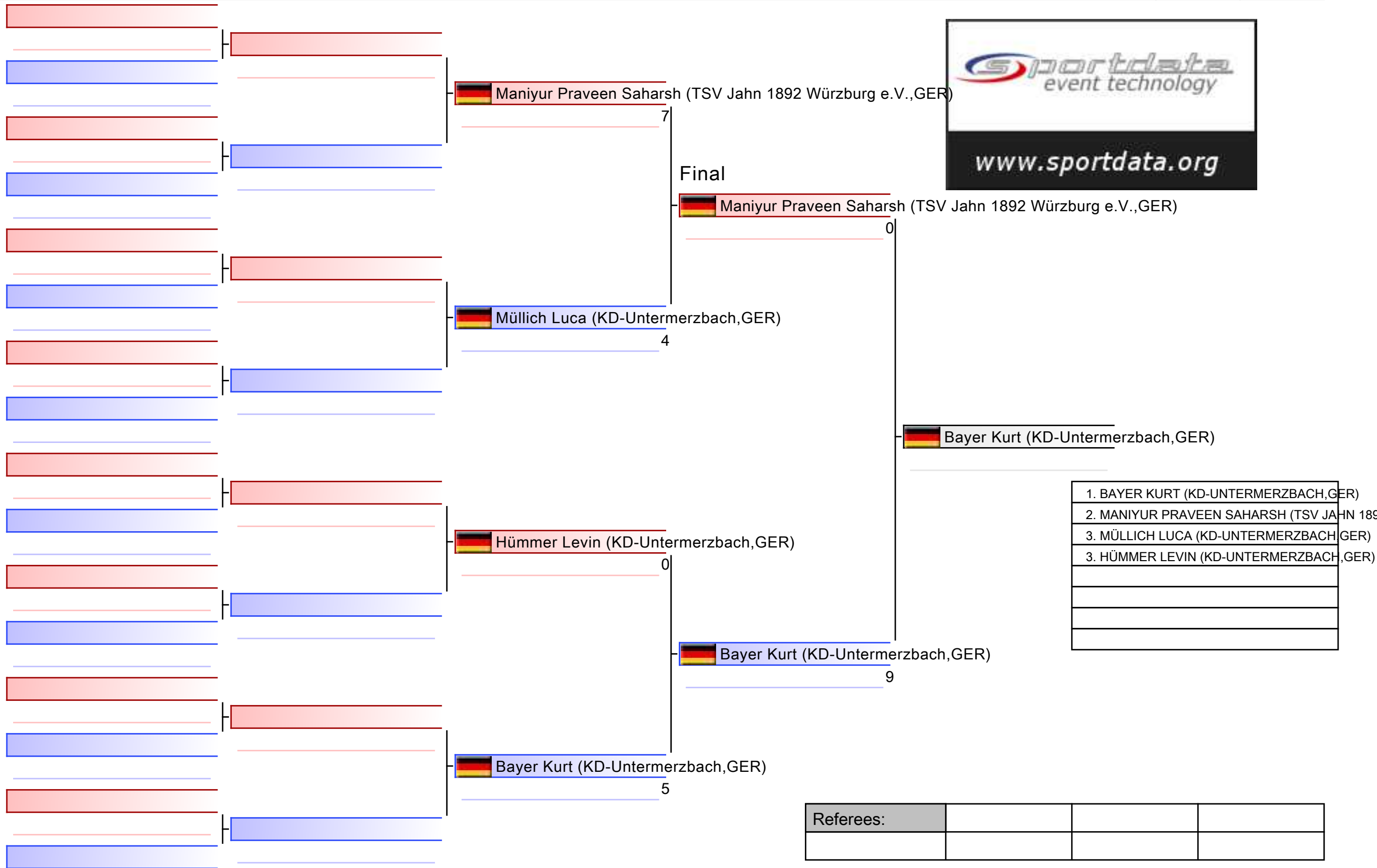

KUMITE Kinder A -30kg männlich

OFFENE UNTERFRÄNKISCHE KARATE BEZIRKSMEISTERSCHAFT & NEWCOMER KARATE TURNIER 2024

Tatami

Pool

1

(c)sportdata GmbH & Co KG 2000-2024 (2024-10-12 18:43) v 10.2.0 build 1 (2024-09-26 10:14 CET) License: Online_Event_ID-8506_OFFENEUNTERFRNKISCHEKARATEBEZIRKSMEISTERSCHAFTNEWCOMERKARATETURNIER2024

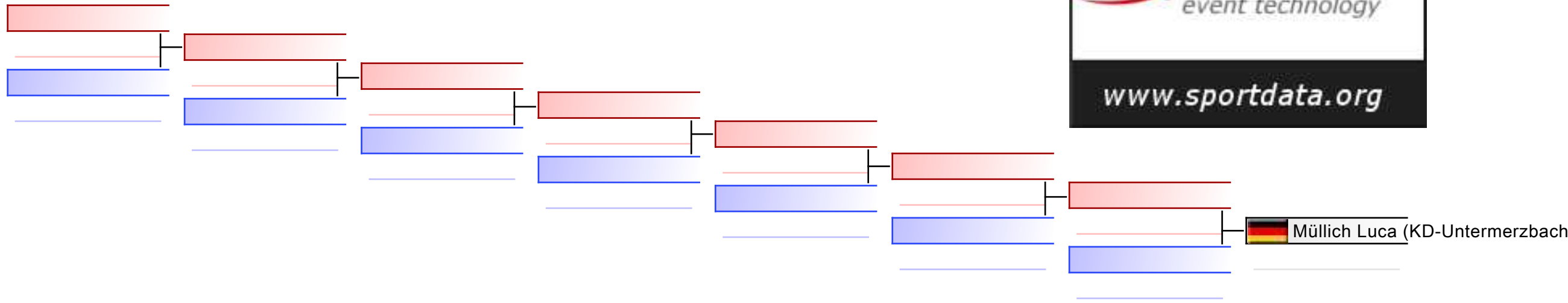

REPECHAGE: (1)

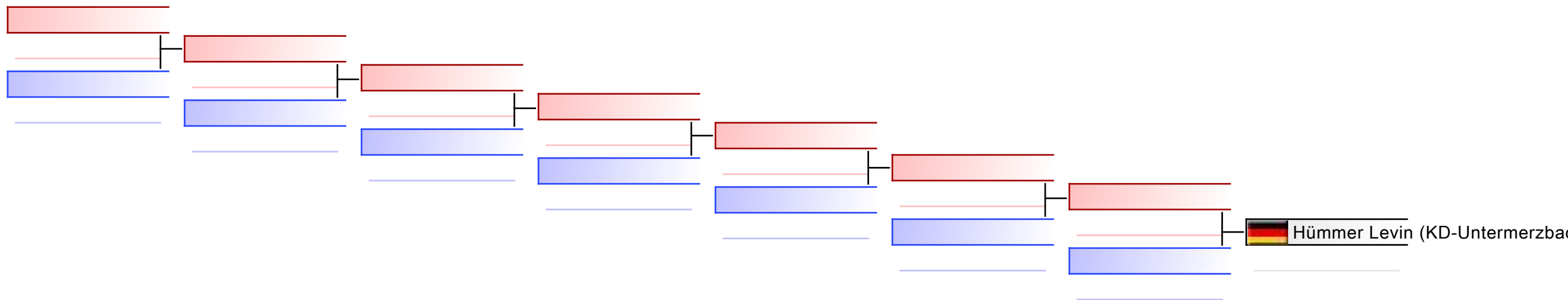

Referees:							
-----------	--	--	--	--	--	--	--









KUMITE Schüler B weiblich - Round Robin (each against each)

OFFENE UNTERFRÄNKISCHE KARATE BEZIRKSMEISTERSCHAFT & NEWCOMER KARATE TURNIER 2024, Hermasweg 1 97506 Grafenrheinfeld, GER

2024-10-12

Tatami
2 14:15

Pool
1/1

1	 Kusnezov Vanessa (KDNaila,GER)	4	 Kusnezov Vanessa (KDNaila,GER)
2	 Schäfer Sophie (Shotokan,GER)	0	
3	 Kusnezov Vanessa (KDNaila,GER)	0	 Böckelmann Amelie (TV Fürth,GER)
4	 Böckelmann Amelie (TV Fürth,GER)	8	
5	 Schäfer Sophie (Shotokan,GER)	0	 Böckelmann Amelie (TV Fürth,GER)
6	 Böckelmann Amelie (TV Fürth,GER)	8	



1. BÖCKELMANN AMELIE (TV FÜRTH,GER)
2. KUSNEZOV VANESSA (KDNAILA,GER)
3. SCHÄFER SOPHIE (SHOTOKAN,GER)

Referees:			

KUMITE TEAM KINDER A/B MÄNNLICH

OFFENE UNTERFRÄNKISCHE KARATE BEZIRKSMEISTERSCHAFT & NEWCOMER KARATE TURNIER 2024, Hermasweg 1 97506 Grafenrheinfeld, GER

Tatami

Pool

1/1

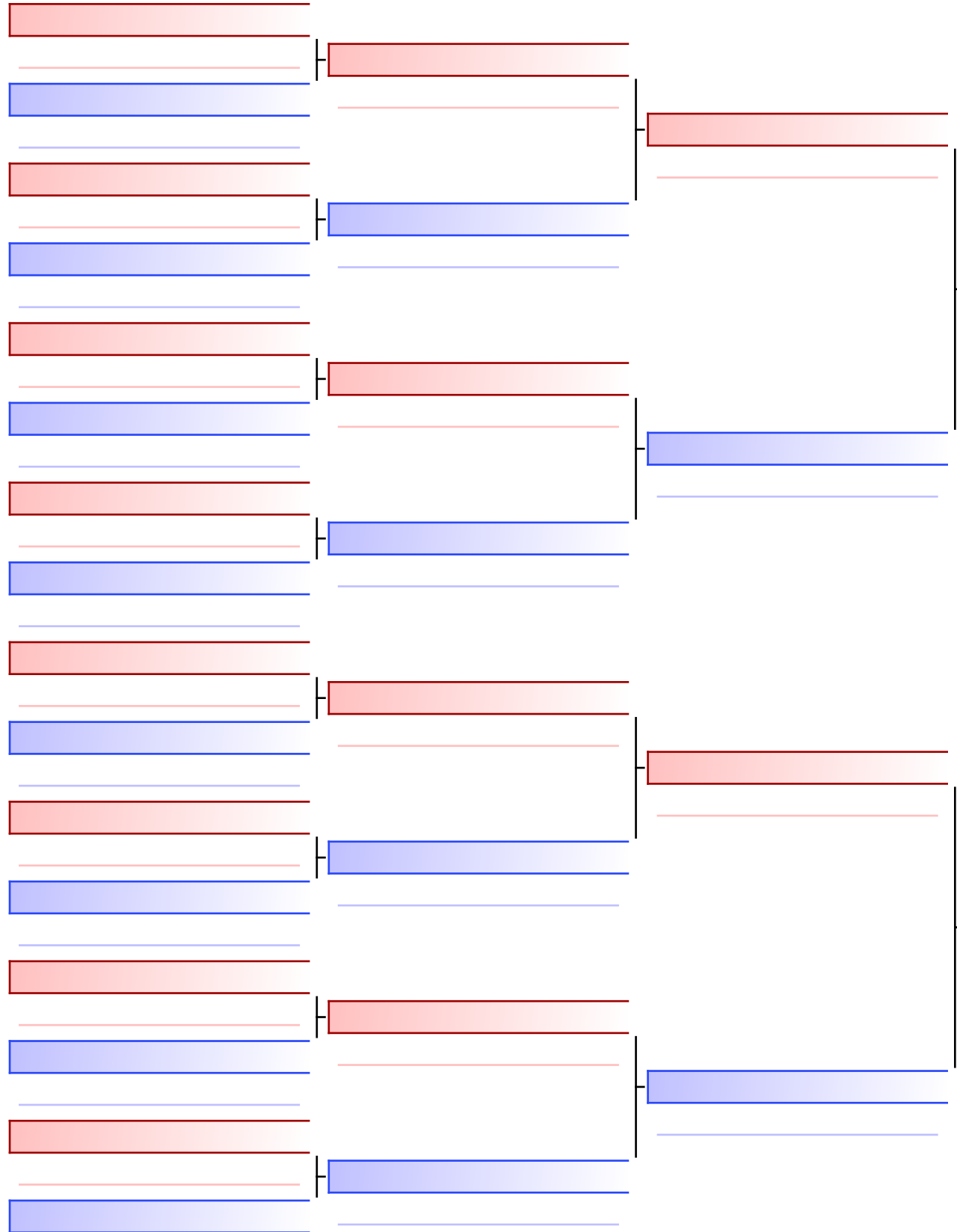

Final

KD Untermerzbach 1 (Bayer, Fischer, Rößner) (KD-Untermerzbach,GER)

2

KD Untermerzbach 1 (Bayer, Fischer, Rößner) (KD-Untermerzbach,GER)

1. KD UNTERMERZBACH 1 (KD-UNTERMERZBACH)
2. KD UNTERMERZBACH 2 (KD-UNTERMERZBACH)

KD Untermerzbach 2 (Bayer, Hümmer, Müllich) (KD-Untermerzbach,GER)

0

Referees:			

Kata Junioren/Leistungsklasse weiblich

OFFENE UNTERFRÄNKISCHE KARATE BEZIRKSMEISTERSCHAFT & NEWCOMER KARATE TURNIER 2024, Hermasweg 1 97506 Grafenrheinfeld, GER

2024-10-12

Tatami
2 12:40

Pool
1/1

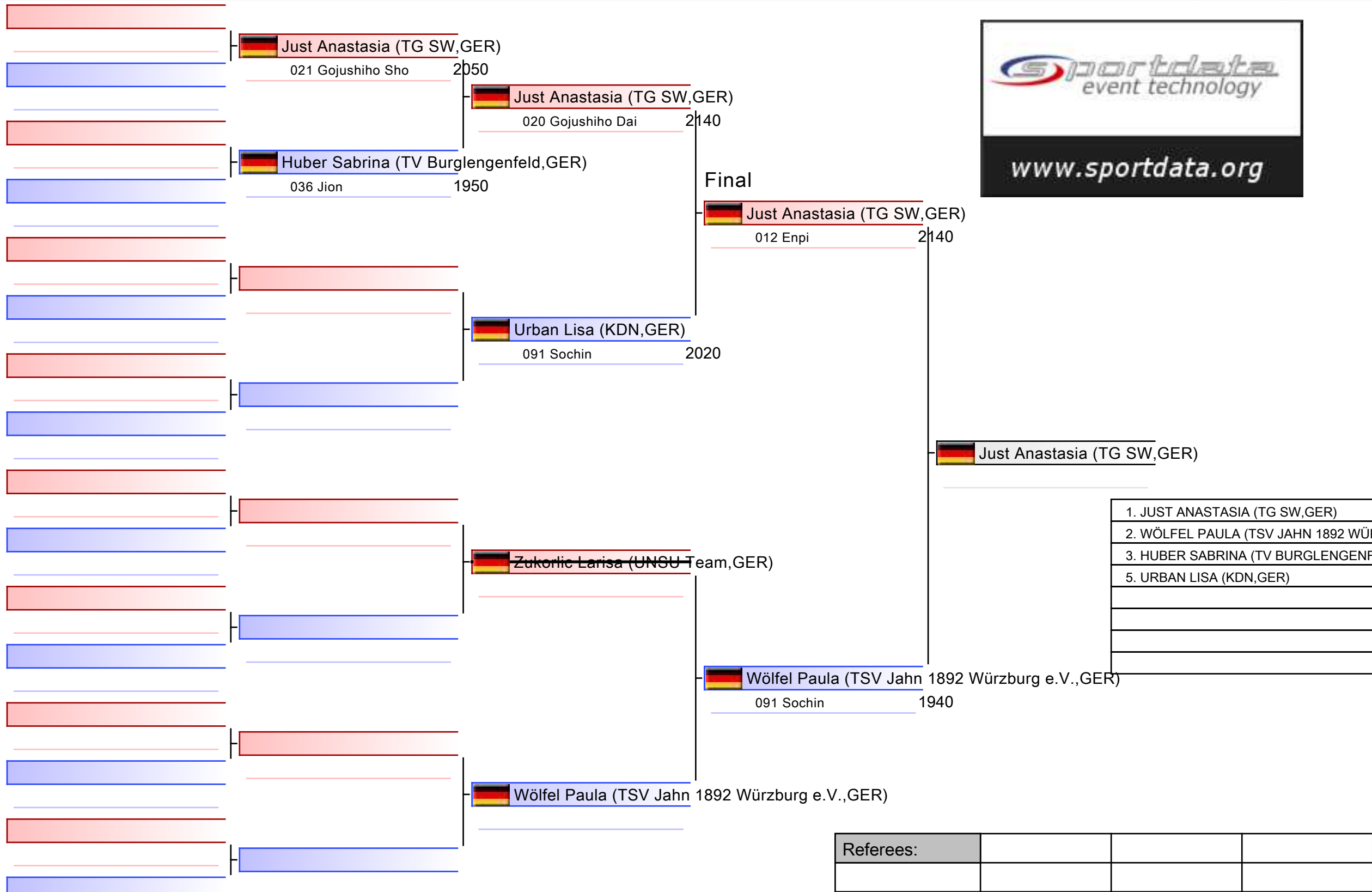

Kata Junioren/Leistungsklasse weiblich

OFFENE UNTERFRÄNKISCHE KARATE BEZIRKSMEISTERSCHAFT & NEWCOMER KARATE TURNIER 2024

2024-10-12

Tatami
2 12:55

Pool
1

(c)sportdata GmbH & Co KG 2000-2024 (2024-10-12 18:42) v 10.2.0 build 1 (2024-09-26 10:14 CET) License: Online_Event_ID-8506_OFFENEUNTERFRNKISCHEKARATEBEZIRKSMEISTERSCHAFTNEWCOMERKARATETURNIER2024

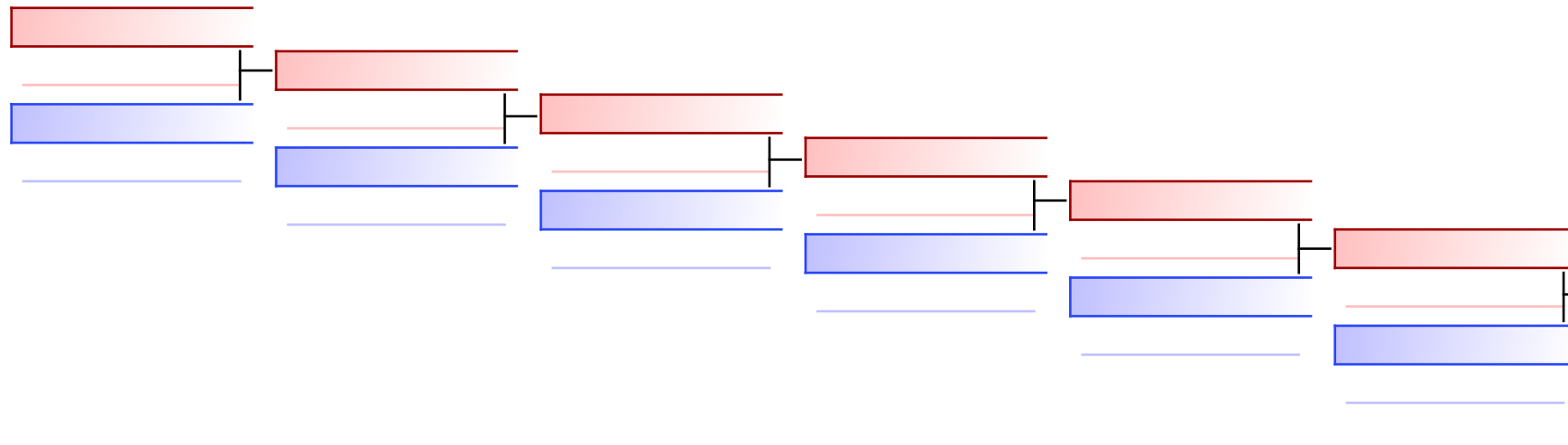

Huber Sabrina (TV Burglengenfeld,GER)
060 Nijushiho 1990
 Huber Sabrina (TV Burglengenfeld)
 Urban Lisa (KDN,GER)
012 Enpi 1950

REPECHAGE: (1)

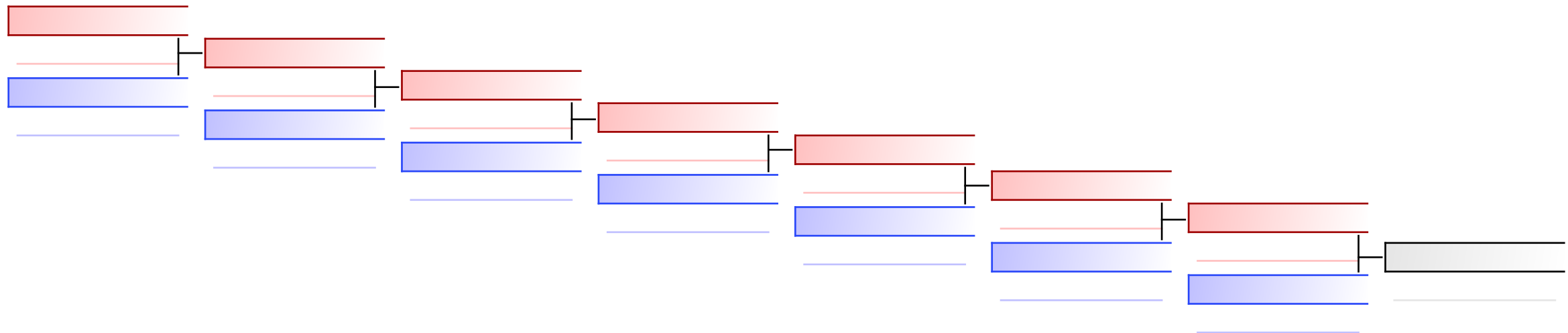

Referees:							
-----------	--	--	--	--	--	--	--

Kata Junioren männlich

OFFENE UNTERFRÄNKISCHE KARATE BEZIRKSMEISTERSCHAFT & NEWCOMER KARATE TURNIER 2024, Hermasweg 1 97506 Grafenheinfeld, GER

Tatami

Pool

1/1

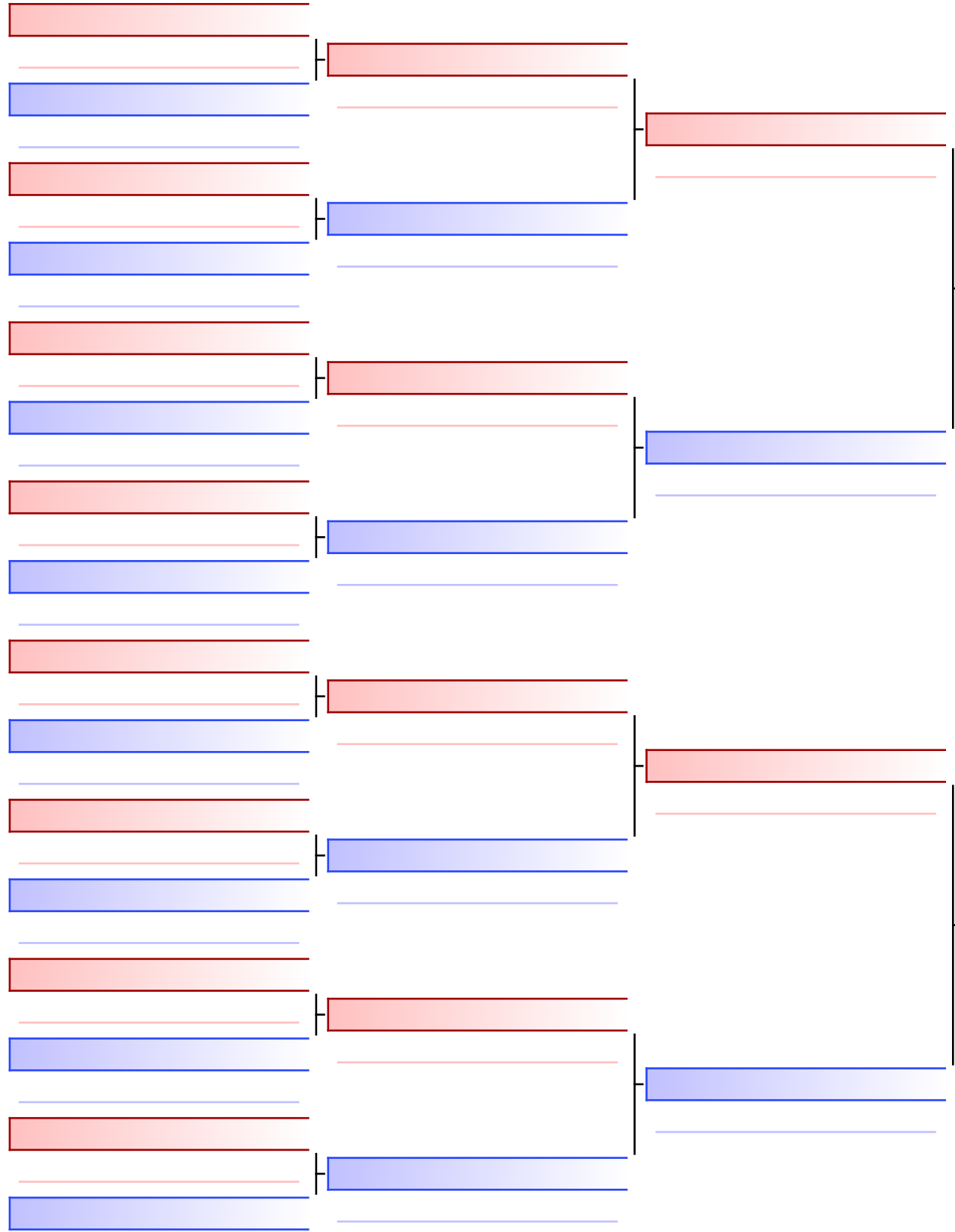

Final

 **Bätz Phil (TVT,GER)**
083 Seipai 1900

 **Kraus Laurenz (Sportschule Kaizen,GER)**

 **Kraus Laurenz (Sportschule Kaizen,GER)**
068 Papuren 2010



1. KRAUS LAURENZ (SPORTSCHULE KAIZEN,GER)
2. BÄTZ PHIL (TVT,GER)

Referees:			

Kata Kinder B mixed

OFFENE UNTERFRÄNKISCHE KARATE BEZIRKSMEISTERSCHAFT & NEWCOMER KARATE TURNIER 2024, Hermasweg 1 97506 Grafenrheinfeld, GER

2024-10-12

Tatami
1 11:30

Pool
1/1

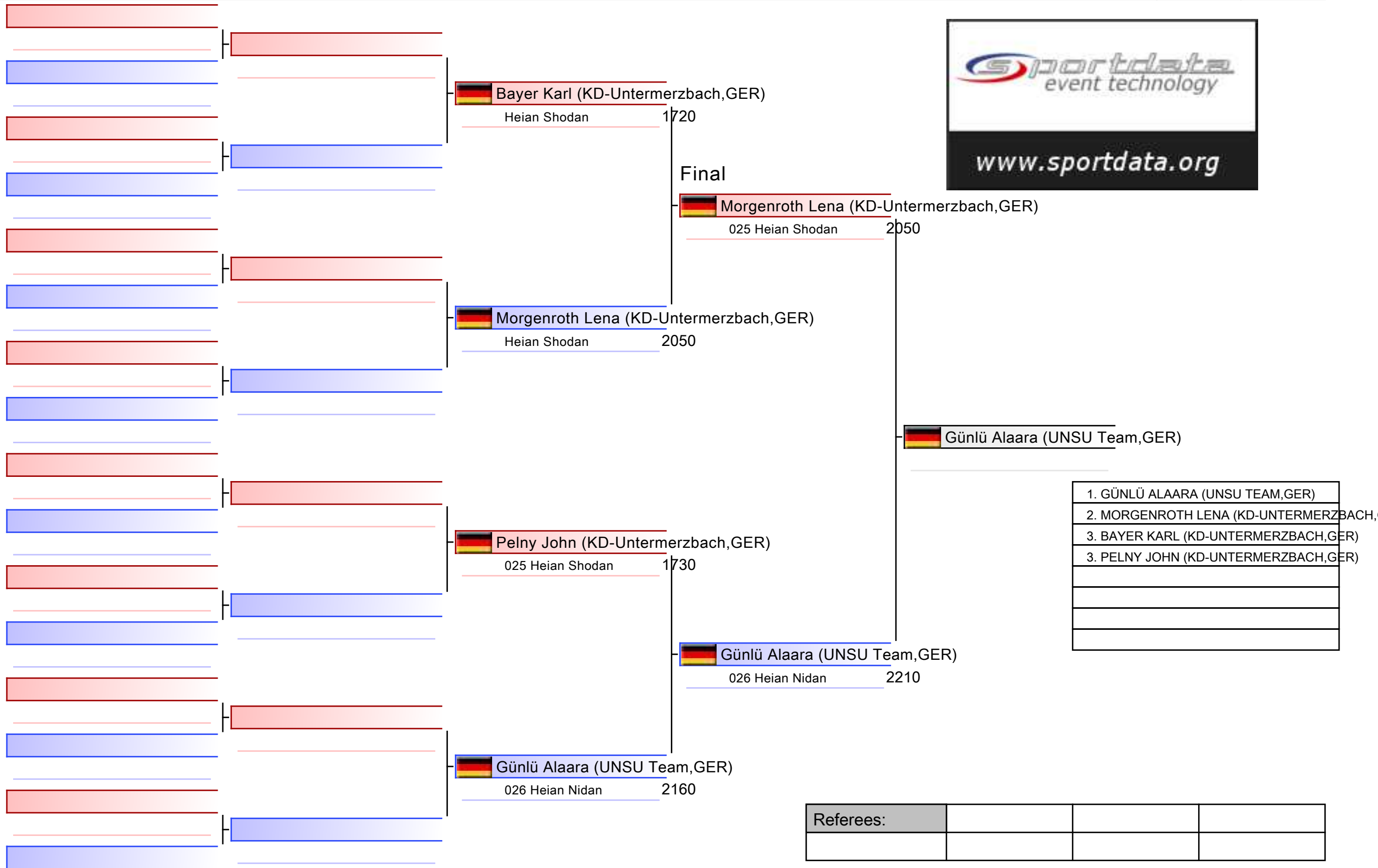

Kata Kinder B mixed

OFFENE UNTERFRÄNKISCHE KARATE BEZIRKSMEISTERSCHAFT & NEWCOMER KARATE TURNIER 2024

Tatami

Pool

1

(c)sportdata GmbH & Co KG 2000-2024 (2024-10-12 18:42) v 10.2.0 build 1 (2024-09-26 10:14 CET) License: Online_Event_ID-8506_OFFENEUNTERFRNKISCHEKARATEBEZIRKSMEISTERSCHAFTNEWCOMERKARATETURNIER2024

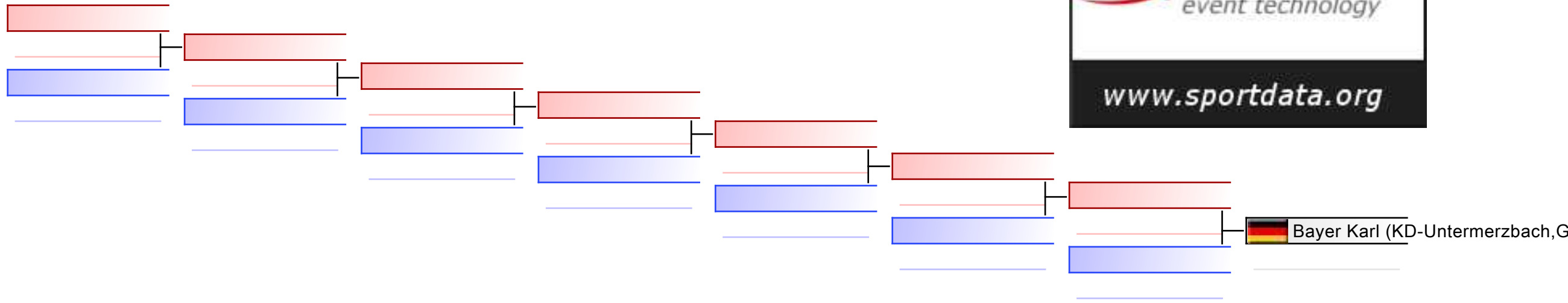

REPECHAGE: (1)

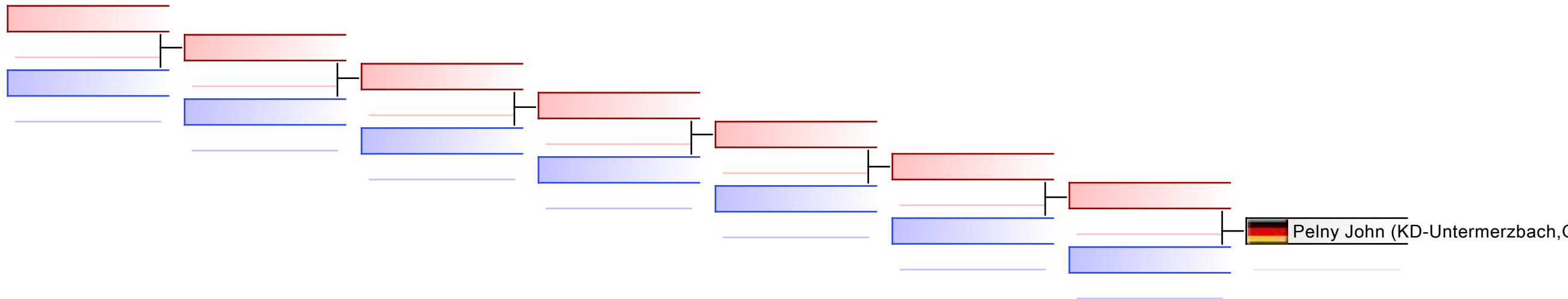

Referees:							
-----------	--	--	--	--	--	--	--

Kata Leistungsklasse männlich

OFFENE UNTERFRÄNKISCHE KARATE BEZIRKSMEISTERSCHAFT & NEWCOMER KARATE TURNIER 2024, Hermasweg 1 97506 Grafenrheinfeld, GER

2024-10-12

Tatami
2 13:10

Pool
1/1

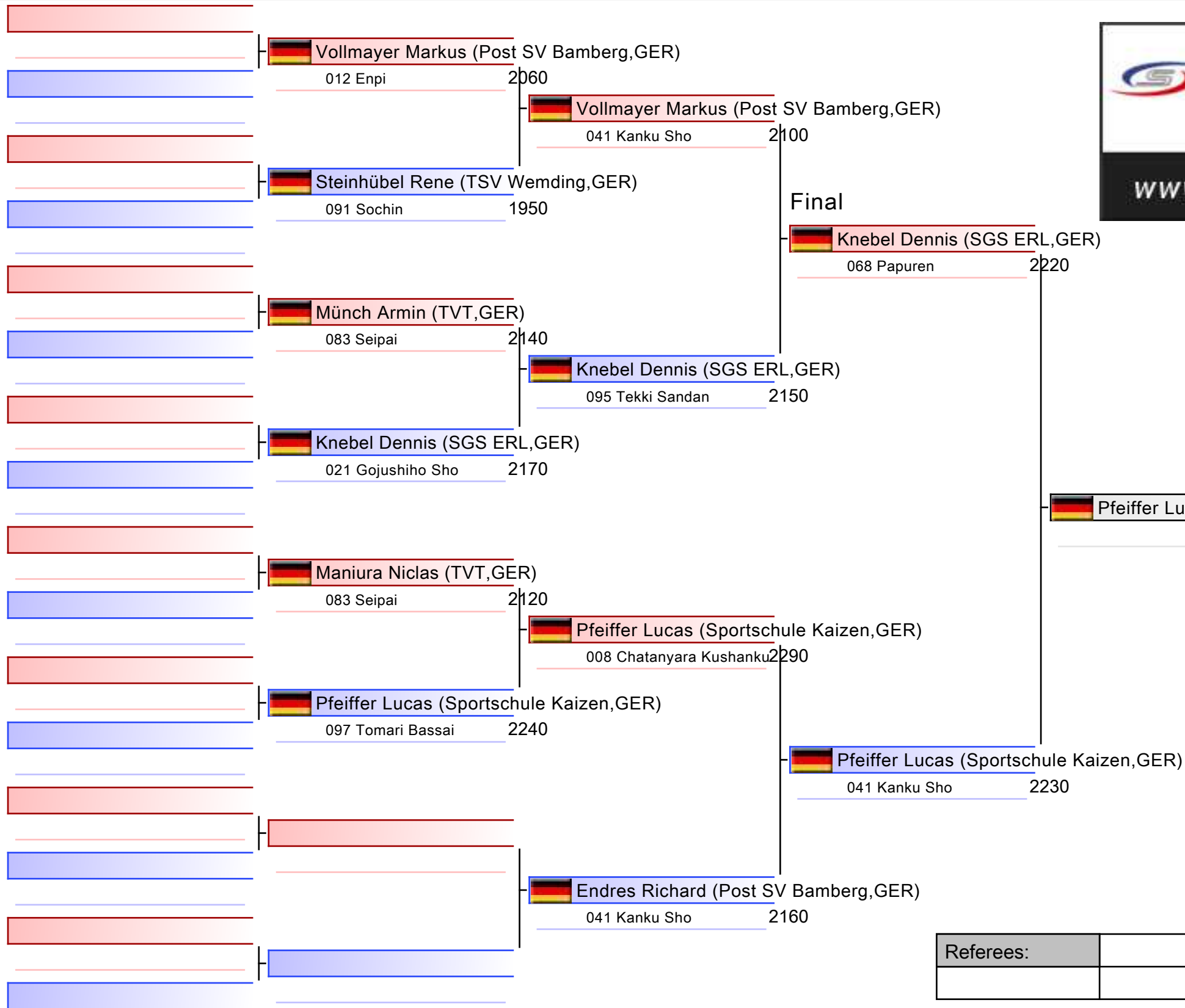

1. PFEIFFER LUCAS (SPORTSCHULE KAIZEN,GER)
2. KNEBEL DENNIS (SGS ERL,GER)
3. MÜNCH ARMIN (TVT,GER)
3. ENDRES RICHARD (POST SV BAMBERG,GER)
5. VOLLMAYER MARKUS (POST SV BAMBERG,GER)
5. MANIURA NICLAS (TVT,GER)

Referees:			

Kata Leistungsklasse männlich

OFFENE UNTERFRÄNKISCHE KARATE BEZIRKSMEISTERSCHAFT & NEWCOMER KARATE TURNIER 2024

2024-10-12

Tatami
2 13:35

Pool
1

(c)sportdata GmbH & Co KG 2000-2024 (2024-10-12 18:42) v 10.2.0 build 1 (2024-09-26 10:14 CET) License: Online_Event_ID-8506_OFFENEUNTERFRNKISCHEKARATEBEZIRKSMEISTERSCHAFTNEWCOMERKARATETURNIER2024

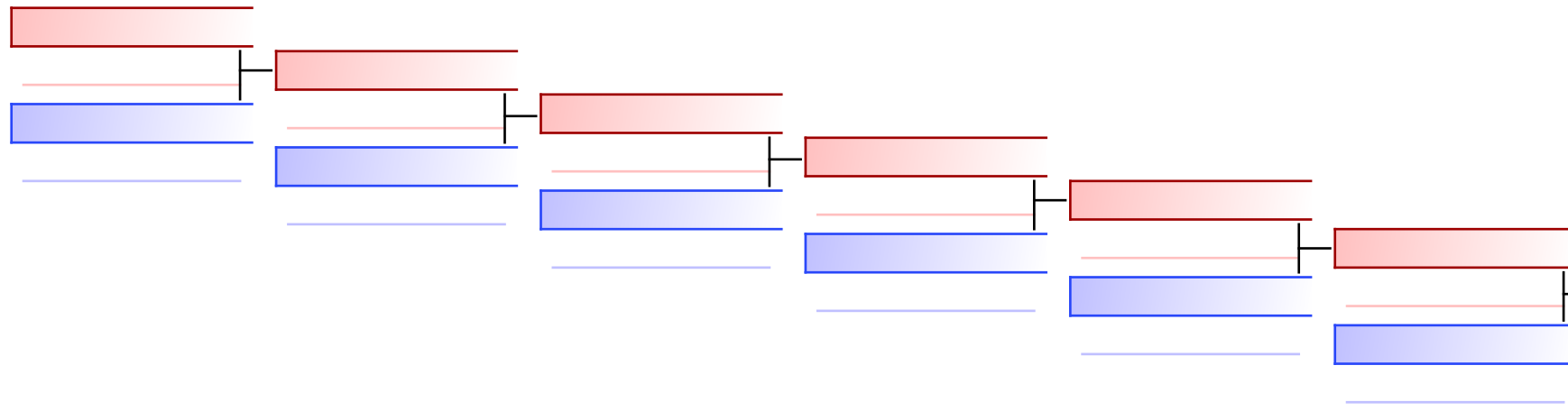

Münch Armin (TVT,GER)
092 Suparinpe. | 2180
 Münch Armin (TVT,GER)
 Vollmayer Markus (Post SV Bamberg,GER)
099 Unsu | 2060

REPECHAGE: (1)

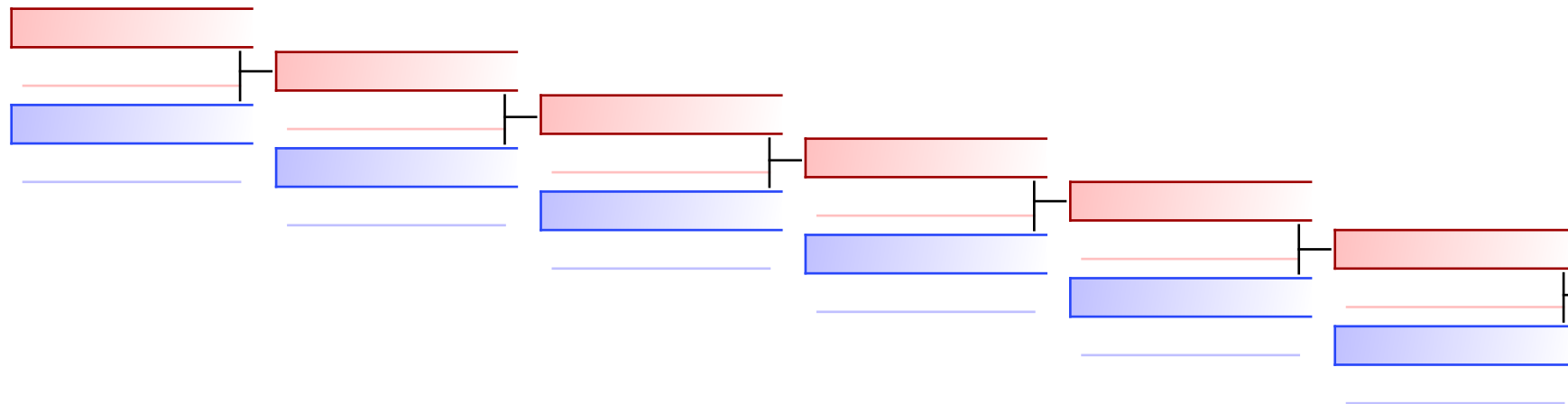

Maniura Niclas (TVT,GER)
047 Kururunfa | 2180
 Endres Richard (Post SV Bamberg,GER)
 Endres Richard (Post SV Bamberg,GER)
078 Sansai | 2180

Referees:							
-----------	--	--	--	--	--	--	--

Kata Masterklasse weiblich

OFFENE UNTERFRÄNKISCHE KARATE BEZIRKSMEISTERSCHAFT & NEWCOMER KARATE TURNIER 2024, Hermasweg 1 97506 Grafenrheinfeld, GER

Tatami

Pool

1/1

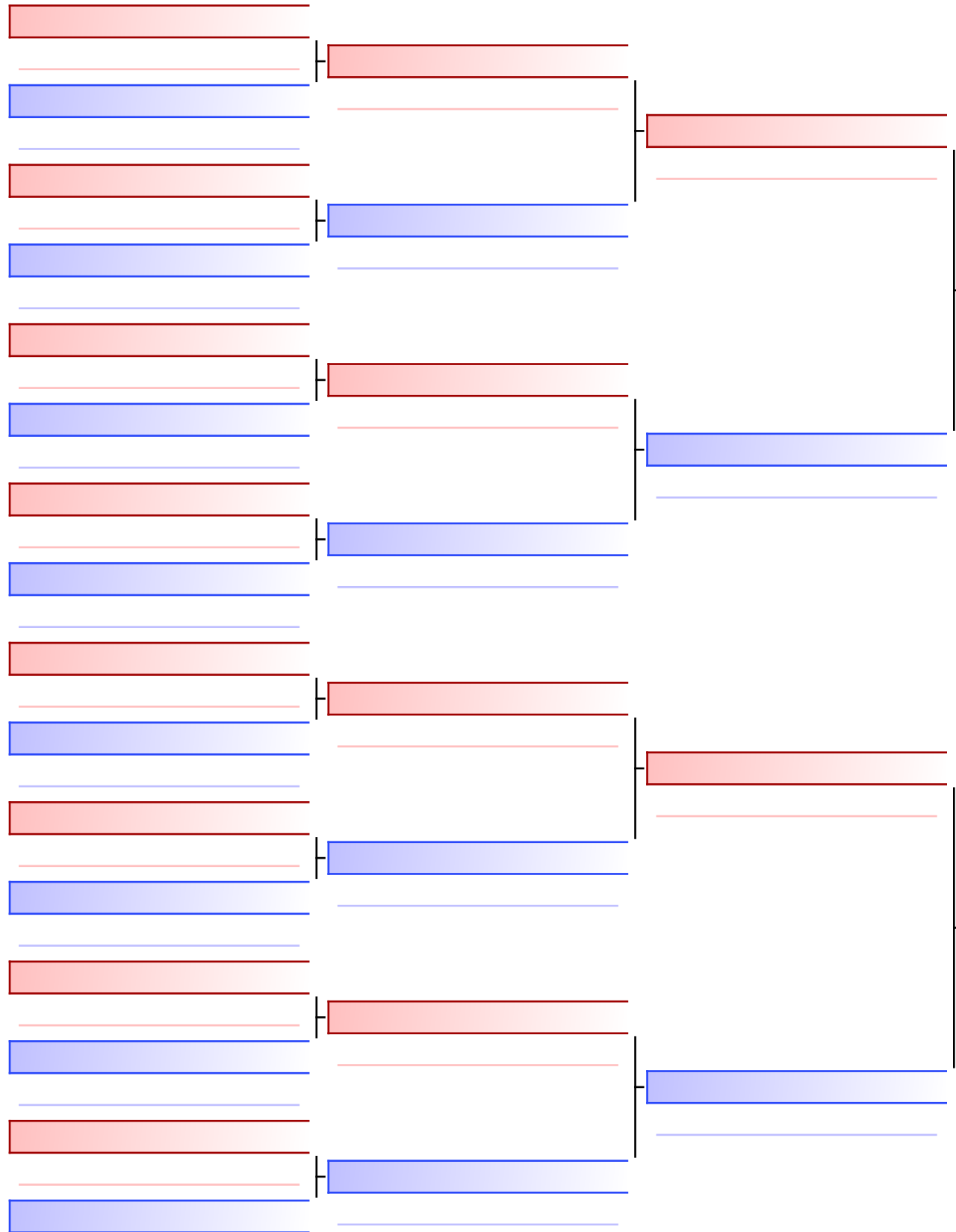

Final

 Bauer Andrea (KAR,GER)
060 Nijushiho 2020

 Huber Sabrina (TV Burglengelfeld,GER)

 Huber Sabrina (TV Burglengelfeld,GER)
060 Nijushiho 2100

1. HUBER SABRINA (TV BURGLENGELFELD,GER)
2. BAUER ANDREA (KAR,GER)

Referees:			

Kata Masterklasse Ü30/Ü35 männlich

OFFENE UNTERFRÄNKISCHE KARATE BEZIRKSMEISTERSCHAFT & NEWCOMER KARATE TURNIER 2024, Hermasweg 1 97506 Grafenheinfeld, GER

2024-10-12

Tatami

3 11:30

Pool

1/1

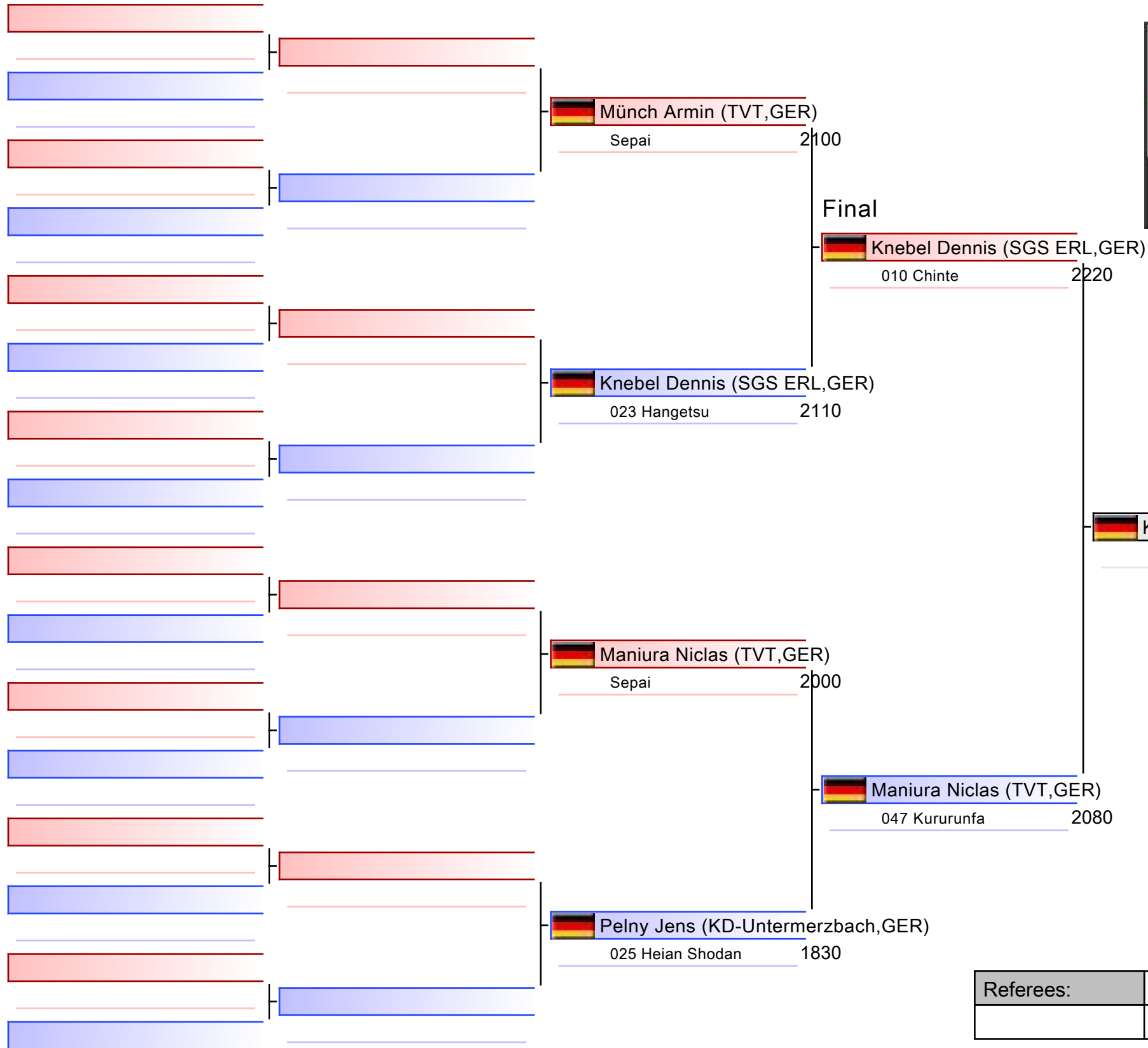

1. KNEBEL DENNIS (SGS ERL,GER)
2. MANIURA NICLAS (TVT,GER)
3. MÜNCH ARMIN (TVT,GER)
3. PELNY JENS (KD-UNTERMERZBACH,GER)

Referees:			

Kata Masterklasse Ü30/Ü35 männlich

OFFENE UNTERFRÄNKISCHE KARATE BEZIRKSMEISTERSCHAFT & NEWCOMER KARATE TURNIER 2024

Tatami

Pool

1

(c)sportdata GmbH & Co KG 2000-2024 (2024-10-12 18:42) v 10.2.0 build 1 (2024-09-26 10:14 CET) License: Online_Event_ID-8506_OFFENEUNTERFRNKISCHEKARATEBEZIRKSMEISTERSCHAFTNEWCOMERKARATETURNIER2024

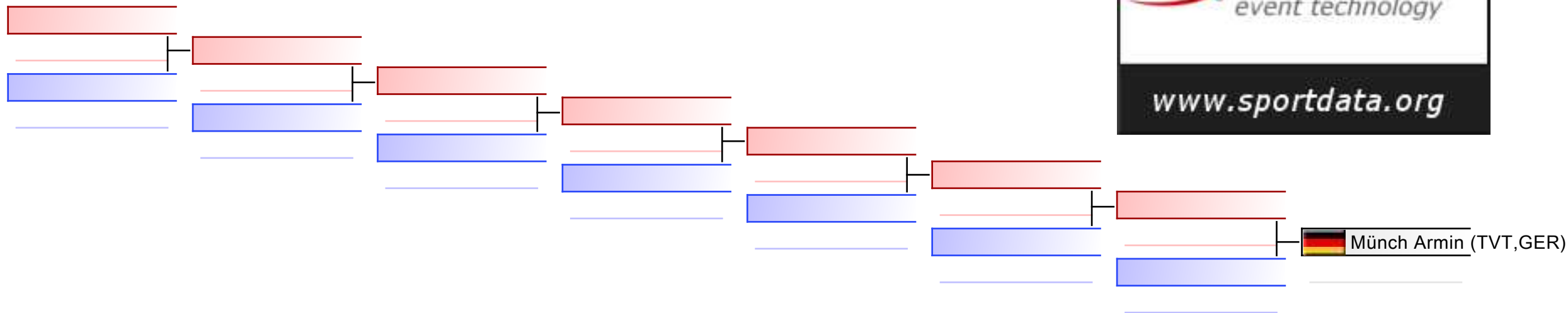

REPECHAGE: (1)

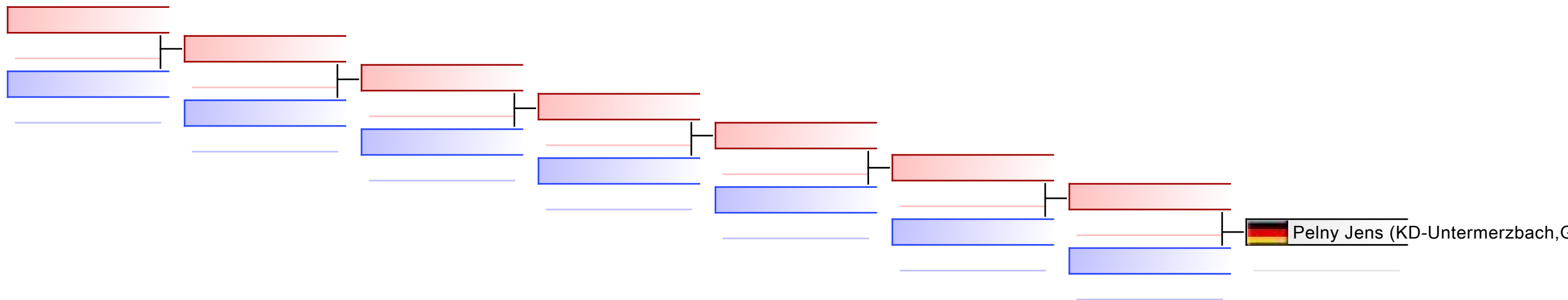

Referees:							
-----------	--	--	--	--	--	--	--

Kata Masterklasse Ü45 männlich

OFFENE UNTERFRÄNKISCHE KARATE BEZIRKSMEISTERSCHAFT & NEWCOMER KARATE TURNIER 2024, Hermasweg 1 97506 Grafenheinfeld, GER

2024-10-12

Tatami

3 11:45

Pool

1/1

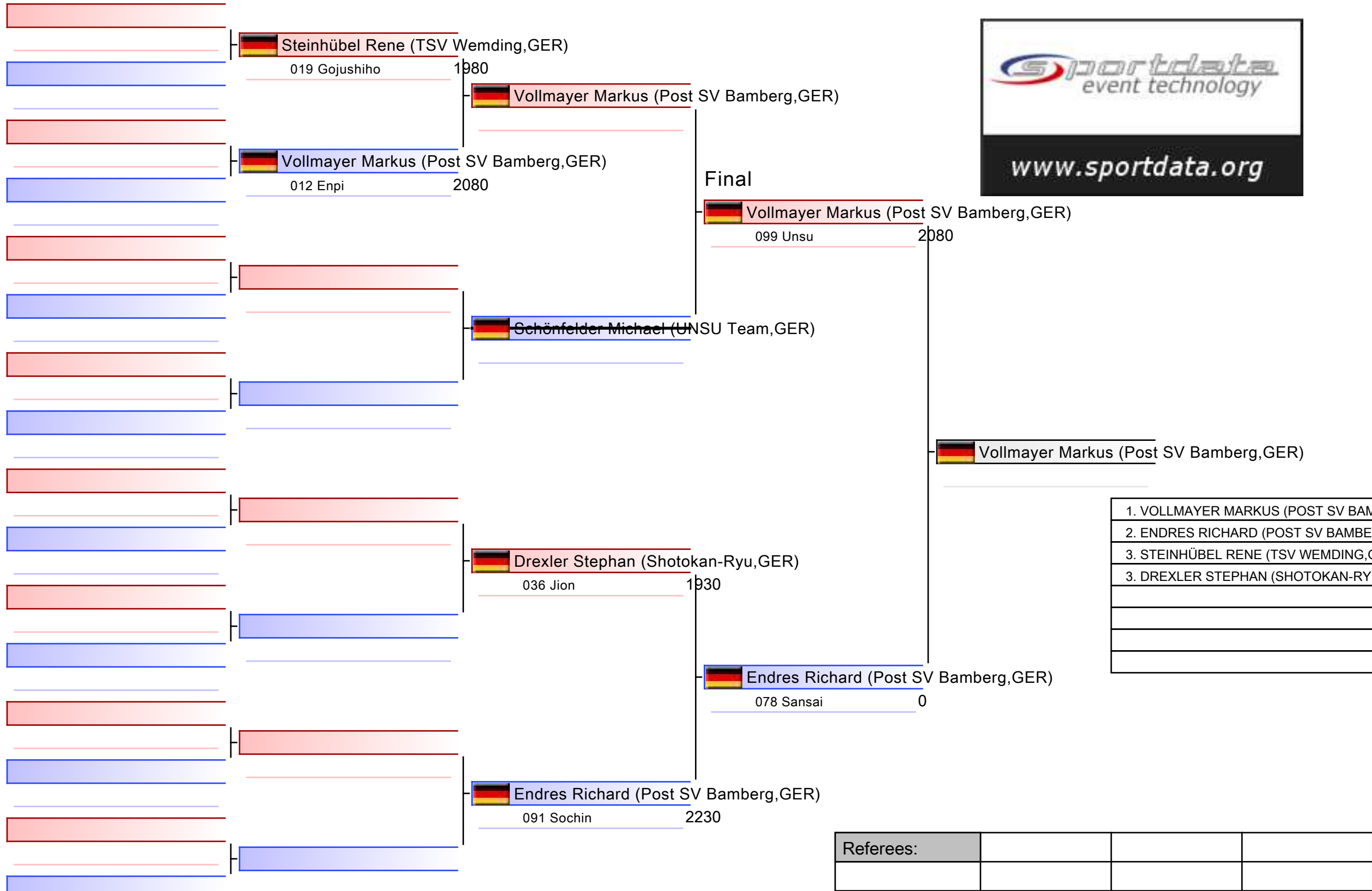

1. VOLLMAYER MARKUS (POST SV BAMBERG, GER)
2. ENDRES RICHARD (POST SV BAMBERG, GER)
3. STEINHÜBEL RENE (TSV WEMDING, GER)
3. DREXLER STEPHAN (SHOTOKAN-RYU, GER)

Referees:			

Kata Masterklasse Ü45 männlich

OFFENE UNTERFRÄNKISCHE KARATE BEZIRKSMEISTERSCHAFT & NEWCOMER KARATE TURNIER 2024

2024-10-12

Tatami

3 12:00

Pool

1

(c)sportdata GmbH & Co KG 2000-2024 (2024-10-12 18:42) v 10.2.0 build 1 (2024-09-26 10:14 CET) License: Online_Event_ID-8506_OFFENEUNTERFRNKISCHEKARATEBEZIRKSMEISTERSCHAFTNEWCOMERKARATETURNIER2024

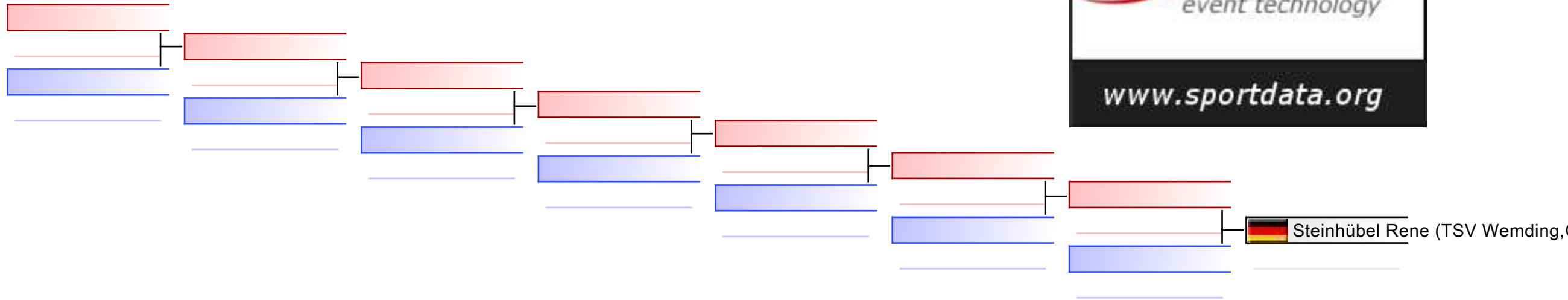

REPECHAGE: (1)

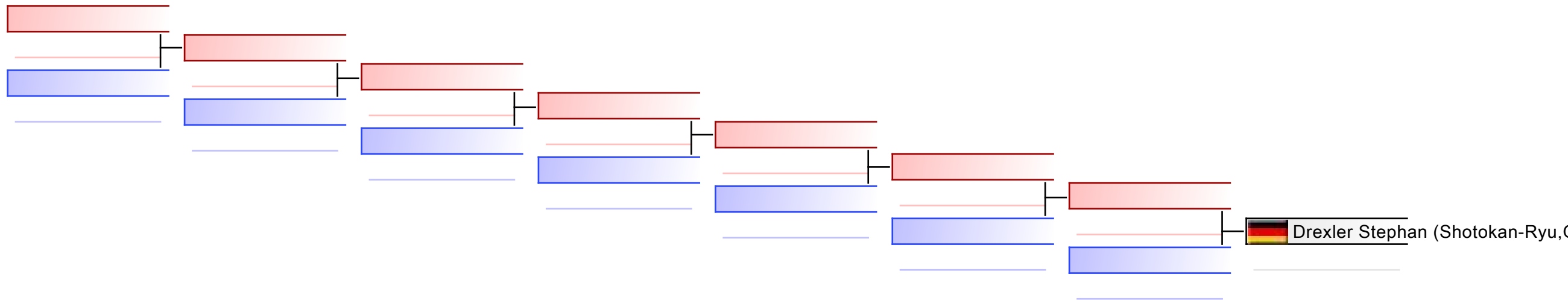

Referees:							
-----------	--	--	--	--	--	--	--

Kata Masterklasse Ü55/Ü65 männlich

OFFENE UNTERFRÄNKISCHE KARATE BEZIRKSMEISTERSCHAFT & NEWCOMER KARATE TURNIER 2024, Hermasweg 1 97506 Grafenrheinfeld, GER

2024-10-12

Tatami
3 12:20

Pool
1/1

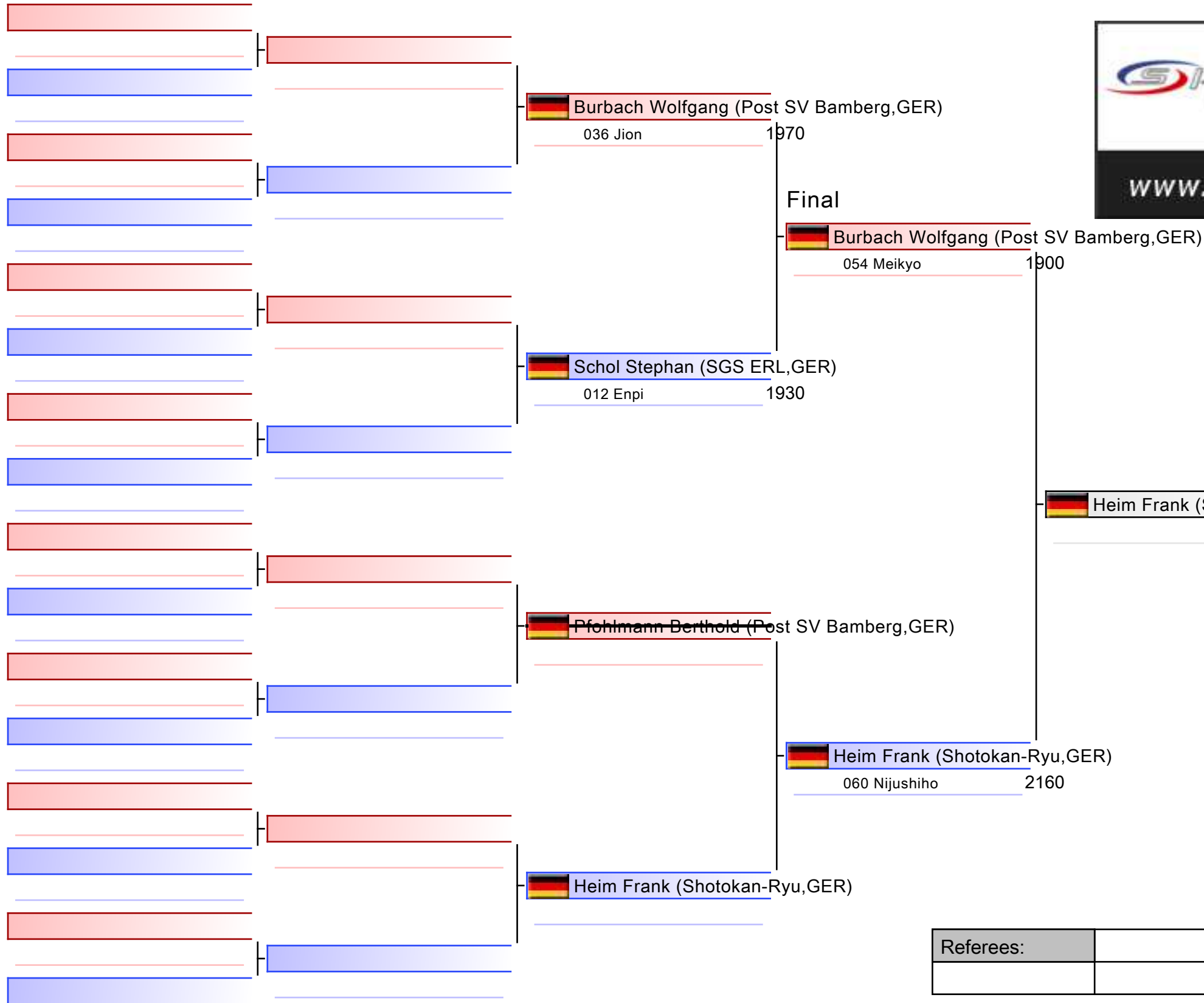

1. HEIM FRANK (SHOTOKAN-RYU,GER)
2. BURBACH WOLFGANG (POST SV BAMBERG,GER)
3. SCHOL STEPHAN (SGS ERL,GER)

Referees:			

Kata Masterklasse Ü55/Ü65 männlich

OFFENE UNTERFRÄNKISCHE KARATE BEZIRKSMEISTERSCHAFT & NEWCOMER KARATE TURNIER 2024

Tatami

Pool

1

(c)sportdata GmbH & Co KG 2000-2024 (2024-10-12 18:42) v 10.2.0 build 1 (2024-09-26 10:14 CET) License: Online_Event_ID-8506_OFFENEUNTERFRNKISCHEKARATEBEZIRKSMEISTERSCHAFTNEWCOMERKARATETURNIER2024

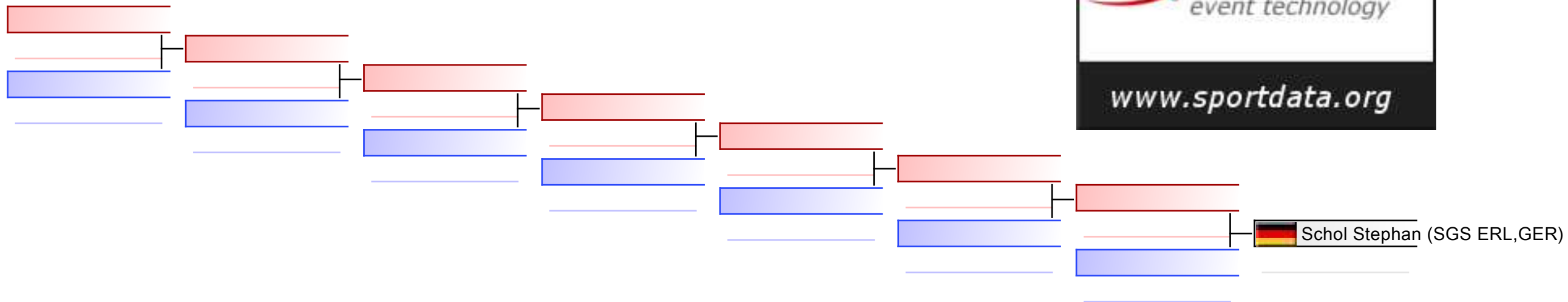

REPECHAGE: (1)

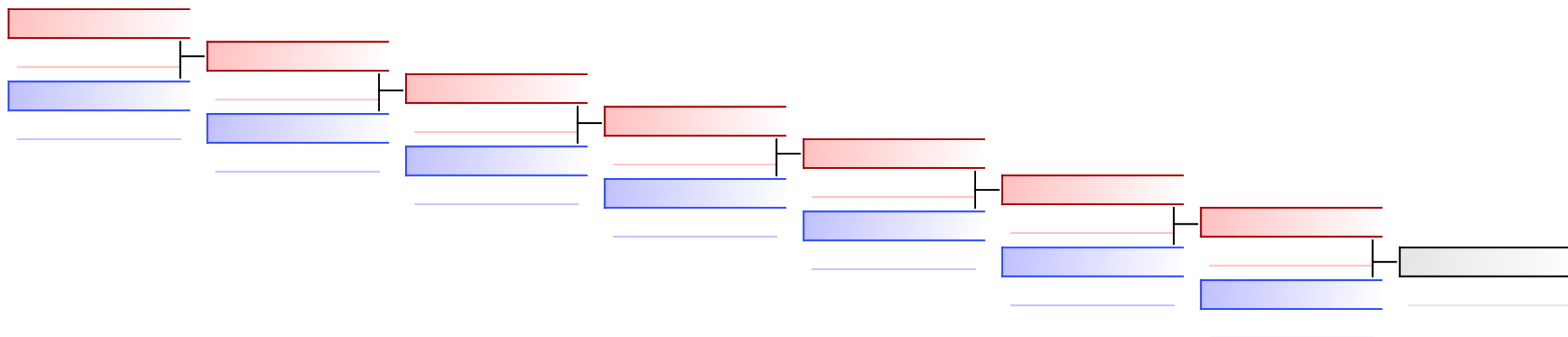

Referees:							
-----------	--	--	--	--	--	--	--

Kata Team Kinder/Schüler mixed

OFFENE UNTERFRÄNKISCHE KARATE BEZIRKSMEISTERSCHAFT & NEWCOMER KARATE TURNIER 2024, Hermasweg 1 97506 Grafenrheinfeld, GER

2024-10-12

Tatami

3 13:40

Pool

1/1

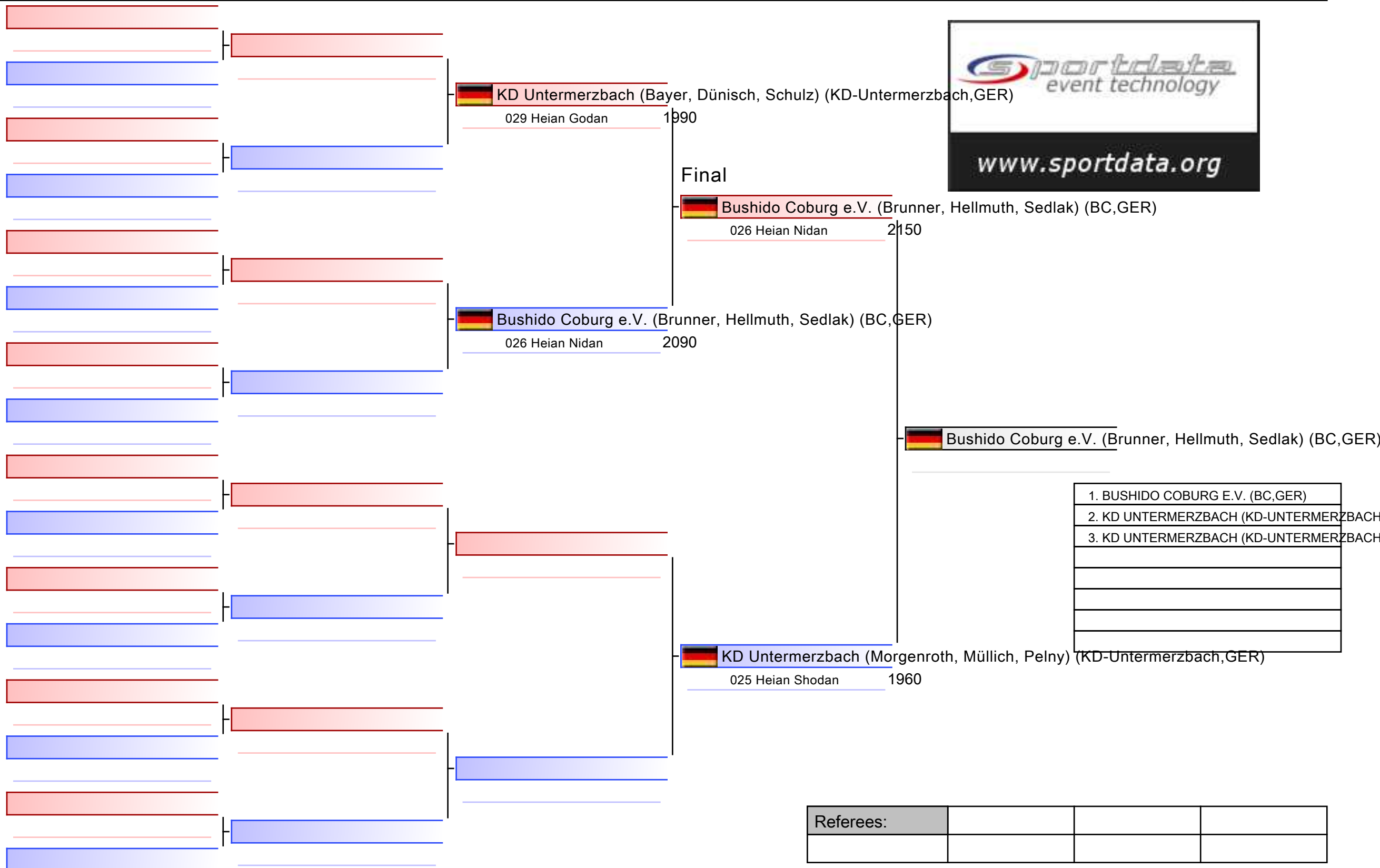

Kata Team Kinder/Schüler mixed

OFFENE UNTERFRÄNKISCHE KARATE BEZIRKSMEISTERSCHAFT & NEWCOMER KARATE TURNIER 2024

Tatami

Pool

1

(c)sportdata GmbH & Co KG 2000-2024 (2024-10-12 18:43) v 10.2.0 build 1 (2024-09-26 10:14 CET) License: Online_Event_ID-8506_OFFENEUNTERFRNKISCHEKARATEBEZIRKSMEISTERSCHAFTNEWCOMERKARATETURNIER2024

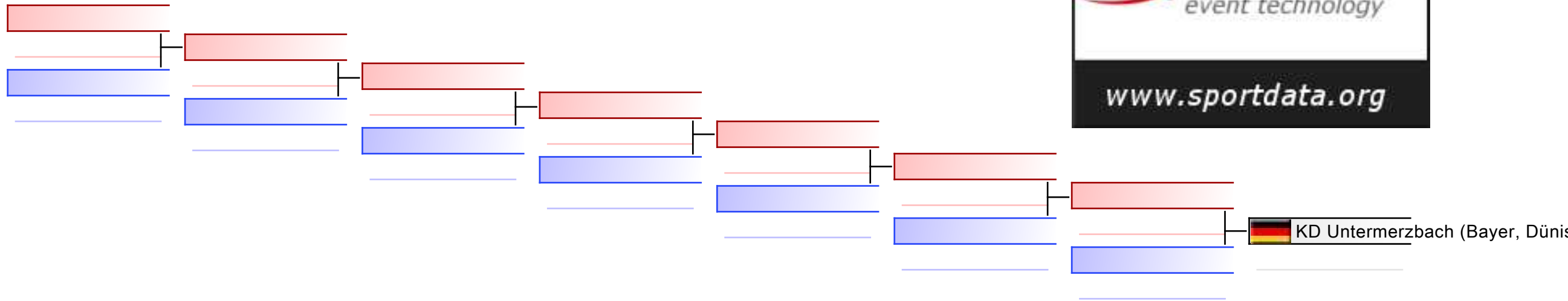

REPECHAGE: (1)

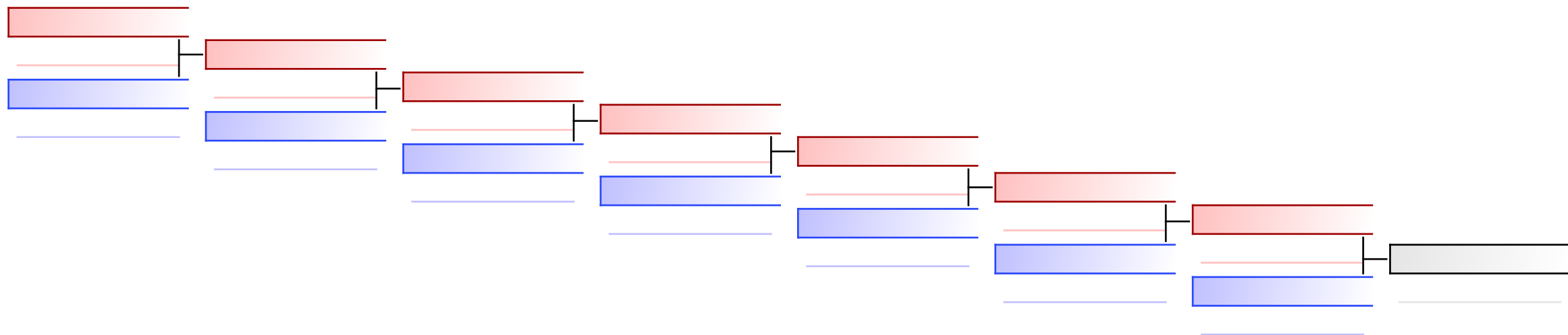

Referees:							
-----------	--	--	--	--	--	--	--

Kumite Jugend -61/+61 kg weiblich

OFFENE UNTERFRÄNKISCHE KARATE BEZIRKSMEISTERSCHAFT & NEWCOMER KARATE TURNIER 2024, Hermasweg 1 97506 Grafenheinfeld, GER

2024-10-12

Tatami
2 15:15

Pool
1/1

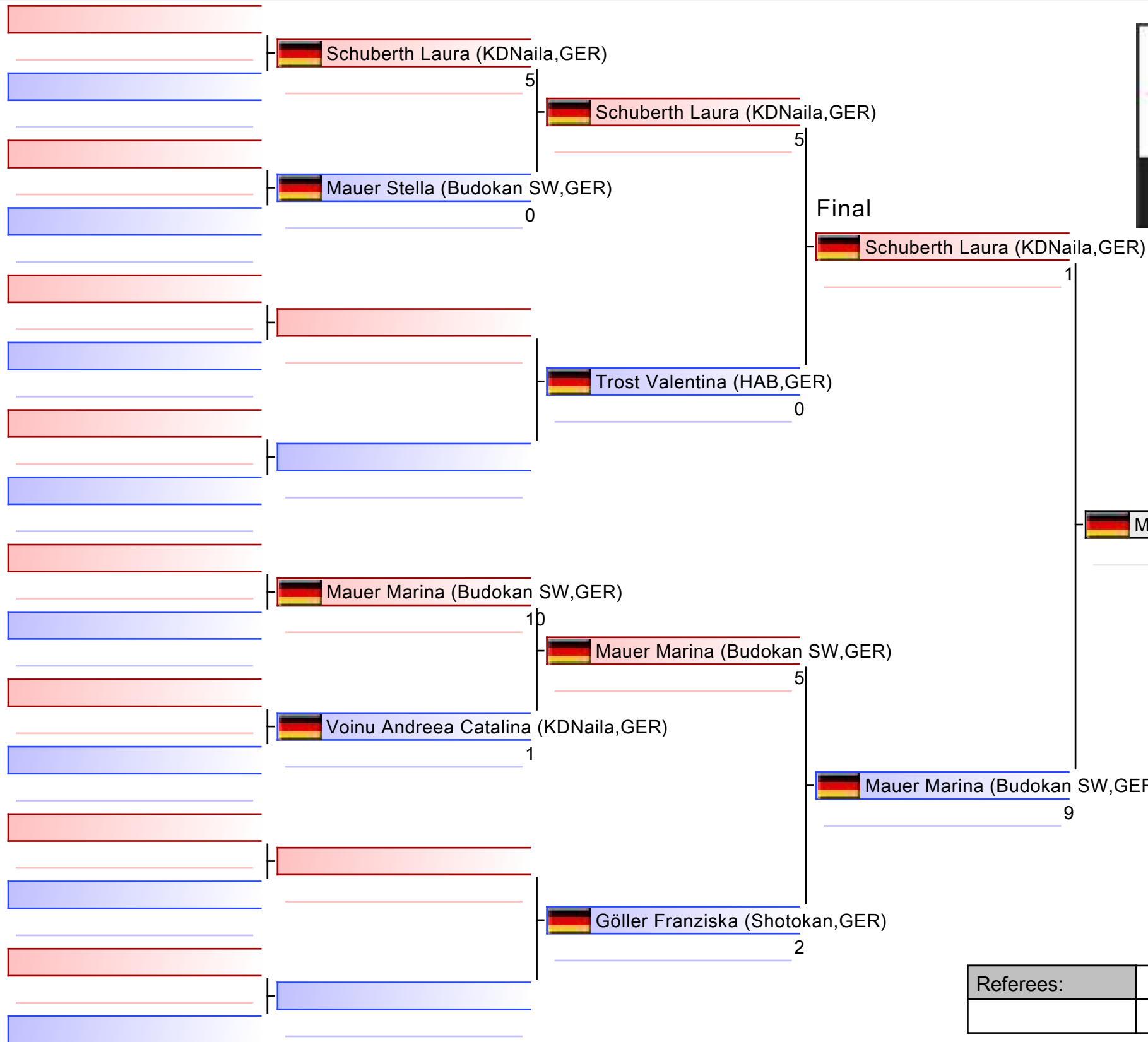

1. MAUER MARINA (BUDOKAN SW,GER)
2. SCHUBERTH LAURA (KDNAILA,GER)
3. MAUER STELLA (BUDOKAN SW,GER)
3. VOINU ANDREEA CATALINA (KDNAILA,GER)
5. TROST VALENTINA (HAB,GER)
5. GÖLLER FRANZISKA (SHOTOKAN,GER)

Referees:			

Kumite Jugend -61/+61 kg weiblich

OFFENE UNTERFRÄNKISCHE KARATÉ BEZIRKSMEISTERSCHAFT & NEWCOMER KARATE TURNIER 2024

2024-10-12

Tatami
2 15:35

Pool
1

(c)sportdata GmbH & Co KG 2000-2024 (2024-10-12 18:43) v 10.2.0 build 1 (2024-09-26 10:14 CET) License: Online_Event_ID-8506_OFFENEUNTERFRNKISCHEKARATEBEZIRKSMEISTERSCHAFTNEWCOMERKARATETURNIER2024

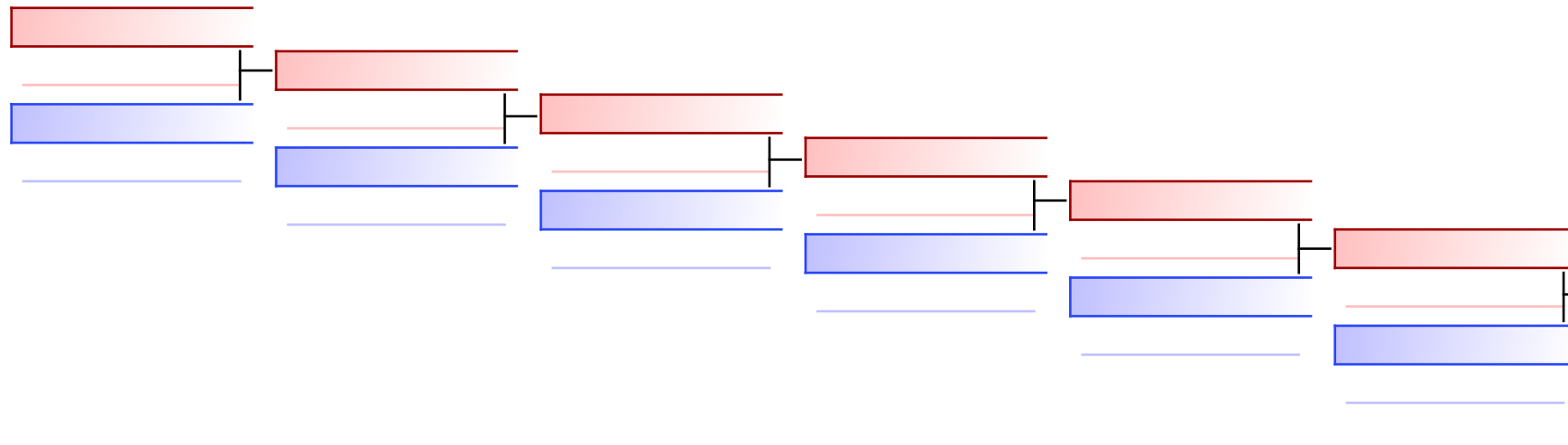

Mauer Stella (Budokan SW,GER)
 2
 Mauer Stella (Budokan SW,GER)
 Trost Valentina (HAB,GER)
 0

REPECHAGE: (1)

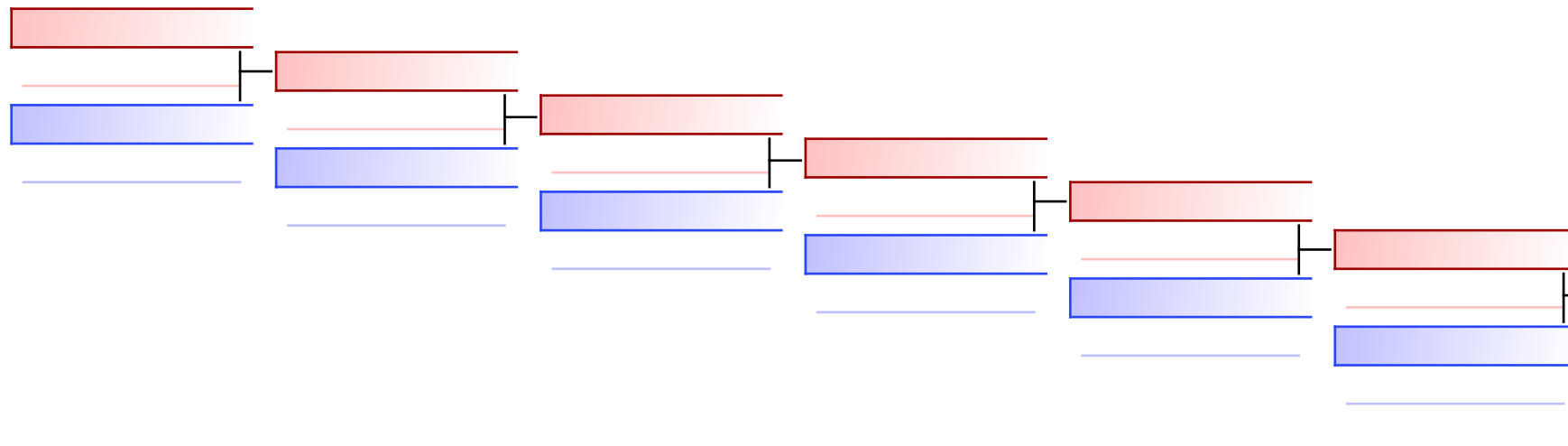

Voinu Andreea Catalina (KDNaila,GER)
 0
 Voinu Andreea Catalina (KDNaila)
 Göller Franziska (Shotokan,GER)
 1

Referees:							
-----------	--	--	--	--	--	--	--

Kumite Jugend/Junioren -57kg männlich

OFFENE UNTERFRÄNKISCHE KARATE BEZIRKSMEISTERSCHAFT & NEWCOMER KARATE TURNIER 2024, Hermasweg 1 97506 Grafenheinfeld, GER

2024-10-12

Tatami
1 15:25

Pool
1/1

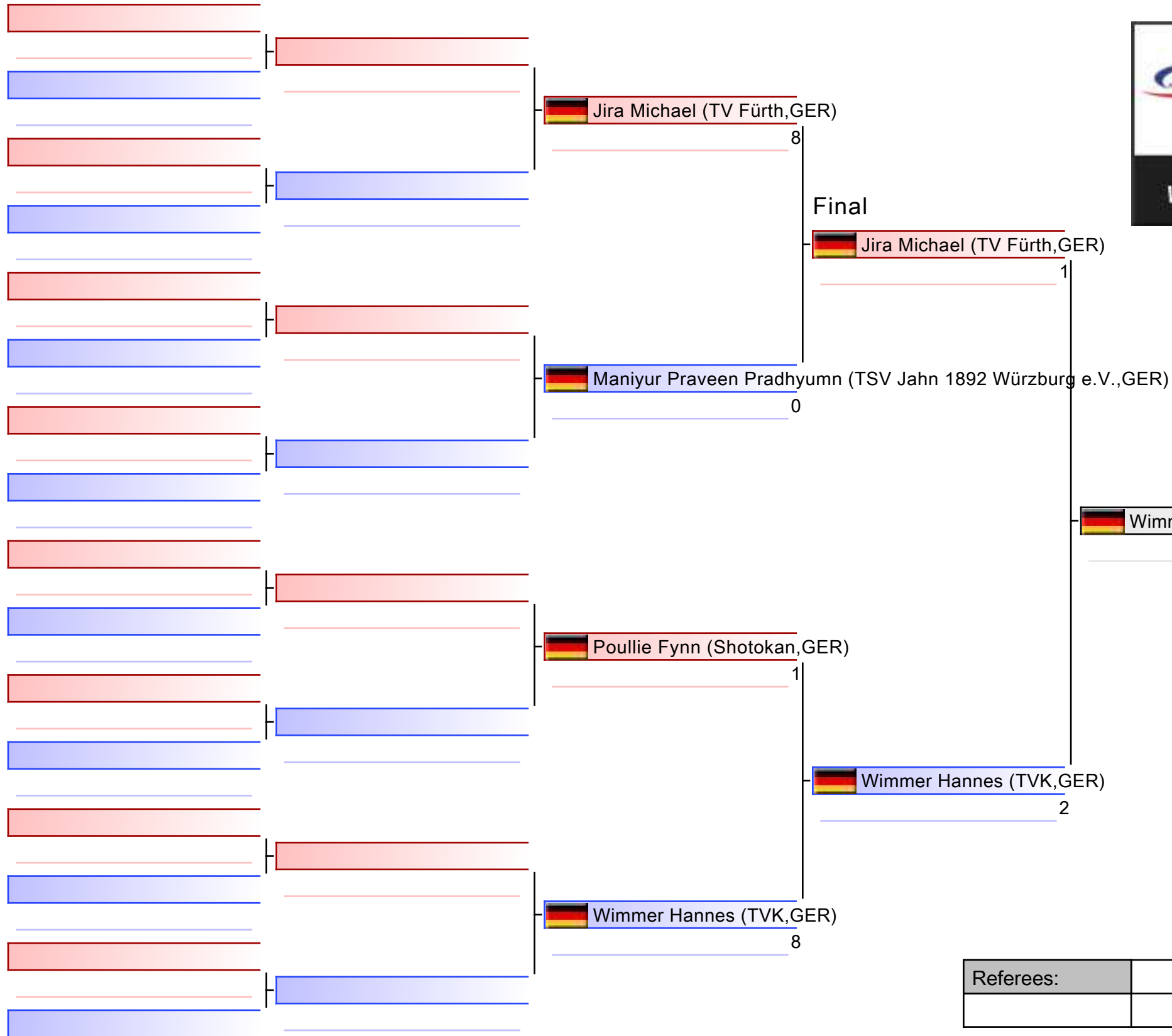

1. WIMMER HANNES (TVK,GER)
2. JIRA MICHAEL (TV FÜRTH,GER)
3. MANIYUR PRAVEEN PRADHYUMN (TSV JAHN
3. POULLIE FYNN (SHOTOKAN,GER)

Referees:			

Kumite Jugend/Junioren -57kg männlich

OFFENE UNTERFRÄNKISCHE KARATE BEZIRKSMEISTERSCHAFT & NEWCOMER KARATE TURNIER 2024

2024-10-12

Tatami
1 15:35

Pool
1

(c)sportdata GmbH & Co KG 2000-2024 (2024-10-12 18:43) v 10.2.0 build 1 (2024-09-26 10:14 CET) License: Online_Event_ID-8506_OFFENEUNTERFRNKISCHEKARATEBEZIRKSMEISTERSCHAFTNEWCOMERKARATETURNIER2024

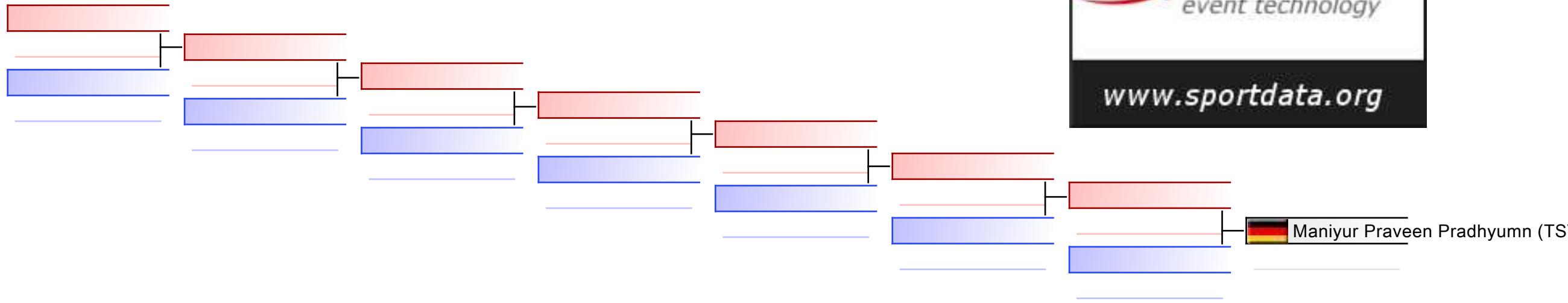

REPECHAGE: (1)

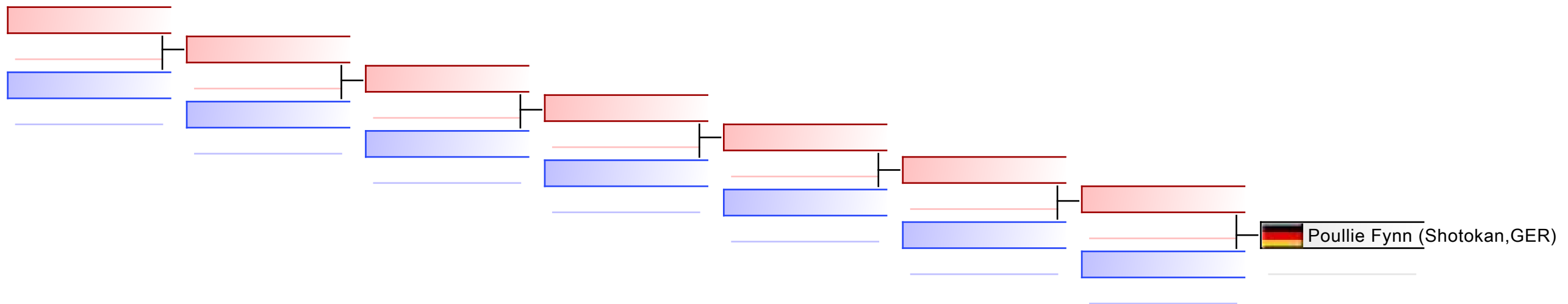

Referees:							
-----------	--	--	--	--	--	--	--

Kumite Junioren weiblich

OFFENE UNTERFRÄNKISCHE KARATE BEZIRKSMEISTERSCHAFT & NEWCOMER KARATE TURNIER 2024, Hermasweg 1 97506 Grafenrheinfeld, GER

2024-10-12

Tatami
3 15:50

Pool
1/1

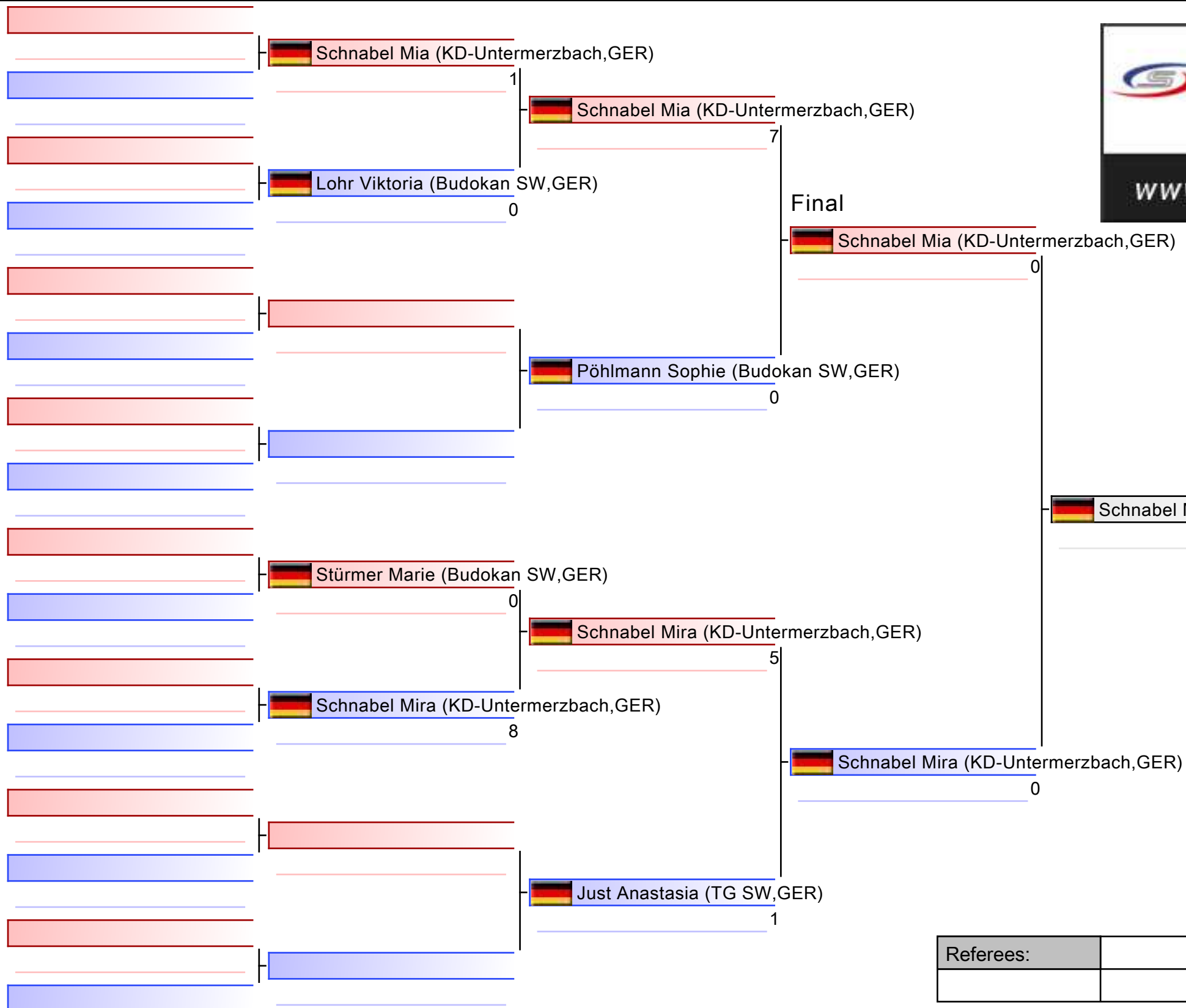

1. SCHNABEL MIRA (KD-UNTERMERZBACH,GER)
2. SCHNABEL MIA (KD-UNTERMERZBACH,GER)
3. PÖHLMANN SOPHIE (BUDOKAN SW,GER)
3. JUST ANASTASIA (TG SW,GER)
5. LOHR VIKTORIA (BUDOKAN SW,GER)
5. STÜRMER MARIE (BUDOKAN SW,GER)

Referees:			

Kumite Junioren weiblich

OFFENE UNTERFRÄNKISCHE KARATE BEZIRKSMEISTERSCHAFT & NEWCOMER KARATE TURNIER 2024

2024-10-12

Tatami
3 16:10

Pool
1

(c)sportdata GmbH & Co KG 2000-2024 (2024-10-12 18:43) v 10.2.0 build 1 (2024-09-26 10:14 CET) License: Online_Event_ID-8506_OFFENEUNTERFRNKISCHEKARATEBEZIRKSMEISTERSCHAFTNEWCOMERKARATETURNIER2024

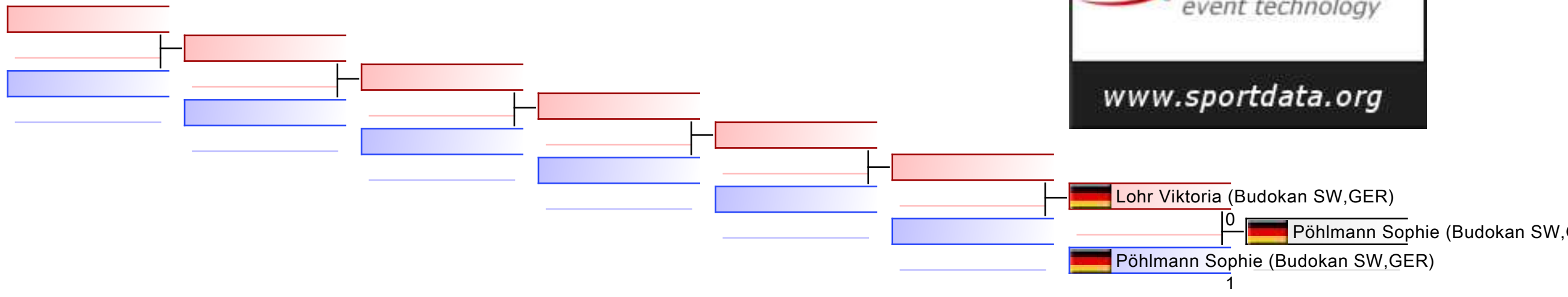

REPECHAGE: (1)

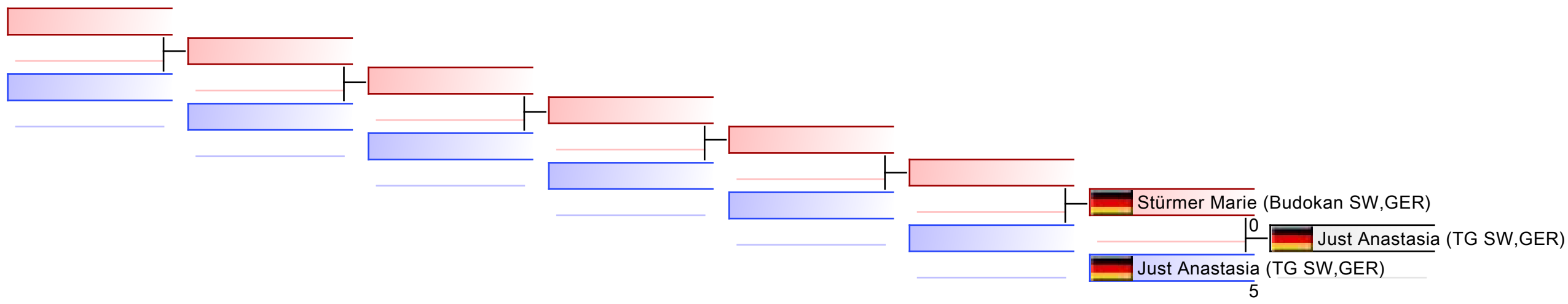

Referees:							
-----------	--	--	--	--	--	--	--

Kumite Kinder A -35/+40kg männlich

OFFENE UNTERFRÄNKISCHE KARATE BEZIRKSMEISTERSCHAFT & NEWCOMER KARATE TURNIER 2024, Hermasweg 1 97506 Grafenrheinfeld, GER

2024-10-12

Tatami
1 14:15

Pool
1/1

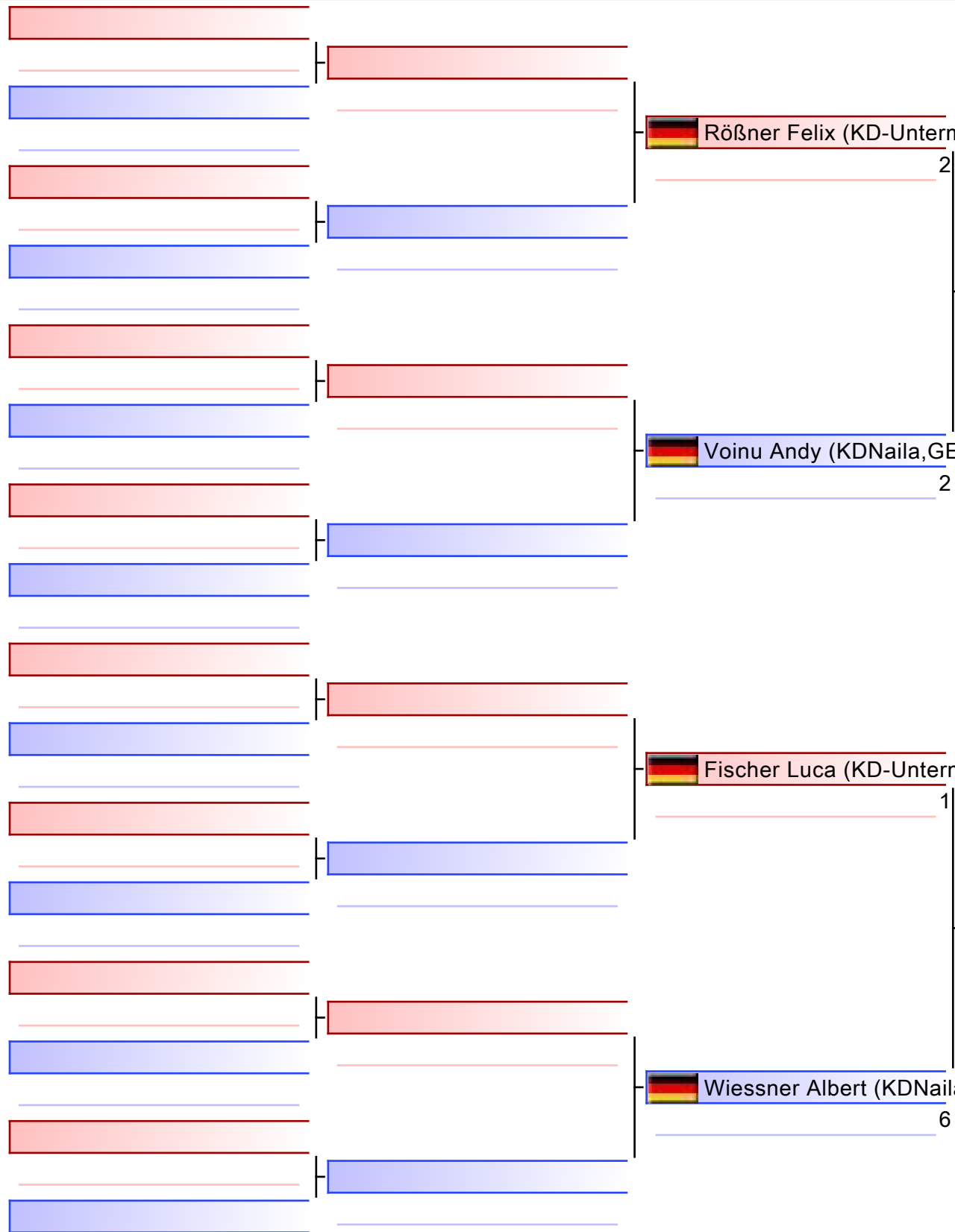

Final

Rößner Felix (KD-Untermmerzbach, GER)

0

Voinu Andy (KDNaila, GER)

2

Fischer Luca (KD-Untermmerzbach, GER)

1

Wiessner Albert (KDNaila, GER)

2

Wiessner Albert (KDNaila, GER)

6

Wiessner Albert (KDNaila, GER)

1. WIESSNER ALBERT (KDNAILA, GER)
2. RÖSSNER FELIX (KD-UNTERMERZBACH, GER)
3. VOINU ANDY (KDNAILA, GER)
3. FISCHER LUCA (KD-UNTERMERZBACH, GER)

Referees:			

Kumite Kinder A -35/+40kg männlich

OFFENE UNTERFRÄNKISCHE KARATE BEZIRKSMEISTERSCHAFT & NEWCOMER KARATE TURNIER 2024

Tatami

Pool

1

(c)sportdata GmbH & Co KG 2000-2024 (2024-10-12 18:43) v 10.2.0 build 1 (2024-09-26 10:14 CET) License: Online_Event_ID-8506_OFFENEUNTERFRNKISCHEKARATEBEZIRKSMEISTERSCHAFTNEWCOMERKARATETURNIER2024

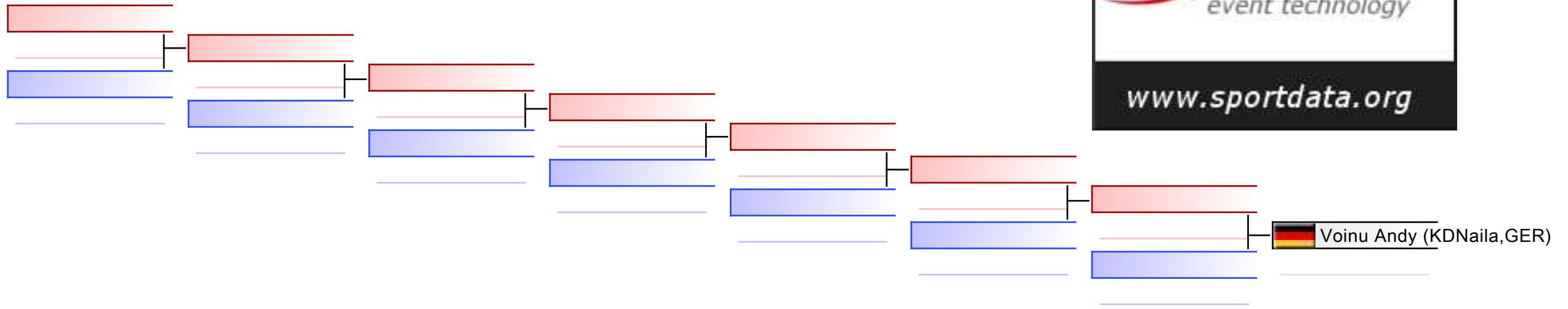

REPECHAGE: (1)

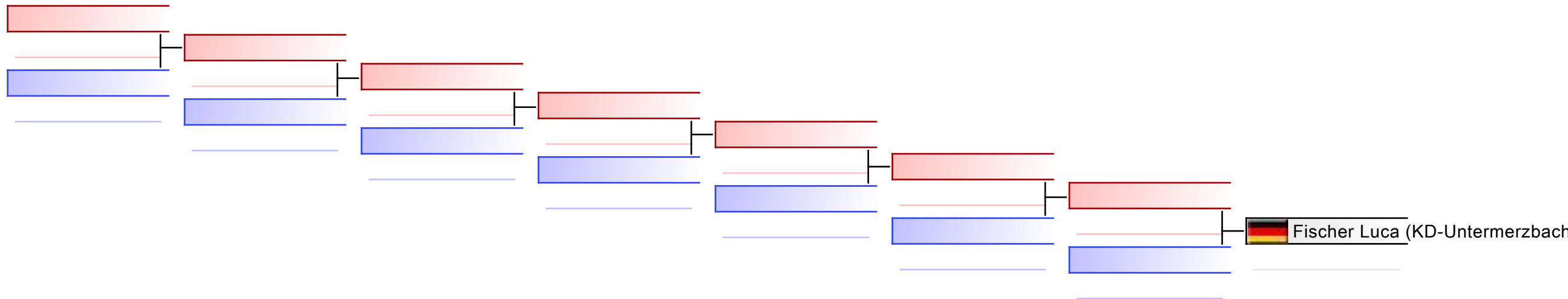

Referees:							
-----------	--	--	--	--	--	--	--









Kumite Leistungsklasse -60/-67/-75kg männlich - Round Robin (each against each)

OFFENE UNTERFRÄNKISCHE KARATE BEZIRKSMEISTERSCHAFT & NEWCOMER KARATE TURNIER 2024, Hermasweg 1 97506 Grafenrheinfeld, GER

2024-10-12

Tatami
2 15:50

Pool
1/1

1	 Schultz Tristan (KD-Untermerzbach,GER)	8	 Schultz Tristan (KD-Untermerzbach,GER)
2	 Janson Patrick (HAB,GER)	7	
3	 Schultz Tristan (KD-Untermerzbach,GER)	7	 Schultz Tristan (KD-Untermerzbach,GER)
4	 Stürmer Noah (Budokan SW,GER)	1	
5	 Janson Patrick (HAB,GER)	0	 Stürmer Noah (Budokan SW,GER)
6	 Stürmer Noah (Budokan SW,GER)	4	



1. SCHULTZ TRISTAN (KD-UNTERMERZBACH,GER)
2. STÜRMER NOAH (BUDOKAN SW,GER)
3. JANSON PATRICK (HAB,GER)

Referees:			

Kumite Leistungsklasse -84/+84kg männlich

OFFENE UNTERFRÄNKISCHE KARATE BEZIRKSMEISTERSCHAFT & NEWCOMER KARATE TURNIER 2024, Hermasweg 1 97506 Grafenheinfeld, GER

2024-10-12

Tatami

2 16:10

Pool

1/1

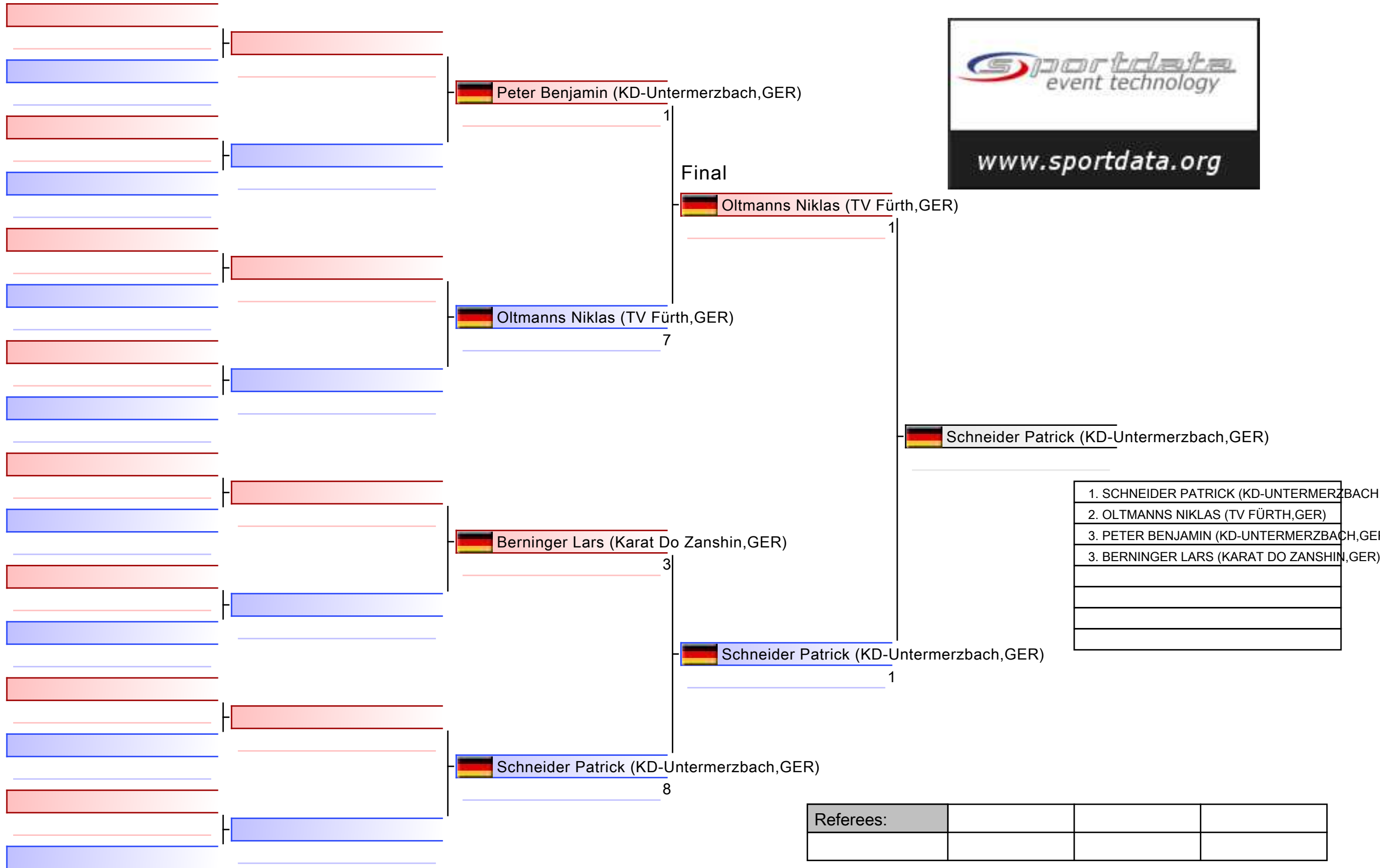

Kumite Leistungsklasse -84/+84kg männlich

OFFENE UNTERFRÄNKISCHE KARATE BEZIRKSMEISTERSCHAFT & NEWCOMER KARATE TURNIER 2024

2024-10-12

Tatami
2 16:25

Pool
1

(c)sportdata GmbH & Co KG 2000-2024 (2024-10-12 18:43) v 10.2.0 build 1 (2024-09-26 10:14 CET) License: Online_Event_ID-8506_OFFENEUNTERFRNKISCHEKARATEBEZIRKSMEISTERSCHAFTNEWCOMERKARATETURNIER2024

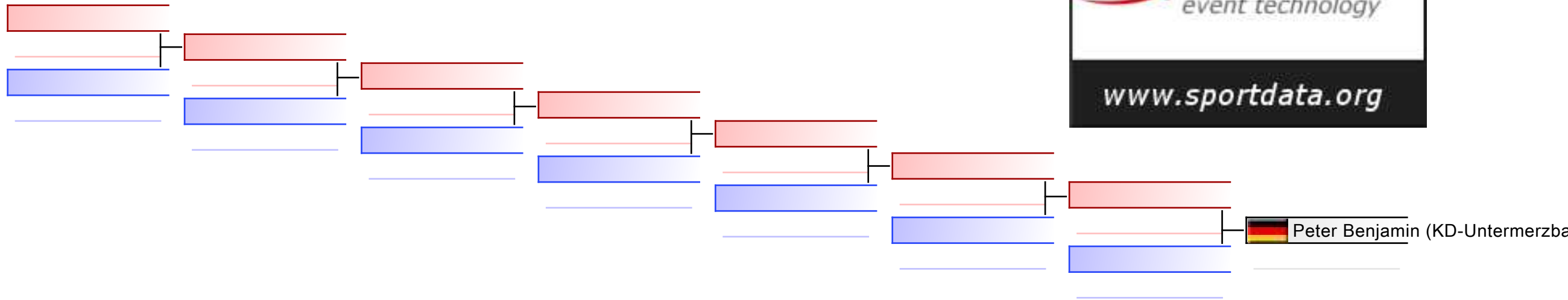

REPECHAGE: (1)

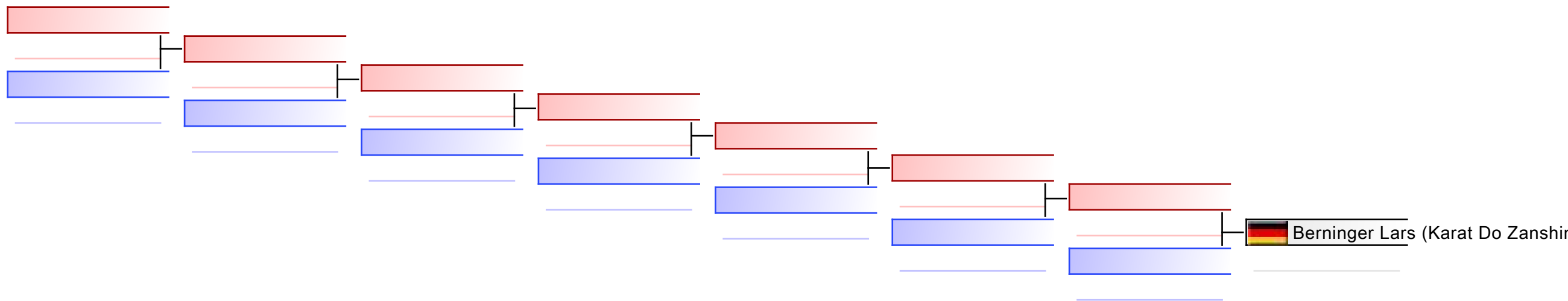

Referees:							
-----------	--	--	--	--	--	--	--

Kumite Leistungsklasse Allkat. männlich

OFFENE UNTERFRÄNKISCHE KARATE BEZIRKSMEISTERSCHAFT & NEWCOMER KARATE TURNIER 2024, Hermasweg 1 97506 Grafenheinfeld, GER

2024-10-12

Tatami

2 16:45

Pool

1/1

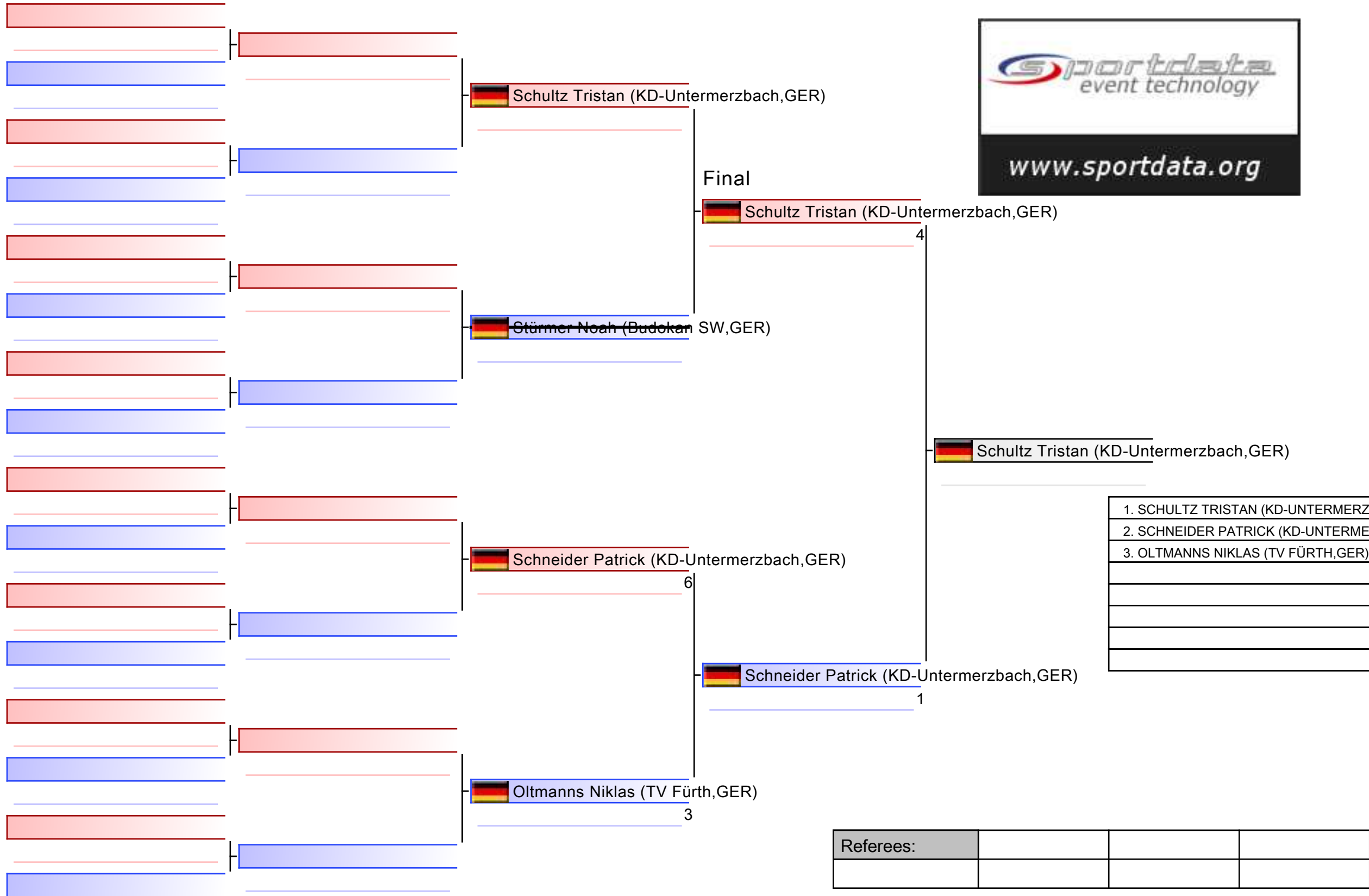

Kumite Leistungsklasse Allkat. männlich

OFFENE UNTERFRÄNKISCHE KARATE BEZIRKSMEISTERSCHAFT & NEWCOMER KARATE TURNIER 2024

Tatami

Pool

1

(c)sportdata GmbH & Co KG 2000-2024 (2024-10-12 18:43) v 10.2.0 build 1 (2024-09-26 10:14 CET) License: Online_Event_ID-8506_OFFENEUNTERFRNKISCHEKARATEBEZIRKSMEISTERSCHAFTNEWCOMERKARATETURNIER2024

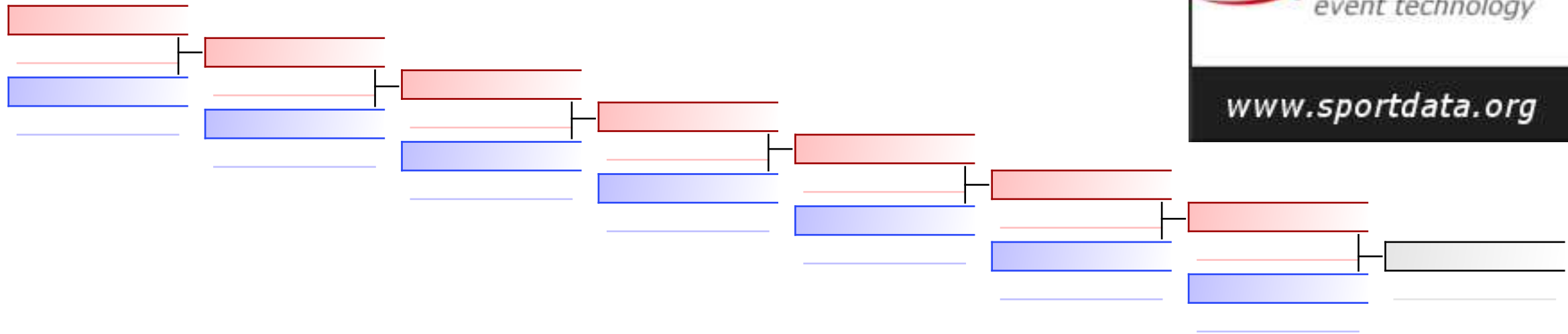

REPECHAGE: (1)

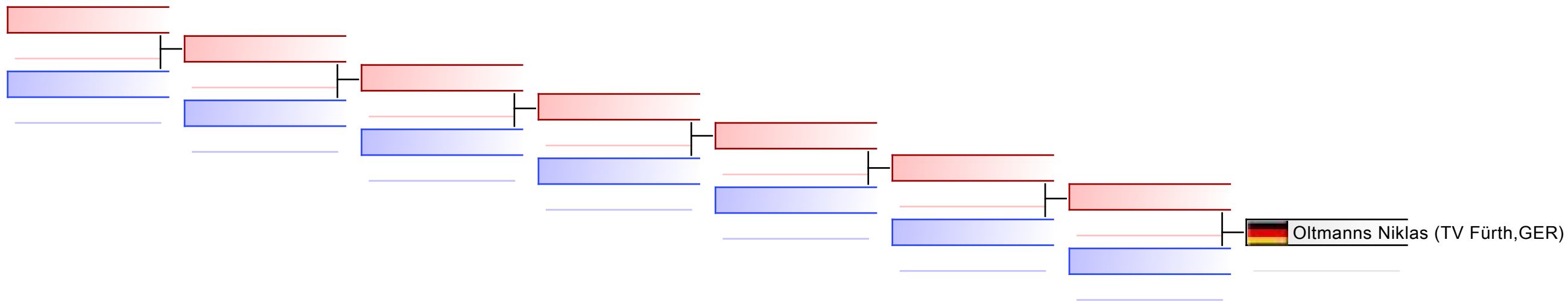

Referees:							
-----------	--	--	--	--	--	--	--

Kumite Leistungsklasse Allkat. weiblich

OFFENE UNTERFRÄNKISCHE KARATE BEZIRKSMEISTERSCHAFT & NEWCOMER KARATE TURNIER 2024, Hermasweg 1 97506 Grafenheinfeld, GER

2024-10-12

Tatami
1 17:00

Pool
1/1

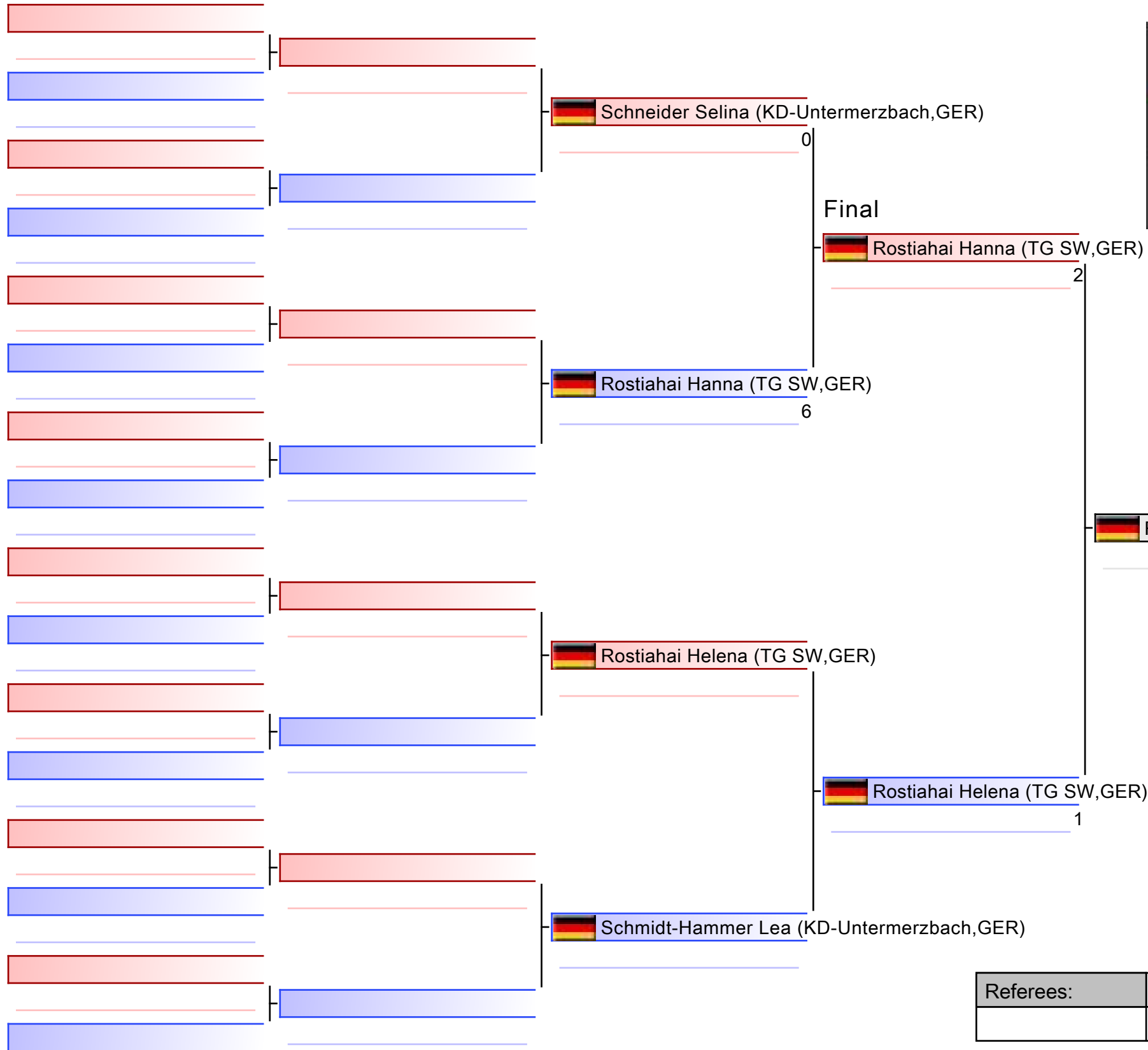

1. ROSTIAHAI HANNA (TG SW,GER)
2. ROSTIAHAI HELENA (TG SW,GER)
3. SCHNEIDER SELINA (KD-UNTERMERZBACH,G
3. SCHMIDT-HAMMER LEA (KD-UNTERMERZBAC

Referees:			

Kumite Leistungsklasse Allkat. weiblich

OFFENE UNTERFRÄNKISCHE KARATE BEZIRKSMEISTERSCHAFT & NEWCOMER KARATE TURNIER 2024

Tatami

Pool

1

(c)sportdata GmbH & Co KG 2000-2024 (2024-10-12 18:43) v 10.2.0 build 1 (2024-09-26 10:14 CET) License: Online_Event_ID-8506_OFFENEUNTERFRNKISCHEKARATEBEZIRKSMEISTERSCHAFTNEWCOMERKARATETURNIER2024

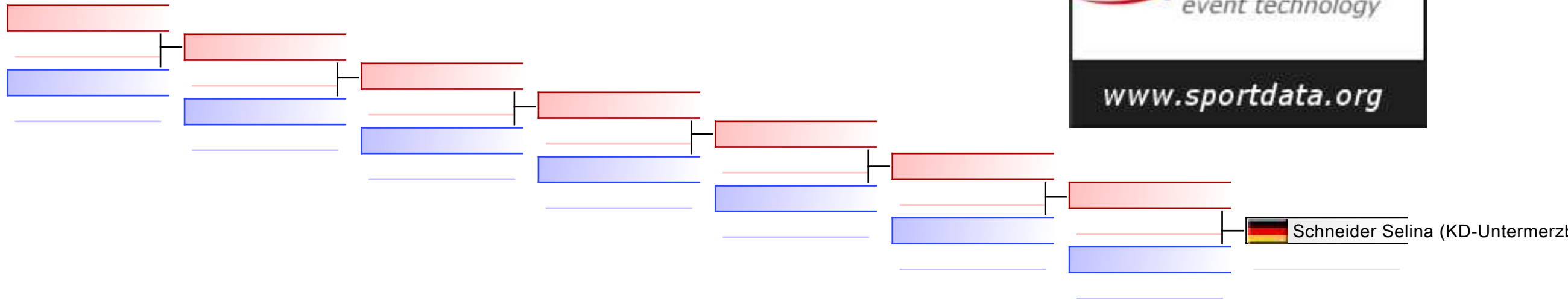

REPECHAGE: (1)

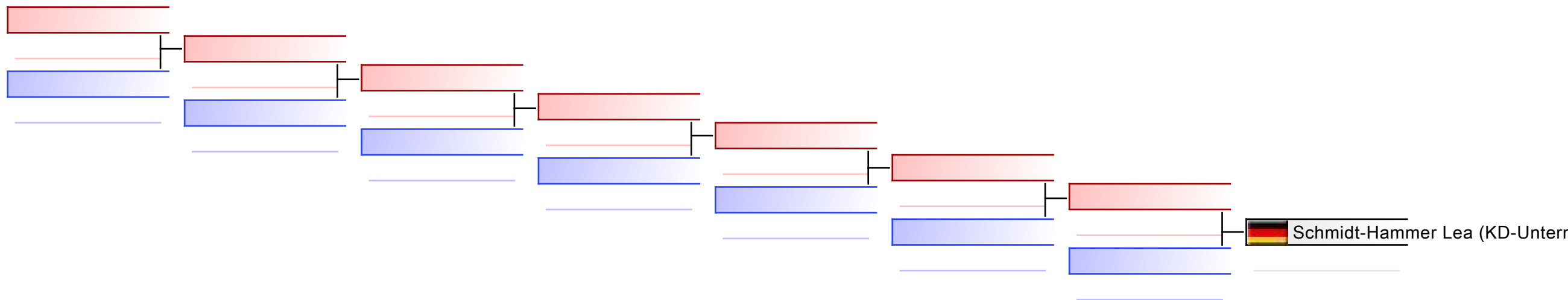

Referees:							
-----------	--	--	--	--	--	--	--

Kumite Leistungsklasse weiblich +68 kg

OFFENE UNTERFRÄNKISCHE KARATE BEZIRKSMEISTERSCHAFT & NEWCOMER KARATE TURNIER 2024, Hermasweg 1 97506 Grafenrheinfeld, GER

2024-10-12

Tatami
1 16:35

Pool
1/1

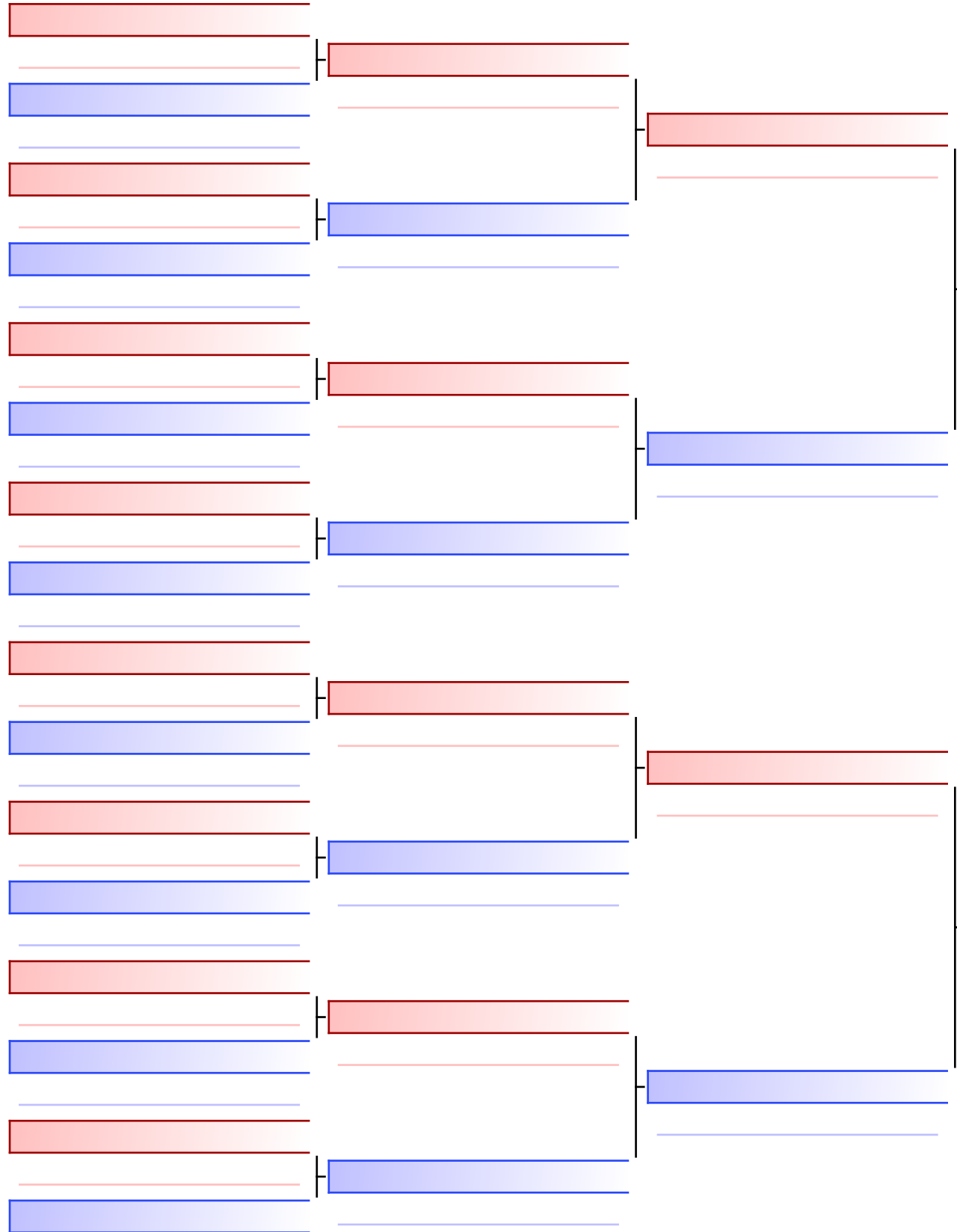

Final

Huber Sabrina (TV Burglengenfeld,GER)

1

Schmidt-Hammer Lea (KD-Untermerzbach,GER)

Schmidt-Hammer Lea (KD-Untermerzbach,GER)

7

1. SCHMIDT-HAMMER LEA (KD-UNTERMERZBACH)
2. HUBER SABRINA (TV BURGLENGENFELD,GER)

Referees:			

Kumite Leistungsklasse weiblich -68 kg

OFFENE UNTERFRÄNKISCHE KARATE BEZIRKSMEISTERSCHAFT & NEWCOMER KARATE TURNIER 2024, Hermasweg 1 97506 Grafenrheinfeld, GER

2024-10-12

Tatami
1 16:40

Pool
1/1

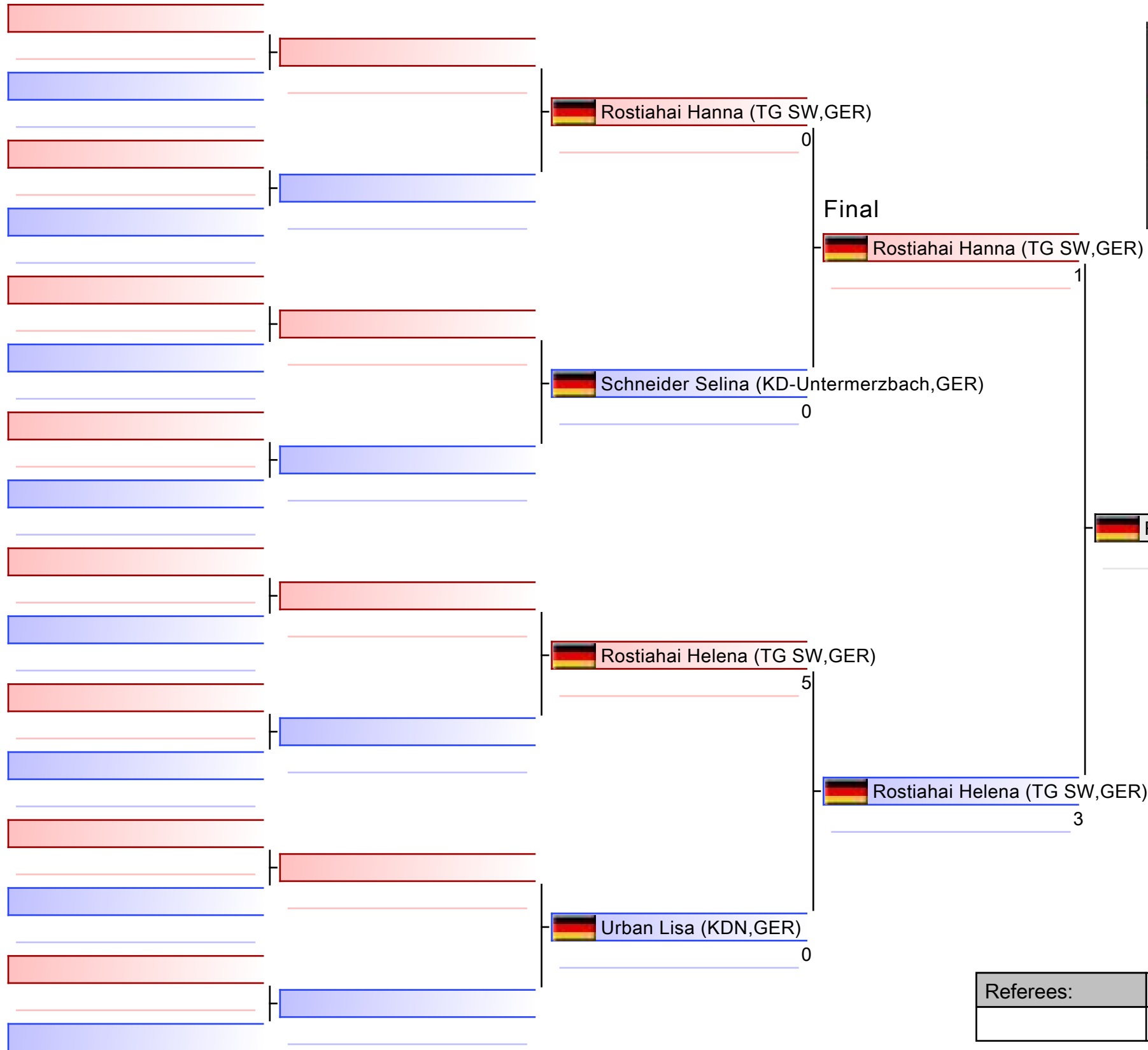

1. ROSTIAHAI HELENA (TG SW,GER)
2. ROSTIAHAI HANNA (TG SW,GER)
3. SCHNEIDER SELINA (KD-UNTERMERZBACH,GER)
3. URBAN LISA (KDN,GER)

Referees:			

Kumite Leistungsklasse weiblich -68 kg

OFFENE UNTERFRÄNKISCHE KARATE BEZIRKSMEISTERSCHAFT & NEWCOMER KARATE TURNIER 2024

Tatami

Pool

1

(c)sportdata GmbH & Co KG 2000-2024 (2024-10-12 18:43) v 10.2.0 build 1 (2024-09-26 10:14 CET) License: Online_Event_ID-8506_OFFENEUNTERFRNKISCHEKARATEBEZIRKSMEISTERSCHAFTNEWCOMERKARATETURNIER2024

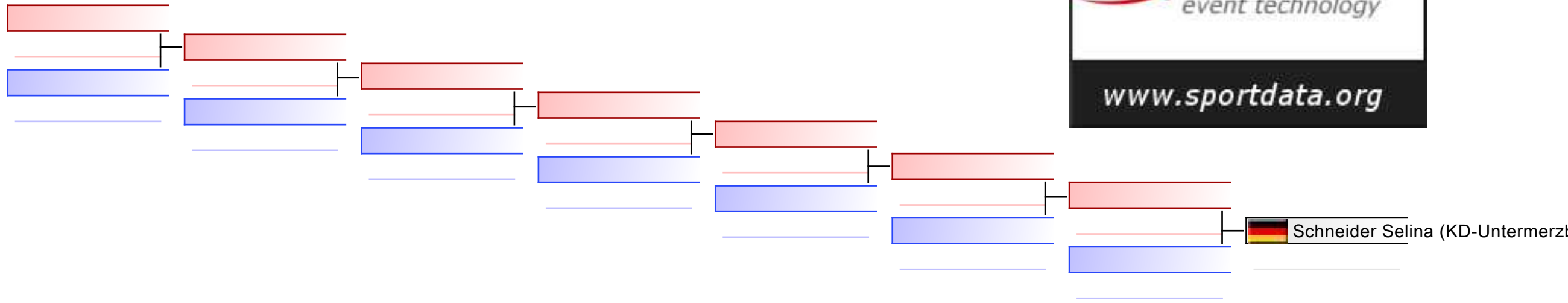

REPECHAGE: (1)

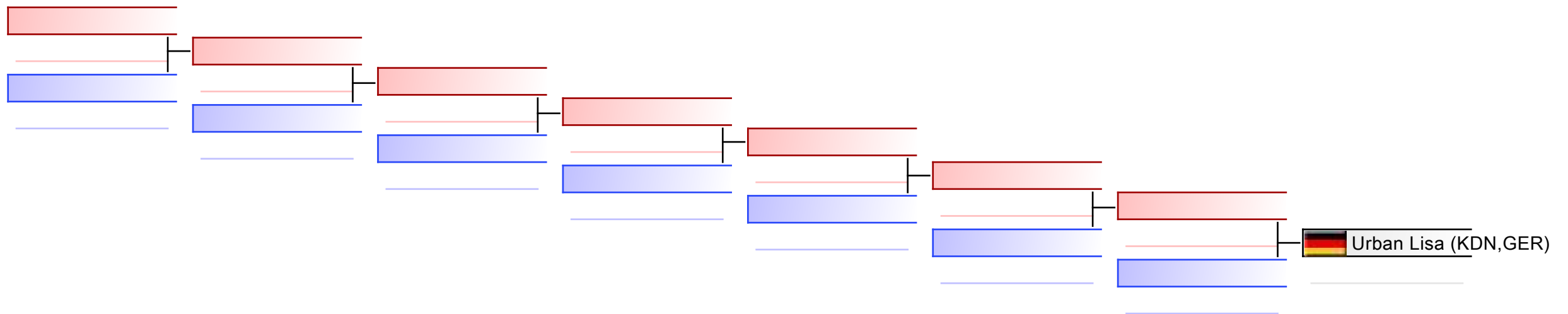

Referees:							
-----------	--	--	--	--	--	--	--

Kumite Masterklasse Ü30/Ü35 -80kg männlich - Round Robin (each against each)

OFFENE UNTERFRÄNKISCHE KARATE BEZIRKSMEISTERSCHAFT & NEWCOMER KARATE TURNIER 2024, Hermasweg 1 97506 Grafenrheinfeld, GER









2024-10-12

Tatami

1 14:00

Pool

1/1

1	 Münch Armin (TVT,GER)	2	 Peter Benjamin (KD-Untermerzbach,GER)
2	 Peter Benjamin (KD-Untermerzbach,GER)	3	
3	 Münch Armin (TVT,GER)	0	 Janson Patrick (HAB,GER)
4	 Janson Patrick (HAB,GER)	8	
5	 Peter Benjamin (KD-Untermerzbach,GER)	0	 Janson Patrick (HAB,GER)
6	 Janson Patrick (HAB,GER)	3	



1. JANSON PATRICK (HAB,GER)
2. PETER BENJAMIN (KD-UNTERMERZBACH,GER)
3. MÜNCH ARMIN (TVT,GER)

Referees:			

Kumite Masterklasse Ü45/Ü55/Ü65 +80kg männlich - Round Robin (each against each)

OFFENE UNTERFRÄNKISCHE KARATE BEZIRKSMEISTERSCHAFT & NEWCOMER KARATE TURNIER 2024, Hermasweg 1 97506 Grafenrheinfeld, GER









2024-10-12

Tatami

2 14:00

Pool

1/1

1	 Ludwig Rainer (Budokan SW,GER)	1	 Heim Frank (Shotokan-Ryu,GER)
2	 Heim Frank (Shotokan-Ryu,GER)	7	
3	 Ludwig Rainer (Budokan SW,GER)	0	 Krug Gerald (Budokan SW,GER)
4	 Krug Gerald (Budokan SW,GER)	4	
5	 Heim Frank (Shotokan-Ryu,GER)	4	 Heim Frank (Shotokan-Ryu,GER)
6	 Krug Gerald (Budokan SW,GER)	0	



1. HEIM FRANK (SHOTOKAN-RYU,GER)
2. KRUG GERALD (BUDOKAN SW,GER)
3. LUDWIG RAINER (BUDOKAN SW,GER)

Referees:			

Kumite Schüler A -40kg männlich - Round Robin (each against each)

OFFENE UNTERFRÄNKISCHE KARATE BEZIRKSMEISTERSCHAFT & NEWCOMER KARATE TURNIER 2024, Hermasweg 1 97506 Grafenrheinfeld, GER









2024-10-12

Tatami

3 15:00

Pool

1/1

1	 Ritter Ben (KDNaila,GER)	0	 Al Awair Abedalmuhaimen (TG SW,GER)
2	 Al Awair Abedalmuhaimen (TG SW,GER)	2	
3	 Ritter Ben (KDNaila,GER)	0	 Köhler Friedrich (KDNaila,GER)
4	 Köhler Friedrich (KDNaila,GER)	6	
5	 Al Awair Abedalmuhaimen (TG SW,GER)	3	 Al Awair Abedalmuhaimen (TG SW,GER)
6	 Köhler Friedrich (KDNaila,GER)	1	



1. AL AWAIR ABEDALMUHAIMEN (TG SW,GER)
2. KÖHLER FRIEDRICH (KDNAILA,GER)
3. RITTER BEN (KDNAILA,GER)

Referees:			

Kumite Schüler A -42/-47kg weiblich

OFFENE UNTERFRÄNKISCHE KARATE BEZIRKSMEISTERSCHAFT & NEWCOMER KARATE TURNIER 2024, Hermasweg 1 97506 Grafenheinfeld, GER

2024-10-12

Tatami
3 14:45

Pool
1/1

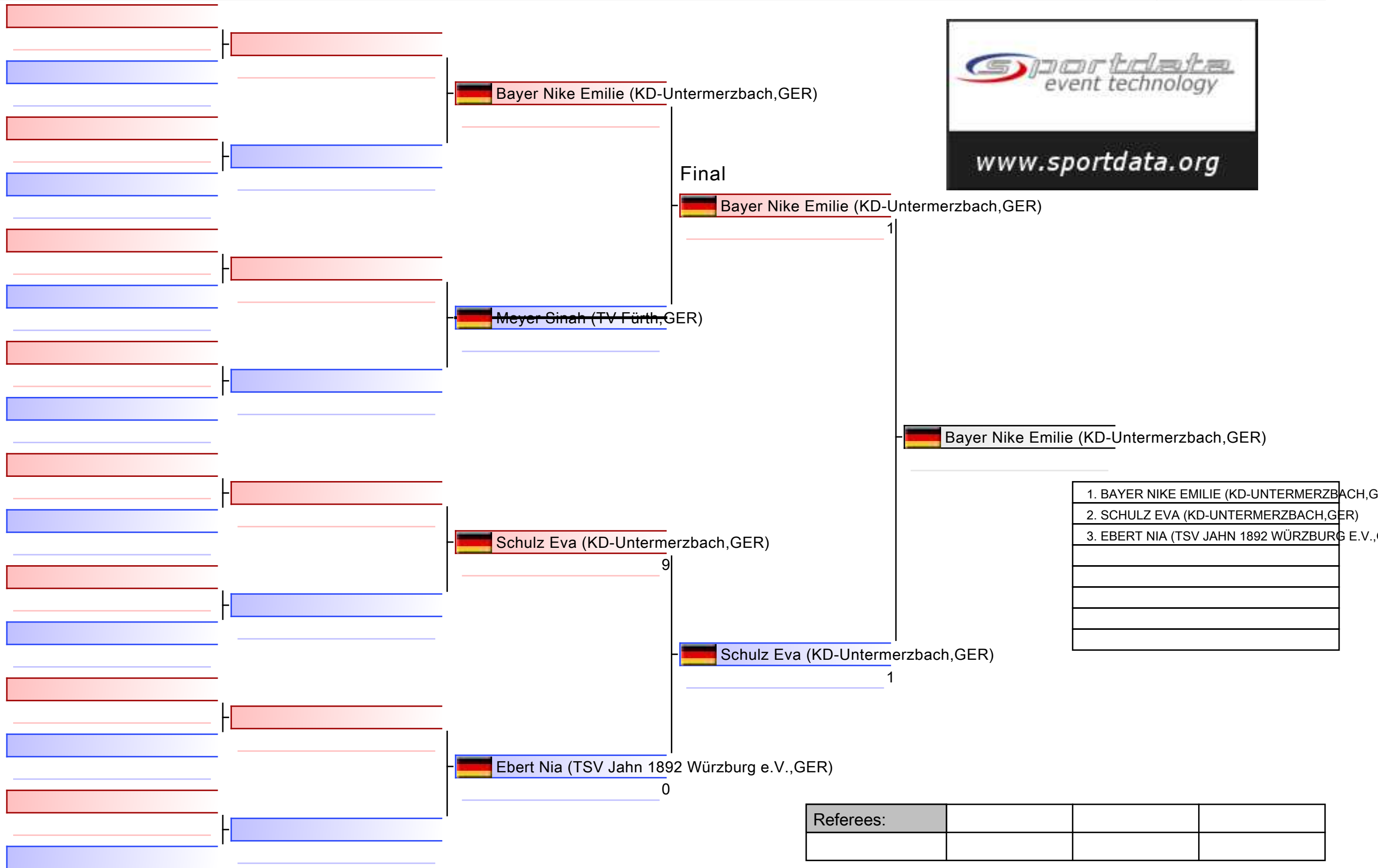

Kumite Schüler A -42/-47kg weiblich

OFFENE UNTERFRÄNKISCHE KARATE BEZIRKSMEISTERSCHAFT & NEWCOMER KARATE TURNIER 2024

Tatami

Pool

1

(c)sportdata GmbH & Co KG 2000-2024 (2024-10-12 18:43) v 10.2.0 build 1 (2024-09-26 10:14 CET) License: Online_Event_ID-8506_OFFENEUNTERFRNKISCHEKARATEBEZIRKSMEISTERSCHAFTNEWCOMERKARATETURNIER2024

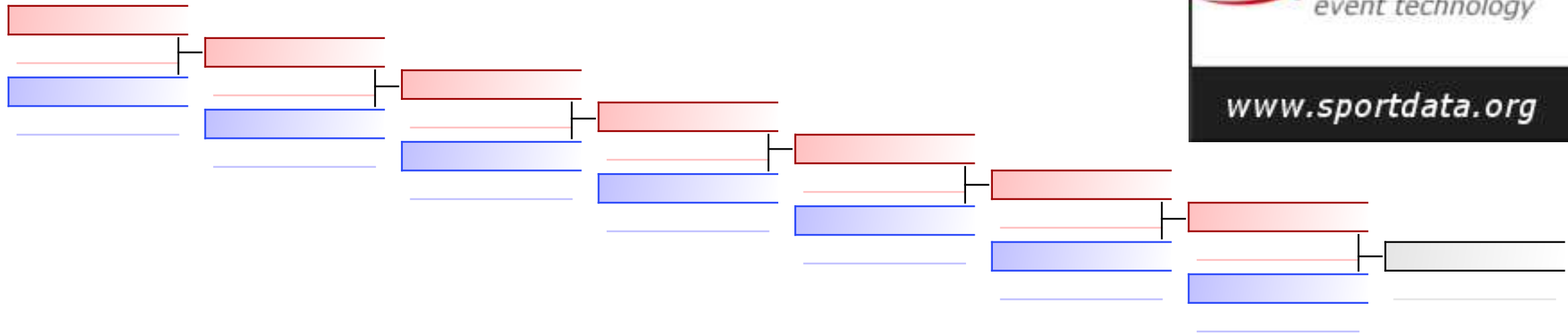

REPECHAGE: (1)

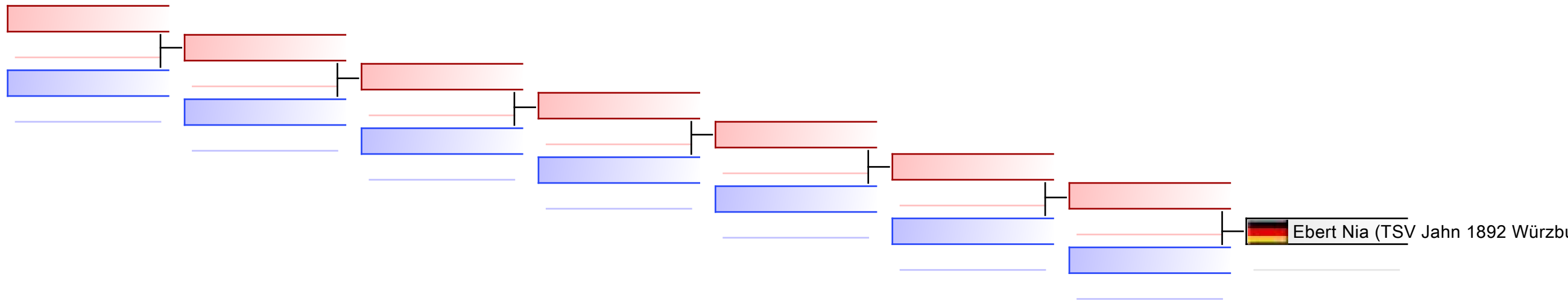

Referees:							
-----------	--	--	--	--	--	--	--

Kumite Schüler A -45kg männlich

OFFENE UNTERFRÄNKISCHE KARATE BEZIRKSMEISTERSCHAFT & NEWCOMER KARATE TURNIER 2024, Hermasweg 1 97506 Grafenheinfeld, GER

2024-10-12

Tatami
2 15:00

Pool
1/1

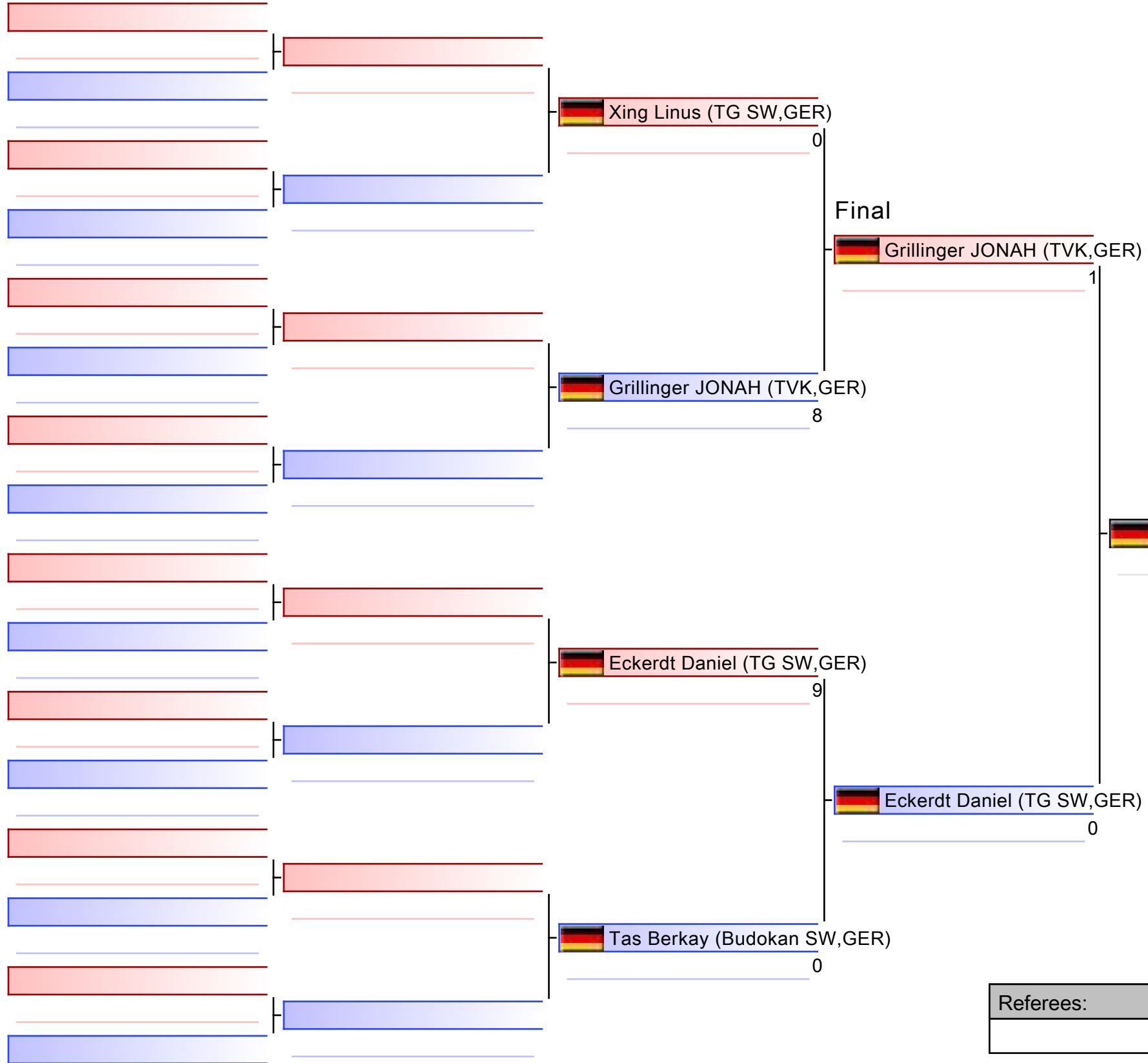

1. GRILLINGER JONAH (TVK,GER)
2. ECKERDT DANIEL (TG SW,GER)
3. XING LINUS (TG SW,GER)
3. TAS BERKAY (BUDOKAN SW,GER)

Referees:			

Kumite Schüler A -45kg männlich

OFFENE UNTERFRÄNKISCHE KARATE BEZIRKSMEISTERSCHAFT & NEWCOMER KARATE TURNIER 2024

Tatami

Pool

1

(c)sportdata GmbH & Co KG 2000-2024 (2024-10-12 18:43) v 10.2.0 build 1 (2024-09-26 10:14 CET) License: Online_Event_ID-8506_OFFENEUNTERFRNKISCHEKARATEBEZIRKSMEISTERSCHAFTNEWCOMERKARATETURNIER2024

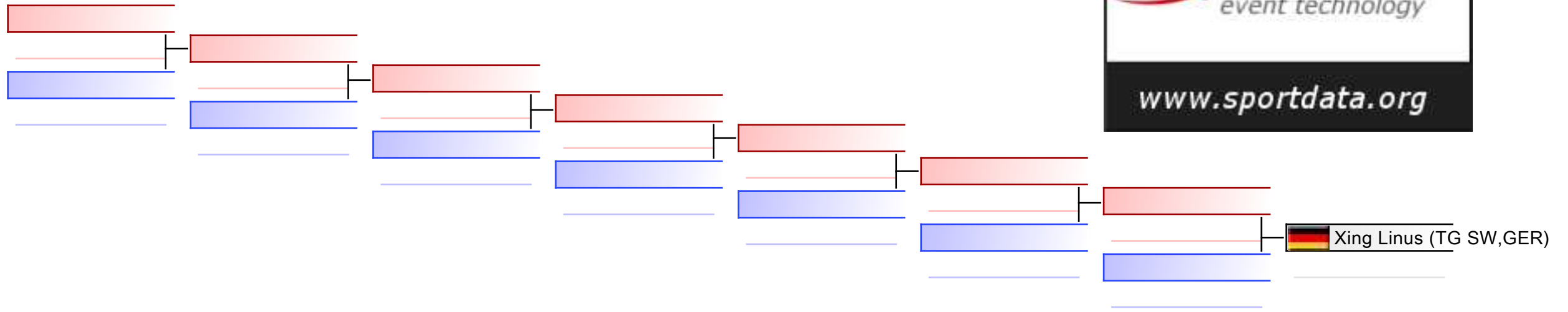

REPECHAGE: (1)

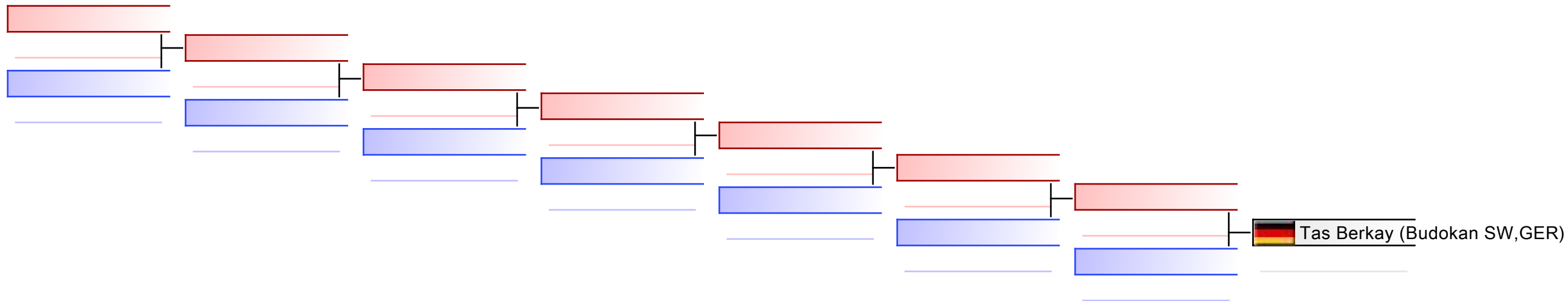

Referees:							
-----------	--	--	--	--	--	--	--

Kumite Schüler A -50/-55kg männlich

OFFENE UNTERFRÄNKISCHE KARATE BEZIRKSMEISTERSCHAFT & NEWCOMER KARATE TURNIER 2024, Hermasweg 1 97506 Grafenrheinfeld, GER

Tatami

Pool

1/1

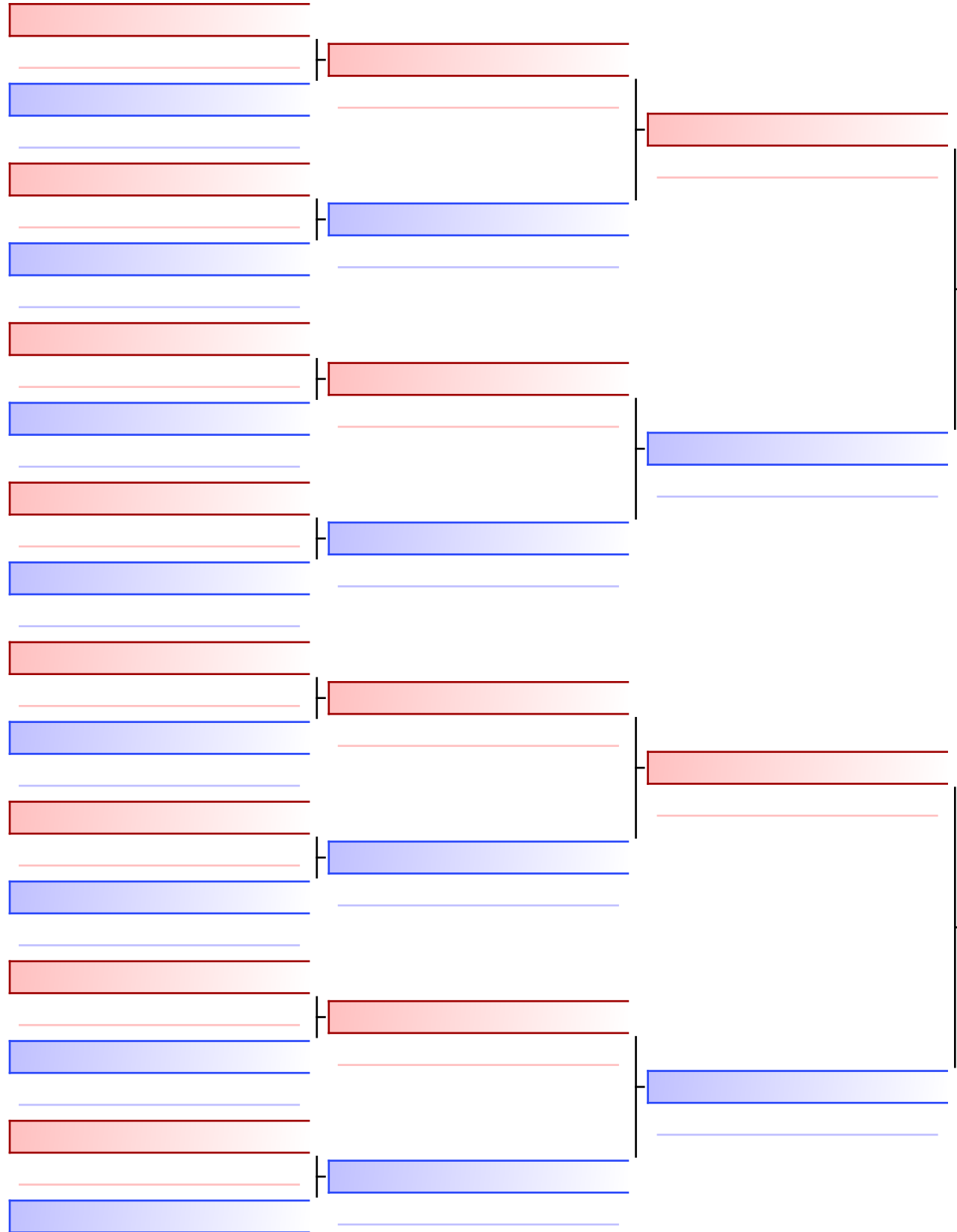

Final

Kummerer Paul (SV Abenberg,GER)

0

Stadick Till (TV Fürth,GER)

Stadick Till (TV Fürth,GER)

8

1. STADICK TILL (TV FÜRTH,GER)
2. KUMMERER PAUL (SV ABENBERG,GER)

Referees:			

Kumite Schüler A -52/+52kg weiblich

OFFENE UNTERFRÄNKISCHE KARATE BEZIRKSMEISTERSCHAFT & NEWCOMER KARATE TURNIER 2024, Hermasweg 1 97506 Grafenheinfeld, GER

Tatami

Pool

1/1

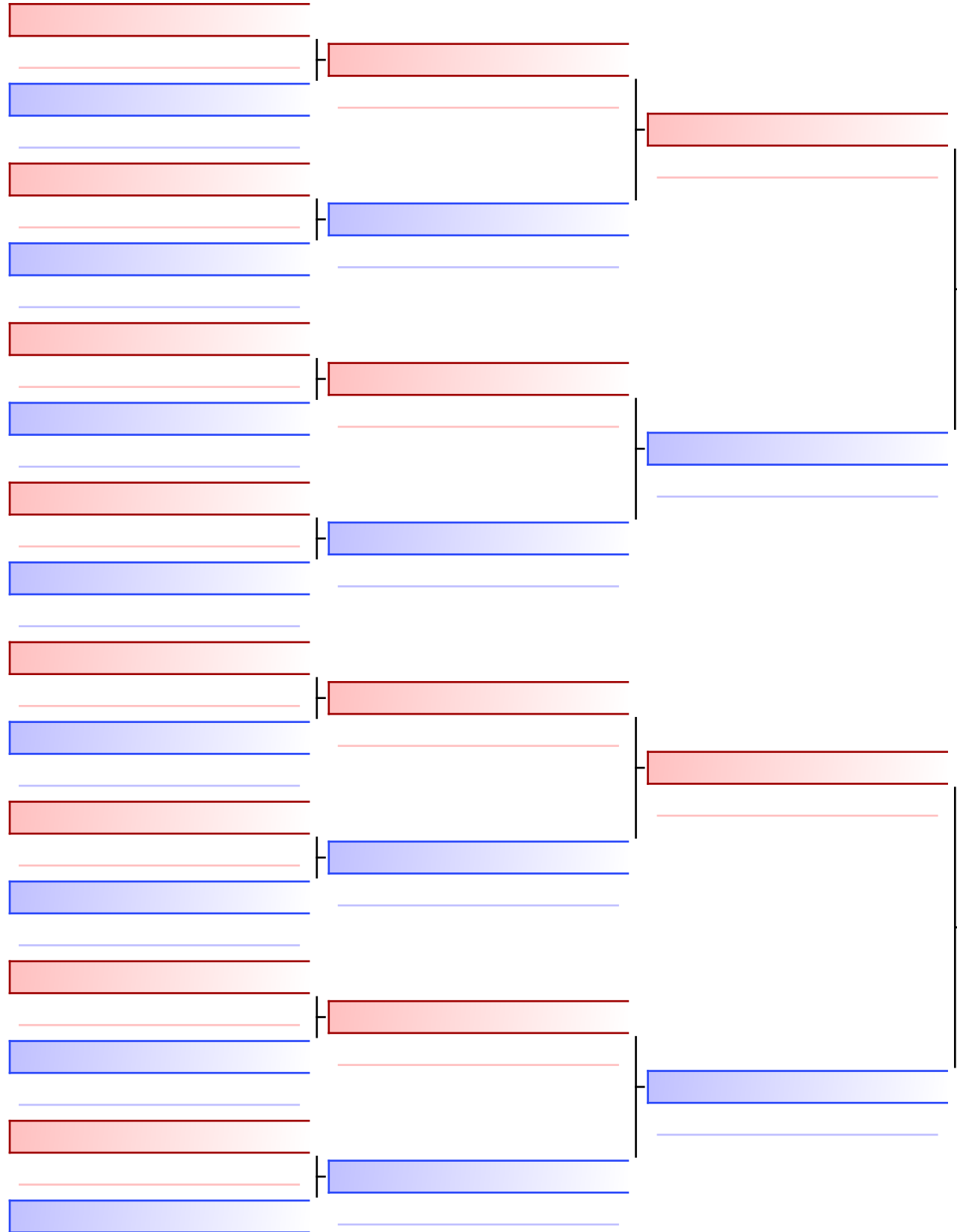

Final

Schubberth Carina (KDNaila,GER)

0

Khaless Marielle (TV Fürth,GER)

Khaless Marielle (TV Fürth,GER)

1

1. KHALESS MARIELLE (TV FÜRTH,GER)
2. SCHUBERTH CARINA (KDNAILA,GER)

Referees:			

Kumite Schüler B +38kg männlich

OFFENE UNTERFRÄNKISCHE KARATE BEZIRKSMEISTERSCHAFT & NEWCOMER KARATE TURNIER 2024, Hermasweg 1 97506 Grafenheinfeld, GER

2024-10-12

Tatami
2 14:30

Pool
1/1

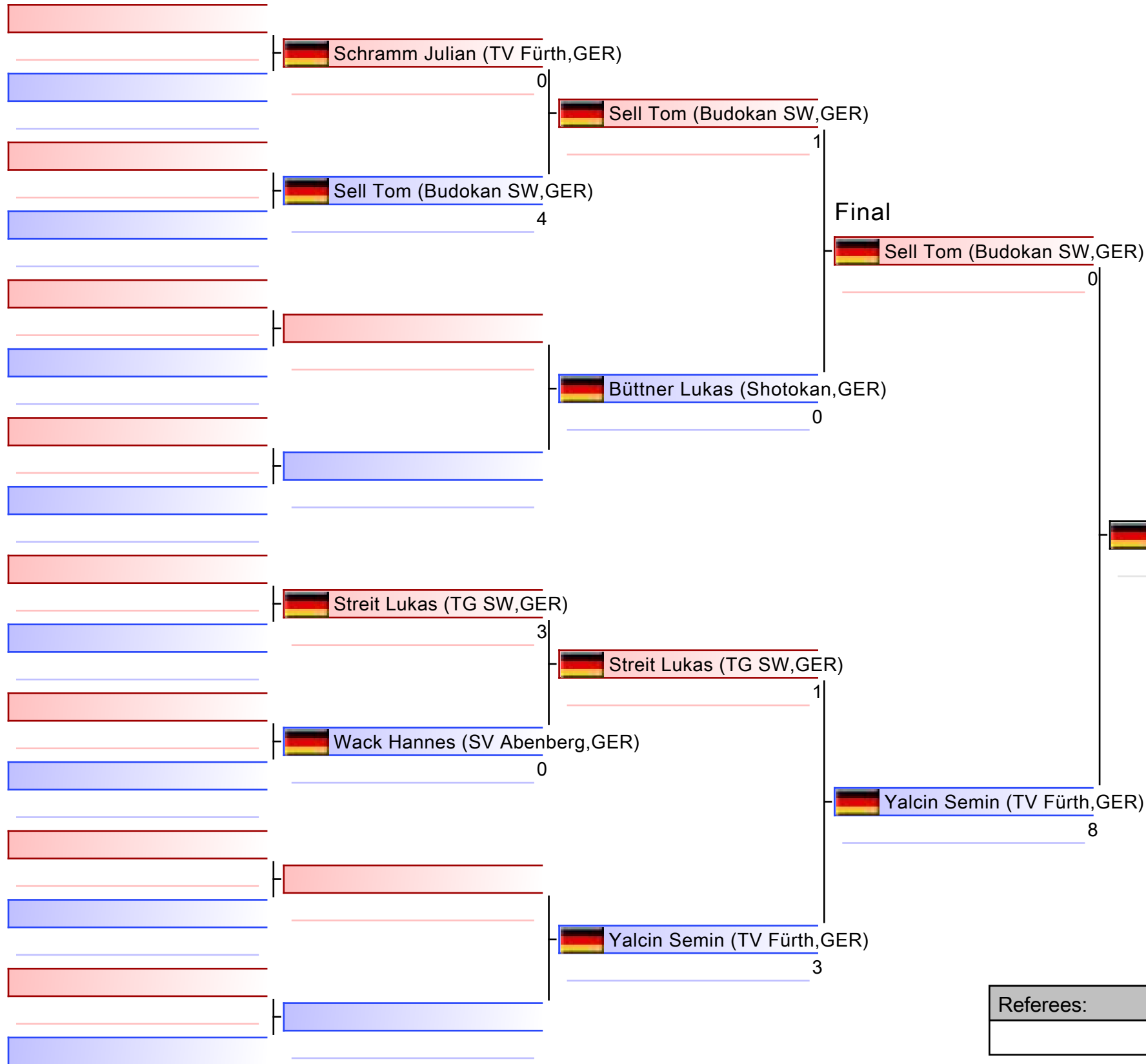

1. YALCIN SEMIN (TV FÜRTH,GER)
2. SELL TOM (BUDOKAN SW,GER)
3. STREIT LUKAS (TG SW,GER)
3. SCHRAMM JULIAN (TV FÜRTH,GER)
5. BÜTTNER LUKAS (SHOTOKAN,GER)

Referees:			

Kumite Schüler B +38kg männlich

OFFENE UNTERFRÄNKISCHE KARATE BEZIRKSMEISTERSCHAFT & NEWCOMER KARATE TURNIER 2024

2024-10-12

Tatami
2 14:45

Pool
1

(c)sportdata GmbH & Co KG 2000-2024 (2024-10-12 18:43) v 10.2.0 build 1 (2024-09-26 10:14 CET) License: Online_Event_ID-8506_OFFENEUNTERFRNKISCHEKARATEBEZIRKSMEISTERSCHAFTNEWCOMERKARATETURNIER2024

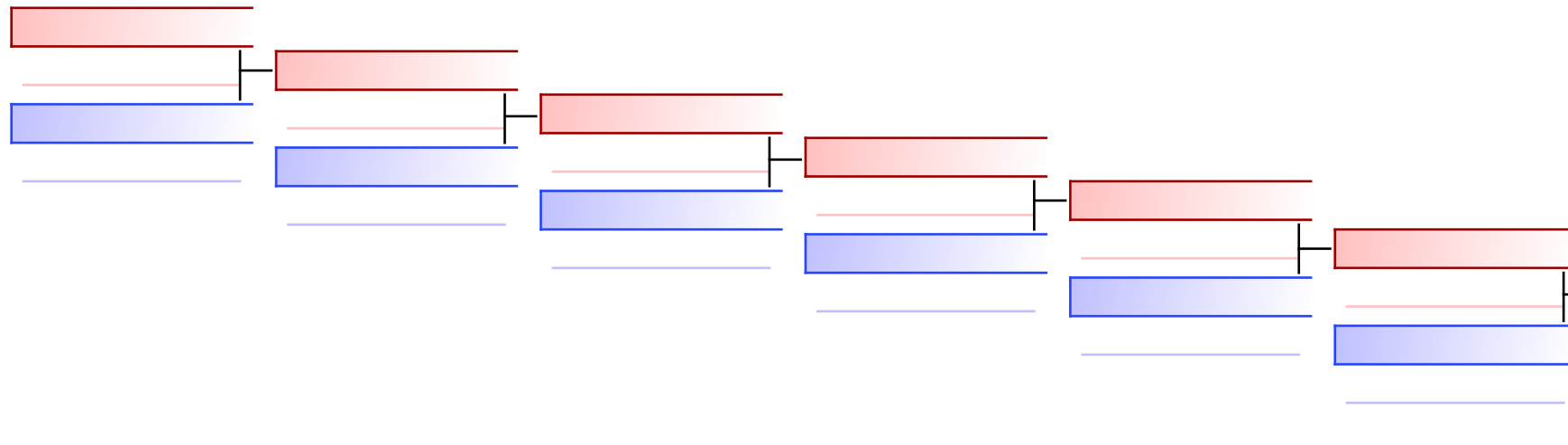

Schramm Julian (TV Fürth,GER)
4
 Schramm Julian (TV Fürth,GER)
 Büttner Lukas (Shotokan,GER)
0

REPECHAGE: (1)

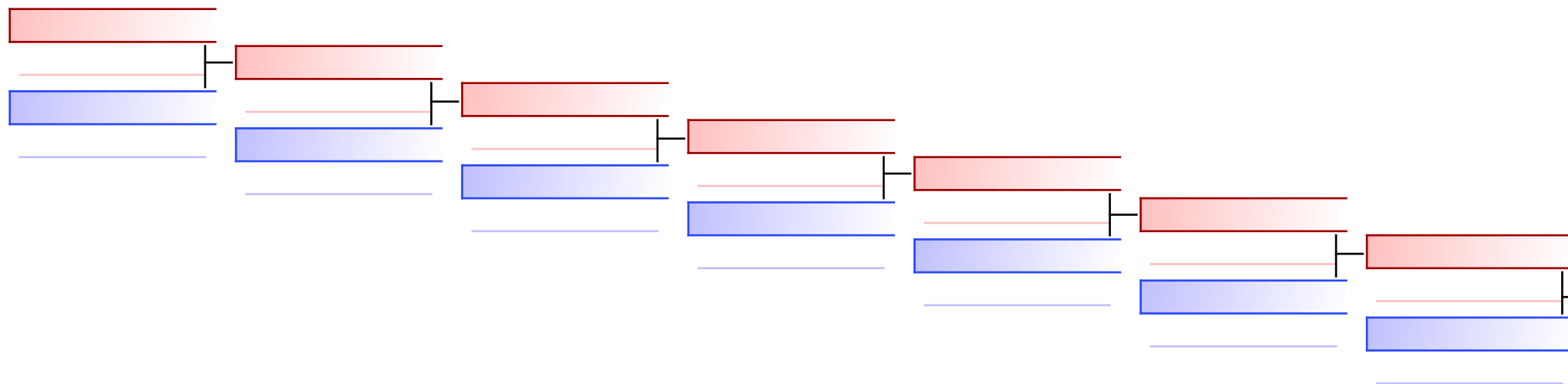

Streit Lukas (TG SW,GER)

Referees:							
-----------	--	--	--	--	--	--	--

Kumite Schüler B -32kg männlich

OFFENE UNTERFRÄNKISCHE KARATE BEZIRKSMEISTERSCHAFT & NEWCOMER KARATE TURNIER 2024, Hermasweg 1 97506 Grafenrheinfeld, GER

2024-10-12

Tatami
3 14:15

Pool
1/1

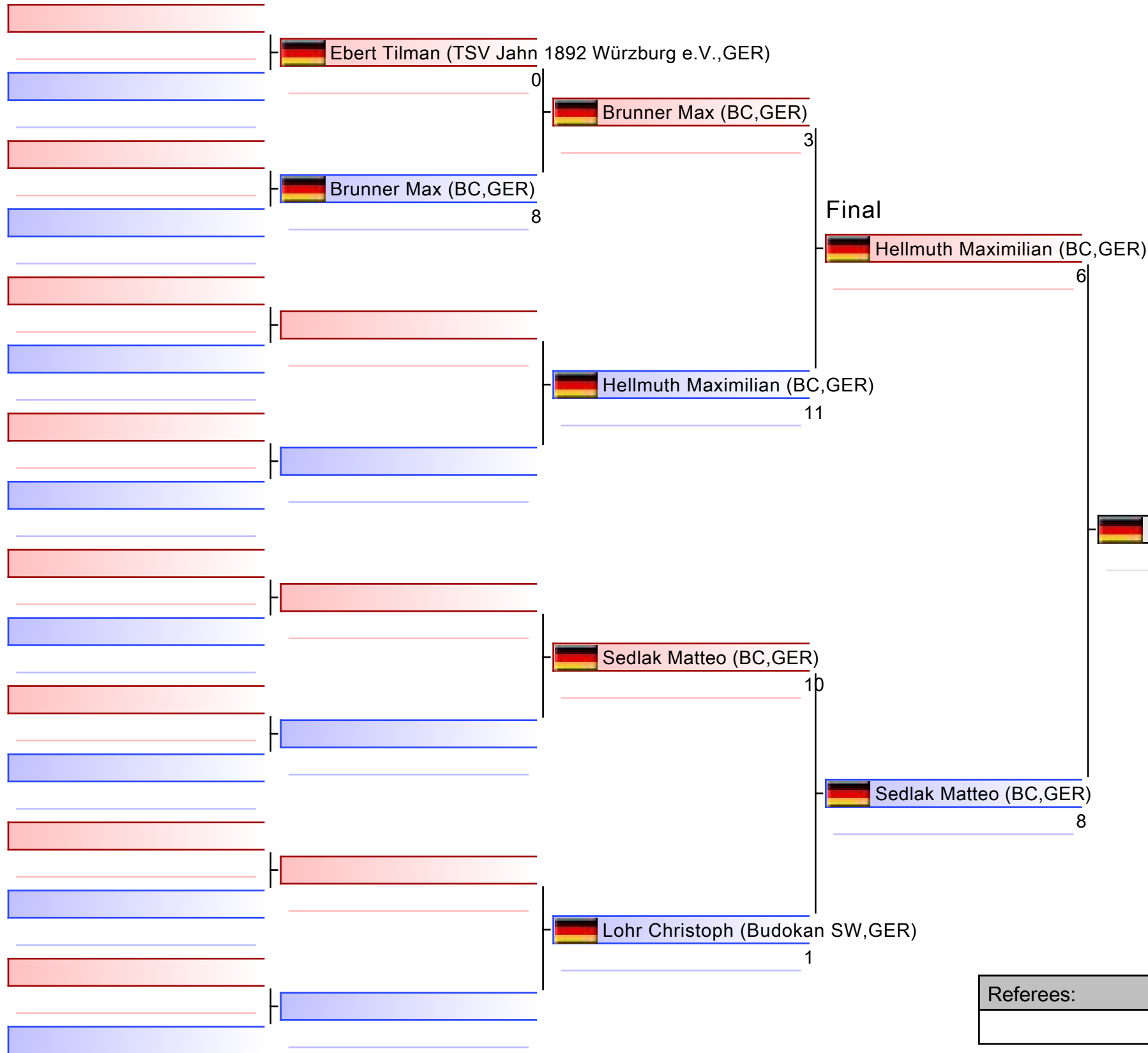

1. SEDLAK MATTEO (BC,GER)
2. HELLMUTH MAXIMILIAN (BC,GER)
3. BRUNNER MAX (BC,GER)
3. LOHR CHRISTOPH (BUDOKAN SW,GER)

Referees:			

Kumite Schüler B -32kg männlich

OFFENE UNTERFRÄNKISCHE KARATE BEZIRKSMEISTERSCHAFT & NEWCOMER KARATE TURNIER 2024

2024-10-12

Tatami

3 14:30

Pool

1

(c)sportdata GmbH & Co KG 2000-2024 (2024-10-12 18:43) v 10.2.0 build 1 (2024-09-26 10:14 CET) License: Online_Event_ID-8506_OFFENEUNTERFRNKISCHEKARATEBEZIRKSMEISTERSCHAFTNEWCOMERKARATETURNIER2024

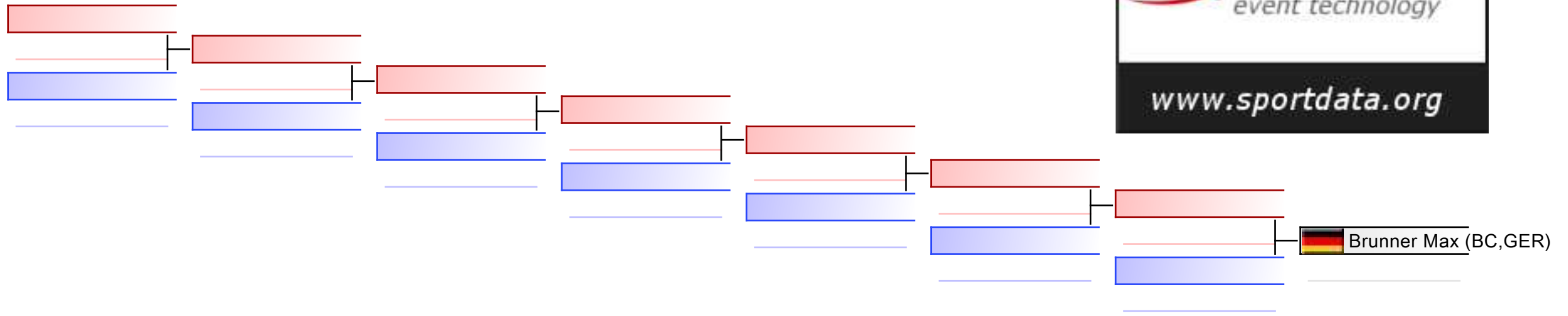

REPECHAGE: (1)

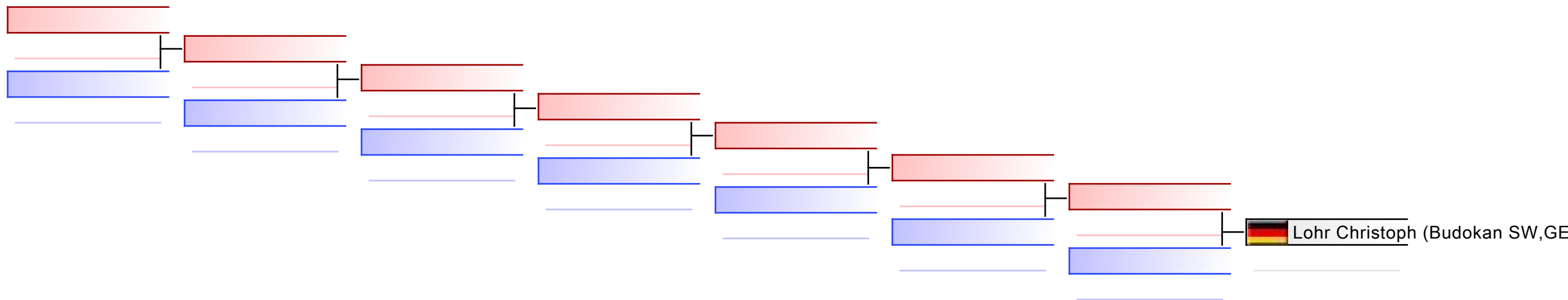

Referees:							
-----------	--	--	--	--	--	--	--

Kumite Schüler B -38kg männlich

OFFENE UNTERFRÄNKISCHE KARATE BEZIRKSMEISTERSCHAFT & NEWCOMER KARATE TURNIER 2024, Hermasweg 1 97506 Grafenrheinfeld, GER

2024-10-12

Tatami
1 14:30

Pool
1/1

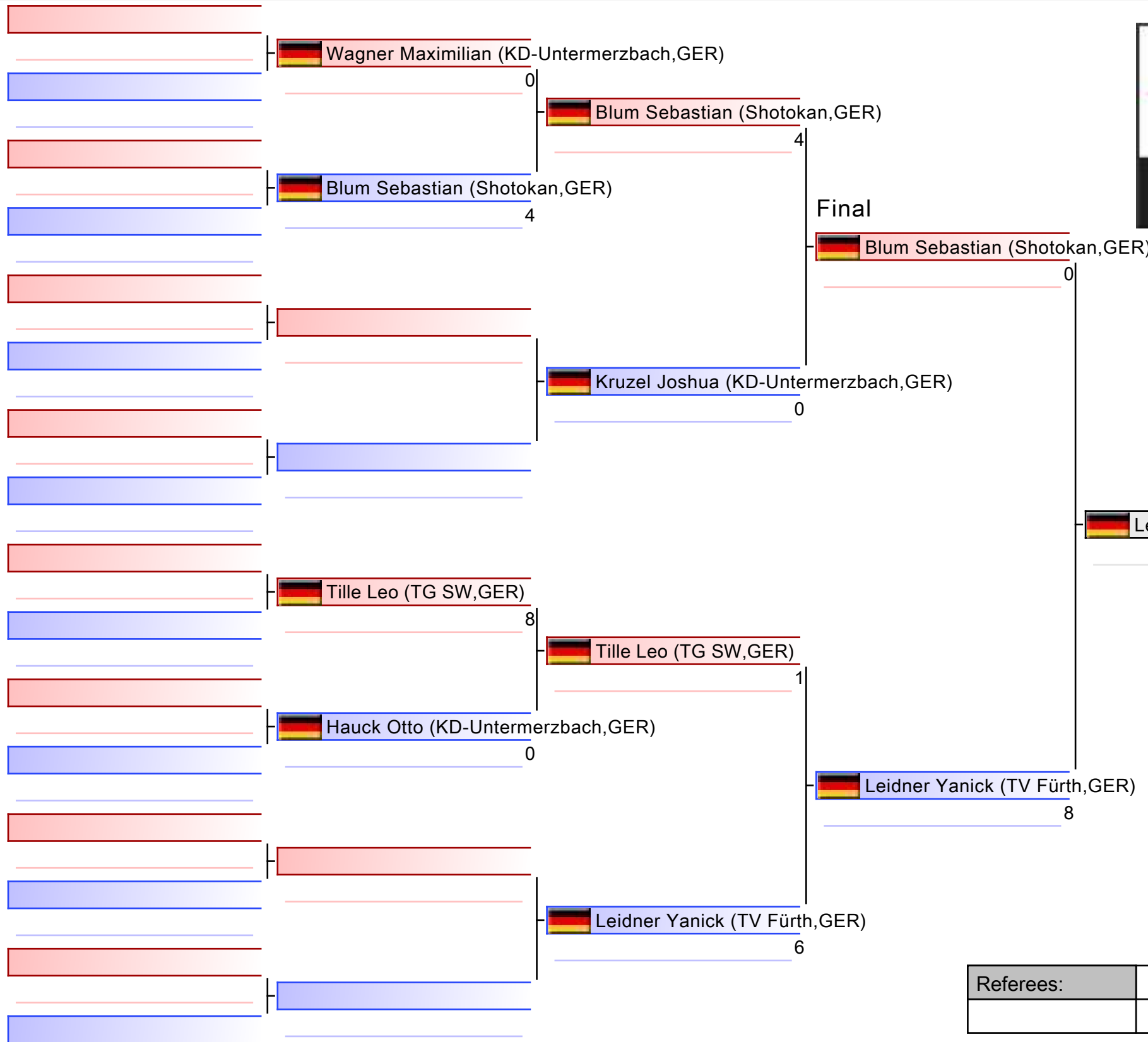

1. LEIDNER YANICK (TV FÜRTH,GER)
2. BLUM SEBASTIAN (SHOTOKAN,GER)
3. TILLE LEO (TG SW,GER)
3. WAGNER MAXIMILIAN (KD-UNTERMERZBACH,GER)
5. KRUZEL JOSHUA (KD-UNTERMERZBACH,GER)

Referees:			

Kumite Schüler B -38kg männlich

OFFENE UNTERFRÄNKISCHE KARATE BEZIRKSMEISTERSCHAFT & NEWCOMER KARATE TURNIER 2024

2024-10-12

Tatami
1 14:45

Pool
1

(c)sportdata GmbH & Co KG 2000-2024 (2024-10-12 18:43) v 10.2.0 build 1 (2024-09-26 10:14 CET) License: Online_Event_ID-8506_OFFENEUNTERFRNKISCHEKARATEBEZIRKSMEISTERSCHAFTNEWCOMERKARATETURNIER2024

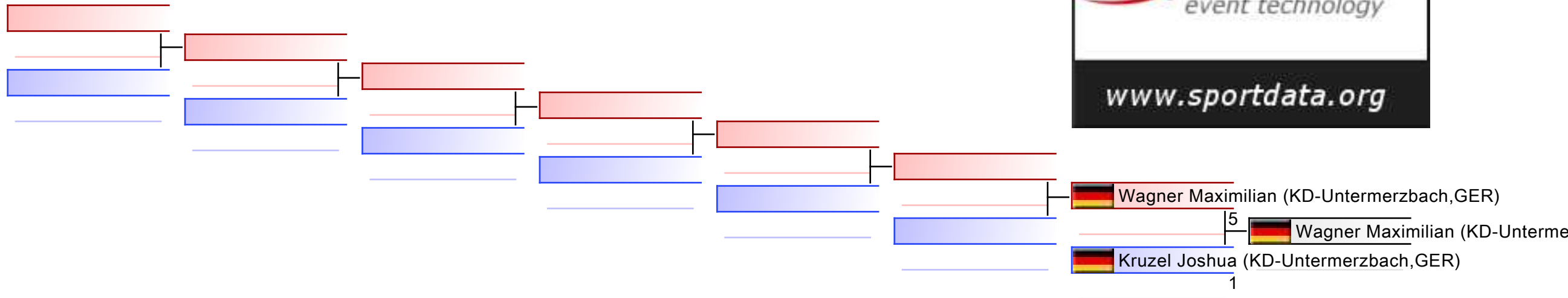

REPECHAGE: (1)

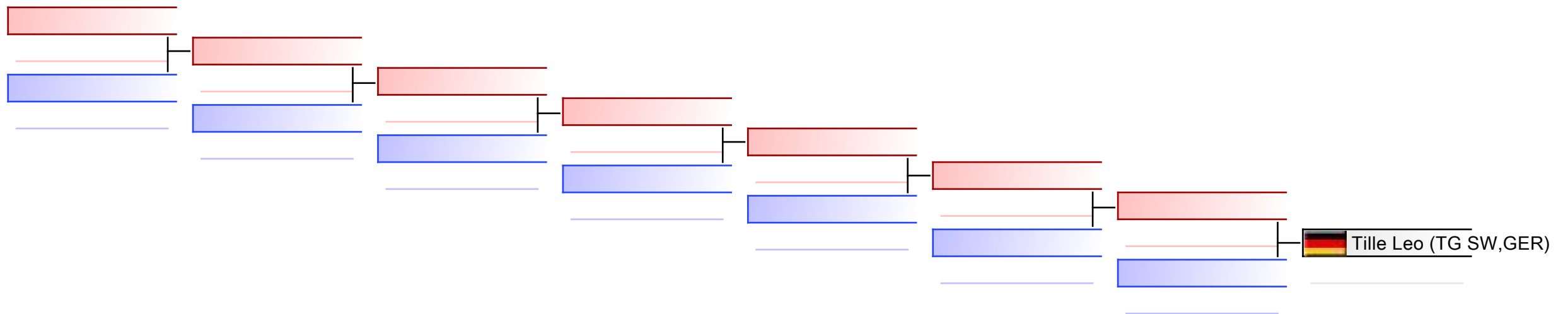

Referees:							
-----------	--	--	--	--	--	--	--

Kumite Team Jugend/Junioren weiblich

OFFENE UNTERFRÄNKISCHE KARATE BEZIRKSMEISTERSCHAFT & NEWCOMER KARATE TURNIER 2024, Hermasweg 1 97506 Grafenheinfeld, GER

2024-10-12

Tatami

2 17:05

Pool

1/1

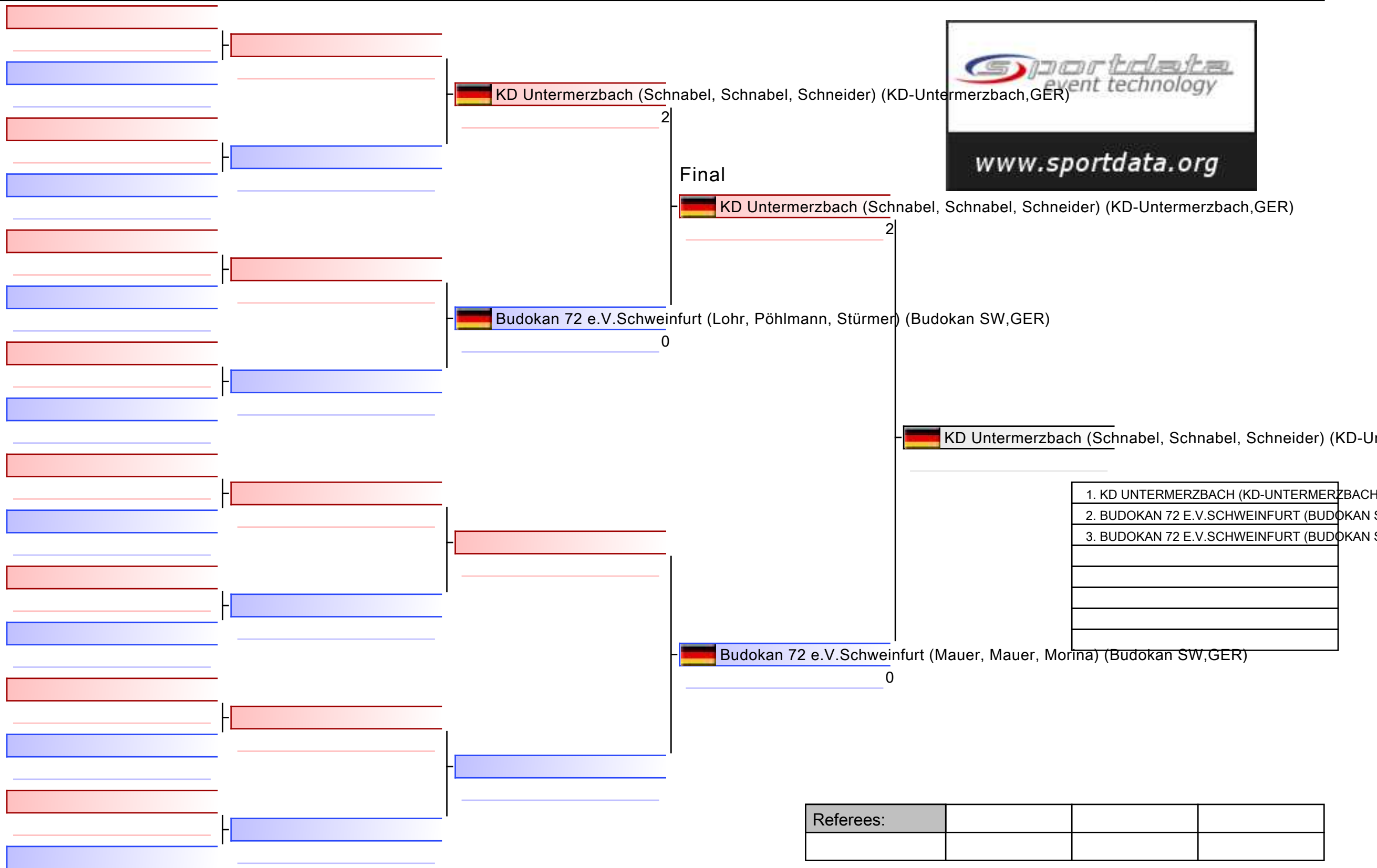

Kumite Team Jugend/Junioren weiblich

OFFENE UNTERFRÄNKISCHE KARATE BEZIRKSMEISTERSCHAFT & NEWCOMER KARATE TURNIER 2024

Tatami

Pool

1

(c)sportdata GmbH & Co KG 2000-2024 (2024-10-12 18:43) v 10.2.0 build 1 (2024-09-26 10:14 CET) License: Online_Event_ID-8506_OFFENEUNTERFRNKISCHEKARATEBEZIRKSMEISTERSCHAFTNEWCOMERKARATETURNIER2024

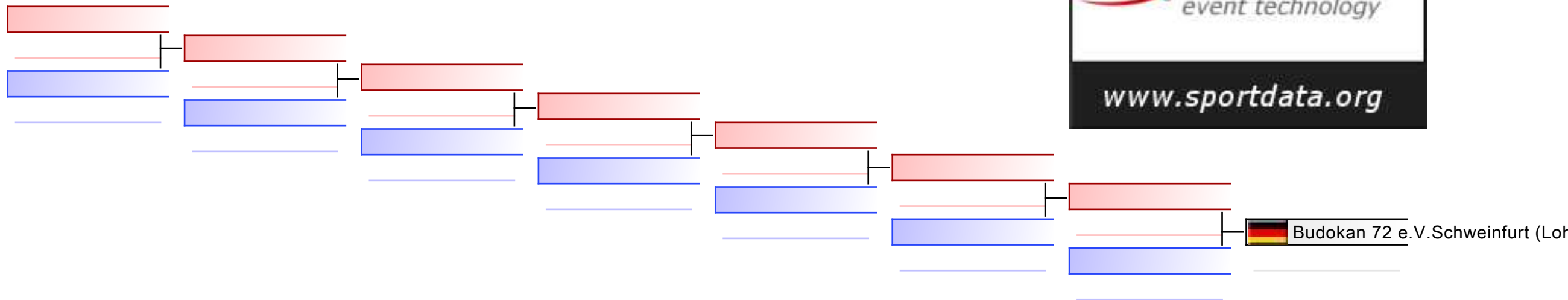

REPECHAGE: (1)

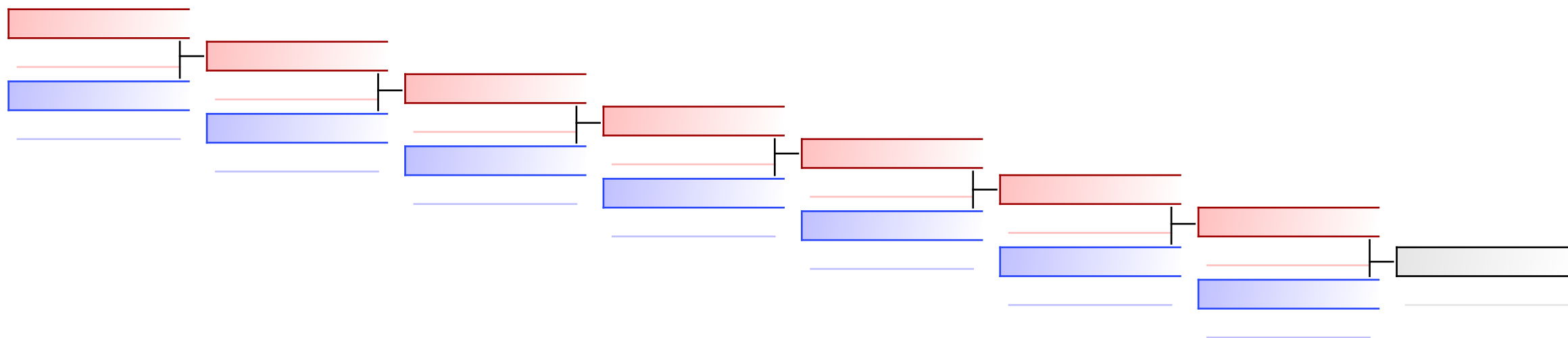

Referees:							
-----------	--	--	--	--	--	--	--

Kumite Team Schüler A&B männlich

OFFENE UNTERFRÄNKISCHE KARATE BEZIRKSMEISTERSCHAFT & NEWCOMER KARATE TURNIER 2024, Hermasweg 1 97506 Grafenrheinfeld, GER

2024-10-12

Tatami

3 16:25

Pool

1/2

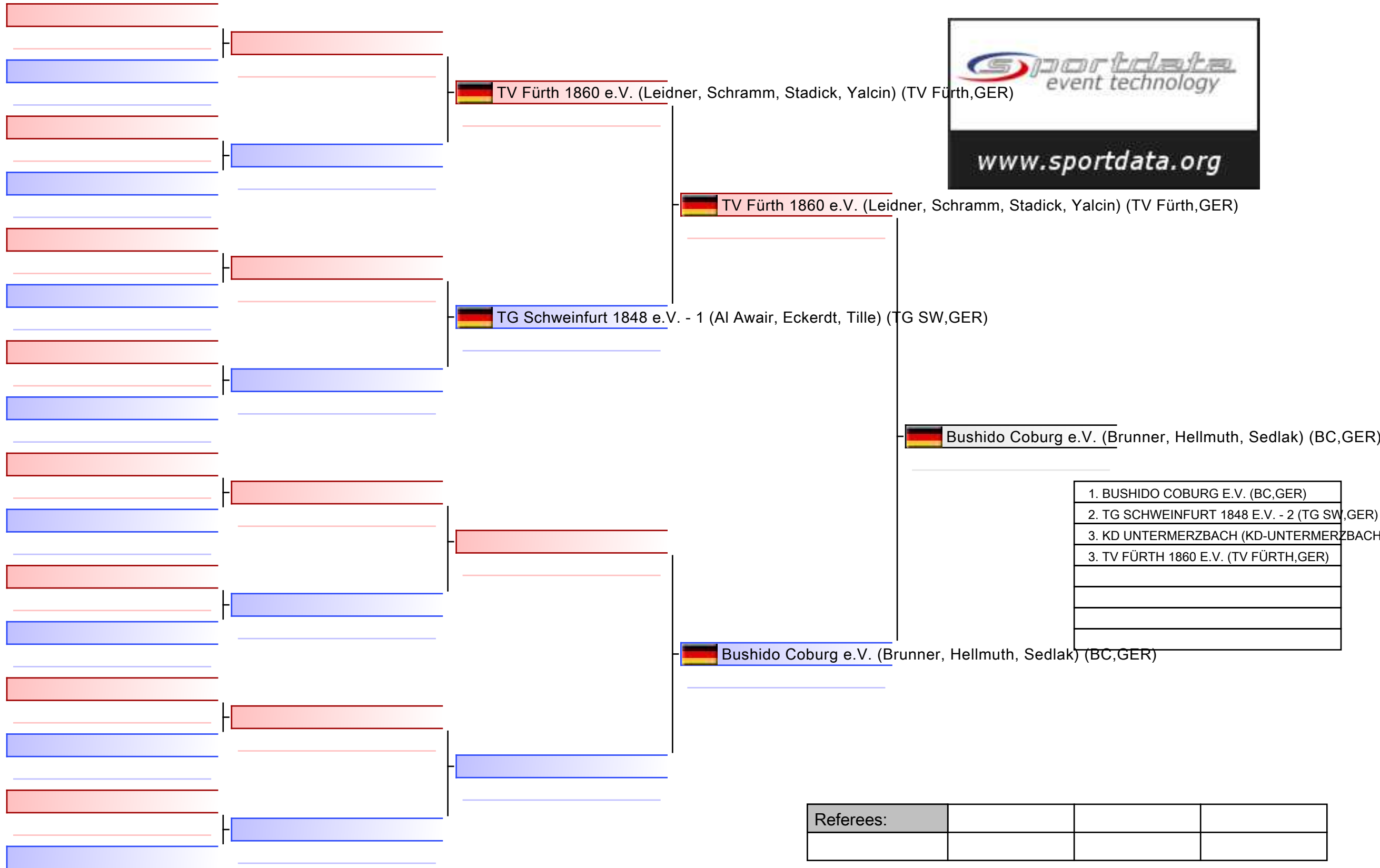

Kumite Team Schüler A&B männlich

OFFENE UNTERFRÄNKISCHE KARATE BEZIRKSMEISTERSCHAFT & NEWCOMER KARATE TURNIER 2024, Hermasweg 1 97506 Grafenrheinfeld, GER

2024-10-12

Tatami

1 16:05

Pool

2/2

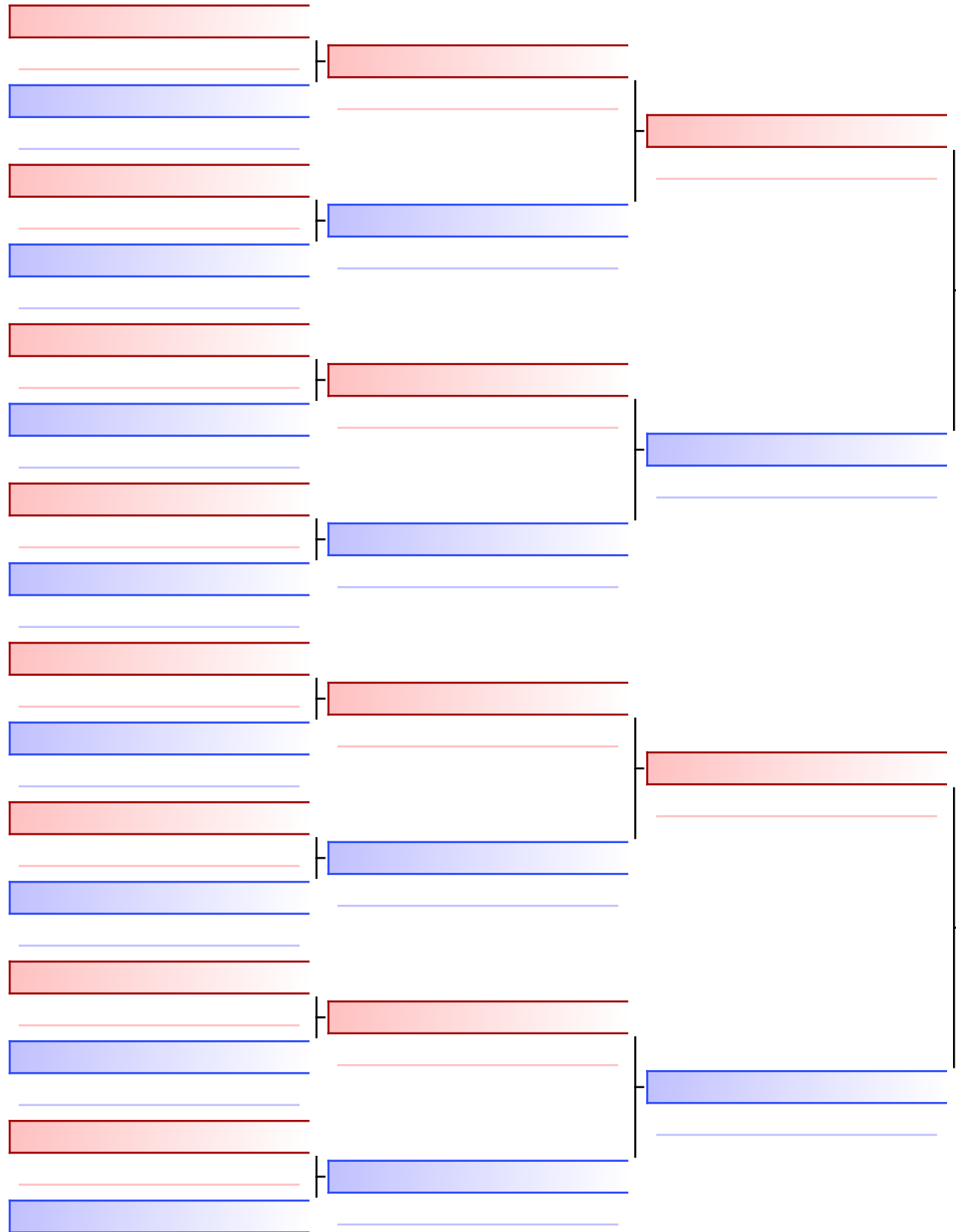

 **KD Untermerzbach (Hauck, Kruzel, Wagner) (KD-Untermerzbach,GER)**

0

 **TG Schweinfurt 1848 e.V. - 2 (Streit, Trogisch, Xing) (TG SW,GER)**

1. BUSHIDO COBURG E.V. (BC,GER)
2. TG SCHWEINFURT 1848 E.V. - 2 (TG SW,GER)
3. KD UNTERMERZBACH (KD-UNTERMERZBACH,GER)
3. TV FÜRTH 1860 E.V. (TV FÜRTH,GER)

 **TG Schweinfurt 1848 e.V. - 2 (Streit, Trogisch, Xing) (TG SW,GER)**

2

Referees:			

Pool winner-Kumite Team Schüler A&B männlich

OFFENE UNTERFRÄNKISCHE KARATE BEZIRKSMEISTERSCHAFT & NEWCOMER KARATE TURNIER 2024, Hermasweg 1 97506 Grafenrheinfeld, GER

Tatami

Pool
1/1

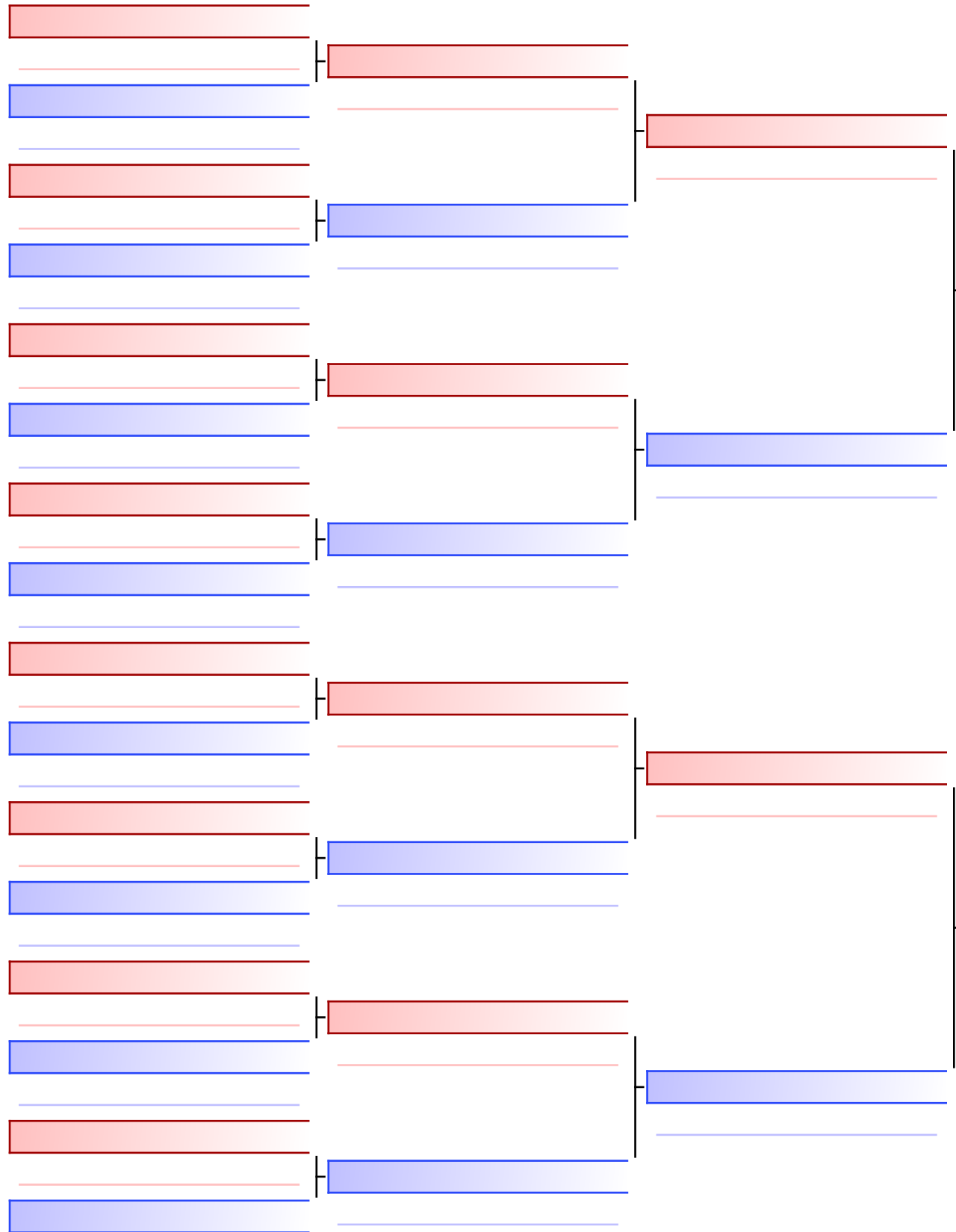

Final

Bushido Coburg e.V. (Brunner, Hellmuth, Sedlak) (BC,GER)

2

Bushido Coburg e.V. (Brunner, Hellmuth, Sedlak) (BC,GER)

TG Schweinfurt 1848 e.V. - 2 (Streit, Trogisch, Xing) (TG SW,GER)

1

- | |
|---|
| 1. BUSHIDO COBURG E.V. (BC,GER) |
| 2. TG SCHWEINFURT 1848 E.V. - 2 (TG SW,GER) |
| 3. KD UNTERMERZBACH (KD-UNTERMERZBACH) |
| 3. TV FÜRTH 1860 E.V. (TV FÜRTH,GER) |
| |
| |
| |

Referees:			

Kumite Team Schüler A&B männlich

OFFENE UNTERFRÄNKISCHE KARATE BEZIRKSMEISTERSCHAFT & NEWCOMER KARATE TURNIER 2024

2024-10-12

Tatami

3 16:50

Pool

1

(c)sportdata GmbH & Co KG 2000-2024 (2024-10-12 18:43) v 10.2.0 build 1 (2024-09-26 10:14 CET) License: Online_Event_ID-8506_OFFENEUNTERFRNKISCHEKARATEBEZIRKSMEISTERSCHAFTNEWCOMERKARATETURNIER2024

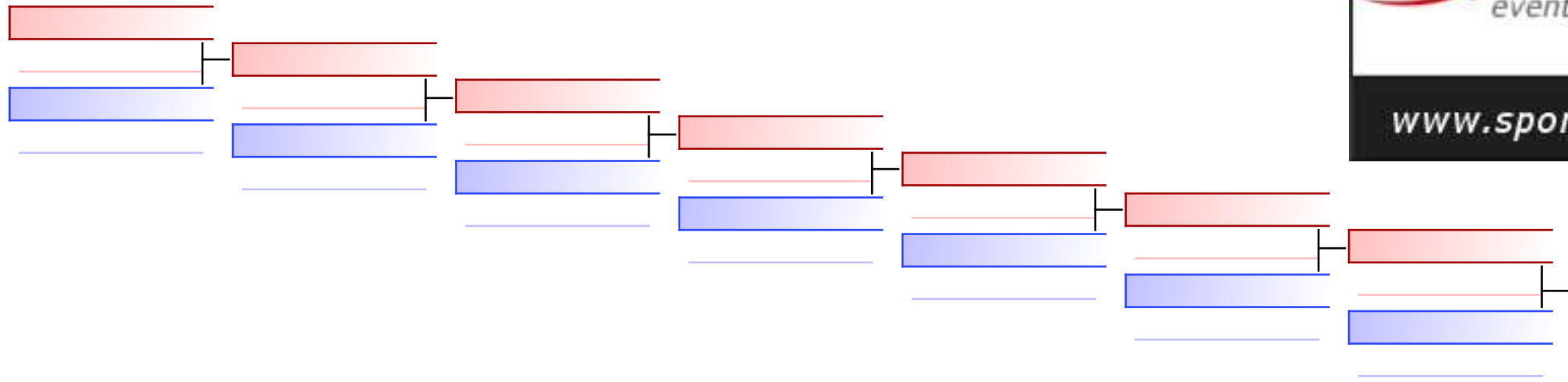

 TV Fürth 1860 e.V. (Leidner, Sch...

REPECHAGE: (1)

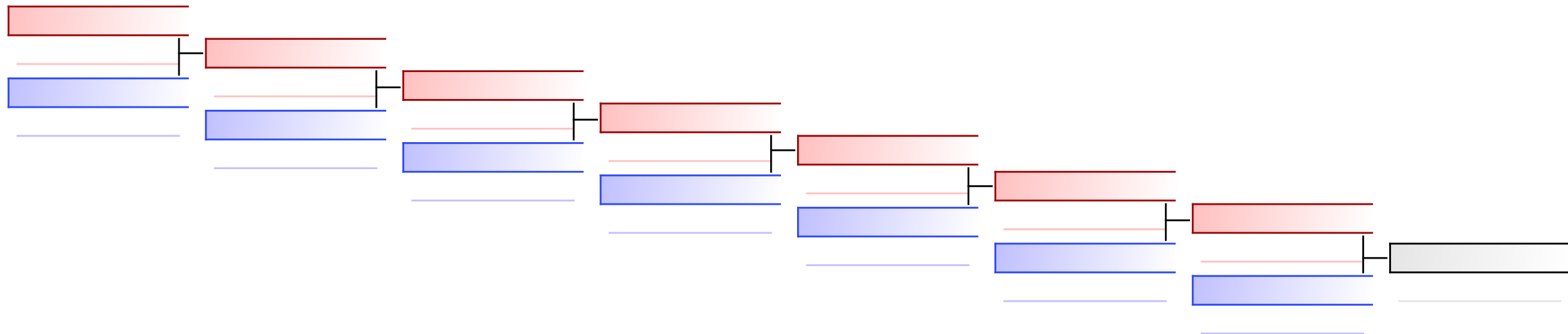

Referees:							
-----------	--	--	--	--	--	--	--

Kumite Team Schüler A&B männlich

OFFENE UNTERFRÄNKISCHE KARATE BEZIRKSMEISTERSCHAFT & NEWCOMER KARATE TURNIER 2024

2024-10-12

Tatami

1 16:20

Pool

2

(c)sportdata GmbH & Co KG 2000-2024 (2024-10-12 18:43) v 10.2.0 build 1 (2024-09-26 10:14 CET) License: Online_Event_ID-8506_OFFENEUNTERFRNKISCHEKARATEBEZIRKSMEISTERSCHAFTNEWCOMERKARATETURNIER2024

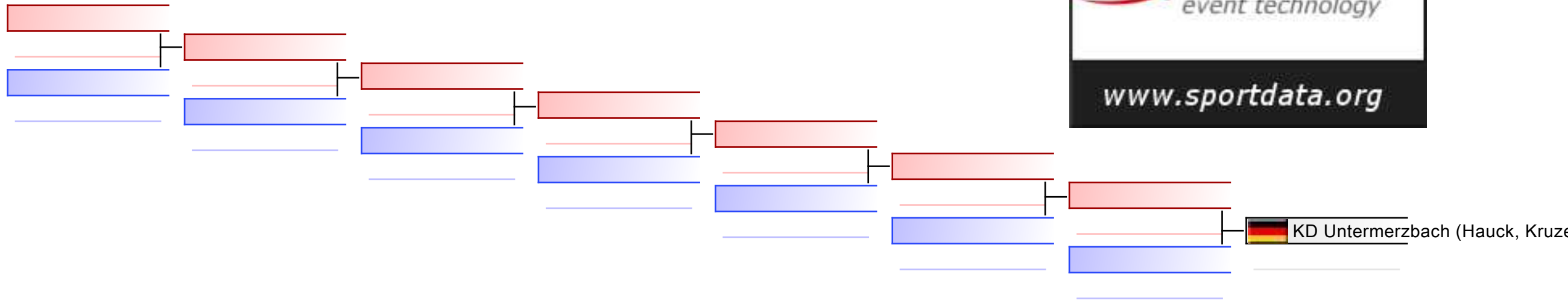

REPECHAGE: (2)

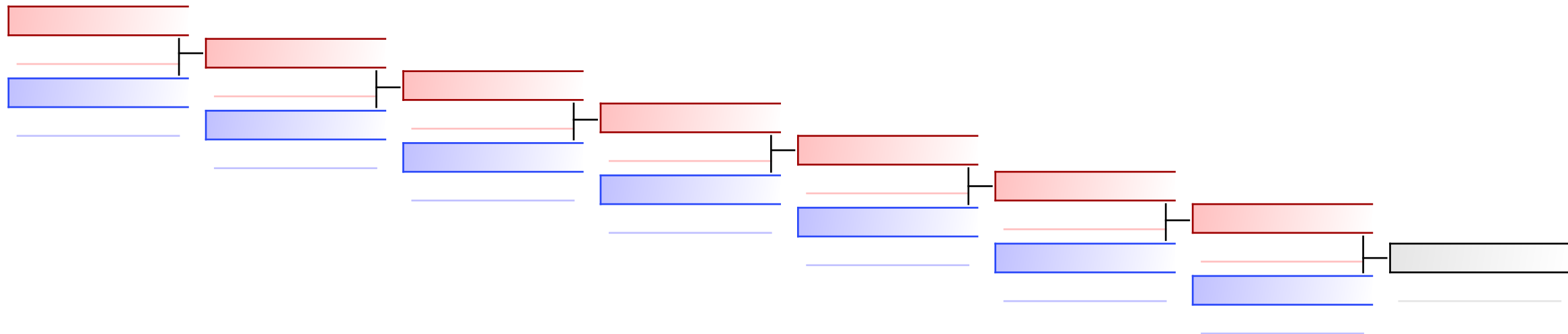

Referees:							
-----------	--	--	--	--	--	--	--

Kumite Team Schüler A&B weiblich

OFFENE UNTERFRÄNKISCHE KARATE BEZIRKSMEISTERSCHAFT & NEWCOMER KARATE TURNIER 2024, Hermasweg 1 97506 Grafenrheinfeld, GER

Tatami

Pool

1/1

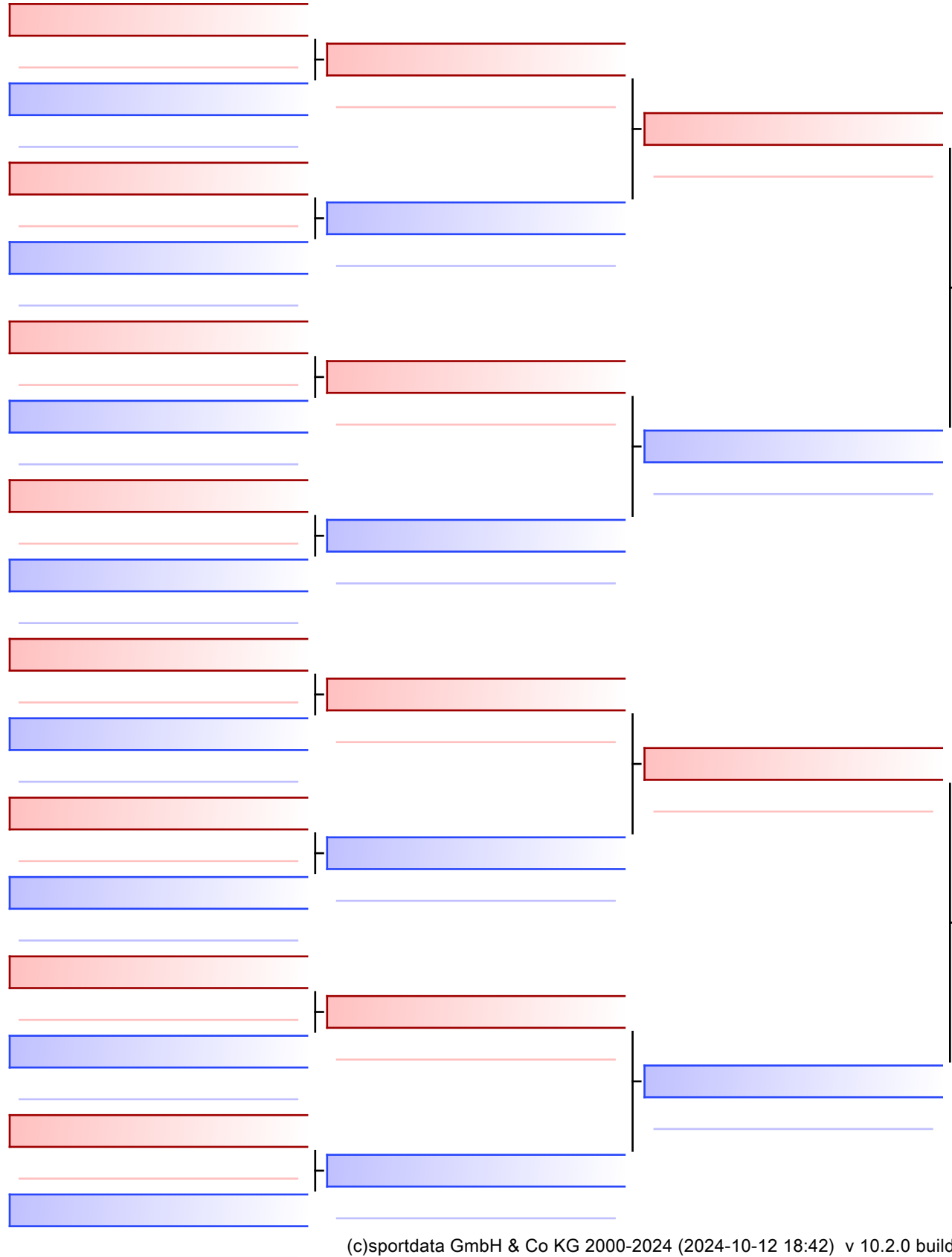

Final

 KD Untermerzbach (Bayer, Dünisch, Schulz) (KD-Untermerzbach,GER)

 KD Untermerzbach (Bayer, Dünisch, Schulz) (KD-Untermerzbach,GER)

1. KD UNTERMERZBACH (KD-UNTERMERZBACH,GER)
2. TV FÜRTH 1860 E.V. (TV FÜRTH,GER)

 TV Fürth 1860 e.V. (Böckelmann, Khaless, Meyer) (TV Fürth,GER)

Referees:			

Newcomer Kata Kinder A 7.-6. Kyu mixed

OFFENE UNTERFRÄNKISCHE KARATE BEZIRKSMEISTERSCHAFT & NEWCOMER KARATE TURNIER 2024, Hermasweg 1 97506 Grafenrheinfeld, GER

2024-10-12

Tatami
3 09:30

Pool
1/1

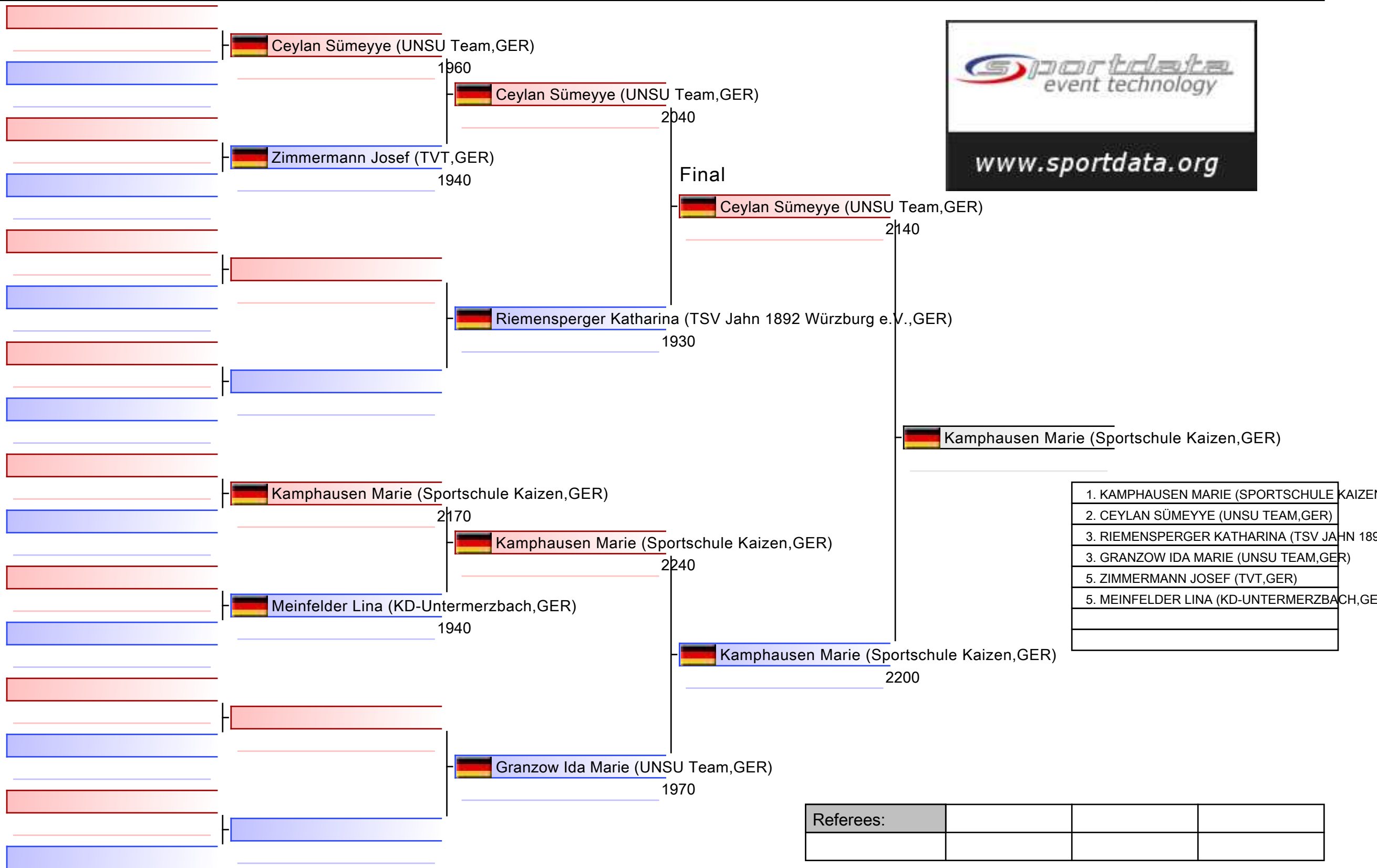

1. KAMPHAUSEN MARIE (SPORTSCHULE KAIZEN,GER)
2. CEYLAN SÜMEYYE (UNSU TEAM,GER)
3. RIEMENSPERGER KATHARINA (TSV JAHN 1892 WÜRZBURG E.V.,GER)
3. GRANZOW IDA MARIE (UNSU TEAM,GER)
5. ZIMMERMANN JOSEF (TVT,GER)
5. MEINFELDER LINA (KD-UNTERMERZBACH,GER)

Referees:			

Newcomer Kata Kinder A 7.-6. Kyu mixed

OFFENE UNTERFRÄNKISCHE KARATE BEZIRKSMEISTERSCHAFT & NEWCOMER KARATE TURNIER 2024

2024-10-12

Tatami
3 09:45

Pool
1

(c)sportdata GmbH & Co KG 2000-2024 (2024-10-12 18:43) v 10.2.0 build 1 (2024-09-26 10:14 CET) License: Online_Event_ID-8506_OFFENEUNTERFRNKISCHEKARATEBEZIRKSMEISTERSCHAFTNEWCOMERKARATETURNIER2024

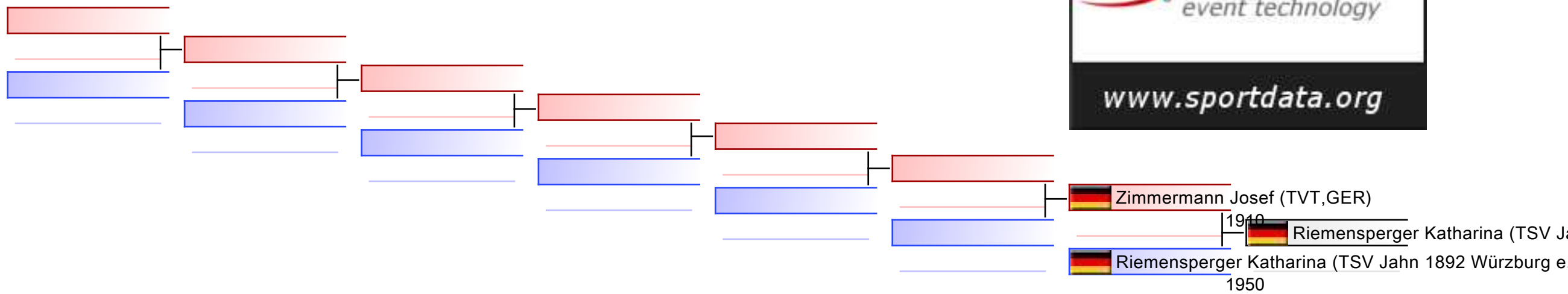

REPECHAGE: (1)

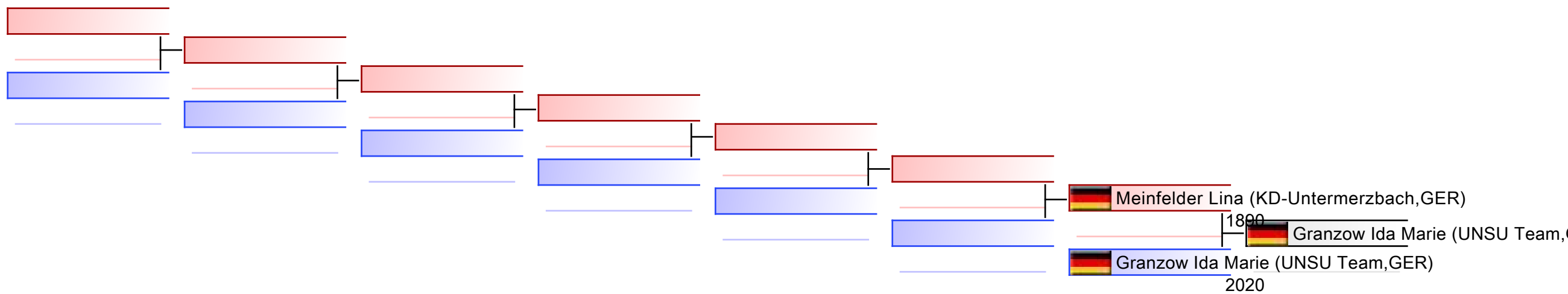

Referees:							
-----------	--	--	--	--	--	--	--

Newcomer Kata Kinder A 9.-8.Kyu männlich

OFFENE UNTERFRÄNKISCHE KARATE BEZIRKSMEISTERSCHAFT & NEWCOMER KARATE TURNIER 2024, Hermasweg 1 97506 Grafenrheinfeld, GER

2024-10-12

Tatami
2 09:30

Pool
1/1

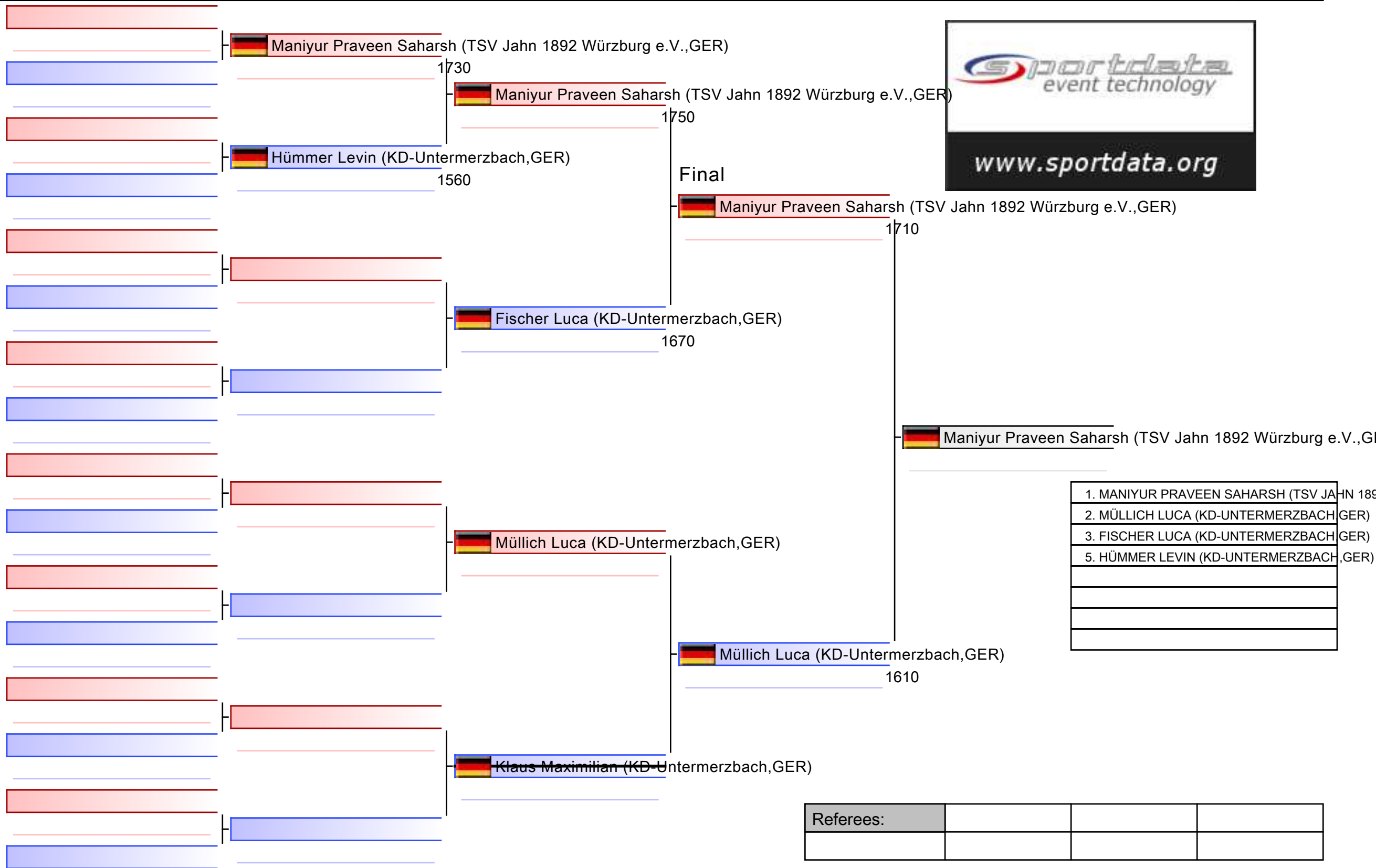

1. MANIYUR PRAVEEN SAHARSH (TSV JAHN 1892 WÜRZBURG E.V.,GER)
2. MÜLLICH LUCA (KD-UNTERMERZBACH,GER)
3. FISCHER LUCA (KD-UNTERMERZBACH,GER)
5. HÜMMEL LEVIN (KD-UNTERMERZBACH,GER)

Referees:			

Newcomer Kata Kinder A 9.-8.Kyu männlich

OFFENE UNTERFRÄNKISCHE KARATE BEZIRKSMEISTERSCHAFT & NEWCOMER KARATE TURNIER 2024

2024-10-12

Tatami
2 09:45

Pool
1

(c)sportdata GmbH & Co KG 2000-2024 (2024-10-12 18:43) v 10.2.0 build 1 (2024-09-26 10:14 CET) License: Online_Event_ID-8506_OFFENEUNTERFRNKISCHEKARATEBEZIRKSMEISTERSCHAFTNEWCOMERKARATETURNIER2024

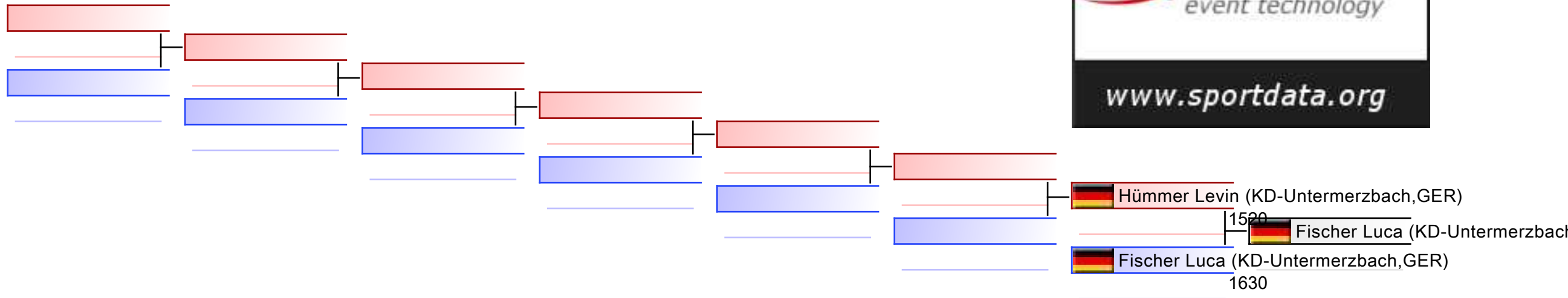

REPECHAGE: (1)

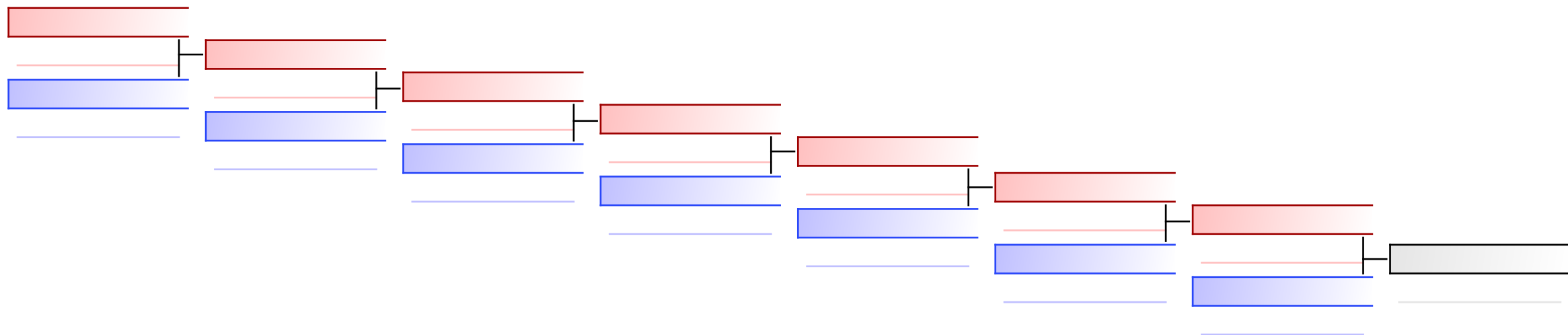

Referees:							
-----------	--	--	--	--	--	--	--

Newcomer Kata Kinder A 9.-8.Kyu weiblich

OFFENE UNTERFRÄNKISCHE KARATE BEZIRKSMEISTERSCHAFT & NEWCOMER KARATE TURNIER 2024, Hermasweg 1 97506 Grafenrheinfeld, GER

2024-10-12

Tatami
2 10:00

Pool
1/1

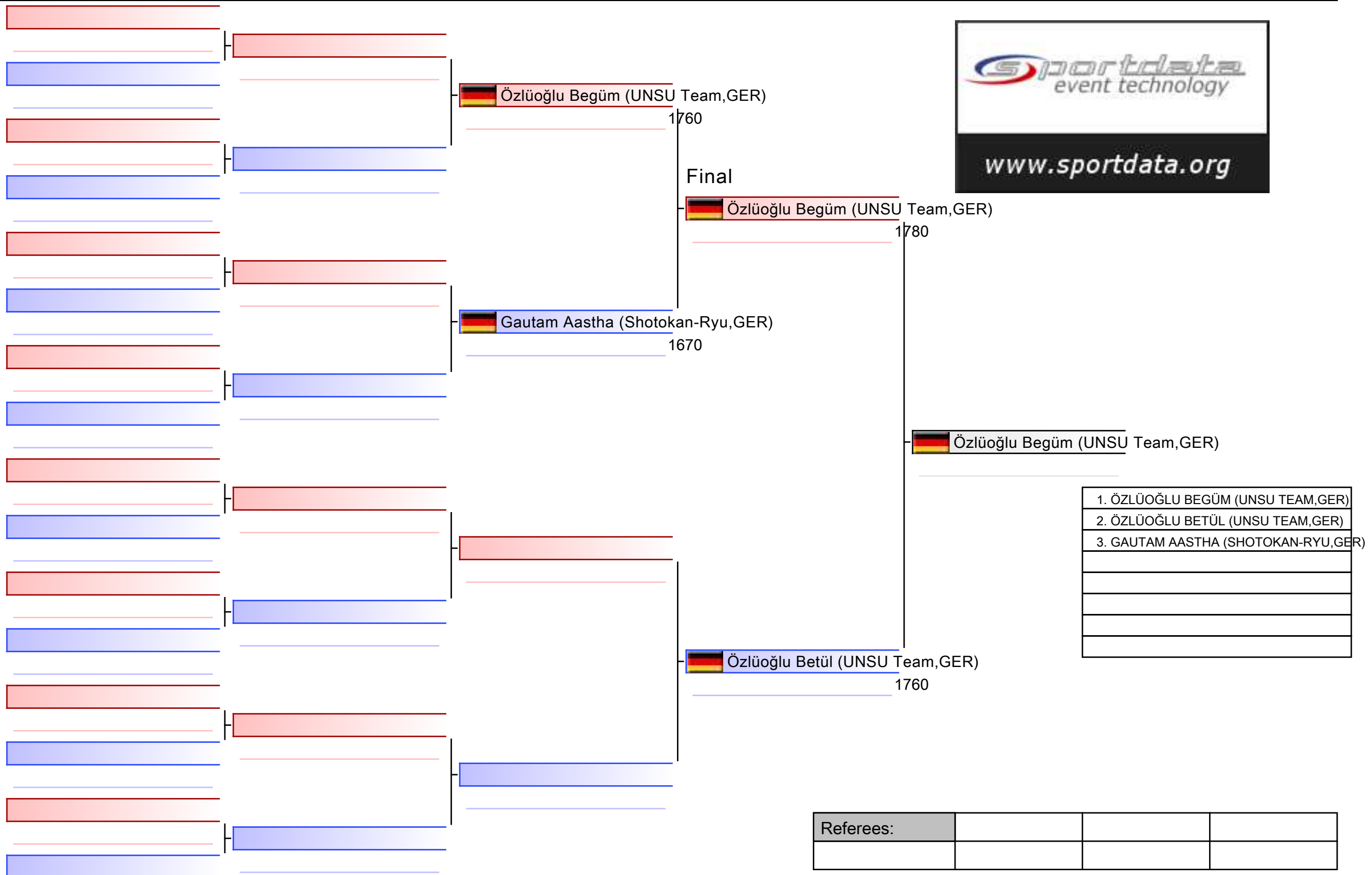

1. ÖZLÜOĞLU BEGÜM (UNSU TEAM,GER)
2. ÖZLÜOĞLU BETÜL (UNSU TEAM,GER)
3. GAUTAM AASTHA (SHOTOKAN-RYU,GER)

Referees:			

Newcomer Kata Kinder A 9.-8.Kyu weiblich

OFFENE UNTERFRÄNKISCHE KARATE BEZIRKSMEISTERSCHAFT & NEWCOMER KARATE TURNIER 2024

Tatami

Pool

1

(c)sportdata GmbH & Co KG 2000-2024 (2024-10-12 18:43) v 10.2.0 build 1 (2024-09-26 10:14 CET) License: Online_Event_ID-8506_OFFENEUNTERFRNKISCHEKARATEBEZIRKSMEISTERSCHAFTNEWCOMERKARATETURNIER2024

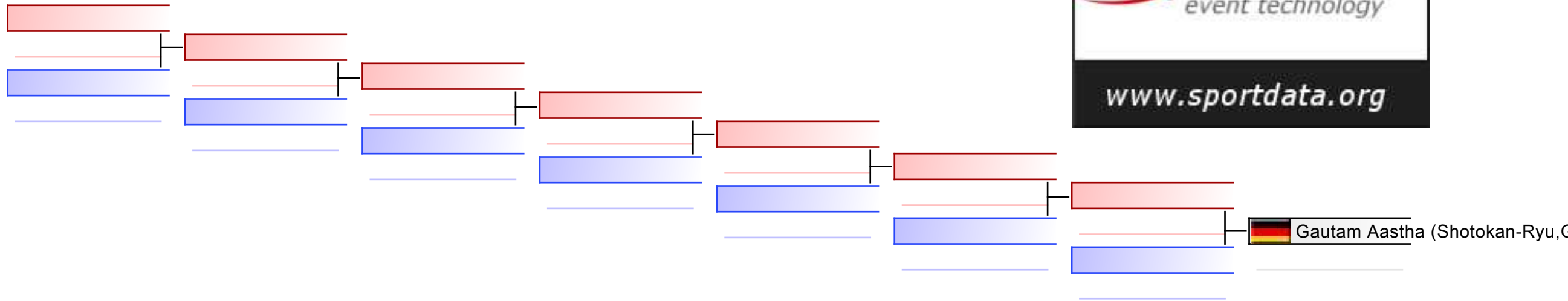

REPECHAGE: (1)

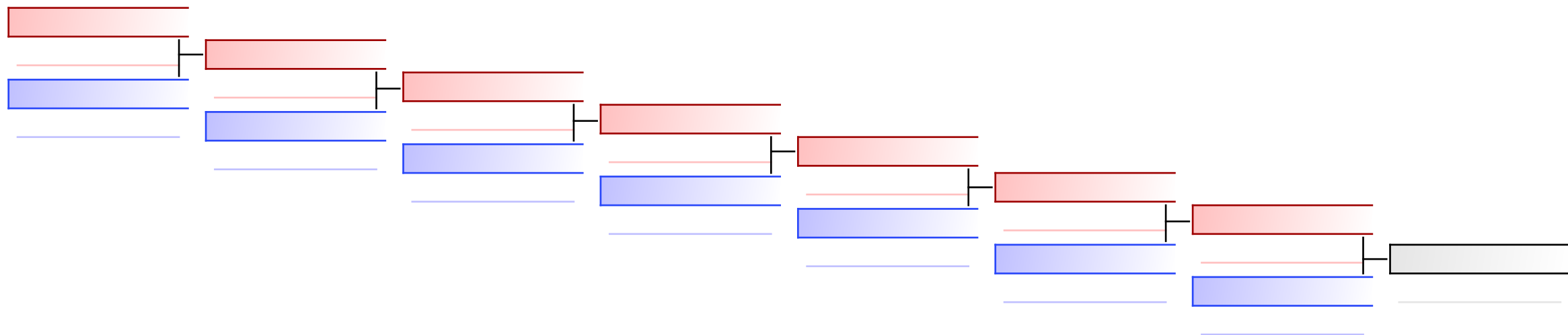

Referees:							
-----------	--	--	--	--	--	--	--

Newcomer Kata Kinder B 9.-8.Kyu männlich

OFFENE UNTERFRÄNKISCHE KARATE BEZIRKSMEISTERSCHAFT & NEWCOMER KARATE TURNIER 2024, Hermasweg 1 97506 Grafenheinfeld, GER

2024-10-12

Tatami

1 09:50

Pool

1/1

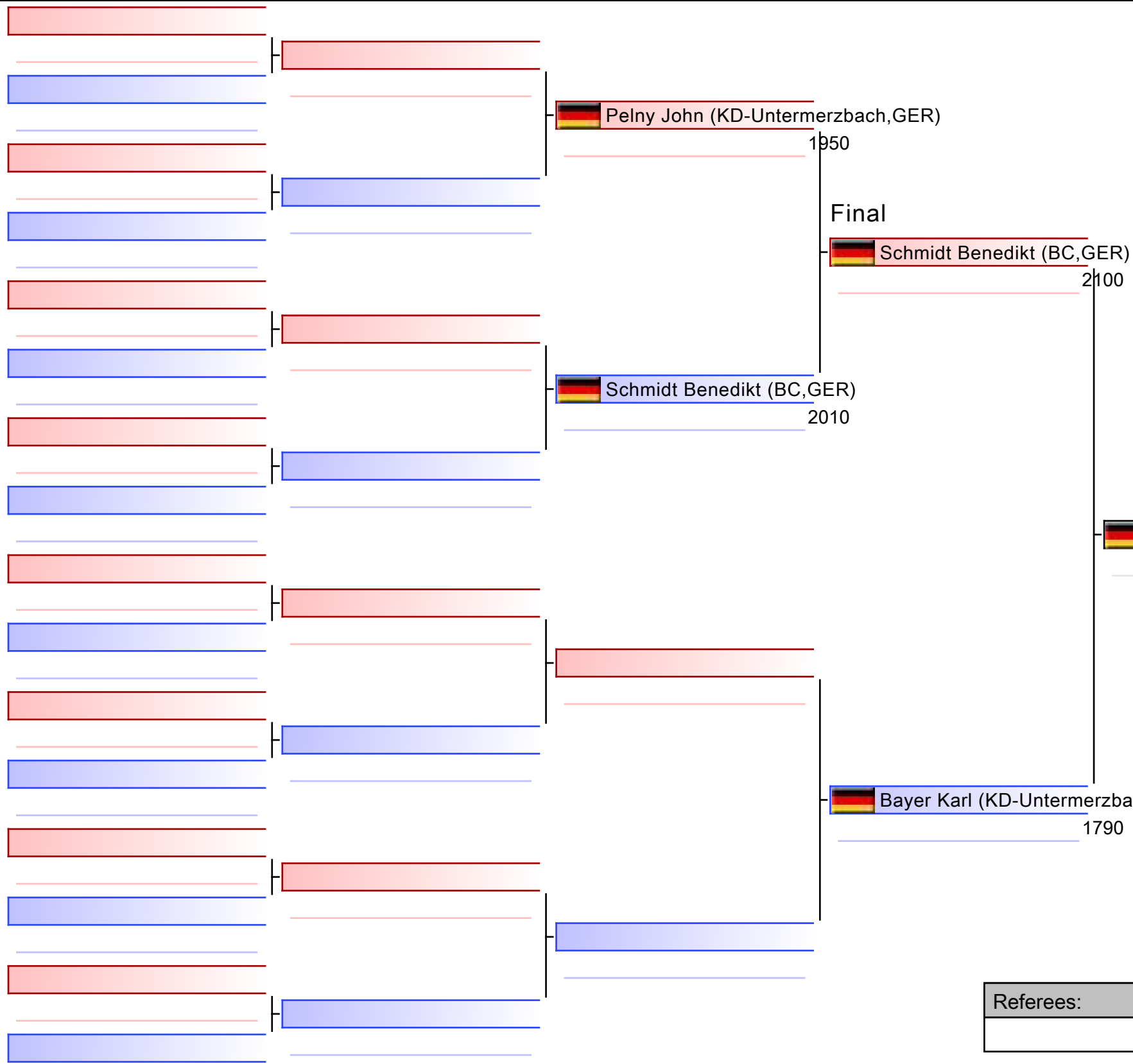

1. SCHMIDT BENEDIKT (BC,GER)
2. BAYER KARL (KD-UNTERMERZBACH,GER)
3. PELNY JOHN (KD-UNTERMERZBACH,GER)

Referees:			

Newcomer Kata Kinder B 9.-8.Kyu männlich

OFFENE UNTERFRÄNKISCHE KARATE BEZIRKSMEISTERSCHAFT & NEWCOMER KARATE TURNIER 2024

Tatami

Pool

1

(c)sportdata GmbH & Co KG 2000-2024 (2024-10-12 18:43) v 10.2.0 build 1 (2024-09-26 10:14 CET) License: Online_Event_ID-8506_OFFENEUNTERFRNKISCHEKARATEBEZIRKSMEISTERSCHAFTNEWCOMERKARATETURNIER2024

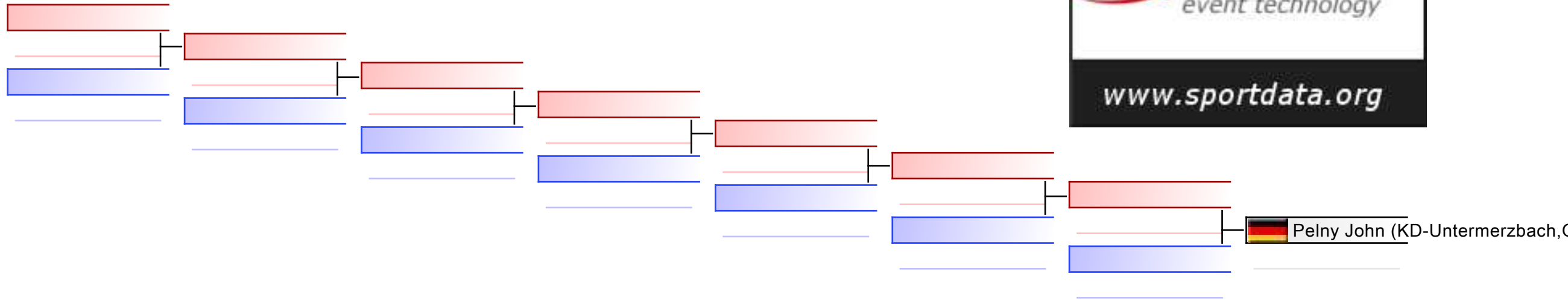

REPECHAGE: (1)

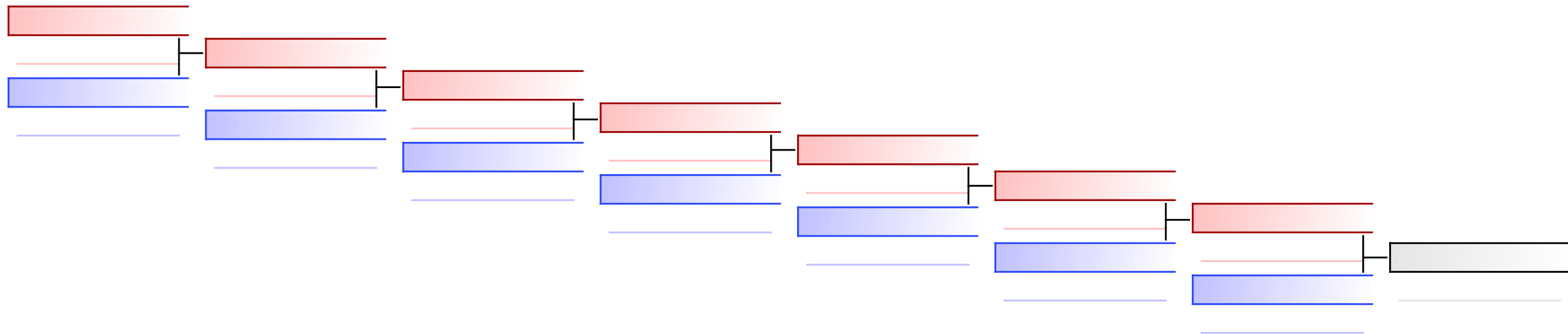

Referees:							
-----------	--	--	--	--	--	--	--

Newcomer Kata Kinder B 9.-8.Kyu weiblich

OFFENE UNTERFRÄNKISCHE KARATE BEZIRKSMEISTERSCHAFT & NEWCOMER KARATE TURNIER 2024, Hermasweg 1 97506 Grafenrheinfeld, GER

2024-10-12

Tatami
1 09:30

Pool
1/1

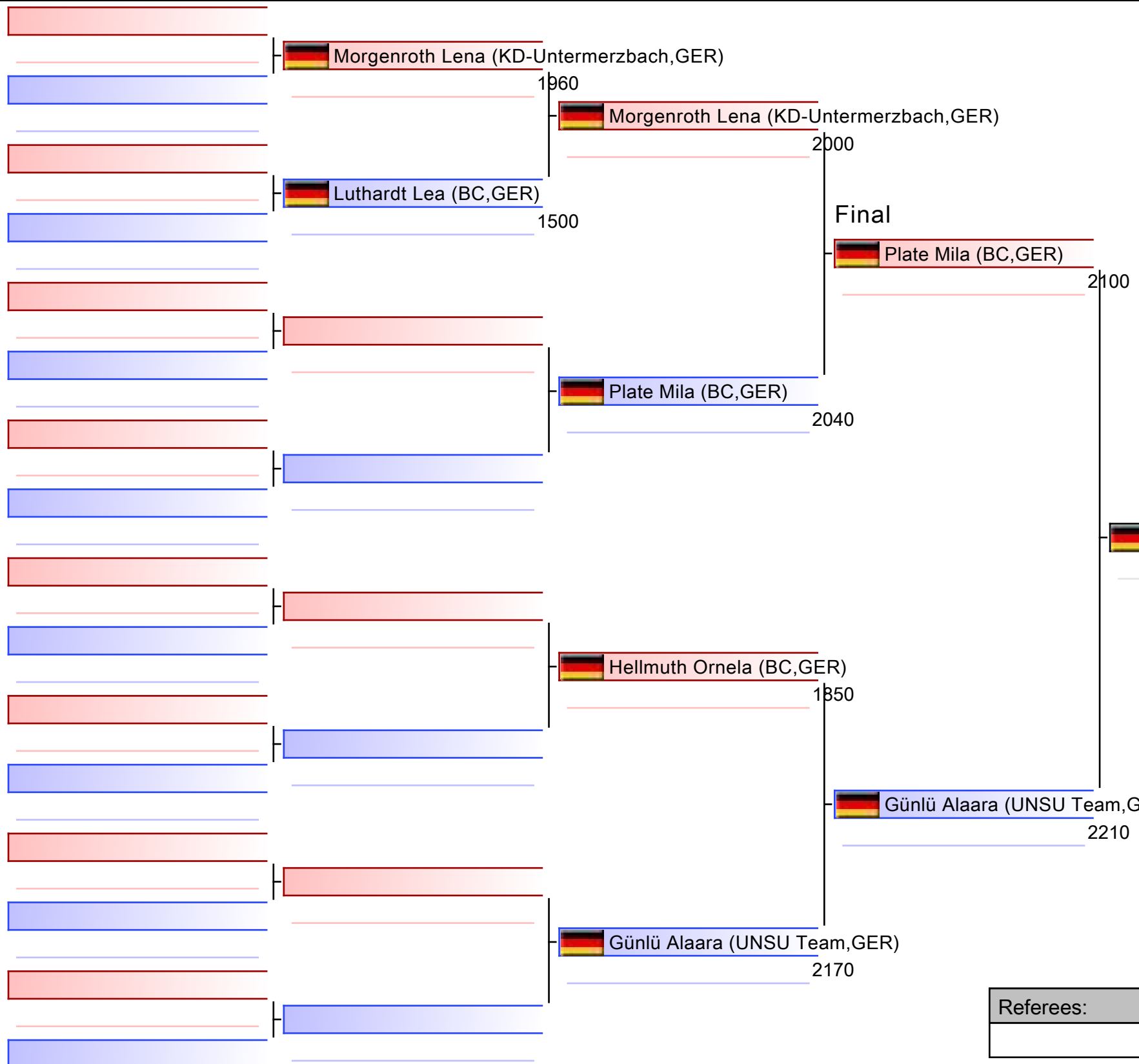

1. GÜNLÜ ALAARA (UNSU TEAM,GER)
2. PLATE MILA (BC,GER)
3. MORGENROTH LENA (KD-UNTERMERZBACH,GER)
3. HELLMUTH ORNELA (BC,GER)

Referees:			

Newcomer Kata Kinder B 9.-8.Kyu weiblich

OFFENE UNTERFRÄNKISCHE KARATE BEZIRKSMEISTERSCHAFT & NEWCOMER KARATE TURNIER 2024

2024-10-12

Tatami

1 09:40

Pool

1

(c)sportdata GmbH & Co KG 2000-2024 (2024-10-12 18:43) v 10.2.0 build 1 (2024-09-26 10:14 CET) License: Online_Event_ID-8506_OFFENEUNTERFRNKISCHEKARATEBEZIRKSMEISTERSCHAFTNEWCOMERKARATETURNIER2024

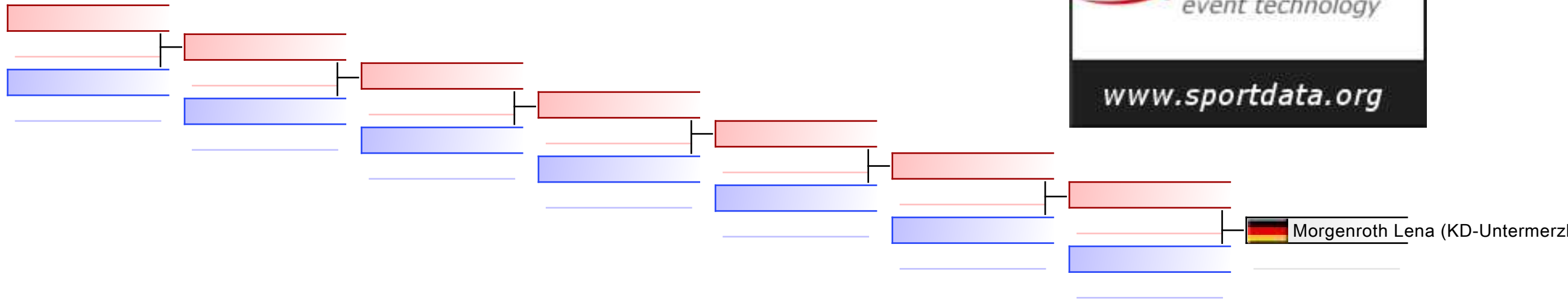

REPECHAGE: (1)

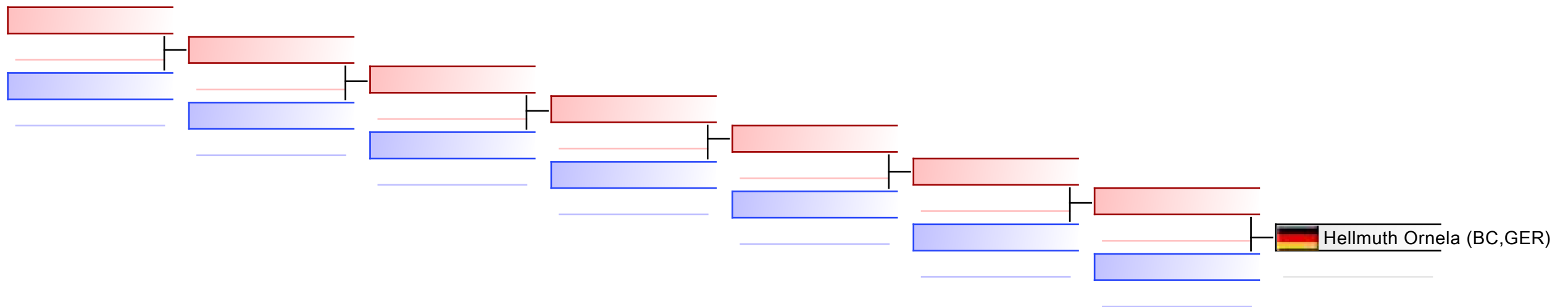

Referees:							
-----------	--	--	--	--	--	--	--

Newcomer Kata Schüler A 7.-6. Kyu mixed

OFFENE UNTERFRÄNKISCHE KARATE BEZIRKSMEISTERSCHAFT & NEWCOMER KARATE TURNIER 2024, Hermasweg 1 97506 Grafenrheinfeld, GER

2024-10-12

Tatami
1 10:20

Pool
1/1

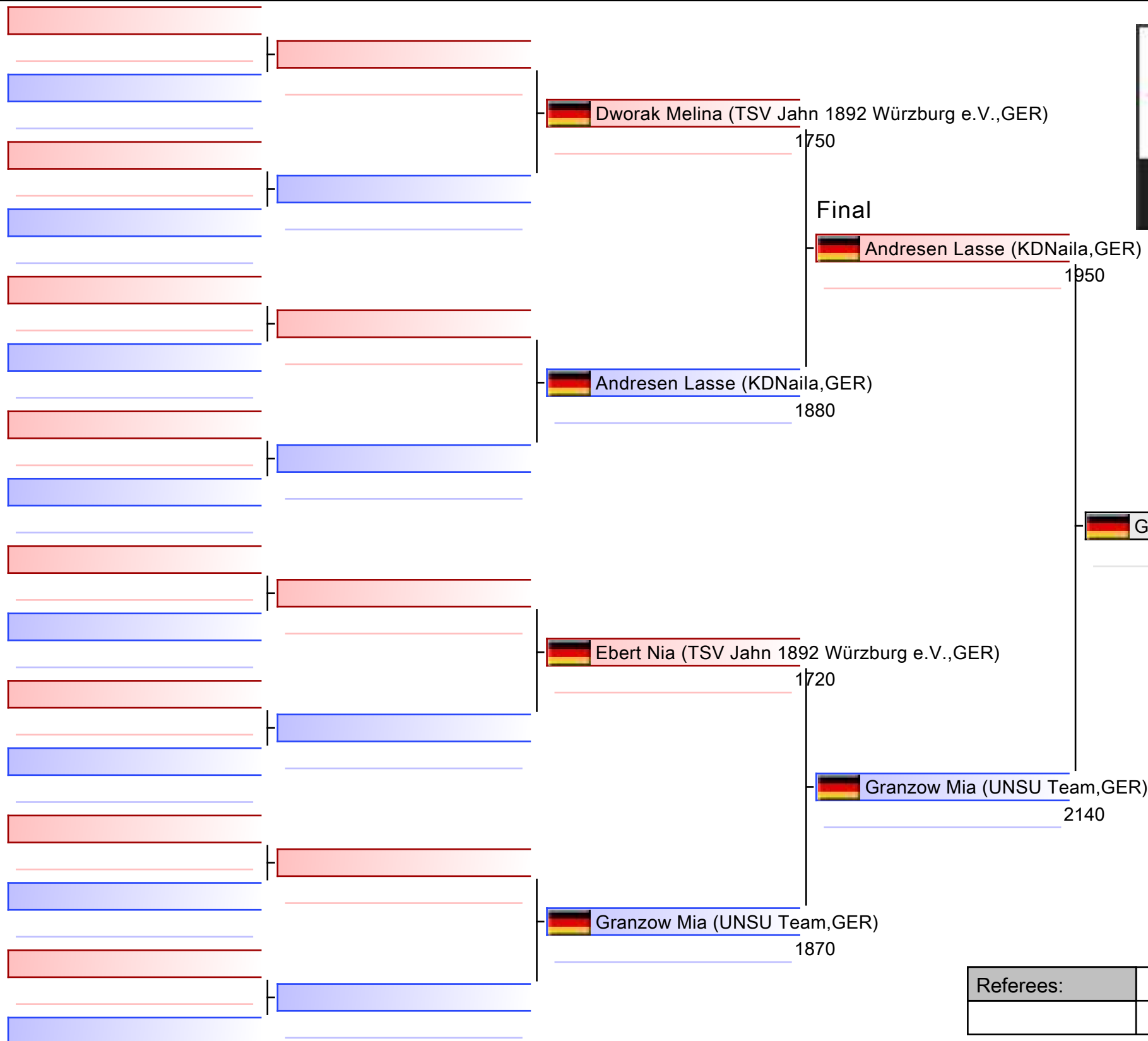

1. GRANZOW MIA (UNSU TEAM, GER)
2. ANDRESEN LASSE (KDNAILA, GER)
3. DWORAK MELINA (TSV JAHN 1892 WÜRZBURG E.V., GER)
3. EBERT NIA (TSV JAHN 1892 WÜRZBURG E.V., GER)

Referees:			

Newcomer Kata Schüler A 7.-6. Kyu mixed

OFFENE UNTERFRÄNKISCHE KARATE BEZIRKSMEISTERSCHAFT & NEWCOMER KARATE TURNIER 2024

Tatami

Pool

1

(c)sportdata GmbH & Co KG 2000-2024 (2024-10-12 18:43) v 10.2.0 build 1 (2024-09-26 10:14 CET) License: Online_Event_ID-8506_OFFENEUNTERFRNKISCHEKARATEBEZIRKSMEISTERSCHAFTNEWCOMERKARATETURNIER2024

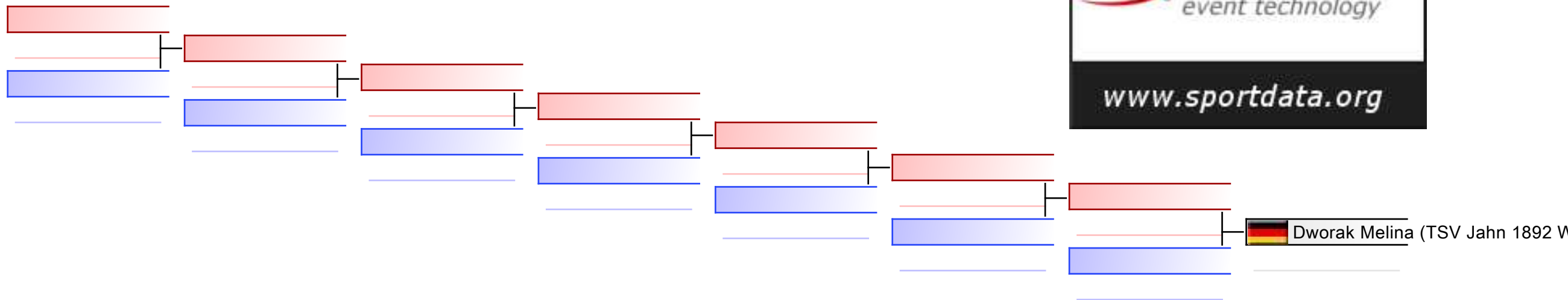

REPECHAGE: (1)

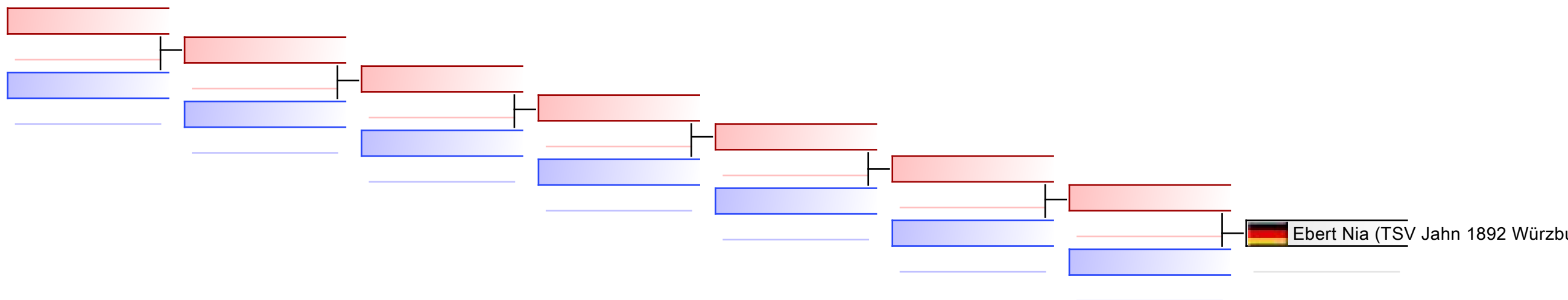

Referees:							
-----------	--	--	--	--	--	--	--

Newcomer Kata Schüler A 9.-8. Kyu mixed

OFFENE UNTERFRÄNKISCHE KARATE BEZIRKSMEISTERSCHAFT & NEWCOMER KARATE TURNIER 2024, Hermasweg 1 97506 Grafenrheinfeld, GER

2024-10-12

Tatami
1 10:10

Pool
1/1

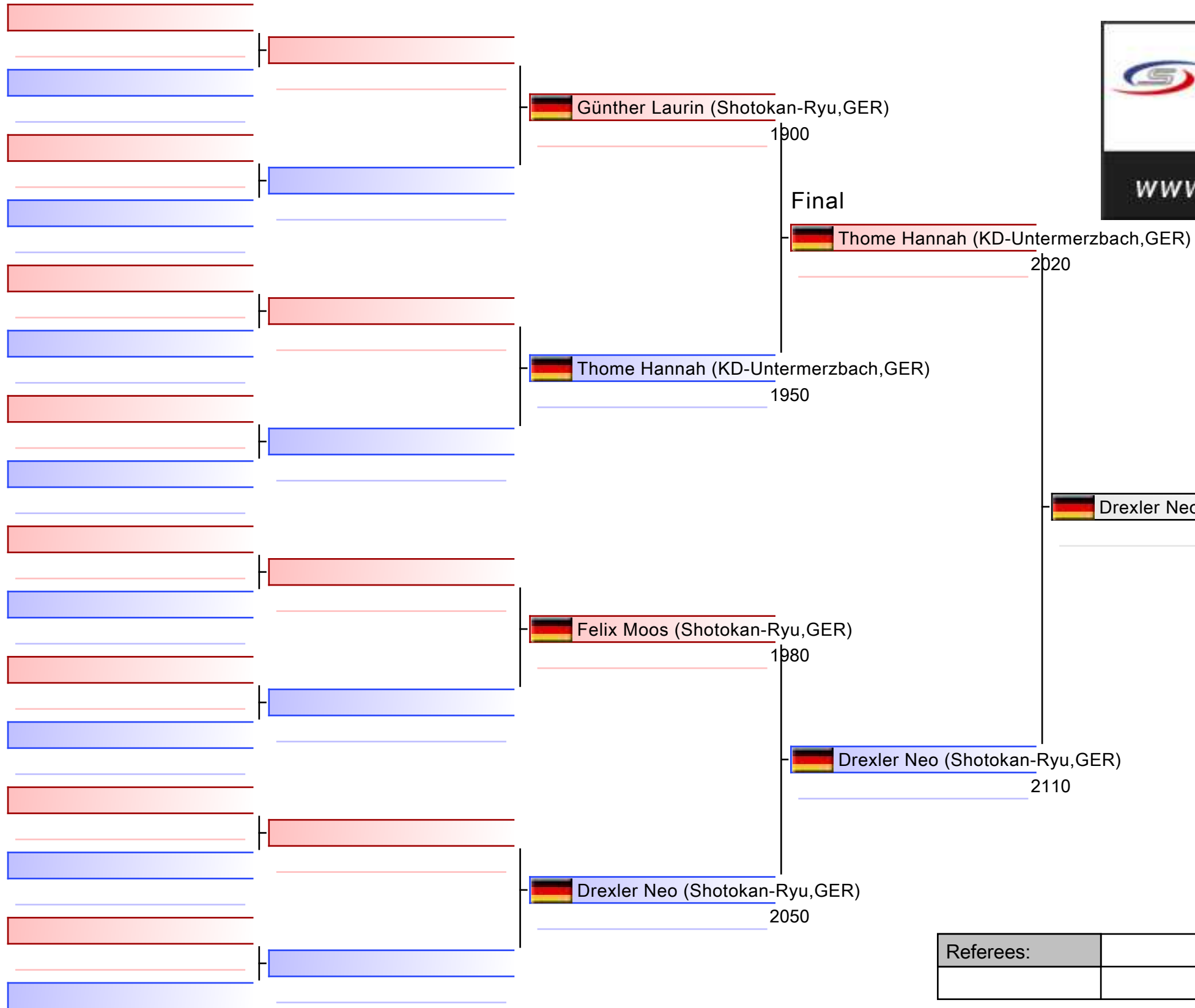

1. DREXLER NEO (SHOTOKAN-RYU,GER)
2. THOME HANNAH (KD-UNTERMERZBACH,GER)
3. GÜNTHER LAURIN (SHOTOKAN-RYU,GER)
3. FELIX MOOS (SHOTOKAN-RYU,GER)

Referees:			

Newcomer Kata Schüler A 9.-8. Kyu mixed

OFFENE UNTERFRÄNKISCHE KARATE BEZIRKSMEISTERSCHAFT & NEWCOMER KARATE TURNIER 2024

Tatami

Pool

1

(c)sportdata GmbH & Co KG 2000-2024 (2024-10-12 18:43) v 10.2.0 build 1 (2024-09-26 10:14 CET) License: Online_Event_ID-8506_OFFENEUNTERFRNKISCHEKARATEBEZIRKSMEISTERSCHAFTNEWCOMERKARATETURNIER2024

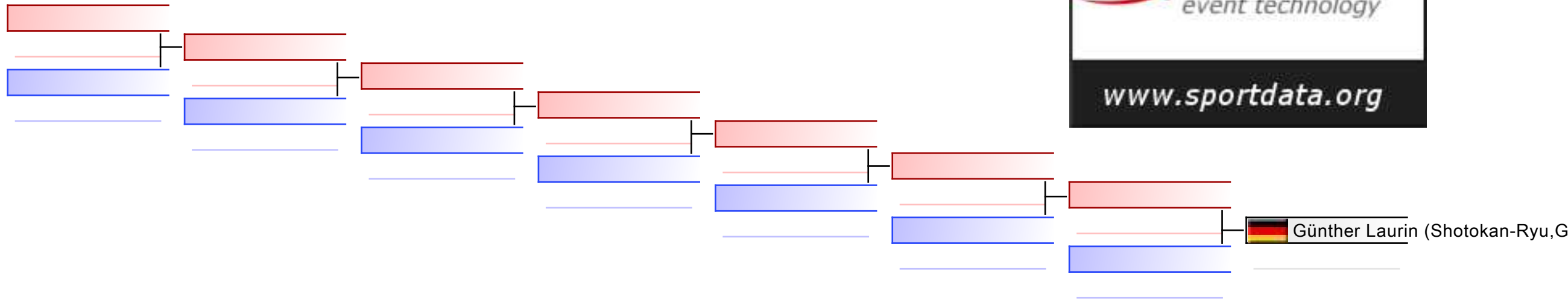

REPECHAGE: (1)

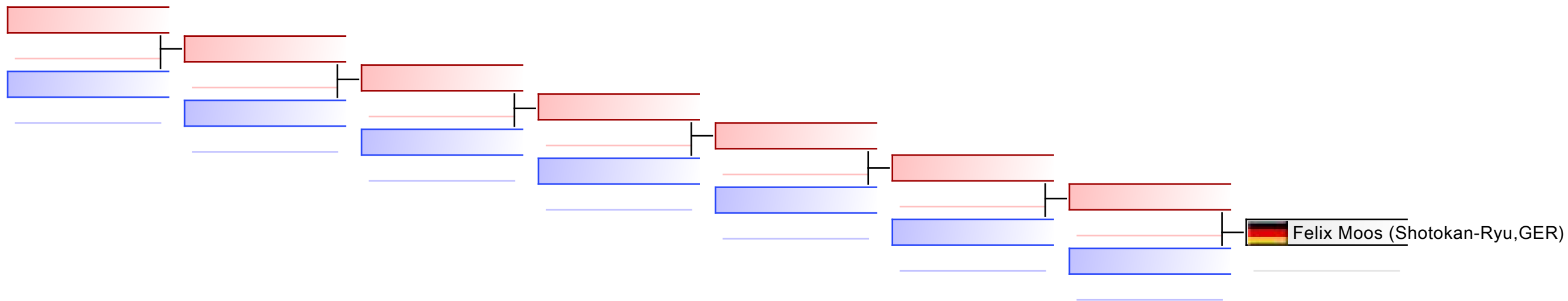

Referees:							
-----------	--	--	--	--	--	--	--

Newcomer Kata Schüler B 7.-6. Kyu mixed

OFFENE UNTERFRÄNKISCHE KARATE BEZIRKSMEISTERSCHAFT & NEWCOMER KARATE TURNIER 2024, Hermasweg 1 97506 Grafenrheinfeld, GER

2024-10-12

Tatami
2 10:10

Pool
1/1

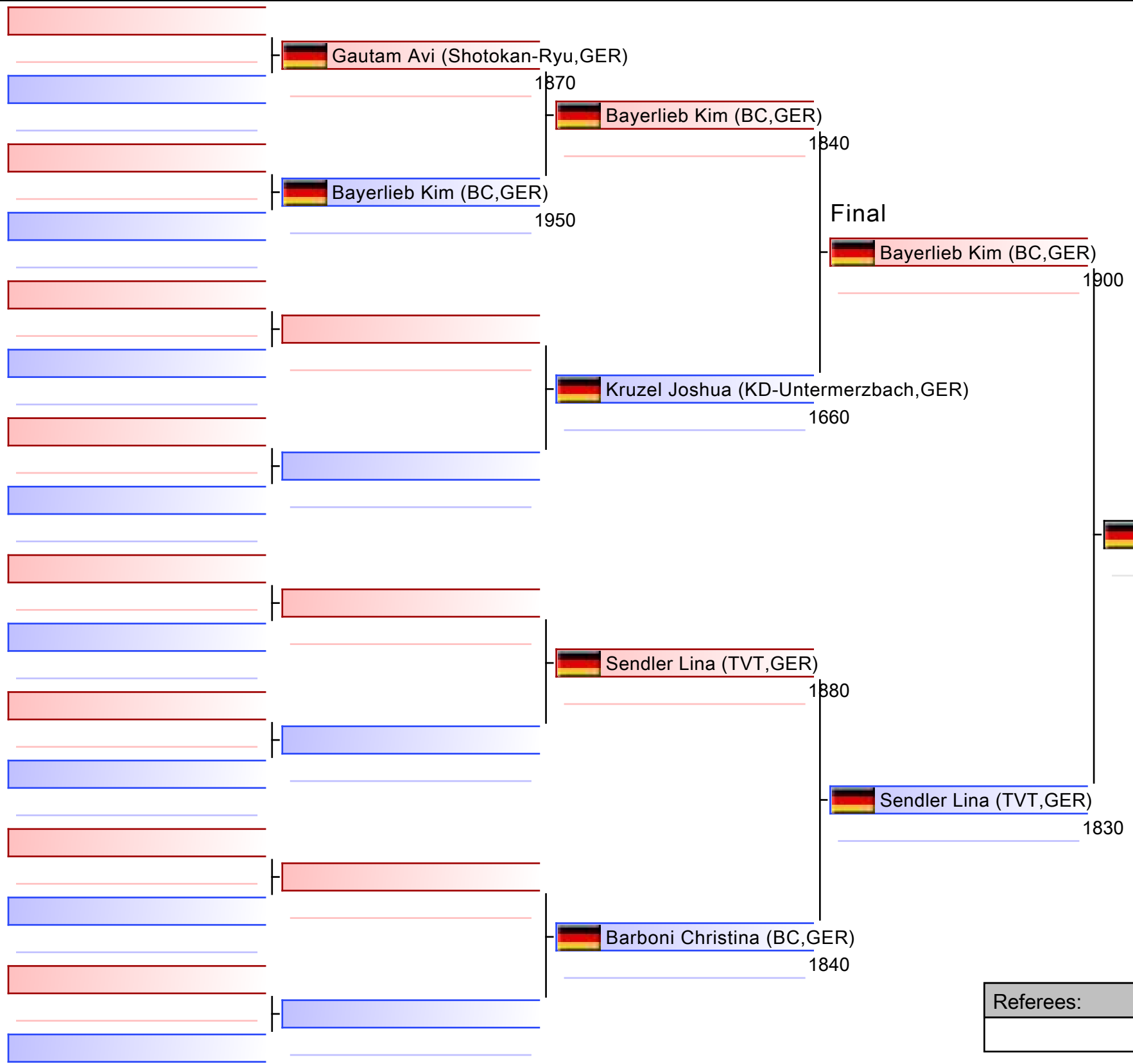

1. BAYERLIEB KIM (BC,GER)
2. SENDLER LINA (TVT,GER)
3. BARBONI CHRISTINA (BC,GER)
3. GAUTAM AVI (SHOTOKAN-RYU,GER)
5. KRUZEL JOSHUA (KD-UNTERMERZBACH,GER)

Referees:			

Newcomer Kata Schüler B 7.-6. Kyu mixed

OFFENE UNTERFRÄNKISCHE KARATE BEZIRKSMEISTERSCHAFT & NEWCOMER KARATE TURNIER 2024

2024-10-12

Tatami
2 10:20

Pool
1

(c)sportdata GmbH & Co KG 2000-2024 (2024-10-12 18:43) v 10.2.0 build 1 (2024-09-26 10:14 CET) License: Online_Event_ID-8506_OFFENEUNTERFRNKISCHEKARATEBEZIRKSMEISTERSCHAFTNEWCOMERKARATETURNIER2024

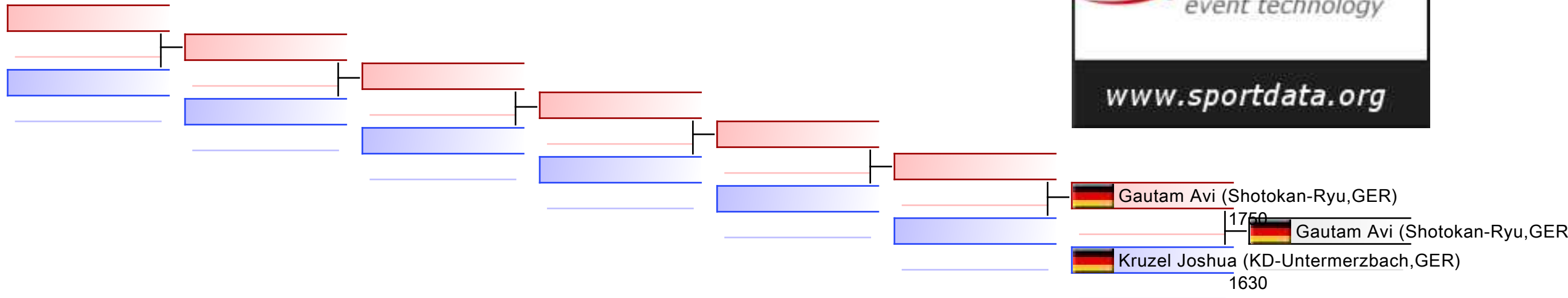

REPECHAGE: (1)

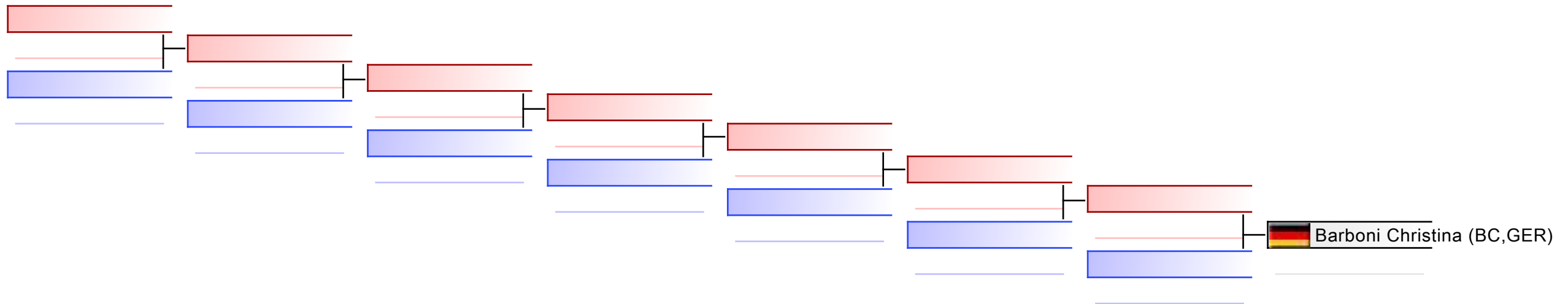

Referees:							
-----------	--	--	--	--	--	--	--

Newcomer Kata Schüler B 9.-8.Kyu männlich

OFFENE UNTERFRÄNKISCHE KARATE BEZIRKSMEISTERSCHAFT & NEWCOMER KARATE TURNIER 2024, Hermasweg 1 97506 Grafenrheinfeld, GER

2024-10-12

Tatami
3 09:55

Pool
1/1

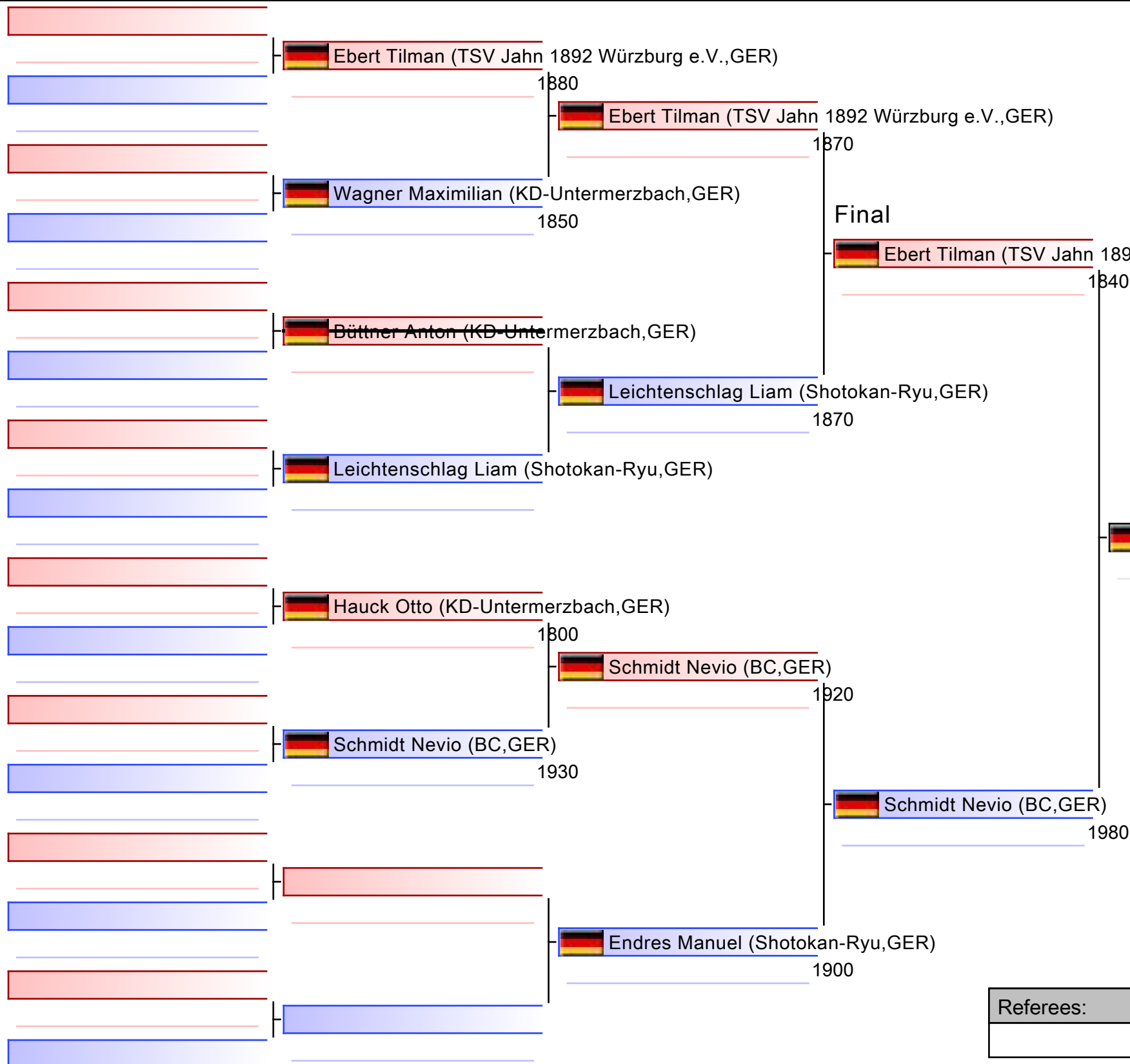

- | |
|---|
| 1. SCHMIDT NEVIO (BC,GER) |
| 2. EBERT TILMAN (TSV JAHN 1892 WÜRZBURG E.V.,GER) |
| 3. LEICHTENSCHLAG LIAM (SHOTOKAN-RYU,GER) |
| 3. ENDRES MANUEL (SHOTOKAN-RYU,GER) |
| 5. WAGNER MAXIMILIAN (KD-UNTERMERZBACH,GER) |
| 5. HAUCK OTTO (KD-UNTERMERZBACH,GER) |
| |
| |

Referees:			

Newcomer Kata Schüler B 9.-8.Kyu männlich

OFFENE UNTERFRÄNKISCHE KARATE BEZIRKSMEISTERSCHAFT & NEWCOMER KARATE TURNIER 2024

2024-10-12

Tatami
3 10:15

Pool
1

(c)sportdata GmbH & Co KG 2000-2024 (2024-10-12 18:43) v 10.2.0 build 1 (2024-09-26 10:14 CET) License: Online_Event_ID-8506_OFFENEUNTERFRNKISCHEKARATEBEZIRKSMEISTERSCHAFTNEWCOMERKARATETURNIER2024

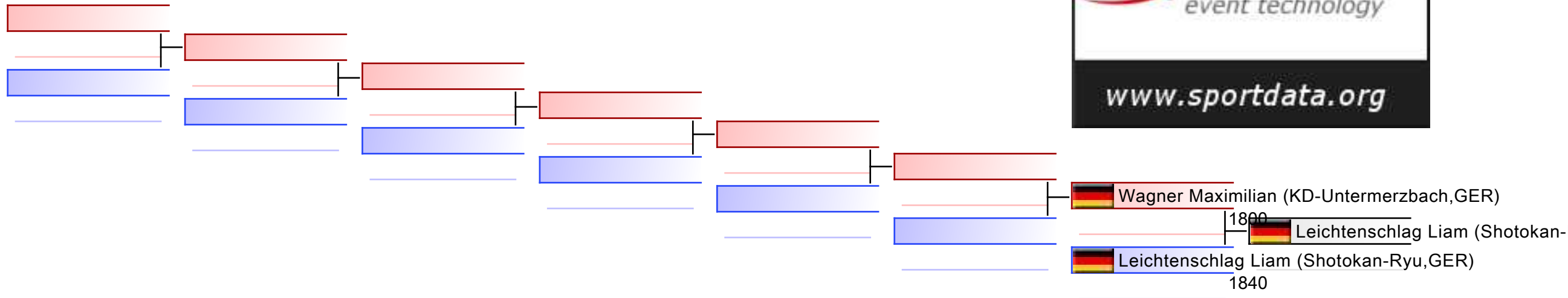

REPECHAGE: (1)

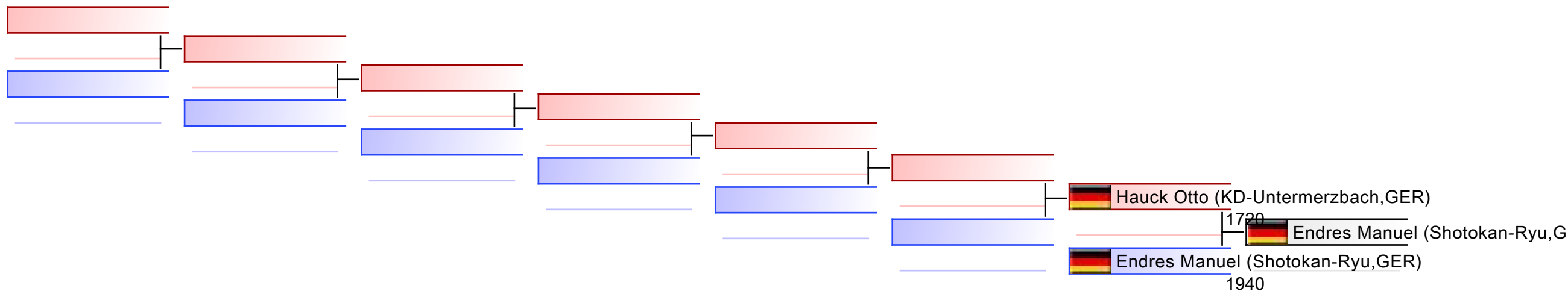

Referees:							
-----------	--	--	--	--	--	--	--

Newcomer Kata Schüler B 9.-8.Kyu weiblich

OFFENE UNTERFRÄNKISCHE KARATE BEZIRKSMEISTERSCHAFT & NEWCOMER KARATE TURNIER 2024, Hermasweg 1 97506 Grafenrheinfeld, GER

2024-10-12

Tatami
1 10:00

Pool
1/1

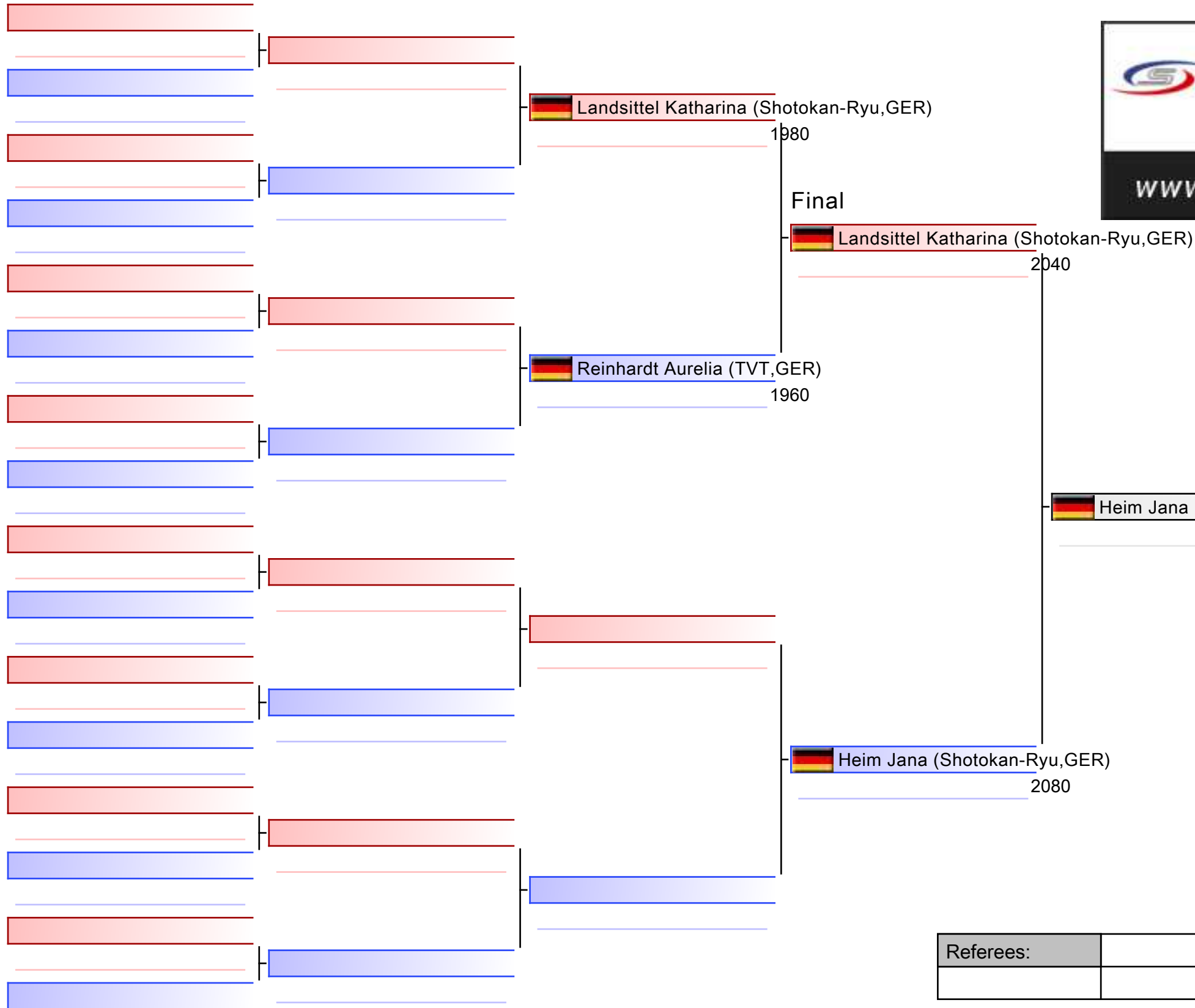

1. HEIM JANA (SHOTOKAN-RYU,GER)
2. LANDSITTEL KATHARINA (SHOTOKAN-RYU,GER)
3. REINHARDT AURELIA (TVT,GER)

Referees:			

Newcomer Kata Schüler B 9.-8.Kyu weiblich

OFFENE UNTERFRÄNKISCHE KARATE BEZIRKSMEISTERSCHAFT & NEWCOMER KARATE TURNIER 2024

Tatami

Pool

1

(c)sportdata GmbH & Co KG 2000-2024 (2024-10-12 18:43) v 10.2.0 build 1 (2024-09-26 10:14 CET) License: Online_Event_ID-8506_OFFENEUNTERFRNKISCHEKARATEBEZIRKSMEISTERSCHAFTNEWCOMERKARATETURNIER2024

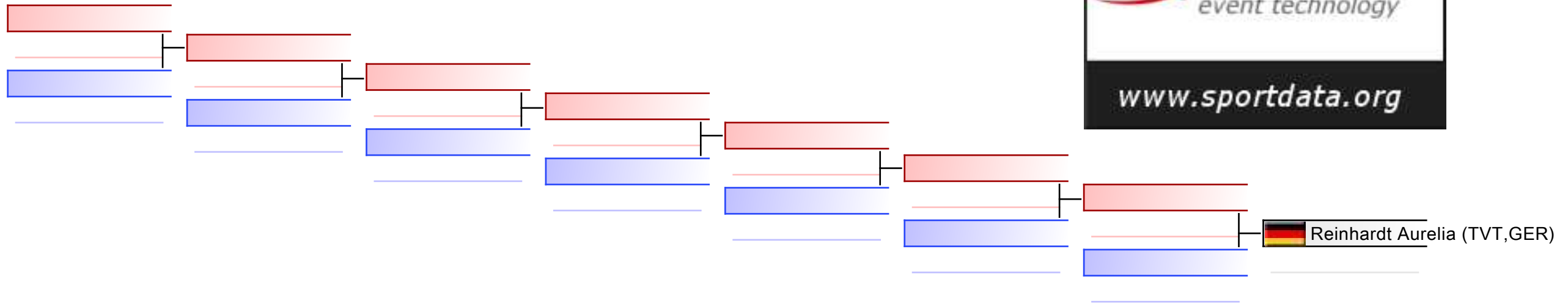

REPECHAGE: (1)

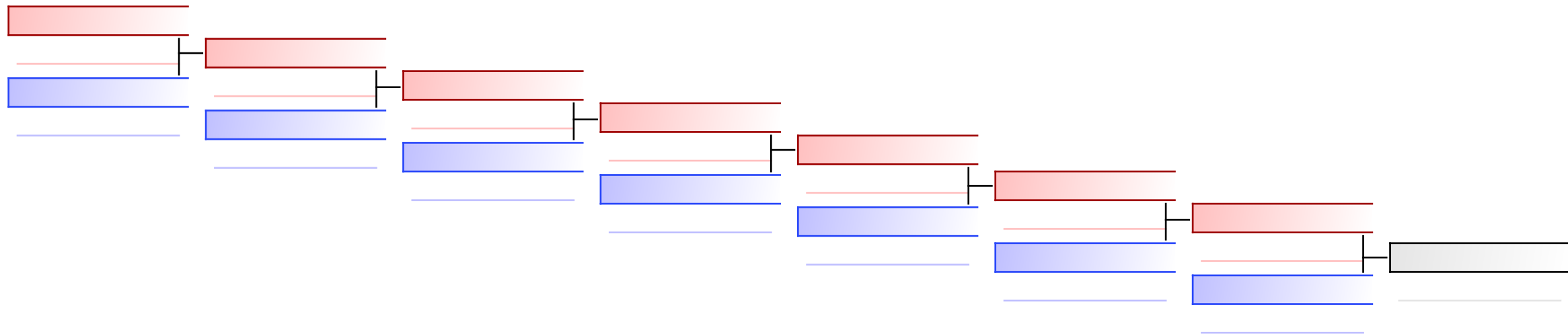

Referees:							
-----------	--	--	--	--	--	--	--

Newcomer Kumite Kinder A weiblich

OFFENE UNTERFRÄNKISCHE KARATE BEZIRKSMEISTERSCHAFT & NEWCOMER KARATE TURNIER 2024, Hermasweg 1 97506 Grafenrheinfeld, GER

2024-10-12

Tatami

2 10:30

Pool

1/1

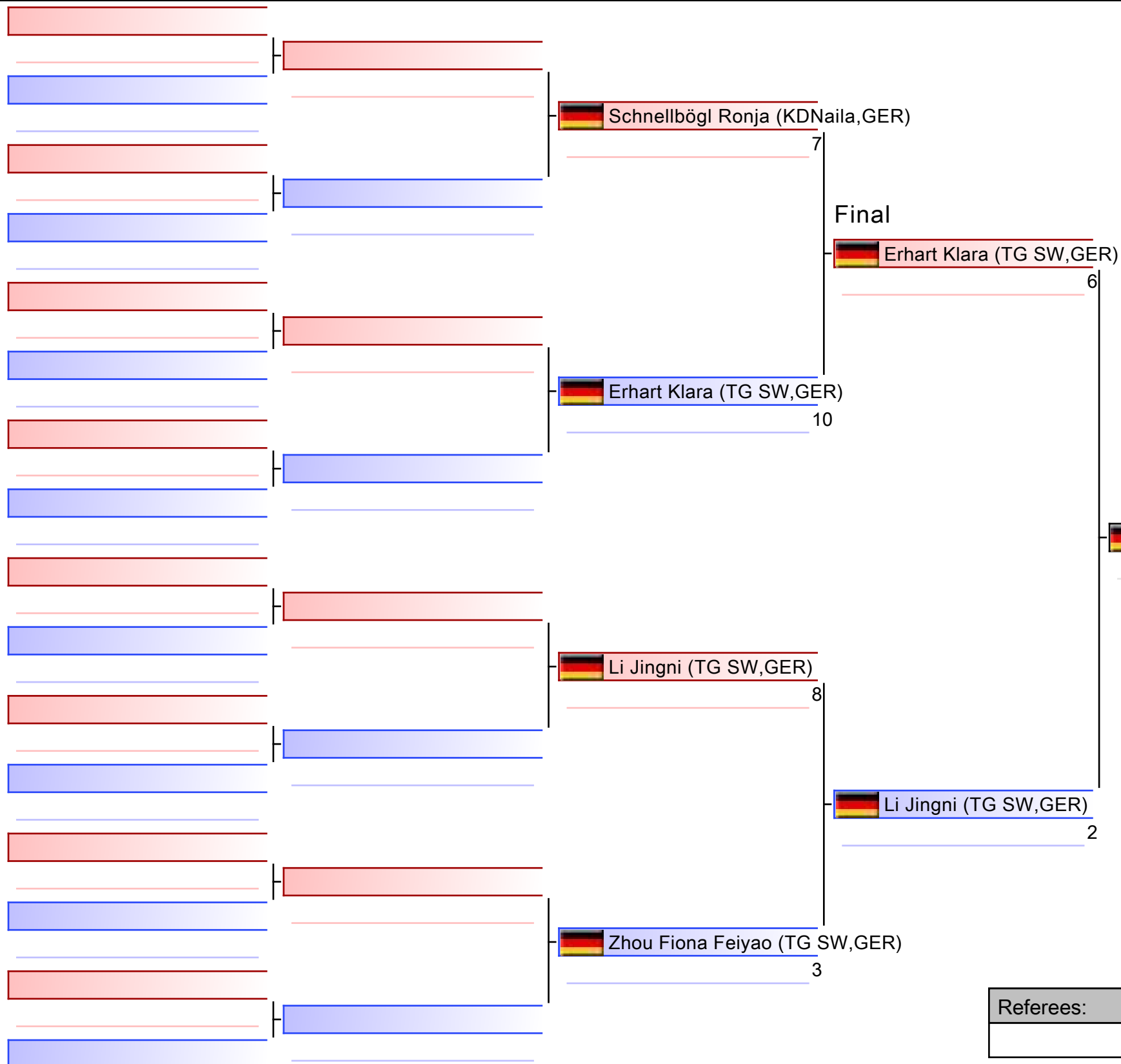

1. ERHART KLARA (TG SW,GER)
2. LI JINGNI (TG SW,GER)
3. SCHNELLBÖGL RONJA (KDNAILA,GER)
3. ZHOU FIONA FEIYAO (TG SW,GER)

Referees:			

Newcomer Kumite Kinder A weiblich

OFFENE UNTERFRÄNKISCHE KARATE BEZIRKSMEISTERSCHAFT & NEWCOMER KARATE TURNIER 2024

Tatami

Pool

1

(c)sportdata GmbH & Co KG 2000-2024 (2024-10-12 18:43) v 10.2.0 build 1 (2024-09-26 10:14 CET) License: Online_Event_ID-8506_OFFENEUNTERFRNKISCHEKARATEBEZIRKSMEISTERSCHAFTNEWCOMERKARATETURNIER2024

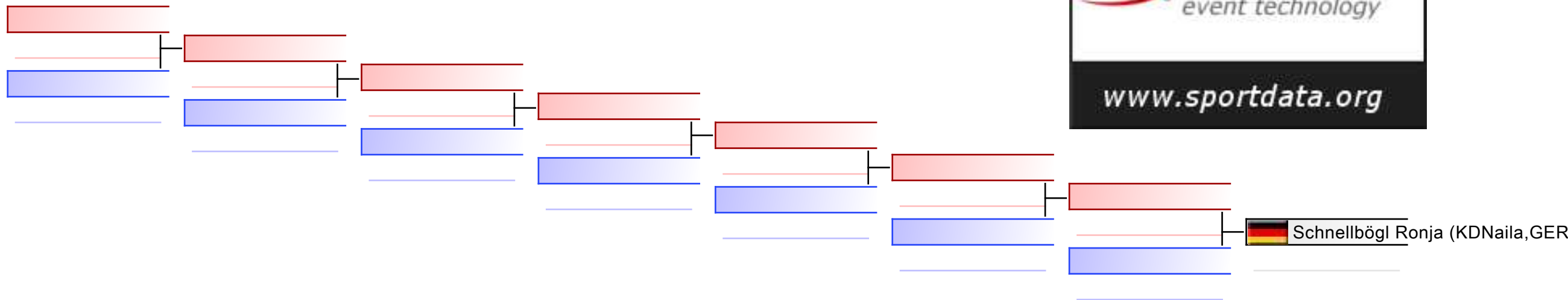

REPECHAGE: (1)

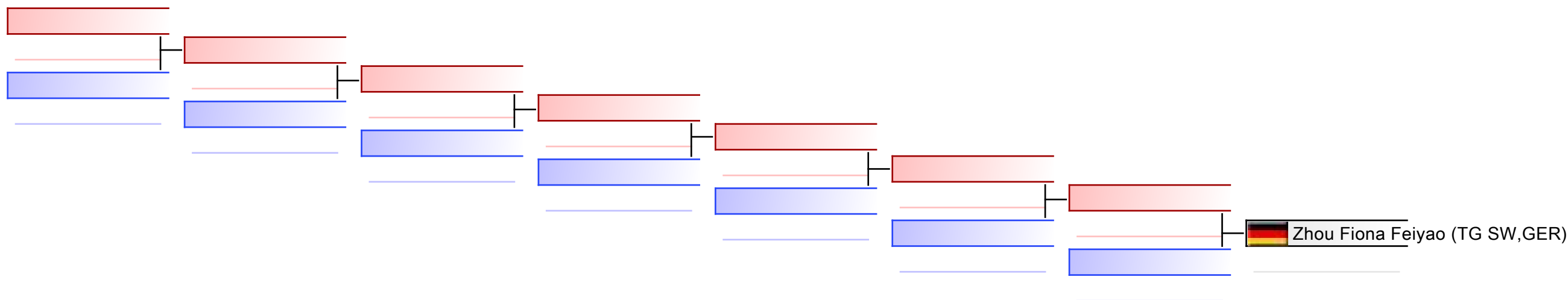

Referees:							
-----------	--	--	--	--	--	--	--

Newcomer Kumite Kinder A -30 kg männlich

OFFENE UNTERFRÄNKISCHE KARATE BEZIRKSMEISTERSCHAFT & NEWCOMER KARATE TURNIER 2024, Hermasweg 1 97506 Grafenheinfeld, GER

2024-10-12

Tatami

3 10:30

Pool

1/1

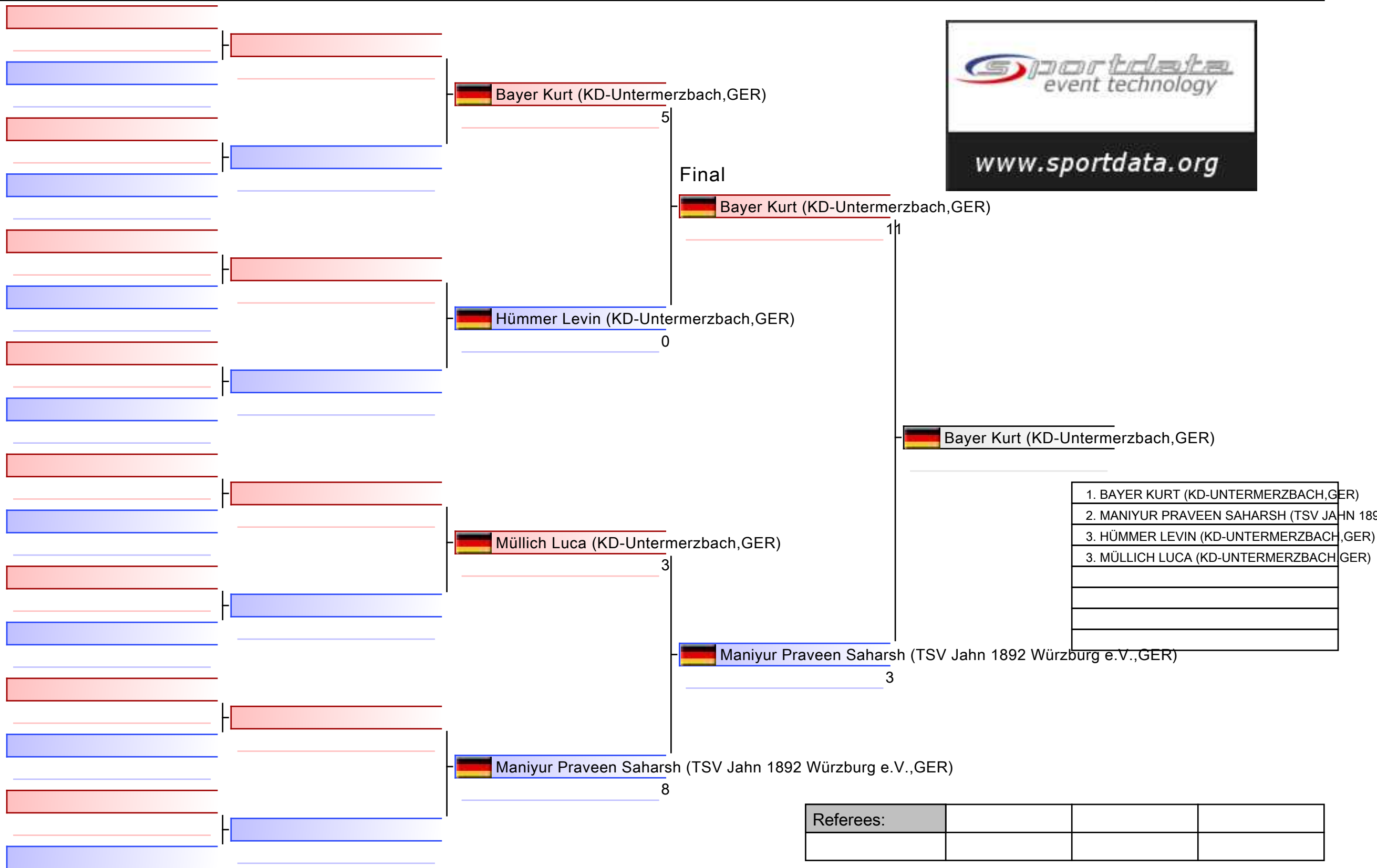

Newcomer Kumite Kinder A -30 kg männlich

OFFENE UNTERFRÄNKISCHE KARATE BEZIRKSMEISTERSCHAFT & NEWCOMER KARATE TURNIER 2024

Tatami

Pool

1

(c)sportdata GmbH & Co KG 2000-2024 (2024-10-12 18:43) v 10.2.0 build 1 (2024-09-26 10:14 CET) License: Online_Event_ID-8506_OFFENEUNTERFRNKISCHEKARATEBEZIRKSMEISTERSCHAFTNEWCOMERKARATETURNIER2024

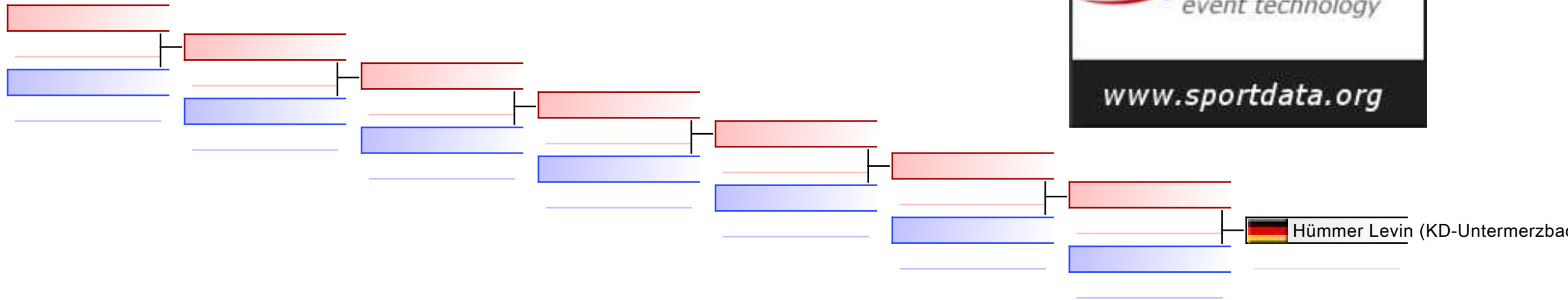

REPECHAGE: (1)

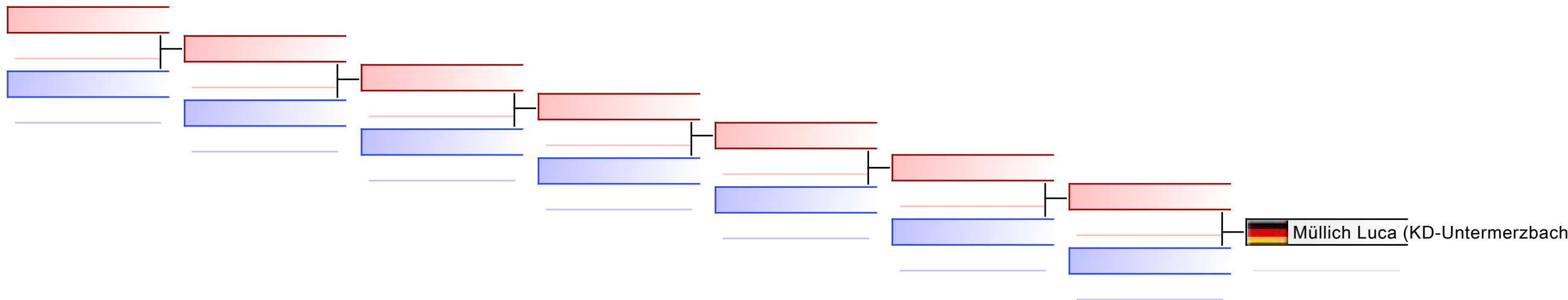

Referees:							
-----------	--	--	--	--	--	--	--

Newcomer Kumite Kinder A -35 kg männlich

OFFENE UNTERFRÄNKISCHE KARATE BEZIRKSMEISTERSCHAFT & NEWCOMER KARATE TURNIER 2024, Hermasweg 1 97506 Grafenheinfeld, GER

2024-10-12

Tatami

3 10:45

Pool

1/1

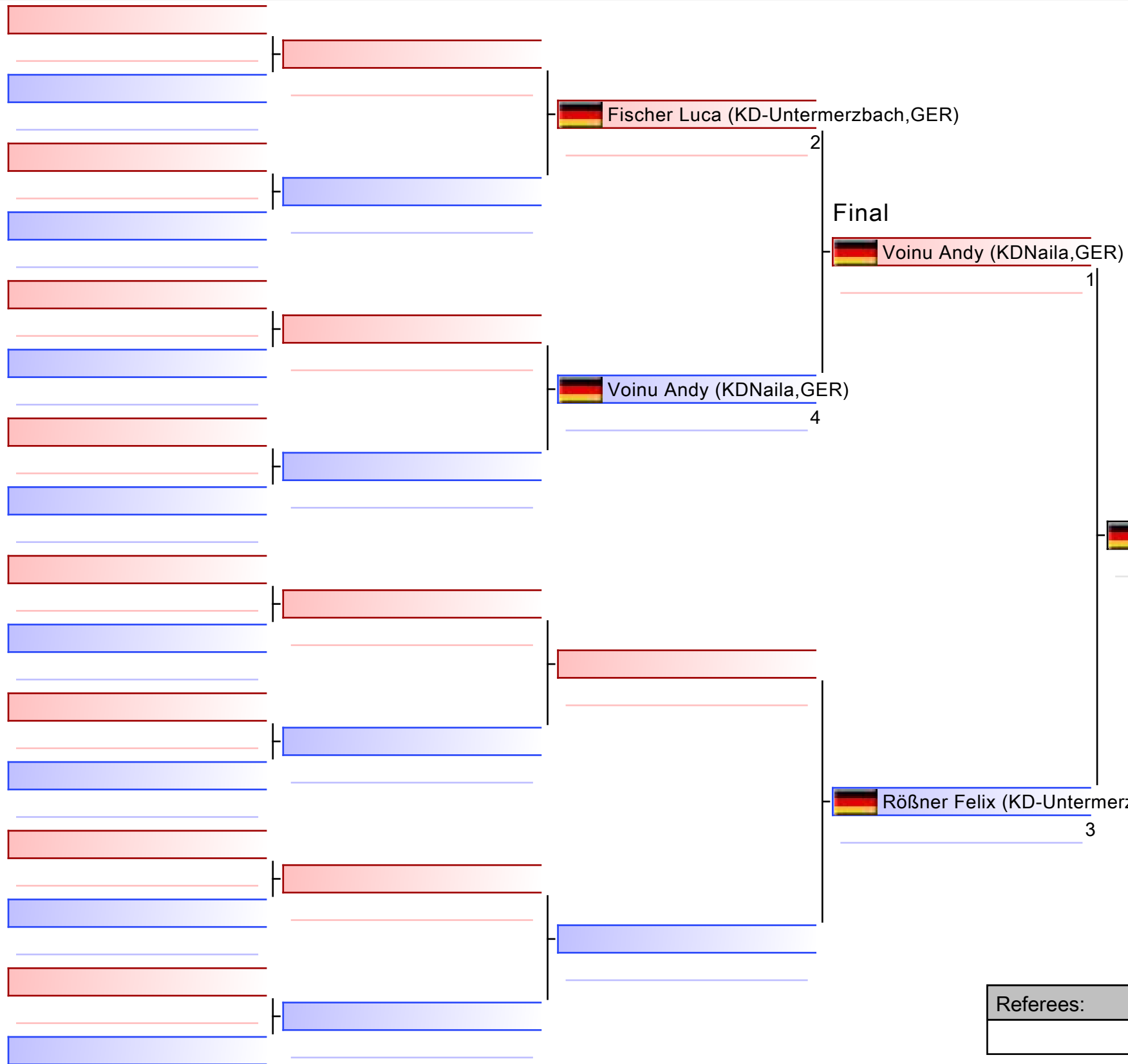

1. RÖSSNER FELIX (KD-UNTERMERZBACH,GER)
2. VOINU ANDY (KDNAILA,GER)
3. FISCHER LUCA (KD-UNTERMERZBACH,GER)

Referees:			

Newcomer Kumite Kinder A -35 kg männlich

OFFENE UNTERFRÄNKISCHE KARATE BEZIRKSMEISTERSCHAFT & NEWCOMER KARATE TURNIER 2024

Tatami

Pool

1

(c)sportdata GmbH & Co KG 2000-2024 (2024-10-12 18:43) v 10.2.0 build 1 (2024-09-26 10:14 CET) License: Online_Event_ID-8506_OFFENEUNTERFRNKISCHEKARATEBEZIRKSMEISTERSCHAFTNEWCOMERKARATETURNIER2024

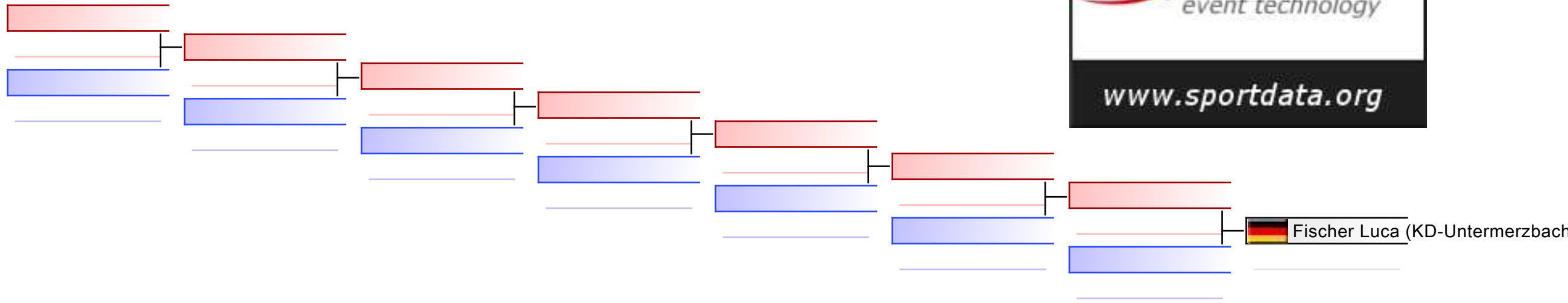

REPECHAGE: (1)

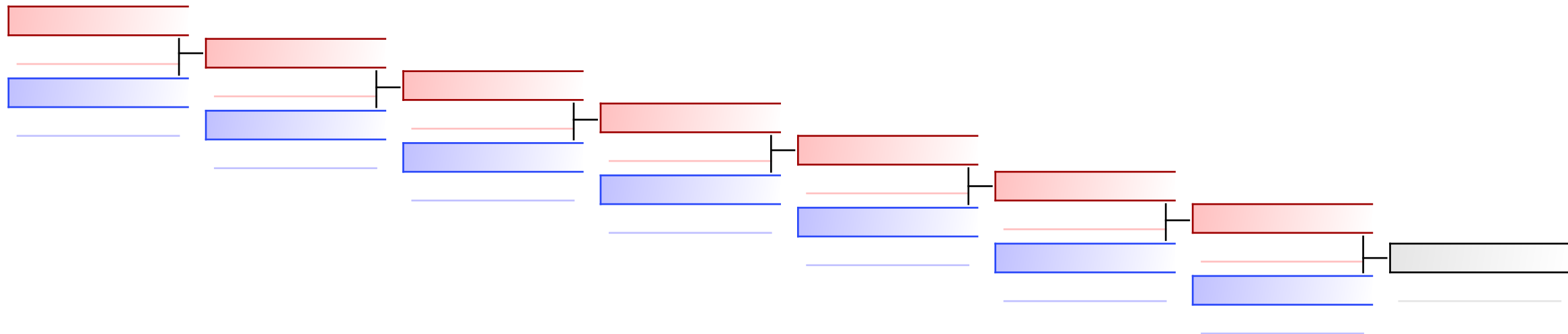

Referees:							
-----------	--	--	--	--	--	--	--

Newcomer Kumite Kinder A -40/+40kg männlich

OFFENE UNTERFRÄNKISCHE KARATE BEZIRKSMEISTERSCHAFT & NEWCOMER KARATE TURNIER 2024, Hermasweg 1 97506 Grafenheinfeld, GER

Tatami

Pool

1/1

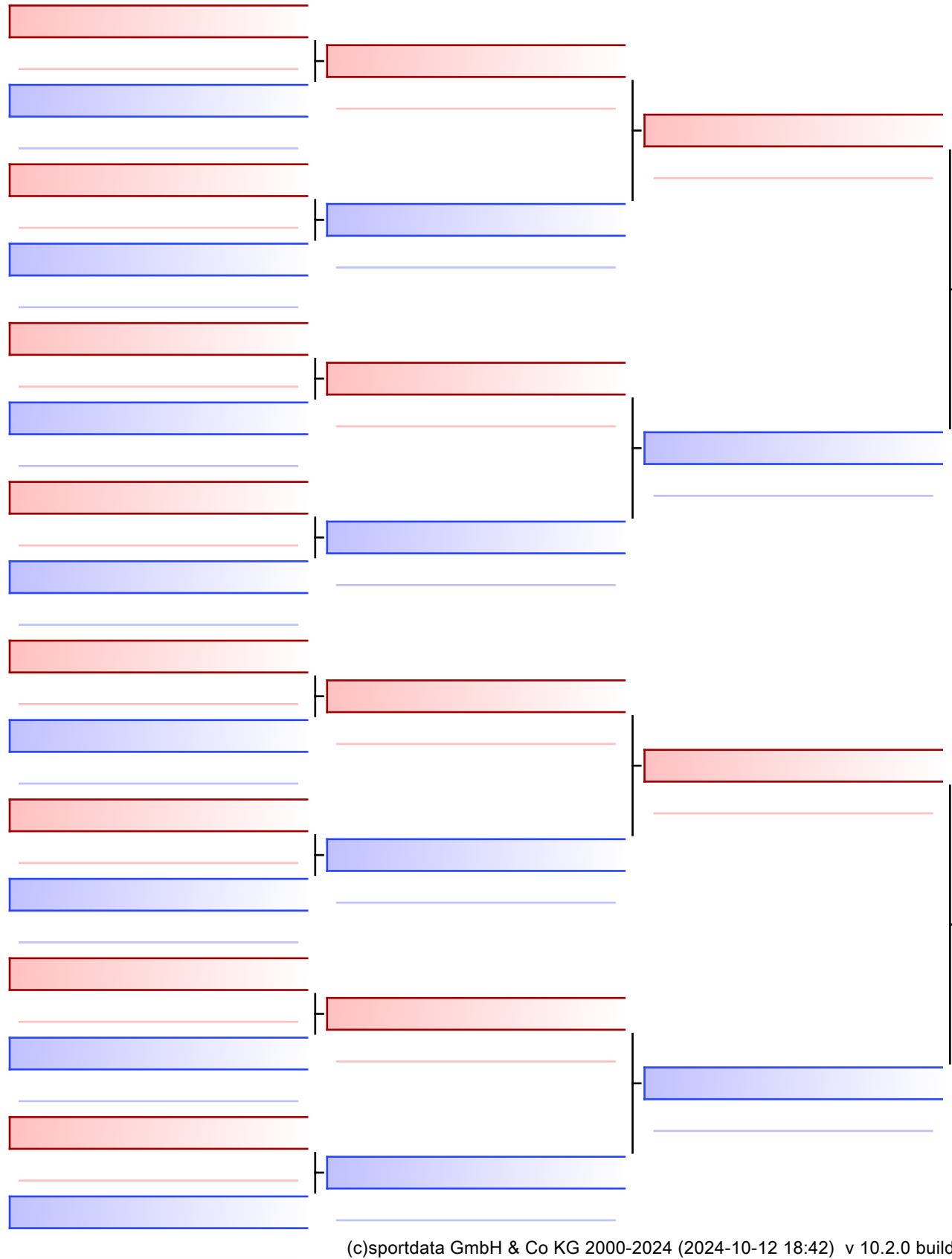

Final

Wiessner Albert (KDNaila,GER)

7

Wiessner Albert (KDNaila,GER)

Klaus Maximilian (KD-Untermerzbach,GER)

2

1. WIESSNER ALBERT (KDNAILA,GER)
2. KLAUS MAXIMILIAN (KD-UNTERMERZBACH,GER)

Referees:			

Newcomer Kumite Kinder B -25 kg männlich

OFFENE UNTERFRÄNKISCHE KARATE BEZIRKSMEISTERSCHAFT & NEWCOMER KARATE TURNIER 2024, Hermasweg 1 97506 Grafenheinfeld, GER

Tatami

Pool

1/1

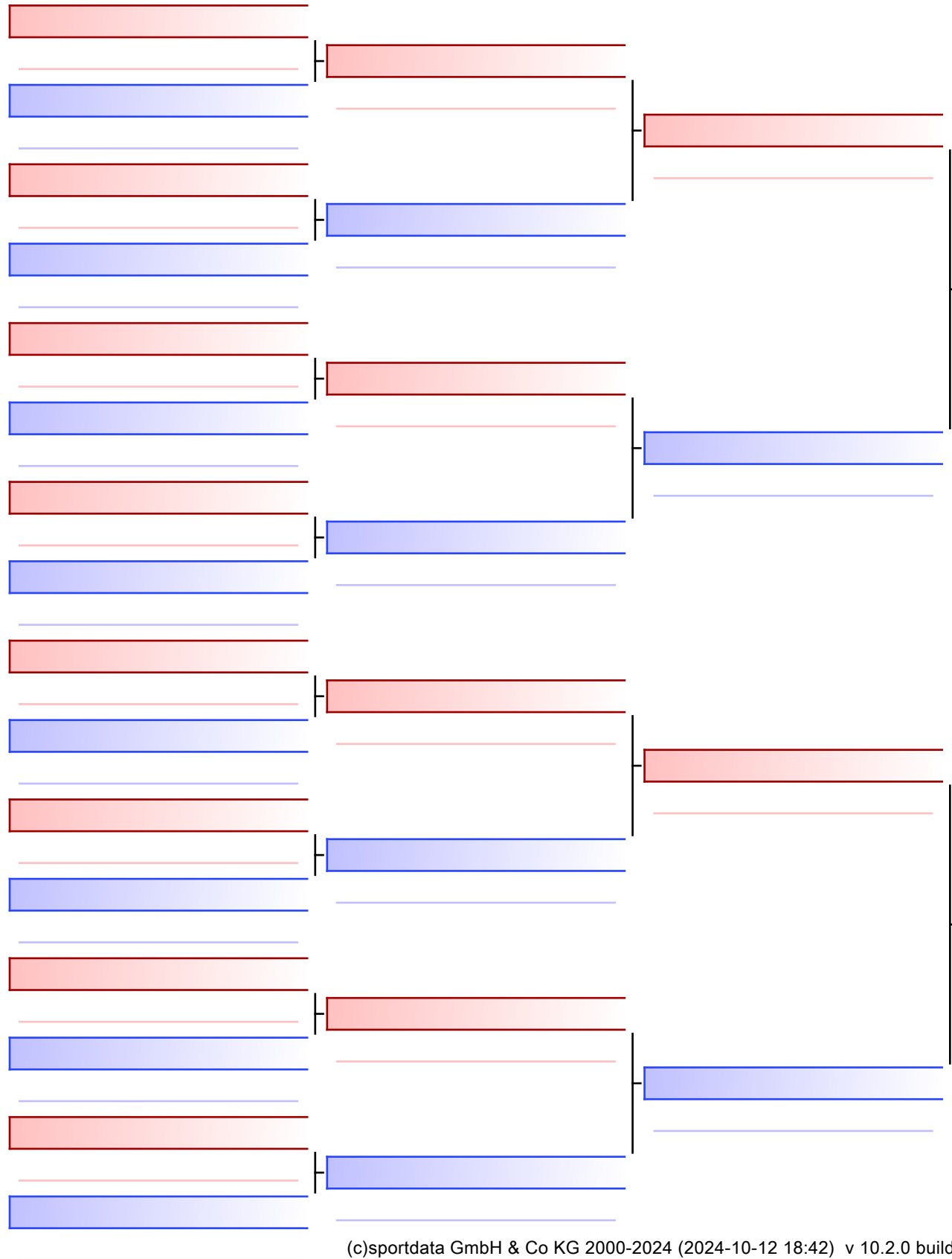

Final

Bayer Karl (KD-Untermerzbach,GER)

10

Bayer Karl (KD-Untermerzbach,GER)

Schmidt Benedikt (BC,GER)

7

1. BAYER KARL (KD-UNTERMERZBACH,GER)
2. SCHMIDT BENEDIKT (BC,GER)

Referees:			

Newcomer Kumite Kinder B weiblich

OFFENE UNTERFRÄNKISCHE KARATE BEZIRKSMEISTERSCHAFT & NEWCOMER KARATE TURNIER 2024, Hermasweg 1 97506 Grafenrheinfeld, GER

2024-10-12

Tatami

1 10:30

Pool

1/1

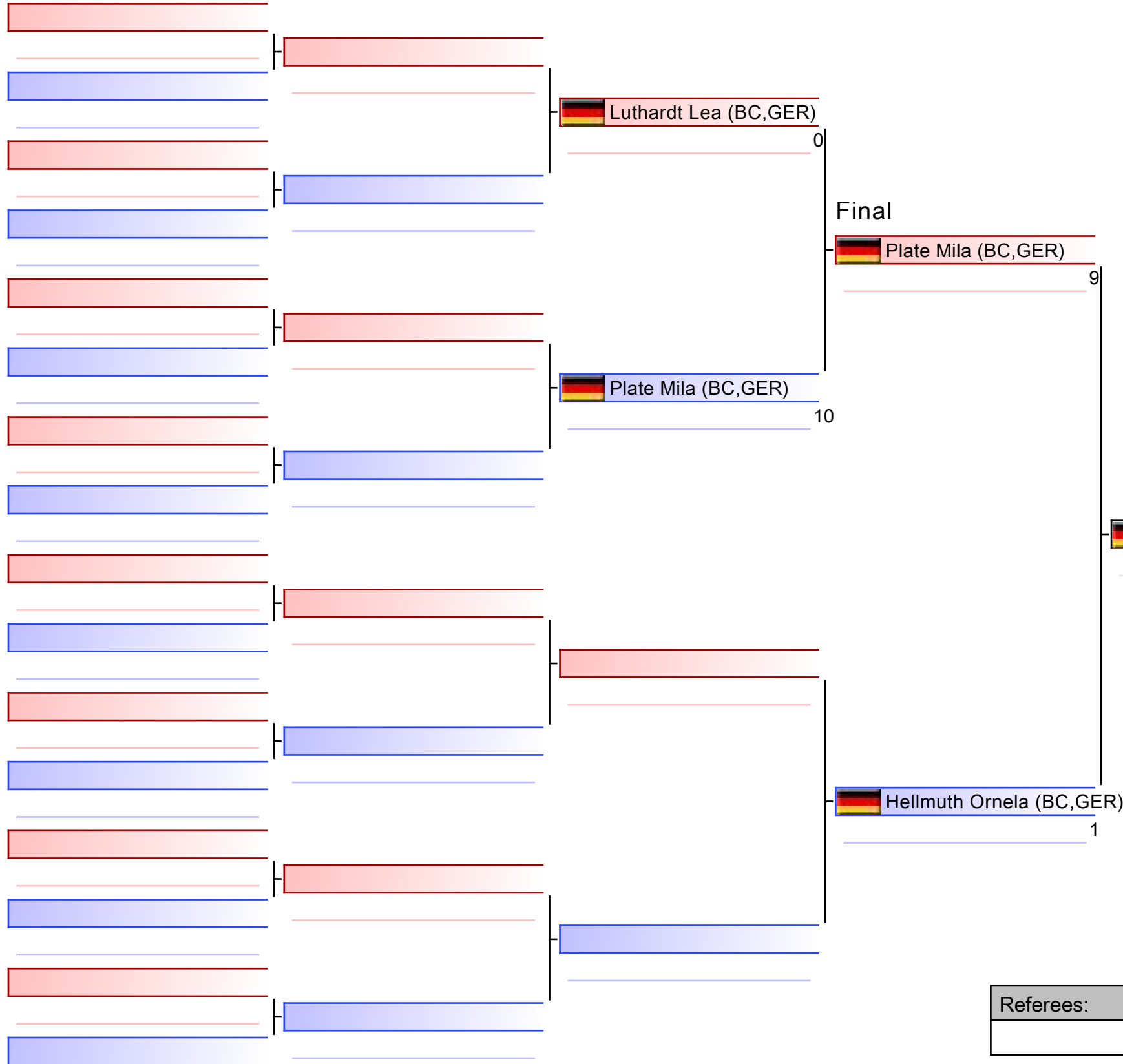

1. PLATE MILA (BC,GER)
2. HELLMUTH ORNELA (BC,GER)
3. LUTHARDT LEA (BC,GER)

Referees:			

Newcomer Kumite Kinder B weiblich

OFFENE UNTERFRÄNKISCHE KARATE BEZIRKSMEISTERSCHAFT & NEWCOMER KARATE TURNIER 2024

Tatami

Pool

1

(c)sportdata GmbH & Co KG 2000-2024 (2024-10-12 18:43) v 10.2.0 build 1 (2024-09-26 10:14 CET) License: Online_Event_ID-8506_OFFENEUNTERFRNKISCHEKARATEBEZIRKSMEISTERSCHAFTNEWCOMERKARATETURNIER2024

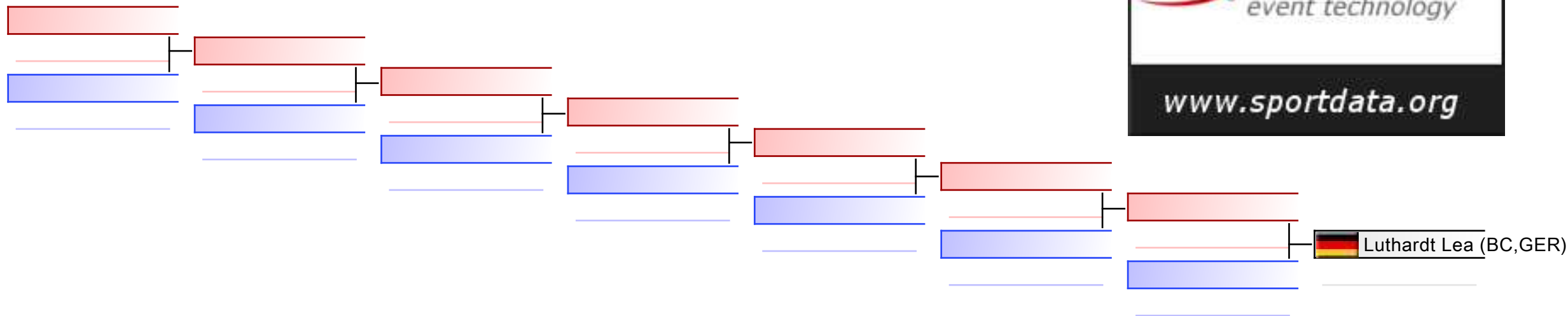

REPECHAGE: (1)

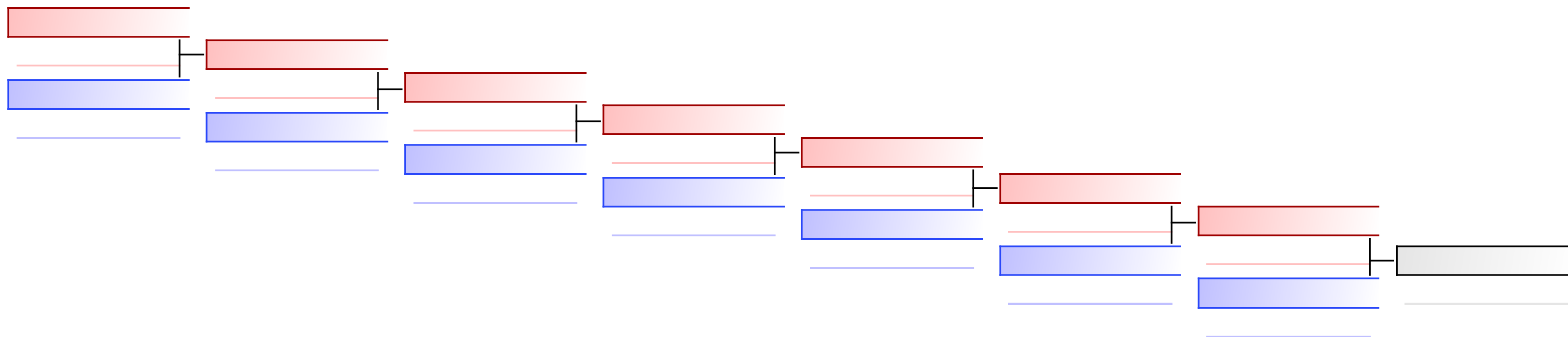

Referees:							
-----------	--	--	--	--	--	--	--

Newcomer Kumite Schüler A -40 kg männlich

OFFENE UNTERFRÄNKISCHE KARATE BEZIRKSMEISTERSCHAFT & NEWCOMER KARATE TURNIER 2024, Hermasweg 1 97506 Grafenheinfeld, GER

2024-10-12

Tatami
2 11:15

Pool
1/1

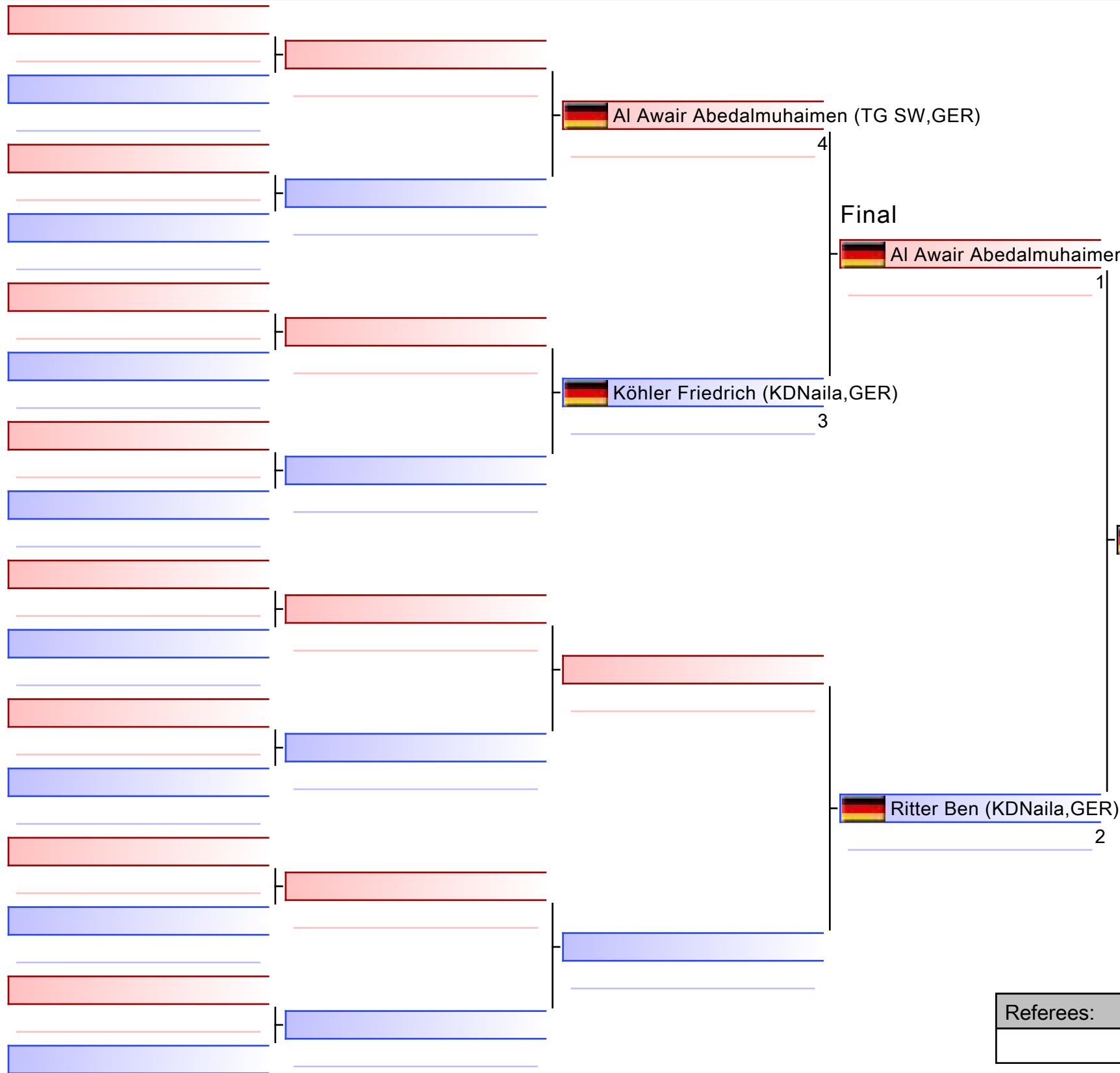

1. RITTER BEN (KDNAILA,GER)
2. AL AWAIR ABEDALMUHAIMEN (TG SW,GER)
3. KÖHLER FRIEDRICH (KDNAILA,GER)

Referees:			

Newcomer Kumite Schüler A -40 kg männlich

OFFENE UNTERFRÄNKISCHE KARATE BEZIRKSMEISTERSCHAFT & NEWCOMER KARATE TURNIER 2024

Tatami

Pool

1

(c)sportdata GmbH & Co KG 2000-2024 (2024-10-12 18:43) v 10.2.0 build 1 (2024-09-26 10:14 CET) License: Online_Event_ID-8506_OFFENEUNTERFRNKISCHEKARATEBEZIRKSMEISTERSCHAFTNEWCOMERKARATETURNIER2024

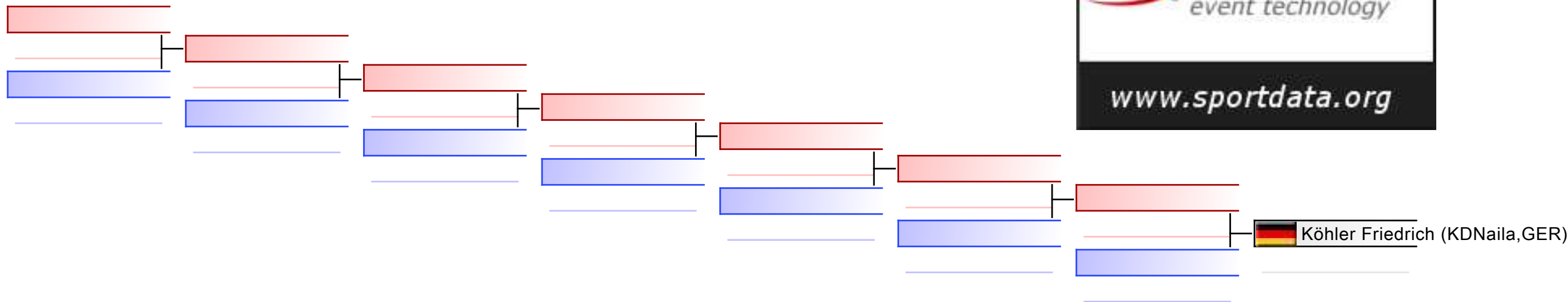

REPECHAGE: (1)

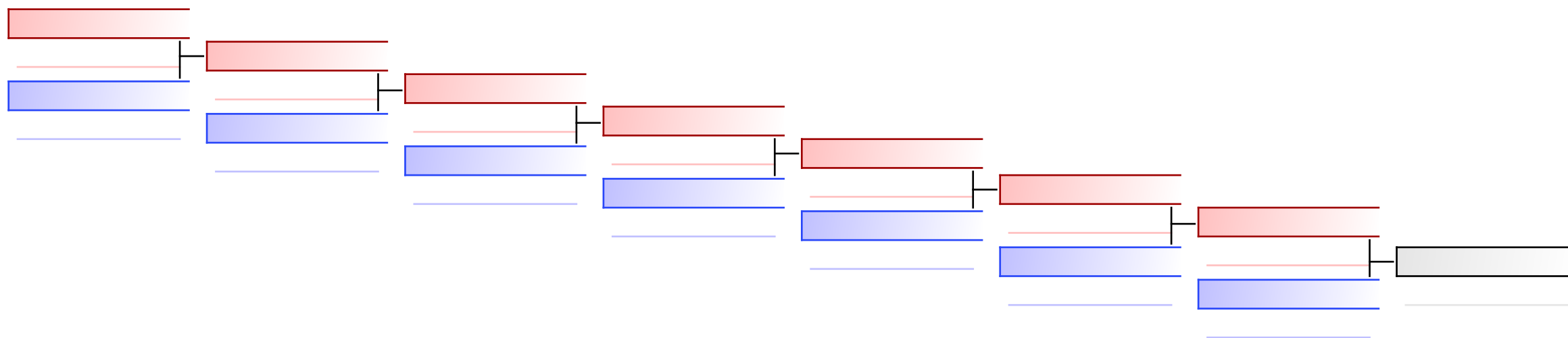

Referees:							
-----------	--	--	--	--	--	--	--

Newcomer Kumite Schüler A -45 kg männlich

OFFENE UNTERFRÄNKISCHE KARATE BEZIRKSMEISTERSCHAFT & NEWCOMER KARATE TURNIER 2024, Hermasweg 1 97506 Grafenheinfeld, GER

Tatami

Pool

1/1

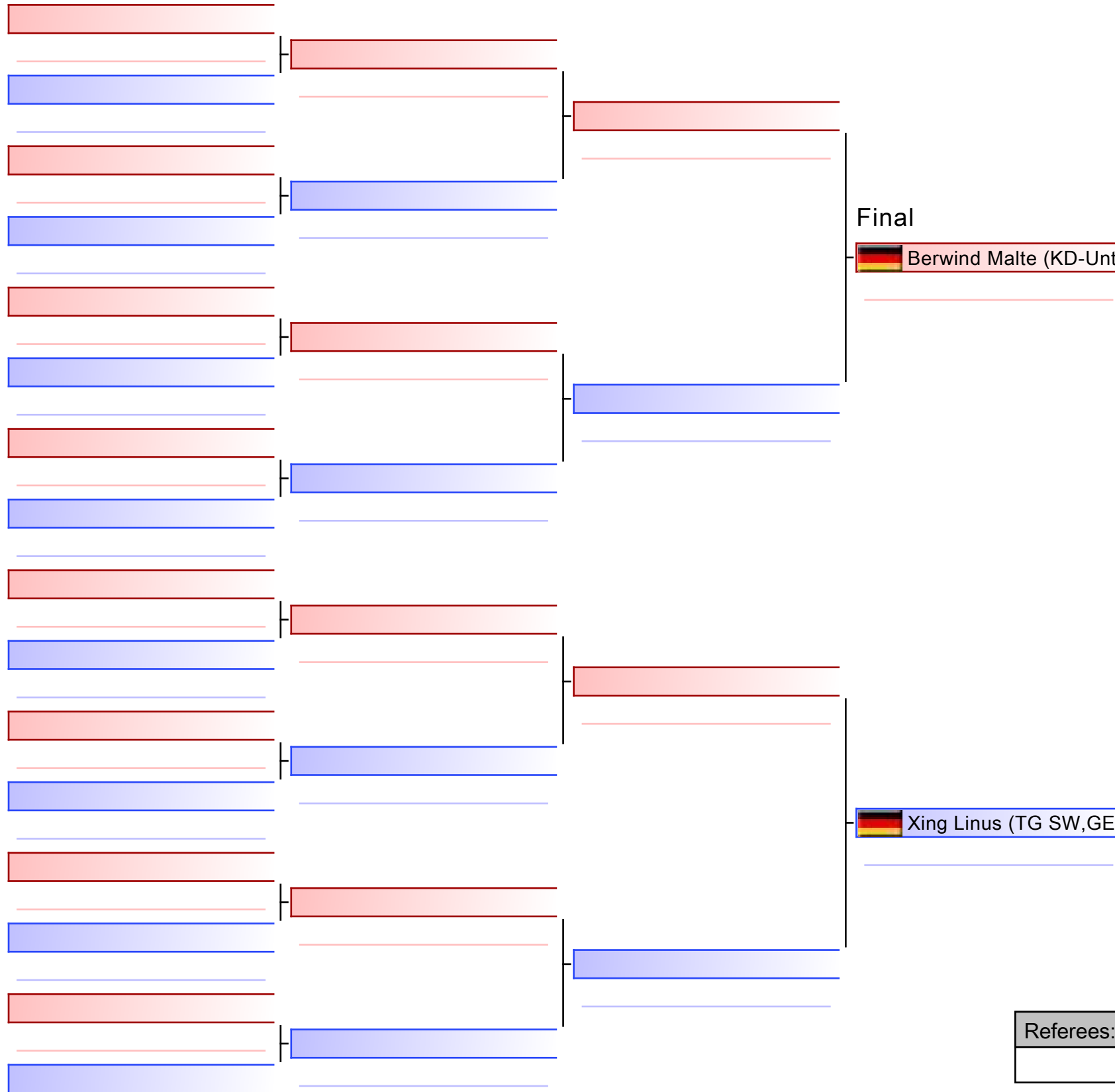

Final

Berwind Malte (KD-Untermerz bach,GER)

0

Xing Linus (TG SW,GER)

1

- | |
|---|
| 1. XING LINUS (TG SW,GER) |
| 2. BERWIND MALTE (KD-UNTERMERZBACH,GER) |
| |
| |
| |
| |
| |

Referees:			

Newcomer Kumite Schüler A -50/+55kg männlich

OFFENE UNTERFRÄNKISCHE KARATE BEZIRKSMEISTERSCHAFT & NEWCOMER KARATE TURNIER 2024, Hermasweg 1 97506 Grafenheinfeld, GER

Tatami

Pool

1/1

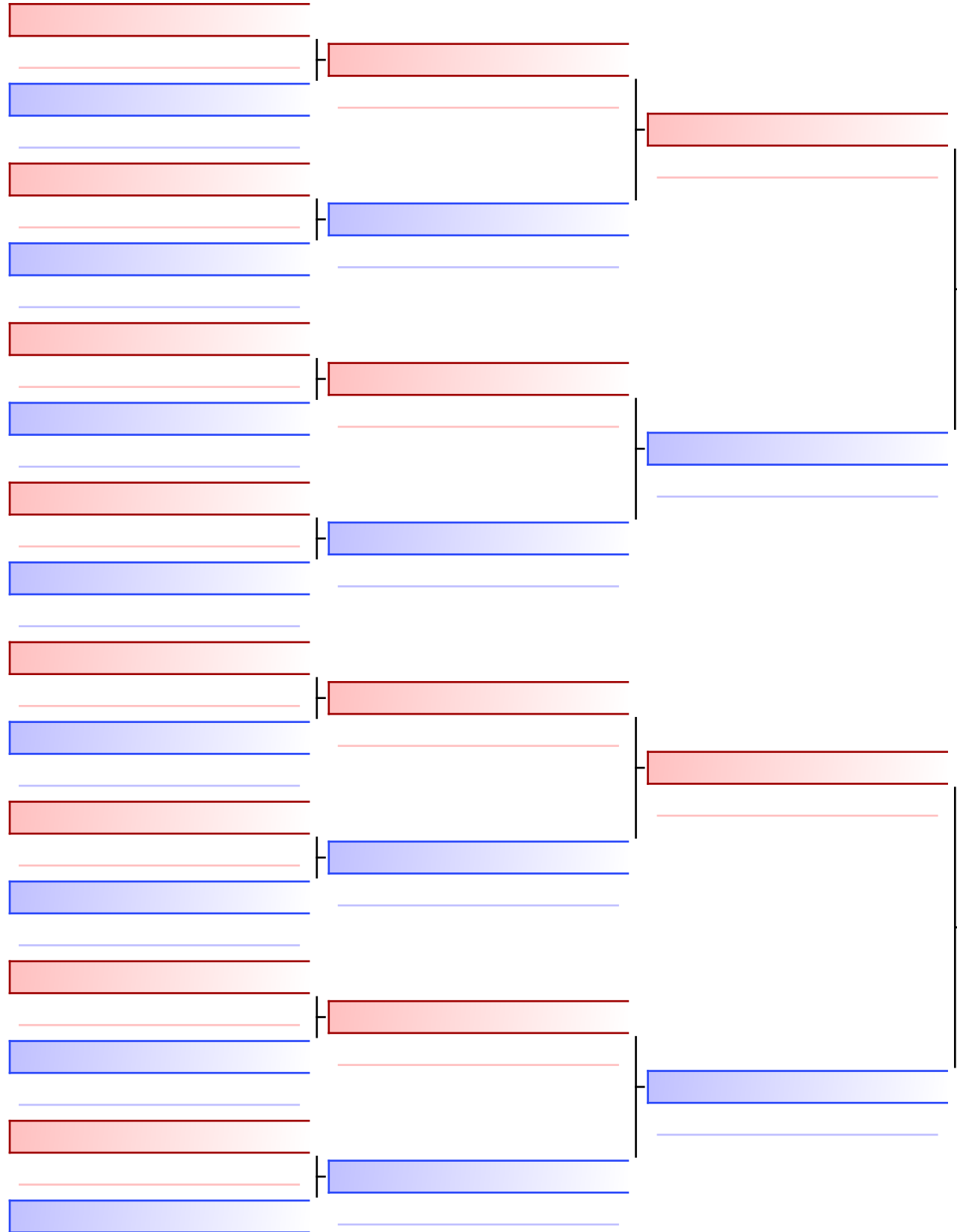

Final

Tas Berkay (Budokan SW,GER)

1

Kummerer Paul (SV Abenberg,GER)

Kummerer Paul (SV Abenberg,GER)

7

1. KUMMERER PAUL (SV ABENBERG,GER)
2. TAS BERKAY (BUDOKAN SW,GER)

Referees:			

Newcomer Kumite Schüler A weiblich

OFFENE UNTERFRÄNKISCHE KARATE BEZIRKSMEISTERSCHAFT & NEWCOMER KARATE TURNIER 2024, Hermasweg 1 97506 Grafenheinfeld, GER

2024-10-12

Tatami
1 11:15

Pool
1/1

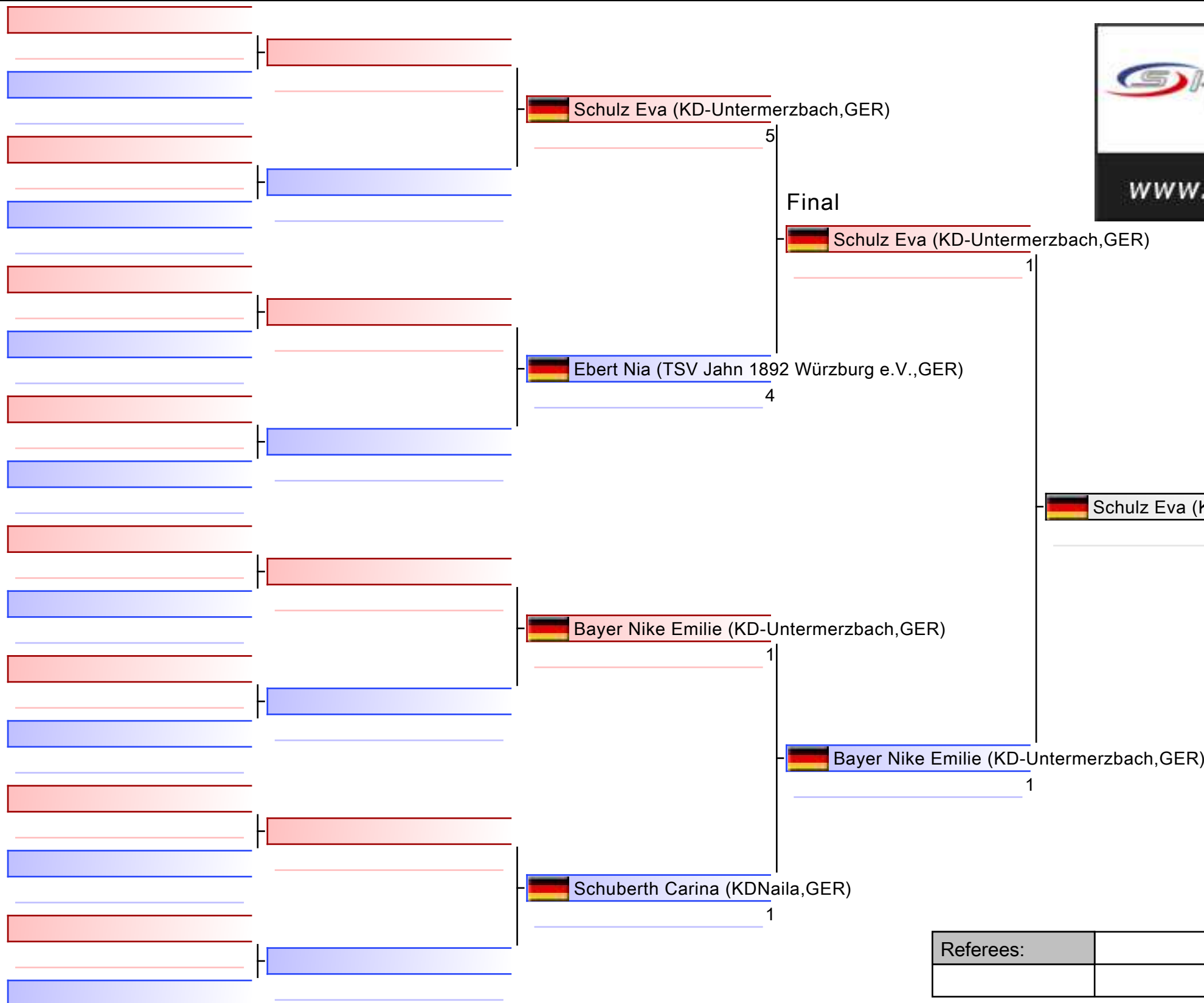

- | |
|--|
| 1. SCHULZ EVA (KD-UNTERMERZBACH,GER) |
| 2. BAYER NIKE EMILIE (KD-UNTERMERZBACH,GER) |
| 3. EBERT NIA (TSV JAHN 1892 WÜRZBURG E.V.,GER) |
| 3. SCHUBERTH CARINA (KDNAILA,GER) |
| |
| |
| |

Referees:			

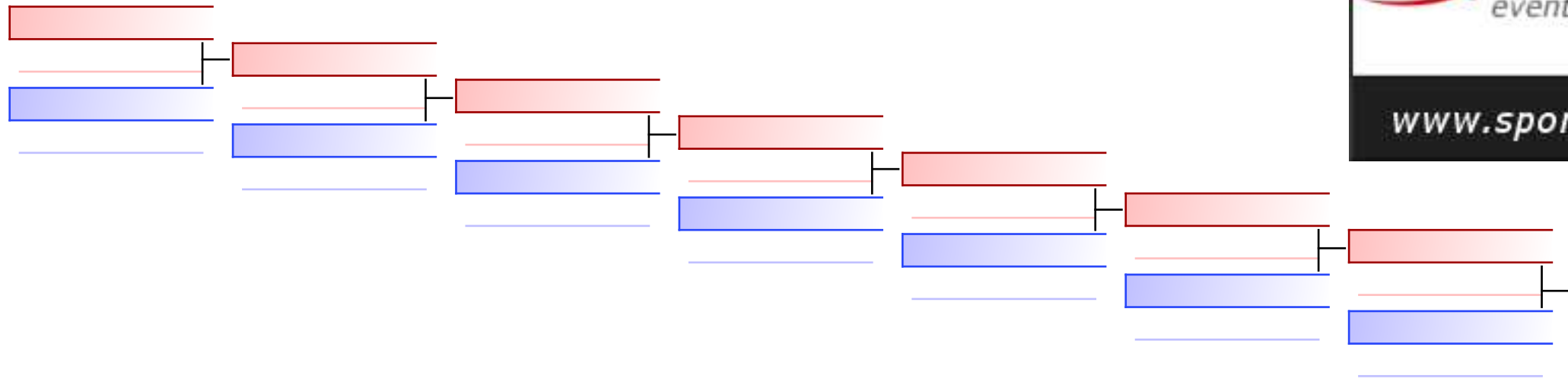

Ebert Nia (TSV Jahn 1892 Würzburg)

REPECHAGE: (1)

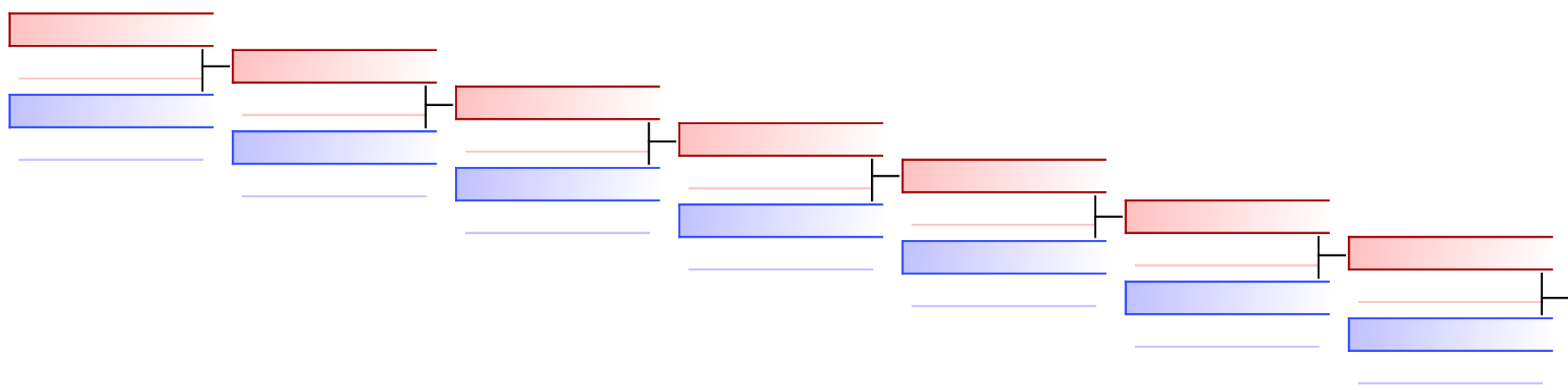

Schuberth Carina (KDNaila, GER)

Referees:							
-----------	--	--	--	--	--	--	--

Newcomer Kumite Schüler B +36 kg weiblich

OFFENE UNTERFRÄNKISCHE KARATE BEZIRKSMEISTERSCHAFT & NEWCOMER KARATE TURNIER 2024, Hermasweg 1 97506 Grafenheinfeld, GER

2024-10-12

Tatami
3 11:05

Pool
1/1

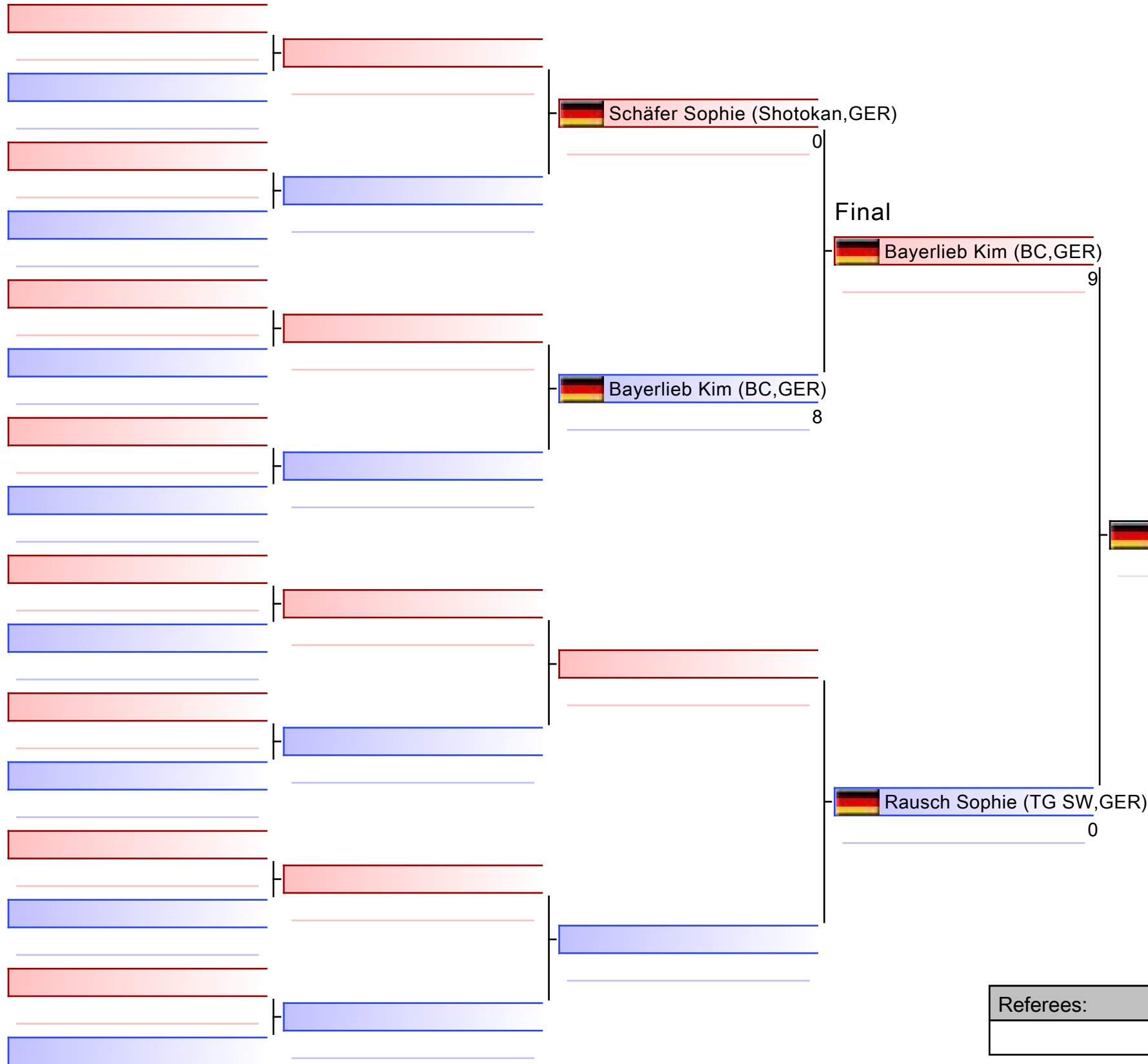

1. BAYERLIEB KIM (BC,GER)
2. RAUSCH SOPHIE (TG SW,GER)
3. SCHÄFER SOPHIE (SHOTOKAN,GER)

Referees:			

Newcomer Kumite Schüler B +36 kg weiblich

OFFENE UNTERFRÄNKISCHE KARATE BEZIRKSMEISTERSCHAFT & NEWCOMER KARATE TURNIER 2024

Tatami

Pool

1

(c)sportdata GmbH & Co KG 2000-2024 (2024-10-12 18:43) v 10.2.0 build 1 (2024-09-26 10:14 CET) License: Online_Event_ID-8506_OFFENEUNTERFRNKISCHEKARATEBEZIRKSMEISTERSCHAFTNEWCOMERKARATETURNIER2024

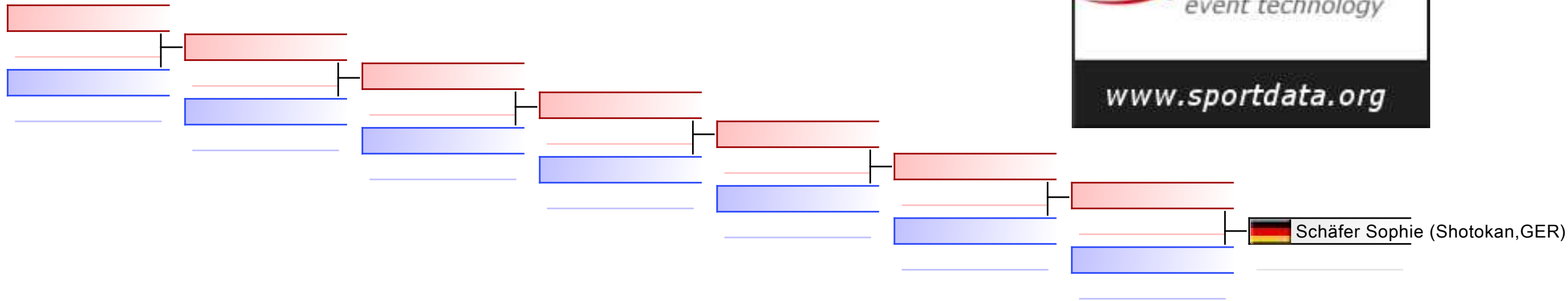

REPECHAGE: (1)

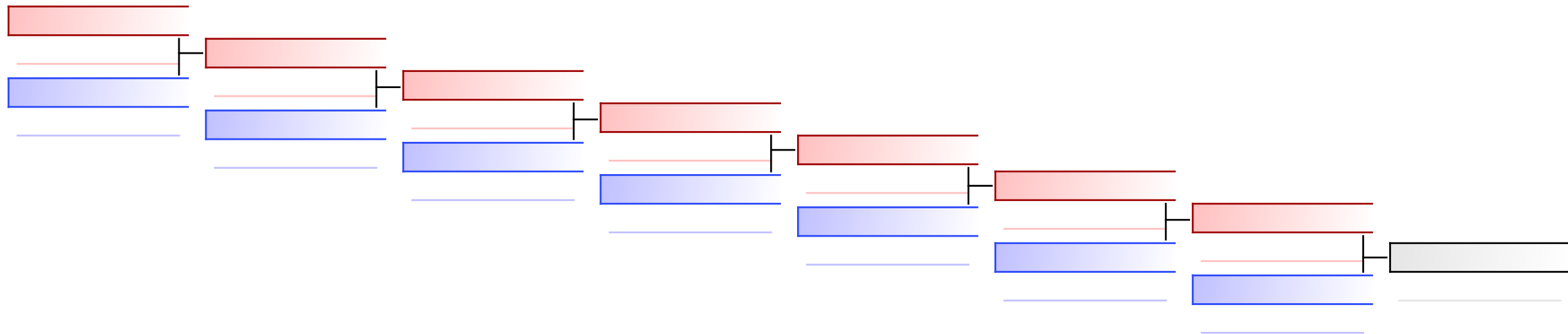

Referees:							
-----------	--	--	--	--	--	--	--

Newcomer Kumite Schüler B +38 kg männlich

OFFENE UNTERFRÄNKISCHE KARATE BEZIRKSMEISTERSCHAFT & NEWCOMER KARATE TURNIER 2024, Hermasweg 1 97506 Grafenheinfeld, GER

2024-10-12

Tatami
2 10:40

Pool
1/1

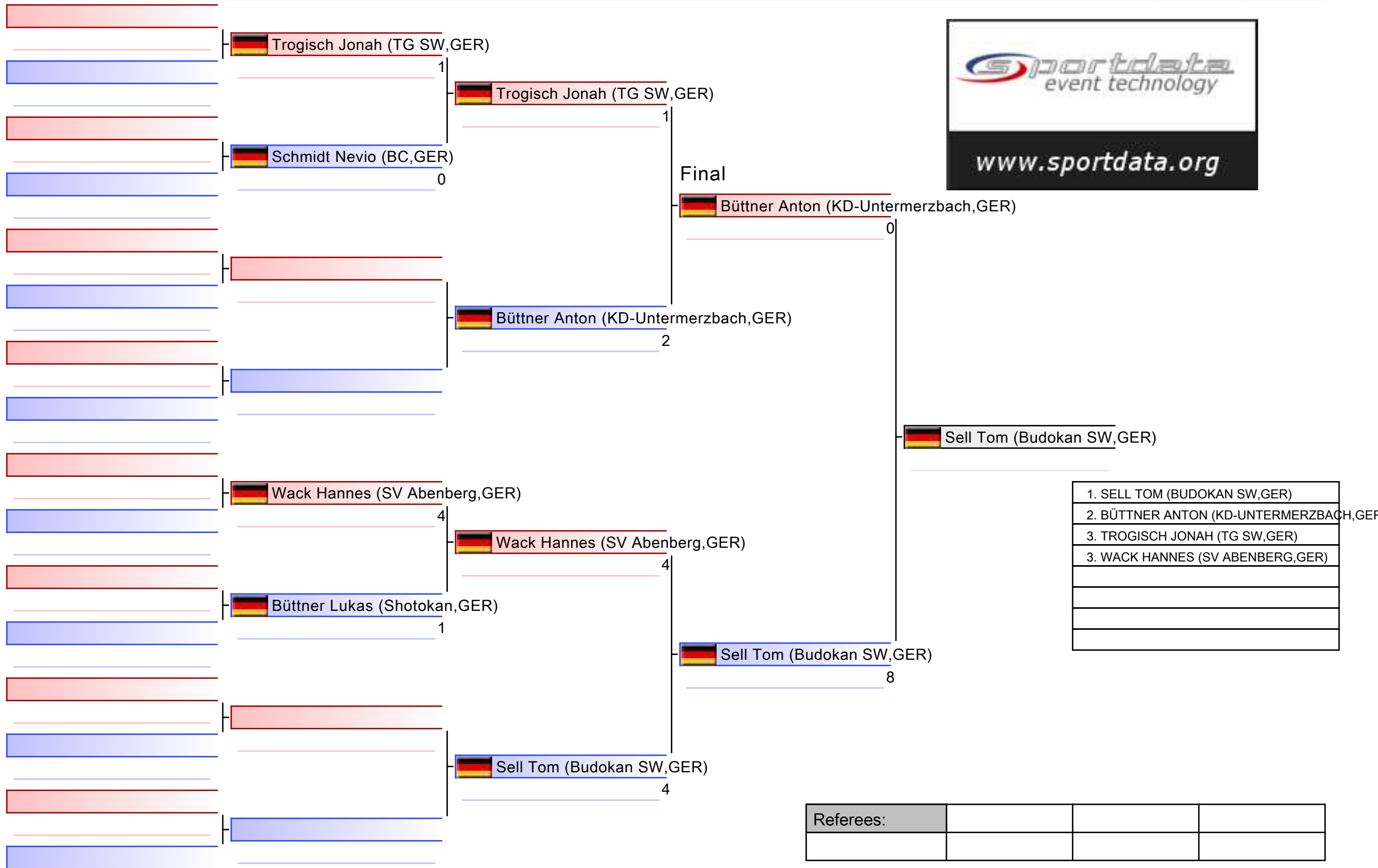

Newcomer Kumite Schüler B +38 kg männlich

OFFENE UNTERFRÄNKISCHE KARATE BEZIRKSMEISTERSCHAFT & NEWCOMER KARATE TURNIER 2024

2024-10-12

Tatami
2 10:55

Pool
1

(c)sportdata GmbH & Co KG 2000-2024 (2024-10-12 18:43) v 10.2.0 build 1 (2024-09-26 10:14 CET) License: Online_Event_ID-8506_OFFENEUNTERFRNKISCHEKARATEBEZIRKSMEISTERSCHAFTNEWCOMERKARATETURNIER2024

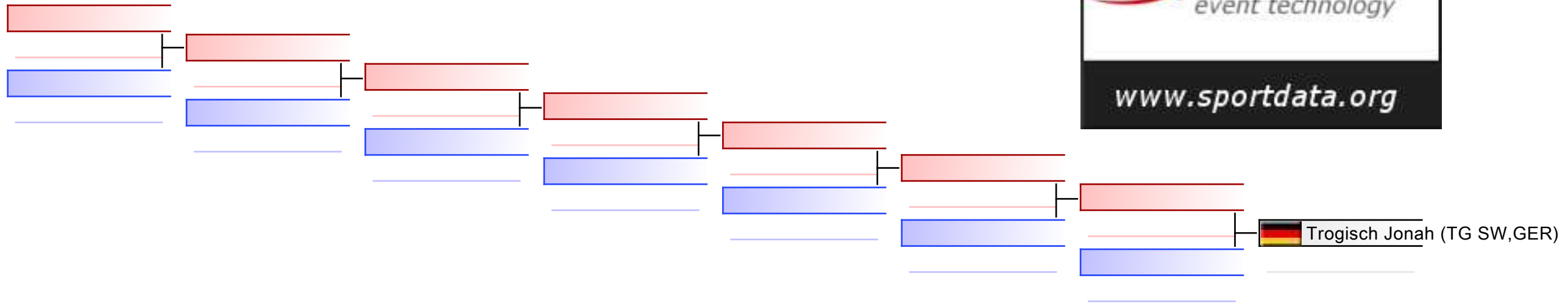

REPECHAGE: (1)

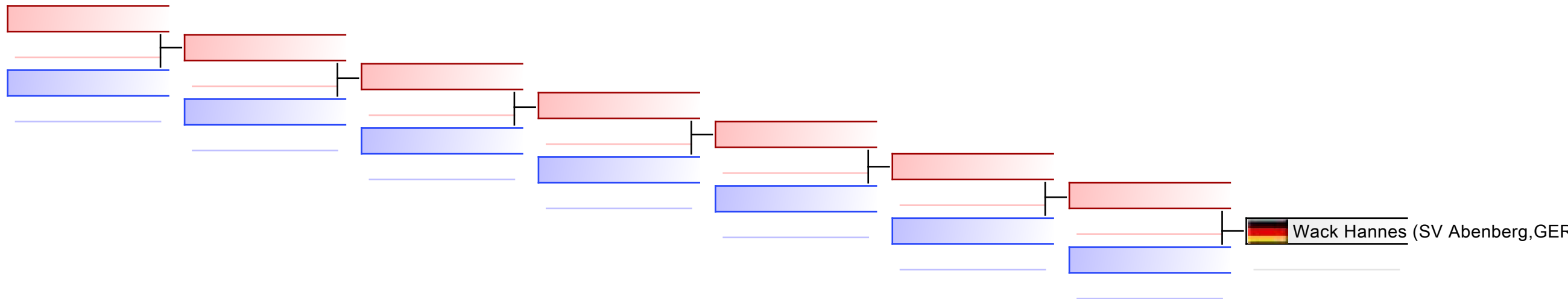

Referees:							
-----------	--	--	--	--	--	--	--

Newcomer Kumite Schüler B -30/-36kg weiblich

OFFENE UNTERFRÄNKISCHE KARATE BEZIRKSMEISTERSCHAFT & NEWCOMER KARATE TURNIER 2024, Hermasweg 1 97506 Grafenrheinfeld, GER

Tatami

Pool

1/1

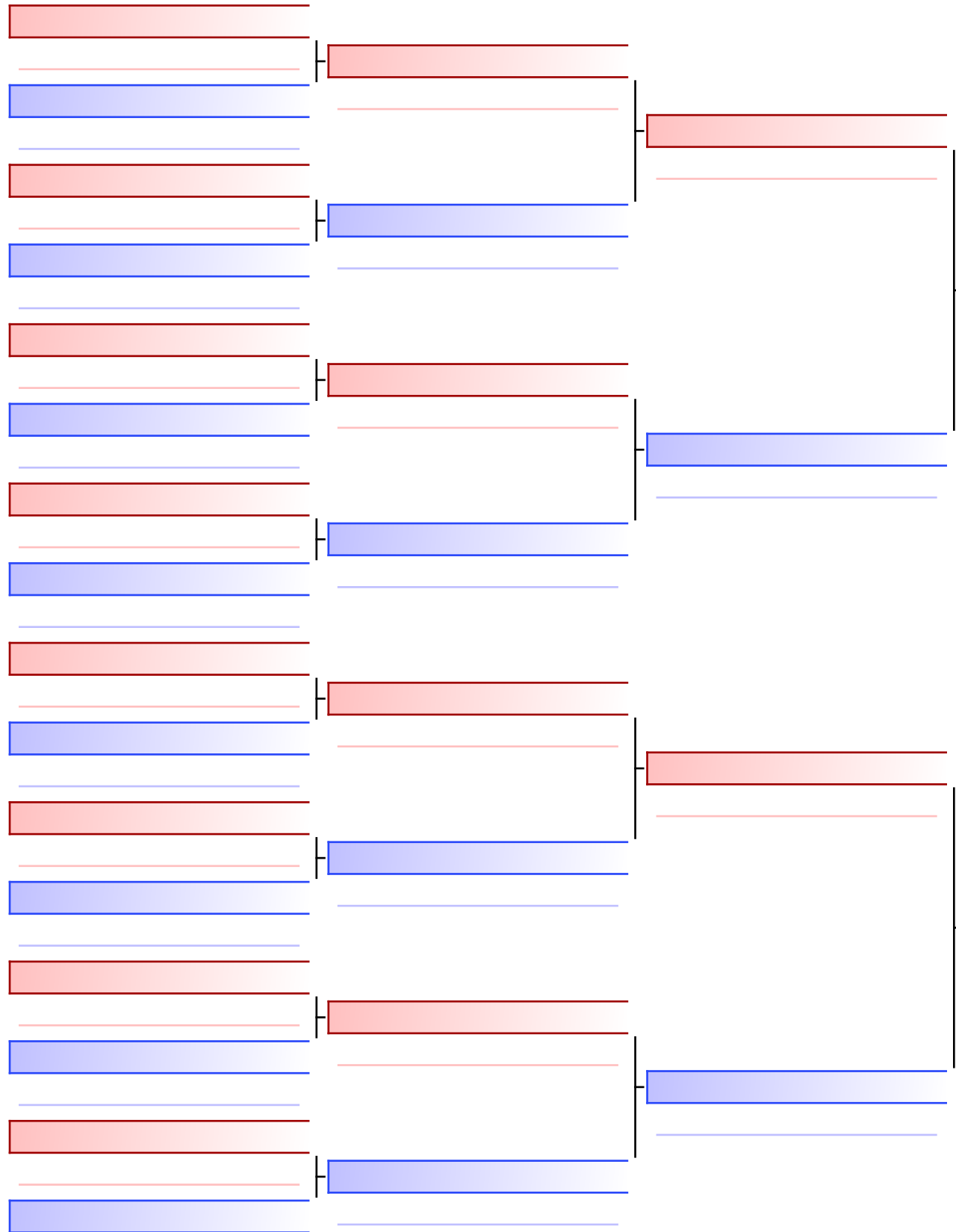

Final

Kusnezov Vanessa (KDNaila,GER)

10

Kusnezov Vanessa (KDNaila,GER)

Barboni Christina (BC,GER)

5

1. KUSNEZOV VANESSA (KDNAILA,GER)
2. BARBONI CHRISTINA (BC,GER)

Referees:			

Newcomer Kumite Schüler B -32 kg männlich

OFFENE UNTERFRÄNKISCHE KARATE BEZIRKSMEISTERSCHAFT & NEWCOMER KARATE TURNIER 2024, Hermasweg 1 97506 Grafenheinfeld, GER

Tatami

Pool

1/1

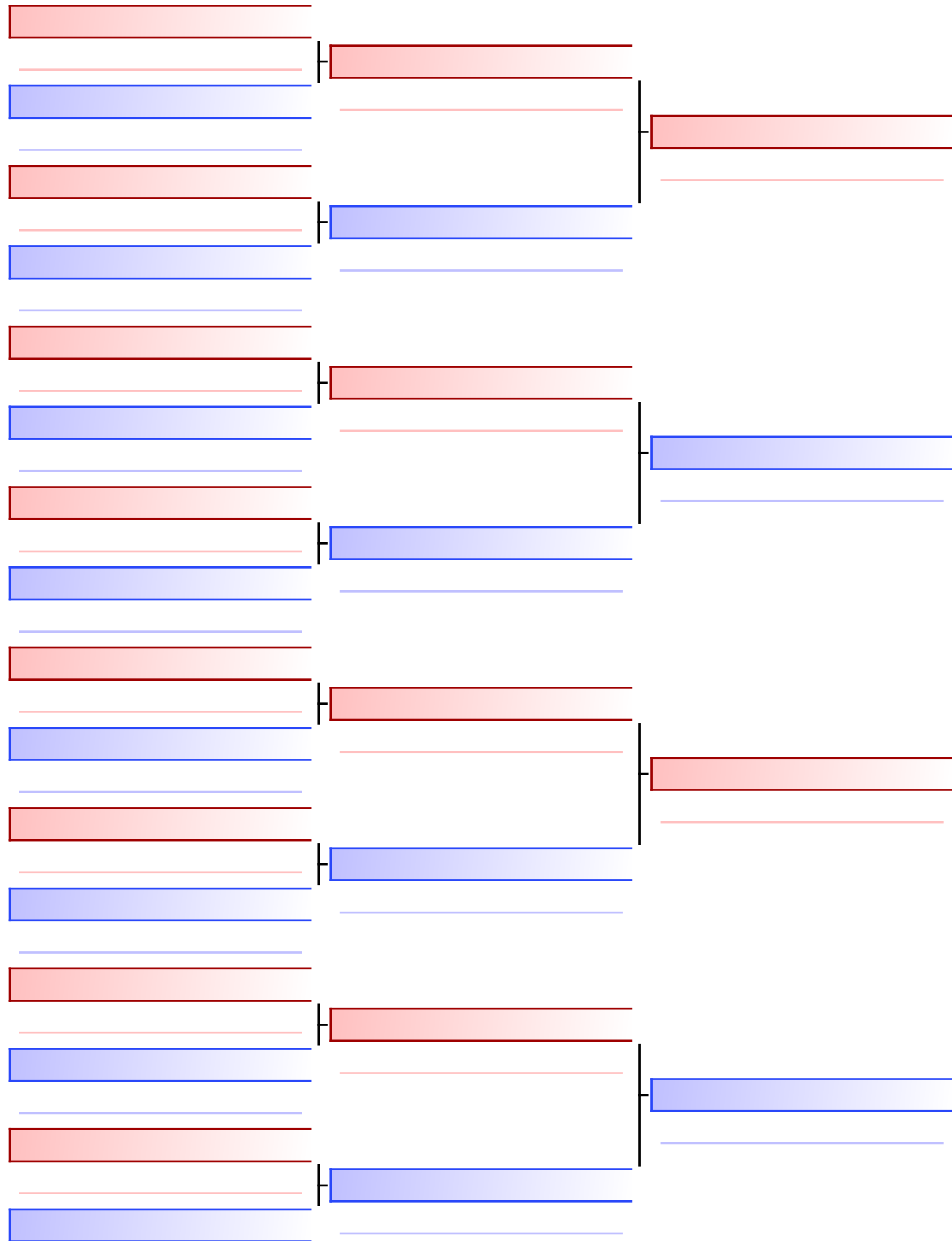

Final

Lohr Christoph (Budokan SW,GER)

4

Ebert Tilman (TSV Jahn 1892 Würzburg e.V.,GER)

Ebert Tilman (TSV Jahn 1892 Würzburg e.V.,GER)

9

1. EBERT TILMAN (TSV JAHN 1892 WÜRZBURG E.V.,GER)
2. LOHR CHRISTOPH (BUDOKAN SW,GER)

Referees:			

Newcomer Kumite Schüler B -38 kg männlich

OFFENE UNTERFRÄNKISCHE KARATE BEZIRKSMEISTERSCHAFT & NEWCOMER KARATE TURNIER 2024, Hermasweg 1 97506 Grafenrheinfeld, GER

2024-10-12

Tatami
1 10:45

Pool
1/1

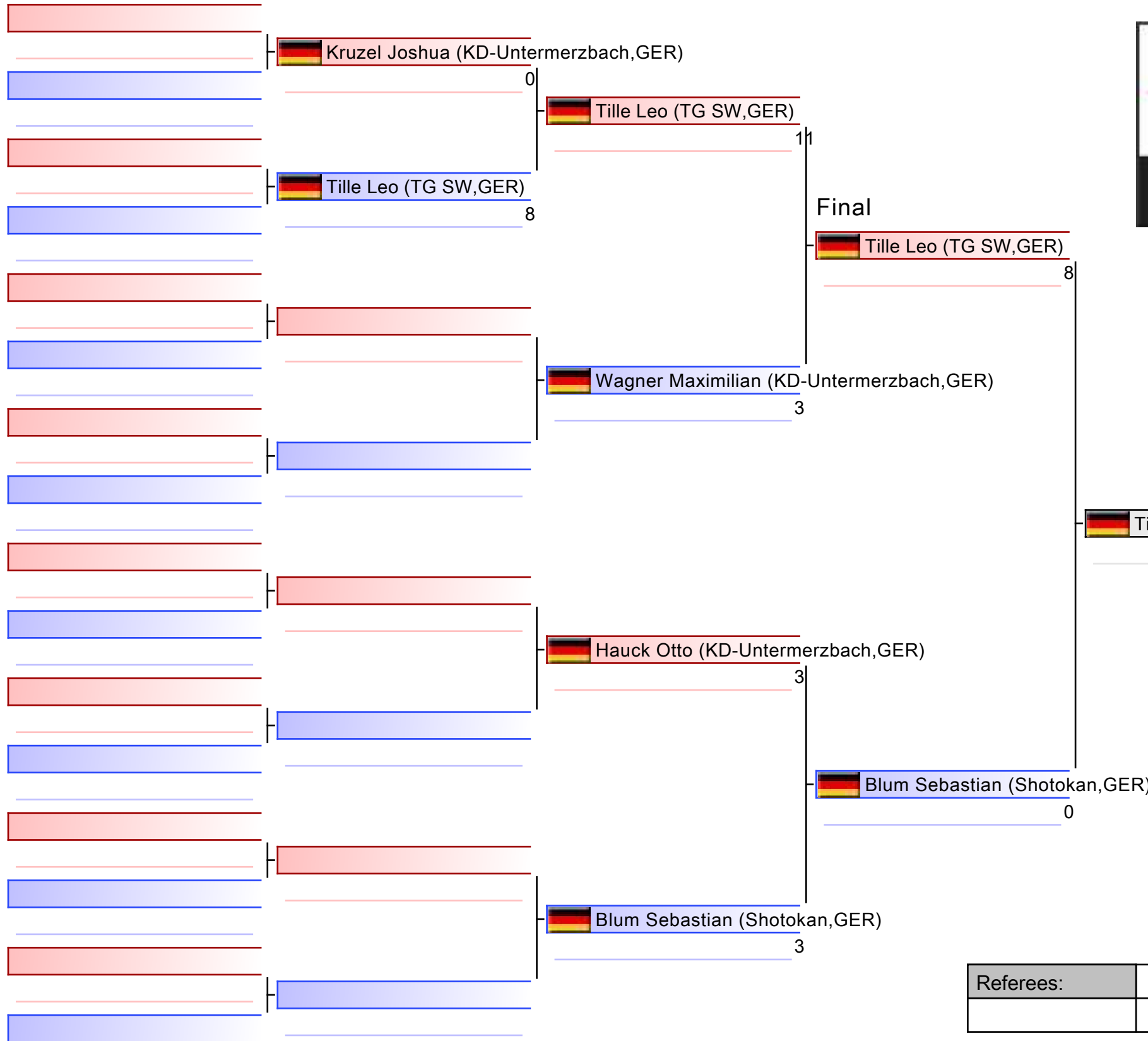

1. TILLE LEO (TG SW,GER)
2. BLUM SEBASTIAN (SHOTOKAN,GER)
3. HAUCK OTTO (KD-UNTERMERZBACH,GER)
3. KRUZEL JOSHUA (KD-UNTERMERZBACH,GER)
5. WAGNER MAXIMILIAN (KD-UNTERMERZBACH,GER)

Referees:			

Newcomer Kumite Schüler B -38 kg männlich

OFFENE UNTERFRÄNKISCHE KARATE BEZIRKSMEISTERSCHAFT & NEWCOMER KARATE TURNIER 2024

2024-10-12

Tatami
1 11:00

Pool
1

(c)sportdata GmbH & Co KG 2000-2024 (2024-10-12 18:43) v 10.2.0 build 1 (2024-09-26 10:14 CET) License: Online_Event_ID-8506_OFFENEUNTERFRNKISCHEKARATEBEZIRKSMEISTERSCHAFTNEWCOMERKARATETURNIER2024

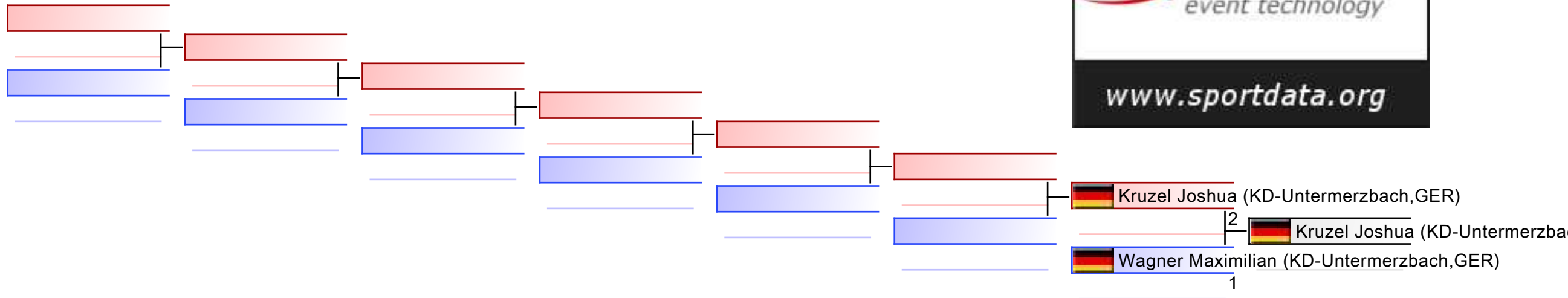

REPECHAGE: (1)

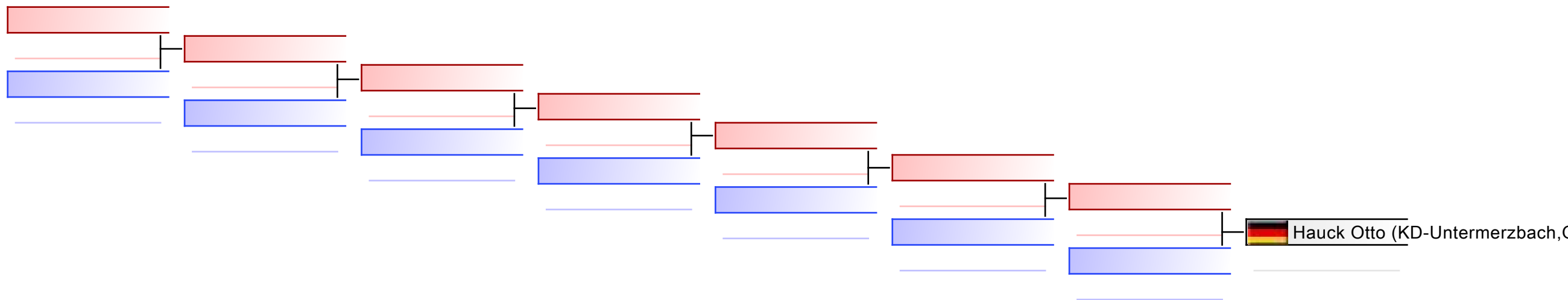

Referees:							
-----------	--	--	--	--	--	--	--

OFFENE UNTERFRÄNKISCHE KARATE
BEZIRKSMEISTERSCHAFT & NEWCOMER
KARATE TURNIER 2024 - 2024-10-12

Official Results

KATA Jugend männlich					
1	BRAUN DANIEL	SV UNSU KARATE MÖMLINGEN E.V.		GER - GERMANY	
2	MOHR JAN	TUS FEUCHTWANGEN		GER - GERMANY	
3	SENDER FYNN	TV TRENNFURT		GER - GERMANY	
3	MANIYUR PRAVEEN PRADHYUMN	TSV JAHN 1892 WÜRZBURG E.V.		GER - GERMANY	
5	GAUTAM BISHUAS	FSV NEUSTADT/ ERLACH A. MAIN		GER - GERMANY	
5	SCHMIDT JAKOB	SV UNSU KARATE MÖMLINGEN E.V.		GER - GERMANY	

KATA Jugend weiblich					
1	BIEDEMANN GRETA	SV UNSU KARATE MÖMLINGEN E.V.		GER - GERMANY	
2	BIEDEMANN HANNAH	SV UNSU KARATE MÖMLINGEN E.V.		GER - GERMANY	
3	KUFFER SANYA	SPORTSCHULE KAIZEN NÜRNBERG		GER - GERMANY	
3	RIEMENSPERGER ISABEL	TSV JAHN 1892 WÜRZBURG E.V.		GER - GERMANY	
5	CAKMAK ELA	SV UNSU KARATE MÖMLINGEN E.V.		GER - GERMANY	

KATA Kinder A männlich					
1	ZIMMERMANN JOSEF	TV TRENNFURT		GER - GERMANY	
2	MANIYUR PRAVEEN SAHARSH	TSV JAHN 1892 WÜRZBURG E.V.		GER - GERMANY	
3	FISCHER LUCA	KARATE DOJO UNTERMERZBACH		GER - GERMANY	
3	MÜLLICH LUCA	KARATE DOJO UNTERMERZBACH		GER - GERMANY	
5	BAYER KURT	KARATE DOJO UNTERMERZBACH		GER - GERMANY	
5	HÜMMER LEVIN	KARATE DOJO UNTERMERZBACH		GER - GERMANY	

KATA Kinder A weiblich					
1	WEISS LEONIE	SPORTSCHULE KAIZEN NÜRNBERG		GER - GERMANY	
2	KAMPHAUSEN MARIE	SPORTSCHULE KAIZEN NÜRNBERG		GER - GERMANY	
3	CEYLAN SÜMEYYE	SV UNSU KARATE MÖMLINGEN E.V.		GER - GERMANY	
3	GRANZOW IDA MARIE	SV UNSU KARATE MÖMLINGEN E.V.		GER - GERMANY	
5	ÖZLÜOĞLU BETÜL	SV UNSU KARATE MÖMLINGEN E.V.		GER - GERMANY	
5	ÖZLÜOĞLU BEGÜM	SV UNSU KARATE MÖMLINGEN E.V.		GER - GERMANY	

KATA Schüler A männlich					
1	STADICK TILL	TV FÜRTH 1860 E.V.		GER - GERMANY	
2	FRIEDRICH LEONARD	SPORTSCHULE KAIZEN NÜRNBERG		GER - GERMANY	

OFFENE UNTERFRÄNKISCHE KARATE
BEZIRKSMEISTERSCHAFT & NEWCOMER
KARATE TURNIER 2024 - 2024-10-12







Official Results

3	RIEMENSPERGER JUSTUS	TSV JAHN 1892 WÜRZBURG E.V.		GER - GERMANY	
3	ANDRESEN LASSE	KARATE DOJO NAILA		GER - GERMANY	

KATA Schüler A weiblich

1	AKINCI NISA NAZ	SV UNSU KARATE MÖMLINGEN E.V.		GER - GERMANY	
2	KAIN THALIA	SPORTSCHULE KAIZEN NÜRNBERG		GER - GERMANY	
3	JÄCKLE ELISA	SPORTSCHULE KAIZEN NÜRNBERG		GER - GERMANY	
3	CEYLAN VAHIDE	SV UNSU KARATE MÖMLINGEN E.V.		GER - GERMANY	
5	DÜNISCH THERESA	KARATE DOJO UNTERMERZBACH		GER - GERMANY	
5	LATUS LENA	TV FÜRTH 1860 E.V.		GER - GERMANY	
7	DWORAK MELINA	TSV JAHN 1892 WÜRZBURG E.V.		GER - GERMANY	

KATA Schüler B männlich

1	YALCIN SEMIN	TV FÜRTH 1860 E.V.		GER - GERMANY	
2	WAGNER MAXIMILIAN	KARATE DOJO UNTERMERZBACH		GER - GERMANY	
3	SCHRAMM JULIAN	TV FÜRTH 1860 E.V.		GER - GERMANY	
3	EBERT TILMAN	TSV JAHN 1892 WÜRZBURG E.V.		GER - GERMANY	
5	HAUCK OTTO	KARATE DOJO UNTERMERZBACH		GER - GERMANY	
5	KRUZEL JOSHUA	KARATE DOJO UNTERMERZBACH		GER - GERMANY	

KATA Schüler B weiblich

1	GÜNLÜ AALIYAH	SV UNSU KARATE MÖMLINGEN E.V.		GER - GERMANY	
2	MOHR LOREEN	TUS FEUCHTWANGEN		GER - GERMANY	
3	TROMSA SANDRA	TUS FEUCHTWANGEN		GER - GERMANY	
3	BAKIRKAN DAMLA	SV UNSU KARATE MÖMLINGEN E.V.		GER - GERMANY	
5	REISINGER ELSA	SPORTSCHULE KAIZEN NÜRNBERG		GER - GERMANY	
5	SENDLER LINA	TV TRENNFURT		GER - GERMANY	

KUMITE Jugend +70kg männlich

1	BAIL JONAS	POST SV BAMBERG		GER - GERMANY	
2	KRÄMER JONAS	KARATE DOJO UNTERMERZBACH		GER - GERMANY	
3	SELL HANNES	BUDOKAN 72 E.V.SCHWEINFURT		GER - GERMANY	

KUMITE Jugend -52kg männlich

1	VOGL SIMON	TV 1875 BURGLENGENFELD EV		GER - GERMANY	
---	------------	---------------------------------	---	---------------	--

OFFENE UNTERFRÄNKISCHE KARATE
BEZIRKSMEISTERSCHAFT & NEWCOMER
KARATE TURNIER 2024 - 2024-10-12

Official Results

2	CANCI DOMENIK	1. KEMPTENER KARATE DOJO IM TV KEMPTEN		GER - GERMANY	
3	ZELLER JARON	SV ABENBERG		GER - GERMANY	

KUMITE Jugend -54kg weiblich

1	MORINA LONA	BUDOKAN 72 E.V.SCHWEINFURT		GER - GERMANY	
2	MÜLLER THERESIA	TV/DJK HAMMELBURG		GER - GERMANY	

KUMITE Kinder A -30kg männlich

1	BAYER KURT	KARATE DOJO UNTERMERZBACH		GER - GERMANY	
2	MANIYUR PRAVEEN SAHARSH	TSV JAHN 1892 WÜRZBURG E.V.		GER - GERMANY	
3	MÜLLICH LUCA	KARATE DOJO UNTERMERZBACH		GER - GERMANY	
3	HÜMMER LEVIN	KARATE DOJO UNTERMERZBACH		GER - GERMANY	

KUMITE Schüler B weiblich

1	BÖCKELMANN AMELIE	TV FÜRTH 1860 E.V.		GER - GERMANY	
2	KUSNEZOV VANESSA	KARATE DOJO NAILA		GER - GERMANY	
3	SCHÄFER SOPHIE	SHOTOKAN BESSENBACH E.V.		GER - GERMANY	

KUMITE TEAM KINDER A/B MÄNNLICH

1	KD UNTERMERZBACH 1 - BAYER KURT - FISCHER LUCA - RÖSSNER FELIX	KARATE DOJO UNTERMERZBACH		GER - GERMANY	
2	KD UNTERMERZBACH 2 - BAYER KARL - HÜMMER LEVIN - MÜLLICH LUCA	KARATE DOJO UNTERMERZBACH		GER - GERMANY	

Kata Junioren männlich

1	KRAUS LAURENZ	SPORTSCHULE KAIZEN NÜRNBERG		GER - GERMANY	
2	BÄTZ PHIL	TV TRENNFURT		GER - GERMANY	

Kata Junioren/Leistungsklasse weiblich

1	JUST ANASTASIA	TG SCHWEINFURT 1848 E.V.		GER - GERMANY	
2	WÖLFEL PAULA	TSV JAHN 1892 WÜRZBURG E.V.		GER - GERMANY	
3	HUBER SABRINA	TV 1875 BURGLENGENFELD EV		GER - GERMANY	
5	URBAN LISA	KARATE DOJO NEUSTADT/WN		GER - GERMANY	

Kata Kinder B mixed

1	GÜNLÜ ALAARA	SV UNSU KARATE MÖMLINGEN E.V.		GER - GERMANY	
---	--------------	----------------------------------	---	---------------	--

OFFENE UNTERFRÄNKISCHE KARATE
BEZIRKSMEISTERSCHAFT & NEWCOMER
KARATE TURNIER 2024 - 2024-10-12

Official Results

2	MORGENROTH LENA	KARATE DOJO UNTERMERZBACH		GER - GERMANY	
3	BAYER KARL	KARATE DOJO UNTERMERZBACH		GER - GERMANY	
3	PELNY JOHN	KARATE DOJO UNTERMERZBACH		GER - GERMANY	

Kata Leistungsklasse männlich

1	PFEIFFER LUCAS	SPORTSCHULE KAIZEN NÜRNBERG		GER - GERMANY	
2	KNEBEL DENNIS	SGS ERLANGEN KARATE E.V.		GER - GERMANY	
3	MÜNCH ARMIN	TV TRENNFURT		GER - GERMANY	
3	ENDRES RICHARD	POST SV BAMBERG		GER - GERMANY	
5	VOLLMAYER MARKUS	POST SV BAMBERG		GER - GERMANY	
5	MANIURA NICLAS	TV TRENNFURT		GER - GERMANY	

Kata Masterklasse weiblich

1	HUBER SABRINA	TV 1875 BURGLENGENFELD EV		GER - GERMANY	
2	BAUER ANDREA	KARATE-AKADEMIE REGENSBURG		GER - GERMANY	

Kata Masterklasse Ü30/Ü35 männlich

1	KNEBEL DENNIS	SGS ERLANGEN KARATE E.V.		GER - GERMANY	
2	MANIURA NICLAS	TV TRENNFURT		GER - GERMANY	
3	MÜNCH ARMIN	TV TRENNFURT		GER - GERMANY	
3	PELNY JENS	KARATE DOJO UNTERMERZBACH		GER - GERMANY	

Kata Masterklasse Ü45 männlich

1	VOLLMAYER MARKUS	POST SV BAMBERG		GER - GERMANY	
2	ENDRES RICHARD	POST SV BAMBERG		GER - GERMANY	
3	STEINHÜBEL RENE	TSV WEMDING 1892 E. V.		GER - GERMANY	
3	DREXLER STEPHAN	FSV NEUSTADT/ ERLACH A. MAIN		GER - GERMANY	

Kata Masterklasse Ü55/Ü65 männlich

1	HEIM FRANK	FSV NEUSTADT/ ERLACH A. MAIN		GER - GERMANY	
2	BURBACH WOLFGANG	POST SV BAMBERG		GER - GERMANY	
3	SCHOL STEPHAN	SGS ERLANGEN KARATE E.V.		GER - GERMANY	

Kata Team Kinder/Schüler mixed

1	BUSHIDO COBURG E.V. - BRUNNER MAX - HELLMUTH MAXIMILIAN - SEDLAK MATTEO	BUSHIDO COBURG E.V.		GER - GERMANY	
2	KD UNTERMERZBACH	KARATE DOJO UNTERMERZBACH		GER - GERMANY	

OFFENE UNTERFRÄNKISCHE KARATE
BEZIRKSMEISTERSCHAFT & NEWCOMER
KARATE TURNIER 2024 - 2024-10-12

Official Results

	- MORGENROTH LENA - MÜLLICH LUCA - PELNY JOHN			
3	KD UNTERMERZBACH - BAYER NIKE EMILIE - DÜNISCH THERESA - SCHULZ EVA	KARATE DOJO UNTERMERZBACH		GER - GERMANY

Kumite Jugend -61/+61 kg weiblich

1	MAUER MARINA	BUDOKAN 72 E.V.SCHWEINFURT		GER - GERMANY
2	SCHUBERTH LAURA	KARATE DOJO NAILA		GER - GERMANY
3	MAUER STELLA	BUDOKAN 72 E.V.SCHWEINFURT		GER - GERMANY
3	VOINU ANDREEA CATALINA	KARATE DOJO NAILA		GER - GERMANY
5	TROST VALENTINA	TV/DJK HAMMELBURG		GER - GERMANY
5	GÖLLER FRANZISKA	SHOTOKAN BESSENBACH E.V.		GER - GERMANY

Kumite Jugend/Junioren -57kg männlich

1	WIMMER HANNES	1. KEMPTENER KARATE DOJO IM TV KEMPTEN		GER - GERMANY
2	JIRA MICHAEL	TV FÜRTH 1860 E.V.		GER - GERMANY
3	MANIYUR PRAVEEN PRADHYUMN	TSV JAHN 1892 WÜRZBURG E.V.		GER - GERMANY
3	POULLIE FYNN	SHOTOKAN BESSENBACH E.V.		GER - GERMANY

Kumite Junioren weiblich

1	SCHNABEL MIRA	KARATE DOJO UNTERMERZBACH		GER - GERMANY
2	SCHNABEL MIA	KARATE DOJO UNTERMERZBACH		GER - GERMANY
3	PÖHLMANN SOPHIE	BUDOKAN 72 E.V.SCHWEINFURT		GER - GERMANY
3	JUST ANASTASIA	TG SCHWEINFURT 1848 E.V.		GER - GERMANY
5	LOHR VIKTORIA	BUDOKAN 72 E.V.SCHWEINFURT		GER - GERMANY
5	STÜRMER MARIE	BUDOKAN 72 E.V.SCHWEINFURT		GER - GERMANY

Kumite Kinder A -35/+40kg männlich

1	WIESSNER ALBERT	KARATE DOJO NAILA		GER - GERMANY
2	RÖSSNER FELIX	KARATE DOJO UNTERMERZBACH		GER - GERMANY
3	VOINU ANDY	KARATE DOJO NAILA		GER - GERMANY
3	FISCHER LUCA	KARATE DOJO UNTERMERZBACH		GER - GERMANY



Kumite Leistungsklasse -60/-67/-75kg männlich

1	SCHULTZ TRISTAN	KARATE DOJO UNTERMERZBACH		GER - GERMANY
2	STÜRMER NOAH	BUDOKAN 72 E.V.SCHWEINFURT		GER - GERMANY

OFFENE UNTERFRÄNKISCHE KARATE
BEZIRKSMEISTERSCHAFT & NEWCOMER
KARATE TURNIER 2024 - 2024-10-12

Official Results

3	JANSON PATRICK	TV/DJK HAMMELBURG		GER - GERMANY	
---	----------------	----------------------	---	---------------	--

Kumite Leistungsklasse -84/+84kg männlich					
1	SCHNEIDER PATRICK	KARATE DOJO UNTERMERZBACH		GER - GERMANY	
2	OLTMANN'S NIKLAS	TV FÜRTH 1860 E.V.		GER - GERMANY	
3	PETER BENJAMIN	KARATE DOJO UNTERMERZBACH		GER - GERMANY	
3	BERNINGER LARS	TV MÖMLINGEN KARATE DO ZANSHIN		GER - GERMANY	

Kumite Leistungsklasse Allkat. männlich					
1	SCHULTZ TRISTAN	KARATE DOJO UNTERMERZBACH		GER - GERMANY	
2	SCHNEIDER PATRICK	KARATE DOJO UNTERMERZBACH		GER - GERMANY	
3	OLTMANN'S NIKLAS	TV FÜRTH 1860 E.V.		GER - GERMANY	

Kumite Leistungsklasse Allkat. weiblich					
1	ROSTIAHAI HANNA	TG SCHWEINFURT 1848 E.V.		GER - GERMANY	
2	ROSTIAHAI HELENA	TG SCHWEINFURT 1848 E.V.		GER - GERMANY	
3	SCHNEIDER SELINA	KARATE DOJO UNTERMERZBACH		GER - GERMANY	
3	SCHMIDT-HAMMER LEA	KARATE DOJO UNTERMERZBACH		GER - GERMANY	

Kumite Leistungsklasse weiblich +68 kg					
1	SCHMIDT-HAMMER LEA	KARATE DOJO UNTERMERZBACH		GER - GERMANY	
2	HUBER SABRINA	TV 1875 BURGLENGENFELD EV		GER - GERMANY	

Kumite Leistungsklasse weiblich -68 kg					
1	ROSTIAHAI HELENA	TG SCHWEINFURT 1848 E.V.		GER - GERMANY	
2	ROSTIAHAI HANNA	TG SCHWEINFURT 1848 E.V.		GER - GERMANY	
3	SCHNEIDER SELINA	KARATE DOJO UNTERMERZBACH		GER - GERMANY	
3	URBAN LISA	KARATE DOJO NEUSTADT/WN		GER - GERMANY	

Kumite Masterklasse Ü30/Ü35 -80kg männlich					
1	JANSON PATRICK	TV/DJK HAMMELBURG		GER - GERMANY	
2	PETER BENJAMIN	KARATE DOJO UNTERMERZBACH		GER - GERMANY	
3	MÜNCH ARMIN	TV TRENNFURT		GER - GERMANY	

Kumite Masterklasse Ü45/Ü55/Ü65 +80kg männlich					
1	HEIM FRANK	FSV NEUSTADT/ ERLACH A. MAIN		GER - GERMANY	

OFFENE UNTERFRÄNKISCHE KARATE
BEZIRKSMEISTERSCHAFT & NEWCOMER
KARATE TURNIER 2024 - 2024-10-12

Official Results

2	KRUG GERALD	BUDOKAN 72 E.V.SCHWEINFURT		GER - GERMANY	
3	LUDWIG RAINER	BUDOKAN 72 E.V.SCHWEINFURT		GER - GERMANY	

Kumite Schüler A -40kg männlich

1	AL AWAIR ABEDALMUHAIMEN	TG SCHWEINFURT 1848 E.V.		GER - GERMANY	
2	KÖHLER FRIEDRICH	KARATE DOJO NAILA		GER - GERMANY	
3	RITTER BEN	KARATE DOJO NAILA		GER - GERMANY	

Kumite Schüler A -42/-47kg weiblich

1	BAYER NIKE EMILIE	KARATE DOJO UNTERMERZBACH		GER - GERMANY	
2	SCHULZ EVA	KARATE DOJO UNTERMERZBACH		GER - GERMANY	
3	EBERT NIA	TSV JAHN 1892 WÜRZBURG E.V.		GER - GERMANY	

Kumite Schüler A -45kg männlich

1	GRILLINGER JONAH	1. KEMPTENER KARATE DOJO IM TV KEMPTEN		GER - GERMANY	
2	ECKERDT DANIEL	TG SCHWEINFURT 1848 E.V.		GER - GERMANY	
3	XING LINUS	TG SCHWEINFURT 1848 E.V.		GER - GERMANY	
3	TAS BERKAY	BUDOKAN 72 E.V.SCHWEINFURT		GER - GERMANY	

Kumite Schüler A -50/-55kg männlich

1	STADICK TILL	TV FÜRTH 1860 E.V.		GER - GERMANY	
2	KUMMERER PAUL	SV ABENBERG		GER - GERMANY	

Kumite Schüler A -52/+52kg weiblich

1	KHALESS MARIELLE	TV FÜRTH 1860 E.V.		GER - GERMANY	
2	SCHUBERTH CARINA	KARATE DOJO NAILA		GER - GERMANY	

Kumite Schüler B +38kg männlich

1	YALCIN SEMIN	TV FÜRTH 1860 E.V.		GER - GERMANY	
2	SELL TOM	BUDOKAN 72 E.V.SCHWEINFURT		GER - GERMANY	
3	STREIT LUKAS	TG SCHWEINFURT 1848 E.V.		GER - GERMANY	
3	SCHRAMM JULIAN	TV FÜRTH 1860 E.V.		GER - GERMANY	
5	BÜTTNER LUKAS	SHOTOKAN BESSENBACH E.V.		GER - GERMANY	

Kumite Schüler B -32kg männlich

1	SEDLAK MATTEO	BUSHIDO COBURG E.V.		GER - GERMANY	
2	HELLMUTH MAXIMILIAN	BUSHIDO COBURG E.V.		GER - GERMANY	
3	BRUNNER MAX	BUSHIDO COBURG E.V.		GER - GERMANY	

OFFENE UNTERFRÄNKISCHE KARATE
BEZIRKSMEISTERSCHAFT & NEWCOMER
KARATE TURNIER 2024 - 2024-10-12

Official Results

3	LOHR CHRISTOPH	BUDOKAN 72 E.V.SCHWEINFURT		GER - GERMANY	
---	----------------	-------------------------------	---	---------------	--

Kumite Schüler B -38kg männlich

1	LEIDNER YANICK	TV FÜRTH 1860 E.V.		GER - GERMANY	
2	BLUM SEBASTIAN	SHOTOKAN BESSENBACH E.V.		GER - GERMANY	
3	TILLE LEO	TG SCHWEINFURT 1848 E.V.		GER - GERMANY	
3	WAGNER MAXIMILIAN	KARATE DOJO UNTERMERZBACH		GER - GERMANY	
5	KRUZEL JOSHUA	KARATE DOJO UNTERMERZBACH		GER - GERMANY	

Kumite Team Jugend/Junioren weiblich

1	KD UNTERMERZBACH - SCHNEIDER SELINA - SCHNABEL MIRA - SCHNABEL MIA	KARATE DOJO UNTERMERZBACH		GER - GERMANY	
2	BUDOKAN 72 E.V.SCHWEINFURT - MAUER MARINA - MAUER STELLA - MORINA LONA	BUDOKAN 72 E.V.SCHWEINFURT		GER - GERMANY	
3	BUDOKAN 72 E.V.SCHWEINFURT - LOHR VIKTORIA - PÖHLMANN SOPHIE - STÜRMER MARIE	BUDOKAN 72 E.V.SCHWEINFURT		GER - GERMANY	

Kumite Team Schüler A&B männlich

1	BUSHIDO COBURG E.V. - BRUNNER MAX - HELLMUTH MAXIMILIAN - SEDLAK MATTEO	BUSHIDO COBURG E.V.		GER - GERMANY	
2	TG SCHWEINFURT 1848 E.V. - 2 - XING LINUS - TROGISCH JONAH - STREIT LUKAS	TG SCHWEINFURT 1848 E.V.		GER - GERMANY	
3	KD UNTERMERZBACH - HAUCK OTTO - KRUZEL JOSHUA - WAGNER MAXIMILIAN	KARATE DOJO UNTERMERZBACH		GER - GERMANY	
3	TV FÜRTH 1860 E.V. - LEIDNER YANICK - SCHRAMM JULIAN - STADICK TILL - YALCIN SEMIN	TV FÜRTH 1860 E.V.		GER - GERMANY	

Kumite Team Schüler A&B weiblich

1	KD UNTERMERZBACH - BAYER NIKE_EMILIE - DÜNISCH THERESA - SCHULZ EVA	KARATE DOJO UNTERMERZBACH		GER - GERMANY	
2	TV FÜRTH 1860 E.V. - MEYER SINAH - KHALESS MARIELLE - BÖCKELMANN AMELIE	TV FÜRTH 1860 E.V.		GER - GERMANY	

OFFENE UNTERFRÄNKISCHE KARATE
BEZIRKSMEISTERSCHAFT & NEWCOMER
KARATE TURNIER 2024 - 2024-10-12

Official Results

Newcomer Kata Kinder A 7.-6. Kyu mixed				
1	KAMPHAUSEN MARIE	SPORTSCHULE KAIZEN NÜRNBERG		GER - GERMANY
2	CEYLAN SÜMEYYE	SV UNSU KARATE MÖMLINGEN E.V.		GER - GERMANY
3	RIEMENSPEGER KATHARINA	TSV JAHN 1892 WÜRZBURG E.V.		GER - GERMANY
3	GRANZOW IDA MARIE	SV UNSU KARATE MÖMLINGEN E.V.		GER - GERMANY
5	ZIMMERMANN JOSEF	TV TRENNFURT		GER - GERMANY
5	MEINFELDER LINA	KARATE DOJO UNTERMERZBACH		GER - GERMANY

Newcomer Kata Kinder A 9.-8.Kyu männlich				
1	MANIYUR PRAVEEN SAHARSH	TSV JAHN 1892 WÜRZBURG E.V.		GER - GERMANY
2	MÜLLICH LUCA	KARATE DOJO UNTERMERZBACH		GER - GERMANY
3	FISCHER LUCA	KARATE DOJO UNTERMERZBACH		GER - GERMANY
5	HÜMMER LEVIN	KARATE DOJO UNTERMERZBACH		GER - GERMANY

Newcomer Kata Kinder A 9.-8.Kyu weiblich				
1	ÖZLÜOĞLU BEGÜM	SV UNSU KARATE MÖMLINGEN E.V.		GER - GERMANY
2	ÖZLÜOĞLU BETÜL	SV UNSU KARATE MÖMLINGEN E.V.		GER - GERMANY
3	GAUTAM AASTHA	FSV NEUSTADT/ ERLACH A. MAIN		GER - GERMANY

Newcomer Kata Kinder B 9.-8.Kyu männlich				
1	SCHMIDT BENEDIKT	BUSHIDO COBURG E.V.		GER - GERMANY
2	BAYER KARL	KARATE DOJO UNTERMERZBACH		GER - GERMANY
3	PELNY JOHN	KARATE DOJO UNTERMERZBACH		GER - GERMANY



Newcomer Kata Kinder B 9.-8.Kyu weiblich				
1	GÜNLÜ ALAARA	SV UNSU KARATE MÖMLINGEN E.V.		GER - GERMANY
2	PLATE MILA	BUSHIDO COBURG E.V.		GER - GERMANY
3	MORGENROTH LENA	KARATE DOJO UNTERMERZBACH		GER - GERMANY
3	HELLMUTH ORNELA	BUSHIDO COBURG E.V.		GER - GERMANY

Newcomer Kata Schüler A 7.-6. Kyu mixed				
1	GRANZOW MIA	SV UNSU KARATE MÖMLINGEN E.V.		GER - GERMANY
2	ANDRESEN LASSE	KARATE DOJO NAILA		GER - GERMANY
3	DWORAK MELINA	TSV JAHN 1892 WÜRZBURG E.V.		GER - GERMANY
3	EBERT NIA	TSV JAHN 1892 WÜRZBURG E.V.		GER - GERMANY

OFFENE UNTERFRÄNKISCHE KARATE
BEZIRKSMEISTERSCHAFT & NEWCOMER
KARATE TURNIER 2024 - 2024-10-12

Official Results

Newcomer Kata Schüler A 9.-8. Kyu mixed				
1	DREXLER NEO	FSV NEUSTADT/ ERLACH A. MAIN		GER - GERMANY
2	THOME HANNAH	KARATE DOJO UNTERMERZBACH		GER - GERMANY
3	GÜNTHER LAURIN	FSV NEUSTADT/ ERLACH A. MAIN		GER - GERMANY
3	FELIX MOOS	FSV NEUSTADT/ ERLACH A. MAIN		GER - GERMANY

Newcomer Kata Schüler B 7.-6. Kyu mixed				
1	BAYERLIEB KIM	BUSHIDO COBURG E.V.		GER - GERMANY
2	SENDLER LINA	TV TRENNFURT		GER - GERMANY
3	BARBONI CHRISTINA	BUSHIDO COBURG E.V.		GER - GERMANY
3	GAUTAM AVI	FSV NEUSTADT/ ERLACH A. MAIN		GER - GERMANY
5	KRUZEL JOSHUA	KARATE DOJO UNTERMERZBACH		GER - GERMANY

Newcomer Kata Schüler B 9.-8. Kyu männlich				
1	SCHMIDT NEVIO	BUSHIDO COBURG E.V.		GER - GERMANY
2	EBERT TILMAN	TSV JAHN 1892 WÜRZBURG E.V.		GER - GERMANY
3	LEICHTENSCHLAG LIAM	FSV NEUSTADT/ ERLACH A. MAIN		GER - GERMANY
3	ENDRES MANUEL	FSV NEUSTADT/ ERLACH A. MAIN		GER - GERMANY
5	WAGNER MAXIMILIAN	KARATE DOJO UNTERMERZBACH		GER - GERMANY
5	HAUCK OTTO	KARATE DOJO UNTERMERZBACH		GER - GERMANY

Newcomer Kata Schüler B 9.-8. Kyu weiblich				
1	HEIM JANA	FSV NEUSTADT/ ERLACH A. MAIN		GER - GERMANY
2	LANDSITTEL KATHARINA	FSV NEUSTADT/ ERLACH A. MAIN		GER - GERMANY
3	REINHARDT AURELIA	TV TRENNFURT		GER - GERMANY

Newcomer Kumite Kinder A weiblich				
1	ERHART KLARA	TG SCHWEINFURT 1848 E.V.		GER - GERMANY
2	LI JINGNI	TG SCHWEINFURT 1848 E.V.		GER - GERMANY
3	SCHNELLBÖGL RONJA	KARATE DOJO NAILA		GER - GERMANY
3	ZHOU FIONA FEIYAO	TG SCHWEINFURT 1848 E.V.		GER - GERMANY

Newcomer Kumite Kinder A -30 kg männlich				
1	BAYER KURT	KARATE DOJO UNTERMERZBACH		GER - GERMANY
2	MANIYUR PRAVEEN SAHARSH	TSV JAHN 1892 WÜRZBURG E.V.		GER - GERMANY

OFFENE UNTERFRÄNKISCHE KARATE
BEZIRKSMEISTERSCHAFT & NEWCOMER
KARATE TURNIER 2024 - 2024-10-12

Official Results

3	HÜMMER LEVIN	KARATE DOJO UNTERMERZBACH		GER - GERMANY	
3	MÜLLICH LUCA	KARATE DOJO UNTERMERZBACH		GER - GERMANY	

Newcomer Kumite Kinder A -35 kg männlich

1	RÖSSNER FELIX	KARATE DOJO UNTERMERZBACH		GER - GERMANY	
2	VOINU ANDY	KARATE DOJO NAILA		GER - GERMANY	
3	FISCHER LUCA	KARATE DOJO UNTERMERZBACH		GER - GERMANY	

Newcomer Kumite Kinder A -40/+40kg männlich

1	WIESSNER ALBERT	KARATE DOJO NAILA		GER - GERMANY	
2	KLAUS MAXIMILIAN	KARATE DOJO UNTERMERZBACH		GER - GERMANY	

Newcomer Kumite Kinder B -25 kg männlich

1	BAYER KARL	KARATE DOJO UNTERMERZBACH		GER - GERMANY	
2	SCHMIDT BENEDIKT	BUSHIDO COBURG E.V.		GER - GERMANY	

Newcomer Kumite Kinder B weiblich

1	PLATE MILA	BUSHIDO COBURG E.V.		GER - GERMANY	
2	HELLMUTH ORNELA	BUSHIDO COBURG E.V.		GER - GERMANY	
3	LUTHARDT LEA	BUSHIDO COBURG E.V.		GER - GERMANY	

Newcomer Kumite Schüler A -40 kg männlich

1	RITTER BEN	KARATE DOJO NAILA		GER - GERMANY	
2	AL AWAIR ABEDALMUHAIMEN	TG SCHWEINFURT 1848 E.V.		GER - GERMANY	
3	KÖHLER FRIEDRICH	KARATE DOJO NAILA		GER - GERMANY	

Newcomer Kumite Schüler A -45 kg männlich

1	XING LINUS	TG SCHWEINFURT 1848 E.V.		GER - GERMANY	
2	BERWIND MALTE	KARATE DOJO UNTERMERZBACH		GER - GERMANY	

Newcomer Kumite Schüler A -50/+55kg männlich



1	KUMMERER PAUL	SV ABENBERG		GER - GERMANY	
2	TAS BERKAY	BUDOKAN 72 E.V.SCHWEINFURT		GER - GERMANY	

Newcomer Kumite Schüler A weiblich

1	SCHULZ EVA	KARATE DOJO UNTERMERZBACH		GER - GERMANY	
2	BAYER NIKE EMILIE	KARATE DOJO UNTERMERZBACH		GER - GERMANY	
3	EBERT NIA	TSV JAHN 1892 WÜRZBURG E.V.		GER - GERMANY	
3	SCHUBERTH CARINA	KARATE DOJO NAILA		GER - GERMANY	

OFFENE UNTERFRÄNKISCHE KARATE
BEZIRKSMEISTERSCHAFT & NEWCOMER
KARATE TURNIER 2024 - 2024-10-12

Official Results

Newcomer Kumite Schüler B +36 kg weiblich				
1	BAYERLIEB KIM	BUSHIDO COBURG E.V.		GER - GERMANY
2	RAUSCH SOPHIE	TG SCHWEINFURT 1848 E.V.		GER - GERMANY
3	SCHÄFER SOPHIE	SHOTOKAN BESSENBACH E.V.		GER - GERMANY

Newcomer Kumite Schüler B +38 kg männlich				
1	SELL TOM	BUDOKAN 72 E.V.SCHWEINFURT		GER - GERMANY
2	BÜTTNER ANTON	KARATE DOJO UNTERMERZBACH		GER - GERMANY
3	TROGISCH JONAH	TG SCHWEINFURT 1848 E.V.		GER - GERMANY
3	WACK HANNES	SV ABENBERG		GER - GERMANY

Newcomer Kumite Schüler B -30/-36kg weiblich				
1	KUSNEZOV VANESSA	KARATE DOJO NAILA		GER - GERMANY
2	BARBONI CHRISTINA	BUSHIDO COBURG E.V.		GER - GERMANY

Newcomer Kumite Schüler B -32 kg männlich				
1	EBERT TILMAN	TSV JAHN 1892 WÜRZBURG E.V.		GER - GERMANY
2	LOHR CHRISTOPH	BUDOKAN 72 E.V.SCHWEINFURT		GER - GERMANY

Newcomer Kumite Schüler B -38 kg männlich				
1	TILLE LEO	TG SCHWEINFURT 1848 E.V.		GER - GERMANY
2	BLUM SEBASTIAN	SHOTOKAN BESSENBACH E.V.		GER - GERMANY
3	HAUCK OTTO	KARATE DOJO UNTERMERZBACH		GER - GERMANY
3	KRUZEL JOSHUA	KARATE DOJO UNTERMERZBACH		GER - GERMANY
5	WAGNER MAXIMILIAN	KARATE DOJO UNTERMERZBACH		GER - GERMANY

OFFENE UNTERFRÄNKISCHE KARATE
BEZIRKSMEISTERSCHAFT & NEWCOMER
KARATE TURNIER 2024 - 2024-10-12

Medals - Club

Rank	Club	1. Place	2. Place	3. Place
1	 KARATE DOJO UNTERMERZBACH, GER	14	17	23
2	 BUSHIDO COBURG E.V., GER	8	5	4
3	 SV UNSU KARATE MÖMLINGEN E.V., GER	8	3	5
4	 TG SCHWEINFURT 1848 E.V., GER	7	7	6
5	 TV FÜRTH 1860 E.V., GER	7	3	4
6	 KARATE DOJO NAILA, GER	4	6	7
7	 SPORTSCHULE KAIZEN NÜRNBERG, GER	4	3	2
8	 FSV NEUSTADT/ERLACH A. MAIN, GER	4	1	7
9	 BUDOKAN 72 E.V.SCHWEINFURT, GER	3	6	7
10	 TSV JAHN 1892 WÜRZBURG E.V., GER	2	5	10
11	 POST SV BAMBERG, GER	2	2	1
12	 TV 1875 BURGLENGENFELD EV, GER	2	1	1
13	 1. KEMPTENER KARATE DOJO IM TV KEMPTEN, GER	2	1	0
14	 TV TRENNFURT, GER	1	3	5
15	 SV ABENBERG, GER	1	1	2
16	 TV/DJK HAMMELBURG, GER	1	1	1
	 SGS ERLANGEN KARATE E.V., GER	1	1	1
18	 SHOTOKAN BESSENACH E.V., GER	0	2	3
19	 TUS FEUCHTWANGEN, GER	0	2	1
20	 KARATE-AKADEMIE REGENSBURG, GER	0	1	0
21	 TSV WEMDING 1892 E. V., GER	0	0	1
	 TV MÖMLINGEN KARATE DO ZANSHIN, GER	0	0	1
	 KARATE DOJO NEUSTADT/WN, GER	0	0	1