

EMIRATES SPORTS KARATE OPEN

2023.03.03 - 2023.03.05

SHARJAH

UNITED ARAB EMIRATES, UAE



EMIRATES SPORTS KARATE OPEN

UNITED ARAB EMIRATES
SHARJAH

2023.03.03 - 2023.03.05



NUMBER OF ENTRIES

#	Code	Country	Male Entries	Female Entries	Total Entries	Total Athletes
1	ALG	ALGERIA	2	0	2	2
2	AZE	AZERBAIJAN	17	4	21	21
3	BRN	BAHRAIN	5	2	7	6
4	BLR	BELARUS	4	4	8	8
5	EGY	EGYPT	7	0	7	6
6	IND	INDIA	1	6	7	4
7	JOR	JORDAN	3	6	9	8
8	KUW	KUWAIT	28	7	35	29
9	NEP	NEPAL	8	6	14	14
10	PAK	PAKISTAN	0	1	1	1
11	PHI	PHILIPPINES	16	7	23	14
12	QAT	QATAR	5	0	5	4
13	RUS	RUSSIAN FEDERATION	33	30	63	56
14	KSA	SAUDI ARABIA	10	0	10	9
15	SUD	SUDAN	4	2	6	6
16	UAE	UNITED ARAB EMIRATES	233	129	362	324
17	UZB	UZBEKISTAN	20	1	21	21
Totals:			396	205	601	533



EMIRATES SPORTS KARATE OPEN

UNITED ARAB EMIRATES
SHARJAH

2023.03.03 - 2023.03.05



ENTRY LIST

ALG - ALGERIA				
ID	Gender	Family Name	Given Name	Event
	Male	YOUCEF	MOKRANI	Cadet Kata Male
	Male	NIZAR	MOKRANI	Cadet Kata Male

Entries: 2



EMIRATES SPORTS KARATE OPEN

UNITED ARAB EMIRATES
SHARJAH

2023.03.03 - 2023.03.05



ENTRY LIST

AZE - AZERBAIJAN				
ID	Gender	Family Name	Given Name	Event
	Male	ABBASLI	AMIL	U14 KUMITE MALE +55 KG
	Male	ABBASOV	RASUL	JUNIOR KUMITE MALE -61 KG
	Male	ALIYEV	FARHAD	KIDS KUMITE MALE 8 YEARS
	Male	ALMURADLI	SHAHIN	KIDS KUMITE MALE 10 YEARS
	Male	ASKEROV	DIAS	U14 KUMITE MALE -40 KG
	Male	AZIZLI	VUGAR	U14 KUMITE MALE -55 KG
	Male	BAGHIROV	ELDAR	U14 KUMITE MALE -40 KG
	Male	BILALOV	NIJAT	KIDS KUMITE MALE 11 YEARS
	Male	GURBANLI	ELDAR	KIDS KUMITE MALE 10 YEARS
	Male	HUSEYNZADE	ALI	U14 KUMITE MALE -50 KG
	Male	ISMAYILOV	MUSA	KIDS KUMITE MALE 10 YEARS
	Male	JAFARZADE	ZAKI	JUNIOR KUMITE MALE -76 KG
	Male	MAMMADOV	SAMIR	SENIOR KUMITE MALE -84 KG
	Male	MUKHTARZADE	HUSEYN	CADET KUMITE MALE -52 KG
	Male	MURADOV	DAVUD	JUNIOR KUMITE MALE -68 KG
	Male	NABIYEV	TURAL	U14 KUMITE MALE -40 KG
	Male	TALIBOV	ALI	U14 KUMITE MALE -45 KG
	Female	ASGAROVA	AGHGUL	CADET KUMITE FEMALE -61 KG
	Female	HASANLI	HUMAY	SENIOR KUMITE FEMALE 68+ KG
	Female	MURSALOVA	KHADIJA	U14 KUMITE FEMALE -52 KG
	Female	VALIZADA	KHADIJA	JUNIOR KUMITE FEMALE -59 KG

Entries: 21



EMIRATES SPORTS KARATE OPEN

UNITED ARAB EMIRATES
SHARJAH

2023.03.03 - 2023.03.05



ENTRY LIST

BRN - BAHRAIN				
ID	Gender	Family Name	Given Name	Event
	Male	Ahmed abdulkarim	Mohammed	JUNIOR KUMITE MALE -68 KG
	Male	Ayman Mousa	Mohanad	U14 KUMITE MALE +55 KG
	Male	Ayman Mousa	Mohanad	U14 Kata Male
	Male	Jamal Albalooshi	Sam	JUNIOR KUMITE MALE -68 KG
	Male	Showaiter	Zakariya	U14 KUMITE MALE -45 KG
	Female	ahmed raza	Salwa	JUNIOR KUMITE FEMALE -59 KG
	Female	yousif Shanbaih	Fatima	SENIOR KUMITE FEMALE -50 KG

Entries: 7



EMIRATES SPORTS KARATE OPEN

UNITED ARAB EMIRATES
SHARJAH

2023.03.03 - 2023.03.05



ENTRY LIST

 BLR - BELARUS				
ID	Gender	Family Name	Given Name	Event
	Male	Kiryievich	Mikita	SENIOR KUMITE MALE -84 KG
	Male	Melyokhin	Oleg	SENIOR KUMITE MALE -60 KG
	Male	Nhuyen	Devid	SENIOR KUMITE MALE -75 KG
	Male	Sachkouski	Hleb	SENIOR KUMITE MALE -75 KG
	Female	Aliakseyeva	Maryia	SENIOR KUMITE FEMALE -68 KG
	Female	Azarava	Maryia	SENIOR KUMITE FEMALE -61 KG
	Female	Baravik	Veranika	Senior kata female
	Female	Sharykhina	Irina	SENIOR KUMITE FEMALE -55 KG

Entries: 8

EMIRATES SPORTS KARATE OPEN

UNITED ARAB EMIRATES
SHARJAH

2023.03.03 - 2023.03.05



ENTRY LIST

 EGY - EGYPT				
ID	Gender	Family Name	Given Name	Event
	Male	ABDELMENEM	BRAA	SENIOR KUMITE MALE -60 KG
	Male	Dalati	Hamza	U14 Kata Male
	Male	ELSAYED	AHMED	JUNIOR KUMITE MALE -61 KG
	Male	GALAL	AASEM	Junior Kata Male
	Male	GALAL	AASEM	JUNIOR KUMITE MALE -68 KG
	Male	KHALED	GAMAL	JUNIOR KUMITE MALE -55 KG
	Male	YASSER	MOHAMED	CADET KUMITE MALE -57 KG

Entries: 7

EMIRATES SPORTS KARATE OPEN

UNITED ARAB EMIRATES
SHARJAH

2023.03.03 - 2023.03.05



ENTRY LIST

 IND - INDIA				
ID	Gender	Family Name	Given Name	Event
	Male	GUPTA	ANIKET	Senior kata male
	Female	JOSHI	MIMANSHA	Junior Kata Female
	Female	JOSHI	MIMANSHA	JUNIOR KUMITE FEMALE -48 KG
	Female	RAO	VAANYA	U14 Kata Female
	Female	RAO	VAANYA	U14 KUMITE FEMALE -52 KG
	Female	VERMA	AKANKSHA	SENIOR KUMITE FEMALE -50 KG
	Female	VERMA	AKANKSHA	Senior kata female

Entries: 7



EMIRATES SPORTS KARATE OPEN

UNITED ARAB EMIRATES
SHARJAH

2023.03.03 - 2023.03.05



ENTRY LIST

 JOR - JORDAN				
ID	Gender	Family Name	Given Name	Event
	Male	RAMI	BAHI	KIDS KATA MALE 6 - 7 YEARS
	Male	RAMI	DHAY	KIDS KATA MALE 8 - 9 YEARS
	Male	Rami	Kareem	CADET KUMITE MALE -70 KG
	Female	KHALID	ROOH	CADET KUMITE FEMALE -47 KG
	Female	TAREQ	BERNADETTE	KIDS KATA FEMALE 8 - 9 YEARS
	Female	TAREQ	BERNADETTE	KIDS KUMITE FEMALE 9 YEARS
	Female	TAREQ	LEMAR	U14 Kata Female
	Female	TAREQ	MAYA	Junior Kata Female
	Female	TAREQ	NATTALY	CADET KUMITE FEMALE -47 KG

Entries: 9



EMIRATES SPORTS KARATE OPEN

UNITED ARAB EMIRATES
SHARJAH

2023.03.03 - 2023.03.05



ENTRY LIST

 KUW - KUWAIT				
ID	Gender	Family Name	Given Name	Event
	Male	Abbas	Hamad	KIDS KUMITE MALE 9 YEARS
	Male	Ahimad	Yousef	KIDS KUMITE MALE 10 YEARS
	Male	Ahmadi	Ali	U14 Kata Male
	Male	Ahmadi	Ali	U14 KUMITE MALE -40 KG
	Male	ALAli	Yaqoub	KIDS KUMITE MALE 8 YEARS
	Male	ALBlushi	Naser	KIDS KATA MALE 8 - 9 YEARS
	Male	AlHarbi	Jaber	SENIOR KUMITE MALE -84 KG
	Male	ALHashash	Waleed	KIDS KUMITE MALE 8 YEARS
	Male	AlJazzaf	Ali	KIDS KUMITE MALE 7 YEARS
	Male	AlJazzaf	Ali	KIDS KATA MALE 6 - 7 YEARS
	Male	ALKandari	Hasan	KIDS KUMITE MALE 7 YEARS
	Male	ALMejady	Ali	JUNIOR KUMITE MALE -68 KG
	Male	ALMejady	Ali	Junior Kata Male
	Male	ALNajem	Abdulateef	KIDS KUMITE MALE 8 YEARS
	Male	ALObaid	Yaqoub	KIDS KUMITE MALE 8 YEARS
	Male	Alsabaghah	Ali	KIDS KUMITE MALE 10 YEARS
	Male	ALSarraf	Dawoud	U14 KUMITE MALE -40 KG
	Male	ALShwaiker	Abdulaziz	KIDS KUMITE MALE 7 YEARS
	Male	ALShwaiker	Abdullah	KIDS KATA MALE 8 - 9 YEARS
	Male	ALShwaiker	Abdullah	KIDS KUMITE MALE 9 YEARS
	Male	Busakher	Yousef	KIDS KUMITE MALE 11 YEARS
	Male	Haidar	Mohammad	KIDS KATA MALE 10 - 11 YEARS
	Male	Haidar	Mohammad	KIDS KATA MALE 8 - 9 YEARS
	Male	Husain	Meqdad	Senior kata male
	Male	Husain	Mohammad	KIDS KUMITE MALE 8 YEARS
	Male	Rajab	Hamza	KIDS KUMITE MALE 7 YEARS
	Male	Saleem	Eissa	CADET KUMITE MALE -57 KG
	Male	Sarkhouh	Abbas	SENIOR KUMITE MALE -75 KG
	Female	Ahmad	Haneen	CADET KUMITE FEMALE -47 KG
	Female	ALAdsani	Nourah	KIDS KATA FEMALE 8 - 9 YEARS
	Female	ALAli	Dana	KIDS KUMITE FEMALE 11 YEARS
	Female	ALAli	Dana	KIDS KATA FEMALE 10 - 11 YEARS
	Female	ALKanderi	Zainab	CADET KUMITE FEMALE -47 KG
	Female	ALQattan	Sara	KIDS KATA FEMALE 6 - 7 YEARS
	Female	Wahidi	Zainab	Senior kata female

Entries: 35



EMIRATES SPORTS KARATE OPEN

UNITED ARAB EMIRATES
SHARJAH

2023.03.03 - 2023.03.05



ENTRY LIST

NEP - NEPAL				
ID	Gender	Family Name	Given Name	Event
	Male	G. C.	Ram Kumar	SENIOR KUMITE MALE -75 KG
	Male	Khadka	Mandip	SENIOR KUMITE MALE -84 KG
	Male	Nepal	Prem Prasad	SENIOR KUMITE MALE -60 KG
	Male	Paija	Ganesh	SENIOR KUMITE MALE -60 KG
	Male	Sah	Shree Kishun	SENIOR KUMITE MALE -75 KG
	Male	Tamang	Amrit	SENIOR KUMITE MALE 84+ KG
	Male	Tamang	Dev Kumar	SENIOR KUMITE MALE -60 KG
	Male	Thapa	Mohanlal	SENIOR KUMITE MALE 84+ KG
	Female	Dhungel	Rojita	SENIOR KUMITE FEMALE 68+ KG
	Female	Shrestha	Binita	SENIOR KUMITE FEMALE -68 KG
	Female	Shrestha	Sonu	SENIOR KUMITE FEMALE -50 KG
	Female	Tamang	Binu maya	JUNIOR KUMITE FEMALE -59 KG
	Female	Tamang	Nirupa	SENIOR KUMITE FEMALE -61 KG
	Female	Waiba	Susmita	SENIOR KUMITE FEMALE -55 KG

Entries: 14



EMIRATES SPORTS KARATE OPEN

UNITED ARAB EMIRATES
SHARJAH

2023.03.03 - 2023.03.05



ENTRY LIST

PAK - PAKISTAN				
ID	Gender	Family Name	Given Name	Event
	Female	BHIDWAL	FATIMA AAMIR	KIDS KATA FEMALE 10 - 11 YEARS

Entries: 1



EMIRATES SPORTS KARATE OPEN

UNITED ARAB EMIRATES
SHARJAH

2023.03.03 - 2023.03.05



ENTRY LIST

 PHI - PHILIPPINES				
ID	Gender	Family Name	Given Name	Event
	Male	Berjamin	Yohan Dale	KIDS KUMITE MALE 7 YEARS
	Male	Caballero	Ethan Christopher	U14 Kata Male
	Male	Caballero	Ethan Christopher	U14 KUMITE MALE +55 KG
	Male	Croox	Michael Johann	U14 Kata Male
	Male	Croox	Scott Ceasar	KIDS KATA MALE 8 - 9 YEARS
	Male	Cruz	Lance Journey Ezekiel	Cadet Kata Male
	Male	Cruz	Lance Journey Ezekiel	CADET KUMITE MALE -63 KG
	Male	Cruz	Zach Hashlee	U14 KUMITE MALE -55 KG
	Male	Cruz	Zach Hashlee	U14 Kata Male
	Male	Reginio	Jes Joseph	CADET KUMITE MALE -57 KG
	Male	Reginio	Jes Joseph	Cadet Kata Male
	Male	Salcedo	Tristan Luis Raphael	U14 KUMITE MALE +55 KG
	Male	Salcedo	Tristan Luis Raphael	U14 Kata Male
	Male	Soriano	Avery Rosh	KIDS KATA MALE 8 - 9 YEARS
	Male	Soriano	Avery Rosh	KIDS KUMITE MALE 9 YEARS
	Male	Yaser Ali	Abdelrahman	KIDS KUMITE MALE 11 YEARS
	Female	Bayani	Chantal Yuri	U14 KUMITE FEMALE 52+ KG
	Female	Bayani	Chantal Yuri	U14 Kata Female
	Female	Caballero	Yvonne Bethany	KIDS KATA FEMALE 8 - 9 YEARS
	Female	Caballero	Yvonne Bethany	KIDS KUMITE FEMALE 9 YEARS
	Female	Magbitang	Maegan Jyll	KIDS KUMITE FEMALE 9 YEARS
	Female	Paguio	Gabrielle	Cadet Kata Female
	Female	Paguio	Gabrielle	CADET KUMITE FEMALE -54 KG

Entries: 23

EMIRATES SPORTS KARATE OPEN

UNITED ARAB EMIRATES
SHARJAH

2023.03.03 - 2023.03.05



ENTRY LIST

QAT - QATAR				
ID	Gender	Family Name	Given Name	Event
	Male	AL-SHOULI	YOUSEF	KIDS KUMITE MALE 8 YEARS
	Male	AL-SHOULI	YOUSEF	KIDS KATA MALE 8 - 9 YEARS
	Male	ALI	MAHMUD HAMDI	KIDS KUMITE MALE 10 YEARS
	Male	HAMDI ALI	MOHAMED	U14 KUMITE MALE +55 KG
	Male	MOHAMMAD DHAHER	HASHEM	U14 KUMITE MALE +55 KG

Entries: 5



EMIRATES SPORTS KARATE OPEN

UNITED ARAB EMIRATES
SHARJAH

2023.03.03 - 2023.03.05



ENTRY LIST

 RUS - RUSSIAN FEDERATION				
ID	Gender	Family Name	Given Name	Event
	Male	Akhmedov	Akhmed	SENIOR KUMITE MALE -67 KG
	Male	Akhmetov	Evgenii	KIDS KATA MALE 8 - 9 YEARS
	Male	Akhmetov	Evgenii	KIDS KUMITE MALE 9 YEARS
	Male	Akhmetov	Evgenii	KIDS KATA MALE 10 - 11 YEARS
	Male	ALIKHADZHIEV	KERIM	SENIOR KUMITE MALE -60 KG
	Male	ASKAROV	RINAT	CADET KUMITE MALE -52 KG
	Male	Belonogov	Kirill	SENIOR KUMITE MALE 84+ KG
	Male	Berezin	Anton	KIDS KATA MALE 6 - 7 YEARS
	Male	Berezin	Daniil	Cadet Kata Male
	Male	BOIKO	IVAN	U14 Kata Male
	Male	Kamalidinov	Zamil	U14 KUMITE MALE -40 KG
	Male	Kamyshev	Daniil	SENIOR KUMITE MALE 84+ KG
	Male	KARSALOV	ARTEMII	CADET KUMITE MALE -52 KG
	Male	KHALILOV	AMIR	JUNIOR KUMITE MALE -61 KG
	Male	Kibirev	Pavel	U14 KUMITE MALE -40 KG
	Male	KOLTUKHCHIAN	GOR	KIDS KUMITE MALE 11 YEARS
	Male	Kovalev	Kirill	SENIOR KUMITE MALE 84+ KG
	Male	LARIN	IVAN	Senior kata male
	Male	MURATOV	ARSENI	JUNIOR KUMITE MALE -55 KG
	Male	PEREVOZCHIKOV	TIMUR	U14 KUMITE MALE -40 KG
	Male	PEREVOZCHIKOV	TIMUR	U14 Kata Male
	Male	Razvalov	Nikolai	U14 Kata Male
	Male	Razvalov	Nikolai	KIDS KATA MALE 10 - 11 YEARS
	Male	Selezenev	Matvei	CADET KUMITE MALE -63 KG
	Male	SHAISHIAN	LEVON	U14 KUMITE MALE -55 KG
	Male	SHARAFUTDINOV	ERNEST	SENIOR KUMITE MALE -75 KG
	Male	SHULGIN	LEV	KIDS KUMITE MALE 10 YEARS
	Male	Spivak	Mikhail	CADET KUMITE MALE -52 KG
	Male	Stanichnov	Daniila	JUNIOR KUMITE MALE -61 KG
	Male	Stanichnov	Kirill	U14 KUMITE MALE -55 KG
	Male	Tuminov	Matvei	U14 KUMITE MALE +55 KG
	Male	ZHADANOV	EVGENII	U14 KUMITE MALE -40 KG
	Male	ZHADANOV	EVGENII	U14 Kata Male
	Female	AFSHAR	SOFI	KIDS KATA FEMALE 10 - 11 YEARS
	Female	AKSENOVA	VARVARA	CADET KUMITE FEMALE -54 KG
	Female	ARAPOVA	ALINA	CADET KUMITE FEMALE -47 KG
	Female	Chernysheva	Anna	SENIOR KUMITE FEMALE -55 KG
	Female	DANILOVA	SOFIA	U14 KUMITE FEMALE 52+ KG
	Female	DAVYDOVA	VIKTORIIA	JUNIOR KUMITE FEMALE -48 KG
	Female	Filiukova	Natalia	Senior kata female
	Female	Grigoreva	Elizaveta	SENIOR KUMITE FEMALE -50 KG
	Female	KARIMOVA	MUSAINNA	KIDS KUMITE FEMALE 7 YEARS
	Female	Khalimova	Sunita	SENIOR KUMITE FEMALE 68+ KG
	Female	Khokhlova	Karina	SENIOR KUMITE FEMALE -61 KG
	Female	Khozyaeva	Valeriya	Senior kata female
	Female	Kibireva	Alexandra	KIDS KATA FEMALE 10 - 11 YEARS
	Female	Kibireva	Alexandra	KIDS KATA FEMALE 8 - 9 YEARS



EMIRATES SPORTS KARATE OPEN

UNITED ARAB EMIRATES
SHARJAH

2023.03.03 - 2023.03.05



ENTRY LIST

	Female	KUDRIAVTSEVA	ANNA	SENIOR KUMITE FEMALE -68 KG
	Female	Labatsevich	Alina	U14 KUMITE FEMALE -47 KG
	Female	Labatsevich	Alisa	JUNIOR KUMITE FEMALE -59 KG
	Female	MANNANOVA	SAFIIA	KIDS KUMITE FEMALE 11 YEARS
	Female	Mecheryakova	Margarita	SENIOR KUMITE FEMALE -55 KG
	Female	Meshkova	Aleksandra	SENIOR KUMITE FEMALE -68 KG
	Female	Perevozchikova	Anna	SENIOR KUMITE FEMALE -55 KG
	Female	Piriazeva	Viktoriiia	Cadet Kata Female
	Female	Piriazeva	Viktoriiia	U14 Kata Female
	Female	Rodina	Anna	SENIOR KUMITE FEMALE -61 KG
	Female	SADYKOVA	AIGUL	JUNIOR KUMITE FEMALE -53 KG
	Female	Shcherbina	Anna	Senior kata female
	Female	Stadnik	Valeriiia	SENIOR KUMITE FEMALE -68 KG
	Female	Staroseltseva	Milana	SENIOR KUMITE FEMALE -61 KG
	Female	Zotova	Maria	Senior kata female
	Male	OZODA	nuridinova	SENIOR KUMITE FEMALE -55 KG

Entries: **63**

EMIRATES SPORTS KARATE OPEN

UNITED ARAB EMIRATES
SHARJAH

2023.03.03 - 2023.03.05



ENTRY LIST

KSA - SAUDI ARABIA				
ID	Gender	Family Name	Given Name	Event
	Male	Al-Awashes	Abdullah	CADET KUMITE MALE -63 KG
	Male	Al-Malehi	Faisal	CADET KUMITE MALE 70+ KG
	Male	Al-Maliki	Abdulaziz	CADET KUMITE MALE -52 KG
	Male	Al-Zahrani	Azzam	CADET KUMITE MALE -70 KG
	Male	Alkhathami	Rayan	CADET KUMITE MALE -52 KG
	Male	alkhthami	abdullah	CADET KUMITE MALE -52 KG
	Male	almalki	waleed	KIDS KUMITE MALE 10 YEARS
	Male	almalki	waleed	KIDS KATA MALE 10 - 11 YEARS
	Male	Falatah	Faisal	JUNIOR KUMITE MALE -61 KG
	Male	salami	Ahmed	KIDS KUMITE MALE 10 YEARS

Entries: 10

EMIRATES SPORTS KARATE OPEN

UNITED ARAB EMIRATES
SHARJAH

2023.03.03 - 2023.03.05



ENTRY LIST

 SUD - SUDAN				
ID	Gender	Family Name	Given Name	Event
	Male	ABDELKAREEM ALI	MOHAMED	U14 KUMITE MALE +55 KG
	Male	IBRAHIM	MOWMEN	KIDS KUMITE MALE 8 YEARS
	Male	MOHAMED AHMED	MOHAMED	KIDS KUMITE MALE 11 YEARS
	Male	YOUSIF MOHAMED	MOHAMED	CADET KUMITE MALE 70+ KG
	Female	ABDALKAREEM ALI	AMNA	KIDS KUMITE FEMALE 9 YEARS
	Female	ALI	DOHA	KIDS KUMITE FEMALE 11 YEARS

Entries: 6



EMIRATES SPORTS KARATE OPEN

UNITED ARAB EMIRATES
SHARJAH

2023.03.03 - 2023.03.05



ENTRY LIST

UAE - UNITED ARAB EMIRATES				
ID	Gender	Family Name	Given Name	Event
	Male	Aarav	Taman	KIDS KUMITE MALE 7 YEARS
	Male	AARON SALDANA	ARTHUR	KIDS KATA MALE 6 - 7 YEARS
	Male	ABDELHAMID	SAYED	U14 Kata Male
	Male	ABDELHAMID	SAYED	KIDS KUMITE MALE 11 YEARS
	Male	ABDELRAHIM	ABDULAZIZ	U14 KUMITE MALE -40 KG
	Male	ABDELRAHMAN AMR	MOHAMED ABDELRAHMAN EL SHABRAWY	KIDS KATA MALE 8 - 9 YEARS
	Male	ABDELSALAM	HAMZA	KIDS KATA MALE 6 - 7 YEARS
	Male	ABDELSALAM	HAMZA	KIDS KUMITE MALE 7 YEARS
	Male	ABDUGAFAROV	KAMRONBEK	KIDS KATA MALE 8 - 9 YEARS
	Male	ABNDAEM	LAYTH	KIDS KATA MALE 6 - 7 YEARS
	Male	Abouelyazeid	Raafat	U14 KUMITE MALE -40 KG
	Male	Abu Eslaih	Yamen Hazem Hamdan	KIDS KUMITE MALE 10 YEARS
	Male	AFFANDY	EHSAN	KIDS KUMITE FEMALE 8 YEARS
	Male	AFFANDY	EHSAN	KIDS KATA FEMALE 8 - 9 YEARS
	Male	AFFANDY	EHSAN	KIDS KATA MALE 8 - 9 YEARS
	Male	AHMED	JAZSER	KIDS KATA MALE 8 - 9 YEARS
	Male	AHMED	TAMBAL	U14 KUMITE MALE +55 KG
	Male	AHMED	YOUSSEF	JUNIOR KUMITE MALE -68 KG
	Male	AHMED GAMAL AHMED	MOHAMED ABDELMOTELEB AMMAR	KIDS KATA MALE 10 - 11 YEARS
	Male	AHMED GAMAL AHMED	MOHAMED ABDELMOTELEB AMMAR	KIDS KUMITE MALE 10 YEARS
	Male	AJEESH	ANGELO	KIDS KATA MALE 10 - 11 YEARS
	Male	Al Khishi	Karam Muntaser Fawzi	KIDS KUMITE MALE 10 YEARS
	Male	ALALI	MAYED	KIDS KATA MALE 8 - 9 YEARS
	Male	ALAYDI	AMEER	KIDS KUMITE MALE 7 YEARS
	Male	Alazzeh	Eyas Samer	CADET KUMITE MALE -63 KG
	Male	ALBLOOSHI	SAIF MOHAMMED HASAN EBRAHIM	U14 KUMITE MALE -40 KG
	Male	ALBLOOSHI	SULTAN MOHAMMED HASAN EBRAHIM	KIDS KUMITE MALE 11 YEARS
	Male	Alborom	Abdullah	KIDS KUMITE MALE 11 YEARS
	Male	Alborom	Muhammad	KIDS KUMITE MALE 11 YEARS
	Male	Alborom	Yasser	CADET KUMITE MALE -63 KG
	Male	Aldroos	Rashid	KIDS KUMITE MALE 7 YEARS
	Male	ALFADEL	ADAM	KIDS KUMITE MALE 9 YEARS
	Male	ALGHFELI	AHMED	U14 Kata Male
	Male	ALGHFELI	BUTI	KIDS KATA MALE 8 - 9 YEARS
	Male	ALGHONEMY	HAMZA	KIDS KUMITE MALE 11 YEARS
	Male	alhajjaj	khalifa	U14 KUMITE MALE -50 KG
	Male	Alhammadi	Saud	KIDS KUMITE MALE 8 YEARS
	Male	ALHEDDINY	ISSA	KIDS KUMITE MALE 9 YEARS
	Male	ALI	MEHRI	KIDS KATA MALE 10 - 11 YEARS



EMIRATES SPORTS KARATE OPEN

UNITED ARAB EMIRATES
SHARJAH

2023.03.03 - 2023.03.05



ENTRY LIST

	Male	ALI KHALID	ALI ELHAJ	U14 KUMITE MALE -45 KG
	Male	ALKHALDI	FAISAL	U14 KUMITE MALE -55 KG
	Male	ALKHALIDI	SAIF	KIDS KATA MALE 6 - 7 YEARS
	Male	Alkokhardi	Abdalla	U14 KUMITE MALE -40 KG
	Male	ALKOMY	MOUSA	U14 KUMITE MALE +55 KG
	Male	ALMAZRUI	LUAY	KIDS KATA MALE 8 - 9 YEARS
	Male	ALMAZRUI	LUAY	KIDS KUMITE MALE 9 YEARS
	Male	AIMomani	Yousef Issam Aref	U14 KUMITE MALE -45 KG
	Male	AIMomani	Yousef Issam Aref	U14 Kata Male
	Male	Alrashid	Abulmalik	U14 Kata Male
	Male	ALSHAER	YAHYA	KIDS KATA MALE 10 - 11 YEARS
	Male	ALSHAER	YAHYA	KIDS KUMITE MALE 10 YEARS
	Male	ALSHEHHI	MANSOUR	JUNIOR KUMITE MALE -68 KG
	Male	ALSUWAIDI	SAIF	KIDS KATA MALE 6 - 7 YEARS
	Male	Alzghoul	Aiham	U14 KUMITE MALE -45 KG
	Male	Amer	Saif Yaser	KIDS KUMITE MALE 10 YEARS
	Male	Amer	Zaid Yaser	KIDS KUMITE MALE 9 YEARS
	Male	ARSHAD	ZACKAREYA	KIDS KUMITE MALE 8 YEARS
	Male	ARSHAD	ZACKAREYA	KIDS KATA MALE 8 - 9 YEARS
	Male	ASEM AHMED	MOHAMMAD ABU QORAH	KIDS KUMITE MALE 11 YEARS
	Male	ASER ABDELHAMID	SHAHAT AHMED YOUSSEF	KIDS KATA MALE 8 - 9 YEARS
	Male	Ashour	Youssef	KIDS KUMITE MALE 8 YEARS
	Male	ASHRAF	ARZAN	KIDS KUMITE MALE 10 YEARS
	Male	AWAN	RAYAAN	KIDS KATA MALE 6 - 7 YEARS
	Male	bader	issa	JUNIOR KUMITE MALE -68 KG
	Male	BEIG	EMAAD	KIDS KATA MALE 6 - 7 YEARS
	Male	bilal	ali	KIDS KUMITE MALE 10 YEARS
	Male	CHABCHOUB	AHMED	U14 KUMITE MALE +55 KG
	Male	CHAFIC	FAISAL	U14 KUMITE MALE +55 KG
	Male	CHAFIC	FAISAL	U14 KUMITE MALE -40 KG
	Male	Chaltouni	Omar	JUNIOR KUMITE MALE -55 KG
	Male	chandra kumar	Taran krishna	KIDS KATA MALE 10 - 11 YEARS
	Male	CHOURASIA	SAMYAK	KIDS KATA MALE 8 - 9 YEARS
	Male	DEHANKAR	AKSHAJ	KIDS KUMITE MALE 7 YEARS
	Male	DURAH-BAK	OMAR	KIDS KUMITE MALE 9 YEARS
	Male	DURAH-BAK	ZAID	KIDS KATA MALE 6 - 7 YEARS
	Male	EFFIX	AUSTIN	KIDS KATA MALE 10 - 11 YEARS
	Male	EHAB	MOHAMED	KIDS KATA MALE 8 - 9 YEARS
	Male	ELDAOUDI	ADAM	KIDS KUMITE MALE 8 YEARS
	Male	ELFATEH	AHMED	KIDS KATA MALE 6 - 7 YEARS
	Male	ELGENDY	ALI	U14 KUMITE MALE -50 KG
	Male	ELGENDY	OMAR	KIDS KATA MALE 8 - 9 YEARS
	Male	ELGENDY	OMAR	KIDS KUMITE MALE 9 YEARS
	Male	Elghoorori	Loai	JUNIOR KUMITE MALE -68 KG
	Male	ELSAYED	AHMED	U14 KUMITE MALE +55 KG
	Male	ELSAYED	YOUSEF	JUNIOR KUMITE MALE 76+ KG
	Male	EWAN ABDELHAMID	SHAHAT AHMED YOUSSEF	Cadet Kata Male



EMIRATES SPORTS KARATE OPEN

UNITED ARAB EMIRATES
SHARJAH

2023.03.03 - 2023.03.05



ENTRY LIST

	Male	EYAD ABDELHAMID	SHAHAT AHMED YOUSSEF	KIDS KATA MALE 10 - 11 YEARS
	Male	FAHMY	YOUSEF	KIDS KATA MALE 6 - 7 YEARS
	Male	FAZELI	ADNAN	CADET KUMITE MALE -52 KG
	Male	FEKKAS	NIKOLAOS	U14 Kata Male
	Male	flores	lorenzo louis	U14 KUMITE MALE -50 KG
	Male	GABER	MAHMOUD	SENIOR KUMITE MALE -75 KG
	Male	GAD	BELAL	JUNIOR KUMITE MALE -76 KG
	Male	GEORGE	JOUSHUA	Junior Kata Male
	Male	GEORGE	JOUSHUA	JUNIOR KUMITE MALE -55 KG
	Male	Ghali	Adam	JUNIOR KUMITE MALE -76 KG
	Male	Gholamreza	Fazel	JUNIOR KUMITE MALE -55 KG
	Male	GOHIL	VIVAAN VAIBHAV	KIDS KATA MALE 8 - 9 YEARS
	Male	Gomaa	Khalid	CADET KUMITE MALE 70+ KG
	Male	Gomaa	Yousif	U14 KUMITE MALE +55 KG
	Male	Hadi	Abdul.	U14 KUMITE MALE +55 KG
	Male	HAMZA	WALEED	Senior kata male
	Male	HAMZA GAMAL AHMED	MOHAMED ABDELMOTELEB AMMAR	KIDS KATA MALE 8 - 9 YEARS
	Male	HANIEL	PERRY POAL	KIDS KUMITE MALE 7 YEARS
	Male	HASSAN ABDULLAH	ABDULLA	JUNIOR KUMITE MALE -61 KG
	Male	HELMY	OMAR	KIDS KUMITE MALE 10 YEARS
	Male	hossam	abdulrahman	JUNIOR KUMITE MALE 76+ KG
	Male	HUSSAIN	ISABIN	SENIOR KUMITE MALE -75 KG
	Male	HUSSEIN	ABDALLA	CADET KUMITE MALE 70+ KG
	Male	IBRAHIM	MALEK	U14 KUMITE MALE -55 KG
	Male	Ishan Kunnath	Ishan	U14 Kata Male
	Male	Ismail	Zeiad	KIDS KUMITE MALE 11 YEARS
0	Male	ISMAIL	ZIAD	KIDS KUMITE MALE 11 YEARS
	Male	ISSA	ADAM	KIDS KUMITE MALE 10 YEARS
	Male	ISSA	HISHAM	KIDS KUMITE MALE 8 YEARS
	Male	ISSA	HISHAM	KIDS KATA MALE 8 - 9 YEARS
	Male	IZA	JESSE	KIDS KUMITE MALE 10 YEARS
	Male	Jarrouche	Jason	KIDS KUMITE MALE 11 YEARS
	Male	JOOD ALAA	HABRAH	U14 KUMITE MALE +55 KG
	Male	K T	Muzammil	Senior kata male
	Male	KAMOUN	MOHAMED	KIDS KUMITE MALE 10 YEARS
	Male	KAMOUN	MOHAMED	KIDS KATA MALE 10 - 11 YEARS
	Male	Khachan	Saif Wasim	KIDS KUMITE MALE 10 YEARS
	Male	KHAJEH	ROHAM	KIDS KATA MALE 8 - 9 YEARS
	Male	Khalid	Ahmed	U14 KUMITE MALE +55 KG
	Male	KHALID ABDALLA	SALIM ABDALLA ALKINDI	U14 KUMITE MALE -55 KG
	Male	KHALIFA	NASER	KIDS KUMITE MALE 10 YEARS
	Male	KHALIFA	SAIF	KIDS KUMITE MALE 8 YEARS
	Male	KHALIL	RASHID	CADET KUMITE MALE -57 KG
	Male	KHALIL	saif	KIDS KUMITE MALE 10 YEARS
	Male	khamis	essa mohammed	U14 KUMITE MALE +55 KG
	Male	KHAMMASH	ABDALLAH	U14 KUMITE MALE -55 KG
	Male	KHAMMASH	OWAIS	KIDS KATA MALE 8 - 9 YEARS



EMIRATES SPORTS KARATE OPEN

UNITED ARAB EMIRATES
SHARJAH

2023.03.03 - 2023.03.05



ENTRY LIST

	Male	KHAN	SALAH	KIDS KATA MALE 6 - 7 YEARS
	Male	KHAN	SAUD	U14 KUMITE MALE -45 KG
	Male	KHAN	SAUD	U14 KUMITE MALE +55 KG
	Male	Kheidri	Mounir	SENIOR KUMITE MALE -67 KG
	Male	KIAN	FARAMARZ	Junior Kata Male
	Male	KV	ANJUNATH	SENIOR KUMITE MALE -60 KG
	Male	kv	jamshad	SENIOR KUMITE MALE -67 KG
	Male	LOH	ETHAN	KIDS KATA MALE 10 - 11 YEARS
	Male	MAHMOOD	HAMZA	KIDS KUMITE MALE 7 YEARS
	Male	MAHMOUD	YAZAN	KIDS KATA MALE 6 - 7 YEARS
	Male	MAHMOUD FATHY	ADAM	KIDS KUMITE MALE 8 YEARS
	Male	mahyoub	hamdan	KIDS KATA MALE 8 - 9 YEARS
	Male	mahyoub	mohammed	CADET KUMITE MALE -52 KG
	Male	MAJDI	MOHAMED	KIDS KUMITE MALE 10 YEARS
	Male	MAJDI	MOHAMED	KIDS KATA MALE 10 - 11 YEARS
	Male	MAKDISSY	JHON ALARD	KIDS KATA MALE 10 - 11 YEARS
	Male	MALIK	FAHAD	KIDS KATA MALE 6 - 7 YEARS
	Male	MALIK	FAISAL	KIDS KATA MALE 10 - 11 YEARS
	Male	MALIK	FAISAL	KIDS KUMITE MALE 10 YEARS
	Male	MARANAN	AMMIEL CHUA	KIDS KATA MALE 10 - 11 YEARS
	Male	MATAR	AHMED	KIDS KATA MALE 10 - 11 YEARS
	Male	MATAR	AHMED	KIDS KATA MALE 8 - 9 YEARS
	Male	MAZDA	ZAOSH	KIDS KATA MALE 6 - 7 YEARS
	Male	MISK	FARIS	KIDS KATA MALE 10 - 11 YEARS
	Male	MISK	SAMER	KIDS KATA MALE 8 - 9 YEARS
	Male	MOHAMED	ABDELRAHMAN	KIDS KATA MALE 6 - 7 YEARS
	Male	MOHAMED	ABDELRAHMAN	KIDS KUMITE MALE 7 YEARS
	Male	MOHAMED	ABDULGHANI	Junior Kata Male
	Male	MOHAMED	ALI	CADET KUMITE MALE 70+ KG
	Male	Mohamed	Kareem	U14 KUMITE MALE -45 KG
	Male	MOHAMED	YOUSEF	KIDS KUMITE MALE 10 YEARS
	Male	MOHAMED ABDALLA	SALIM ABDALLA ALKINDI	KIDS KUMITE MALE 11 YEARS
	Male	MOHAMED ALI	MOHAMED EISA ALBLOOSHI	U14 KUMITE MALE -45 KG
	Male	MOHARAM	KAREEM	U14 KUMITE MALE -40 KG
	Male	mokhtar	saif	KIDS KATA MALE 8 - 9 YEARS
	Male	Mostafa	Anas	KIDS KATA MALE 6 - 7 YEARS
	Male	Mubadda	Abdulhalim	CADET KUMITE MALE 70+ KG
	Male	Mubadda	Mohmad	KIDS KUMITE MALE 10 YEARS
	Male	Muhammad	Athif	JUNIOR KUMITE MALE 76+ KG
	Male	MUNJE	NIADH	KIDS KUMITE MALE 7 YEARS
	Male	Naji	Qahtan	U14 KUMITE MALE -55 KG
	Male	Noureldin	Mohmed	SENIOR KUMITE MALE -67 KG
	Male	OMAR	EIAD	KIDS KATA MALE 8 - 9 YEARS
	Male	PATIL	ARAV	KIDS KUMITE MALE 8 YEARS
	Male	PRASAD	RYAN	KIDS KATA MALE 8 - 9 YEARS
	Male	Quime	Pierre Gustav	KIDS KATA MALE 10 - 11 YEARS
	Male	RAJESH	RISHIE	KIDS KUMITE MALE 7 YEARS
	Male	RAJESH	RITVIK	KIDS KUMITE MALE 9 YEARS



EMIRATES SPORTS KARATE OPEN

UNITED ARAB EMIRATES
SHARJAH

2023.03.03 - 2023.03.05



ENTRY LIST

	Male	Rajesh Nambiar	Jaidith	KIDS KATA MALE 10 - 11 YEARS
	Male	RAKESH	SHIVANSH	KIDS KUMITE MALE 10 YEARS
	Male	RAKESH	SHIVANSH	KIDS KATA MALE 10 - 11 YEARS
	Male	RAYAN RAED	AZMI ABU MOWAIS	U14 KUMITE MALE -45 KG
	Male	REDDY	PARTHIV	KIDS KUMITE MALE 8 YEARS
	Male	RENGARAJ	ROSHAN	U14 Kata Male
	Male	RIBHE MISK	RAYAN	KIDS KATA MALE 6 - 7 YEARS
	Male	Roohi	Badr	CADET KUMITE MALE -63 KG
	Male	Roohi	Hossein	KIDS KUMITE MALE 11 YEARS
	Male	Saeed	Humaid	KIDS KUMITE MALE 10 YEARS
	Male	saidu	samrood	Senior kata male
	Male	SAIF SALEM MOHAMED	EL SHAHAT SALEM MOHAMED	CADET KUMITE MALE -70 KG
	Male	SALEM AHMED ABDULLA	KHAMEIS BINOWAISHO	U14 KUMITE MALE -50 KG
	Male	Sandesh	Sraavan	U14 Kata Male
	Male	SANKAR	ARJUNA	U14 KUMITE MALE -50 KG
	Male	SATHISH	MITHIRAN	KIDS KUMITE MALE 9 YEARS
	Male	SATISH	SRINATH	Cadet Kata Male
	Male	Selvaraj	Sridhar	Cadet Kata Male
	Male	SHAH	ABDULLA	Cadet Kata Male
	Male	SHAKER	ALEX MARK	KIDS KATA MALE 6 - 7 YEARS
	Male	SHARAFELDIN	NOUR	KIDS KATA MALE 8 - 9 YEARS
	Male	SHARAFELDIN	NOUR	KIDS KATA FEMALE 8 - 9 YEARS
	Male	SHARMA	TANISH	KIDS KATA MALE 10 - 11 YEARS
	Male	SHENOY	ATHARV	KIDS KATA MALE 6 - 7 YEARS
	Male	SHOBAKI	DAIF	U14 KUMITE MALE -40 KG
	Male	Shrestha	Navaraj	SENIOR KUMITE MALE -60 KG
	Male	SOHALI	IBRAHIM	U14 KUMITE MALE -45 KG
	Male	Soufan	Adnan	U14 KUMITE MALE -55 KG
	Male	SUGAWARA	SOSUKE	KIDS KUMITE MALE 10 YEARS
	Male	SULTAN	AMMAR	KIDS KATA MALE 8 - 9 YEARS
	Male	SULTAN	AMMAR	KIDS KUMITE MALE 9 YEARS
	Male	T R	VISHNU	Senior kata male
	Male	Tariq	Mohamed	KIDS KATA MALE 8 - 9 YEARS
	Male	THARINDU	DIMANTHA	Senior kata male
	Male	Usman	Dhani	U14 KUMITE MALE -40 KG
	Male	Usman	Ghazal	JUNIOR KUMITE MALE -61 KG
	Male	Usman	Nafih	SENIOR KUMITE MALE -67 KG
	Male	VIJEESH	ARJIT	KIDS KATA MALE 8 - 9 YEARS
	Male	Wadee	Abu wakim	Senior kata male
	Male	Wafai	Alaeddin	CADET KUMITE MALE -63 KG
	Male	YAZDHANI	FATEH	U14 KUMITE MALE -40 KG
	Male	Younes	Mohamed	CADET KUMITE MALE -70 KG
	Male	Youssef	Omar	JUNIOR KUMITE MALE -68 KG
	Male	ZADA	HUSSEYN	U14 KUMITE MALE -55 KG
	Male	Zahnouni	Ahmed	KIDS KUMITE MALE 9 YEARS
	Male	Zamora	Wilfred II	Cadet Kata Male
	Male	ZAYAAN	MUHAMMED	KIDS KATA MALE 8 - 9 YEARS
	Female	AASHER	AIZA	KIDS KATA FEMALE 6 - 7 YEARS



EMIRATES SPORTS KARATE OPEN

UNITED ARAB EMIRATES
SHARJAH

2023.03.03 - 2023.03.05



ENTRY LIST

	Female	AASHER	ALIZA	KIDS KATA FEMALE 10 - 11 YEARS
	Female	ABDELSALAM	ROKAIA	KIDS KATA FEMALE 6 - 7 YEARS
	Female	ABU AL HAJ	LAYAN OSAMA	U14 KUMITE FEMALE 52+ KG
	Female	AHMED	FARIDA	U14 Kata Female
	Female	AHMED	FARIDA	KIDS KUMITE FEMALE 11 YEARS
	Female	AHMED	YASSMIN	CADET KUMITE FEMALE -61 KG
	Female	AL -NSOUR	NOUF SULEIMAN	CADET KUMITE FEMALE 61+ KG
	Female	Al ali	Aisha	KIDS KATA FEMALE 8 - 9 YEARS
	Female	Al Malkawi	Jana	CADET KUMITE FEMALE -54 KG
	Female	ALAGUZ	JUMANA	CADET KUMITE FEMALE -54 KG
	Female	ALALI	FAJIR	KIDS KATA FEMALE 8 - 9 YEARS
	Female	ALALI	FAJIR	KIDS KUMITE FEMALE 11 YEARS
	Female	Alazzeh	Linda	Junior Kata Female
	Female	Alazzeh	Linda	JUNIOR KUMITE FEMALE -66 KG
	Female	Albaz	Rayyan	JUNIOR KUMITE FEMALE -59 KG
	Female	Alborom	Jena	Cadet Kata Female
	Female	Alborom	Jena	CADET KUMITE FEMALE -54 KG
	Female	Aldroos	Joud	SENIOR KUMITE FEMALE -68 KG
	Female	alhajjaj	alyazia	KIDS KATA FEMALE 6 - 7 YEARS
	Female	ALI HASSAN	FATMAELZAHRAA MUSTAFA	SENIOR KUMITE FEMALE -55 KG
	Female	ALKETBI	SHAIKHA	CADET KUMITE FEMALE -61 KG
	Female	ALKETBI	SHAMMA	U14 KUMITE FEMALE 52+ KG
	Female	Alnahr	Sana	KIDS KATA FEMALE 10 - 11 YEARS
	Female	ALNOURASI	JANA	KIDS KUMITE FEMALE 8 YEARS
	Female	ALNOURASI	MENNA	U14 KUMITE FEMALE -42 KG
	Female	ALSHAHRANI	RANA	KIDS KATA FEMALE 6 - 7 YEARS
	Female	ALSHAHRANI	SAMA	KIDS KATA FEMALE 6 - 7 YEARS
	Female	Alsoboh	Haneen	CADET KUMITE FEMALE -47 KG
	Female	Alzghoul	Raseel	U14 Kata Female
	Female	BARAT	AMNA	CADET KUMITE FEMALE -47 KG
	Female	basnet	preeti	SENIOR KUMITE FEMALE -50 KG
	Female	BASUONI	DEMA	KIDS KATA FEMALE 10 - 11 YEARS
	Female	BASUONI	REEM	KIDS KATA FEMALE 6 - 7 YEARS
	Female	Benzeroual	Meriem	U14 KUMITE FEMALE -52 KG
	Female	bilal	budoor	U14 KUMITE FEMALE -42 KG
	Female	EHAB	MALAK	KIDS KATA FEMALE 10 - 11 YEARS
	Female	EHAB	SARA	KIDS KATA FEMALE 10 - 11 YEARS
	Female	Elawadi	Enji	KIDS KUMITE FEMALE 9 YEARS
	Female	ELMESSIRY	ALISSAR	CADET KUMITE FEMALE -54 KG
	Female	ELSAYED	AYA	U14 KUMITE FEMALE 52+ KG
	Female	Elshabrawy	Lina	KIDS KATA FEMALE 6 - 7 YEARS
	Female	Elshromolsy	Sama	KIDS KUMITE FEMALE 9 YEARS
	Female	Fadi Oun	Ayah	CADET KUMITE FEMALE -61 KG
	Female	Fathy Mohamed	Allaa	CADET KUMITE FEMALE -54 KG
	Female	Fathy Mohamed	Aya	U14 KUMITE FEMALE 52+ KG
	Female	FATIMA	KANEEZ	SENIOR KUMITE FEMALE -61 KG
	Female	Ghali	Ala	KIDS KUMITE FEMALE 11 YEARS
	Female	GHANIM	HALA	KIDS KATA FEMALE 6 - 7 YEARS
	Female	ghubash	amal	KIDS KUMITE FEMALE 11 YEARS



EMIRATES SPORTS KARATE OPEN

UNITED ARAB EMIRATES
SHARJAH

2023.03.03 - 2023.03.05



ENTRY LIST

	Female	HAITHAM	YARA	KIDS KATA FEMALE 10 - 11 YEARS
	Female	HAITHAM	YARA	KIDS KUMITE FEMALE 10 YEARS
	Female	HAMZA	ANSHIDA	Senior kata female
	Female	HAMZA	KHADEEJAH	KIDS KATA FEMALE 6 - 7 YEARS
	Female	Hassan	Haiqa	U14 KUMITE FEMALE -42 KG
	Female	Hassan	Haiqa	U14 Kata Female
	Female	hatam	huda	U14 Kata Female
	Female	hatam	huda	U14 KUMITE FEMALE -42 KG
	Female	hatam	nouf	KIDS KATA FEMALE 8 - 9 YEARS
	Female	HOUDA	EZHIRI	U14 KUMITE FEMALE -47 KG
	Female	IBRAHIM	HAYA	U14 KUMITE FEMALE 52+ KG
	Female	IBRAHIM	HAYA	U14 KUMITE FEMALE -52 KG
	Female	IBRAHIM	JOURY	KIDS KATA FEMALE 6 - 7 YEARS
	Female	ISMAIL	ALYAZYA	SENIOR KUMITE FEMALE -55 KG
	Female	JILLIAN	MAYZEE	U14 Kata Female
	Female	JULIAN	MAYA	CADET KUMITE FEMALE -61 KG
	Female	KAMAL	SUMIYA	Senior kata female
	Female	KAMOUN	MALAK	KIDS KATA FEMALE 6 - 7 YEARS
	Female	KANAN	EMAN	KIDS KUMITE FEMALE 11 YEARS
	Female	KANAN	EMAN	KIDS KATA FEMALE 10 - 11 YEARS
	Female	KAUR	AMARPREET	SENIOR KUMITE FEMALE -55 KG
	Female	khalid	dana	KIDS KATA FEMALE 10 - 11 YEARS
	Female	khalid	dana	KIDS KUMITE FEMALE 11 YEARS
	Female	khalid	mahra	KIDS KUMITE FEMALE 11 YEARS
	Female	KHALIL	hind	U14 KUMITE FEMALE 52+ KG
	Female	Kotb	Malak	CADET KUMITE FEMALE 61+ KG
	Female	Kovalevskaya	Anastassiya	KIDS KATA FEMALE 8 - 9 YEARS
	Female	LOH	CAYLA	KIDS KATA FEMALE 8 - 9 YEARS
	Female	LOH	LAYLA	U14 Kata Female
	Female	MAHMOUD	BISAN	KIDS KATA FEMALE 10 - 11 YEARS
	Female	mahyoub	razan	KIDS KATA FEMALE 10 - 11 YEARS
	Female	mahyoub	razan	KIDS KUMITE FEMALE 11 YEARS
	Female	MAKKI	SAFA	KIDS KATA FEMALE 6 - 7 YEARS
	Female	MALAK	JOUD	CADET KUMITE FEMALE -47 KG
	Female	MATAR	JANA	U14 Kata Female
	Female	MC KINNON	AMANDA	KIDS KUMITE FEMALE 7 YEARS
	Female	MC KINNON	SAMANTHA	KIDS KUMITE FEMALE 9 YEARS
	Female	Mineshkumar	Diya minesh kumar	JUNIOR KUMITE FEMALE -66 KG
	Female	Mineshkumar	Diya minesh kumar	Junior Kata Female
	Female	Mohamed	Aya	KIDS KUMITE FEMALE 9 YEARS
	Female	mohamed	lamar	KIDS KUMITE FEMALE 11 YEARS
	Female	mohamed	lamar	KIDS KATA FEMALE 10 - 11 YEARS
	Female	mohamed	mayar	KIDS KATA FEMALE 10 - 11 YEARS
	Female	mohamed	mayar	KIDS KUMITE FEMALE 10 YEARS
	Female	MOHAMED	ZAINA ABOBAKR	U14 KUMITE FEMALE 52+ KG
	Female	NADA AHMED ABDULLA	KHAMEIS BINOWAISHO	KIDS KUMITE FEMALE 11 YEARS
	Female	Nath	Kiara	KIDS KATA FEMALE 10 - 11 YEARS
	Female	Nazouri	Mojdeh	Senior kata female
	Female	ORABI	RAGHD	U14 KUMITE FEMALE -42 KG



EMIRATES SPORTS KARATE OPEN

UNITED ARAB EMIRATES
SHARJAH

2023.03.03 - 2023.03.05



ENTRY LIST

	Female	OUESLATI	ISRAA	KIDS KATA FEMALE 10 - 11 YEARS
	Female	OUESLATI	MILIA	KIDS KATA FEMALE 8 - 9 YEARS
	Female	parecattil	Rose saparya	U14 Kata Female
	Female	RAJESH	RUDHRA	U14 Kata Female
	Female	REDDY	SHULKA	U14 KUMITE FEMALE -52 KG
	Female	Roudher	Aayesha taji mohideen	CADET KUMITE FEMALE 61+ KG
	Female	SABRI	LAMAR MARWAN	CADET KUMITE FEMALE 61+ KG
	Female	SAID	SALMA	KIDS KATA FEMALE 10 - 11 YEARS
	Female	SALAH	DENA	U14 Kata Female
	Female	Samson	Elizabeth	KIDS KATA FEMALE 10 - 11 YEARS
	Female	SHAH	AAIRA	KIDS KATA FEMALE 6 - 7 YEARS
	Female	SHAH	AARIKA	KIDS KATA FEMALE 8 - 9 YEARS
	Female	SHAH ABBAS ALI	BUSHRA	Senior kata female
	Female	SHANIA	ANGEL	JUNIOR KUMITE FEMALE -53 KG
	Female	Sherif	Dougana	KIDS KATA FEMALE 6 - 7 YEARS
	Female	sherif	farida	KIDS KATA FEMALE 8 - 9 YEARS
	Female	Shinedas	Serah	U14 Kata Female
	Female	Shrestha	Sharmila	Senior kata female
	Female	SINHA	MANASVI	KIDS KUMITE FEMALE 10 YEARS
	Female	TIU	NATHANIA ERIKA	Cadet Kata Female
	Female	yaqoob	mahra	U14 KUMITE FEMALE -52 KG
	Female	Yaser	Habiba	U14 KUMITE FEMALE -47 KG
	Female	Younes	Fareda	KIDS KUMITE FEMALE 9 YEARS
	Female	Zamora	Stella Maris	U14 Kata Female
	Female	Zineldin	Ganatalla	KIDS KUMITE FEMALE 11 YEARS
	Male	ADEM	ELSAWY	KIDS KATA FEMALE 8 - 9 YEARS
	Male	ADEM	ELSAWY	KIDS KATA MALE 8 - 9 YEARS
	Male	ALBOURM	ABDULLAH	KIDS KUMITE MALE 9 YEARS
	Male	AYEDH H ABNDAJEM	EMAD	KIDS KATA MALE 10 - 11 YEARS
	Male	HAITHAM	YASIN	KIDS KATA FEMALE 8 - 9 YEARS
	Male	HAITHAM	YASIN	KIDS KATA MALE 8 - 9 YEARS
	Male	KARIM WAEL	MOHAMED ABDULAZIM	Senior kata male
	Male	MOHAMED OSAMA	ISMAIL FAWZI ISMAIL	KIDS KUMITE MALE 11 YEARS
	Male	SELIM AMR	SAYED ALY HANAFY	KIDS KATA MALE 8 - 9 YEARS
	Male	ZIAD WAEL	ABDULAZIM HUSSEIN	Cadet Kata Male

Entries: 362

EMIRATES SPORTS KARATE OPEN

UNITED ARAB EMIRATES
SHARJAH

2023.03.03 - 2023.03.05



ENTRY LIST

UZB - UZBEKISTAN				
ID	Gender	Family Name	Given Name	Event
	Male	ABDULVAKHOBOV	BEKHRUZ	KIDS KUMITE MALE 10 YEARS
	Male	ABDUNABIYEV	TENGIZ	KIDS KUMITE MALE 11 YEARS
	Male	Ibragimov	Zubair	KIDS KUMITE MALE 8 YEARS
	Male	Imomnazarov	Sherpolat	KIDS KUMITE MALE 7 YEARS
	Male	Kamalov	Sardor	KIDS KUMITE MALE 9 YEARS
	Male	Khakimov	Bobur	KIDS KUMITE MALE 8 YEARS
	Male	Kosimov	Javokhir	KIDS KUMITE MALE 11 YEARS
	Male	MADALIYEV	TIMUR	KIDS KUMITE MALE 9 YEARS
	Male	MUHAMMAD	SADINOV	KIDS KUMITE MALE 7 YEARS
	Male	Nematov	Imron	KIDS KUMITE MALE 7 YEARS
	Male	Olimjonov	Ziyodulla	KIDS KUMITE MALE 7 YEARS
	Male	Palvanov	Muhammadali	KIDS KUMITE MALE 9 YEARS
	Male	Raimberdiyev	Suhrobbek	KIDS KUMITE MALE 11 YEARS
	Male	Sadikov	Saidbek	KIDS KUMITE MALE 9 YEARS
	Male	SHORUSTAMOV	DIYORBEK	KIDS KUMITE MALE 10 YEARS
	Male	Shukhratshanov	Timur	KIDS KUMITE MALE 8 YEARS
	Male	Sodikov	Shokhrukh	U14 KUMITE MALE -40 KG
	Male	Umarov	Umar	CADET KUMITE MALE -52 KG
	Male	Yuldashev	Komron	KIDS KUMITE MALE 10 YEARS
	Male	Шоҳпуз	Алимжанов	KIDS KUMITE MALE 9 YEARS
	Female	Abduraimova	Mushtariy	U14 Kata Female

Entries: 21



EMIRATES SPORTS KARATE OPEN

UNITED ARAB EMIRATES
SHARJAH

2023.03.03 - 2023.03.05



ENTRY LIST

Total Entries: **601**



EMIRATES SPORTS KARATE OPEN

UNITED ARAB EMIRATES
SHARJAH

2023.03.03 - 2023.03.05



Statistics

Participating Countries: 17

Participating Regions: 14

Participating Team/Clubs: 67

	Competitors	Entries
Female	175	199
Male	358	402
Total	533	601

Entries per Category

	Entries	Teams
CADET KUMITE FEMALE -47 KG	8	-
CADET KUMITE FEMALE -54 KG	7	-
CADET KUMITE FEMALE -61 KG	5	-
CADET KUMITE FEMALE 61+ KG	4	-
CADET KUMITE MALE -52 KG	10	-
CADET KUMITE MALE -57 KG	4	-
CADET KUMITE MALE -63 KG	7	-
CADET KUMITE MALE -70 KG	4	-
CADET KUMITE MALE 70+ KG	6	-
Cadet Kata Female	4	-
Cadet Kata Male	11	-
JUNIOR KUMITE FEMALE -48 KG	2	-
JUNIOR KUMITE FEMALE -53 KG	2	-
JUNIOR KUMITE FEMALE -59 KG	5	-
JUNIOR KUMITE FEMALE -66 KG	2	-
JUNIOR KUMITE MALE -55 KG	5	-
JUNIOR KUMITE MALE -61 KG	7	-
JUNIOR KUMITE MALE -68 KG	10	-
JUNIOR KUMITE MALE -76 KG	3	-
JUNIOR KUMITE MALE 76+ KG	3	-
Junior Kata Female	4	-
Junior Kata Male	5	-
KIDS KATA FEMALE 10 - 11 YEARS	20	-
KIDS KATA FEMALE 6 - 7 YEARS	15	-
KIDS KATA FEMALE 8 - 9 YEARS	16	-
KIDS KATA MALE 10 - 11 YEARS	24	-
KIDS KATA MALE 6 - 7 YEARS	22	-
KIDS KATA MALE 8 - 9 YEARS	39	-
KIDS KUMITE FEMALE 10 YEARS	3	-
KIDS KUMITE FEMALE 11 YEARS	14	-



EMIRATES SPORTS KARATE OPEN

UNITED ARAB EMIRATES
SHARJAH

2023.03.03 - 2023.03.05



Statistics

KIDS KUMITE FEMALE 7 YEARS	2	-
KIDS KUMITE FEMALE 8 YEARS	2	-
KIDS KUMITE FEMALE 9 YEARS	9	-
KIDS KUMITE MALE 10 YEARS	33	-
KIDS KUMITE MALE 11 YEARS	20	-
KIDS KUMITE MALE 7 YEARS	19	-
KIDS KUMITE MALE 8 YEARS	20	-
KIDS KUMITE MALE 9 YEARS	20	-
SENIOR KUMITE FEMALE -50 KG	5	-
SENIOR KUMITE FEMALE -55 KG	9	-
SENIOR KUMITE FEMALE -61 KG	6	-
SENIOR KUMITE FEMALE -68 KG	6	-
SENIOR KUMITE FEMALE 68+ KG	3	-
SENIOR KUMITE MALE -60 KG	8	-
SENIOR KUMITE MALE -67 KG	5	-
SENIOR KUMITE MALE -75 KG	8	-
SENIOR KUMITE MALE -84 KG	4	-
SENIOR KUMITE MALE 84+ KG	5	-
Senior kata female	12	-
Senior kata male	10	-
U14 KUMITE FEMALE -42 KG	5	-
U14 KUMITE FEMALE -47 KG	3	-
U14 KUMITE FEMALE -52 KG	6	-
U14 KUMITE FEMALE 52+ KG	9	-
U14 KUMITE MALE +55 KG	19	-
U14 KUMITE MALE -40 KG	19	-
U14 KUMITE MALE -45 KG	10	-
U14 KUMITE MALE -50 KG	6	-
U14 KUMITE MALE -55 KG	11	-
U14 Kata Female	17	-
U14 Kata Male	19	-
Totals:	601	0





EMIRATES SPORTS KARATE OPEN - 2023-03-03

Cadet Kata Female



R1 G1/2 (2) Tatami 4 10:40(2023-03-04)

Competitors	Kata	1	2	3	4	5	6	7	TOTAL	Extra Total Rank
1 TIU NATHANIA, ERIKA (SHARJAH SPORTS CLUB,UAE)	028 HEIAN YONDAN	(7.3)	7.5	7.4	8.0	(8.1)			22.9	22.9 2
2 PIRIAZEVA VIKTORIIA (TATSUJIN KARATE SCHOOL RUS,RUS)	068 PAPUREN	7.5	(7.3)	7.6	8.2	(8.8)			23.3	23.3 1

R1 G2/2 (2) Tatami 4 10:45(2023-03-04)

Competitors	Kata	1	2	3	4	5	6	7	TOTAL	Extra Total Rank
1 ALBOROM JENA (SHARJAH SELF DEFENCE SPORTS CLUB,UAE)	021 GOJUSHIHO SHO	7.4	7.8	7.5	(8.4)	(5.0)			22.7	22.7 1
2 PAGUIO GABRIELLE (BUSHIDO MARTIAL ARTS & FITNESS - SKIF,PHI)	035 JIIN	7.1	7.4	7.2	(7.8)	(6.9)			21.7	21.7 2

R2 Gold Medal Match Tatami 4 10:50(2023-03-04)

Competitors	Kata	1	2	3	4	5	6	7	TOTAL	Extra Total Rank
1 PIRIAZEVA VIKTORIIA (TATSUJIN KARATE SCHOOL RUS,RUS)	092 SUPARINPEI	7.7	7.7	(6.8)	(8.9)	7.4			22.8	22.8 2
2 ALBOROM JENA (SHARJAH SELF DEFENCE SPORTS CLUB,UAE)	041 KANKU SHO	7.6	7.8	(7.5)	(8.5)	7.6			23.0	23.0 1

Results

1	ALBOROM JENA		UNITED ARAB EMIRATES
2	PIRIAZEVA VIKTORIIA		RUSSIAN FEDERATION
3	TIU NATHANIA ERIKA		UNITED ARAB EMIRATES
3	PAGUIO GABRIELLE		PHILIPPINES





EMIRATES SPORTS KARATE OPEN - 2023-03-03

Cadet Kata Male



R1 G1/2 (6) Tatami 3 11:40(2023-03-04)

Competitors	Kata	1	2	3	4	5	6	7	TOTAL	Extra Total Rank
1 SHAH ABDULLA (AL AZZAM KARATE CENTER, SHARJAH,UAE)	026 HEIAN NIDAN	6.6	6.8	(6.5)	6.9	(8.2)			20.3	5
2 REGINIO JES_ JOSEPH (BUSHIDO MARTIAL ARTS & FITNESS - SKIF,PHI)	036 JION	(6.9)	7.0	6.9	7.2	(7.9)			21.1	4
3 YOUSEF MOKRANI (ALGERIE,ALG)	067 PAIKU	7.7	7.6	(7.5)	8.6	(8.7)			23.9	1
4 ZAMORA WILFRED_ II (SHITOKAI MURAYAMA UAE,UAE)	075 ROHAI	7.0	(6.8)	7.1	(8.2)	7.7			21.8	3
5 EWAN_ABDELHAMID SHAHAT_AHMED_YOUSSEF (ABDELHAMED_CLUB,UAE)	008 CHATANYARA KUSHANKU	7.6	(7.5)	7.6	8.4	(8.5)			23.6	2
6 SELVARAJ SRIDHAR (MARTIAL ARTS KARATE KIDS,UAE)	036 JION	(5.0)	(5.0)	5.0	5.0	5.0			15.0	6

R1 G2/2 (5) Tatami 3 12:05(2023-03-04)

Competitors	Kata	1	2	3	4	5	6	7	TOTAL	Extra Total Rank
1 CRUZ LANCE_ JOURNEY_ EZEKIEL (BUSHIDO MARTIAL ARTS & FITNESS - SKIF,PHI)	041 KANKU SHO	(7.1)	7.2	(8.0)	7.1	7.2			21.5	4
2 BEREZIN DANIIL (НИЖЕГОРОДСКАЯ ОБЛАСТЬ,RUS)	061 NIPAIPO	7.4	7.4	(8.3)	7.6	(6.9)			22.4	3
3 NIZAR MOKRANI (ALGERIE,ALG)	020 GOJUSHIHO DAI	7.8	7.8	(8.6)	7.9	(7.6)			23.5	2
4 SATISH SRINATH (KARATE PRO , DUBAI,UAE)	021 GOJUSHIHO SHO									
5 ZIAD_WAEL ABDULAZIM_HUSSEIN (ABDELHAMED_CLUB,UAE)	021 GOJUSHIHO SHO	(7.7)	8.0	(8.2)	8.0	7.8			23.8	1

R2-G1 Tatami 3 12:25(2023-03-04)

Competitors	Kata	1	2	3	4	5	6	7	TOTAL	Extra Total Rank
1 YOUSEF MOKRANI (ALGERIE,ALG)	001 ANAN	(7.3)	7.6	8.6	(8.8)	7.6			23.8	1
2 ZAMORA WILFRED_ II (SHITOKAI MURAYAMA UAE,UAE)	006 BASSAI DAI	6.7	(6.6)	(7.8)	7.1	6.9			20.7	4
3 EWAN_ABDELHAMID SHAHAT_AHMED_YOUSSEF (ABDELHAMED_CLUB,UAE)	092 SUPARINPEI	7.7	(7.4)	8.4	(8.9)	7.5			23.6	2
4 REGINIO JES_ JOSEPH (BUSHIDO MARTIAL ARTS & FITNESS - SKIF,PHI)	091 SOCHIN	7.1	(7.0)	(8.2)	7.3	7.2			21.6	3

R2-G2 Tatami 4 12:25(2023-03-04)

Competitors	Kata	1	2	3	4	5	6	7	TOTAL	Extra Total Rank
1 NIZAR MOKRANI (ALGERIE,ALG)		(7.4)	(8.4)	7.8	7.8	7.5			23.1	3
2 CRUZ LANCE_ JOURNEY_ EZEKIEL (BUSHIDO MARTIAL ARTS & FITNESS - SKIF,PHI)		(7.3)	7.6	(8.0)	7.7	7.8			23.1	4
3 BEREZIN DANIIL (НИЖЕГОРОДСКАЯ ОБЛАСТЬ,RUS)		7.9	8.0	(7.5)	7.9	(8.4)			23.8	2
4 ZIAD_WAEL ABDULAZIM_HUSSEIN (ABDELHAMED_CLUB,UAE)		8.2	(8.1)	8.1	8.1	(8.8)			24.4	1

R3 Bronze Medal Match 1 Tatami 3 12:40(2023-03-04)

Competitors	Kata	1	2	3	4	5	6	7	TOTAL	Extra Total Rank
1 NIZAR MOKRANI (ALGERIE,ALG)	099 UNSU	7.8	(7.6)	7.7	8.4	(8.9)			23.9	2
2 EWAN_ABDELHAMID SHAHAT_AHMED_YOUSSEF (ABDELHAMED_CLUB,UAE)	002 ANAN DAI	8.1	7.9	(7.6)	8.3	(8.7)			24.3	1

R3 Bronze Medal Match 2 Tatami 4 12:40(2023-03-04)

Competitors	Kata	1	2	3	4	5	6	7	TOTAL	Extra Total Rank
1 BEREZIN DANIIL (НИЖЕГОРОДСКАЯ ОБЛАСТЬ,RUS)	068 PAPUREN	7.7	(7.4)	7.7	8.4	(8.7)			23.8	1
2 REGINIO JES_ JOSEPH (BUSHIDO MARTIAL ARTS & FITNESS - SKIF,PHI)	060 NIJUSHIHO	7.4	(7.1)	7.4	(8.0)	7.3			22.1	2

R3 Gold Medal Match Tatami 3 12:50(2023-03-04)

Competitors	Kata	1	2	3	4	5	6	7	TOTAL	Extra Total Rank
1 ZIAD_WAEL ABDULAZIM_HUSSEIN (ABDELHAMED_CLUB,UAE)	068 PAPUREN	7.3	7.3	7.2	(7.1)	(7.6)			21.8	1
2 YOUSEF MOKRANI (ALGERIE,ALG)	064 OHAN DAI	(7.0)	7.1	7.1	7.2	(7.8)			21.4	2

Results

1	ZIAD WAEL ABDULAZIM HUSSEIN		UNITED ARAB EMIRATES
---	-----------------------------	--	----------------------





EMIRATES SPORTS KARATE OPEN - 2023-03-03 Cadet Kata Male



2	YOUCEF MOKRANI		ALGERIA
3	EWAN ABDELHAMID SHAHAT AHMED YOUSSEF		UNITED ARAB EMIRATES
3	BEREZIN DANIIL		RUSSIAN FEDERATION
5	NIZAR MOKRANI		ALGERIA
5	REGINIO JES JOSEPH		PHILIPPINES
7	ZAMORA WILFRED II		UNITED ARAB EMIRATES
7	CRUZ LANCE JOURNEY EZEKIEL		PHILIPPINES
9	SHAH ABDULLA		UNITED ARAB EMIRATES
11	SELVARAJ SRIDHAR		UNITED ARAB EMIRATES



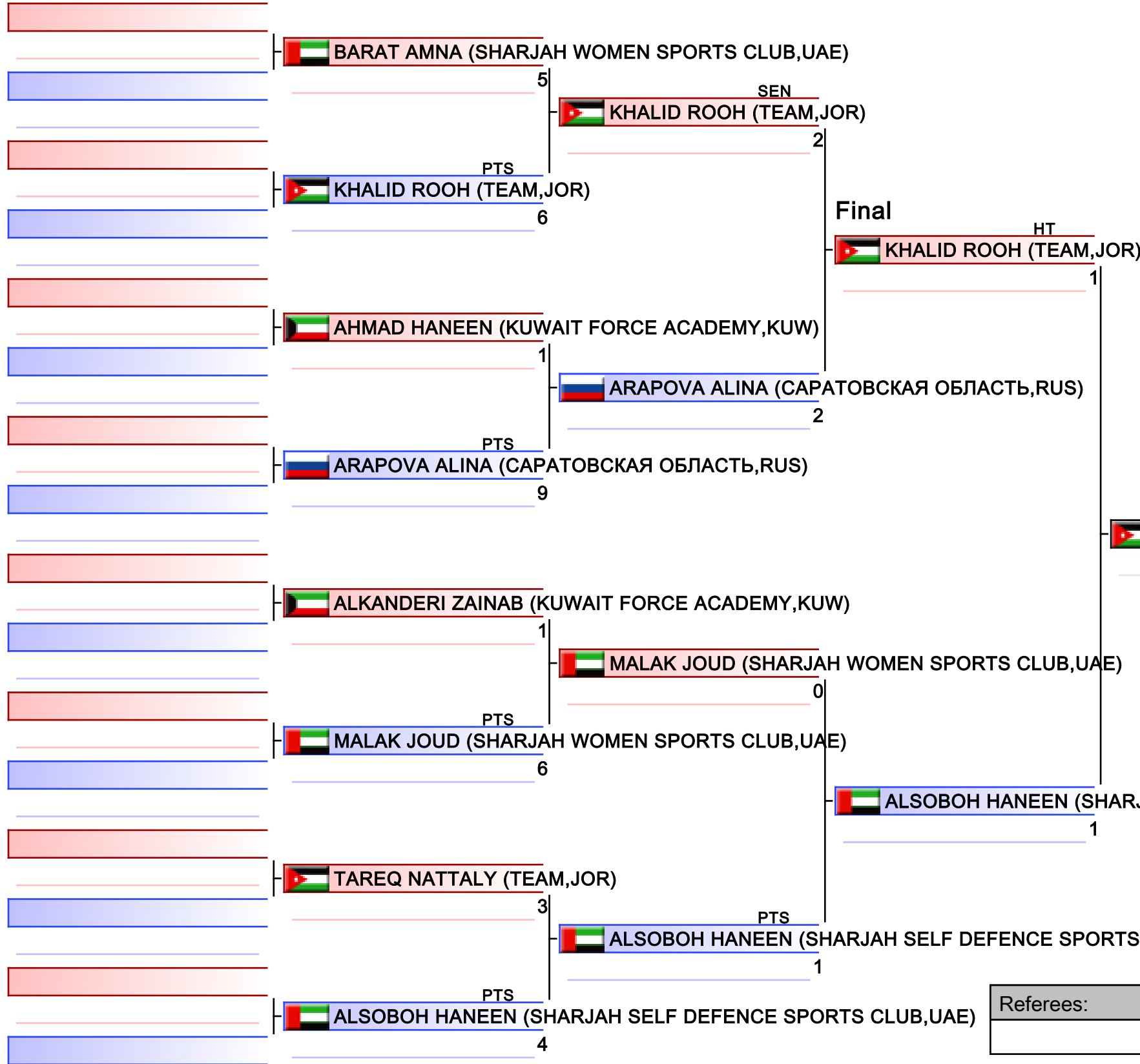

- | |
|--|
| 1. KHALID ROOH (TEAM,JOR) |
| 2. ALSOBOH HANEEN (SHARJAH SELF DEFENCE SPORTS CLUB,UAE) |
| 3. ARAPOVA ALINA (САРАТОВСКАЯ ОБЛАСТЬ,RUS) |
| 3. TAREQ NATTALY (TEAM,JOR) |
| 5. BARAT AMNA (SHARJAH WOMEN SPORTS CLUB,UAE) |
| 5. MALAK JOUD (SHARJAH WOMEN SPORTS CLUB,UAE) |
| |
| |

Referees:			

CADET KUMITE FEMALE -47 KG
EMIRATES SPORTS KARATE OPEN

2023-03-05

Tatami
1 09:45

Pool
1

(c)sportdata GmbH & Co KG 2000-2023 (2023-03-05 14:27) v 10.0.0 build 1 (2023-01-21) License: UAE Karate Federation (expire 2023-07-31)

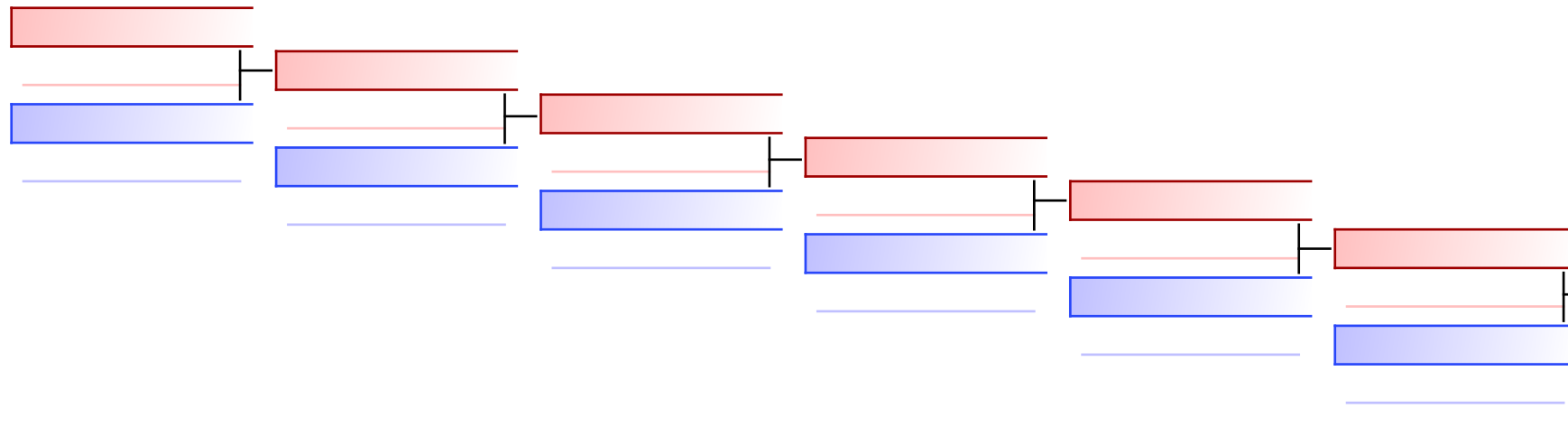

BARAT AMNA (SHARJAH WOMEN SPORTS CLUB,UAE)
 PTS | **АРАПОВА АЛИНА (САРАТОВСКАЯ ОБЛАСТЬ,RUS)**
 0 | 8

REPECHAGE: (1)

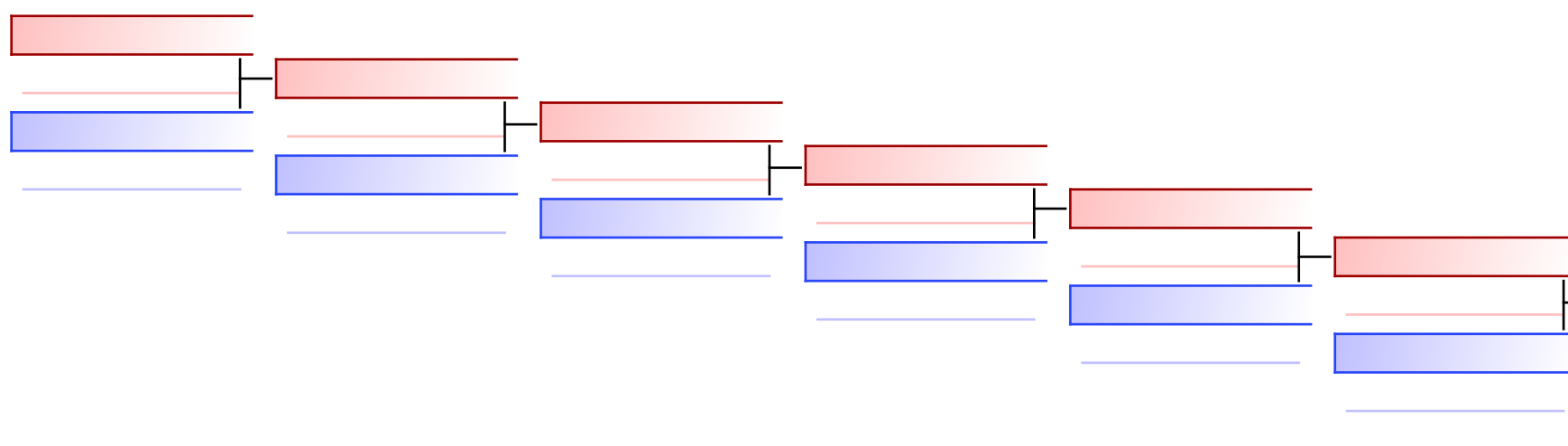

HT
TAREQ NATTALY (TEAM,JOR)
 0 | **TAREQ NATTALY (TEAM,JOR)**
MALAK JOUD (SHARJAH WOMEN SPORTS CLUB,UAE)
 0

Referees:							
-----------	--	--	--	--	--	--	--

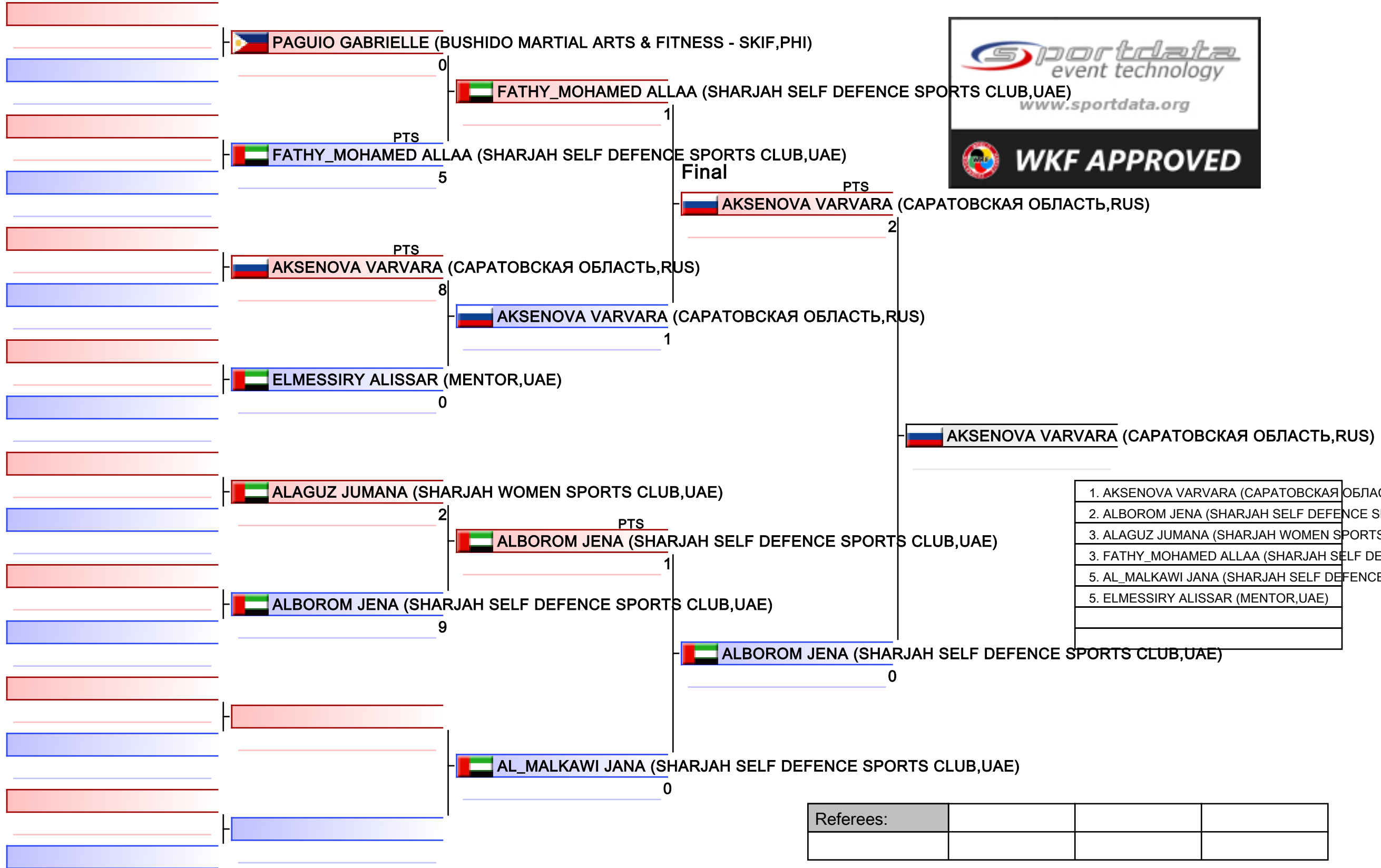

Referees:			

CADET KUMITE FEMALE -54 KG
EMIRATES SPORTS KARATE OPEN

2023-03-05

Tatami
2 09:40

Pool
1

(c)sportdata GmbH & Co KG 2000-2023 (2023-03-05 14:27) v 10.0.0 build 1 (2023-01-21) License: UAE Karate Federation (expire 2023-07-31)

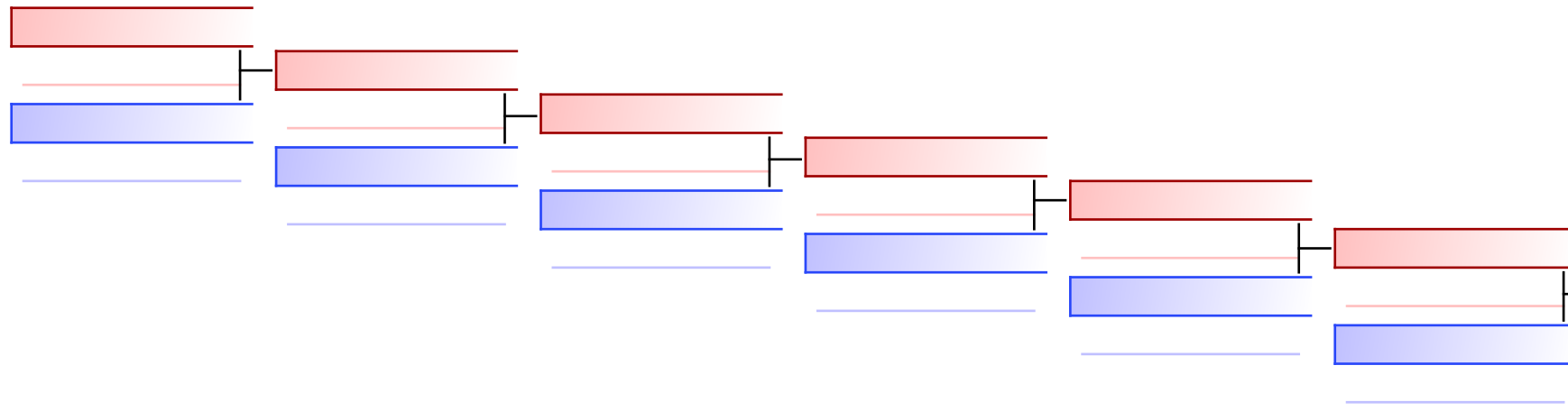

ELMESSIRY ALISSAR (MENTOR,UAE) | PTS | 0
 FATHY_MOHAMED ALLAA (SHARJAH SELF DEFENCE SPORTS CLUB) | PTS | 8

REPECHAGE: (1)

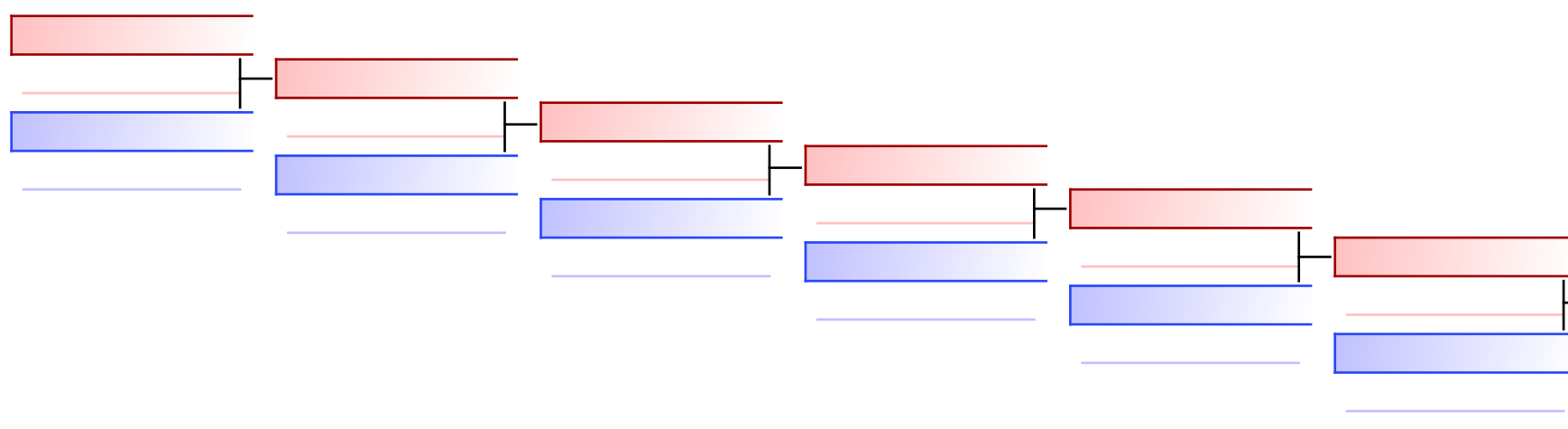

ALAGUZ JUMANA (SHARJAH WOMEN SPORTS CLUB) | PTS | 2
 AL_MALKAWI JANA (SHARJAH SELF DEFENCE SPORTS CLUB) | PTS | 0

Referees:							
-----------	--	--	--	--	--	--	--

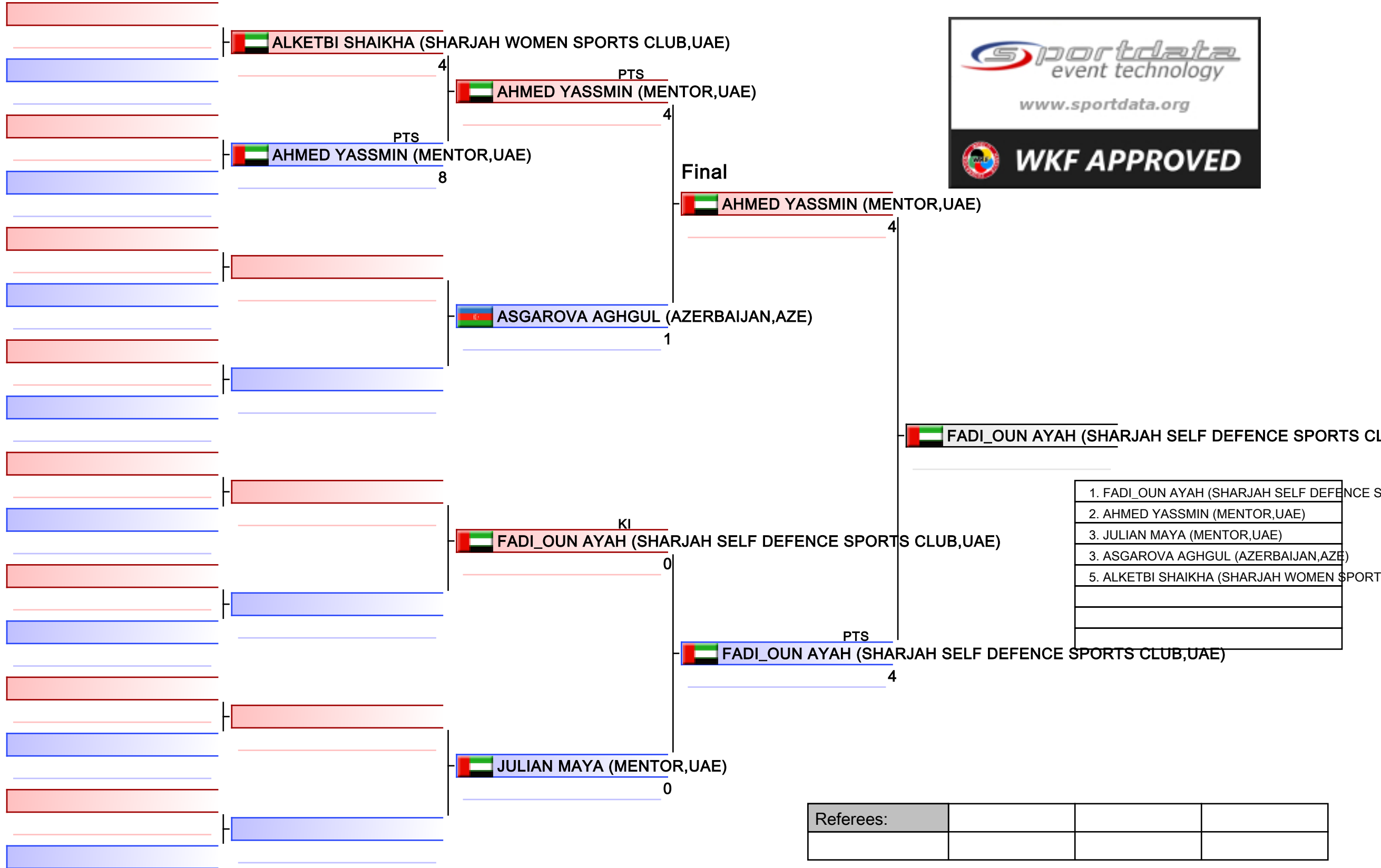

- | |
|---|
| 1. FADI_OUN AYAH (SHARJAH SELF DEFENCE SPORTS CLUB,UAE) |
| 2. AHMED YASSMIN (MENTOR,UAE) |
| 3. JULIAN MAYA (MENTOR,UAE) |
| 3. ASGAROVA AGHGUL (AZERBAIJAN,AZE) |
| 5. ALKETBI SHAIKHA (SHARJAH WOMEN SPORTS CLUB,UAE) |
| |
| |

Referees:			

CADET KUMITE FEMALE -61 KG
EMIRATES SPORTS KARATE OPEN

2023-03-05 3 09:35 Tatami
 1 Pool

(c)sportdata GmbH & Co KG 2000-2023 (2023-03-05 14:27) v 10.0.0 build 1 (2023-01-21) License: UAE Karate Federation (expire 2023-07-31)

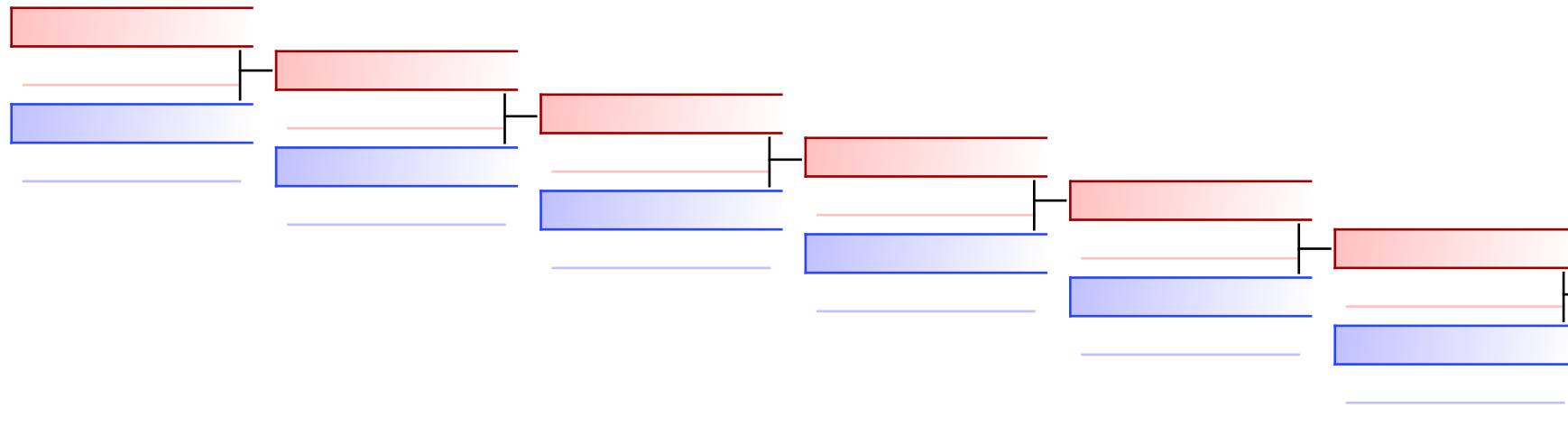

ALKETBI SHAIKHA (SHARJAH WOMEN SPORTS CLUB, UAE)
 3
ASGAROVA AGHGUL (AZERBAIJAN, AZE)
 4

REPECHAGE: (1)

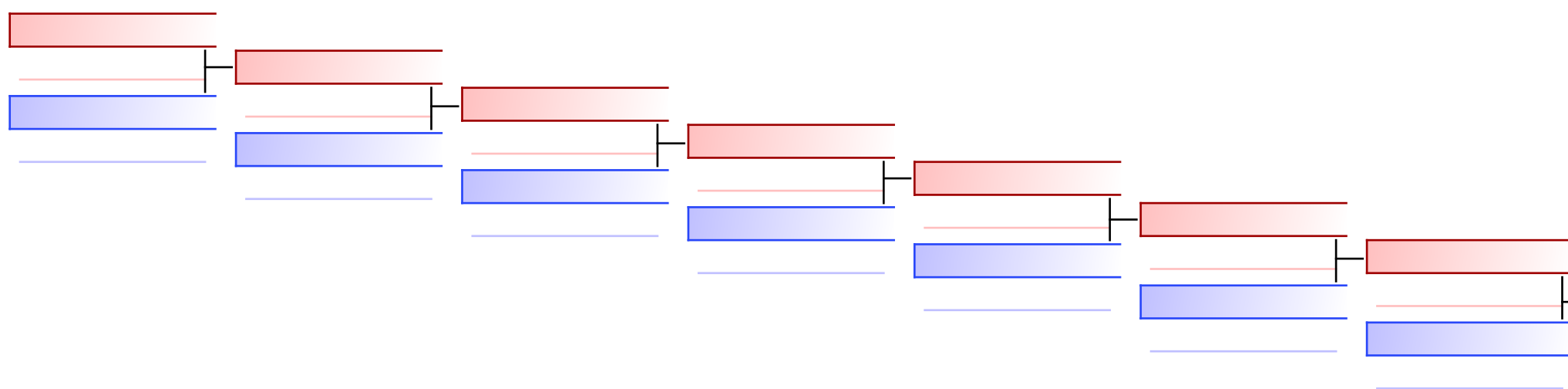

JULIAN MAYA (MENTOR, UAE)

Referees:							
-----------	--	--	--	--	--	--	--

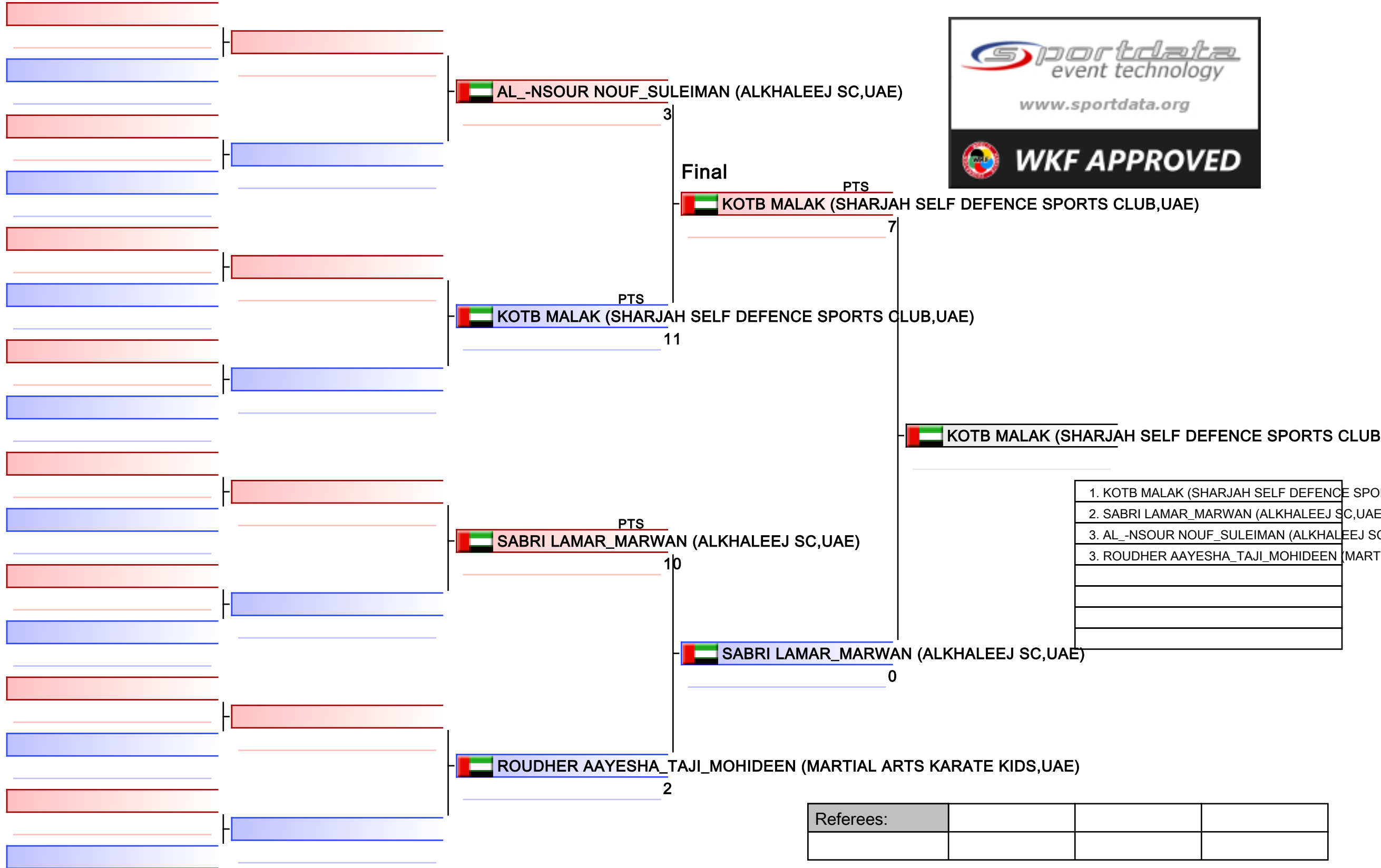

- | |
|--|
| 1. KOTB MALAK (SHARJAH SELF DEFENCE SPO |
| 2. SABRI LAMAR_MARWAN (ALKHALEEJ SC,UAE) |
| 3. AL_NSOUR NOUF_SULEIMAN (ALKHALEEJ SC |
| 3. ROUDHER AAYESHA_TAJI_MOHIDEEN (MARTI |
| |
| |
| |

Referees:			

CADET KUMITE FEMALE 61+ KG
EMIRATES SPORTS KARATE OPEN

Tatami

Pool
1

(c)sportdata GmbH & Co KG 2000-2023 (2023-03-05 14:27) v 10.0.0 build 1 (2023-01-21) License: UAE Karate Federation (expire 2023-07-31)

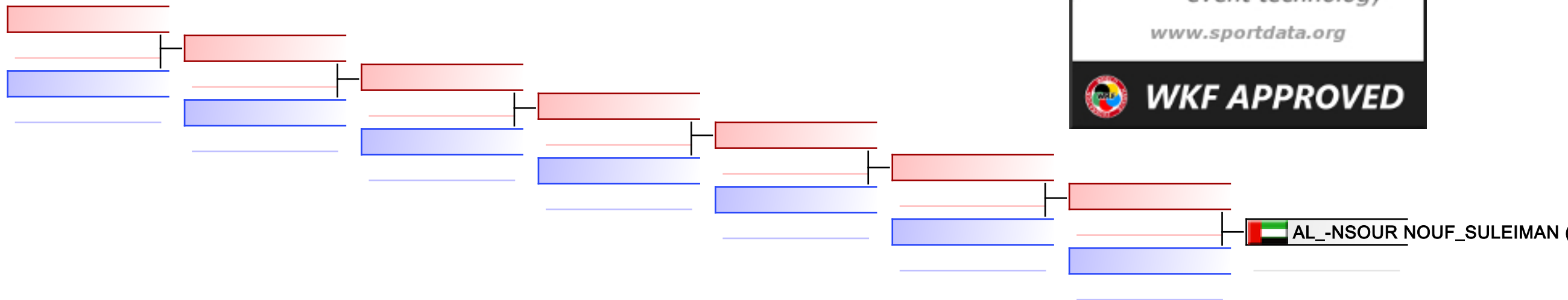

REPECHAGE: (1)

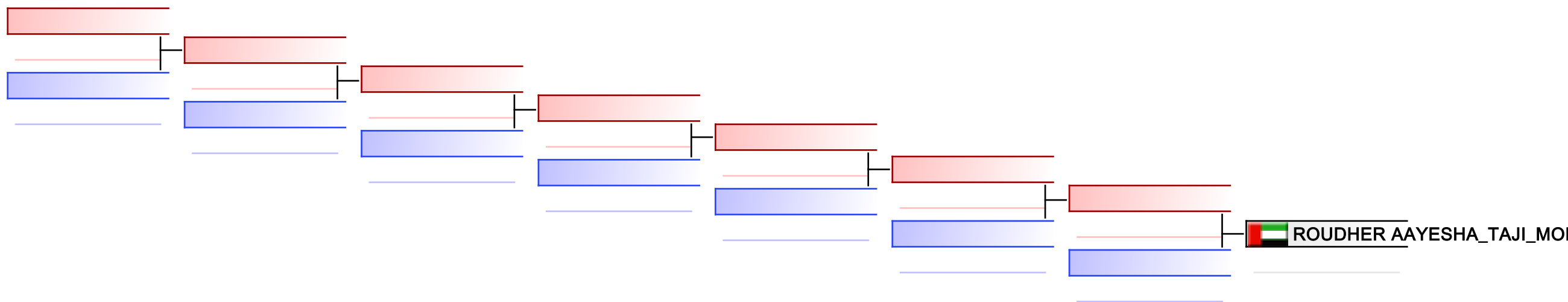

Referees:							
-----------	--	--	--	--	--	--	--

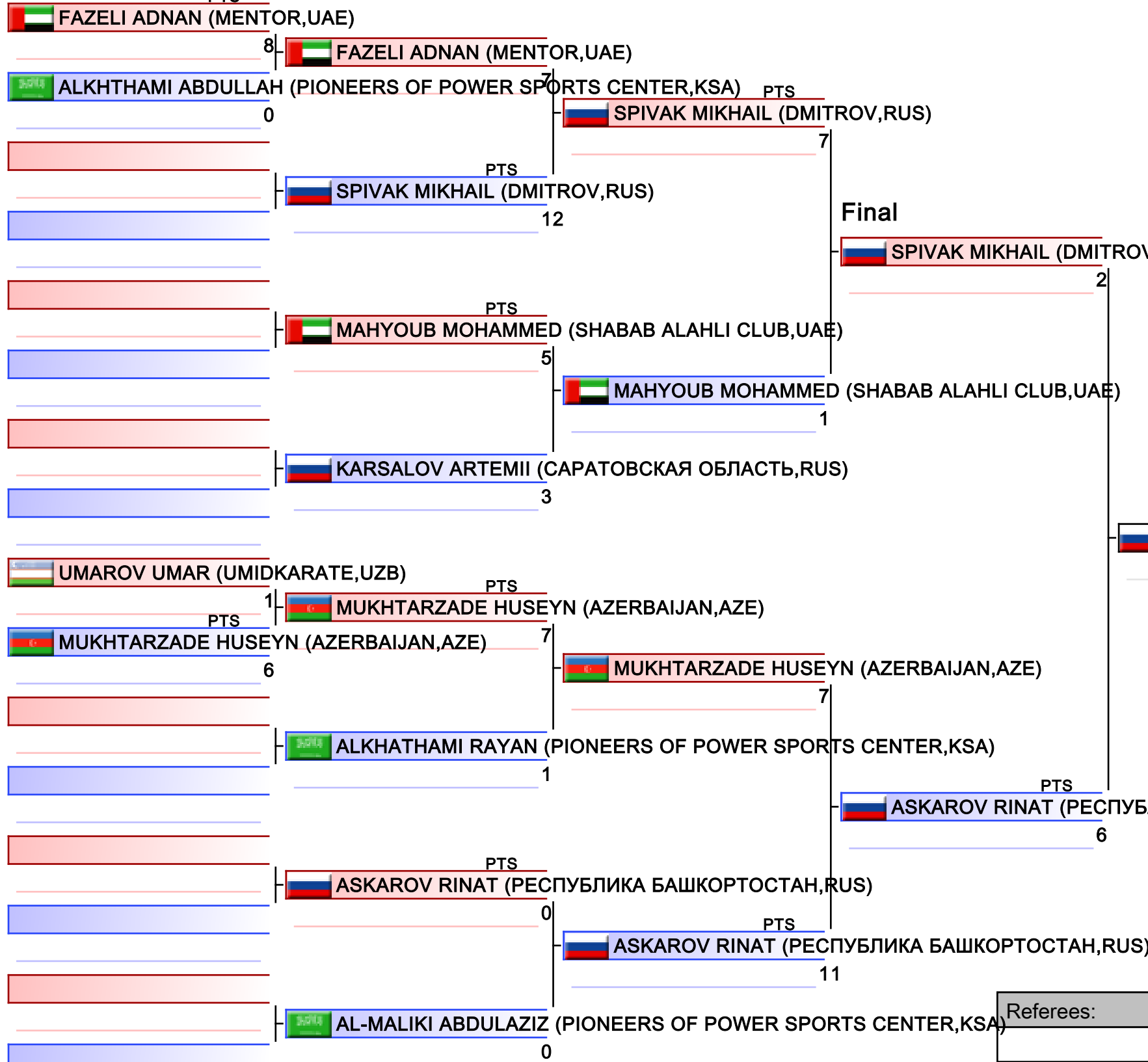

- | |
|--|
| 1. ASKAROV RINAT (РЕСПУБЛИКА БАШКОРТОСТАН,RUS) |
| 2. SPIVAK MIKHAIL (DMITROV,RUS) |
| 3. MAHYOUB MOHAMMED (SHABAB ALAHLI CLUB,UAE) |
| 3. MUKHTARZADE HUSEYN (AZERBAIJAN,AZE) |
| 5. FAZELI ADNAN (MENTOR,UAE) |
| 5. AL-MALIKI ABDULAZIZ (PIONEERS OF POWER SPORTS CENTER,KSA) |
| |
| |

CADET KUMITE MALE -52 KG
EMIRATES SPORTS KARATE OPEN

2023-03-05

Tatami
4 09:55

Pool
1

(c)sportdata GmbH & Co KG 2000-2023 (2023-03-05 14:27) v 10.0.0 build 1 (2023-01-21) License: UAE Karate Federation (expire 2023-07-31)

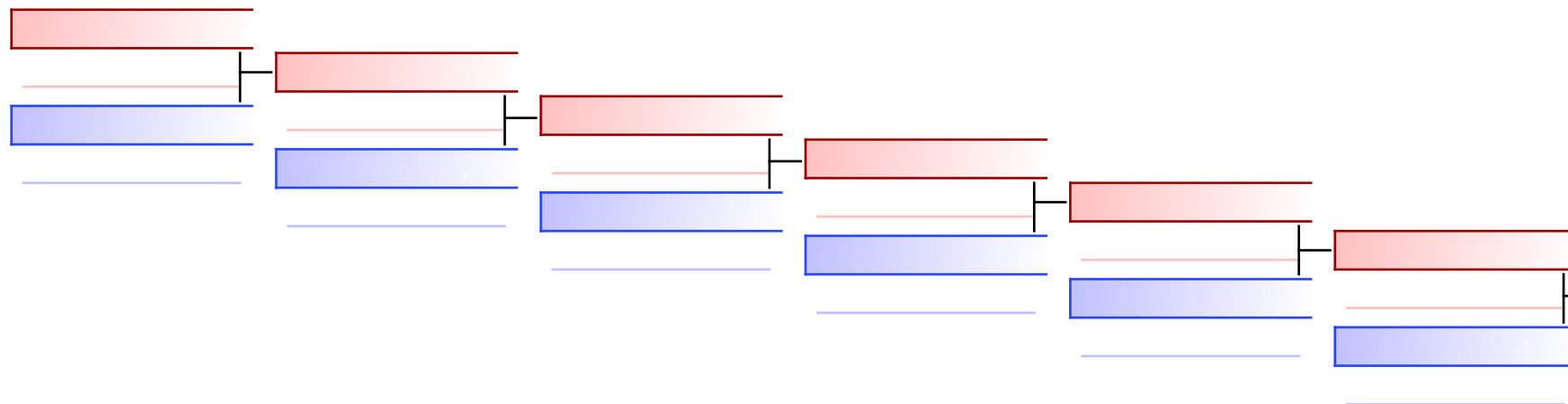

FAZELI ADNAN (MENTOR,UAE)
 PTS 4
MAHYOUB MOHAMMED (SHABAB ALAHLI CLUB,UA)
 PTS 12

REPECHAGE: (1)

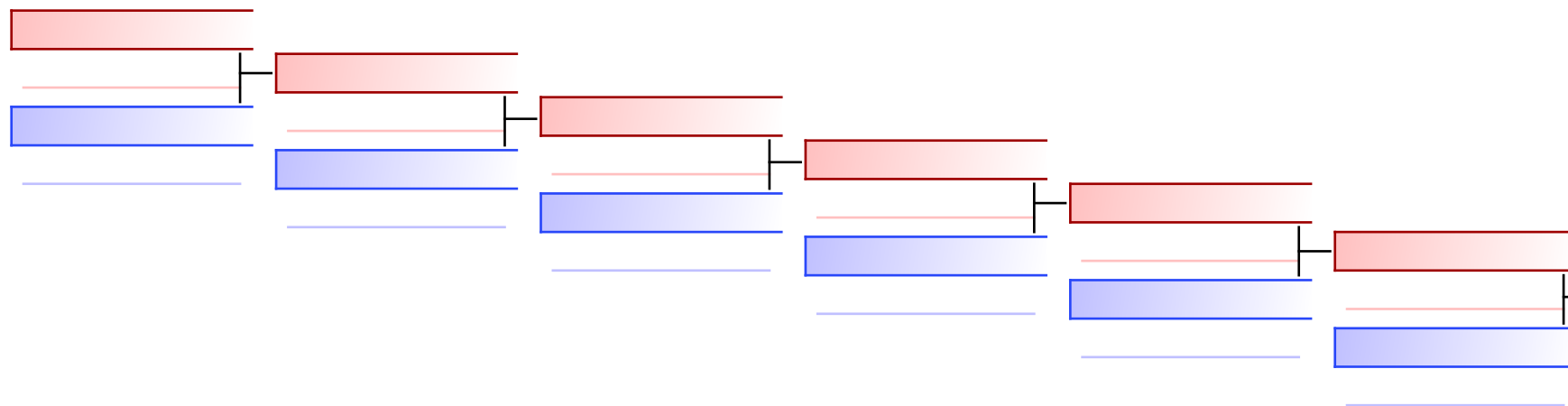

AL-MALIKI ABDULAZIZ (PIONEERS OF POWER SPO)
 PTS 0
MUKHTARZADE HUSEYN (AZERBAIJAN,AZE)
 PTS 4

Referees:							
-----------	--	--	--	--	--	--	--

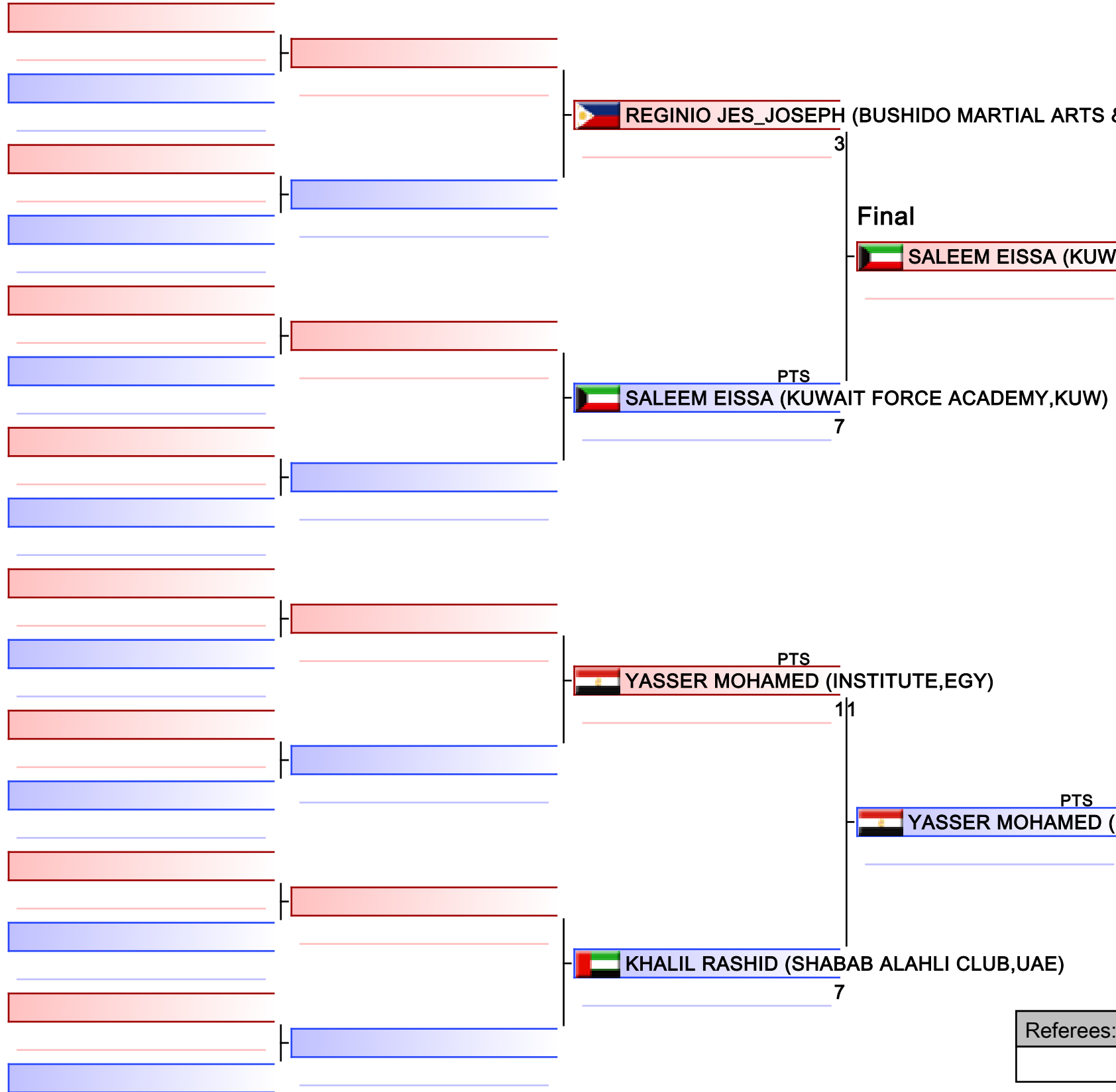

YASSER MOHAMED (INSTITUTE,EGY)

1. YASSER MOHAMED (INSTITUTE,EGY)
2. SALEEM EISSA (KUWAIT FORCE ACADEMY,KUW)
3. REGINIO JES_JOSEPH (BUSHIDO MARTIAL AR)
3. KHALIL RASHID (SHABAB ALAHLI CLUB,UAE)

Referees:			

CADET KUMITE MALE -57 KG
EMIRATES SPORTS KARATE OPEN

Tatami

Pool
1

(c)sportdata GmbH & Co KG 2000-2023 (2023-03-05 14:27) v 10.0.0 build 1 (2023-01-21) License: UAE Karate Federation (expire 2023-07-31)

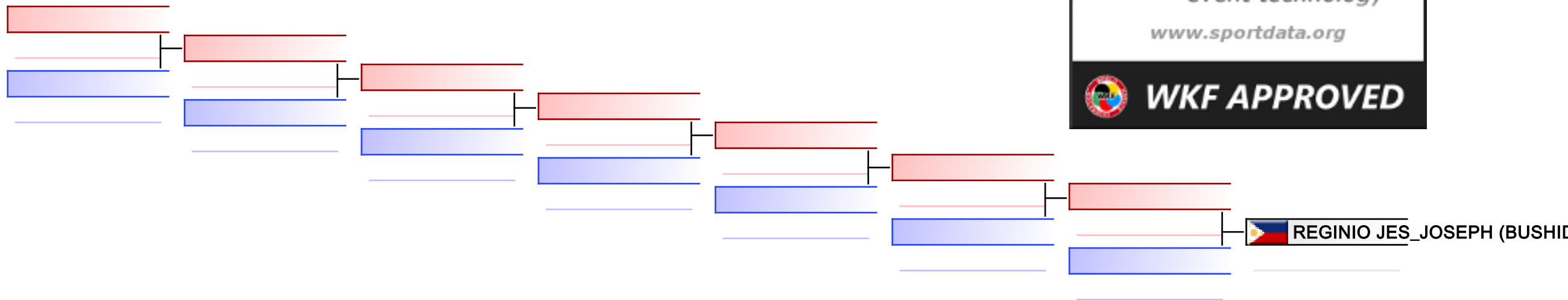

REPECHAGE: (1)

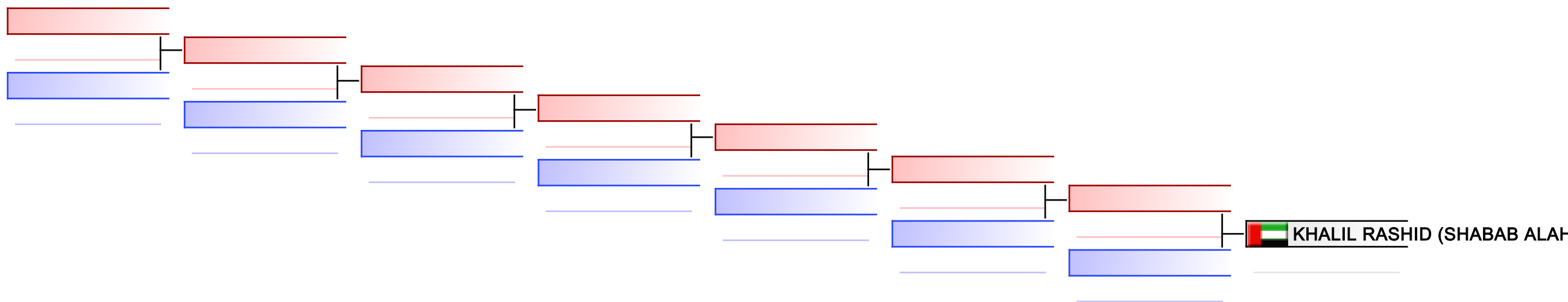

Referees:							
-----------	--	--	--	--	--	--	--

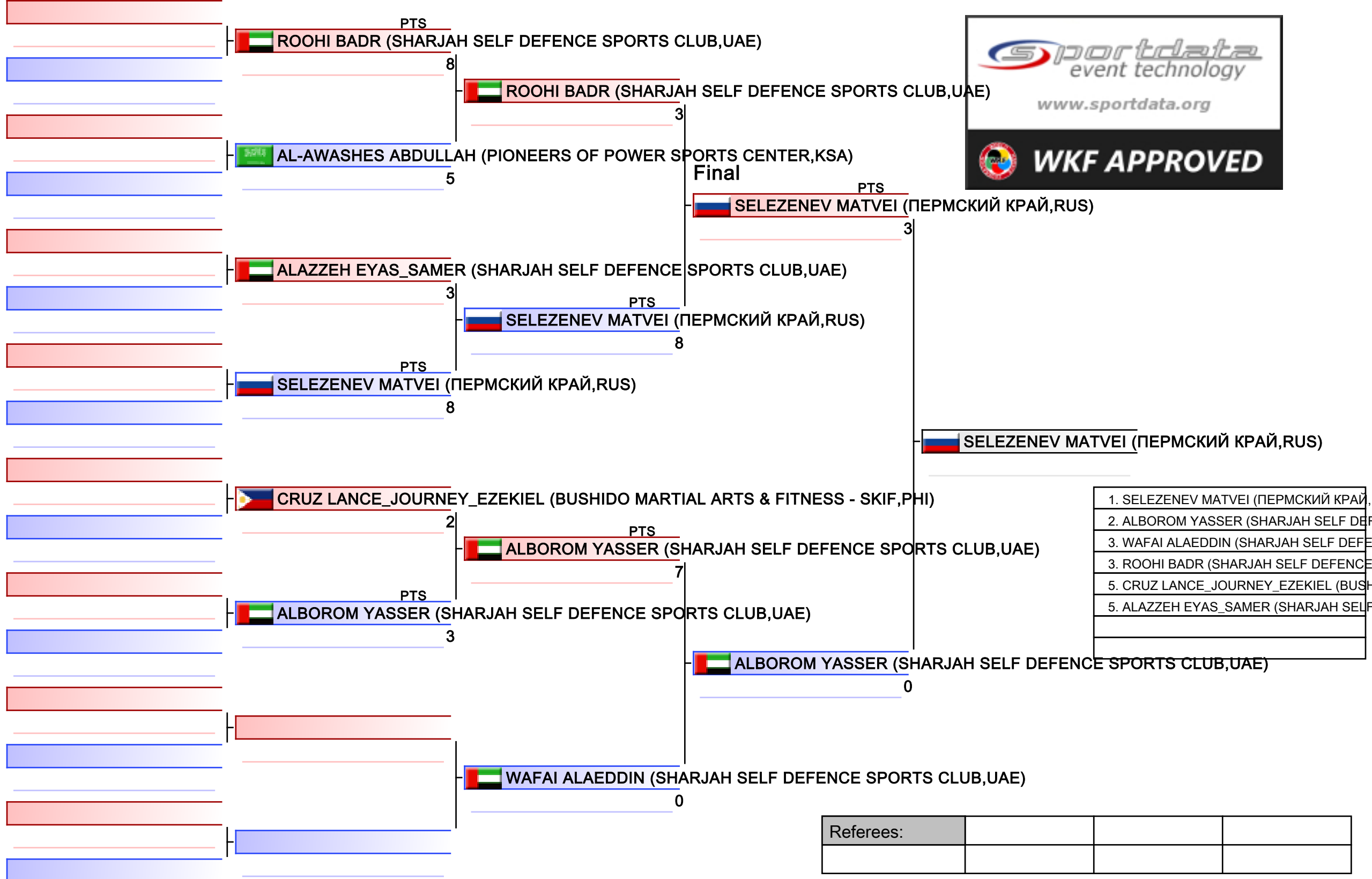

- | |
|--|
| 1. SELEZENEV MATVEI (ПЕРМСКИЙ КРАЙ, RUS) |
| 2. ALBOROM YASSER (SHARJAH SELF DEFENCE SPORTS CLUB, UAE) |
| 3. WAFI ALAEDDIN (SHARJAH SELF DEFENCE SPORTS CLUB, UAE) |
| 3. ROOHI BADR (SHARJAH SELF DEFENCE SPORTS CLUB, UAE) |
| 5. CRUZ LANCE_JOURNEY_EZEKIEL (BUSHIDO MARTIAL ARTS & FITNESS - SKIF, PHI) |
| 5. ALAZZEH EYAS_SAMER (SHARJAH SELF DEFENCE SPORTS CLUB, UAE) |
| |
| |

Referees:			

CADET KUMITE MALE -63 KG
EMIRATES SPORTS KARATE OPEN

2023-03-05

Tatami
2 10:00

Pool
1

(c)sportdata GmbH & Co KG 2000-2023 (2023-03-05 14:27) v 10.0.0 build 1 (2023-01-21) License: UAE Karate Federation (expire 2023-07-31)

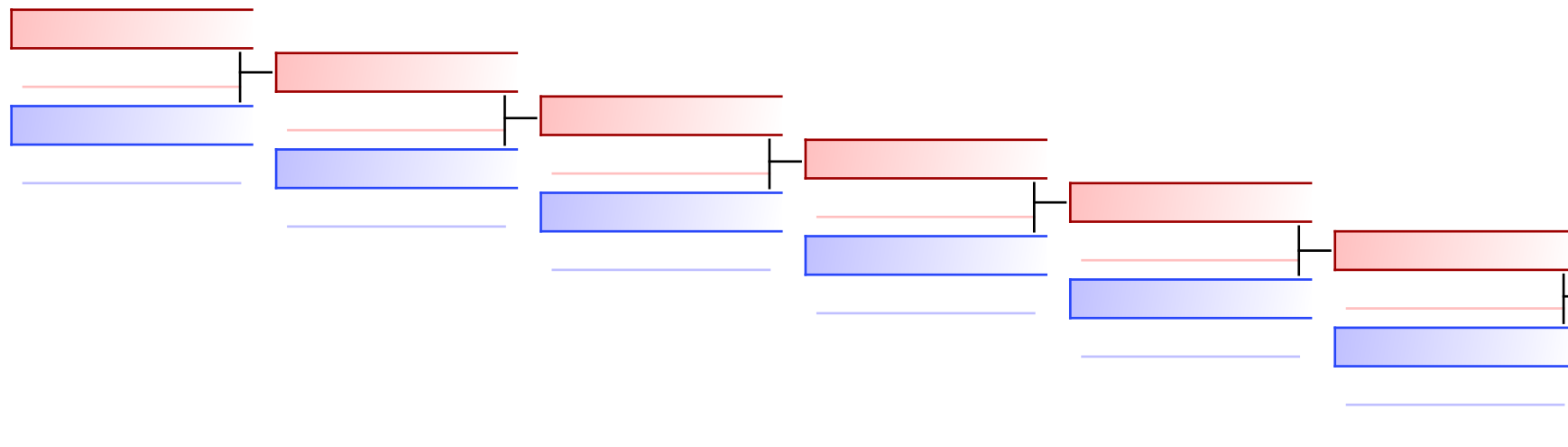

ALAZZEH EYAS_SAMER (SHARJAH SELF DEFENCE SPORTS CLUB) 5
 ROOHI BADR (SHARJAH SELF DEFENCE SPORTS CLUB) 5

REPECHAGE: (1)

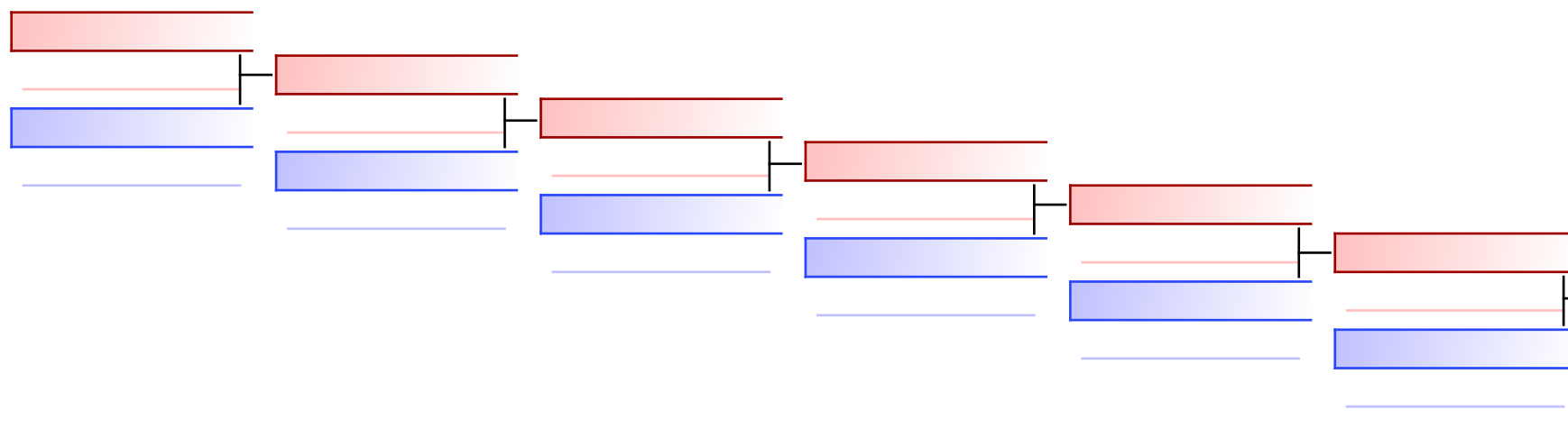

CRUZ LANCE_JOURNEY_EZEKIEL (BUSHIDO MARTIAL ARTS) 1
 PTS
 WAFAI ALAEDDIN (SHARJAH SELF DEFENCE SPORTS CLUB) 7

Referees:							
-----------	--	--	--	--	--	--	--

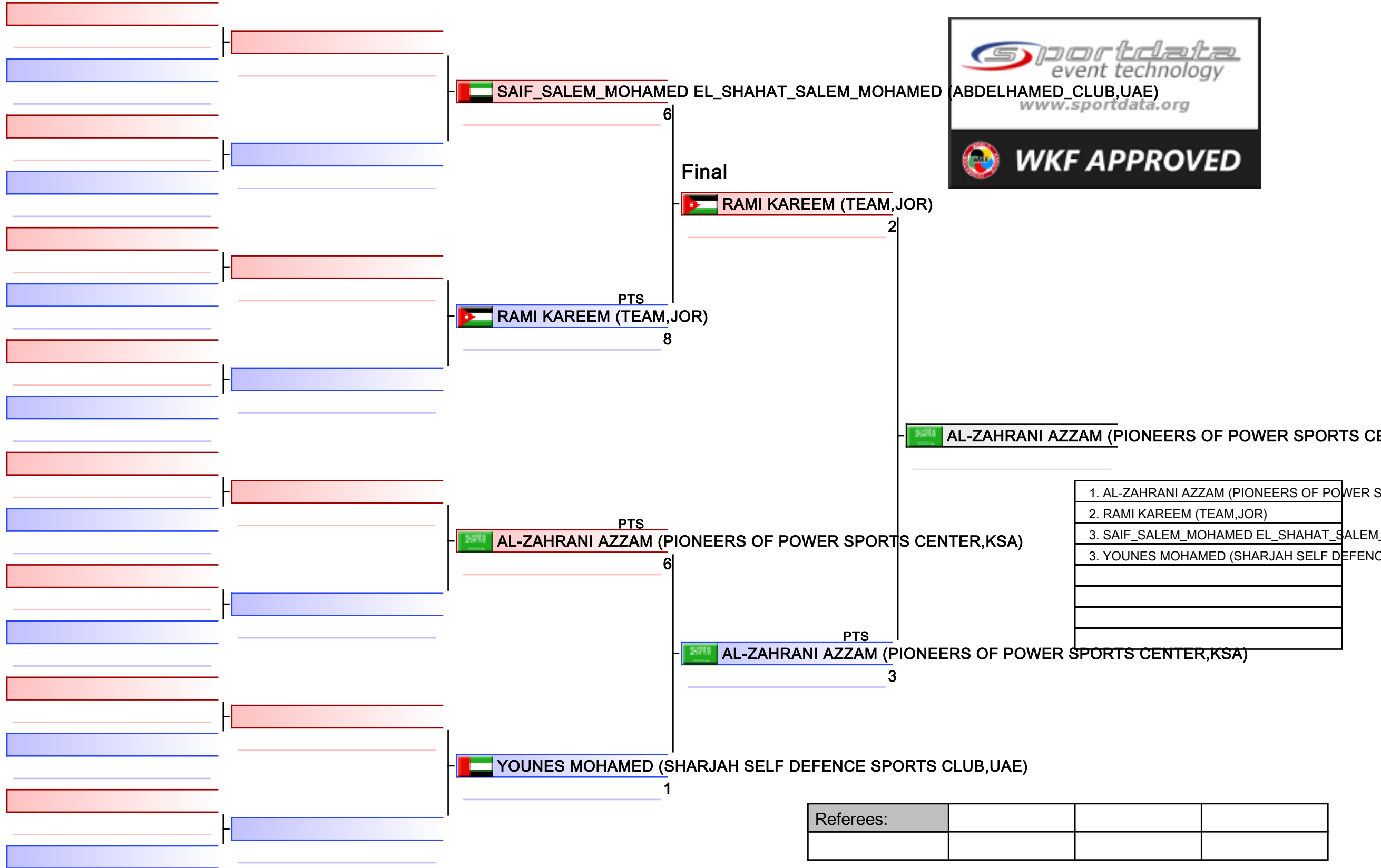

CADET KUMITE MALE -70 KG
EMIRATES SPORTS KARATE OPEN

Tatami

Pool
1

(c)sportdata GmbH & Co KG 2000-2023 (2023-03-05 14:27) v 10.0.0 build 1 (2023-01-21) License: UAE Karate Federation (expire 2023-07-31)

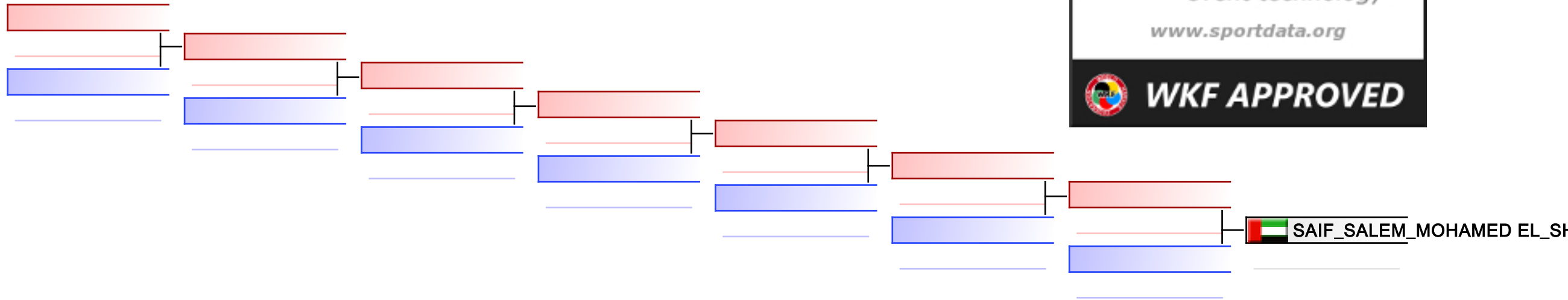

REPECHAGE: (1)

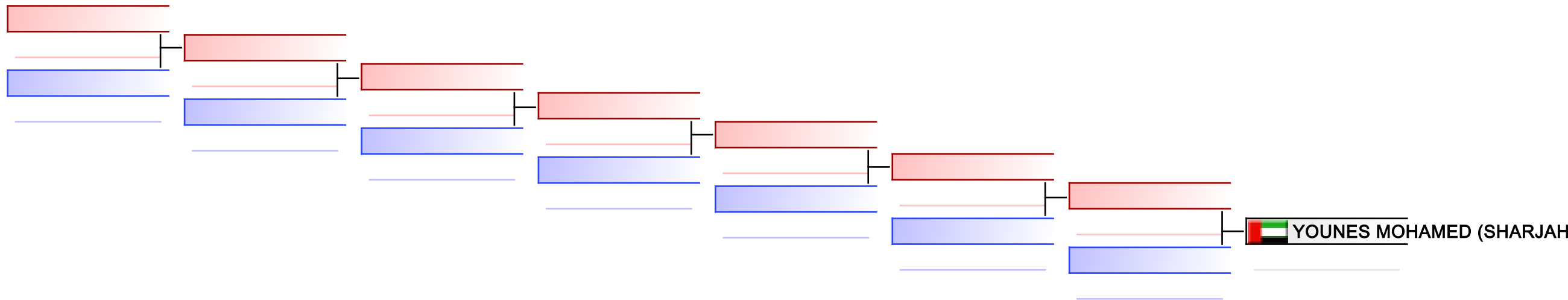

Referees:							
-----------	--	--	--	--	--	--	--

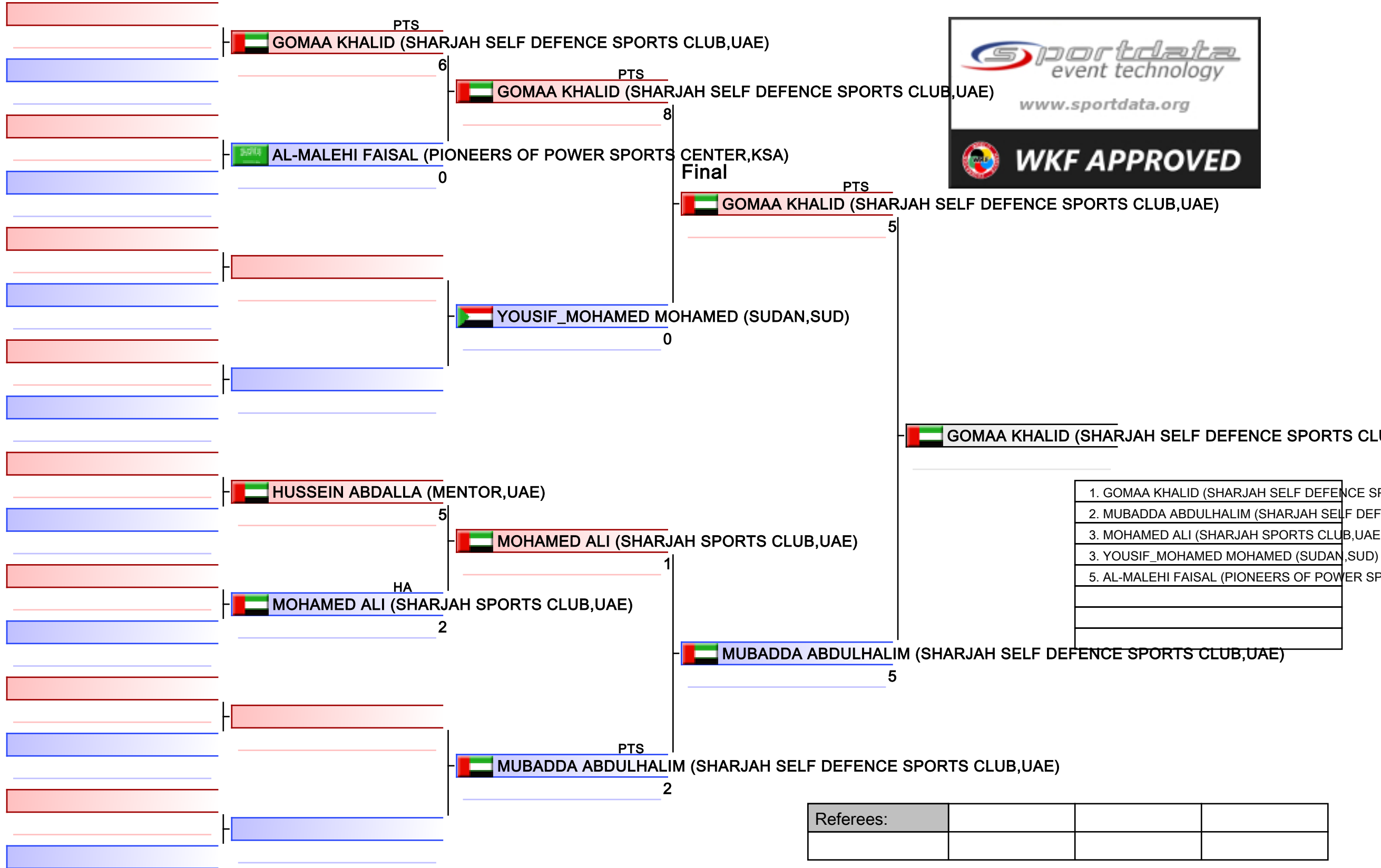

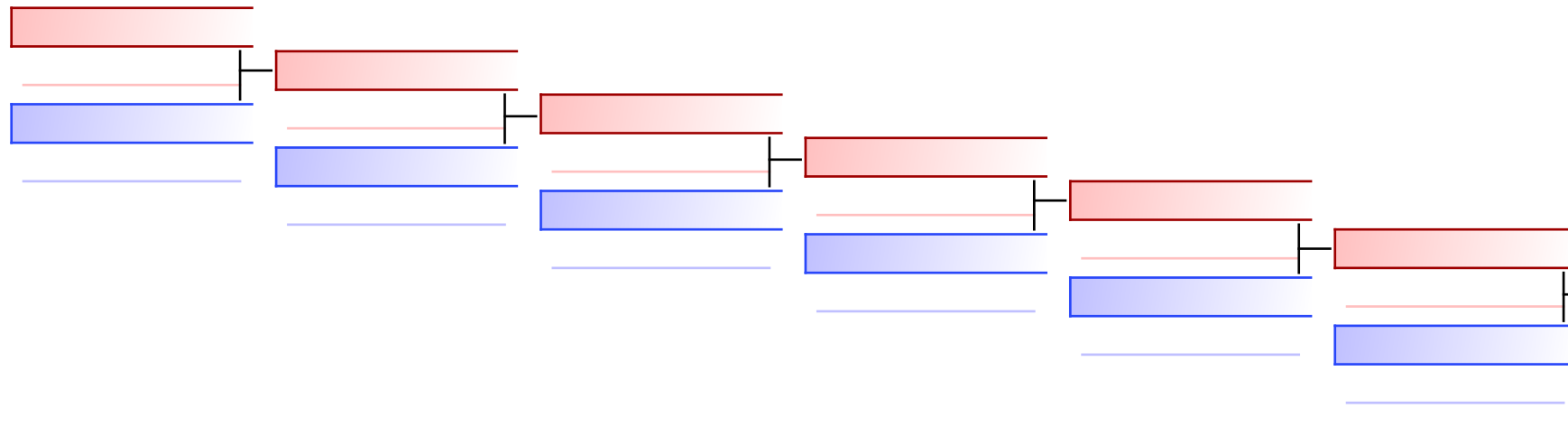

AL-MALEHI FAISAL (PIONEERS OF POWER SPORTS)
 PTS 7
 YOUSIF_MOHAMED MOHAMED
 YOUSIF_MOHAMED MOHAMED (SUDAN,SUD)
 8

REPECHAGE: (1)

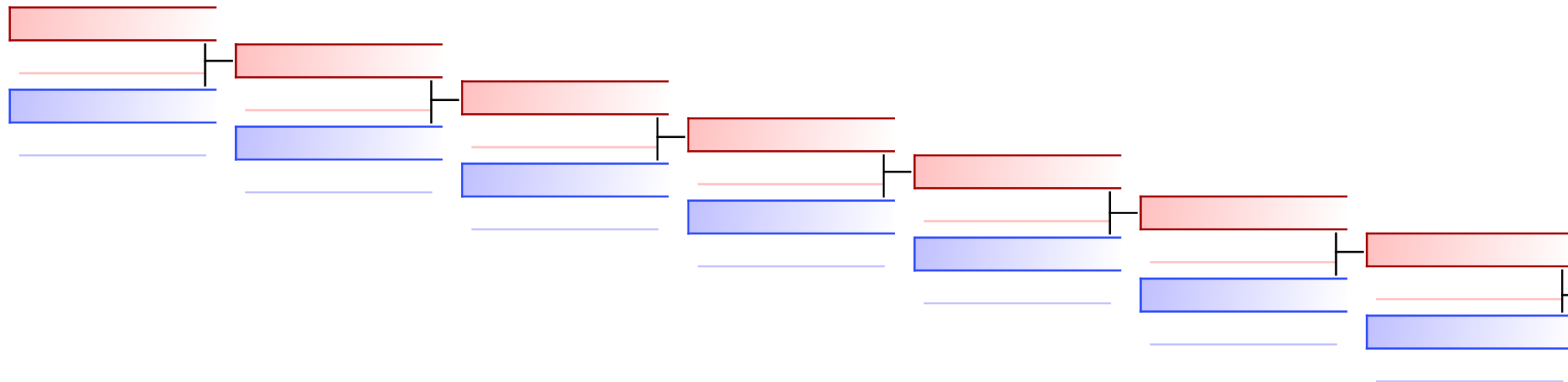

MOHAMED ALI (SHARJAH SPO)

Referees:							
-----------	--	--	--	--	--	--	--



EMIRATES SPORTS KARATE OPEN - 2023-03-03

Junior Kata Female



R1 G1/2 (2) Tatami 1 14:00(2023-03-03)

Competitors	Kata	1	2	3	4	5	6	7	TOTAL	Extra Total Rank
1 JOSHI MIMANSHA (INDIA TEAM,IND)	001 ANAN	(5.8)	5.8	6.3	6.9	(7.2)			19.0	19.0 2
2 ALAZZEH LINDA (SHARJAH SELF DEFENCE SPORTS CLUB,UAE)	021 GOJUSHIHO SHO	(6.2)	6.7	6.4	7.4	(7.6)			20.5	20.5 1

R1 G2/2 (2) Tatami 2 14:00(2023-03-03)

Competitors	Kata	1	2	3	4	5	6	7	TOTAL	Extra Total Rank
1 TAREQ MAYA (TEAM,JOR)	012 ENPI	(7.2)	7.4	7.2	7.5	(7.6)			22.1	22.1 1
2 MINESHKUMAR DIYA_MINESH_KUMAR (MARTIAL ARTS KARATE KIDS,UAE)	040 KANKU DAI	6.7	6.6	(7.1)	6.8	(6.0)			20.1	20.1 2

R2 Gold Medal Match Tatami 1 18:00(2023-03-03)

Competitors	Kata	1	2	3	4	5	6	7	TOTAL	Extra Total Rank
1 ALAZZEH LINDA (SHARJAH SELF DEFENCE SPORTS CLUB,UAE)	012 ENPI	7.5	7.5	7.5	(7.8)	(7.3)			22.5	22.5 2
2 TAREQ MAYA (TEAM,JOR)	021 GOJUSHIHO SHO	(8.0)	7.8	7.7	7.9	(7.5)			23.4	23.4 1

Results

1 TAREQ MAYA		JORDAN
2 ALAZZEH LINDA		UNITED ARAB EMIRATES
3 JOSHI MIMANSHA		INDIA
3 MINESHKUMAR DIYA MINESH KUMAR		UNITED ARAB EMIRATES





EMIRATES SPORTS KARATE OPEN - 2023-03-03

Junior Kata Male



R1 G1/2 (3) Tatami 1 14:10(2023-03-03)

Competitors	Kata	1	2	3	4	5	6	7	TOTAL	Extra Total Rank
1 MOHAMED ABDULGHANI (SHARJAH SPORTS CLUB,UAE)	021 GOJUSHIHO SHO	(7.6)	(7.4)	7.5	7.6	7.4			22.5	22.5 1
2 GEORGE JOUSHUA (MENTOR,UAE)										
3 ALMEJADY ALI (KUWAIT FORCE ACADEMY,KUW)	021 GOJUSHIHO SHO	(7.2)	6.6	(5.8)	6.4	6.8			19.8	19.8 2

R1 G2/2 (2) Tatami 2 14:10(2023-03-03)

Competitors	Kata	1	2	3	4	5	6	7	TOTAL	Extra Total Rank
1 KIAN FARAMARZ (AJSPORTSCLUB,UAE)	021 GOJUSHIHO SHO	7.2	(7.7)	7.5	7.3	(6.8)			22.0	22.0 1
2 GALAL AASEM (INSTITUTE,EGY)	012 ENPI	7.4	7.1	7.3	(7.5)	(6.6)			21.8	21.8 2

R2 Bronze Medal Match 1 Tatami 1 14:25(2023-03-03)

Competitors	Kata	1	2	3	4	5	6	7	TOTAL	Extra Total Rank
1 ALMEJADY ALI (KUWAIT FORCE ACADEMY,KUW)										

R2 Bronze Medal Match 2 Tatami 2 14:25(2023-03-03)

Competitors	Kata	1	2	3	4	5	6	7	TOTAL	Extra Total Rank
1 GALAL AASEM (INSTITUTE,EGY)										

R2 Gold Medal Match Tatami 2 18:00(2023-03-03)

Competitors	Kata	1	2	3	4	5	6	7	TOTAL	Extra Total Rank
1 MOHAMED ABDULGHANI (SHARJAH SPORTS CLUB,UAE)	041 KANKU SHO	(8.3)	7.4	7.5	7.7	(7.3)			22.6	22.6 1
2 KIAN FARAMARZ (AJSPORTSCLUB,UAE)	041 KANKU SHO	(8.0)	(7.0)	7.2	7.1	7.0			21.3	21.3 2

Results

1	MOHAMED ABDULGHANI		UNITED ARAB EMIRATES
2	KIAN FARAMARZ		UNITED ARAB EMIRATES
3	ALMEJADY ALI		KUWAIT
3	GALAL AASEM		EGYPT



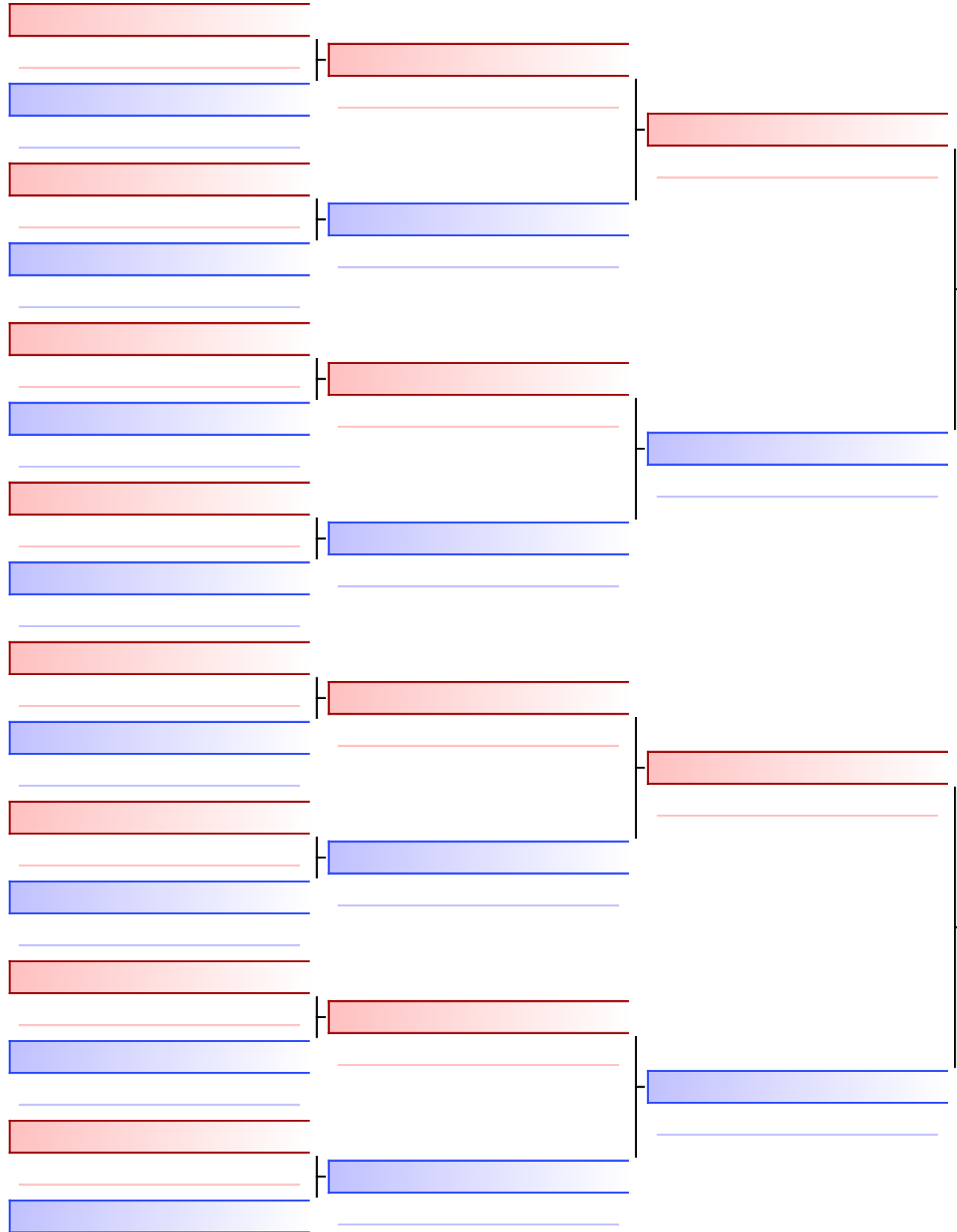

Final

JOSHI MIMANSHA (INDIA TEAM,IND)

1

DAVYDOVA VIKTORIIA (САРАТОВСКАЯ ОБЛАСТЬ,RUS)

PTS

DAVYDOVA VIKTORIIA (САРАТОВСКАЯ ОБЛАСТЬ,RUS)

5

1. DAVYDOVA VIKTORIIA (САРАТОВСКАЯ ОБЛАСТЬ,RUS)
2. JOSHI MIMANSHA (INDIA TEAM,IND)

Referees:			

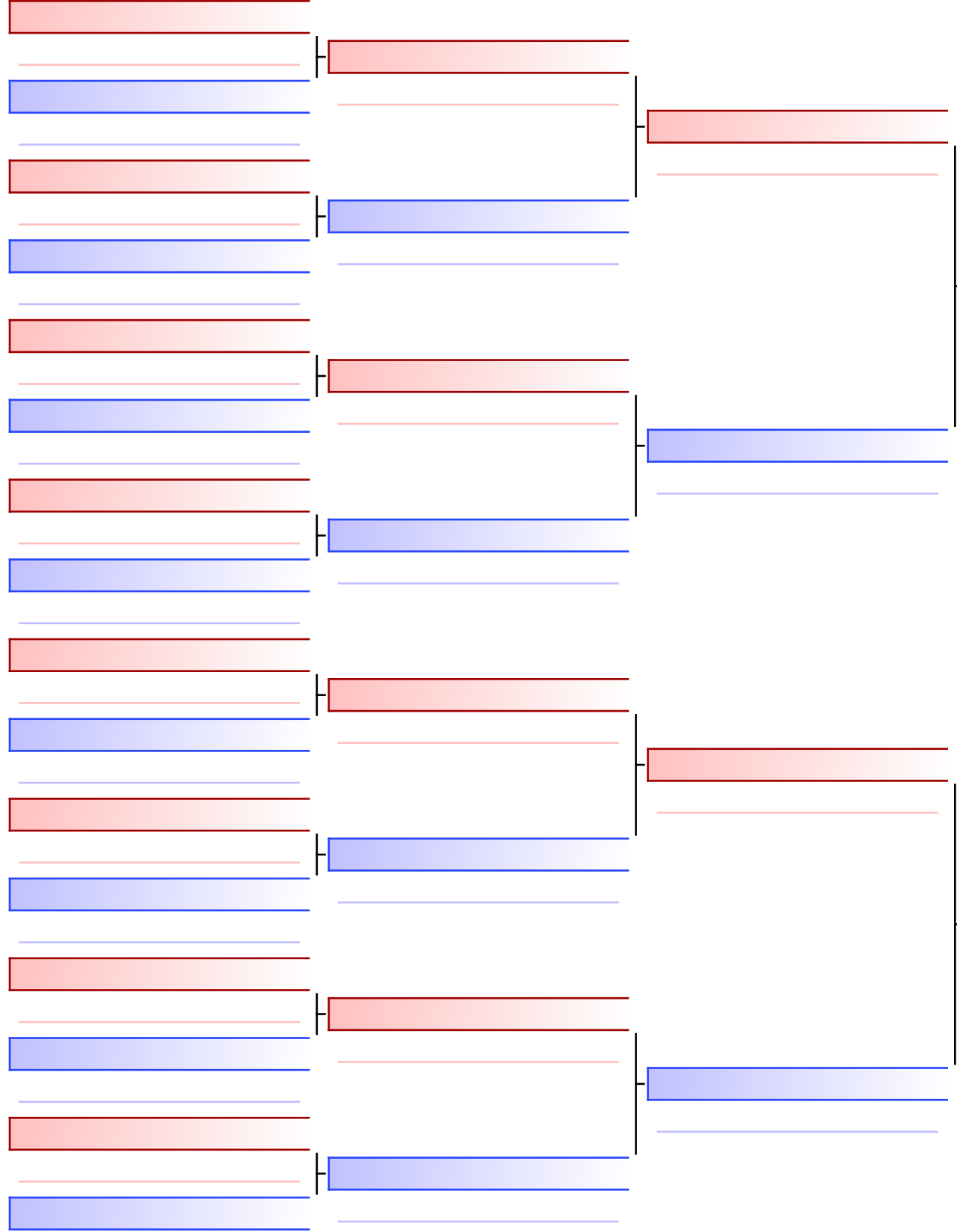

Final

SHANIA ANGEL (GOLDEN FIST AL QUSAIS CLUB, UAE)

0

SADUKOVA AIGUL (РЕСПУБЛИКА БАШКОРТОСТАН, RUS)

PTS

SADUKOVA AIGUL (РЕСПУБЛИКА БАШКОРТОСТАН, RUS)

8

1. SADUKOVA AIGUL (РЕСПУБЛИКА БАШКОРТОСТАН, RUS)
2. SHANIA ANGEL (GOLDEN FIST AL QUSAIS CLUB, UAE)

Referees:			

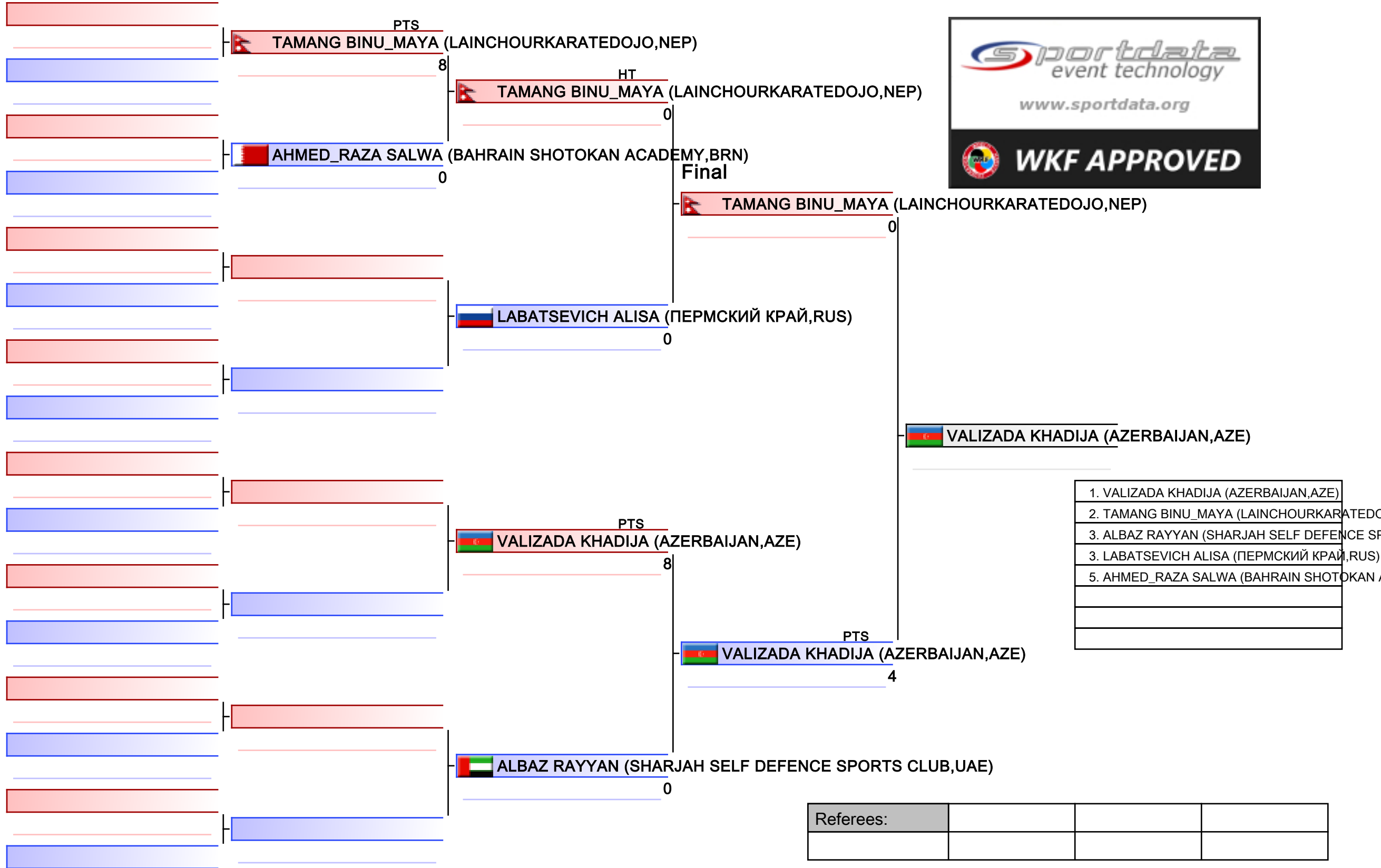

JUNIOR KUMITE FEMALE -59 KG

EMIRATES SPORTS KARATE OPEN

2023-03-03

Tatami
1 15:45

Pool
1

(c)sportdata GmbH & Co KG 2000-2023 (2023-03-05 14:27) v 10.0.0 build 1 (2023-01-21) License: UAE Karate Federation (expire 2023-07-31)

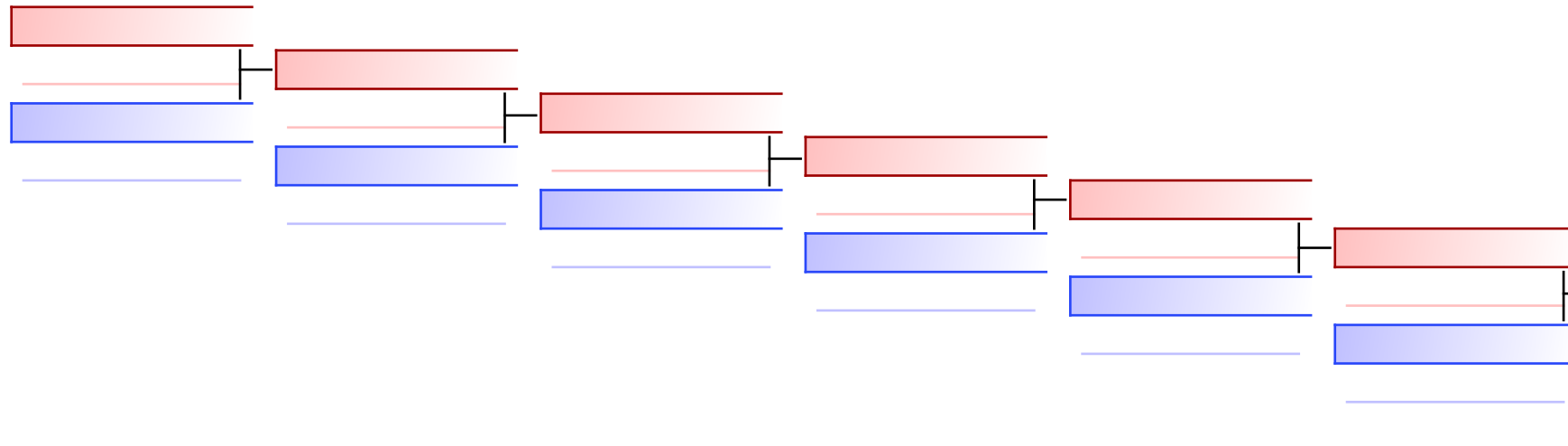

AHMED_RAZA SALWA (BAHRAIN SHOTOKAN ACAD) 0
PTS
LABATSEVICH ALISA (ПЕРМСКИЙ КРАЙ,RUS) 9

REPECHAGE: (1)

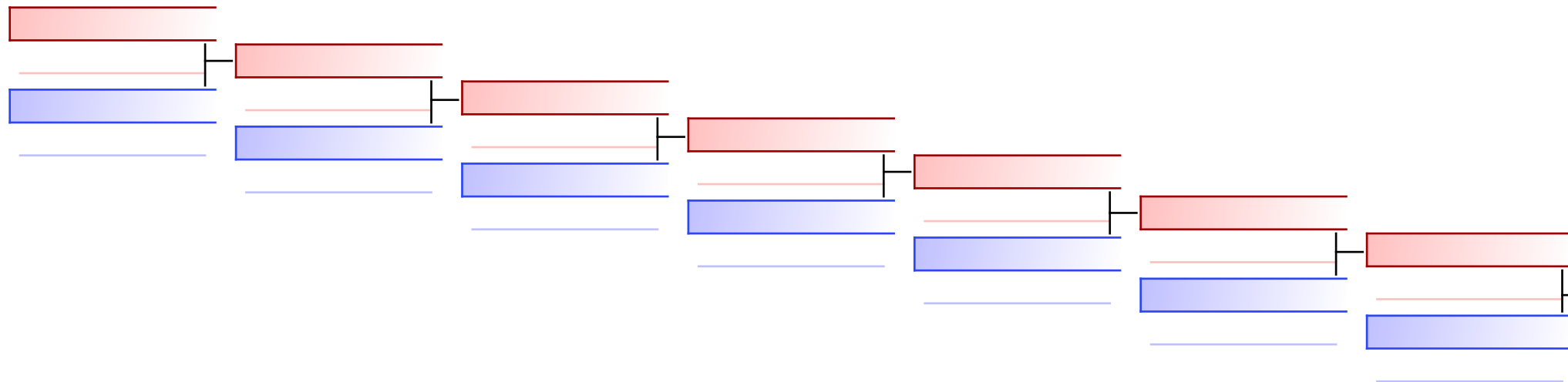

ALBAZ RAYYAN (SHARJAH SEL)

Referees:							
-----------	--	--	--	--	--	--	--

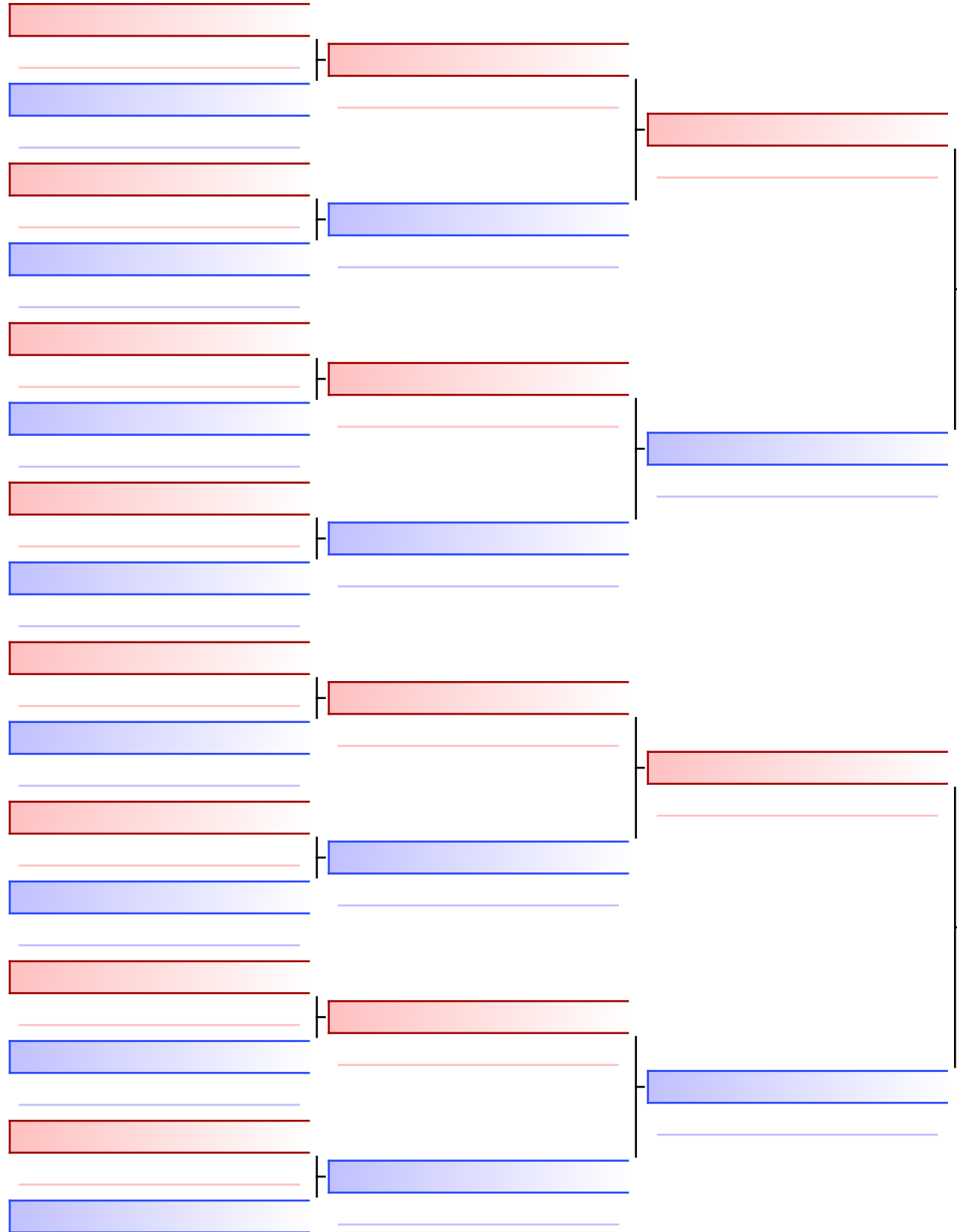

Final

PTS

ALAZZEH LINDA (SHARJAH SELF DEFENCE SPORTS CLUB,UAE)

8

ALAZZEH LINDA (SHARJAH SELF DEFENCE SPORTS CLUB,UAE)

MINESHKUMAR DIYA_MINESH_KUMAR (MARTIAL ARTS KARATE KIDS,UAE)

3

- | |
|---|
| 1. ALAZZEH LINDA (SHARJAH SELF DEFENCE SPORTS CLUB,UAE) |
| 2. MINESHKUMAR DIYA_MINESH_KUMAR (MARTIAL ARTS KARATE KIDS,UAE) |
| |
| |
| |
| |
| |
| |

Referees:			

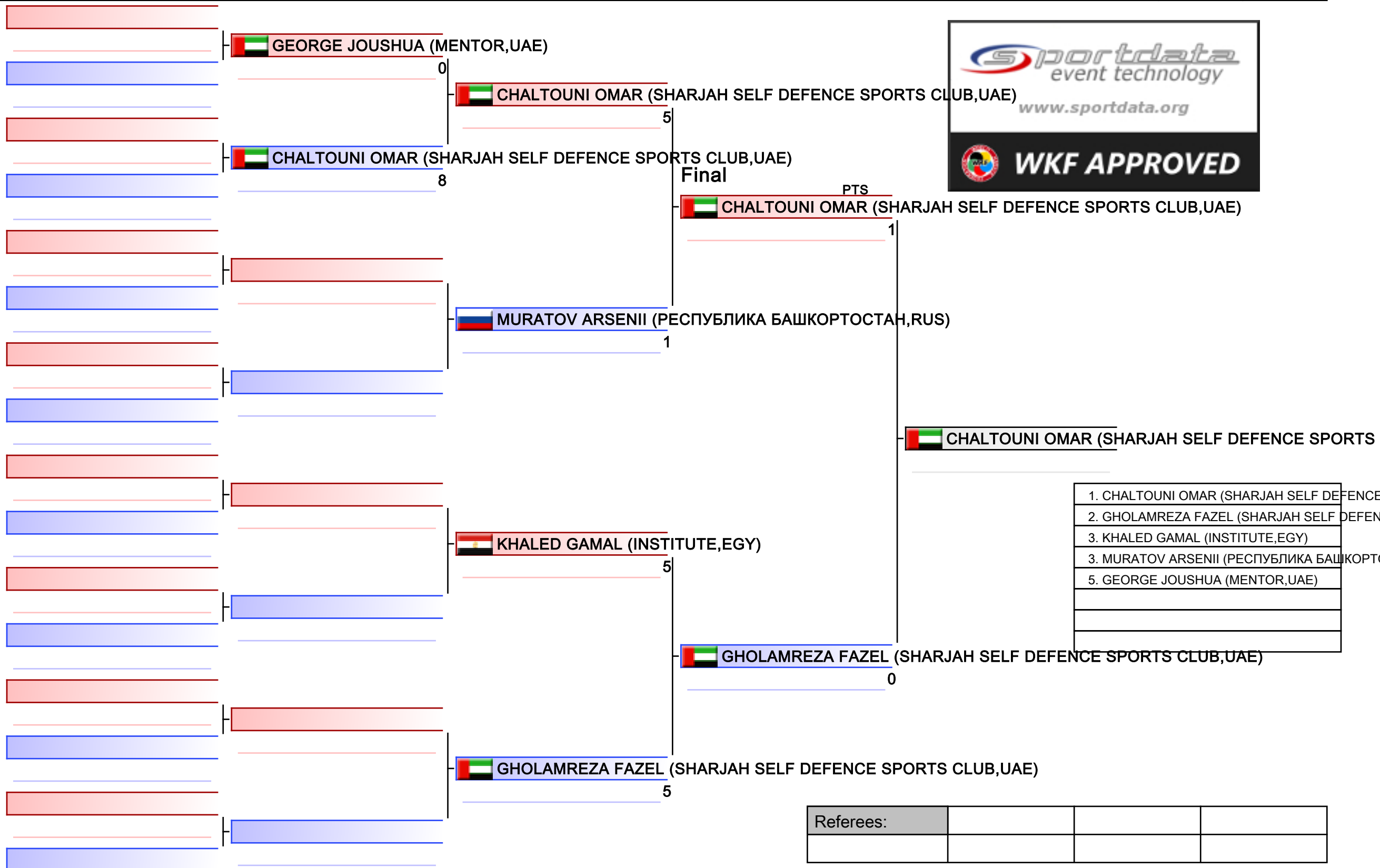

JUNIOR KUMITE MALE -55 KG
EMIRATES SPORTS KARATE OPEN

2023-03-03

Tatami
2 15:45

Pool
1

(c)sportdata GmbH & Co KG 2000-2023 (2023-03-05 14:27) v 10.0.0 build 1 (2023-01-21) License: UAE Karate Federation (expire 2023-07-31)

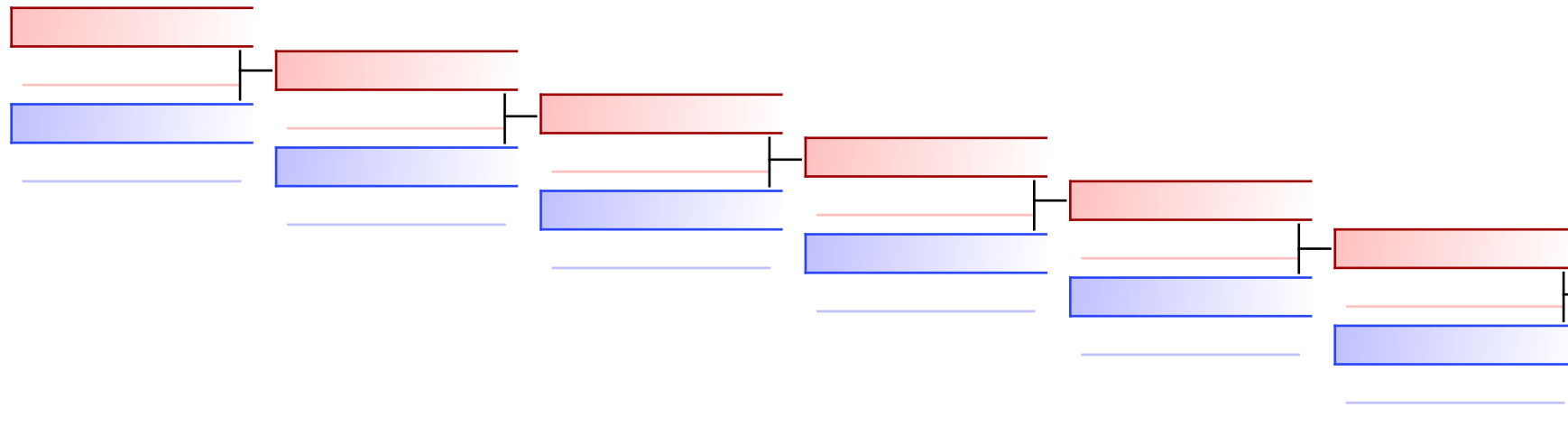

 **GEORGE JOUSHUA (MENTOR,UAE)**

 **MURATOV ARSENI (РЕСПУБЛИКА БАШКОРТОСТА)**

 **MURATOV ARSENI (РЕСПУБЛИКА БАШКОРТОСТА)**

1
9

REPECHAGE: (1)

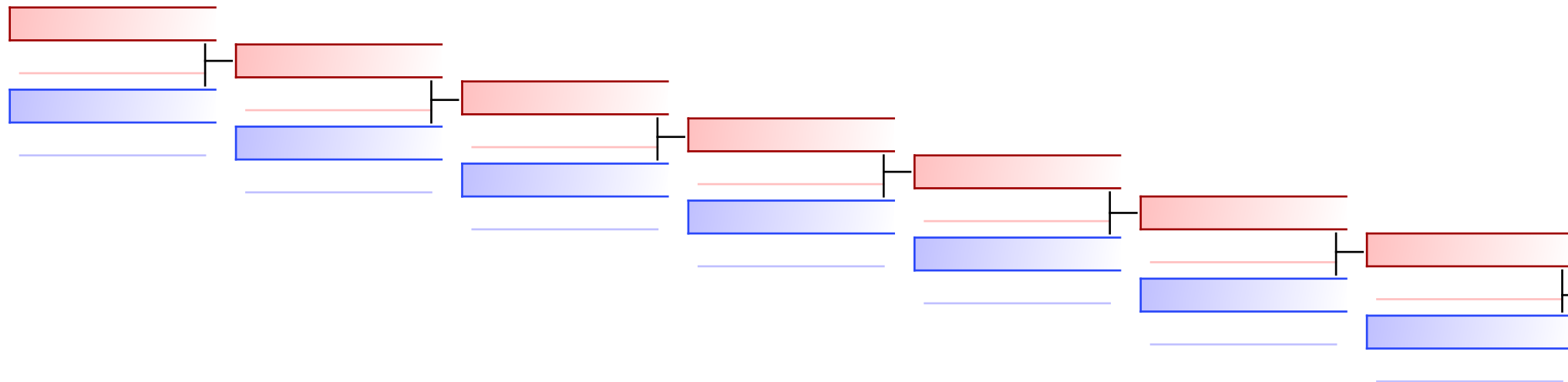

 **KHALED GAMAL (INSTITUTE,EGYPT)**

Referees:							
-----------	--	--	--	--	--	--	--

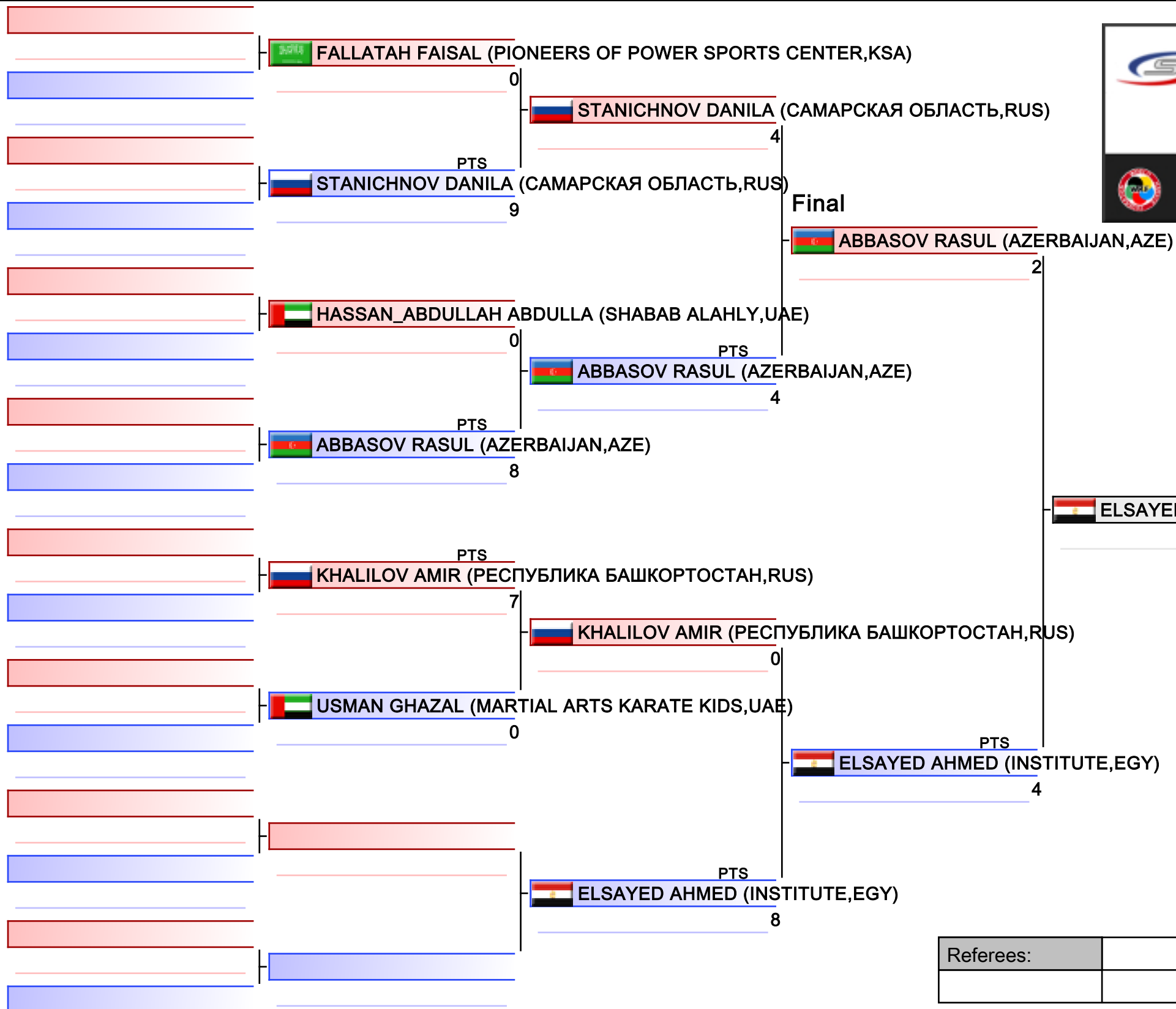

1. ELSAYED AHMED (INSTITUTE, EGY)
2. ABBASOV RASUL (AZERBAIJAN, AZE)
3. KHALILOV AMIR (РЕСПУБЛИКА БАШКОРТОСТАН, RUS)
3. STANICHNOV DANILA (САМАРСКАЯ ОБЛАСТЬ, RUS)
5. HASSAN_ABDULLAH ABDULLA (SHABAB ALAHLI, UAE)

Referees:			

JUNIOR KUMITE MALE -61 KG
EMIRATES SPORTS KARATE OPEN

2023-03-03 Tatami 3 15:55 Pool 1

(c)sportdata GmbH & Co KG 2000-2023 (2023-03-05 14:28) v 10.0.0 build 1 (2023-01-21) License: UAE Karate Federation (expire 2023-07-31)

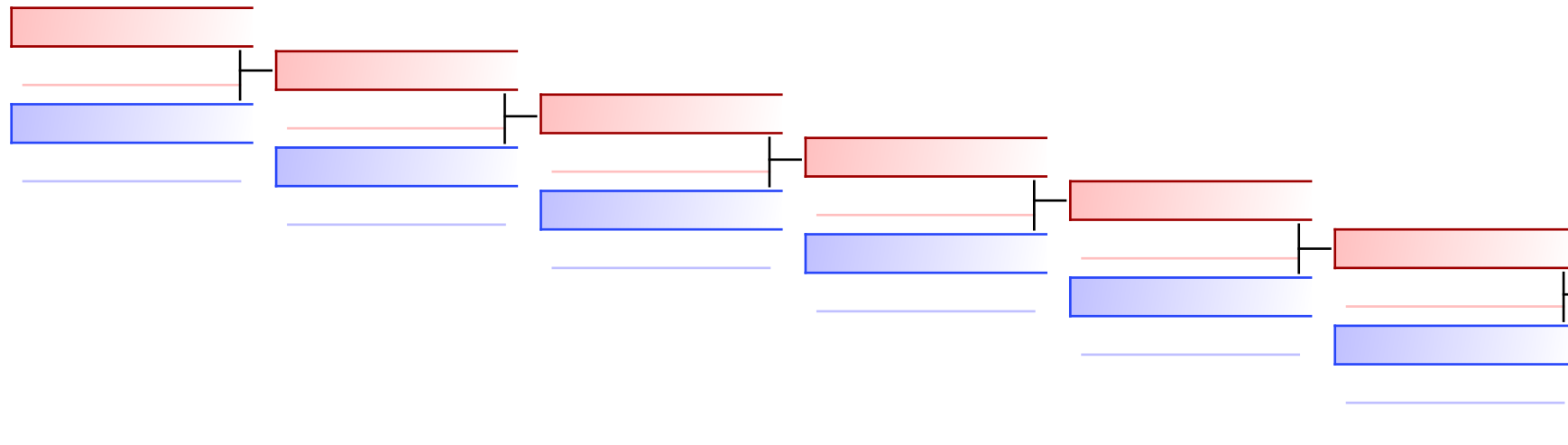

HASSAN_ABDULLAH ABDULLA (SHABAB ALAHLI, U
 PTS | STANICHNOV DANILA (САМАР
 STANICHNOV DANILA (САМАРСКАЯ ОБЛАСТЬ, RU
 1
 2

REPECHAGE: (1)

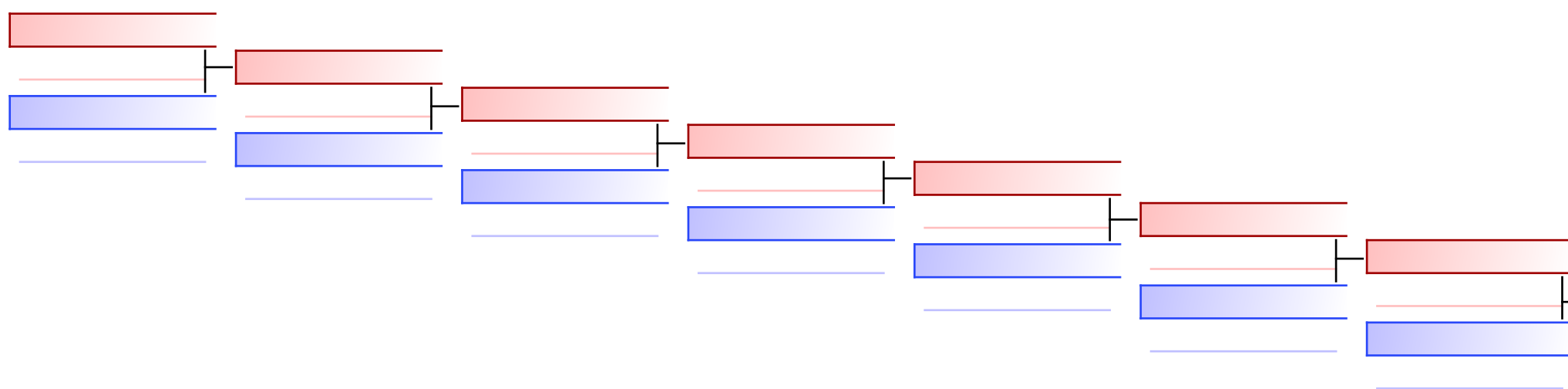

KHALILOV AMIR (РЕСПУБЛИКА

Referees:							
-----------	--	--	--	--	--	--	--

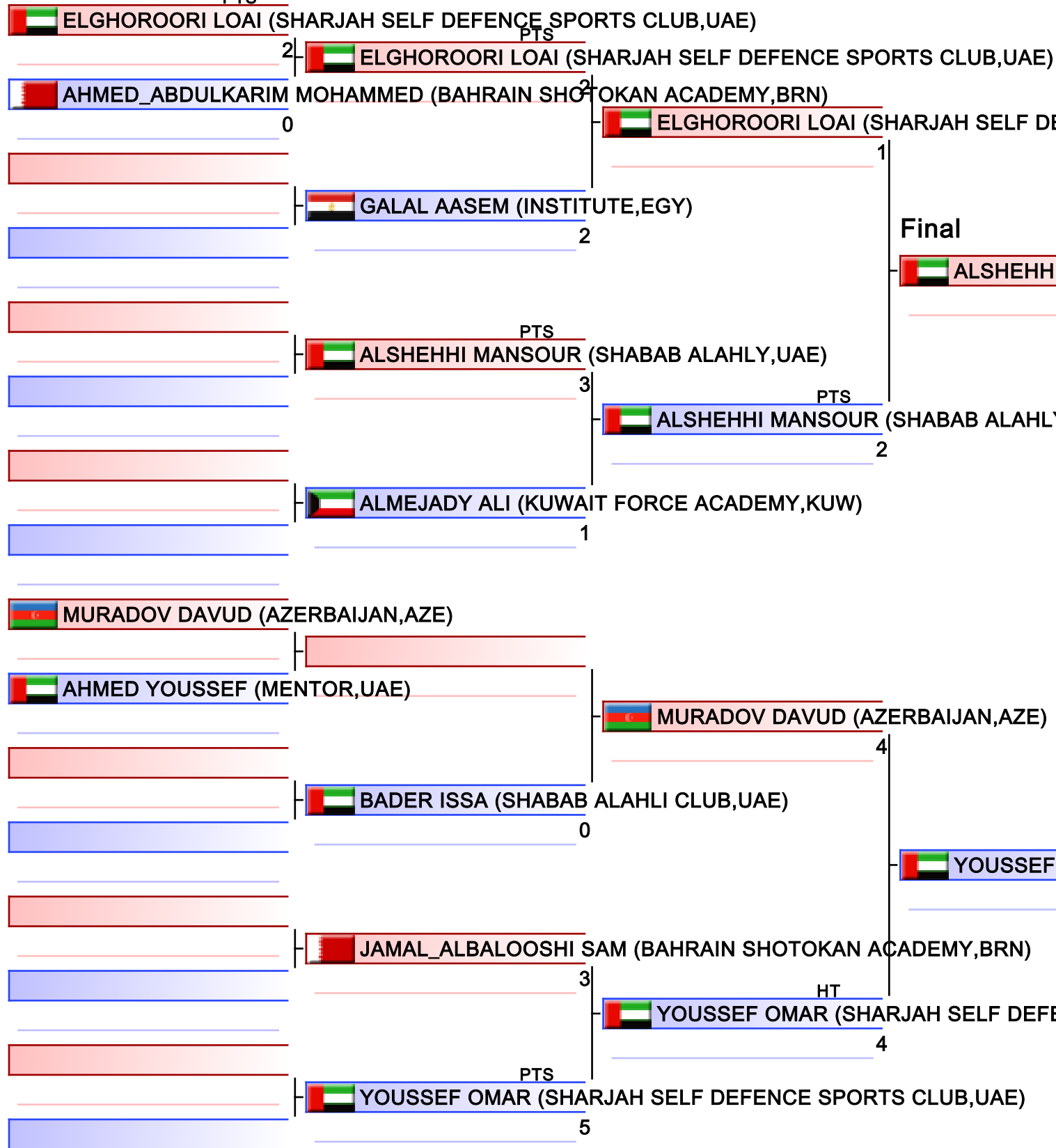

1. YOUSSEF OMAR (SHARJAH SELF DEFENCE SPORTS CLUB, UAE)
2. ALSHEHHI MANSOUR (SHABAB ALAHLI, UAE)
3. ELGHOROORI LOAI (SHARJAH SELF DEFENCE SPORTS CLUB, UAE)
3. MURADOV DAVUD (AZERBAIJAN, AZE)
5. ALMEJADY ALI (KUWAIT FORCE ACADEMY, KUW)
5. JAMAL_ALBALOOSHI SAM (BAHRAIN SHOTOKAN ACADEMY, BRN)

Referees:			

JUNIOR KUMITE MALE -68 KG
EMIRATES SPORTS KARATE OPEN

2023-03-03

Tatami
4 16:10

Pool
1

(c)sportdata GmbH & Co KG 2000-2023 (2023-03-05 14:28) v 10.0.0 build 1 (2023-01-21) License: UAE Karate Federation (expire 2023-07-31)

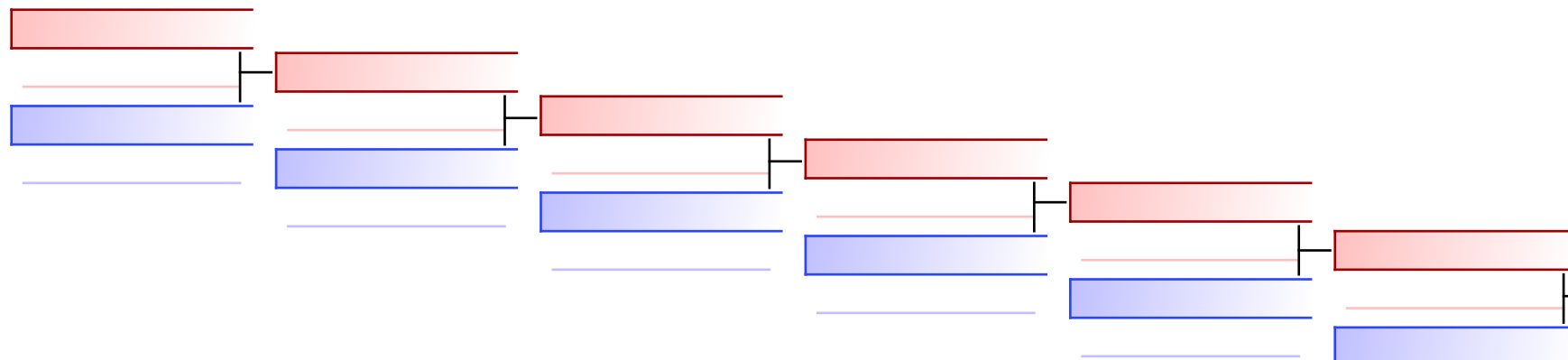

ALMEJADY ALI (KUWAIT FORCE ACADEMY, KUW) | PTS 0
 ELGHOROORI LOAI (SHARJAH SELF DEFENCE SPO) | PTS 4

REPECHAGE: (1)

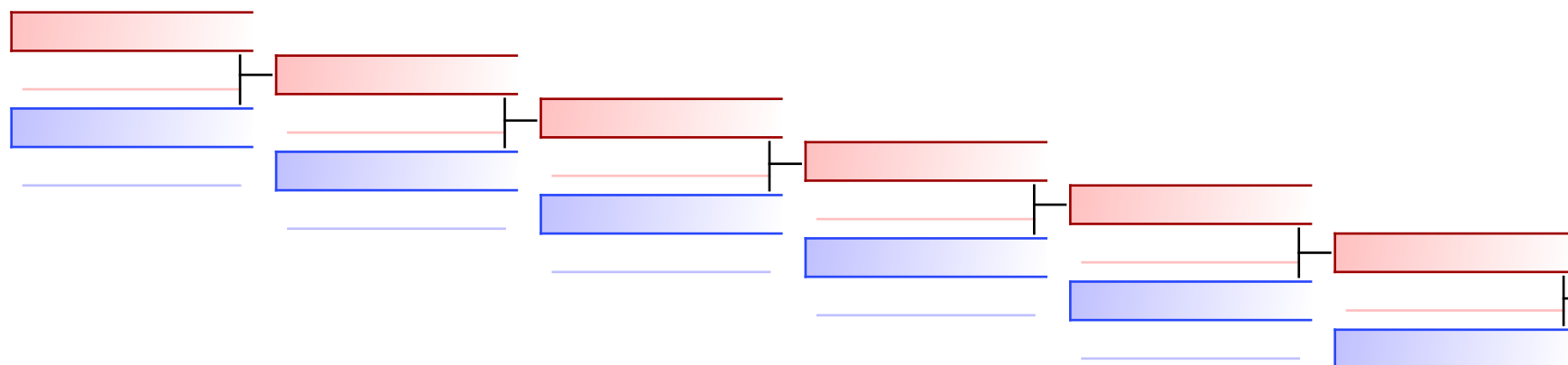

JAMAL_ALBALOOSHI SAM (BAHRAIN SHOTOKAN A) | PTS 0
 MURADOV DAVUD (AZERBAIJAN, AZE) | PTS 8

Referees:							
-----------	--	--	--	--	--	--	--

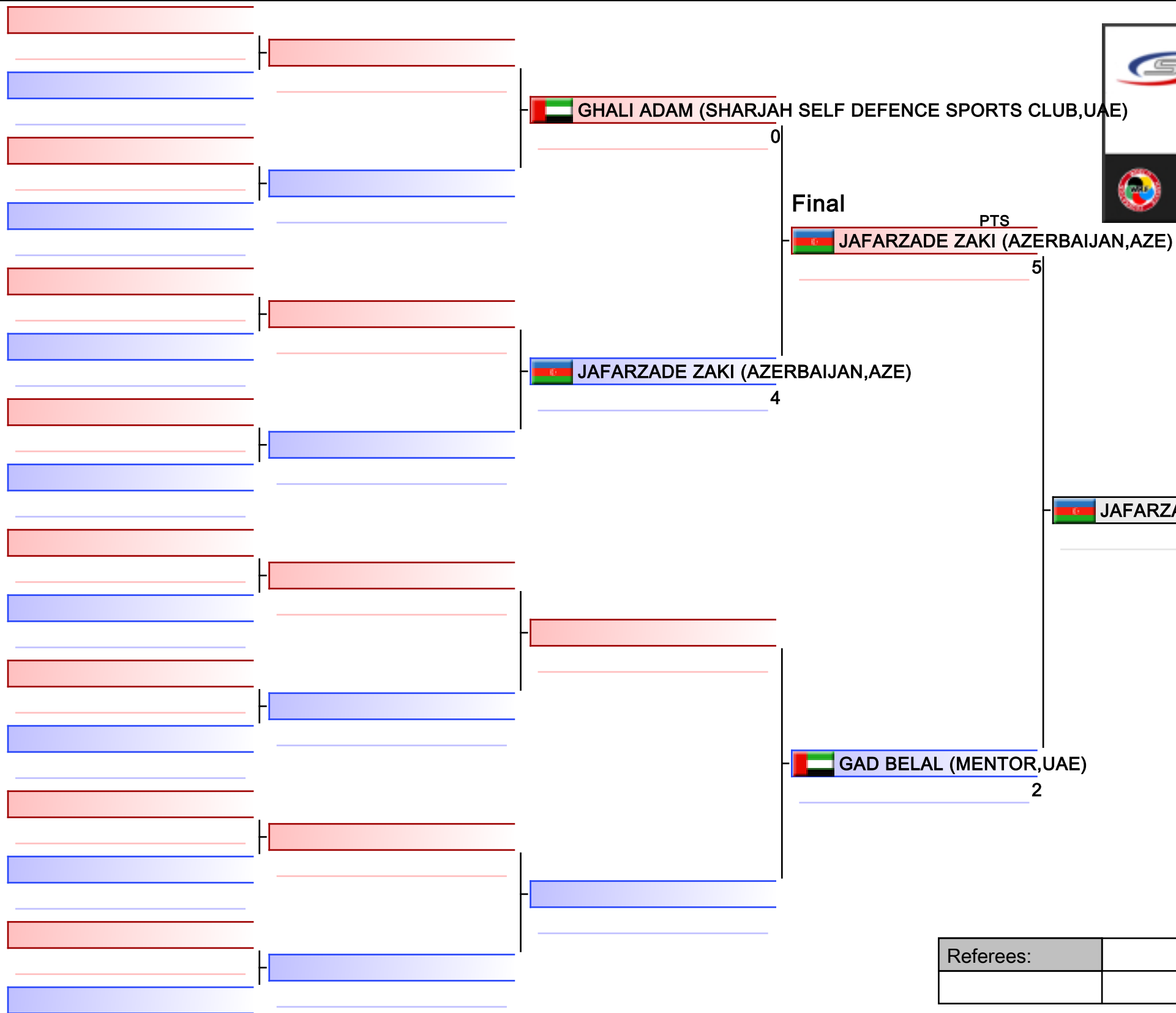

1. JAFARZADE ZAKI (AZERBAIJAN,AZE)
2. GAD BELAL (MENTOR,UAE)

Referees:			

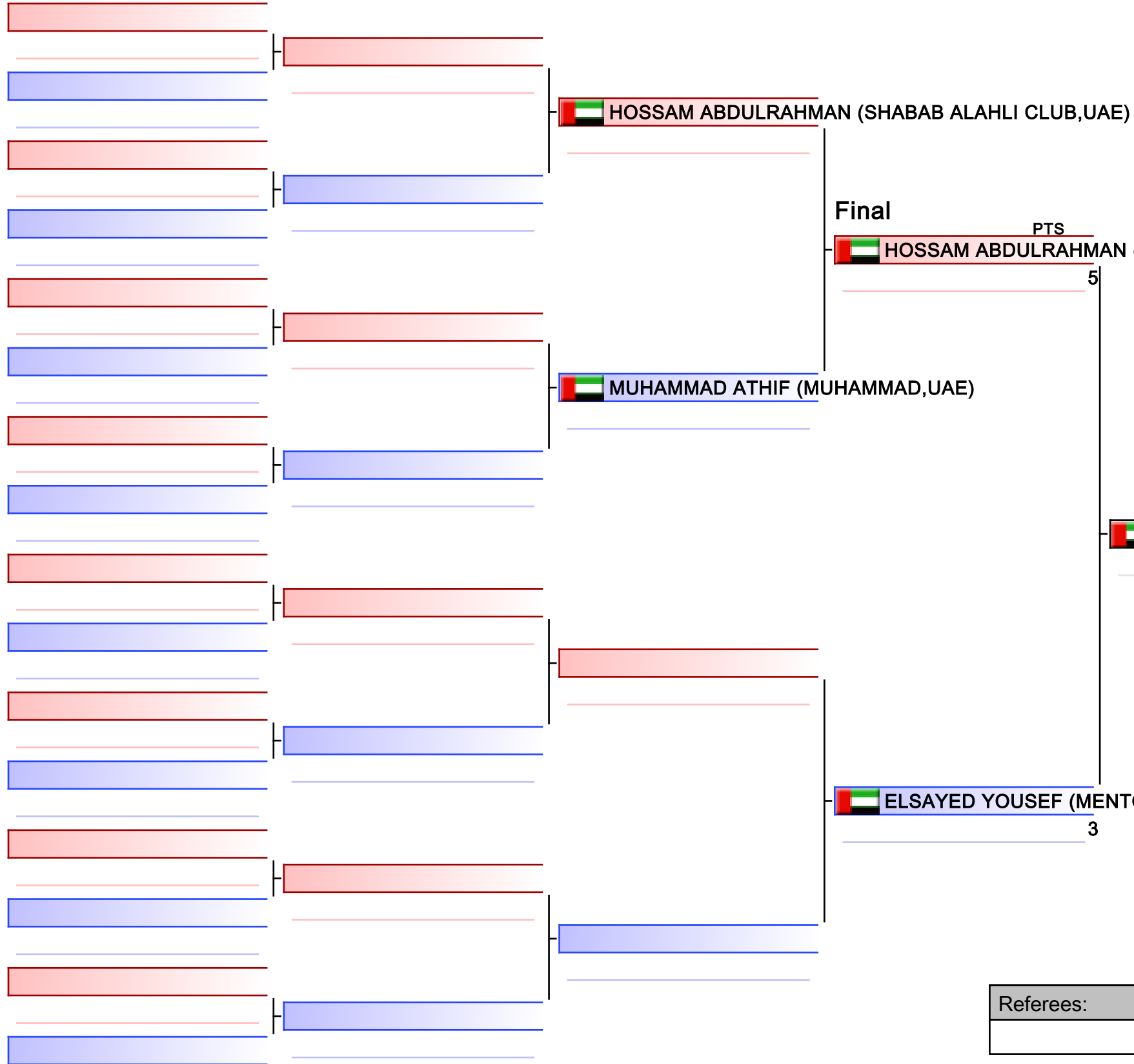

1. HOSSAM ABDULRAHMAN (SHABAB ALAHLI CLUB,UAE)
2. ELSAYED YOUSEF (MENTOR,UAE)

Referees:			



EMIRATES SPORTS KARATE OPEN - 2023-03-03 KIDS KATA FEMALE 10 - 11 YEARS



R1 G1/2 (10) Tatami 1 09:45(2023-03-04)

Competitors	Kata	1	2	3	4	5	6	7	TOTAL	Extra Total Rank
1 BASUONI DEMA (MENTOR,UAE)		5.9	(5.7)	5.9	(6.3)	6.3			18.1	18.1 9
2 MAHMOUD BISAN (SHARJAH SPORTS CLUB,UAE)		6.4	6.4	(6.0)	(7.3)	6.6			19.4	19.4 6
3 ALALI DANA (KUWAIT FORCE ACADEMY,KUW)		6.5	7.2	6.5	(7.6)	(6.3)			20.2	20.2 3
4 MOHAMED LAMAR (SHABAB ALAHLI CLUB,UAE)		6.4	(7.4)	(6.3)	7.0	6.7			20.1	20.1 4
5 OUESLATI ISRAA (SHARJAH SPORTS CLUB,UAE)		(6.1)	6.8	6.2	(7.5)	6.5			19.5	19.5 5
6 KIBIREVA ALEXANDRA (TATSUJIN KARATE SCHOOL RUS,RUS)		7.4	7.2	6.4	(7.5)	(6.3)			21.0	21.0 1
7 EHAB MALAK (SHARJAH SPORTS CLUB,UAE)		(6.1)	6.3	6.1	(7.2)	6.1			18.5	18.5 7
8 NATH KIARA (MARTIAL ARTS KARATE KIDS,UAE)		6.0	(5.8)	6.0	(6.8)	6.0			18.0	18.0 10
9 MOHAMED MAYAR (SHABAB ALAHLI CLUB,UAE)		(7.1)	7.1	6.3	(6.1)	6.9			20.3	20.3 2
10 ALNAHAR SANA (SHARJAH SELF DEFENCE SPORTS CLUB,UAE)		6.3	5.8	(5.7)	(6.5)	6.1			18.2	18.2 8

R1 G2/2 (10) Tatami 2 09:45(2023-03-04)

Competitors	Kata	1	2	3	4	5	6	7	TOTAL	Extra Total Rank
1 MAHYOUB RAZAN (SHABAB ALAHLI CLUB,UAE)		(6.6)	(7.6)	6.8	6.6	7.4			20.8	20.8 5
2 SAMSON ELIZABETH (SHITOKAI MURAYAMA UAE,UAE)		6.5	(7.2)	6.9	(6.2)	6.9			20.3	20.3 6
3 KANAN EMAN (SHARJAH SPORTS CLUB,UAE)		(6.8)	(7.8)	7.1	6.8	7.6			21.5	21.5 3
4 BHIDWAL FATIMA_AAMIR (PAKISTAN_PAK)		6.2	6.3	(5.6)	6.5	(6.8)			19.0	19.0 7
5 HAITHAM YARA (SHARJAH SPORTS CLUB,UAE)		(5.0)	(5.0)	5.0	5.0	5.0			15.0	15.0 10
6 AFSHAR SOFI (RUSSIAN FEDERATION,RUS)		(7.3)	(8.1)	7.8	7.3	7.5			22.6	22.6 1
7 AASHER ALIZA (DEV,UAE)		6.2	5.8	(5.3)	5.6	(6.4)			17.6	17.6 9
8 EHAB SARA (SHARJAH SPORTS CLUB,UAE)		7.0	(7.4)	7.4	(6.3)	6.6			21.0	21.0 4
9 KHALID DANA (SHABAB ALAHLI CLUB,UAE)		7.1	(7.5)	7.2	(6.5)	7.3			21.6	21.6 2
10 SAID SALMA (MENTOR,UAE)		(6.6)	5.8	(5.4)	5.8	6.0			17.6	17.6 8

R2-G1 Tatami 1 10:15(2023-03-04)

Competitors	Kata	1	2	3	4	5	6	7	TOTAL	Extra Total Rank
1 ALALI DANA (KUWAIT FORCE ACADEMY,KUW)		(7.8)	6.9	6.6	7.2	(6.5)			20.7	20.7 3
2 MOHAMED MAYAR (SHABAB ALAHLI CLUB,UAE)		(7.5)	7.1	6.7	6.7	(6.6)			20.5	20.5 4
3 MOHAMED LAMAR (SHABAB ALAHLI CLUB,UAE)		(7.7)	6.8	(6.4)	7.4	6.8			21.0	21.0 2
4 KIBIREVA ALEXANDRA (TATSUJIN KARATE SCHOOL RUS,RUS)		(7.9)	7.3	(6.8)	7.3	6.9			21.5	21.5 1

R2-G2 Tatami 2 10:15(2023-03-04)

Competitors	Kata	1	2	3	4	5	6	7	TOTAL	Extra Total Rank
1 KHALID DANA (SHABAB ALAHLI CLUB,UAE)		(6.8)	(7.5)	7.3	7.2	7.5			22.0	22.0 2
2 AFSHAR SOFI (RUSSIAN FEDERATION,RUS)		7.2	(7.1)	(8.0)	7.5	7.9			22.6	22.6 1
3 EHAB SARA (SHARJAH SPORTS CLUB,UAE)		(6.4)	6.8	(7.2)	7.1	7.2			21.1	21.1 3
4 KANAN EMAN (SHARJAH SPORTS CLUB,UAE)		6.6	(6.5)	6.8	6.8	(7.5)			20.2	20.2 4

R3 Bronze Medal Match 1 Tatami 1 10:30(2023-03-04)

Competitors	Kata	1	2	3	4	5	6	7	TOTAL	Extra Total Rank
1 MOHAMED LAMAR (SHABAB ALAHLI CLUB,UAE)		7.4	(7.8)	6.8	7.4	(6.6)			21.6	21.6 1
2 EHAB SARA (SHARJAH SPORTS CLUB,UAE)		6.9	(7.4)	(6.3)	6.5	6.4			19.8	19.8 2

R3 Bronze Medal Match 2 Tatami 2 10:30(2023-03-04)

Competitors	Kata	1	2	3	4	5	6	7	TOTAL	Extra Total Rank
1 ALALI DANA (KUWAIT FORCE ACADEMY,KUW)		(7.2)	7.2	7.2	(7.3)	7.2			21.6	21.6 2





EMIRATES SPORTS KARATE OPEN - 2023-03-03
KIDS KATA FEMALE 10 - 11 YEARS



2	KHALID DANA (SHABAB ALAHLI CLUB,UAE)		7.5	(7.7)	(7.4)	7.6	7.5						22.6		22.6	1
---	--------------------------------------	--	-----	-------	-------	-----	-----	--	--	--	--	--	------	--	------	---

R3 Gold Medal Match Tatami 1 10:35(2023-03-04)

Competitors	Kata	1	2	3	4	5	6	7	TOTAL	Extra Total Rank
1 KIBIREVA ALEXANDRA (TATSUJIN KARATE SCHOOL RUS,RUS)		6.9	7.1	7.5	(7.6)	(6.7)			21.5	21.5 1
2 AFSHAR SOFI (RUSSIAN FEDERATION,RUS)		(6.8)	(7.3)	7.0	7.3	6.9			21.2	21.2 2

Results

1	KIBIREVA ALEXANDRA		RUSSIAN FEDERATION
2	AFSHAR SOFI		RUSSIAN FEDERATION
3	MOHAMED LAMAR		UNITED ARAB EMIRATES
3	KHALID DANA		UNITED ARAB EMIRATES
5	EHAB SARA		UNITED ARAB EMIRATES
5	ALALI DANA		KUWAIT
7	MOHAMED MAYAR		UNITED ARAB EMIRATES
7	KANAN EMAN		UNITED ARAB EMIRATES
9	OUESLATI ISRAA		UNITED ARAB EMIRATES
9	MAHYOUB RAZAN		UNITED ARAB EMIRATES
11	MAHMOUD BISAN		UNITED ARAB EMIRATES
11	SAMSON ELIZABETH		UNITED ARAB EMIRATES
13	EHAB MALAK		UNITED ARAB EMIRATES
13	BHIDWAL FATIMA AAMIR		PAKISTAN
15	ALNAHAR SANA		UNITED ARAB EMIRATES
15	SAID SALMA		UNITED ARAB EMIRATES
17	BASUONI DEMA		UNITED ARAB EMIRATES
17	AASHER ALIZA		UNITED ARAB EMIRATES
19	NATH KIARA		UNITED ARAB EMIRATES
19	HAITHAM YARA		UNITED ARAB EMIRATES





EMIRATES SPORTS KARATE OPEN - 2023-03-03
KIDS KATA FEMALE 6 - 7 YEARS



R1 G1/2 (8) Tatami 1 09:00(2023-03-04)

Competitors	Kata	1	2	3	4	5	6	7	TOTAL	Extra Total Rank
1 ABDELSALAM ROKAIA (MENTOR,UAE)		6.3	(7.2)	6.5	(5.3)	6.8			19.6	19.6 3
2 ALHAJJAJ ALYAZIA (SHABAB ALAHLI CLUB,UAE)		6.6	(7.4)	7.0	(5.6)	7.4			21.0	21.0 1
3 SHERIF DOUGANA (SHARJAH SELF DEFENCE SPORTS CLUB,UAE)		6.5	(7.0)	6.6	(5.4)	6.6			19.7	19.7 2
4 SHAH AAIRA (MENTOR,UAE)		6.1	6.0	5.5	(5.2)	(7.1)			17.6	17.6 6
5 AASHER AIZA (DEV,UAE)		5.9	6.2	5.7	(5.3)	(7.3)			17.8	17.8 5
6 GHANIM HALA (MENTOR,UAE)		6.0	6.3	5.8	(5.1)	(7.0)			18.1	18.1 4
7 ALSHAHRANI SAMA (MENTOR,UAE)		5.5	5.5	5.4	(5.2)	(6.3)			16.4	16.4 8
8 ALSHAHRANI RANA (MENTOR,UAE)		5.7	(5.3)	5.5	5.3	(6.1)			16.5	16.5 7

R1 G2/2 (7) Tatami 2 09:00(2023-03-04)

Competitors	Kata	1	2	3	4	5	6	7	TOTAL	Extra Total Rank
1 BASUONI REEM (MENTOR,UAE)		(7.5)	7.0	(5.7)	7.2	6.6			20.8	20.8 2
2 KAMOUN MALAK (SHARJAH SPORTS CLUB,UAE)		7.3	7.2	(6.5)	(7.5)	7.1			21.6	21.6 1
3 IBRAHIM JOURY (MENTOR,UAE)		(5.0)	(5.0)	5.0	5.0	5.0			15.0	15.0 7
4 HAMZA KHADEEJAH (AL FAROOQ,UAE)		6.3	6.4	(5.9)	(7.1)	6.8			19.5	19.5 4
5 ALQATTAN SARA (KUWAIT FORCE ACADEMY,KUW)		(6.0)	7.1	6.1	7.0	(7.2)			20.2	20.2 3
6 MAKKI SAFA (MENTOR,UAE)		(5.5)	(6.6)	5.5	5.6	6.2			17.3	17.3 6
7 ELSHABRAWY LINA (SHARJAH SELF DEFENCE SPORTS CLUB,UAE)		6.4	6.3	(5.7)	(7.2)	6.4			19.1	19.1 5

R2-G1 Tatami 1 09:25(2023-03-04)

Competitors	Kata	1	2	3	4	5	6	7	TOTAL	Extra Total Rank
1 ALHAJJAJ ALYAZIA (SHABAB ALAHLI CLUB,UAE)		6.7	(7.5)	7.0	(5.8)	7.4			21.1	21.1 1
2 SHERIF DOUGANA (SHARJAH SELF DEFENCE SPORTS CLUB,UAE)		6.6	7.3	6.8	(5.6)	(7.8)			20.7	20.7 3
3 ABDELSALAM ROKAIA (MENTOR,UAE)		6.7	7.1	7.2	(5.9)	(7.6)			21.0	21.0 2
4 GHANIM HALA (MENTOR,UAE)		5.3	5.4	(5.0)	5.1	(5.9)			15.8	15.8 4

R2-G2 Tatami 2 09:20(2023-03-04)

Competitors	Kata	1	2	3	4	5	6	7	TOTAL	Extra Total Rank
1 ALQATTAN SARA (KUWAIT FORCE ACADEMY,KUW)		6.0	6.1	(5.8)	(6.9)	6.9			19.0	19.0 4
2 BASUONI REEM (MENTOR,UAE)		6.1	6.9	(6.0)	6.7	(7.0)			19.7	19.7 2
3 HAMZA KHADEEJAH (AL FAROOQ,UAE)		6.1	6.9	(5.8)	6.7	(7.0)			19.7	19.7 3
4 KAMOUN MALAK (SHARJAH SPORTS CLUB,UAE)		(7.4)	7.3	(6.5)	7.3	7.3			21.9	21.9 1

R3 Bronze Medal Match 1 Tatami 2 09:35(2023-03-04)

Competitors	Kata	1	2	3	4	5	6	7	TOTAL	Extra Total Rank
1 ABDELSALAM ROKAIA (MENTOR,UAE)		7.1	6.8	7.1	(6.5)	(7.5)			21.0	21.0 1
2 HAMZA KHADEEJAH (AL FAROOQ,UAE)		6.5	6.7	6.6	(6.3)	(6.8)			19.8	19.8 2

R3 Bronze Medal Match 2 Tatami 1 09:40(2023-03-04)

Competitors	Kata	1	2	3	4	5	6	7	TOTAL	Extra Total Rank
1 SHERIF DOUGANA (SHARJAH SELF DEFENCE SPORTS CLUB,UAE)		5.4	(5.8)	(5.0)	5.1	5.4			15.9	15.9 2
2 BASUONI REEM (MENTOR,UAE)		6.2	6.5	(7.0)	(5.8)	6.7			19.4	19.4 1

R3 Gold Medal Match Tatami 2 09:40(2023-03-04)

Competitors	Kata	1	2	3	4	5	6	7	TOTAL	Extra Total Rank
1 ALHAJJAJ ALYAZIA (SHABAB ALAHLI CLUB,UAE)		7.2	(6.9)	7.1	(7.6)	7.0			21.3	21.3 1
2 KAMOUN MALAK (SHARJAH SPORTS CLUB,UAE)		6.9	7.1	6.8	(7.7)	(6.6)			20.8	20.8 2

Results

1	ALHAJJAJ ALYAZIA		UNITED ARAB EMIRATES
2	KAMOUN MALAK		UNITED ARAB EMIRATES
3	ABDELSALAM ROKAIA		UNITED ARAB EMIRATES
3	BASUONI REEM		UNITED ARAB EMIRATES
5	HAMZA KHADEEJAH		UNITED ARAB EMIRATES





EMIRATES SPORTS KARATE OPEN - 2023-03-03
KIDS KATA FEMALE 6 - 7 YEARS



5	SHERIF DOUGANA		UNITED ARAB EMIRATES
7	GHANIM HALA		UNITED ARAB EMIRATES
7	ALQATTAN SARA		KUWAIT
9	AASHER AIZA		UNITED ARAB EMIRATES
9	ELSHABRAWY LINA		UNITED ARAB EMIRATES
11	SHAH AAIRA		UNITED ARAB EMIRATES
11	MAKKI SAFA		UNITED ARAB EMIRATES
13	ALSHAHRANI RANA		UNITED ARAB EMIRATES
13	IBRAHIM JOURY		UNITED ARAB EMIRATES
15	ALSHAHRANI SAMA		UNITED ARAB EMIRATES





EMIRATES SPORTS KARATE OPEN - 2023-03-03 KIDS KATA FEMALE 8 - 9 YEARS



R1 G1/2 (7) Tatami 3 09:00(2023-03-04)

Competitors	Kata	1	2	3	4	5	6	7	TOTAL	Extra Total Rank
1 TAREQ BERNADETTE (TEAM,JOR)		7.2	(7.6)	7.2	(7.0)	7.6			22.0	22.0 1
2 KOVALEVSKAYA ANASTASSIYA (SHARJAH SELF DEFENCE SPORTS CLUB,UAE)		6.8	(5.8)	(7.0)	7.0	6.7			20.5	20.5 4
3 SHAH AARIKA (AL AZZAM KARATE CENTER, SHARJAH,UAE)		(6.9)	6.4	6.9	(6.0)	6.5			19.8	19.8 6
4 OUESLATI MILIA (SHARJAH SPORTS CLUB,UAE)		7.1	7.2	7.1	(6.3)	(7.6)			21.4	21.4 2
5 LOH CAYLA (AJSPORTSCLUB,UAE)		6.7	(7.7)	7.2	(6.5)	7.3			21.2	21.2 3
6 HATAM NOUF (SHABAB ALAHLI CLUB,UAE)		6.4	6.7	(6.9)	(6.2)	6.8			19.9	19.9 5
7 ALALI FAJIR (SHJSDSC,UAE)		6.3	6.0	(6.4)	(5.8)	5.8			18.1	18.1 7

R1 G2/2 (5) Tatami 4 09:00(2023-03-04)

Competitors	Kata	1	2	3	4	5	6	7	TOTAL	Extra Total Rank
1 CABALLERO YVONNE BETHANY (BUSHIDO MARTIAL ARTS & FITNESS - SKIF,PHI)		7.0	(6.5)	7.4	6.9	(7.5)			21.3	21.3 3
2 SHERIF FARIDA (SHABAB ALAHLI CLUB,UAE)		7.1	(6.7)	7.2	7.2	(7.8)			21.5	21.5 2
3 ALADSANI NOURAH (KUWAIT FORCE ACADEMY,KUW)		(6.8)	6.3	6.3	6.0	(5.8)			18.6	18.6 5
4 KIBIREVA ALEXANDRA (TATSUJIN KARATE SCHOOL RUS,RUS)		7.4	(7.0)	8.0	(9.1)	8.0			23.4	23.4 1
5 AL_ALI AISHA (SHARJAH SELF DEFENCE SPORTS CLUB,UAE)		6.7	(5.8)	(7.1)	6.5	6.0			19.2	19.2 4

R2-G1 Tatami 3 09:25(2023-03-04)

Competitors	Kata	1	2	3	4	5	6	7	TOTAL	Extra Total Rank
1 KOVALEVSKAYA ANASTASSIYA (SHARJAH SELF DEFENCE SPORTS CLUB,UAE)		7.0	(5.5)	6.7	(7.4)	6.6			20.3	20.3 4
2 LOH CAYLA (AJSPORTSCLUB,UAE)		(7.7)	(5.8)	7.2	7.0	7.0			21.2	21.2 3
3 TAREQ BERNADETTE (TEAM,JOR)		(8.0)	7.9	(7.4)	7.5	7.8			23.2	23.2 1
4 OUESLATI MILIA (SHARJAH SPORTS CLUB,UAE)		7.5	7.4	(7.6)	(7.2)	7.5			22.4	22.4 2

R2-G2 Tatami 4 09:25(2023-03-04)

Competitors	Kata	1	2	3	4	5	6	7	TOTAL	Extra Total Rank
1 SHERIF FARIDA (SHABAB ALAHLI CLUB,UAE)		6.8	(7.3)	7.2	(6.7)	6.8			20.8	20.8 3
2 CABALLERO YVONNE BETHANY (BUSHIDO MARTIAL ARTS & FITNESS - SKIF,PHI)		(7.2)	(7.1)	7.1	7.2	7.2			21.5	21.5 2
3 KIBIREVA ALEXANDRA (TATSUJIN KARATE SCHOOL RUS,RUS)		7.5	7.7	(9.5)	(7.4)	7.5			22.7	22.7 1
4 AL_ALI AISHA (SHARJAH SELF DEFENCE SPORTS CLUB,UAE)		(6.1)	(7.0)	6.4	6.4	6.6			19.4	19.4 4

R3 Bronze Medal Match 1 Tatami 3 09:40(2023-03-04)

Competitors	Kata	1	2	3	4	5	6	7	TOTAL	Extra Total Rank
1 SHERIF FARIDA (SHABAB ALAHLI CLUB,UAE)		(8.2)	7.1	7.0	(6.3)	7.0			21.1	21.1 2
2 OUESLATI MILIA (SHARJAH SPORTS CLUB,UAE)		(8.4)	7.5	7.5	(7.0)	7.6			22.6	22.6 1

R3 Bronze Medal Match 2 Tatami 4 09:40(2023-03-04)

Competitors	Kata	1	2	3	4	5	6	7	TOTAL	Extra Total Rank
1 CABALLERO YVONNE BETHANY (BUSHIDO MARTIAL ARTS & FITNESS - SKIF,PHI)		7.2	7.4	(7.5)	(7.0)	7.5			22.1	22.1 2
2 LOH CAYLA (AJSPORTSCLUB,UAE)		7.3	(6.3)	7.8	7.5	(8.0)			22.6	22.6 1

R3 Gold Medal Match Tatami 3 09:45(2023-03-04)

Competitors	Kata	1	2	3	4	5	6	7	TOTAL	Extra Total Rank
1 KIBIREVA ALEXANDRA (TATSUJIN KARATE SCHOOL RUS,RUS)		(7.0)	7.7	7.7	(8.4)	7.6			23.0	23.0 1
2 TAREQ BERNADETTE (TEAM,JOR)		(7.8)	7.8	7.6	(7.5)	7.5			22.9	22.9 2

Results

1 KIBIREVA ALEXANDRA		RUSSIAN FEDERATION
----------------------	--	--------------------





EMIRATES SPORTS KARATE OPEN - 2023-03-03
KIDS KATA FEMALE 8 - 9 YEARS



2	TAREQ BERNADETTE		JORDAN
3	OUESLATI MILIA		UNITED ARAB EMIRATES
3	LOH CAYLA		UNITED ARAB EMIRATES
5	SHERIF FARIDA		UNITED ARAB EMIRATES
5	CABALLERO YVONNE BETHANY		PHILIPPINES
7	KOVALEVSKAYA ANASTASSIYA		UNITED ARAB EMIRATES
7	AL ALI AISHA		UNITED ARAB EMIRATES
9	HATAM NOUF		UNITED ARAB EMIRATES
9	ALADSANI NOURAH		KUWAIT
11	SHAH AARIKA		UNITED ARAB EMIRATES
13	ALALI FAJIR		UNITED ARAB EMIRATES





EMIRATES SPORTS KARATE OPEN - 2023-03-03
KIDS KATA MALE 10 - 11 YEARS



R1 G1/2 (12) Tatami 5 09:00(2023-03-04)

Competitors	Kata	1	2	3	4	5	6	7	TOTAL	Extra Total Rank
1 AJEESH ANGELO (AL AZZAM KARATE CENTER, SHARJAH,UAE)		6.2	(5.5)	5.8	(6.8)	6.2			18.2	18.2 7
2 EYAD_ABDELHAMID SHAHAT_AHMED_YOUSSEF (ABDELHAMED_CLUB,UAE)		(6.5)	6.9	7.0	(7.5)	6.8			20.7	20.7 2
3 HAIDAR MOHAMMAD (KUWAIT COMBAT CLUB,KUW)	012 ENPI	6.3	(5.9)	6.5	6.8	(7.1)			19.6	19.6 5
4 LOH ETHAN (AJSPORTSCLUB,UAE)		(5.7)	5.8	5.9	(6.4)	6.0			17.7	17.7 8
5 MALIK FAISAL (MENTOR,UAE)		5.5	(5.4)	5.8	(6.0)	5.5			16.8	16.8 10
6 MAJDI MOHAMED (SHARJAH SPORTS CLUB,UAE)		(6.0)	(7.0)	6.8	6.5	6.6			19.9	19.9 4
7 RAZVALOV NIKOLAI (TATSUJIN KARATE SCHOOL RUS,RUS)		(7.6)	7.4	(7.0)	7.0	7.4			21.8	21.8 1
8 RAJESH_NAMBIAR JAIDITH (MARTIAL ARTS KARATE KIDS,UAE)		6.4	5.8	(5.7)	6.6	(6.7)			18.8	18.8 6
9 MARANAN AMMIEL_CHUA (KARATE PRO , DUBAI,UAE)		(7.2)	(6.1)	6.3	7.2	6.9			20.4	20.4 3
10 EFFIX AUSTIN (AL AZZAM KARATE CENTER, SHARJAH,UAE)		5.7	5.7	5.7	(6.4)	(5.5)			17.1	17.1 9
11 MAKDISSY JHON_ALARD (AJSPORTSCLUB,UAE)		5.6	5.6	5.6	(5.8)	(5.1)			16.8	16.8 11
12 RAKESH SHIVANSH (MENTOR,UAE)										

R1 G2/2 (12) Tatami 5 09:35(2023-03-04)

Competitors	Kata	1	2	3	4	5	6	7	TOTAL	Extra Total Rank
1 ALSHAER YAHYA (MENTOR,UAE)	025 HEIAN SHODAN	5.6	(5.5)	5.5	5.5	(6.6)			16.6	16.6 9
2 SHARMA TANISH (AL AZZAM KARATE CENTER, SHARJAH,UAE)	026 HEIAN NIDAN	(5.4)	5.8	5.7	5.4	(6.7)			16.9	16.9 8
3 ALMALKI WALEED (PIONEERS OF POWER SPORTS CENTER,KSA)	006 BASSAI DAI	5.9	5.6	5.8	(5.2)	(7.0)			17.3	17.3 7
4 ALI MEHRI (AJSPORTSCLUB,UAE)	026 HEIAN NIDAN	5.5	(5.3)	5.3	5.8	(6.5)			16.6	16.6 10
5 CHANDRA_KUMAR TARAN_KRISHNA (MARTIAL ARTS KARATE KIDS,UAE)	036 JION	(5.7)	6.1	6.2	6.2	(6.8)			18.5	18.5 4
6 AKHMETOV EVGENII (TATSUJIN KARATE SCHOOL RUS,RUS)	061 NIPAPO	(6.9)	7.2	7.2	(7.4)	7.4			21.8	21.8 1
7 AHMED_GAMAL AHMED MOHAMED_ABDELMOTELB_AMMAR (ABDELHAMED_CLUB,UAE)	006 BASSAI DAI	6.3	6.3	(5.6)	5.7	(6.9)			18.3	18.3 5
8 KAMOUN MOHAMED (SHARJAH SPORTS CLUB,UAE)	006 BASSAI DAI	6.6	6.6	(6.3)	6.7	(7.1)			19.9	19.9 3
9 QUIME PIERRE_GUSTAV (SHITOKAI MURAYAMA UAE,UAE)		(5.7)	5.9	5.9	6.0	(6.5)			17.8	17.8 6
10 MISK FARIS (MENTOR,UAE)	025 HEIAN SHODAN	5.5	(5.1)	5.2	5.2	(7.0)			15.9	15.9 11
11 AYEDH_H_ABNDJEM EMAD (MENTOR,UAE)		5.3	(5.0)	5.1	5.1	(5.5)			15.5	15.5 12
12 MATAR AHMED (SHJSDSC,UAE)	006 BASSAI DAI	6.7	6.8	(5.8)	6.9	(7.2)			20.4	20.4 2

R2-G1 Tatami 5 10:10(2023-03-04)

Competitors	Kata	1	2	3	4	5	6	7	TOTAL	Extra Total Rank
1 EYAD_ABDELHAMID SHAHAT_AHMED_YOUSSEF (ABDELHAMED_CLUB,UAE)	092 SUPARINPEI	7.1	(7.4)	7.2	(7.0)	7.2			21.5	21.5 2
2 RAZVALOV NIKOLAI (TATSUJIN KARATE SCHOOL RUS,RUS)		7.4	(7.2)	7.3	(7.5)	7.4			22.1	22.1 1
3 MAJDI MOHAMED (SHARJAH SPORTS CLUB,UAE)	025 HEIAN SHODAN	(6.8)	6.9	(7.1)	6.8	6.9			20.6	20.6 3
4 MARANAN AMMIEL_CHUA (KARATE PRO , DUBAI,UAE)	040 KANKU DAI	6.6	6.8	6.8	(6.5)	(7.0)			20.2	20.2 4

R2-G2 Tatami 5 10:25(2023-03-04)

Competitors	Kata	1	2	3	4	5	6	7	TOTAL	Extra Total Rank
1 AKHMETOV EVGENII (TATSUJIN KARATE SCHOOL RUS,RUS)	067 PAIKU	(7.3)	(7.5)	7.3	7.3	7.4			22.0	22.0 1
2 KAMOUN MOHAMED (SHARJAH SPORTS CLUB,UAE)	006 BASSAI DAI	(6.8)	6.6	6.7	(6.5)	6.8			20.1	20.1 3
3 CHANDRA_KUMAR TARAN_KRISHNA (MARTIAL ARTS KARATE KIDS,UAE)	006 BASSAI DAI	6.5	6.2	(6.0)	6.1	(7.0)			18.8	18.8 4
4 MATAR AHMED (SHJSDSC,UAE)	021 GOJUSHIHO SHO	(6.7)	7.1	6.9	6.8	(7.2)			20.8	20.8 2

R3 Bronze Medal Match 1 Tatami 5 10:40(2023-03-04)

Competitors	Kata	1	2	3	4	5	6	7	TOTAL	Extra Total Rank
-------------	------	---	---	---	---	---	---	---	-------	------------------





EMIRATES SPORTS KARATE OPEN - 2023-03-03
KIDS KATA MALE 10 - 11 YEARS



1	EYAD_ABDELHAMID SHAHAT_AHMED_YOUSSEF (ABDELHAMED_CLUB,UAE)	002 ANAN DAI	7.1	7.0	(7.4)	(6.9)	7.2												21.3			21.3	1	
2	KAMOUN MOHAMED (SHARJAH SPORTS CLUB,UAE)	006 BASSAI DAI	6.8	6.8	(6.6)	6.7	(7.0)													20.3			20.3	2

R3 Bronze Medal Match 2 Tatami 5 10:45(2023-03-04)

Competitors	Kata	1	2	3	4	5	6	7	TOTAL	Extra Total Rank					
1 MAJDI MOHAMED (SHARJAH SPORTS CLUB,UAE)	027 HEIAN SANDAN	(6.5)	6.9	(7.0)	6.9	6.9					20.7			20.7	1
2 MATAR AHMED (SHJSDSC,UAE)	006 BASSAI DAI	(6.7)	(7.1)	6.8	6.7	7.1					20.6			20.6	2

R3 Gold Medal Match Tatami 5 10:50(2023-03-04)

Competitors	Kata	1	2	3	4	5	6	7	TOTAL	Extra Total Rank					
1 RAZVALOV NIKOLAI (TATSUJIN KARATE SCHOOL RUS,RUS)	001 ANAN	(7.5)	(7.3)	7.4	7.3	7.3					22.0			22.0	1
2 AKHMETOV EVGENII (TATSUJIN KARATE SCHOOL RUS,RUS)	001 ANAN	(7.1)	7.2	7.2	(7.5)	7.5					21.9			21.9	2

Results

1	RAZVALOV NIKOLAI		RUSSIAN FEDERATION
2	AKHMETOV EVGENII		RUSSIAN FEDERATION
3	EYAD ABDELHAMID SHAHAT AHMED YOUSSEF		UNITED ARAB EMIRATES
3	MAJDI MOHAMED		UNITED ARAB EMIRATES
5	KAMOUN MOHAMED		UNITED ARAB EMIRATES
5	MATAR AHMED		UNITED ARAB EMIRATES
7	MARANAN AMMIEL CHUA		UNITED ARAB EMIRATES
7	CHANDRA KUMAR TARAN KRISHNA		UNITED ARAB EMIRATES
9	AHMED GAMAL AHMED MOHAMED ABDELMOTELEB AMMAR		UNITED ARAB EMIRATES
11	QUIME PIERRE GUSTAV		UNITED ARAB EMIRATES
13	ALMALKI WALEED		SAUDI ARABIA
15	SHARMA TANISH		UNITED ARAB EMIRATES
17	ALSHAER YAHYA		UNITED ARAB EMIRATES
19	ALI MEHRI		UNITED ARAB EMIRATES
21	MISK FARIS		UNITED ARAB EMIRATES
23	AYEDH H ABNDAJEM EMAD		UNITED ARAB EMIRATES





EMIRATES SPORTS KARATE OPEN - 2023-03-03
KIDS KATA MALE 6 - 7 YEARS



R1 G1/2 (11) Tatami 1 10:40(2023-03-04)

Competitors	Kata	1	2	3	4	5	6	7	TOTAL	Extra Total Rank
1 DURAH-BAK ZAID (MENTOR,UAE)										
2 MAHMOUD YAZAN (SHARJAH SPORTS CLUB,UAE)		(5.5)	(5.7)	5.5	5.7	5.5			16.7	16.7 6
3 MAZDA ZAOSH (MENTOR,UAE)		(5.3)	5.8	5.8	(6.4)	5.6			17.2	17.2 5
4 ABDELSALAM HAMZA (MENTOR,UAE)		(5.3)	6.5	(7.0)	6.8	5.9			19.2	19.2 1
5 AARON_SALDANA ARTHUR (KARATE PRO , DUBAI,UAE)		6.0	(5.5)	6.9	(7.4)	6.2			19.1	19.1 2
6 BEIG EMAAD (MENTOR,UAE)		(5.3)	(5.8)	5.6	5.7	5.4			16.7	16.7 7
7 ALJAZZAF ALI (KUWAIT COMBAT CLUB,KUW)		5.9	6.0	(7.2)	7.1	(5.8)			19.0	19.0 3
8 AWAN RAYAAN (MENTOR,UAE)		(5.3)	5.9	5.4	(6.0)	5.3			16.6	16.6 8
9 MOHAMED ABDELRAHMAN (MENTOR,UAE)		(5.2)	(5.6)	5.2	5.4	5.2			15.8	15.8 9
10 BEREZIN ANTON (НИЖЕГОРОДСКАЯ ОБЛАСТЬ,RUS)		(5.4)	6.0	(6.8)	6.4	5.7			18.1	18.1 4
11 ALKHALIDI SAIF (MENTOR,UAE)		(5.1)	5.4	5.1	(6.0)	5.1			15.6	15.6 10

R1 G2/2 (11) Tatami 2 10:35(2023-03-04)

Competitors	Kata	1	2	3	4	5	6	7	TOTAL	Extra Total Rank
1 KHAN SALAH (MENTOR,UAE)		(5.7)	5.7	(5.5)	5.6	5.6			16.9	16.9 9
2 SHAKER ALEX_MARK (AJSPORTSCLUB,UAE)		6.8	6.1	(6.9)	6.2	(6.0)			19.1	19.1 3
3 FAHMY YOUSEF (MENTOR,UAE)		(5.8)	5.5	5.4	5.5	(5.2)			16.4	16.4 11
4 RAMI BAHY (TEAM,JOR)		6.9	6.5	(8.2)	6.9	(6.2)			20.3	20.3 1
5 RIBHE_MISK RAYAN (MENTOR,UAE)		5.5	5.4	(5.3)	5.5	(5.6)			16.4	16.4 10
6 ALSUWAIDI SAIF (MENTOR,UAE)		(6.6)	(5.6)	5.8	6.6	5.7			18.1	18.1 5
7 MOSTAFA ANAS (SHARJAH SELF DEFENCE SPORTS CLUB,UAE)		(5.5)	5.8	5.7	(6.4)	5.5			17.0	17.0 8
8 MALIK FAHAD (MENTOR,UAE)		(5.8)	5.9	6.2	(6.8)	6.1			18.2	18.2 4
9 ABNDAEM LAYTH (MENTOR,UAE)		(5.3)	5.5	6.1	(6.4)	6.1			17.7	17.7 7
10 SHENOY ATHARV (MENTOR,UAE)		(5.9)	6.0	5.9	(6.2)	5.9			17.8	17.8 6
11 ELFATEH AHMED (SHARJAH SPORTS CLUB,UAE)		6.9	(6.2)	6.4	(7.2)	6.8			20.1	20.1 2

R2-G1 Tatami 1 11:15(2023-03-04)

Competitors	Kata	1	2	3	4	5	6	7	TOTAL	Extra Total Rank
1 BEREZIN ANTON (НИЖЕГОРОДСКАЯ ОБЛАСТЬ,RUS)		6.1	(6.2)	6.2	(6.0)	6.0			18.3	18.3 4
2 ALJAZZAF ALI (KUWAIT COMBAT CLUB,KUW)		6.8	(7.1)	6.4	6.8	(5.9)			20.0	20.0 1
3 AARON_SALDANA ARTHUR (KARATE PRO , DUBAI,UAE)		6.4	(6.5)	6.5	6.4	(6.1)			19.3	19.3 3
4 ABDELSALAM HAMZA (MENTOR,UAE)		6.7	(7.0)	(6.2)	7.0	6.2			19.9	19.9 2

R2-G2 Tatami 2 11:10(2023-03-04)

Competitors	Kata	1	2	3	4	5	6	7	TOTAL	Extra Total Rank
1 ELFATEH AHMED (SHARJAH SPORTS CLUB,UAE)		(7.2)	6.8	7.2	(6.7)	6.8			20.8	20.8 2
2 MALIK FAHAD (MENTOR,UAE)		6.5	6.6	(6.7)	(5.9)	6.6			19.7	19.7 4
3 SHAKER ALEX_MARK (AJSPORTSCLUB,UAE)		6.8	7.0	(7.1)	7.0	(6.7)			20.8	20.8 3
4 RAMI BAHY (TEAM,JOR)		7.2	7.4	(8.3)	7.2	(7.1)			21.8	21.8 1

R3 Bronze Medal Match 1 Tatami 1 11:30(2023-03-04)

Competitors	Kata	1	2	3	4	5	6	7	TOTAL	Extra Total Rank
1 SHAKER ALEX_MARK (AJSPORTSCLUB,UAE)		6.7	(7.2)	6.2	6.8	(5.7)			19.7	19.7 2
2 ABDELSALAM HAMZA (MENTOR,UAE)		6.5	(7.4)	6.3	7.0	(6.2)			19.8	19.8 1

R3 Bronze Medal Match 2 Tatami 2 11:30(2023-03-04)

Competitors	Kata	1	2	3	4	5	6	7	TOTAL	Extra Total Rank
1 ELFATEH AHMED (SHARJAH SPORTS CLUB,UAE)		(7.2)	7.1	7.0	(6.4)	6.6			20.7	20.7 1
2 AARON_SALDANA ARTHUR (KARATE PRO , DUBAI,UAE)		(6.9)	6.9	6.8	(6.4)	6.9			20.6	20.6 2

R3 Gold Medal Match Tatami 2 11:25(2023-03-04)

Competitors	Kata	1	2	3	4	5	6	7	TOTAL	Extra Total Rank
1 RAMI BAHY (TEAM,JOR)		7.2	(7.3)	(7.0)	7.0	7.0			21.2	21.2 1
2 ALJAZZAF ALI (KUWAIT COMBAT CLUB,KUW)		6.7	7.1	(7.3)	(6.6)	7.3			21.1	21.1 2

Results





EMIRATES SPORTS KARATE OPEN - 2023-03-03
KIDS KATA MALE 6 - 7 YEARS



1	RAMI BAHJ		JORDAN
2	ALJAZZAF ALI		KUWAIT
3	ABDELSALAM HAMZA		UNITED ARAB EMIRATES
3	ELFATEH AHMED		UNITED ARAB EMIRATES
5	SHAKER ALEX MARK		UNITED ARAB EMIRATES
5	AARON SALDANA ARTHUR		UNITED ARAB EMIRATES
7	BEREZIN ANTON		RUSSIAN FEDERATION
7	MALIK FAHAD		UNITED ARAB EMIRATES
9	MAZDA ZAOSH		UNITED ARAB EMIRATES
9	ALSUWAIDI SAIF		UNITED ARAB EMIRATES
11	MAHMOUD YAZAN		UNITED ARAB EMIRATES
11	SHENOY ATHARV		UNITED ARAB EMIRATES
13	BEIG EMAAD		UNITED ARAB EMIRATES
13	ABNDAEM LAYTH		UNITED ARAB EMIRATES
15	AWAN RAYAAN		UNITED ARAB EMIRATES
15	MOSTAFA ANAS		UNITED ARAB EMIRATES
17	MOHAMED ABDELRAHMAN		UNITED ARAB EMIRATES
17	KHAN SALAH		UNITED ARAB EMIRATES
19	ALKHALIDI SAIF		UNITED ARAB EMIRATES
19	RIBHE MISK RAYAN		UNITED ARAB EMIRATES
21	FAHMY YOUSEF		UNITED ARAB EMIRATES





EMIRATES SPORTS KARATE OPEN - 2023-03-03

KIDS KATA MALE 8 - 9 YEARS



R1 G1/4 (10) Tatami 3 10:40(2023-03-04)

Competitors	Kata	1	2	3	4	5	6	7	TOTAL	Extra Total Rank
1 Haidar Mohammad (Kuwait Combat Club, KUW)		7.2	(7.3)	(6.4)	7.0	7.0			21.2	21.2 1
2 Tariq Mohamed (Sharjah Self Defence Sports Club, UAE)		6.1	6.4	(5.6)	(6.8)	6.5			19.0	19.0 4
3 Misk Samer (Mentor, UAE)		6.6	6.2	(5.4)	(6.9)	5.7			18.5	18.5 6
4 Khammash Owais (Mentor, UAE)		(5.2)	5.9	5.3	(6.6)	5.5			16.7	16.7 8
5 Abdelrahman_Amr Mohamed_Abelrahman_El_Shabrawy (Abdelhamed Club, UAE)		5.3	(5.6)	5.1	5.4	(5.0)			15.8	15.8 10
6 Vijeesh Arjit (Machingal, UAE)		5.6	5.8	(5.0)	6.3	(6.7)			17.7	17.7 7
7 Sultan Ammar (Mentor, UAE)		7.1	(7.2)	(6.0)	6.0	7.1			20.2	20.2 2
8 Prasad Ryan (Al Azzam Karate Center, Sharjah, UAE)		6.2	6.3	6.3	(5.8)	(7.0)			18.8	18.8 5
9 Ehab Mohamed (Sharjah Sports Club, UAE)		6.6	6.7	6.8	(6.1)	(6.9)			20.1	20.1 3
10 Affandy Ehsan (Mentor, UAE)		5.4	5.5	(5.1)	5.3	(6.1)			16.2	16.2 9

R1 G2/4 (9) Tatami 3 11:10(2023-03-04)

Competitors	Kata	1	2	3	4	5	6	7	TOTAL	Extra Total Rank
1 Elgendy Omar (Mentor, UAE)		6.5	(6.7)	(5.6)	6.5	6.7			19.7	19.7 4
2 Gohil Vivaan_Vaibhav (Karate Pro, Dubai, UAE)		(5.8)	6.4	(7.0)	6.2	6.8			19.4	19.4 6
3 Aser_Abelhamed Shahat_Ahmed_Youssef (Abdelhamed Club, UAE)		6.4	(5.5)	6.3	6.1	(6.6)			18.8	18.8 7
4 Alali Mayed (Shjdsdc, UAE)		(5.4)	5.7	5.5	6.1	(6.2)			17.3	17.3 9
5 Soriano Avery_Rosh (Bushido Martial Arts & Fitness - Skif, PHI)		6.1	(5.7)	(7.2)	7.0	6.9			20.0	20.0 2
6 Mahyoub Hamdan (Shabab Alahli Club, UAE)		(5.8)	6.8	(7.1)	6.8	5.9			19.5	19.5 5
7 Rami Dhay (Team, JOR)		6.6	(6.9)	6.8	6.4	(5.9)			19.8	19.8 3
8 Alblushi Naser (Kuwait Force Academy, KUW)		(5.9)	7.2	6.0	7.0	(7.3)			20.2	20.2 1
9 KHAJEH ROHAM (Mentor, UAE)		(5.2)	6.5	5.6	(7.0)	5.7			17.8	17.8 8

R1 G3/4 (10) Tatami 4 10:55(2023-03-04)

Competitors	Kata	1	2	3	4	5	6	7	TOTAL	Extra Total Rank
1 Al-Shouli Yousef (International Sport Center, QAT)	012 ENPI	6.9	(6.8)	7.0	7.1	(7.2)			21.0	21.0 2
2 Arshad Zackareya (Mentor, UAE)	025 HEIAN SHODAN	6.1	5.9	(6.4)	(5.5)	5.9			17.9	17.9 5
3 Chourasia Samyak (Al Azzam Karate Center, Sharjah, UAE)	026 HEIAN NIDAN	(6.4)	6.0	(5.5)	5.6	5.8			17.4	17.4 7
4 Omar Eiad (Sharjah Sports Club, UAE)	025 HEIAN SHODAN	5.6	(5.7)	5.6	(5.3)	5.4			16.6	16.6 9
5 Alghefeli Buti (Mentor, UAE)	025 HEIAN SHODAN	(5.4)	(5.2)	5.3	5.2	5.3			15.8	15.8 10
6 Abdugafarov Kamronbek (Ajssportsclub, UAE)	026 HEIAN NIDAN	6.7	6.4	(5.4)	5.6	(6.8)			18.7	18.7 4
7 Selim_Amr Sayed_Aly_Hanafy (Abdelhamed Club, UAE)	026 HEIAN NIDAN	6.0	(5.4)	(6.6)	5.9	5.6			17.5	17.5 6
8 Issa Hisham (Mentor, UAE)	029 HEIAN GODAN	(7.1)	7.0	6.9	(6.7)	6.8			20.7	20.7 3
9 Akhmetov Evgenii (Tatsujin Karate School Rus, Rus)		7.3	(7.7)	7.1	(7.0)	7.1			21.5	21.5 1
10 Adem ElSawy (Sharjah Self - Defence Sports Club, UAE)	025 HEIAN SHODAN	(5.2)	5.6	(5.8)	5.6	5.7			16.9	16.9 8

R1 G4/4 (9) Tatami 5 10:55(2023-03-04)

Competitors	Kata	1	2	3	4	5	6	7	TOTAL	Extra Total Rank
1 Hamza_Gamal_Ahmed Mohamed_Abelmoteleb_Ammar (Abdelhamed Club, UAE)	027 HEIAN SANDAN	5.6	5.7	(6.1)	(5.5)	5.5			16.8	16.8 6
2 Zayaan Muhammed (Al Azzam Karate Center, Sharjah, UAE)	026 HEIAN NIDAN	(5.8)	(6.9)	6.8	5.8	5.9			18.5	18.5 2
3 Ahmed Jazser (Sharjah Sports Club, UAE)	025 HEIAN SHODAN	(5.3)	(5.4)	5.4	5.4	5.3			16.1	16.1 7
4 Mokhtar Saif (Shabab Alahli Club, UAE)	027 HEIAN SANDAN	5.7	5.9	(6.9)	(5.6)	5.7			17.3	17.3 5
5 Almazrui Luay (Mentor, UAE)	025 HEIAN SHODAN	(5.2)	5.2	5.2	(5.3)	5.2			15.6	15.6 8
6 Alshwaiker Abdullah (Kuwait Force Academy, KUW)	021 GOJUSHIHO SHO	(6.4)	6.6	(7.3)	7.2	6.6			20.4	20.4 1
7 Croox Scott_Ceasar (Bushido Martial Arts & Fitness - Skif, PHI)	025 HEIAN SHODAN	6.1	6.0	(6.6)	5.8	(5.7)			17.9	17.9 4
8 Sharafeldin Nour (Mentor, UAE)										
9 Haitham Yasin (Sharjah Sports Club, UAE)	025 HEIAN SHODAN	(6.3)	(5.9)	6.0	6.0	6.0			18.0	18.0 3





EMIRATES SPORTS KARATE OPEN - 2023-03-03
KIDS KATA MALE 8 - 9 YEARS



R2-G1 Tatami 4 11:25(2023-03-04)

Competitors	Kata	1	2	3	4	5	6	7	TOTAL	Extra Total Rank
1 RAMI DHAY (TEAM,JOR)		(7.4)	(6.4)	6.9	7.0	6.8			20.7	5
2 SULTAN AMMAR (MENTOR,UAE)		7.1	(7.4)	7.0	6.9	(6.7)			21.0	3
3 EHAB MOHAMED (SHARJAH SPORTS CLUB,UAE)		(7.5)	(6.4)	7.2	7.1	6.6			20.9	4
4 ALBLUSHI NASER (KUWAIT FORCE ACADEMY,KUW)		(7.4)	(6.0)	7.1	7.3	6.8			21.2	2
5 TARIQ MOHAMED (SHARJAH SELF DEFENCE SPORTS CLUB,UAE)		(6.6)	(5.6)	6.2	6.6	5.7			18.5	8
6 SORIANO AVERY_ROSH (BUSHIDO MARTIAL ARTS & FITNESS - SKIF,PHI)		(5.6)	6.8	6.7	(7.2)	5.8			19.3	6
7 ELGENDY OMAR (MENTOR,UAE)		(5.9)	5.9	(6.6)	6.3	6.5			18.7	7
8 HAIDAR MOHAMMAD (KUWAIT COMBAT CLUB,KUW)		(7.7)	7.1	7.3	7.4	(6.4)			21.8	1

R2-G2 Tatami 5 11:25(2023-03-04)

Competitors	Kata	1	2	3	4	5	6	7	TOTAL	Extra Total Rank
1 HAITHAM YASIN (SHARJAH SPORTS CLUB,UAE)	025 HEIAN SHODAN	(6.6)	6.6	5.8	(5.7)	5.7			18.1	6
2 ISSA HISHAM (MENTOR,UAE)	029 HEIAN GODAN	6.7	(6.9)	6.9	6.9	(6.2)			20.5	4
3 CROOX SCOTT_CEASAR (BUSHIDO MARTIAL ARTS & FITNESS - SKIF,PHI)	026 HEIAN NIDAN	(5.5)	6.2	(6.4)	6.4	5.5			18.1	7
4 ABDUGAFAROV KAMRONBEK (AJSPORTSCLUB,UAE)	027 HEIAN SANDAN	5.8	6.4	(6.6)	6.0	(5.6)			18.2	5
5 ZAYAAN MUHAMMED (AL AZZAM KARATE CENTER, SHARJAH,UAE)	027 HEIAN SANDAN	(5.6)	(6.1)	5.9	5.9	6.0			17.8	8
6 AKHMETOV EVGENII (TATSUJIN KARATE SCHOOL RUS,RUS)	030 HEIKU	7.1	7.1	(7.4)	7.4	(6.9)			21.6	3
7 ALSHWAIKER ABDULLAH (KUWAIT FORCE ACADEMY,KUW)	021 GOJUSHIHO SHO	(6.8)	(7.3)	7.2	7.2	7.3			21.7	2
8 AL-SHOULI YOUSEF (INTERNATIONAL SPORT CENTER,QAT)	036 JION	(6.9)	7.5	(7.6)	7.1	7.1			21.7	1

R3-G1 Tatami 4 11:50(2023-03-04)

Competitors	Kata	1	2	3	4	5	6	7	TOTAL	Extra Total Rank
1 ALBLUSHI NASER (KUWAIT FORCE ACADEMY,KUW)		7.0	7.3	(7.5)	(6.8)	7.5			21.8	2
2 HAIDAR MOHAMMAD (KUWAIT COMBAT CLUB,KUW)		7.5	7.1	7.6	(6.6)	(7.9)			22.2	1
3 SULTAN AMMAR (MENTOR,UAE)		7.3	(6.5)	7.1	7.2	(8.0)			21.6	3
4 EHAB MOHAMED (SHARJAH SPORTS CLUB,UAE)		6.8	(6.7)	7.0	7.0	(8.2)			20.8	4

R3-G2 Tatami 5 11:50(2023-03-04)

Competitors	Kata	1	2	3	4	5	6	7	TOTAL	Extra Total Rank
1 ALSHWAIKER ABDULLAH (KUWAIT FORCE ACADEMY,KUW)	021 GOJUSHIHO SHO	7.2	(6.7)	7.0	(7.5)	7.2			21.4	3
2 AL-SHOULI YOUSEF (INTERNATIONAL SPORT CENTER,QAT)	036 JION	(7.5)	(7.1)	7.3	7.1	7.4			21.8	1
3 ISSA HISHAM (MENTOR,UAE)	029 HEIAN GODAN	6.9	6.9	6.8	(6.6)	(7.1)			20.6	4
4 AKHMETOV EVGENII (TATSUJIN KARATE SCHOOL RUS,RUS)	002 ANAN DAI	7.3	(7.0)	7.1	(7.4)	7.3			21.7	2

R4 Bronze Medal Match 1 Tatami 4 12:05(2023-03-04)

Competitors	Kata	1	2	3	4	5	6	7	TOTAL	Extra Total Rank
1 ALBLUSHI NASER (KUWAIT FORCE ACADEMY,KUW)	021 GOJUSHIHO SHO	(6.8)	6.7	(6.6)	6.8	6.7			20.2	2
2 ALSHWAIKER ABDULLAH (KUWAIT FORCE ACADEMY,KUW)	021 GOJUSHIHO SHO	(7.0)	7.0	(6.6)	7.0	7.0			21.0	1

R4 Bronze Medal Match 2 Tatami 5 12:05(2023-03-04)

Competitors	Kata	1	2	3	4	5	6	7	TOTAL	Extra Total Rank
1 SULTAN AMMAR (MENTOR,UAE)	029 HEIAN GODAN	(6.9)	7.0	6.9	(7.3)	7.2			21.1	2
2 AKHMETOV EVGENII (TATSUJIN KARATE SCHOOL RUS,RUS)	061 NIPAPO	7.1	(6.9)	7.2	7.0	(7.3)			21.3	1

R4 Gold Medal Match Tatami 5 12:10(2023-03-04)

Competitors	Kata	1	2	3	4	5	6	7	TOTAL	Extra Total Rank
1 HAIDAR MOHAMMAD (KUWAIT COMBAT CLUB,KUW)	012 ENPI	7.0	(6.6)	6.9	7.1	(7.3)			21.0	2
2 AL-SHOULI YOUSEF (INTERNATIONAL SPORT CENTER,QAT)	041 KANKU SHO	7.2	7.3	(7.1)	(7.6)	7.6			22.1	1

Results





EMIRATES SPORTS KARATE OPEN - 2023-03-03 KIDS KATA MALE 8 - 9 YEARS



1	AL-SHOULI YOUSEF		QATAR
2	Haidar MOHAMMAD		KUWAIT
3	ALSHWAIKER ABDULLAH		KUWAIT
3	AKHMETOV EVGENII		RUSSIAN FEDERATION
5	ALBLUSHI NASER		KUWAIT
5	SULTAN AMMAR		UNITED ARAB EMIRATES
7	EHAB MOHAMED		UNITED ARAB EMIRATES
7	ISSA HISHAM		UNITED ARAB EMIRATES
9	RAMI DHAY		JORDAN
9	ABDUGAFAROV KAMRONBEK		UNITED ARAB EMIRATES
11	SORIANO AVERY ROSH		PHILIPPINES
11	HAITHAM YASIN		UNITED ARAB EMIRATES
13	ELGENDY OMAR		UNITED ARAB EMIRATES
13	CROOX SCOTT CEASAR		PHILIPPINES
15	TARIQ MOHAMED		UNITED ARAB EMIRATES
15	ZAYAAN MUHAMMED		UNITED ARAB EMIRATES
17	PRASAD RYAN		UNITED ARAB EMIRATES
17	MAHYOUB HAMDAN		UNITED ARAB EMIRATES
17	ARSHAD ZACKAREYA		UNITED ARAB EMIRATES
17	MOKHTAR SAIF		UNITED ARAB EMIRATES
21	MISK SAMER		UNITED ARAB EMIRATES
21	GOHIL VIVAAN VAIBHAV		UNITED ARAB EMIRATES
21	SELIM AMR SAYED ALY HANAFY		UNITED ARAB EMIRATES
21	HAMZA GAMAL AHMED MOHAMED ABDELMOTELEB AMMAR		UNITED ARAB EMIRATES
25	VIJESH ARJIT		UNITED ARAB EMIRATES
25	ASER ABDELHAMID SHAHAT AHMED YOUSSEF		UNITED ARAB EMIRATES
25	CHOURASIA SAMYAK		UNITED ARAB EMIRATES
25	AHMED JAZSER		UNITED ARAB EMIRATES
29	KHAMMASH OWAIS		UNITED ARAB EMIRATES
29	KHAJEH ROHAM		UNITED ARAB EMIRATES
29	ADEM ELSAWY		UNITED ARAB EMIRATES
29	ALMAZRUI LUAY		UNITED ARAB EMIRATES
33	AFFANDY EHSAN		UNITED ARAB EMIRATES
33	ALALI MAYED		UNITED ARAB EMIRATES
33	OMAR EIAD		UNITED ARAB EMIRATES
37	ABDELRAHMAN AMR MOHAMED ABDELRAHMAN EL SHABRAWY		UNITED ARAB EMIRATES
37	ALGHFELI BUTI		UNITED ARAB EMIRATES



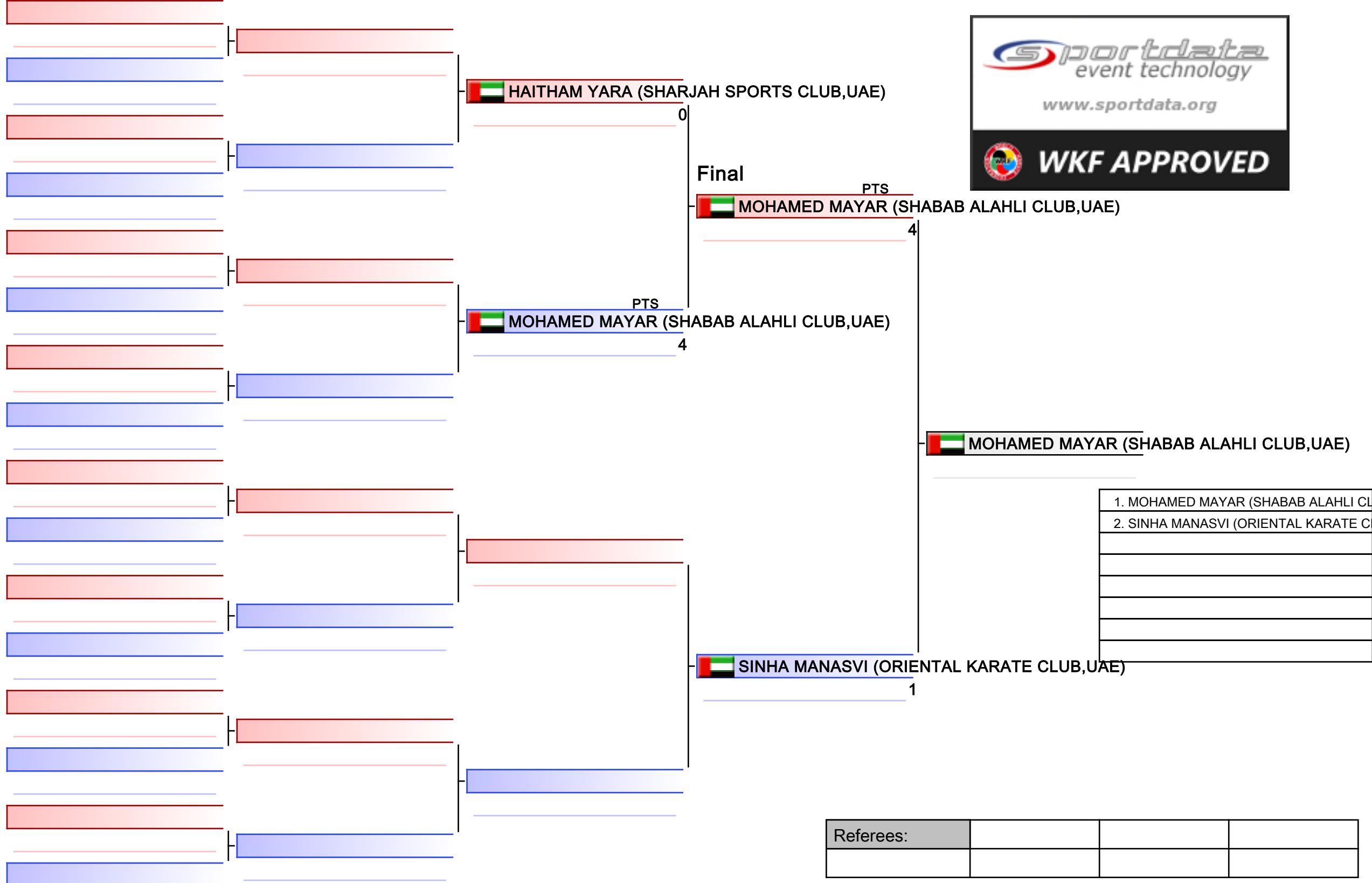

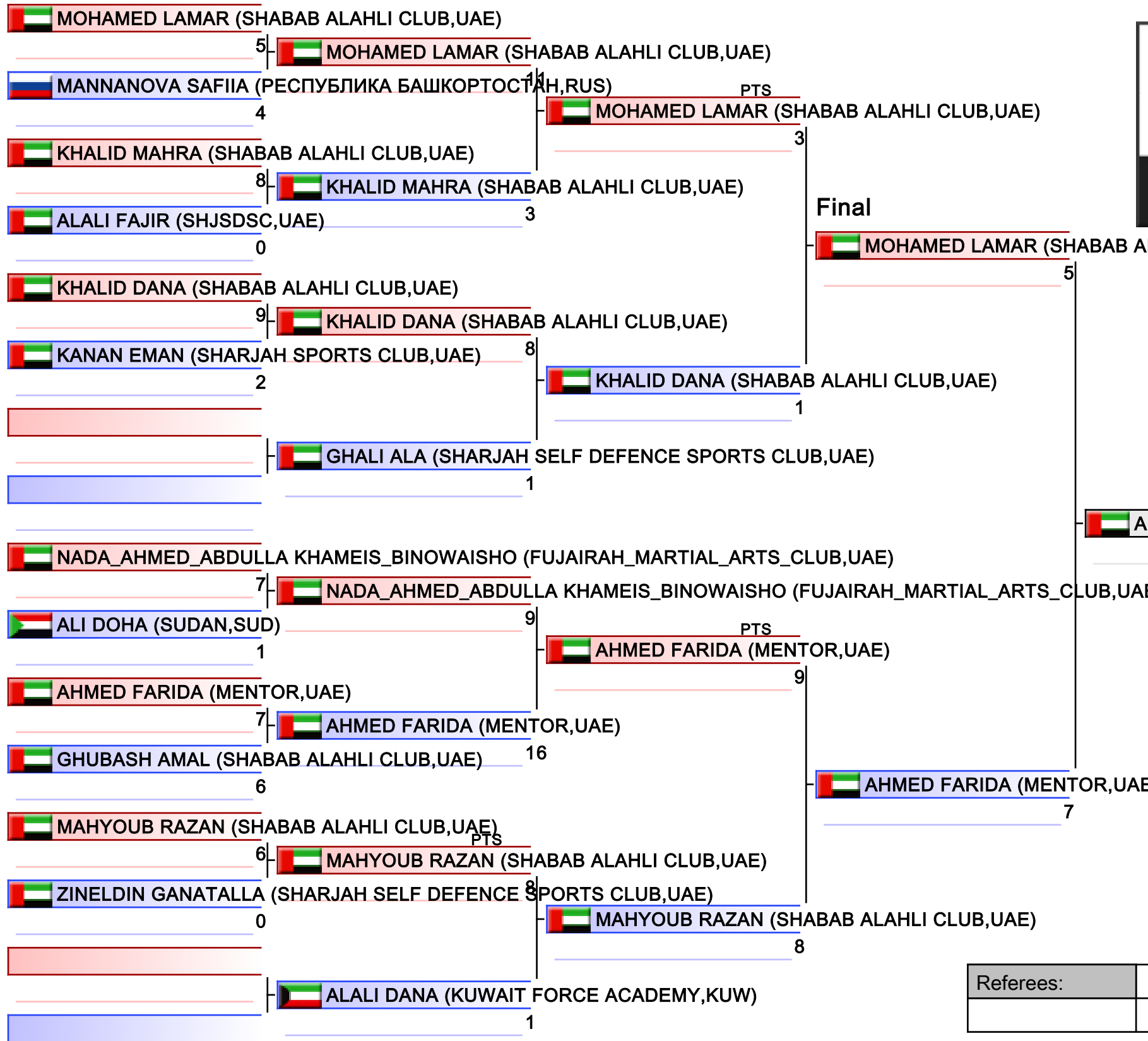

- | |
|---|
| 1. AHMED FARIDA (MENTOR,UAE) |
| 2. MOHAMED LAMAR (SHABAB ALAHLI CLUB,UAE) |
| 3. KHALID DANA (SHABAB ALAHLI CLUB,UAE) |
| 3. MAHYOUB RAZAN (SHABAB ALAHLI CLUB,UAE) |
| 5. MANNANOVA SAFIIA (РЕСПУБЛИКА БАШКОРТОСТАН,RUS) |
| 5. NADA_AHMED_ABDULLA KHAMEIS_BINOWAISHO (FUJAIRAH_MARTIAL_ARTS_CLUB,UAE) |
| 7. KHALID MAHRA (SHABAB ALAHLI CLUB,UAE) |
| 7. GHUBASH AMAL (SHABAB ALAHLI CLUB,UAE) |

Referees:			

KIDS KUMITE FEMALE 11 YEARS

EMIRATES SPORTS KARATE OPEN

2023-03-04

Tatami
3 14:40

Pool
1

(c)sportdata GmbH & Co KG 2000-2023 (2023-03-05 14:28) v 10.0.0 build 1 (2023-01-21) License: UAE Karate Federation (expire 2023-07-31)

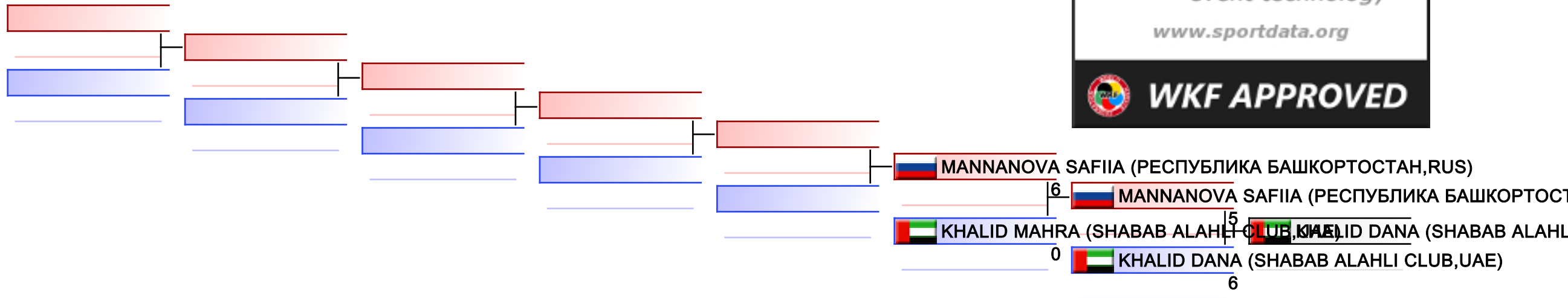

REPECHAGE: (1)

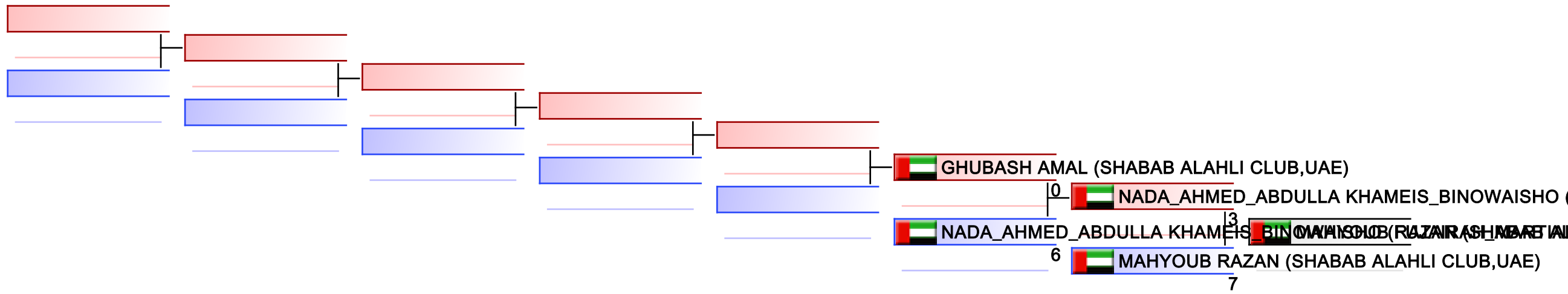

Referees:							
-----------	--	--	--	--	--	--	--

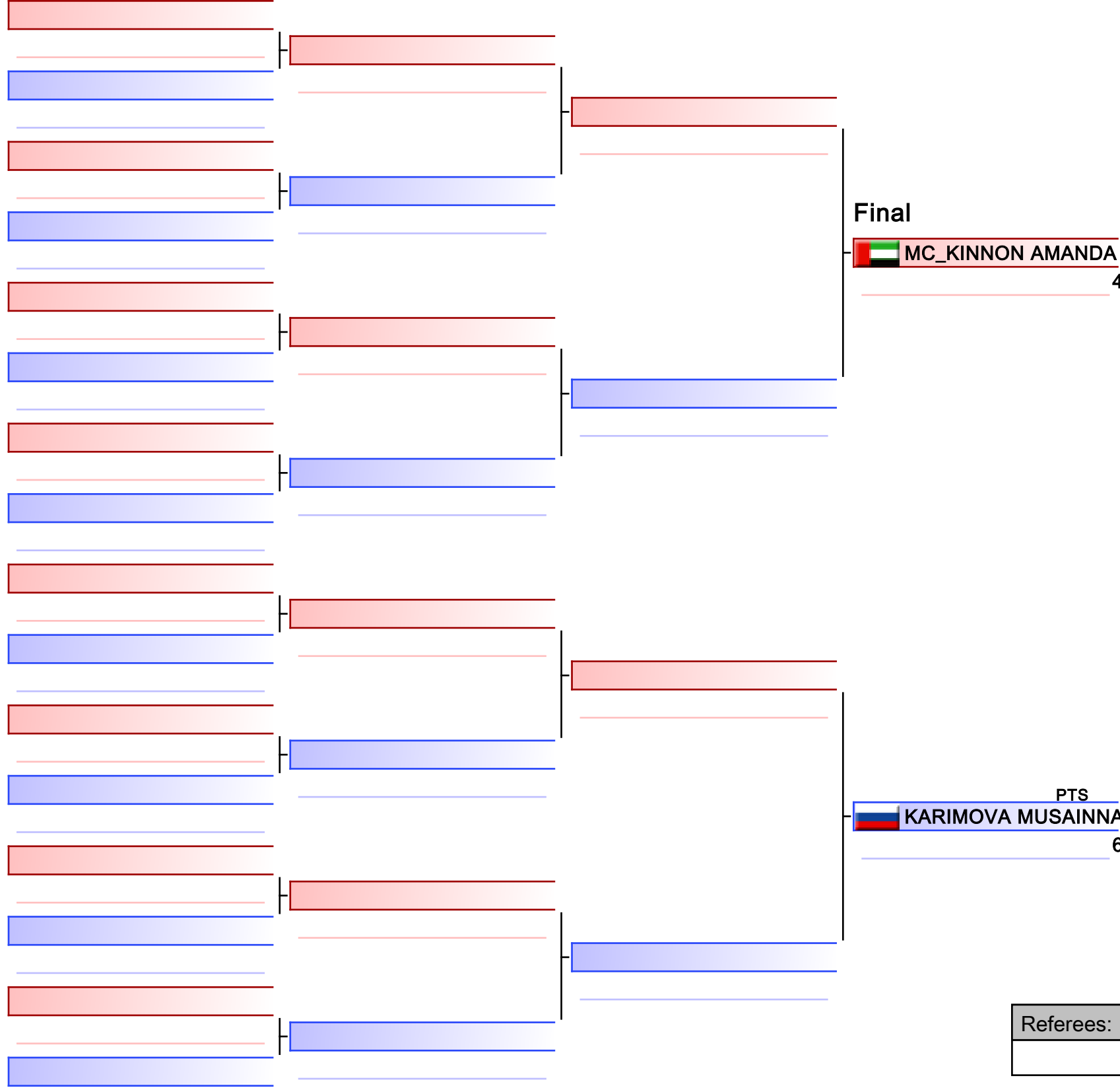

Final

 **MC_KINNON AMANDA (ORIENTAL KARATE CLUB, UAE)**
 4

 **KARIMOVA MUSAINNA (САРАТОВСКАЯ ОБЛАСТЬ, RUS)**

PTS
 **KARIMOVA MUSAINNA (САРАТОВСКАЯ ОБЛАСТЬ, RUS)**
 6

1. KARIMOVA MUSAINNA (САРАТОВСКАЯ ОБЛАСТЬ, RUS)
2. MC_KINNON AMANDA (ORIENTAL KARATE CLUB, UAE)

Referees:			

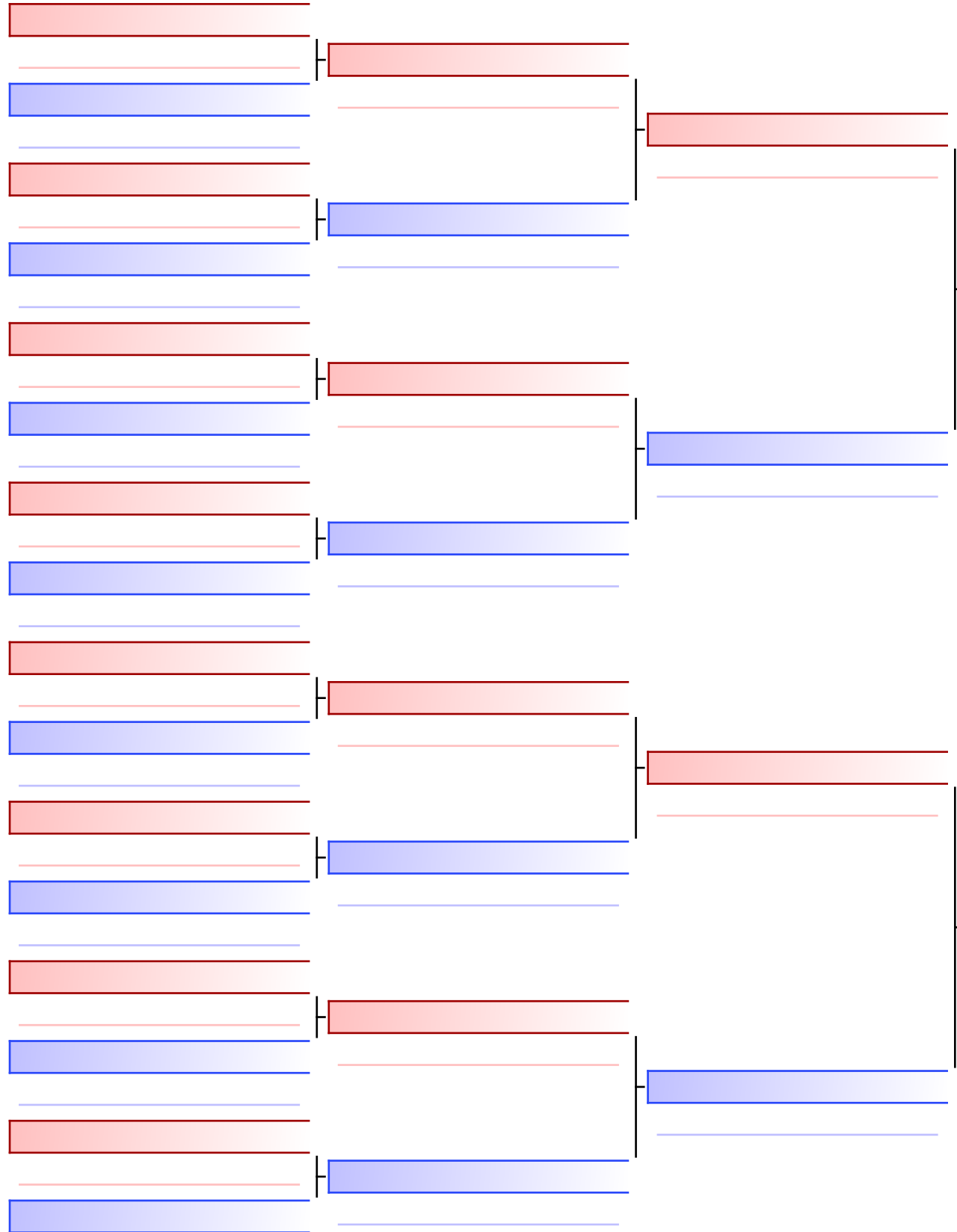

Final

AFFANDY EHSAN (MENTOR,UAE)

0

ALNOURASI JANA (ORIENTAL KARATE CLUB,UAE)

ALNOURASI JANA (ORIENTAL KARATE CLUB,UAE)

0

- | |
|--|
| 1. ALNOURASI JANA (ORIENTAL KARATE CLUB,UAE) |
| 2. AFFANDY EHSAN (MENTOR,UAE) |
| |
| |
| |
| |
| |
| |

Referees:			

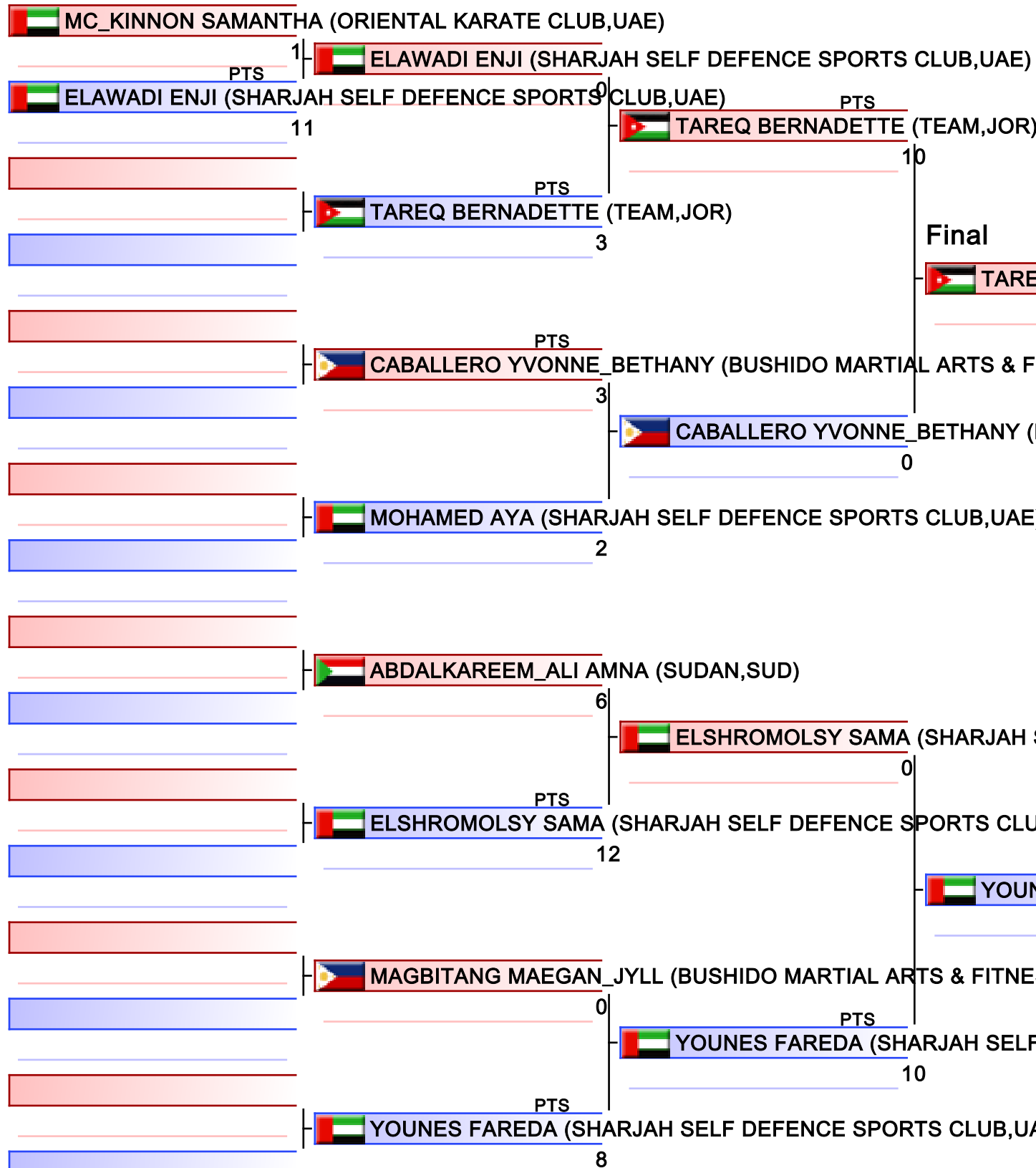

Final

TAREQ BERNADETTE (TEAM,JOR) (PTS 1)

YOUNES FAREDA (SHARJAH SELF DEFENCE SPORTS CLUB,UAE) (PTS 5)

- | |
|---|
| 1. YOUNES FAREDA (SHARJAH SELF DEFENCE SPORTS CLUB,UAE) |
| 2. TAREQ BERNADETTE (TEAM,JOR) |
| 3. ELSHROMOLSY SAMA (SHARJAH SELF DEFENCE SPORTS CLUB,UAE) |
| 3. ELAWADI ENJI (SHARJAH SELF DEFENCE SPORTS CLUB,UAE) |
| 5. MAGBITANG MAEGAN_JYLL (BUSHIDO MARTIAL ARTS & FITNESS - SKIF,PHI) |
| 5. CABALLERO YVONNE_BETHANY (BUSHIDO MARTIAL ARTS & FITNESS - SKIF,PHI) |
| |
| |

Referees:			

KIDS KUMITE FEMALE 9 YEARS

EMIRATES SPORTS KARATE OPEN

2023-03-04

Tatami
1 13:45

Pool
1

(c)sportdata GmbH & Co KG 2000-2023 (2023-03-05 14:28) v 10.0.0 build 1 (2023-01-21) License: UAE Karate Federation (expire 2023-07-31)

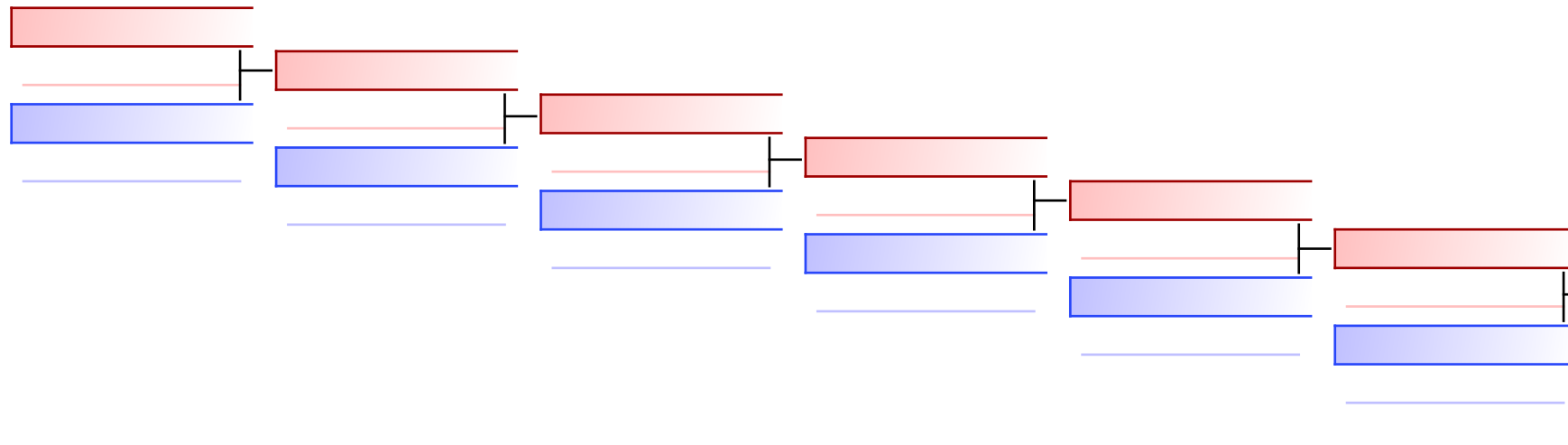

PTS
🇦🇪 ELAWADI ENJI (SHARJAH SELF DEFENCE SPORTS
🇦🇪 ELAWADI ENJI (SHARJAH SELF
🇵🇭 CABALLERO YVONNE_BETHANY (BUSHIDO MARTIAL
4

REPECHAGE: (1)

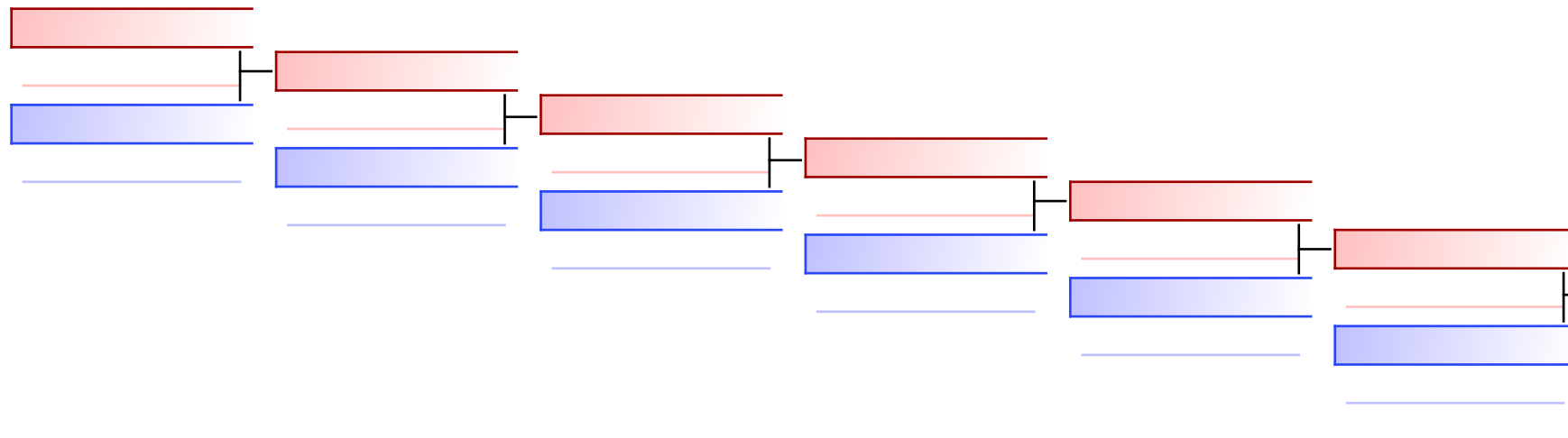

🇵🇭 MAGBITANG MAEGAN_JYLL (BUSHIDO MARTIAL AF
6
SEN
🇦🇪 ELSHROMOLSY SAMA (SHARJAH
🇦🇪 ELSHROMOLSY SAMA (SHARJAH SELF DEFENCE S
6

Referees:							
-----------	--	--	--	--	--	--	--

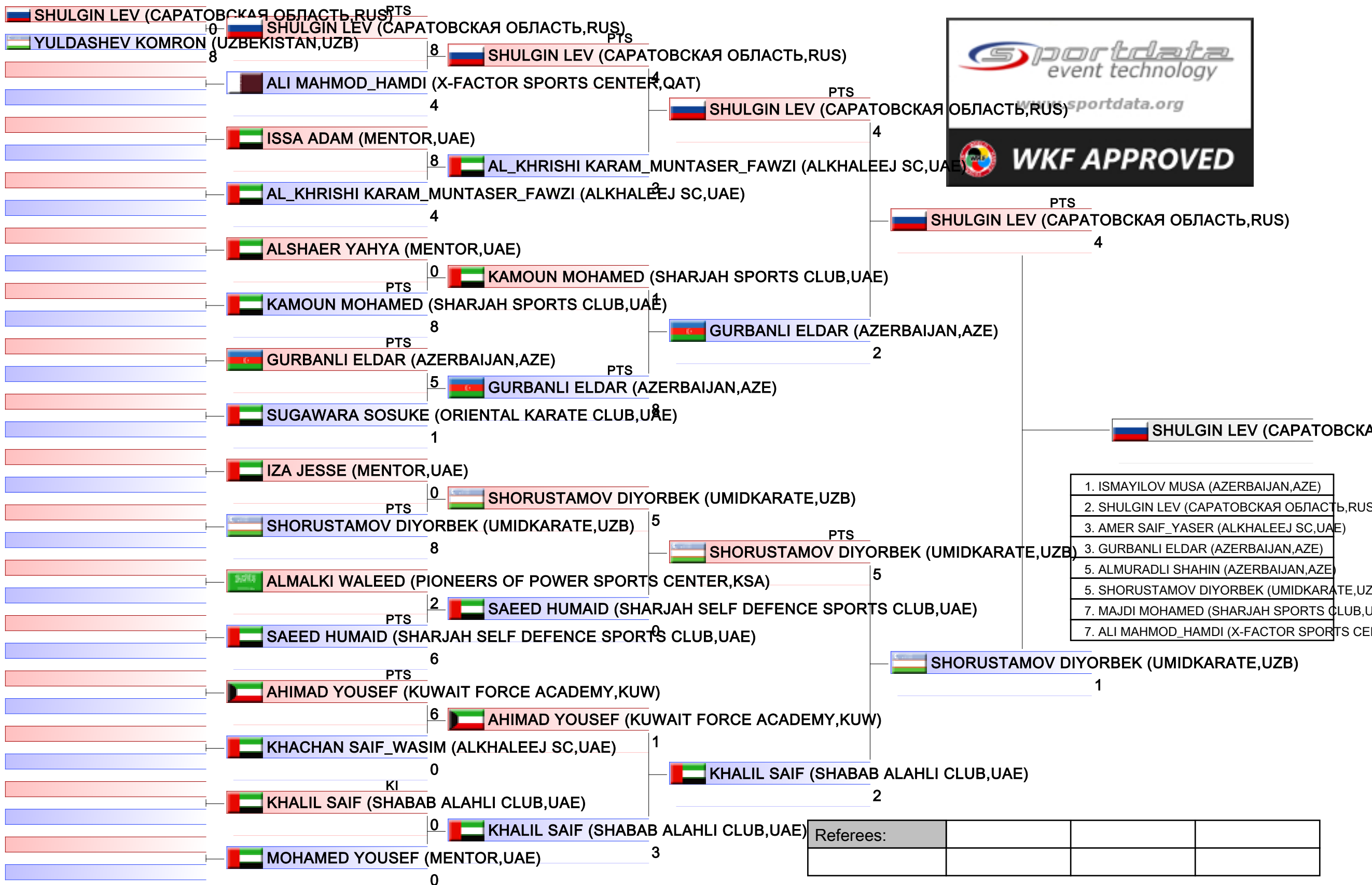

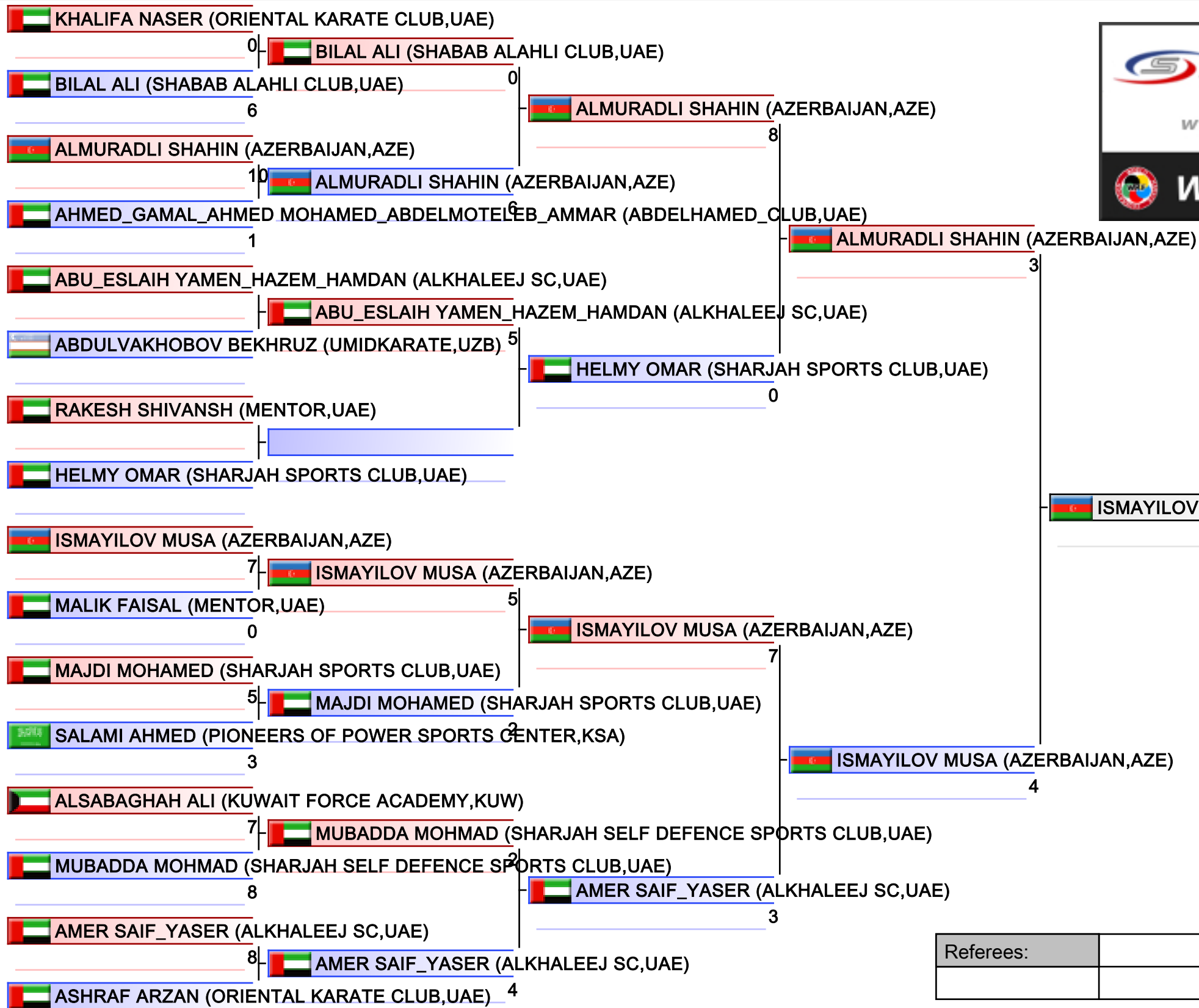

- | |
|--|
| 1. ISMAYILOV MUSA (AZERBAIJAN,AZE) |
| 2. SHULGIN LEV (CAPATOVСКАЯ ОБЛАСТЬ,RUS) |
| 3. AMER SAIF_YASER (ALKHALEEJ SC,UAE) |
| 3. GURBANLI ELDAR (AZERBAIJAN,AZE) |
| 5. ALMURADLI SHAHIN (AZERBAIJAN,AZE) |
| 5. SHORUSTAMOV DIYORBЕК (UMIDKARATE,UZB) |
| 7. MAJDI MOHAMED (SHARJAH SPORTS CLUB,UAE) |
| 7. ALI MAHMOD_HAMDI (X-FACTOR SPORTS CEN) |

Referees:			

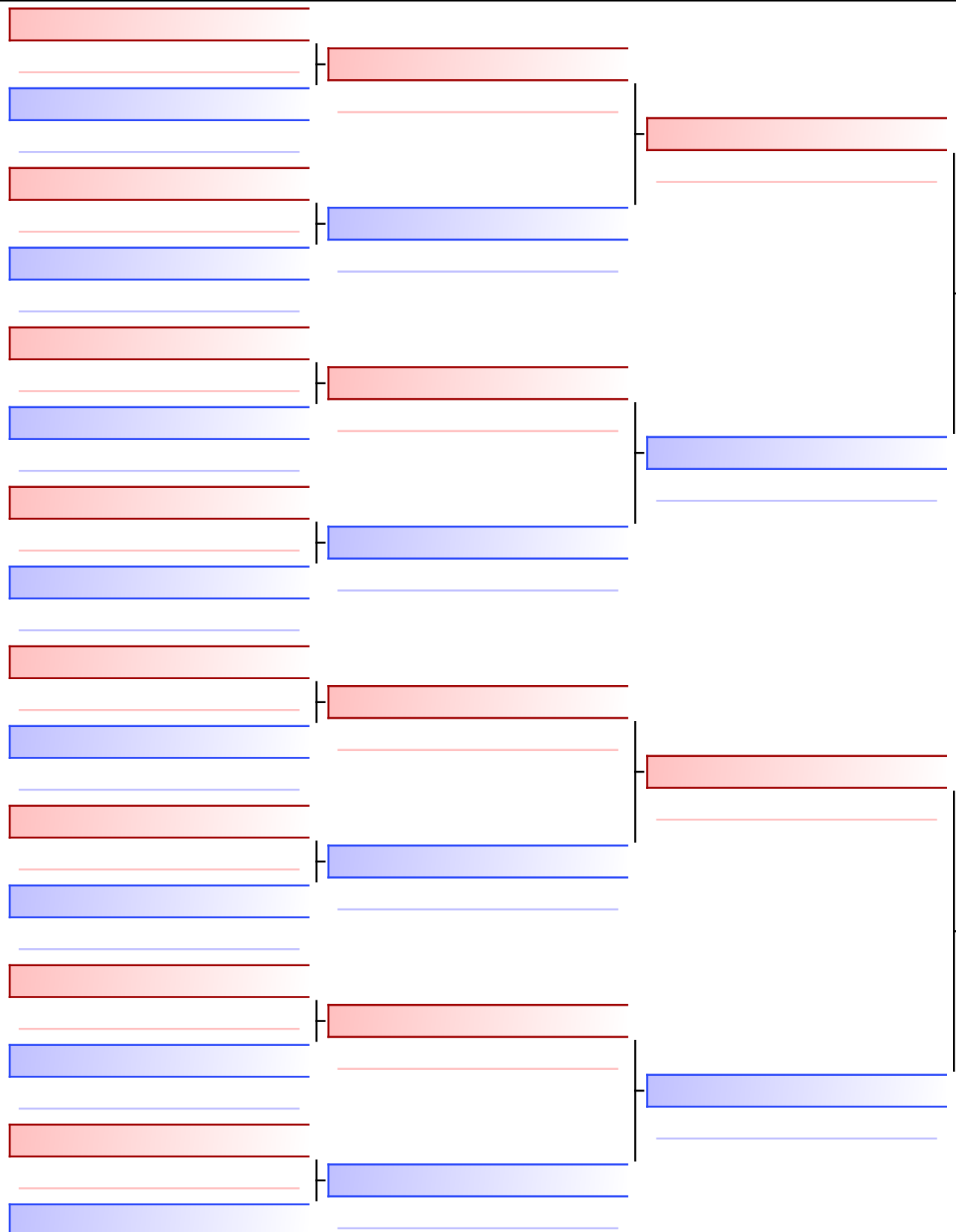

Final

 **SHULGIN LEV (CAPATOVSKAYA OBLAST',RUS)**

3

 **ISMAYILOV MUSA (AZERBAIJAN,AZE)**

PTS

 **ISMAYILOV MUSA (AZERBAIJAN,AZE)**

4

- | |
|--|
| 1. ISMAYILOV MUSA (AZERBAIJAN,AZE) |
| 2. SHULGIN LEV (CAPATOVSKAYA OBLAST',RUS) |
| 3. AMER SAIF_YASER (ALKHALEEEJ SC,UAE) |
| 3. GURBANLI ELDAR (AZERBAIJAN,AZE) |
| 5. ALMURADLI SHAHIN (AZERBAIJAN,AZE) |
| 5. SHORUSTAMOV DIYORBЕК (UMIDKARATE,UZB) |
| 7. MAJDI MOHAMED (SHARJAH SPORTS CLUB,UAE) |
| 7. ALI MAHMUD_HAMDI (X-FACTOR SPORTS CEN,UA) |

Referees:			

KIDS KUMITE MALE 10 YEARS

EMIRATES SPORTS KARATE OPEN

2023-03-04

Tatami
2 14:05

Pool
1,2

(c)sportdata GmbH & Co KG 2000-2023 (2023-03-05 14:28) v 10.0.0 build 1 (2023-01-21) License: UAE Karate Federation (expire 2023-07-31)

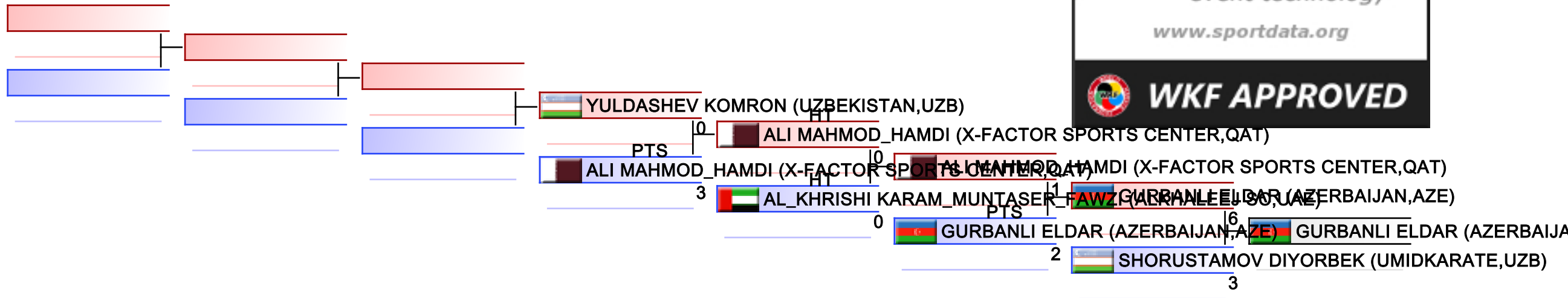

REPECHAGE: (1,2)

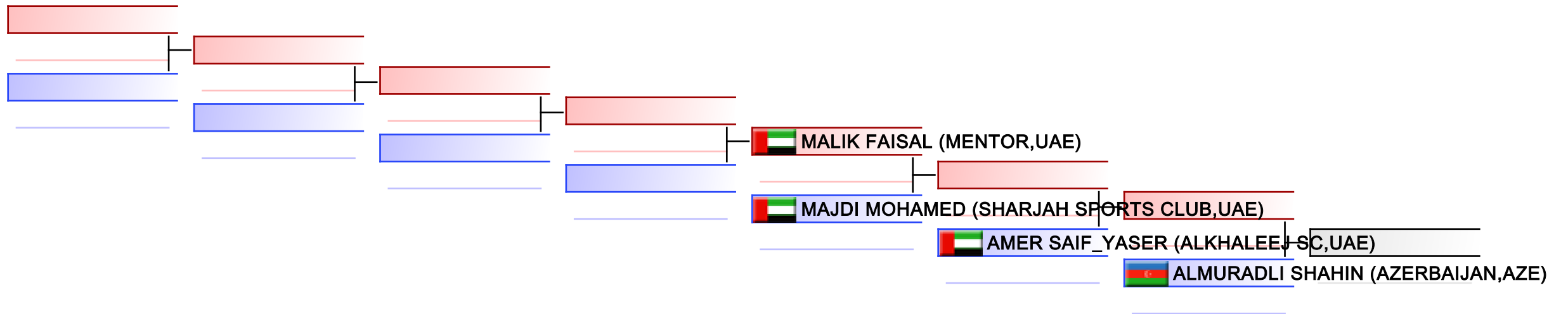

Referees:							
-----------	--	--	--	--	--	--	--

KIDS KUMITE MALE 10 YEARS

EMIRATES SPORTS KARATE OPEN

2023-03-04

Tatami
2 14:05

Pool
1

(c)sportdata GmbH & Co KG 2000-2023 (2023-03-05 14:28) v 10.0.0 build 1 (2023-01-21) License: UAE Karate Federation (expire 2023-07-31)

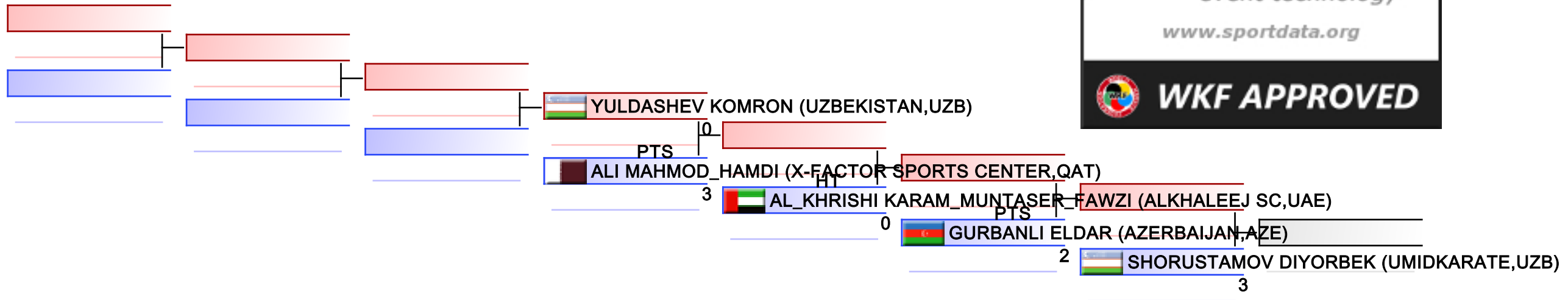

REPECHAGE: (1)

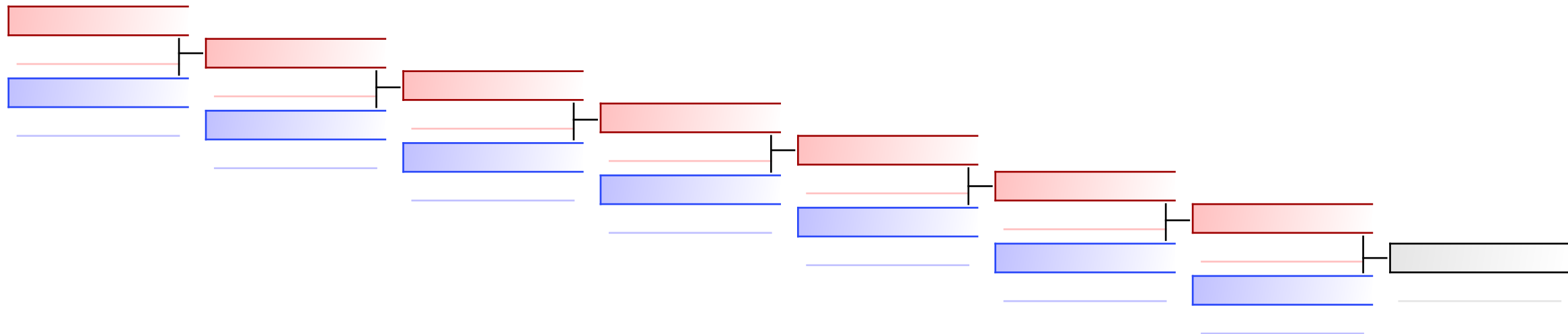

Referees:							
-----------	--	--	--	--	--	--	--

KIDS KUMITE MALE 10 YEARS

EMIRATES SPORTS KARATE OPEN

2023-03-04

Tatami
3 14:00

Pool
2

(c)sportdata GmbH & Co KG 2000-2023 (2023-03-05 14:28) v 10.0.0 build 1 (2023-01-21) License: UAE Karate Federation (expire 2023-07-31)

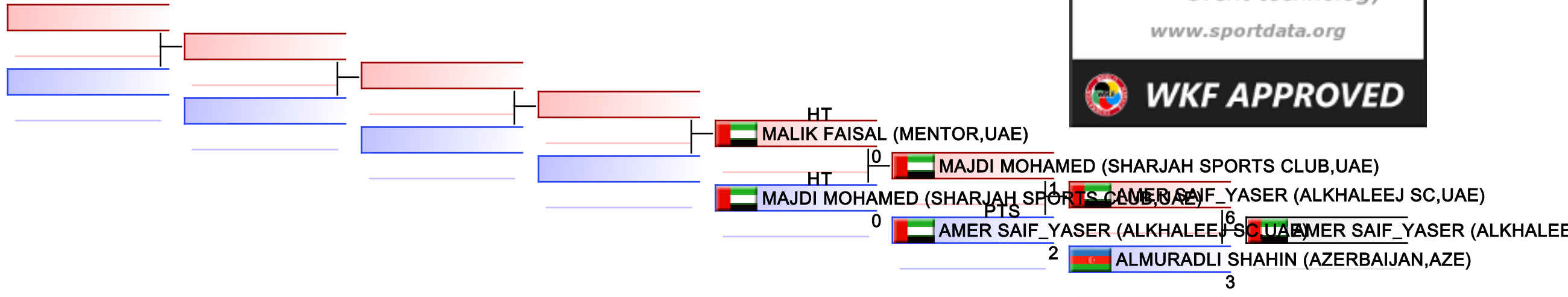

REPECHAGE: (2)

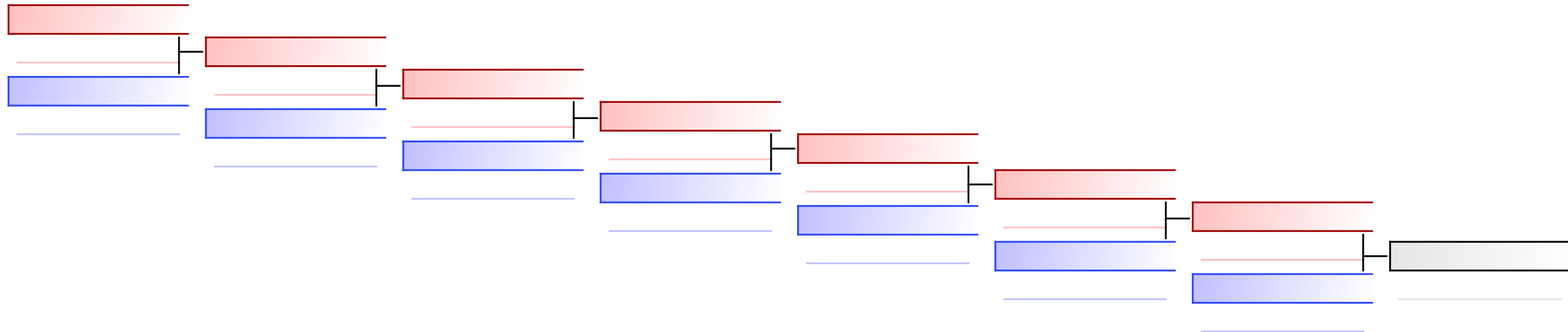

Referees:							
-----------	--	--	--	--	--	--	--

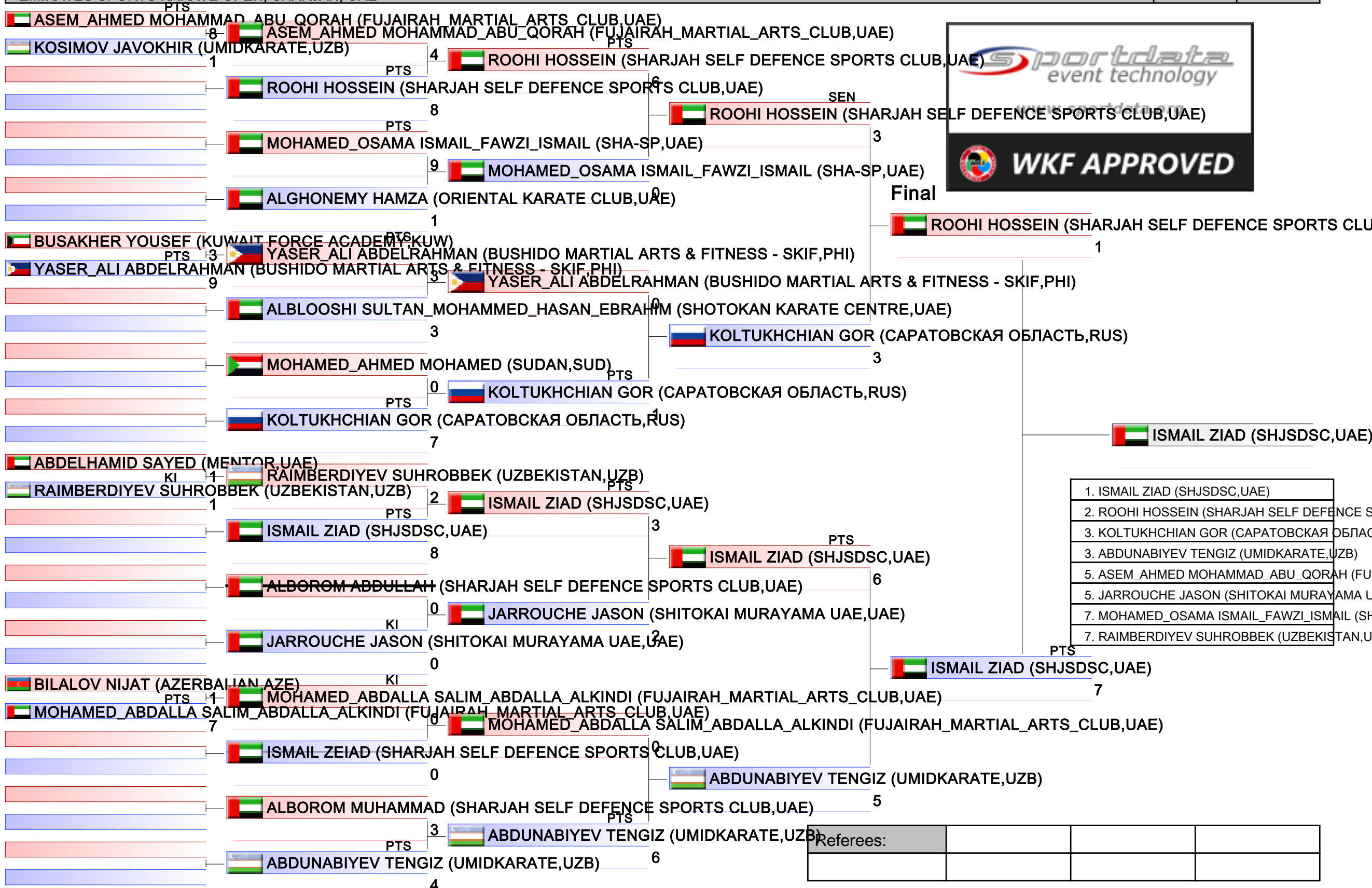

1. ISMAIL ZIAD (SHJSDSC, UAE)
2. ROOHI HOSSEIN (SHARJAH SELF DEFENCE SPORTS CLUB, UAE)
3. KOLTUKHCHIAN GOR (САРАТОВСКАЯ ОБЛАСТЬ, RUS)
3. ABDUNABIYEV TENGIZ (UMIDKARATE, UZB)
5. ASEM_AHMED MOHAMMAD_ABU_QORAH (FUJAIRAH MARTIAL ARTS CLUB, UAE)
5. JARROUCHE JASON (SHITOKAI MURAYAMA UAE, UAE)
7. MOHAMED_OSAMA ISMAIL_FAWZI_ISMAIL (SHA-SP, UAE)
7. RAIMBERDIYEV SUHROBBEK (UZBEKISTAN, UZB)

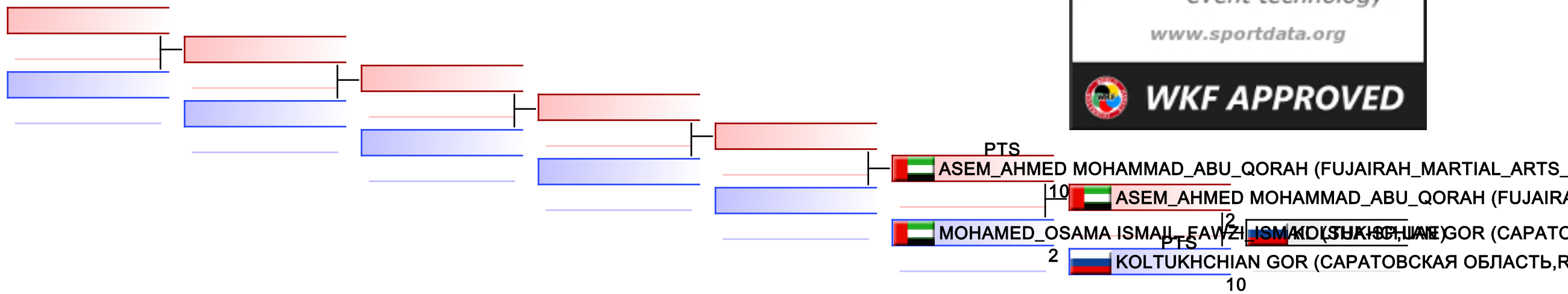

REPECHAGE: (1)

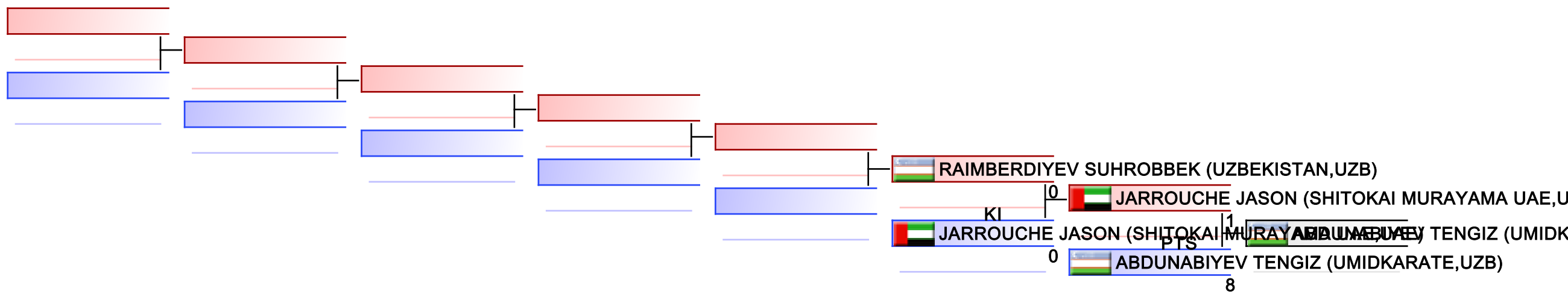

Referees:							
-----------	--	--	--	--	--	--	--

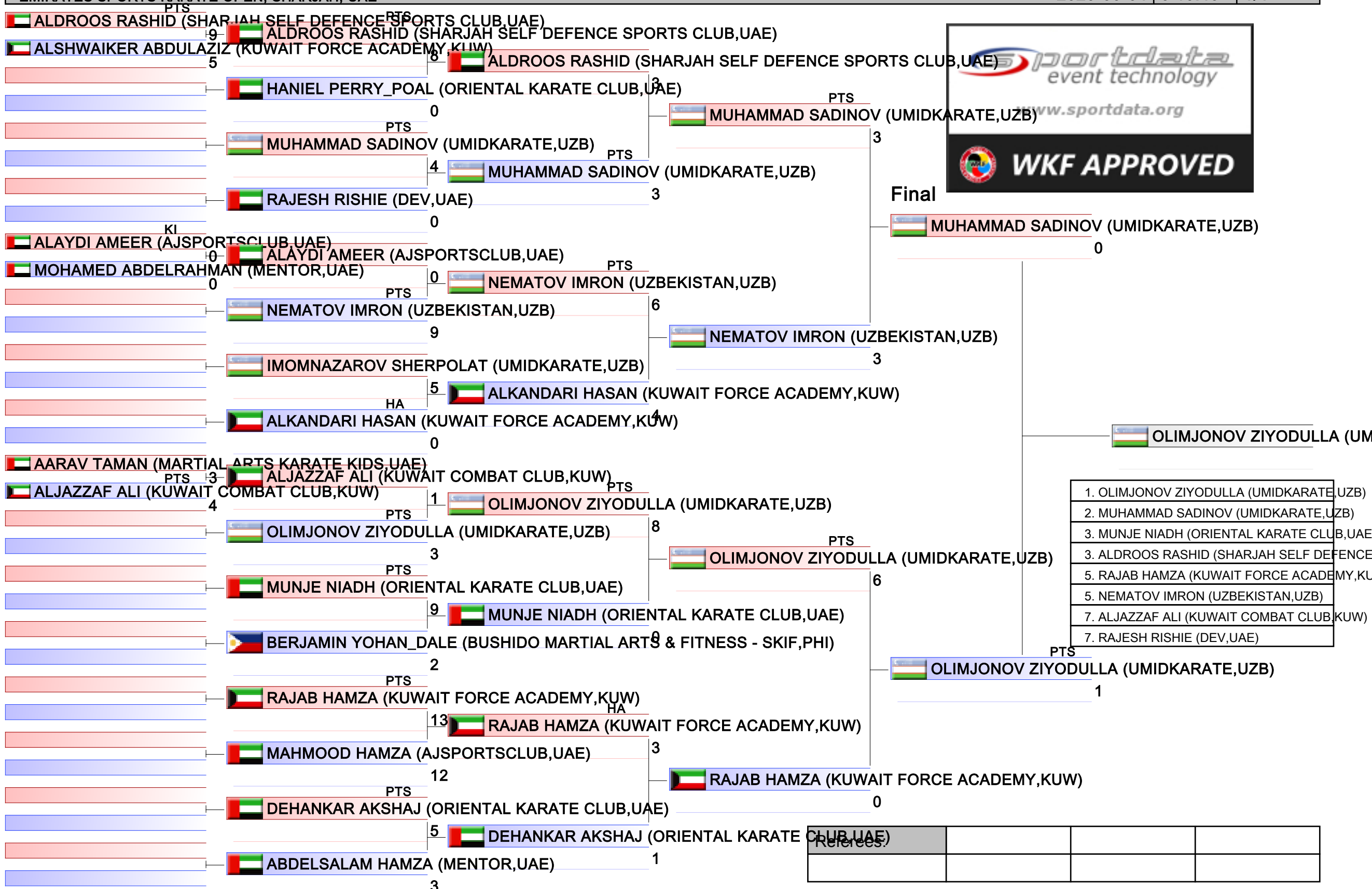

1. OLIMJONOV ZIYODULLA (UMIDKARATE,UZB)
2. MUHAMMAD SADINOV (UMIDKARATE,UZB)
3. MUNJE NIADH (ORIENTAL KARATE CLUB,UAE)
3. ALDROOS RASHID (SHARJAH SELF DEFENCE SPORTS CLUB,UAE)
5. RAJAB HAMZA (KUWAIT FORCE ACADEMY,KUW)
5. NEMATOV IMRON (UZBEKISTAN,UZB)
7. ALJAZZAF ALI (KUWAIT COMBAT CLUB,KUW)
7. RAJESH RISHIE (DEV,UAE)

KIDS KUMITE MALE 7 YEARS

EMIRATES SPORTS KARATE OPEN

2023-03-04

Tatami
5 14:15

Pool
1

(c)sportdata GmbH & Co KG 2000-2023 (2023-03-05 14:28) v 10.0.0 build 1 (2023-01-21) License: UAE Karate Federation (expire 2023-07-31)

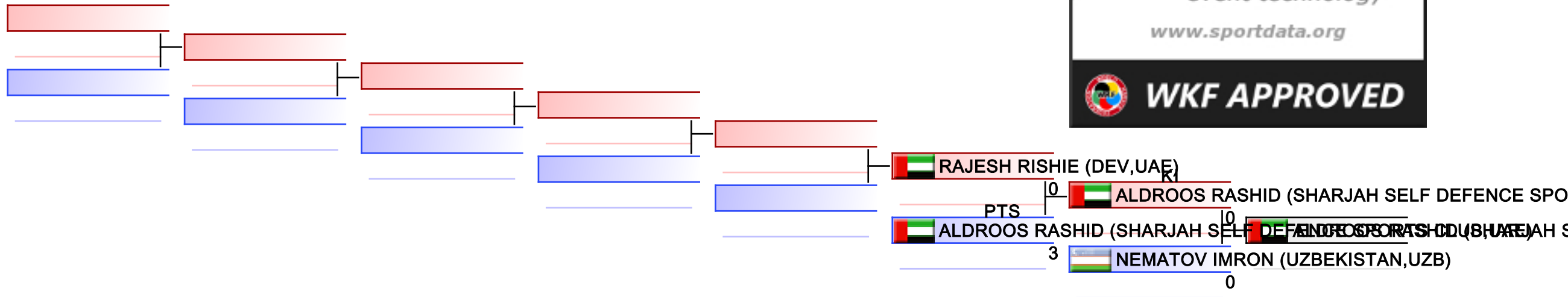

REPECHAGE: (1)

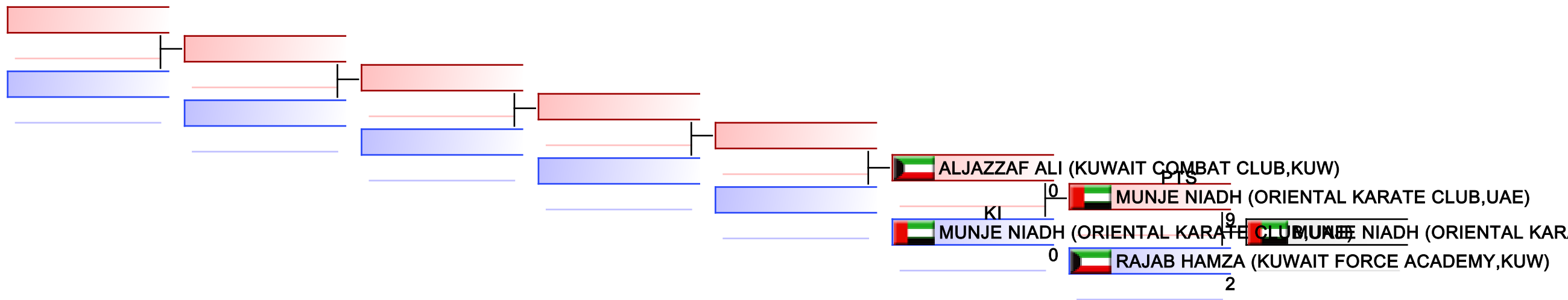

Referees:							
-----------	--	--	--	--	--	--	--

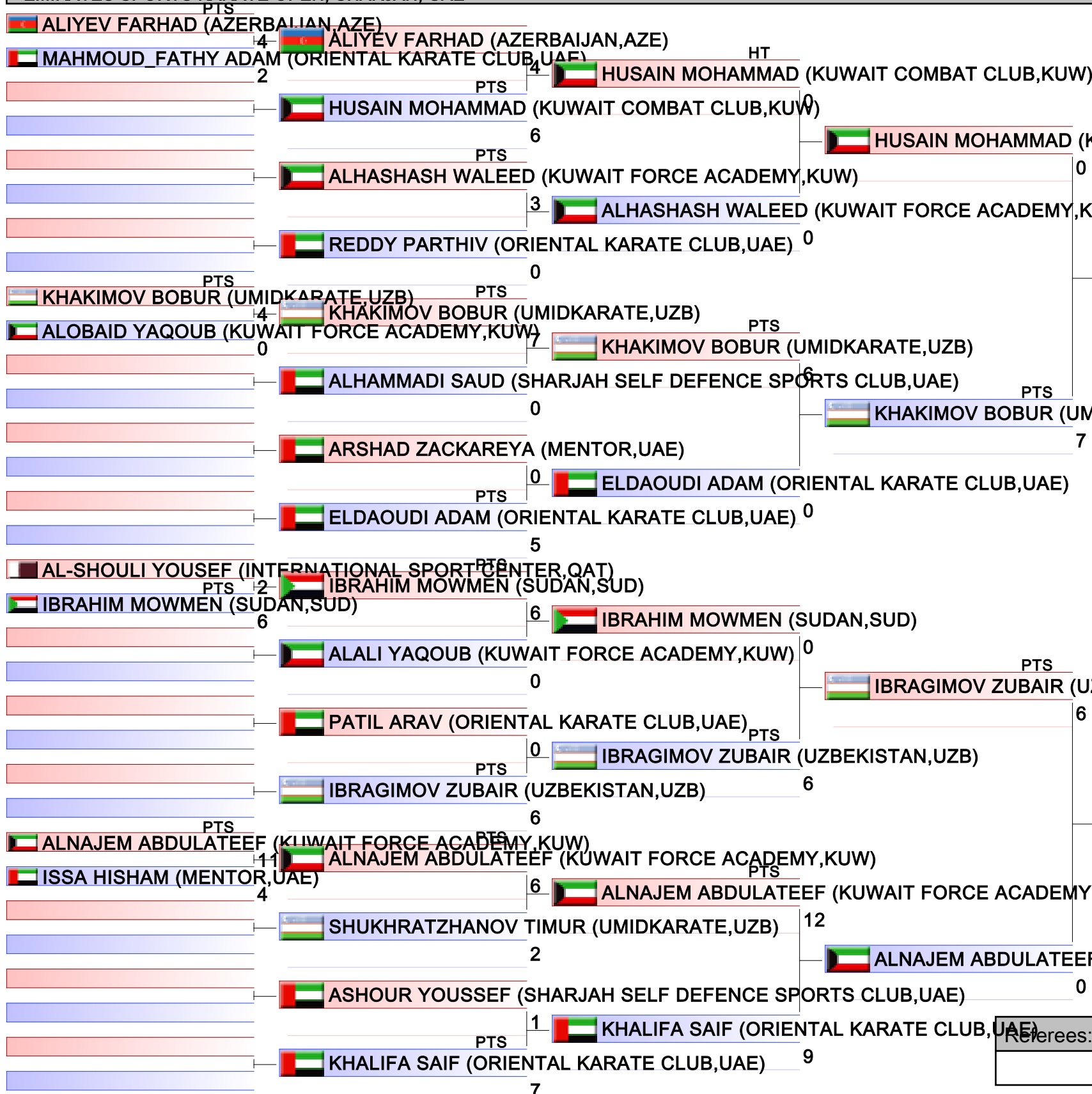

- | |
|--|
| 1. KHAKIMOV BOBUR (UMIDKARATE,UZB) |
| 2. IBRAGIMOV ZUBAIR (UZBEKISTAN,UZB) |
| 3. ALNAJEM ABDULATEEF (KUWAIT FORCE ACADEMY,KUW) |
| 3. HUSAIN MOHAMMAD (KUWAIT COMBAT CLUB,KUW) |
| 5. IBRAHIM MOWMEN (SUDAN,SUD) |
| 5. ALOBAID YAQOUB (KUWAIT FORCE ACADEMY,KUW) |
| 7. PATIL ARAV (ORIENTAL KARATE CLUB,UAE) |
| 7. ELDAOUDI ADAM (ORIENTAL KARATE CLUB,UAE) |

KIDS KUMITE MALE 8 YEARS

EMIRATES SPORTS KARATE OPEN

2023-03-04

Tatami
1 14:35

Pool
1

(c)sportdata GmbH & Co KG 2000-2023 (2023-03-05 14:28) v 10.0.0 build 1 (2023-01-21) License: UAE Karate Federation (expire 2023-07-31)

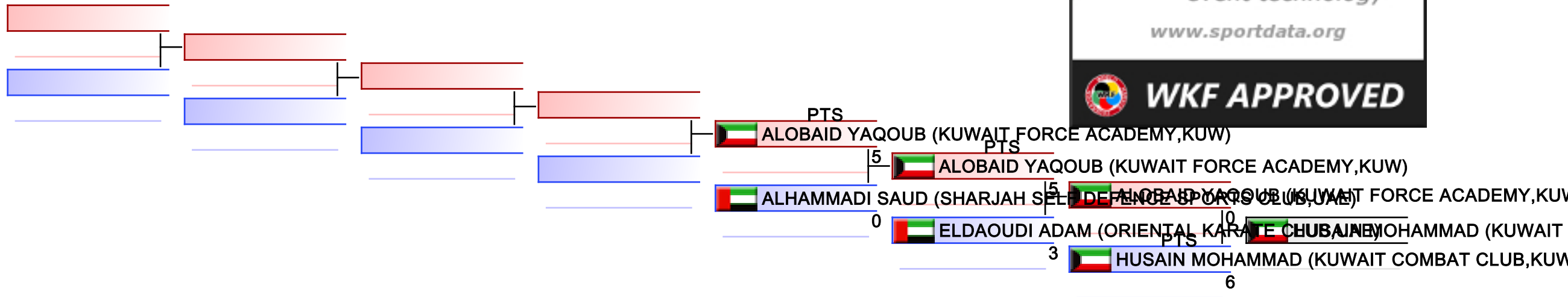

REPECHAGE: (1)

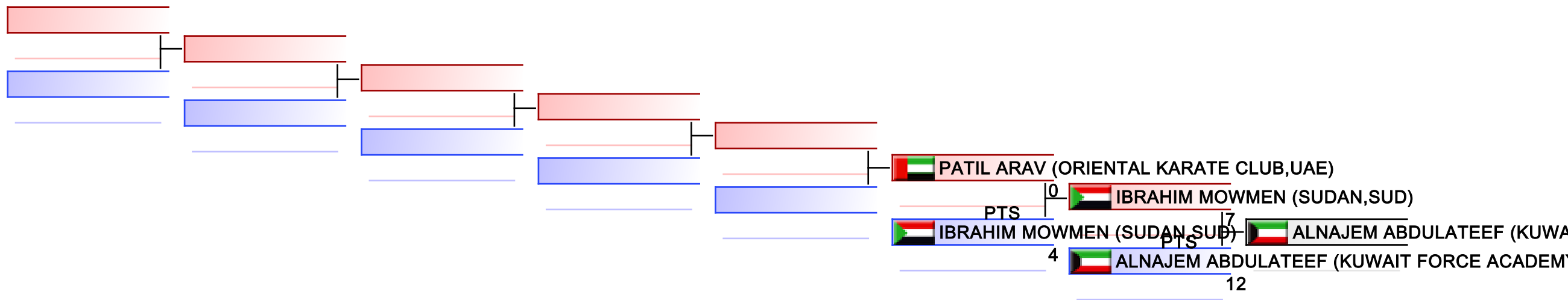

Referees:							
-----------	--	--	--	--	--	--	--

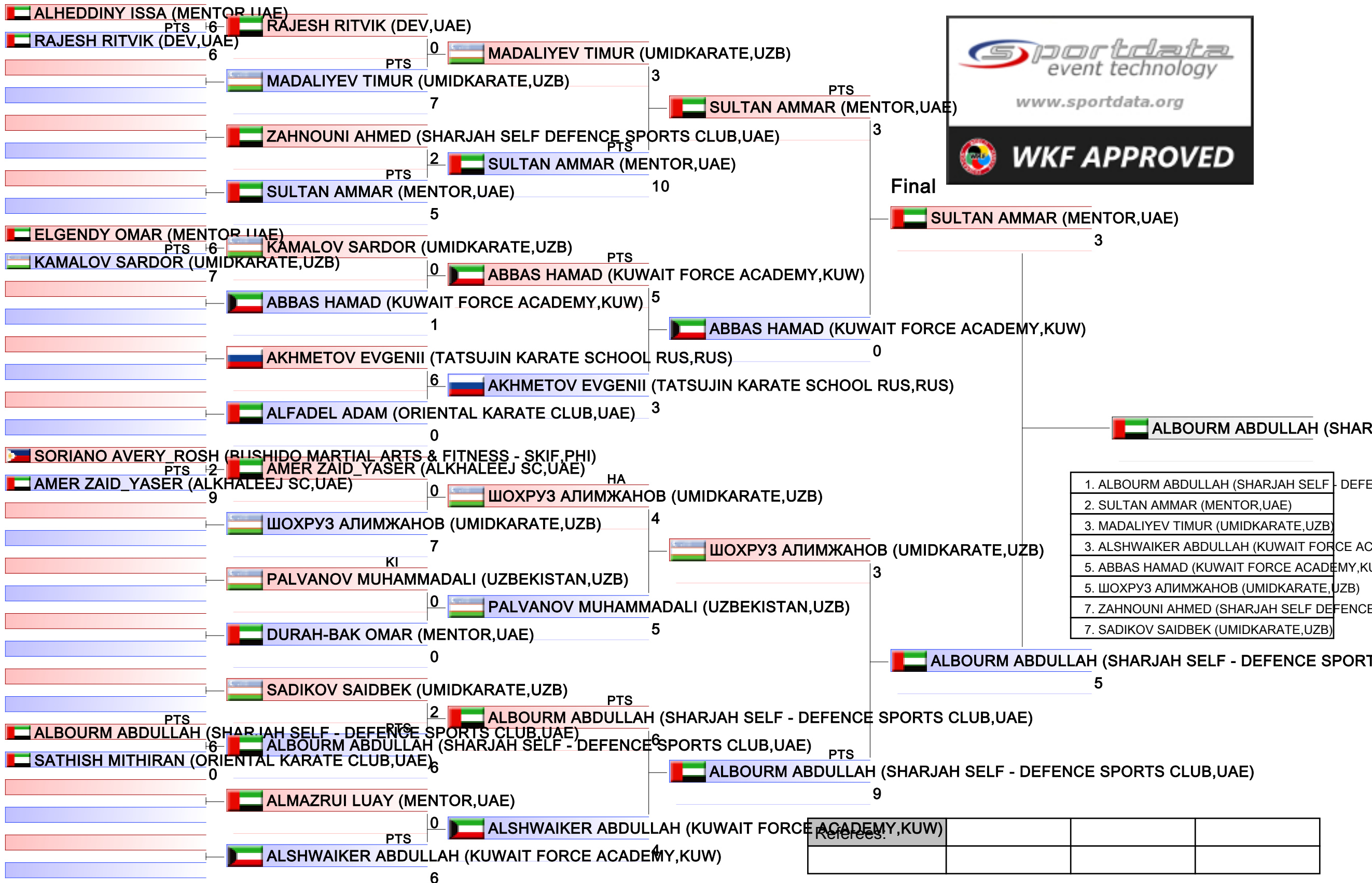

1. ALBOURM ABDULLAH (SHARJAH SELF - DEFENCE SPORTS CLUB,UAE)
2. SULTAN AMMAR (MENTOR,UAE)
3. MADALIYEV TIMUR (UMIDKARATE,UZB)
3. ALSHWAIKER ABDULLAH (KUWAIT FORCE ACADEMY,KUW)
5. ABBAS HAMAD (KUWAIT FORCE ACADEMY,KUW)
5. ШОХРУЗ АЛИМЖАHOV (UMIDKARATE,UZB)
7. ZAHNOUNI AHMED (SHARJAH SELF DEFENCE SPORTS CLUB,UAE)
7. SADIKOV SAIDBEK (UMIDKARATE,UZB)

KIDS KUMITE MALE 9 YEARS

EMIRATES SPORTS KARATE OPEN

2023-03-04

Tatami
2 14:50

Pool
1

(c)sportdata GmbH & Co KG 2000-2023 (2023-03-05 14:28) v 10.0.0 build 1 (2023-01-21) License: UAE Karate Federation (expire 2023-07-31)

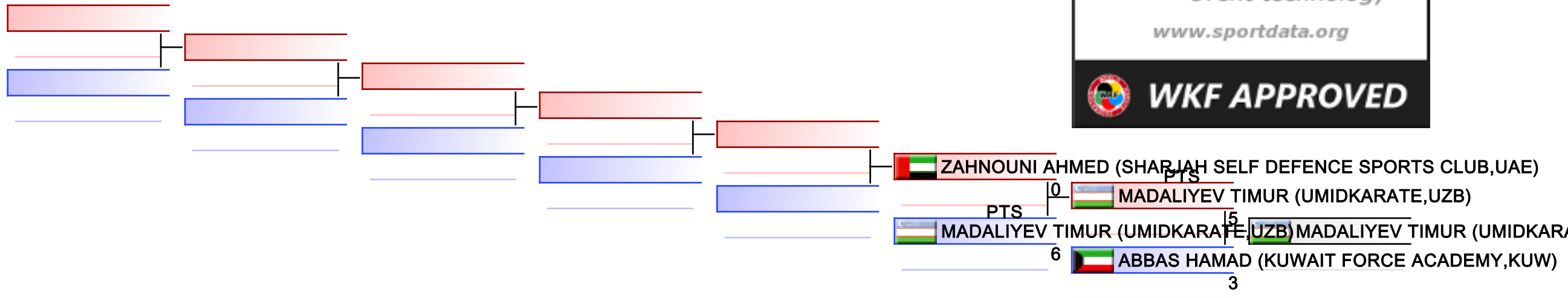

REPECHAGE: (1)

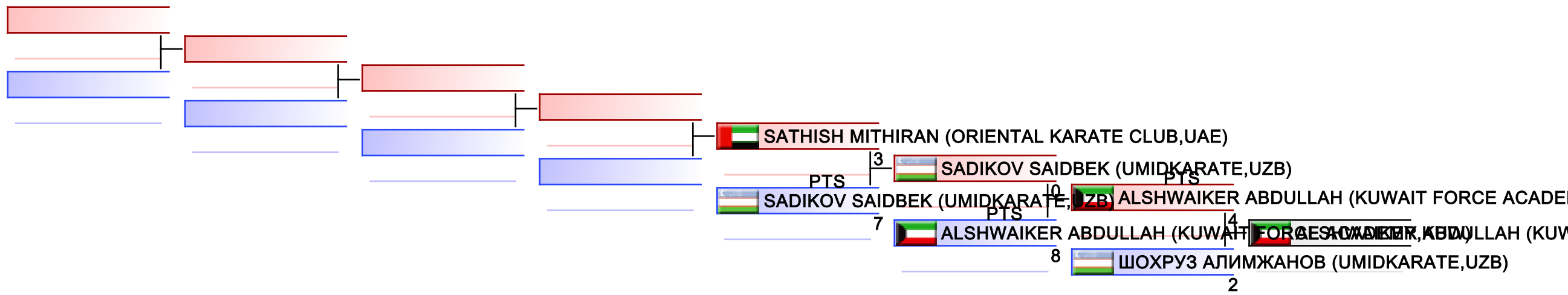

Referees:							
-----------	--	--	--	--	--	--	--



EMIRATES SPORTS KARATE OPEN - 2023-03-03

Senior kata female



R1 G1/2 (6) Tatami 3 14:00(2023-03-03)

Competitors	Kata	1	2	3	4	5	6	7	TOTAL	Extra	Total Rank
1 BARAVIK VERANIKA (НАЦИОНАЛЬНАЯ КОМАНДА BLR,BLR)	002 ANAN DAI	(6.6)	7.6	7.4	(7.8)	7.5			22.5		22.5 2
2 VERMA AKANKSHA (INDIA TEAM,IND)	008 CHATANYARA KUSHANKU	(6.8)	(7.7)	7.2	7.2	7.4			21.8		21.8 3
3 SHRESTHA SHARMILA (UNITED ARAB EMIRATES,UAE)	092 SUPARINPEI	7.2	(7.5)	(6.8)	6.8	7.3			21.3		21.3 4
4 FILIUKOVA NATALIA (СПОРТИВНАЯ ШКОЛА ЛИДЕР,RUS)	061 NIPAIPO	7.5	(7.8)	(7.1)	7.7	7.6			22.8		22.8 1
5 WAHIDI ZAINAB (KUWAIT FORCE ACADEMY,KUW)	021 GOJUSHIHO SHO	(5.4)	(6.9)	5.9	6.5	6.8			19.2		19.2 6
6 KAMAL SUMIYA (SHARJAH SPORTS CLUB,UAE)	021 GOJUSHIHO SHO	(6.2)	(7.4)	6.5	6.6	7.2			20.3		20.3 5

R1 G2/2 (6) Tatami 4 14:00(2023-03-03)

Competitors	Kata	1	2	3	4	5	6	7	TOTAL	Extra	Total Rank
1 SHAH_ABBAS_ALI BUSHRA (AL AZZAM KARATE CENTER, SHARJAH,UAE)	027 HEIAN SANDAN	5.8	(7.1)	6.5	(5.5)	6.5			18.8		18.8 6
2 SHCHERBINA ANNA (САРАТОВСКАЯ ОБЛАСТЬ,RUS)	061 NIPAIPO	7.3	7.5	7.7	(7.9)	(7.2)			22.5		22.5 3
3 HAMZA ANSHIDA (AL FAROOQ,UAE)	020 GOJUSHIHO DAI	7.0	(7.4)	7.1	6.8	(6.7)			20.9		20.9 5
4 KHOZYAEVA VALERIYA (НОВОСИБИРСКАЯ ОБЛАСТЬ,RUS)	001 ANAN	7.5	7.5	(7.7)	7.5	(7.3)			22.5		22.5 2
5 NAZOURI MOJDEH (SHARJAH SPORTS CLUB,UAE)	020 GOJUSHIHO DAI	(6.8)	(7.4)	7.4	6.8	7.0			21.2		21.2 4
6 ZOTOVA MARIA (СПОРТИВНАЯ ШКОЛА ЛИДЕР,RUS)	030 HEIKU	(7.2)	7.7	(7.8)	7.4	7.8			22.9		22.9 1

R2-G1 Tatami 3 14:30(2023-03-03)

Competitors	Kata	1	2	3	4	5	6	7	TOTAL	Extra	Total Rank
1 SHRESTHA SHARMILA (UNITED ARAB EMIRATES,UAE)	001 ANAN	7.0	(7.3)	(6.9)	7.3	7.0			21.3		21.3 4
2 VERMA AKANKSHA (INDIA TEAM,IND)	068 PAPUREN	(7.5)	7.5	7.6	7.5	(8.0)			22.6		22.6 3
3 BARAVIK VERANIKA (НАЦИОНАЛЬНАЯ КОМАНДА BLR,BLR)	064 OHAN DAI	(7.3)	7.9	(8.1)	7.4	7.8			23.1		23.1 2
4 FILIUKOVA NATALIA (СПОРТИВНАЯ ШКОЛА ЛИДЕР,RUS)	001 ANAN	8.0	(7.6)	(8.2)	7.6	7.9			23.5		23.5 1

R2-G2 Tatami 4 14:30(2023-03-03)

Competitors	Kata	1	2	3	4	5	6	7	TOTAL	Extra	Total Rank
1 NAZOURI MOJDEH (SHARJAH SPORTS CLUB,UAE)	021 GOJUSHIHO SHO	6.9	(6.7)	(7.2)	6.8	6.8			20.5		20.5 4
2 ZOTOVA MARIA (СПОРТИВНАЯ ШКОЛА ЛИДЕР,RUS)	067 PAIKU	(7.3)	7.5	(7.6)	7.4	7.4			22.3		22.3 3
3 SHCHERBINA ANNA (САРАТОВСКАЯ ОБЛАСТЬ,RUS)	068 PAPUREN	7.8	(8.0)	7.8	(7.2)	7.8			23.4		23.4 1
4 KHOZYAEVA VALERIYA (НОВОСИБИРСКАЯ ОБЛАСТЬ,RUS)	002 ANAN DAI	7.5	(8.4)	(7.3)	7.5	7.6			22.6		22.6 2

R3 Bronze Medal Match 1 Tatami 3 14:50(2023-03-03)

Competitors	Kata	1	2	3	4	5	6	7	TOTAL	Extra	Total Rank
1 BARAVIK VERANIKA (НАЦИОНАЛЬНАЯ КОМАНДА BLR,BLR)	068 PAPUREN	7.8	7.6	(7.5)	(8.0)	7.8			23.2		23.2 1
2 ZOTOVA MARIA (СПОРТИВНАЯ ШКОЛА ЛИДЕР,RUS)	066 PACHU	7.7	(7.4)	(7.8)	7.7	7.6			23.0		23.0 2

R3 Bronze Medal Match 2 Tatami 4 14:50(2023-03-03)

Competitors	Kata	1	2	3	4	5	6	7	TOTAL	Extra	Total Rank
1 VERMA AKANKSHA (INDIA TEAM,IND)	009 CHIBANA NO KUSHANKU	7.5	(7.8)	7.8	7.3	(7.2)			22.6		22.6 2
2 KHOZYAEVA VALERIYA (НОВОСИБИРСКАЯ ОБЛАСТЬ,RUS)	067 PAIKU	7.8	(8.1)	7.7	7.7	(7.4)			23.2		23.2 1

R3 Gold Medal Match Tatami 5 10:30(2023-03-05)

Competitors	Kata	1	2	3	4	5	6	7	TOTAL	Extra	Total Rank
1 FILIUKOVA NATALIA (СПОРТИВНАЯ ШКОЛА ЛИДЕР,RUS)	068 PAPUREN	(8.4)	8.1	8.0	7.6	7.7	(7.5)	7.5	38.9		38.9 2
2 SHCHERBINA ANNA (САРАТОВСКАЯ ОБЛАСТЬ,RUS)	064 OHAN DAI	8.2	(8.3)	8.2	7.9	8.0	7.9	(7.8)	40.2		40.2 1

Results





EMIRATES SPORTS KARATE OPEN - 2023-03-03

Senior kata female



1	SHCHERBINA ANNA		RUSSIAN FEDERATION
2	FILIUKOVA NATALIA		RUSSIAN FEDERATION
3	BARAVIK VERANIKA		BELARUS
3	KHOZYAEVA VALERIYA		RUSSIAN FEDERATION
5	ZOTOVA MARIA		RUSSIAN FEDERATION
5	VERMA AKANKSHA		INDIA
7	SHRESTHA SHARMILA		UNITED ARAB EMIRATES
7	NAZOURI MOJDEH		UNITED ARAB EMIRATES
9	KAMAL SUMIYA		UNITED ARAB EMIRATES
9	HAMZA ANSHIDA		UNITED ARAB EMIRATES
11	WAHIDI ZAINAB		KUWAIT
11	SHAH ABBAS ALI BUSHRA		UNITED ARAB EMIRATES





EMIRATES SPORTS KARATE OPEN - 2023-03-03

Senior kata male



R1 G1/2 (5) Tatami 1 14:35(2023-03-03)

Competitors	Kata	1	2	3	4	5	6	7	TOTAL	Extra Total Rank
1 GUPTA ANIKET (INDIA TEAM,IND)	068 PAPUREN	7.2	7.4	(6.1)	7.7	(7.8)			22.3	22.3 4
2 HAMZA WALEED (AL FAROOQ,UAE)	041 KANKU SHO	6.9	(7.9)	(5.6)	7.9	7.2			22.0	22.0 5
3 THARINDU DIMANTHA (KARATE PRO , DUBAI,UAE)	021 GOJUSHIHO SHO	7.5	7.6	(7.3)	7.6	(7.7)			22.7	22.7 2
4 KARIM_WAEL MOHAMED ABDULAZIM (ABDELHAMED CLUB,UAE)	020 GOJUSHIHO DAI	7.3	(7.0)	7.5	(8.0)	7.8			22.6	22.6 3
5 SAIDU SAMROOD (MARTIAL ARTS KARATE KIDS,UAE)	092 SUPARINPEI	(7.7)	(8.2)	7.7	8.1	7.8			23.6	23.6 1

R1 G2/2 (5) Tatami 2 14:35(2023-03-03)

Competitors	Kata	1	2	3	4	5	6	7	TOTAL	Extra Total Rank
1 K_T MUZAMMIL (SUN&STARS KARATE CENTER,UAE)	099 UNSU	7.1	6.8	6.9	(7.5)	(6.5)			20.8	20.8 4
2 WADEE ABU_WAKIM (SHARJAH SPORTS CLUB,UAE)	041 KANKU SHO	(7.8)	7.2	(7.1)	7.8	7.5			22.5	22.5 2
3 T_R VISHNU (GULF STAR KARATE,UAE)	021 GOJUSHIHO SHO	7.7	(6.7)	7.0	(8.3)	7.4			22.1	22.1 3
4 HUSAIN MEQDAD (KUWAIT COMBAT CLUB,KUW)	012 ENPI	(7.0)	6.9	6.4	(5.9)	6.4			19.7	19.7 5
5 LARIN IVAN (TATSUJIN KARATE SCHOOL RUS,RUS)	001 ANAN	7.5	7.4	7.7	(7.9)	(6.8)			22.6	22.6 1

R2 Bronze Medal Match 1 Tatami 1 15:00(2023-03-03)

Competitors	Kata	1	2	3	4	5	6	7	TOTAL	Extra Total Rank
1 THARINDU DIMANTHA (KARATE PRO , DUBAI,UAE)	099 UNSU	7.1	(7.6)	7.3	(7.0)	7.6			22.0	22.0 2
2 T_R VISHNU (GULF STAR KARATE,UAE)	020 GOJUSHIHO DAI	(7.7)	7.7	(7.8)	7.8	7.7			23.2	23.2 1

R2 Bronze Medal Match 2 Tatami 2 15:00(2023-03-03)

Competitors	Kata	1	2	3	4	5	6	7	TOTAL	Extra Total Rank
1 KARIM_WAEL MOHAMED ABDULAZIM (ABDELHAMED CLUB,UAE)	021 GOJUSHIHO SHO	(8.2)	7.7	7.9	(7.4)	7.9			23.5	23.5 1
2 WADEE ABU_WAKIM (SHARJAH SPORTS CLUB,UAE)	021 GOJUSHIHO SHO	(8.0)	8.0	7.5	(7.2)	7.6			23.1	23.1 2

R2 Gold Medal Match Tatami 5 10:35(2023-03-05)

Competitors	Kata	1	2	3	4	5	6	7	TOTAL	Extra Total Rank
1 SAIDU SAMROOD (MARTIAL ARTS KARATE KIDS,UAE)	008 CHATANYARA KUSHANKU	7.4	(7.8)	7.4	(7.0)	7.5	7.1	7.6	37.0	37.0 2
2 LARIN IVAN (TATSUJIN KARATE SCHOOL RUS,RUS)	092 SUPARINPEI	7.8	7.9	(8.0)	(7.4)	7.4	7.5	8.0	38.6	38.6 1

Results

1	LARIN IVAN		RUSSIAN FEDERATION
2	SAIDU SAMROOD		UNITED ARAB EMIRATES
3	T R VISHNU		UNITED ARAB EMIRATES
3	KARIM WAEL MOHAMED ABDULAZIM		UNITED ARAB EMIRATES
5	THARINDU DIMANTHA		UNITED ARAB EMIRATES
5	WADEE ABU WAKIM		UNITED ARAB EMIRATES
7	GUPTA ANIKET		INDIA
7	K T MUZAMMIL		UNITED ARAB EMIRATES
9	HAMZA WALEED		UNITED ARAB EMIRATES
9	HUSAIN MEQDAD		KUWAIT



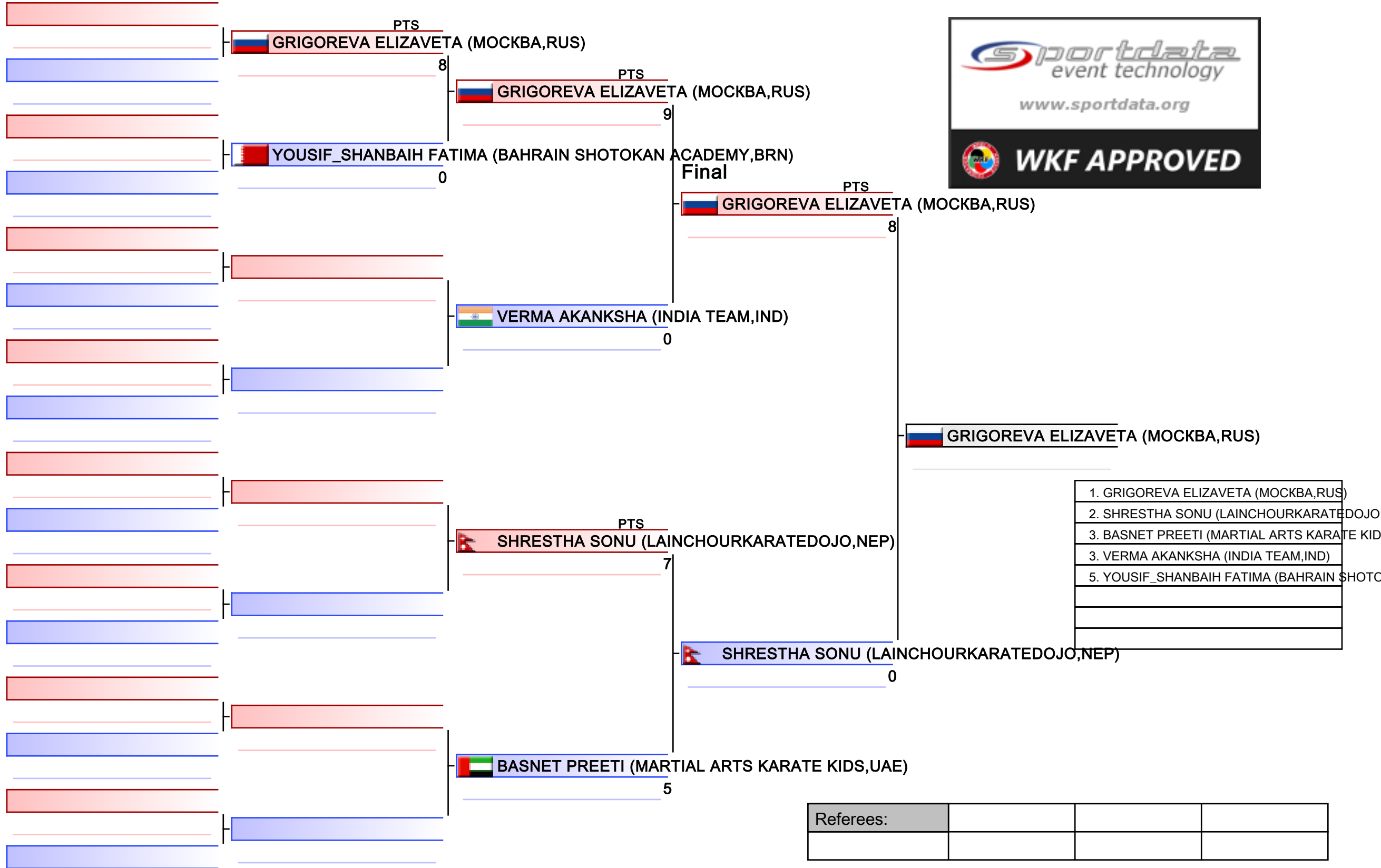

SENIOR KUMITE FEMALE -50 KG
EMIRATES SPORTS KARATE OPEN

2023-03-03 Tatami 1 16:15 Pool 1

(c)sportdata GmbH & Co KG 2000-2023 (2023-03-05 14:28) v 10.0.0 build 1 (2023-01-21) License: UAE Karate Federation (expire 2023-07-31)

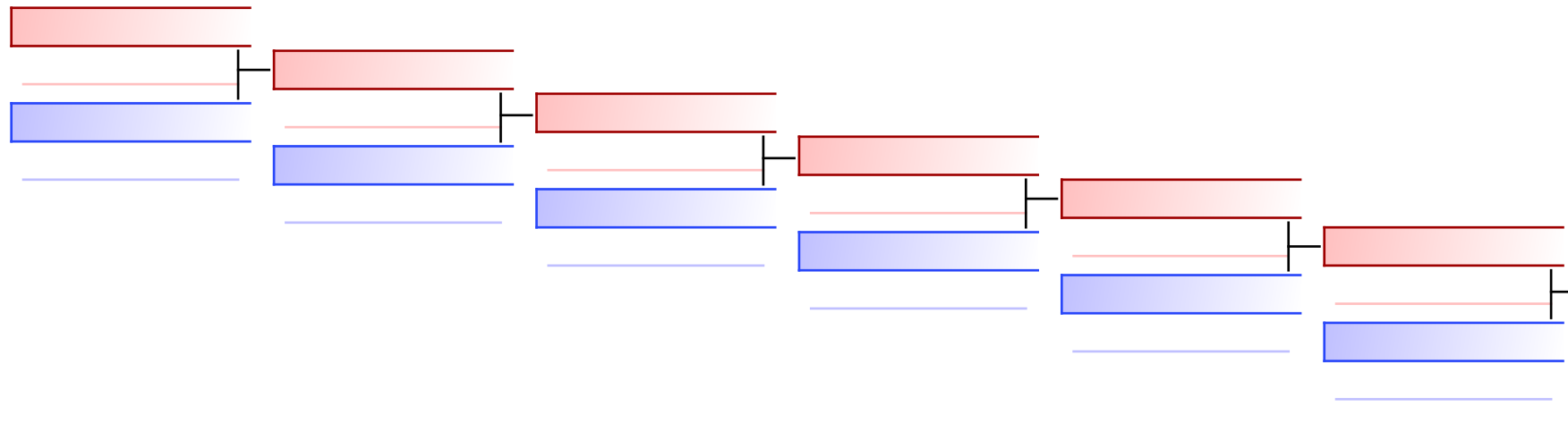

YOUSIF_SHANBAIH FATIMA (BAHRAIN SHOTOKAN)
 PTS 1
VERMA AKANKSHA (INDIA TEAM,IND)
 10

REPECHAGE: (1)

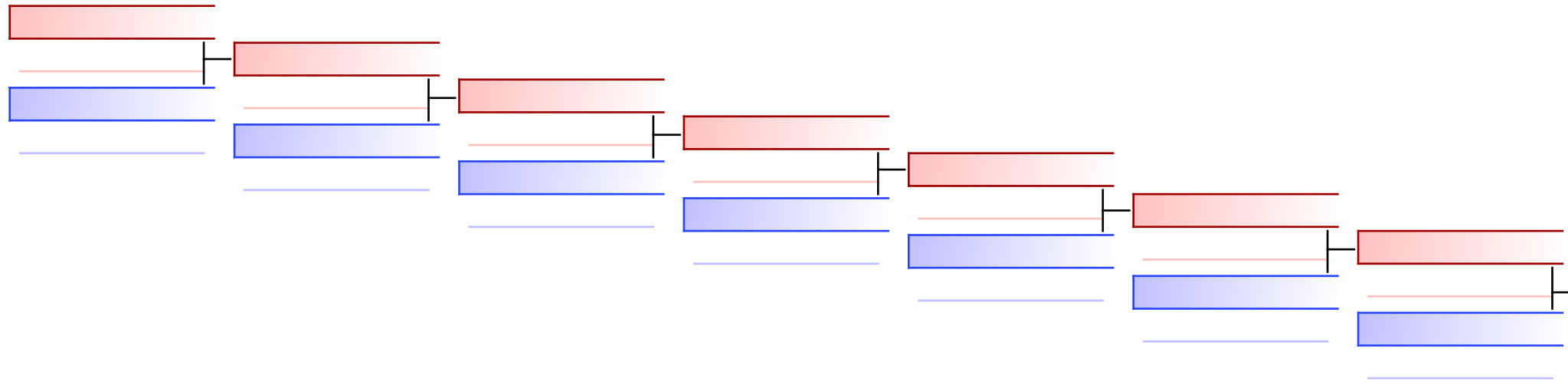

BASNET PREETI (MARTIAL ARTS)

Referees:							
-----------	--	--	--	--	--	--	--

 OZODA NURIDINOVA (САНКТ-ПЕТЕРБУРГ, RUS)

4  OZODA NURIDINOVA (САНКТ-ПЕТЕРБУРГ, RUS)

 ISMAIL ALYAZYA (SHARJAH WOMEN SPORTS CLUB, UAE)

0  CHERNYSHEVA ANNA (САМАРСКАЯ ОБЛАСТЬ, RUS)

5  CHERNYSHEVA ANNA (САМАРСКАЯ ОБЛАСТЬ, RUS)

Final PTS  CHERNYSHEVA ANNA (САМАРСКАЯ ОБЛАСТЬ, RUS)

8  MECHERYAKOVA MARGARITA (ПЕНЗЕНСКАЯ ОБЛАСТЬ, RUS)

0  MECHERYAKOVA MARGARITA (ПЕНЗЕНСКАЯ ОБЛАСТЬ, RUS)

 CHERNYSHEVA ANNA (САМАРСКАЯ ОБЛАСТЬ, RUS)

0  PEREVOZCHIKOVA ANNA (ПЕРМСКИЙ КРАЙ, RUS)

8  PEREVOZCHIKOVA ANNA (ПЕРМСКИЙ КРАЙ, RUS)

3  PEREVOZCHIKOVA ANNA (ПЕРМСКИЙ КРАЙ, RUS)

2  SHARYKHINA IRINA (НАЦИОНАЛЬНАЯ КОМАНДА BLR, BLR)

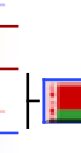
9  SHARYKHINA IRINA (НАЦИОНАЛЬНАЯ КОМАНДА BLR, BLR)



- | |
|---|
| 1. CHERNYSHEVA ANNA (САМАРСКАЯ ОБЛАСТЬ, RUS) |
| 2. PEREVOZCHIKOVA ANNA (ПЕРМСКИЙ КРАЙ, RUS) |
| 3. OZODA NURIDINOVA (САНКТ-ПЕТЕРБУРГ, RUS) |
| 3. SHARYKHINA IRINA (НАЦИОНАЛЬНАЯ КОМАНДА BLR, BLR) |
| 5. MECHERYAKOVA MARGARITA (ПЕНЗЕНСКАЯ ОБЛАСТЬ, RUS) |
| 5. WAIBA SUSMITA (LAINCHOURKARATEDOJO, NEP) |
| |
| |

Referees:			

SENIOR KUMITE FEMALE -55 KG
EMIRATES SPORTS KARATE OPEN

2023-03-03 Tatami 2 16:35 Pool 1

(c)sportdata GmbH & Co KG 2000-2023 (2023-03-05 14:28) v 10.0.0 build 1 (2023-01-21) License: UAE Karate Federation (expire 2023-07-31)

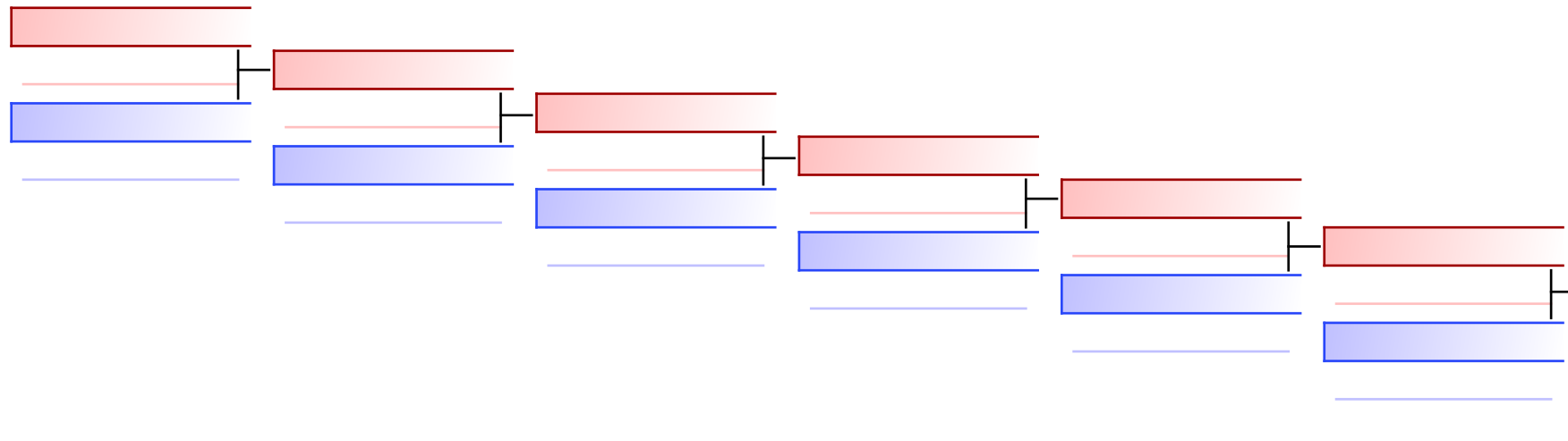

RU OZODA NURIDINOVA (САНКТ-ПЕТЕРБУРГ, RUS) 6
RU OZODA NURIDINOVA (САНКТ-ПЕТЕРБУРГ, RUS)
RU MECHERYAKOVA MARGARITA (ПЕНЗЕНСКАЯ ОБЛ.) 5

REPECHAGE: (1)

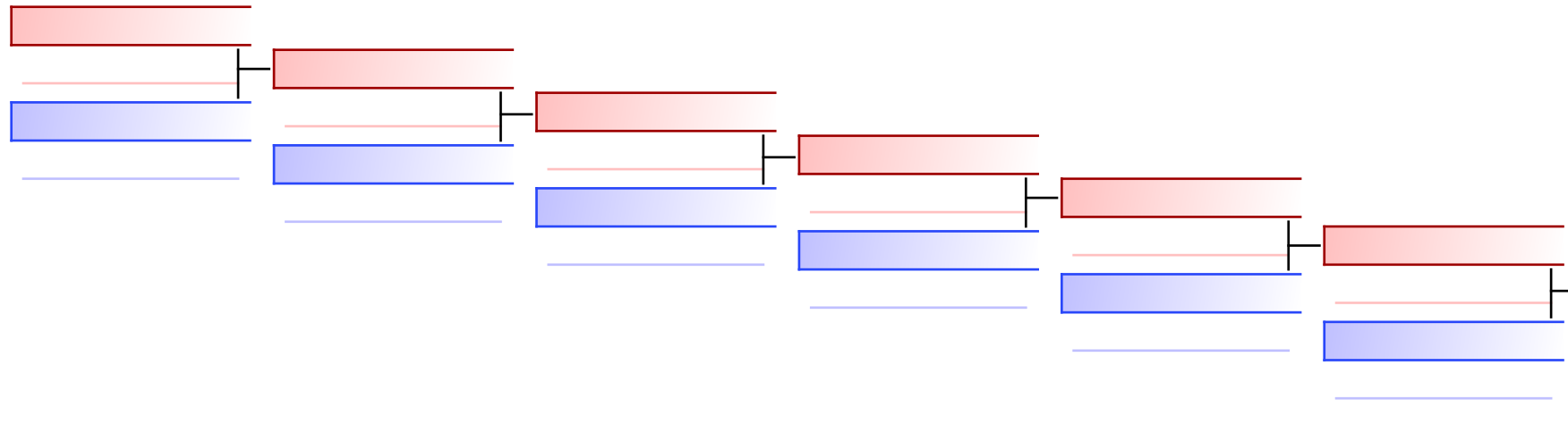

NP WAIBA SUSMITA (LAINCHOURKARATEDOJO, NEP) 2
RU SHARYKHINA IRINA (НАЦИОНАЛЬНАЯ КОМАНДА БОРЬБЫ) 7

Referees:							
-----------	--	--	--	--	--	--	--

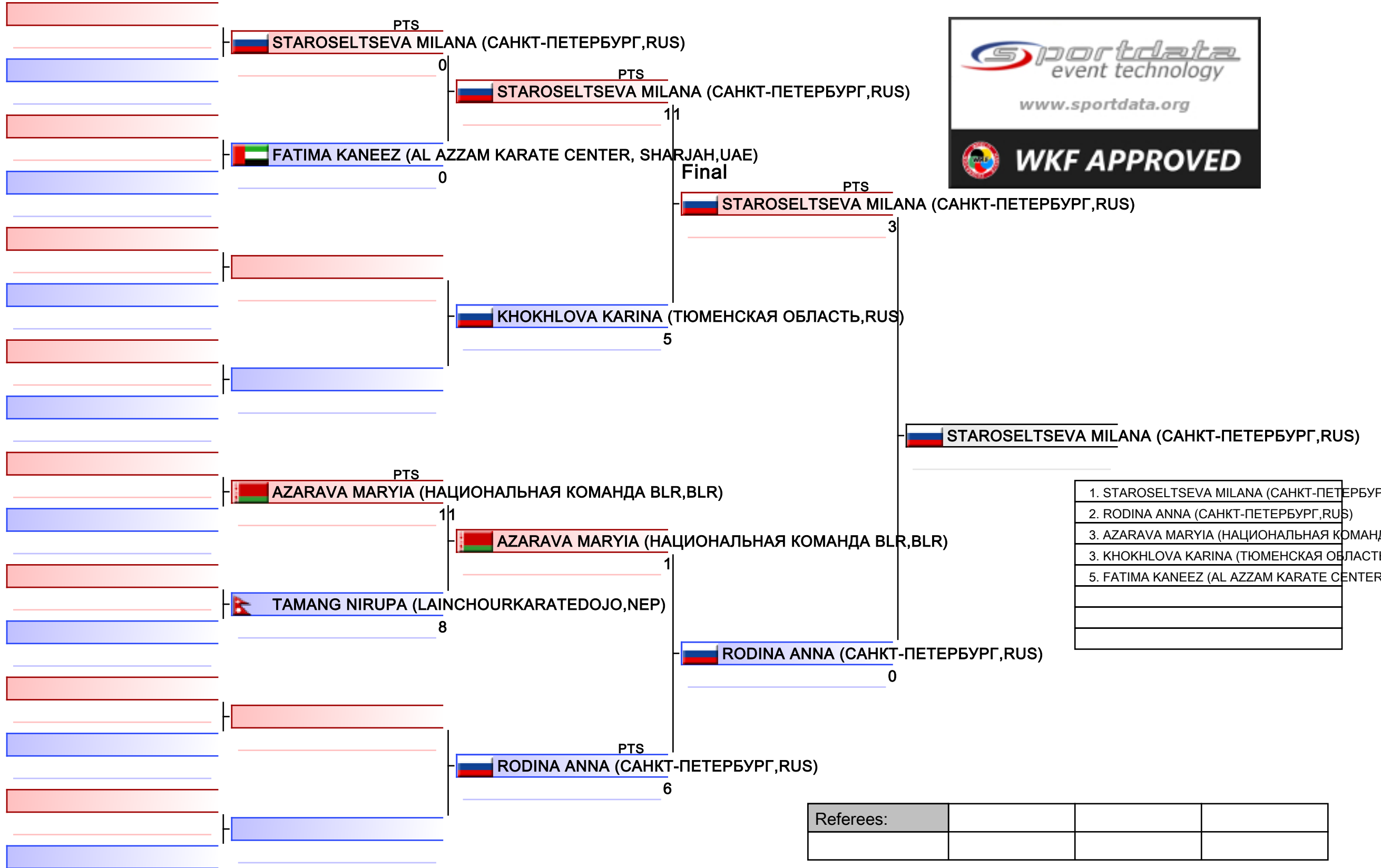

SENIOR KUMITE FEMALE -61 KG
EMIRATES SPORTS KARATE OPEN

2023-03-03 3 16:25 Tatami Pool
1

(c)sportdata GmbH & Co KG 2000-2023 (2023-03-05 14:28) v 10.0.0 build 1 (2023-01-21) License: UAE Karate Federation (expire 2023-07-31)

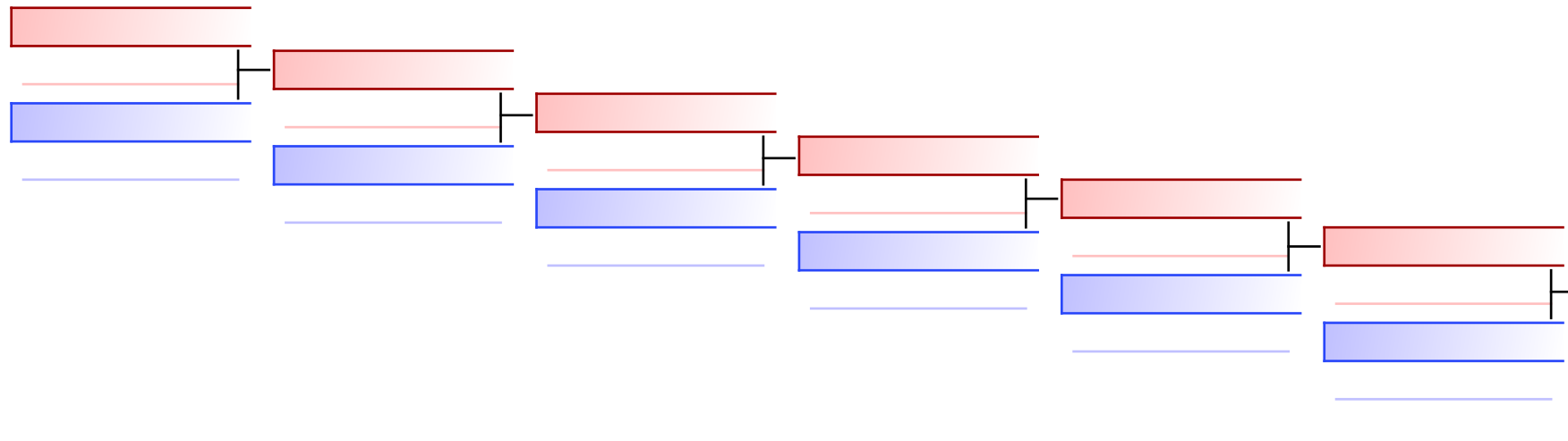

FATIMA KANEEZ (AL AZZAM KARATE CENTER, SHA)
KI 0
 KHOKHLOVA KARINA (ТЮМЕНС
KHOKHLOVA KARINA (ТЮМЕНСКАЯ ОБЛАСТЬ, RUSSIA)
0

REPECHAGE: (1)

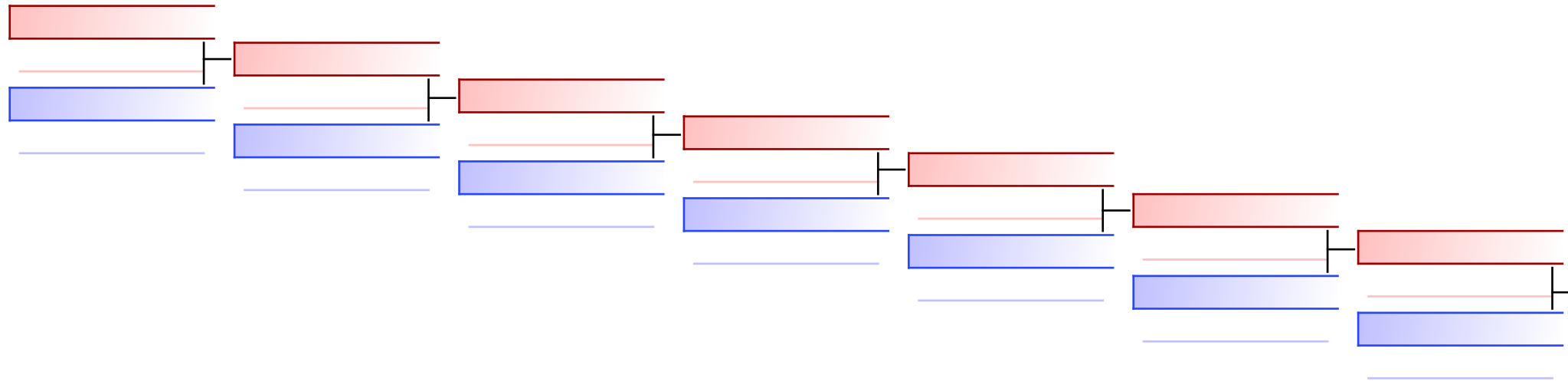

AZARAVA MARYIA (НАЦИОНАЛ

Referees:							
-----------	--	--	--	--	--	--	--

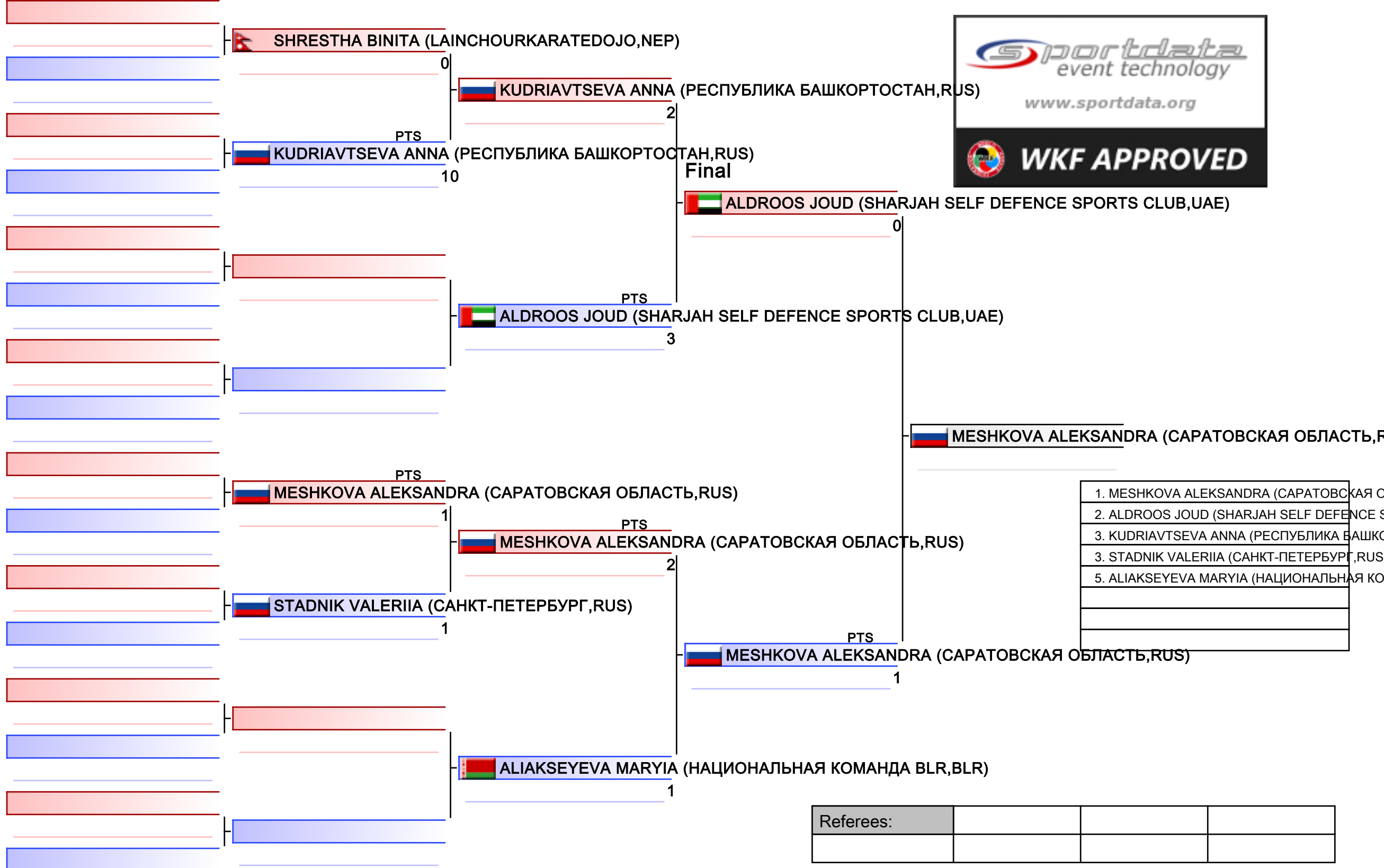

Referees:			

SENIOR KUMITE FEMALE -68 KG

EMIRATES SPORTS KARATE OPEN

2023-03-03

Tatami
1 16:45

Pool
1

(c)sportdata GmbH & Co KG 2000-2023 (2023-03-05 14:28) v 10.0.0 build 1 (2023-01-21) License: UAE Karate Federation (expire 2023-07-31)

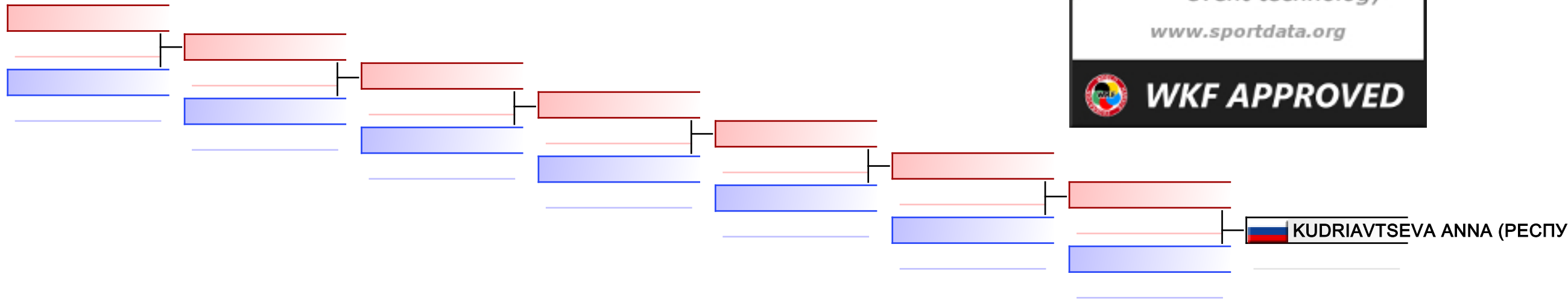

REPECHAGE: (1)

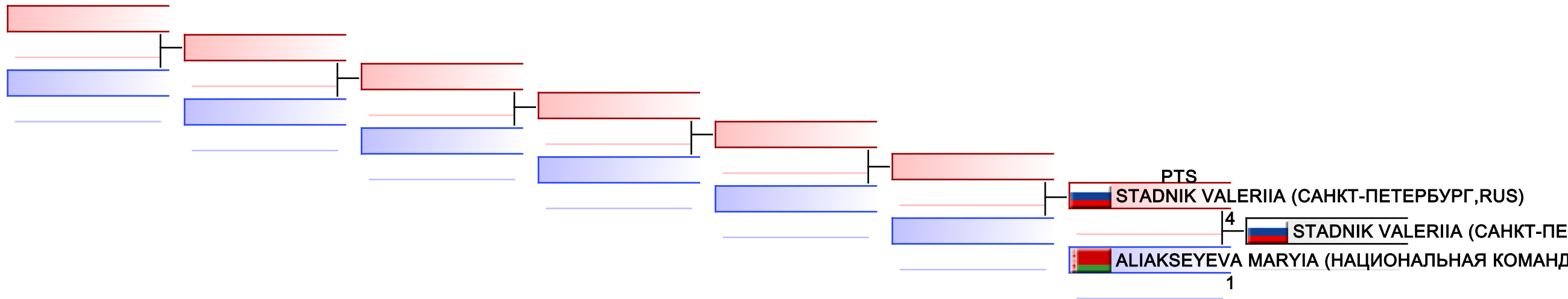

Referees:							
-----------	--	--	--	--	--	--	--

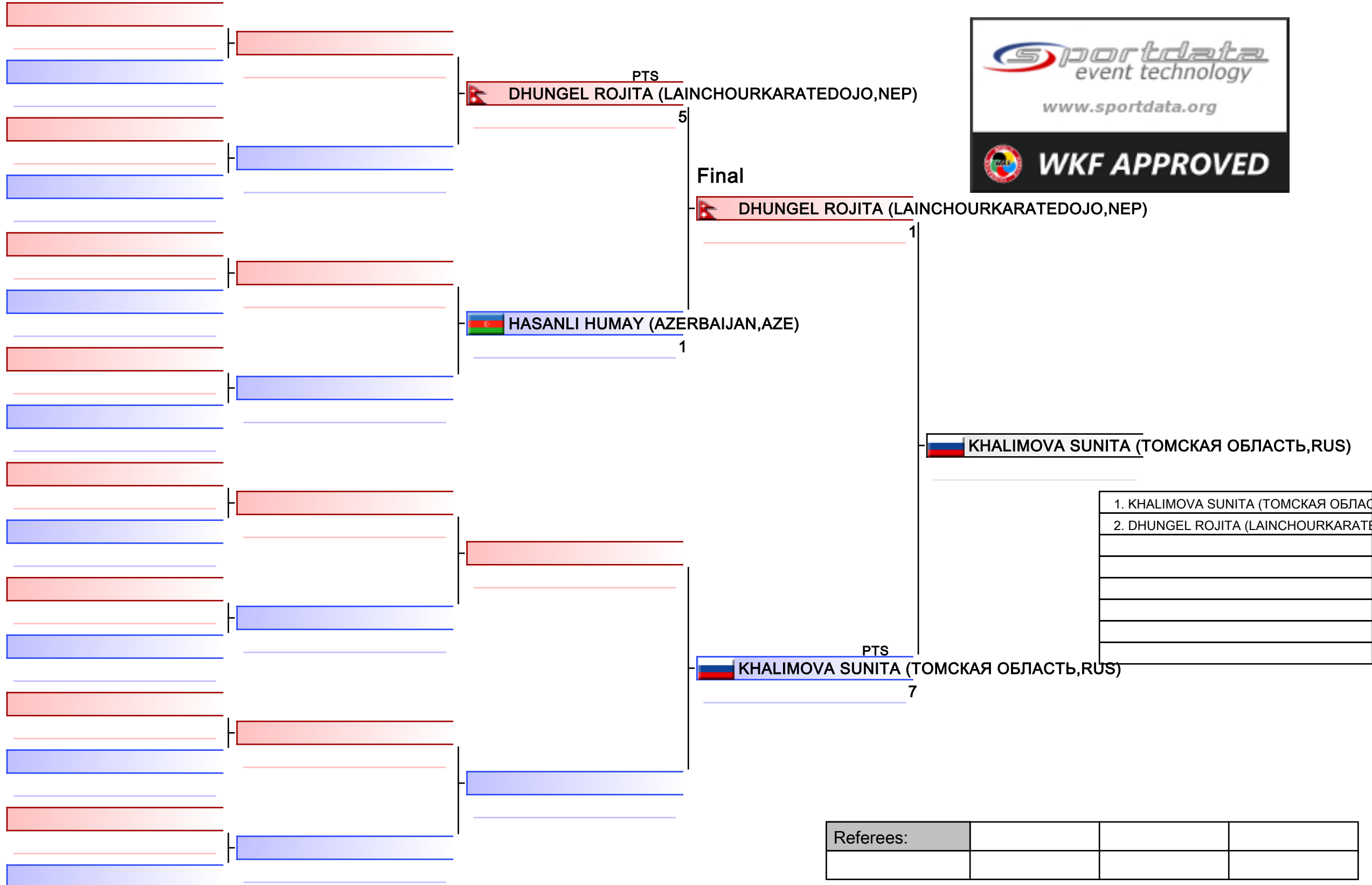

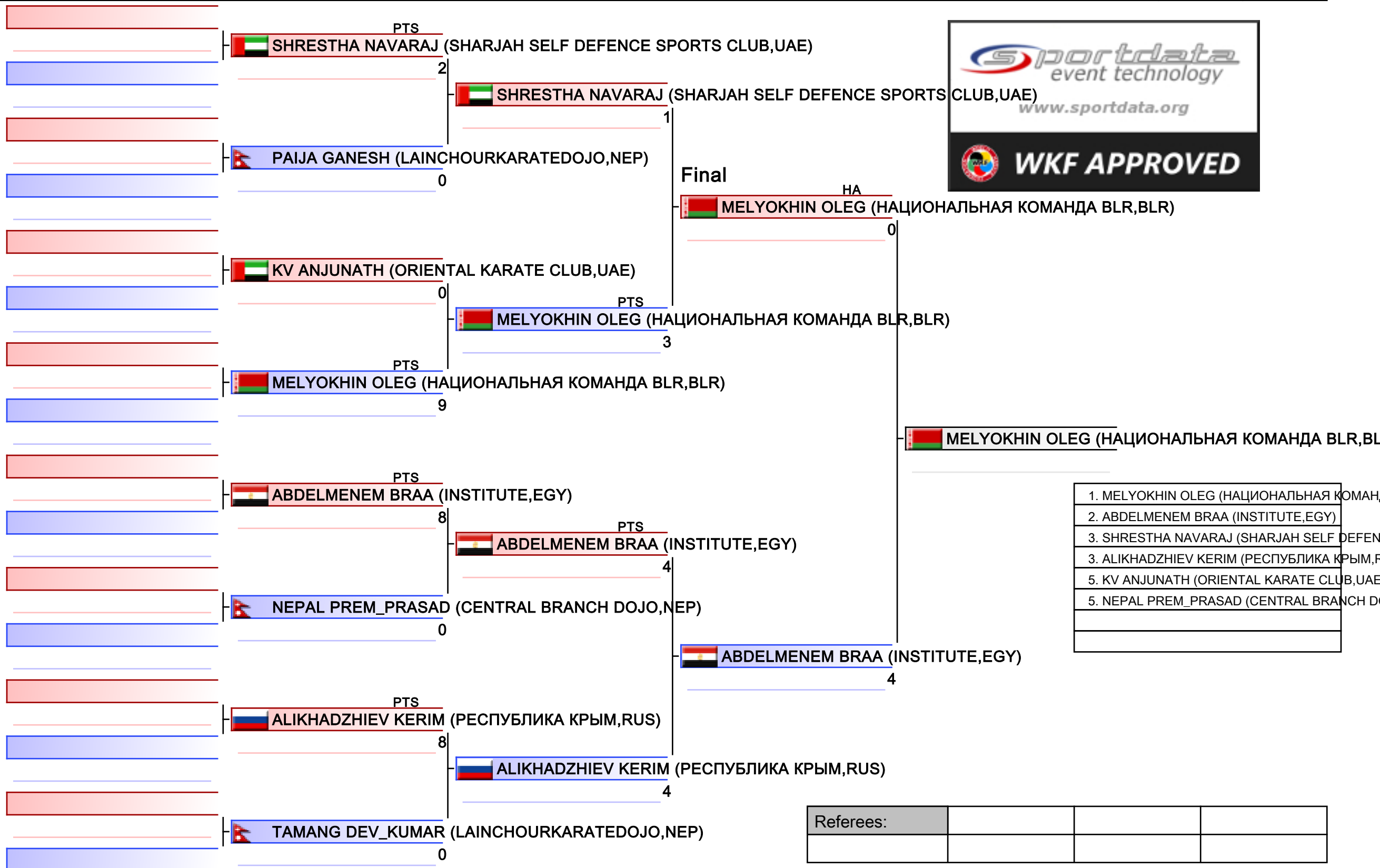

SENIOR KUMITE MALE -60 KG
EMIRATES SPORTS KARATE OPEN

2023-03-03 3 17:05 Tatami
 1 Pool

(c)sportdata GmbH & Co KG 2000-2023 (2023-03-05 14:28) v 10.0.0 build 1 (2023-01-21) License: UAE Karate Federation (expire 2023-07-31)

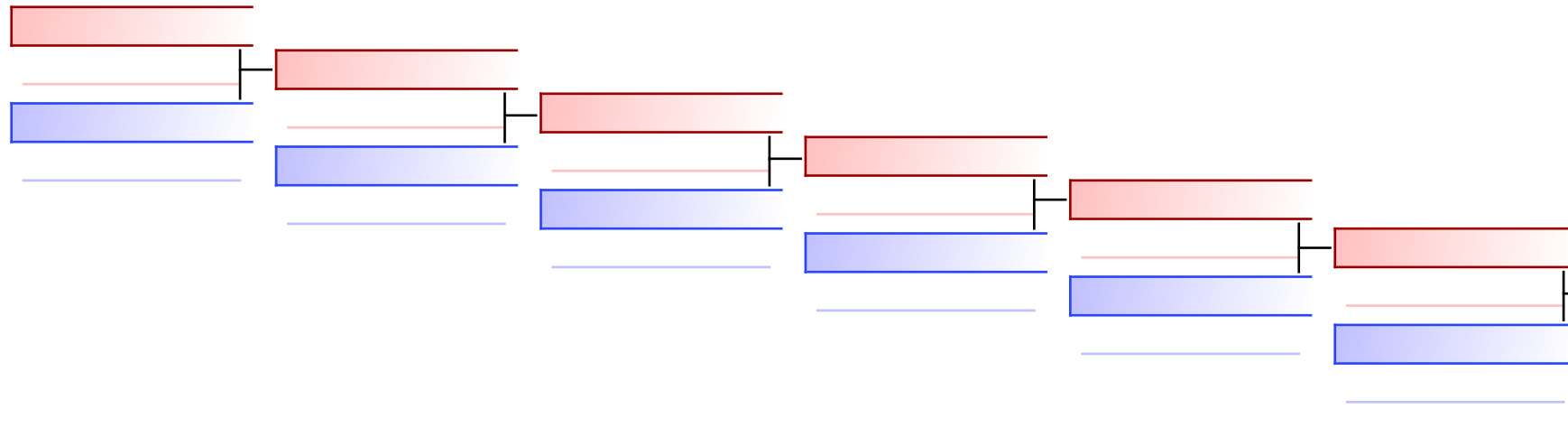

KV ANJUNATH (ORIENTAL KARATE CLUB,UAE)
 PTS 0
 SHRESTHA NAVARAJ (SHARJAH SELF DEFENCE S
 PTS 8

REPECHAGE: (1)

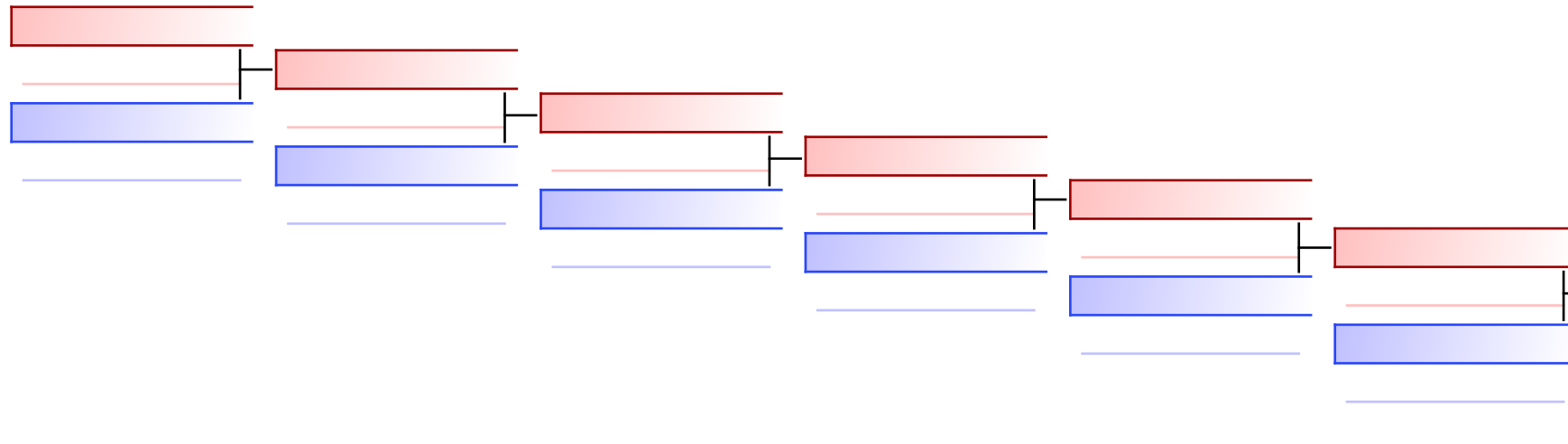

NEPAL PREM_PRASAD (CENTRAL BRANCH DOJO,N
 PTS 0
 ALIKHADZHIEV KERIM (РЕСПУБЛИКА КРЫМ,RUS)
 PTS 8

Referees:							
-----------	--	--	--	--	--	--	--

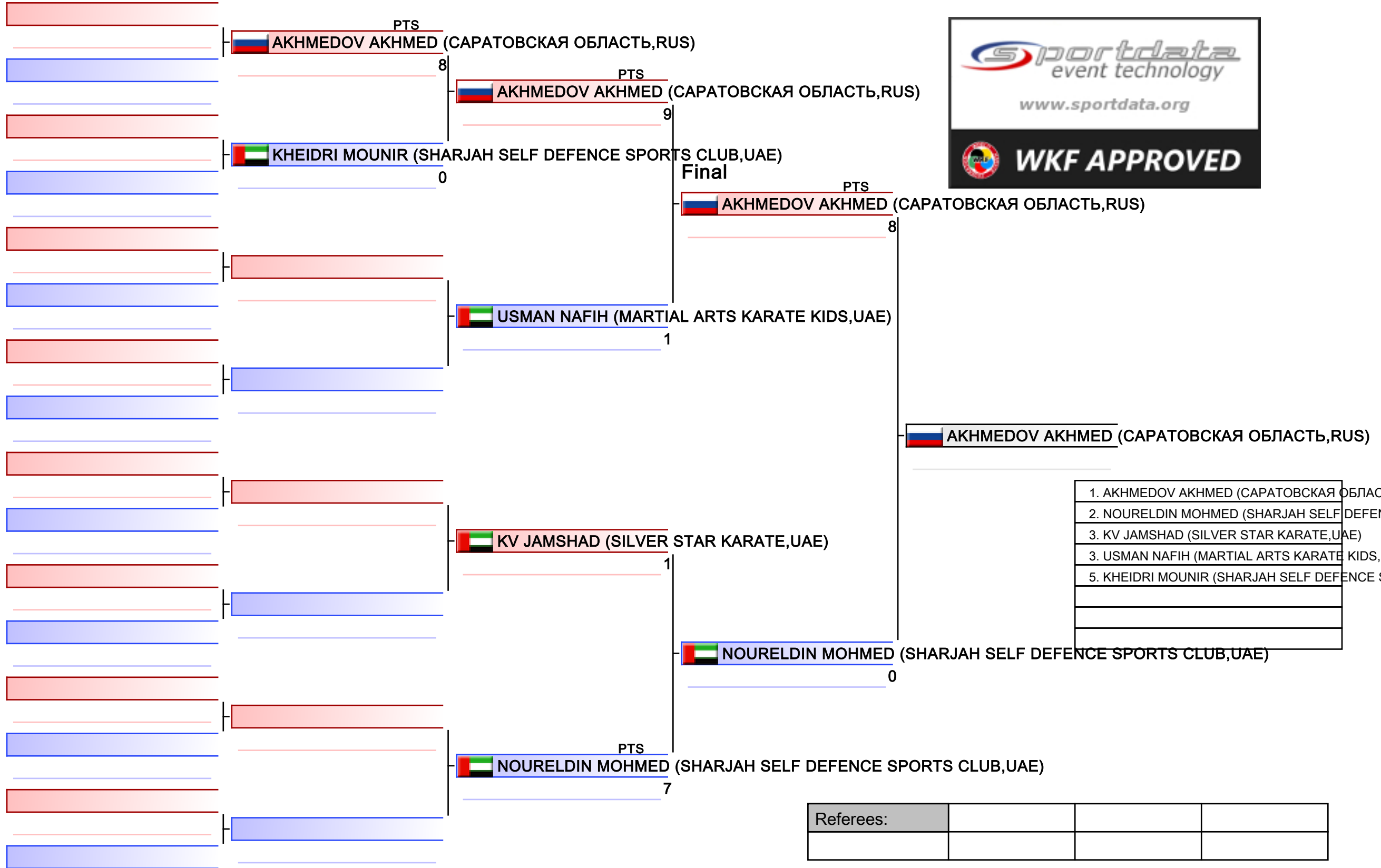

SENIOR KUMITE MALE -67 KG
EMIRATES SPORTS KARATE OPEN

2023-03-03

Tatami
4 16:50

Pool
1

(c)sportdata GmbH & Co KG 2000-2023 (2023-03-05 14:28) v 10.0.0 build 1 (2023-01-21) License: UAE Karate Federation (expire 2023-07-31)

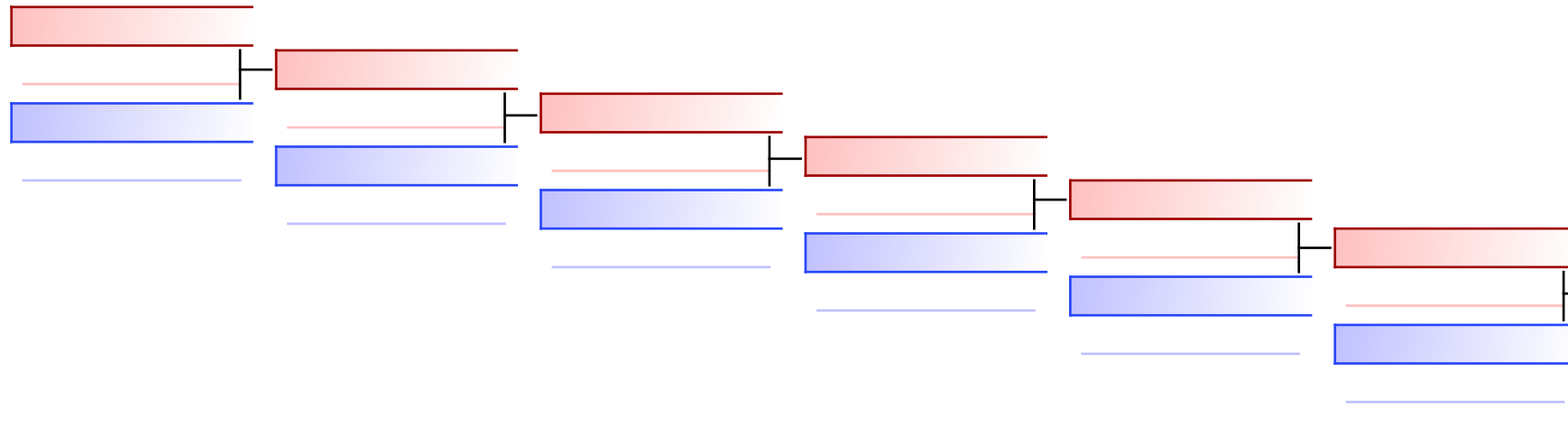

KHEIDRI MOUNIR (SHARJAH SELF DEFENCE SPORTS CLUB)
PTS | **USMAN NAFIH (MARTIAL ARTS KARATE KIDS, UAE)**
1 | 1

REPECHAGE: (1)

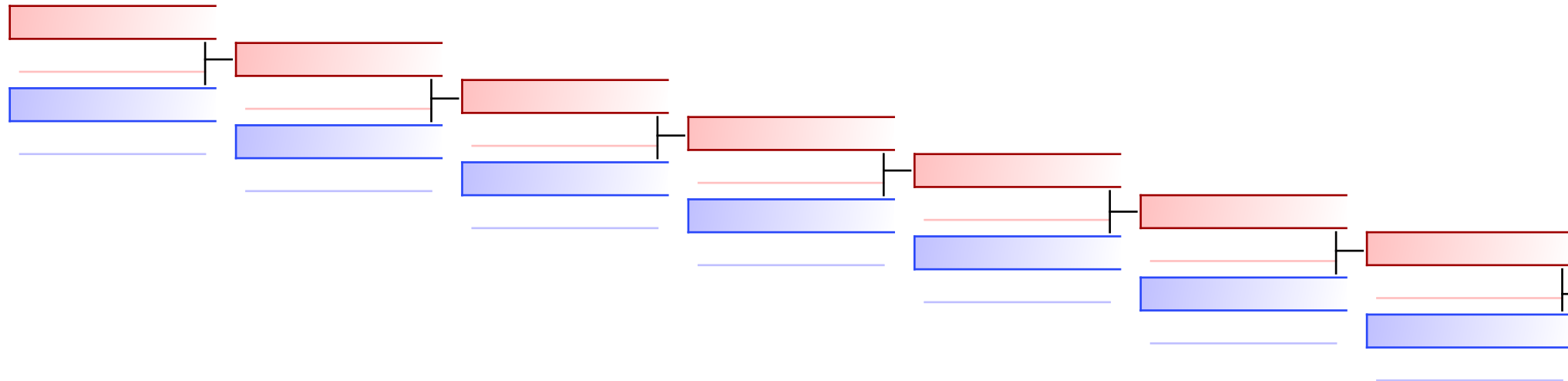

KV JAMSHAD (SILVER STAR KARATE CLUB)

Referees:							
-----------	--	--	--	--	--	--	--

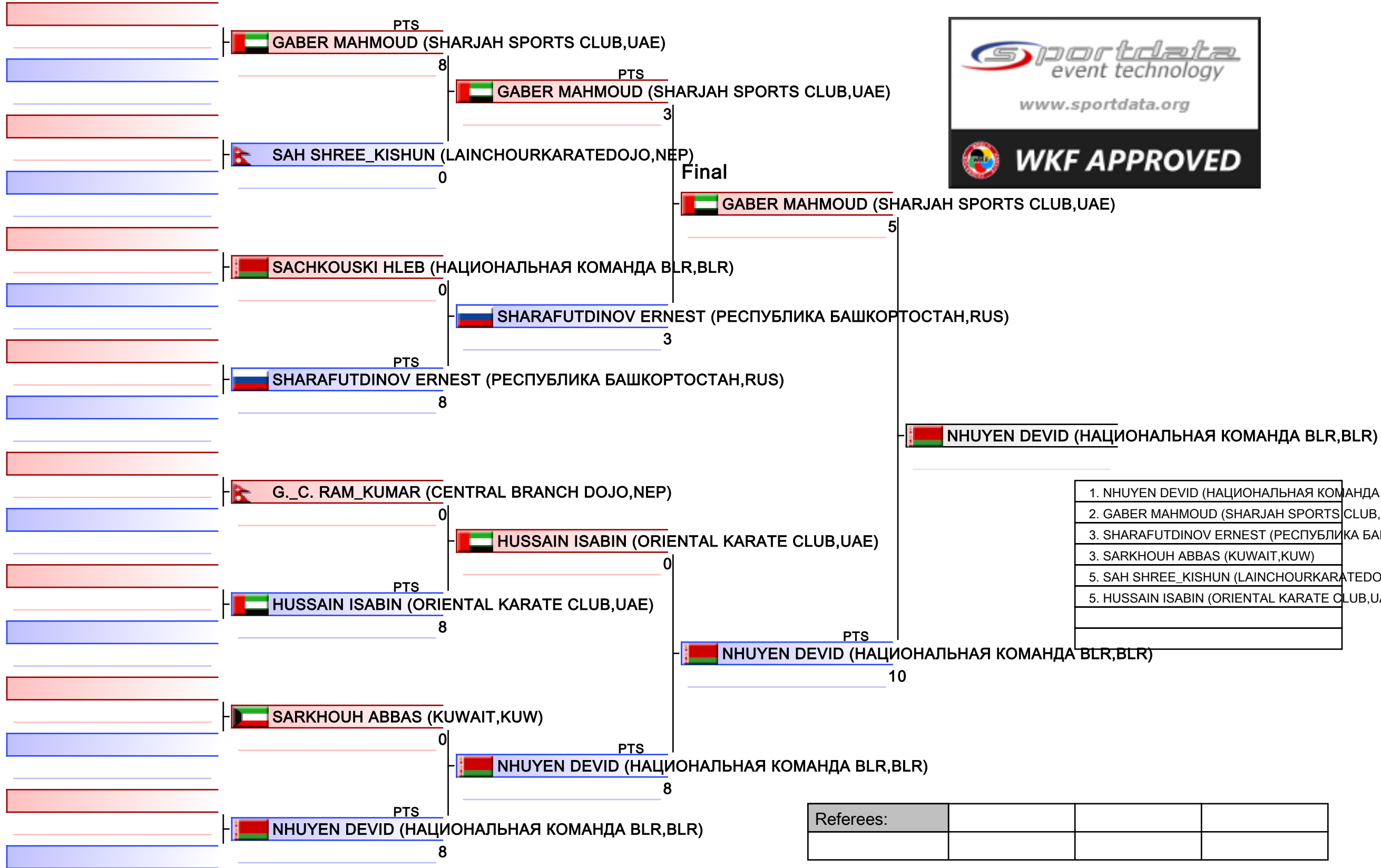

1. NHUYEN DEVID (НАЦИОНАЛЬНАЯ КОМАНДА BLR,BLR)
2. GABER MAHMOUD (SHARJAH SPORTS CLUB,UAE)
3. SHARAFUTDINOV ERNEST (РЕСПУБЛИКА БАШКОРТОСТАН,RUS)
3. SARKHOUH ABBAS (KUWAIT,KUW)
5. SAH SHREE_KISHUN (LAINCHOURKARATEDOJO,NEP)
5. HUSSAIN ISABIN (ORIENTAL KARATE CLUB,UAE)

Referees:			

SENIOR KUMITE MALE -75 KG
EMIRATES SPORTS KARATE OPEN

2023-03-03 Tatami 1 17:25 Pool 1

(c)sportdata GmbH & Co KG 2000-2023 (2023-03-05 14:28) v 10.0.0 build 1 (2023-01-21) License: UAE Karate Federation (expire 2023-07-31)

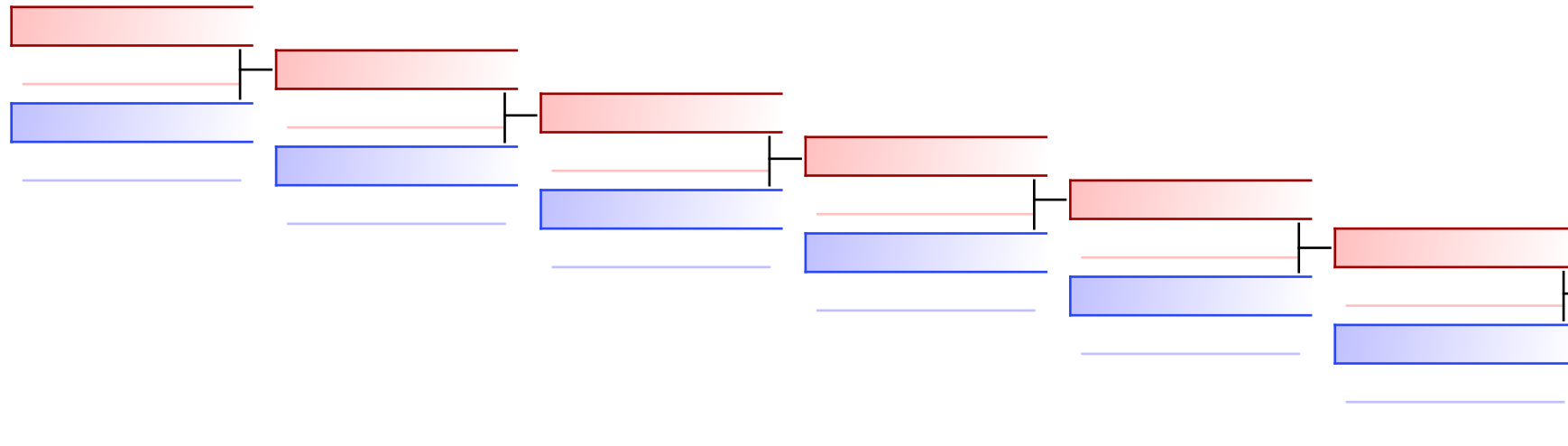

SAH SHREE_KISHUN (LAINCHOURKARATEDOJO,N
 PTS 0
 SHARAFUTDINOV ERNEST (PE
 SHARAFUTDINOV ERNEST (РЕСПУБЛИКА БАШКОР
 9

REPECHAGE: (1)

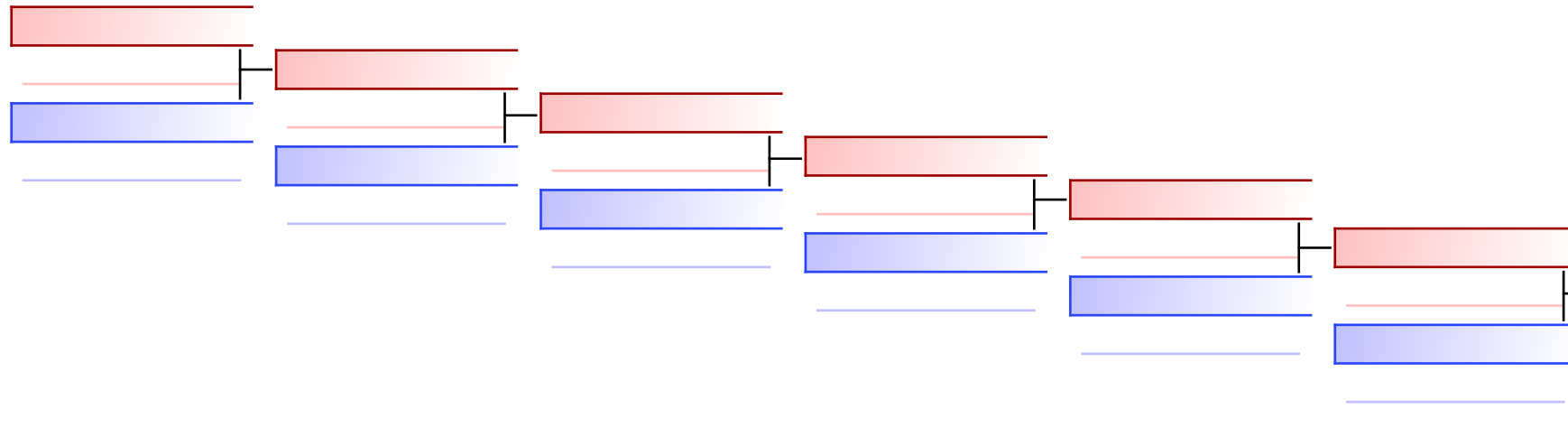

KI
 SARKHOUH ABBAS (KUWAIT,KUW)
 3
 SARKHOUH ABBAS (KUWAIT,K
 HUSSAIN ISABIN (ORIENTAL KARATE CLUB,UAE)
 1

Referees:							
-----------	--	--	--	--	--	--	--

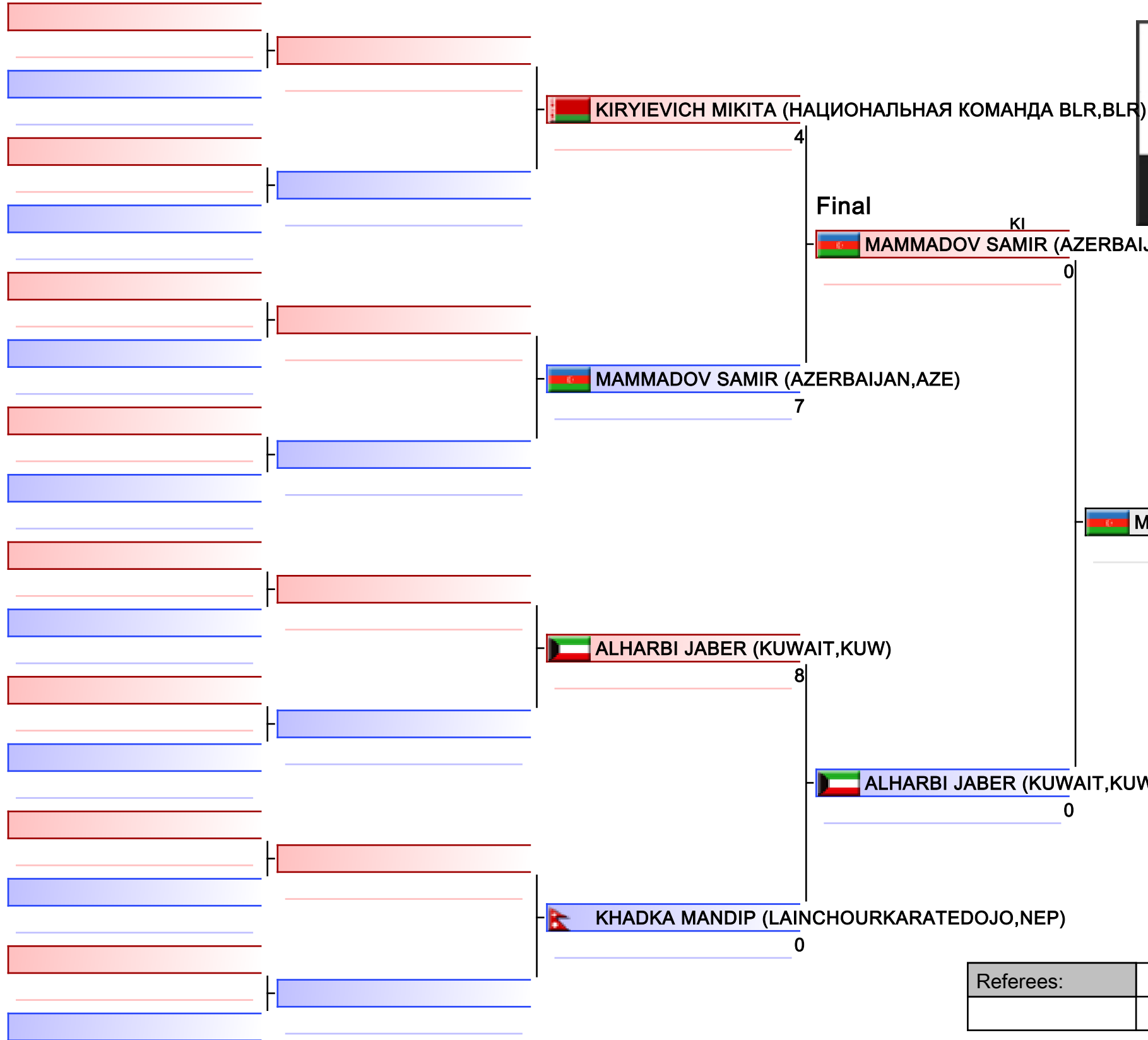

MAMMADOV SAMIR (AZERBAIJAN,AZE)

1. MAMMADOV SAMIR (AZERBAIJAN,AZE)
2. ALHARBI JABER (KUWAIT,KUW)

Referees:			

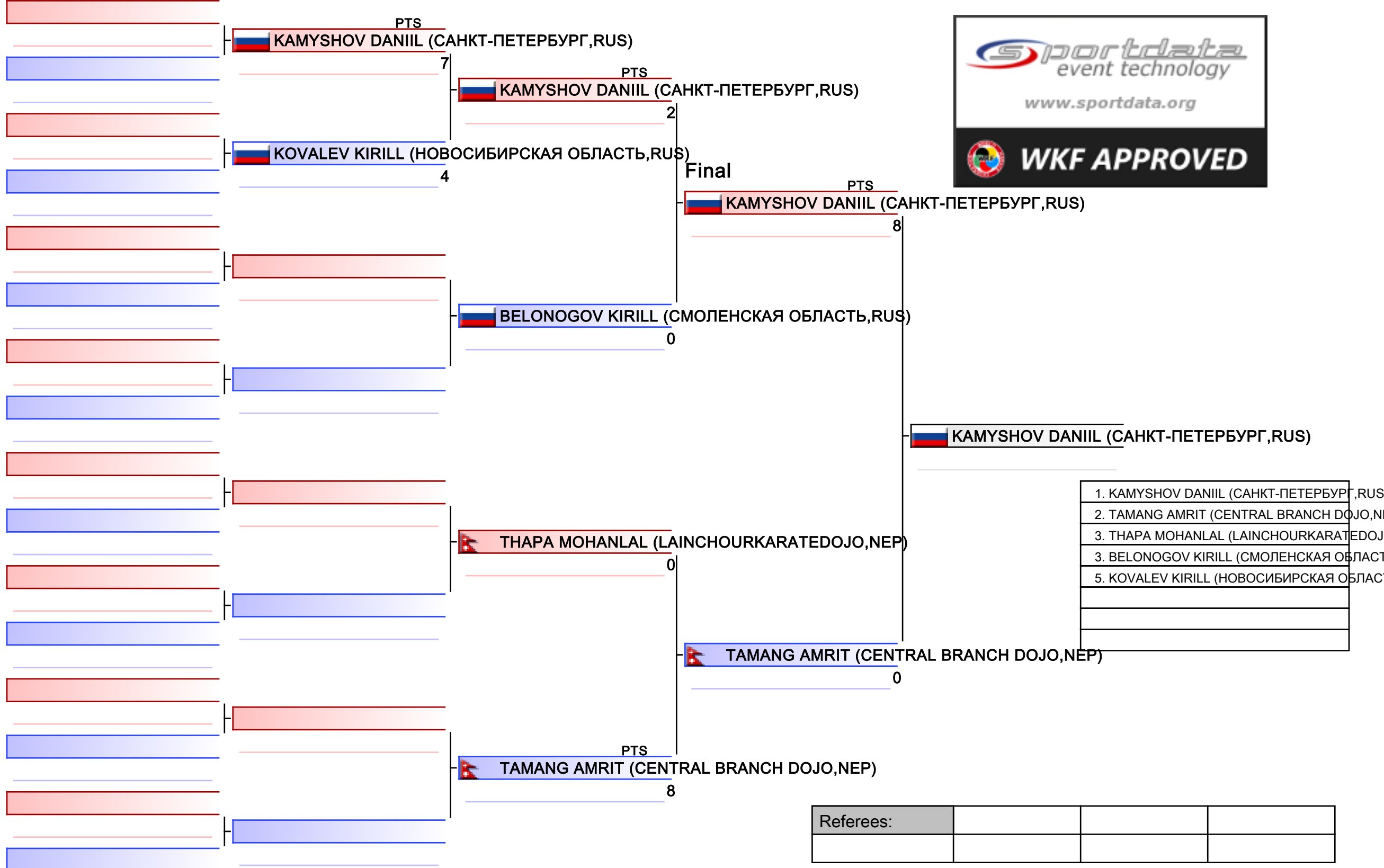

SENIOR KUMITE MALE 84+ KG
EMIRATES SPORTS KARATE OPEN

2023-03-03 Tatami 4 17:15 Pool 1

(c)sportdata GmbH & Co KG 2000-2023 (2023-03-05 14:28) v 10.0.0 build 1 (2023-01-21) License: UAE Karate Federation (expire 2023-07-31)

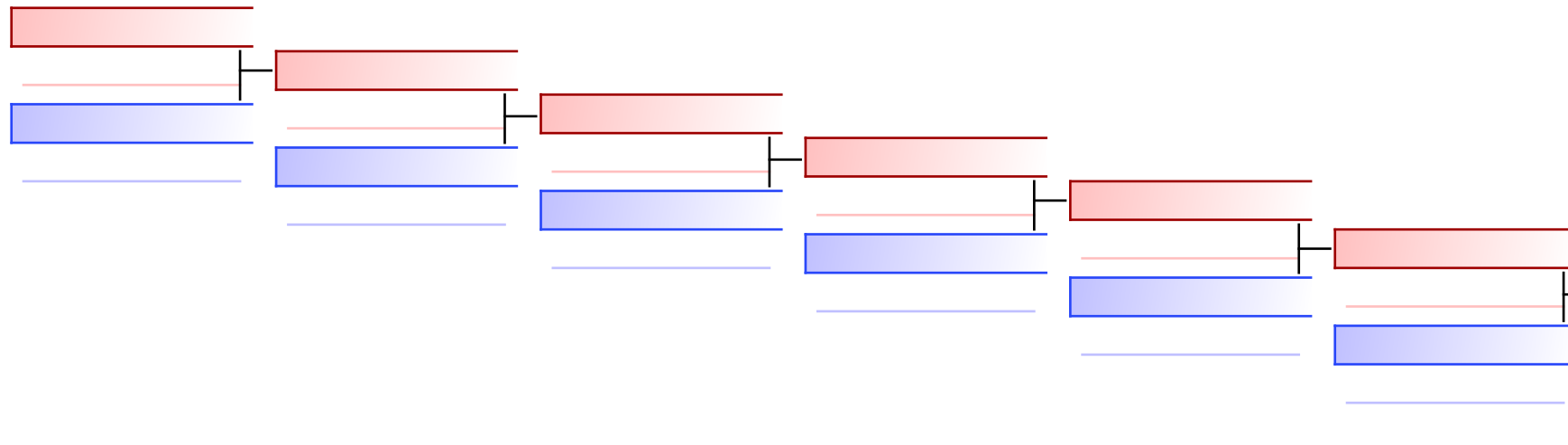

KOVALEV KIRILL (НОВОСИБИРСКАЯ ОБЛАСТЬ, RU)
 HT **BELONOGOV KIRILL (СМОЛЕНСКАЯ ОБЛАСТЬ, RU)**
 0
 0

REPECHAGE: (1)

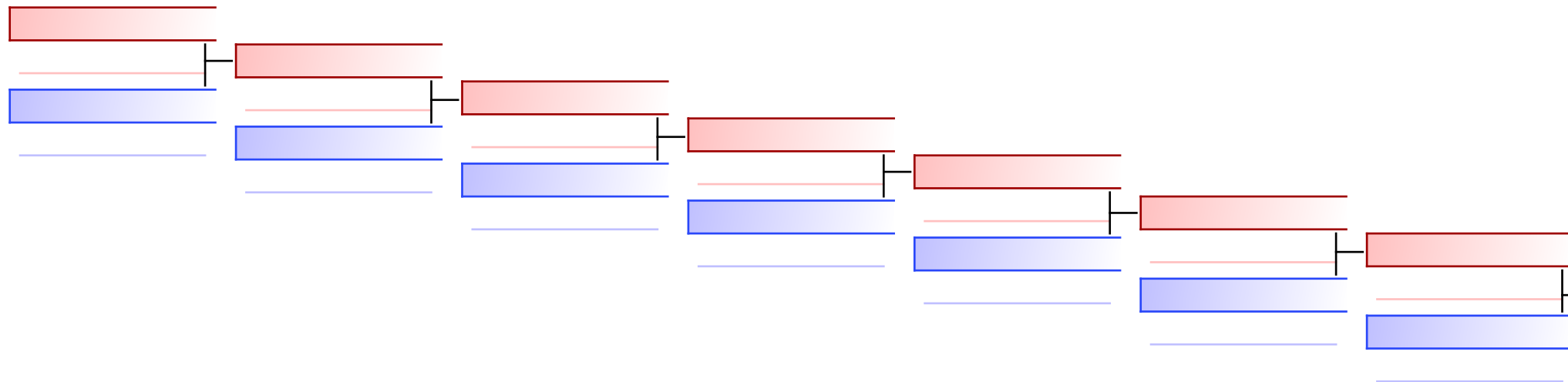

THAPA MOHANLAL (LAINCHOU)

Referees:							
-----------	--	--	--	--	--	--	--



EMIRATES SPORTS KARATE OPEN - 2023-03-03

U14 Kata Female



R1 G1/2 (9) Tatami 3 09:50(2023-03-04)

Competitors	Kata	1	2	3	4	5	6	7	TOTAL	Extra Total Rank
1 SHINEDAS SERAH (MARTIAL ARTS KARATE KIDS,UAE)		7.4	6.8	(7.6)	(6.2)	6.7			20.9	20.9 7
2 AHMED FARIDA (MENTOR,UAE)		(7.5)	6.7	7.0	(6.0)	6.8			20.5	20.5 8
3 HASSAN HAIQA (GULF STAR KARATE,UAE)		(7.7)	7.2	7.2	(5.8)	6.9			21.3	21.3 5
4 BAYANI CHANTAL_YURI (BUSHIDO MARTIAL ARTS & FITNESS - SKIF,PHI)		(7.6)	7.1	7.4	(5.7)	7.0			21.5	21.5 4
5 HATAM HUDA (SHABAB ALAHLI CLUB,UAE)		(7.8)	6.6	7.7	(6.5)	6.6			20.9	20.9 6
6 JILLIAN MAYZEE (AL AZZAM KARATE CENTER, SHARJAH,UAE)		6.7	6.4	(6.8)	(5.6)	6.2			19.3	19.3 9
7 RAO VAANYA (INDIA TEAM,IND)		8.1	(7.3)	7.3	(8.3)	7.3			22.7	22.7 3
8 ABDURAIMOVA MUSHTARIY (UZBEKISTAN,UZB)		(8.0)	7.7	(7.4)	8.0	7.5			23.2	23.2 2
9 TAREQ LEMAR (TEAM,JOR)		8.2	8.3	(7.0)	(8.4)	7.6			24.1	24.1 1

R1 G2/2 (8) Tatami 4 09:45(2023-03-04)

Competitors	Kata	1	2	3	4	5	6	7	TOTAL	Extra Total Rank
1 PIRIAZEVA VIKTORIIA (TATSUJIN KARATE SCHOOL RUS,RUS)	092 SUPARINPEI	(7.6)	7.6	7.6	8.4	(9.4)			23.6	23.6 1
2 ALZGHOUL RASEEL (SHARJAH SELF DEFENCE SPORTS CLUB,UAE)	006 BASSAI DAI	7.3	(6.8)	7.3	7.6	(8.0)			22.2	22.2 3
3 MATAR JANA (SHJSDSC,UAE)	006 BASSAI DAI	(6.9)	7.0	7.1	(7.5)	7.1			21.2	21.2 7
4 LOH LAYLA (AJSPOORTSCLUB,UAE)	012 ENPI	(7.6)	(6.8)	6.9	7.5	7.2			21.6	21.6 5
5 RAJESH RUDHRA (DEV,UAE)	028 HEIAN YONDAN	(6.8)	7.3	6.9	(7.8)	6.9			21.1	21.1 8
6 ZAMORA STELLA_MARIS (SHITOKAI MURAYAMA UAE,UAE)	053 MATSUMURA ROHAI	(7.1)	(7.4)	7.1	7.4	7.3			21.8	21.8 4
7 SALAH DENA (MENTOR,UAE)	006 BASSAI DAI	7.7	(6.9)	7.4	(8.2)	8.1			23.2	23.2 2
8 PARECATTIL ROSE_SAPARYA (MARTIAL ARTS KARATE KIDS,UAE)	JION	7.4	7.1	(6.8)	(7.5)	6.9			21.4	21.4 6

R2-G1 Tatami 4 10:10(2023-03-04)

Competitors	Kata	1	2	3	4	5	6	7	TOTAL	Extra Total Rank
1 ABDURAIMOVA MUSHTARIY (UZBEKISTAN,UZB)		(8.4)	7.6	(7.5)	7.5	7.7			22.8	22.8 3
2 RAO VAANYA (INDIA TEAM,IND)		(8.1)	7.8	(7.2)	8.1	7.5			23.4	23.4 1
3 TAREQ LEMAR (TEAM,JOR)		(8.6)	7.7	7.6	7.9	(7.5)			23.2	23.2 2
4 BAYANI CHANTAL_YURI (BUSHIDO MARTIAL ARTS & FITNESS - SKIF,PHI)		(7.9)	7.0	7.1	7.4	(6.8)			21.5	21.5 4

R2-G2 Tatami 3 10:20(2023-03-04)

Competitors	Kata	1	2	3	4	5	6	7	TOTAL	Extra Total Rank
1 SALAH DENA (MENTOR,UAE)	029 HEIAN GODAN	7.3	7.5	(8.9)	7.8	(6.8)			22.6	22.6 3
2 ZAMORA STELLA_MARIS (SHITOKAI MURAYAMA UAE,UAE)	006 BASSAI DAI	(6.9)	7.3	(7.9)	7.5	7.1			21.9	21.9 4
3 ALZGHOUL RASEEL (SHARJAH SELF DEFENCE SPORTS CLUB,UAE)	012 ENPI	(7.2)	7.4	(8.3)	8.0	7.4			22.8	22.8 2
4 PIRIAZEVA VIKTORIIA (TATSUJIN KARATE SCHOOL RUS,RUS)	068 PAPUREN	(7.4)	7.7	(9.1)	8.6	7.6			23.9	23.9 1

R3 Bronze Medal Match 1 Tatami 4 10:35(2023-03-04)

Competitors	Kata	1	2	3	4	5	6	7	TOTAL	Extra Total Rank
1 SALAH DENA (MENTOR,UAE)	012 ENPI	7.1	(6.8)	6.9	(7.8)	7.8			21.8	21.8 2
2 TAREQ LEMAR (TEAM,JOR)	021 GOJUSHIHO SHO	7.9	(7.3)	7.6	(8.4)	8.1			23.6	23.6 1

R3 Bronze Medal Match 2 Tatami 3 10:35(2023-03-04)

Competitors	Kata	1	2	3	4	5	6	7	TOTAL	Extra Total Rank
1 ALZGHOUL RASEEL (SHARJAH SELF DEFENCE SPORTS CLUB,UAE)		7.1	(6.6)	7.1	7.4	(7.7)			21.6	21.6 2
2 ABDURAIMOVA MUSHTARIY (UZBEKISTAN,UZB)		7.3	7.2	7.6	(6.8)	(8.3)			22.1	22.1 1

R3 Gold Medal Match Tatami 4 10:25(2023-03-04)

Competitors	Kata	1	2	3	4	5	6	7	TOTAL	Extra Total Rank
1 PIRIAZEVA VIKTORIIA (TATSUJIN KARATE SCHOOL RUS,RUS)	092 SUPARINPEI	7.8	(7.3)	7.6	(8.2)	7.8			23.2	23.2 2
2 RAO VAANYA (INDIA TEAM,IND)	092 SUPARINPEI	8.0	7.6	(7.4)	(8.4)	8.1			23.7	23.7 1

Results

1	RAO VAANYA		INDIA
---	------------	--	-------





EMIRATES SPORTS KARATE OPEN - 2023-03-03 U14 Kata Female



2	PIRIAZEVA VIKTORIIA		RUSSIAN FEDERATION
3	TAREQ LEMAR		JORDAN
3	ABDURAIMOVA MUSHTARIY		UZBEKISTAN
5	SALAH DENA		UNITED ARAB EMIRATES
5	ALZGHOUL RASEEL		UNITED ARAB EMIRATES
7	BAYANI CHANTAL YURI		PHILIPPINES
7	ZAMORA STELLA MARIS		UNITED ARAB EMIRATES
9	HASSAN HAIQA		UNITED ARAB EMIRATES
9	MATAR JANA		UNITED ARAB EMIRATES
11	HATAM HUDA		UNITED ARAB EMIRATES
11	RAJESH RUDHRA		UNITED ARAB EMIRATES
13	SHINEDAS SERAH		UNITED ARAB EMIRATES
15	AHMED FARIDA		UNITED ARAB EMIRATES
17	JILLIAN MAYZEE		UNITED ARAB EMIRATES





EMIRATES SPORTS KARATE OPEN - 2023-03-03

U14 Kata Male



R1 G1/2 (10) Tatami 1 11:35(2023-03-04)

Competitors	Kata	1	2	3	4	5	6	7	TOTAL	Extra	Total Rank
1 ALRASHID ABULMALIK (SHARJAH SELF DEFENCE SPORTS CLUB,UAE)		6.5	(7.4)	(6.0)	6.3	6.4			19.2		19.2 6
2 CROOX MICHAEL_JOHANN (BUSHIDO MARTIAL ARTS & FITNESS - SKIF,PHI)		(6.2)	6.1	6.0	(5.9)	5.9			18.0		18.0 8
3 RENGARAJ ROSHAN (AL AZZAM KARATE CENTER, SHARJAH,UAE)		(5.8)	(6.2)	5.8	5.8	6.0			17.6		17.6 10
4 BOIKO IVAN (САРАТОВСКАЯ ОБЛАСТЬ,RUS)		7.1	(7.8)	6.9	(6.8)	6.8			20.8		20.8 2
5 ALMOMANI YOUSEF_ISSAM_AREF (ALKHALEEL SC,UAE)		6.9	(7.9)	7.0	(6.7)	6.9			20.8		20.8 3
6 CABALLERO ETHAN CHRISTOPHER (BUSHIDO MARTIAL ARTS & FITNESS - SKIF,PHI)		(6.3)	5.8	6.2	6.0	(5.6)			18.0		18.0 9
7 ABDELHAMID SAYED (MENTOR,UAE)		(6.5)	6.1	6.5	(5.7)	5.8			18.4		18.4 7
8 AHMADI ALI (KUWAIT FORCE ACADEMY,KUW)		7.3	7.4	(7.5)	6.8	(6.6)			21.5		21.5 1
9 SANDESH SRAAVAN (MARTIAL ARTS KARATE KIDS,UAE)		7.1	6.9	(7.3)	(6.4)	6.4			20.4		20.4 5
10 AYMAN MOUSA MOHANAD (BAHRAIN SHOTOKAN ACADEMY,BRN)		7.4	(7.5)	6.7	6.7	(6.3)			20.8		20.8 4

R1 G2/2 (9) Tatami 2 11:35(2023-03-04)

Competitors	Kata	1	2	3	4	5	6	7	TOTAL	Extra	Total Rank
1 DALATI HAMZA (ISMAILIA MILITARY SPORTS SCHOOL,EGY)		(7.2)	7.2	7.3	(8.1)	7.7			22.2		22.2 1
2 FEKKAS NIKOLAOS (AJSPTSCLUB,UAE)	021 GOJUSHIHO SHO	(6.5)	(5.8)	6.2	5.8	6.3			18.3		18.3 8
3 PEREVOZCHIKOV TIMUR (САРАТОВСКАЯ ОБЛАСТЬ,RUS)		7.0	6.8	7.1	(6.2)	(7.8)			20.9		20.9 4
4 RAZVALOV NIKOLAI (TATSUJIN KARATE SCHOOL RUS,RUS)		7.2	(7.0)	7.2	7.5	(7.6)			21.9		21.9 2
5 CRUZ ZACH_HASHLEE (BUSHIDO MARTIAL ARTS & FITNESS - SKIF,PHI)		6.9	6.9	6.9	(6.8)	(7.2)			20.7		20.7 5
6 SALCEDO TRISTAN_LUIS_RAPHAEL (BUSHIDO MARTIAL ARTS & FITNESS - SKIF,PHI)		6.6	6.3	(6.7)	(6.1)	6.7			19.6		19.6 6
7 ZHADANOV EVGENII (САРАТОВСКАЯ ОБЛАСТЬ,RUS)		7.3	(6.8)	(7.5)	7.3	7.1			21.7		21.7 3
8 ISHAN_KUNNATH ISHAN (MARTIAL ARTS KARATE KIDS,UAE)		6.5	6.5	6.5	(6.2)	(6.6)			19.5		19.5 7
9 ALGHFELI AHMED (MENTOR,UAE)		(5.0)	(5.0)	5.0	5.0	5.0			15.0		15.0 9

R2-G1 Tatami 1 12:05(2023-03-04)

Competitors	Kata	1	2	3	4	5	6	7	TOTAL	Extra	Total Rank
1 BOIKO IVAN (САРАТОВСКАЯ ОБЛАСТЬ,RUS)		7.2	(7.5)	7.1	7.1	(6.8)			21.4		21.4 2
2 AHMADI ALI (KUWAIT FORCE ACADEMY,KUW)		7.4	(7.6)	7.6	6.9	(6.7)			21.9		21.9 1
3 ALMOMANI YOUSEF_ISSAM_AREF (ALKHALEEL SC,UAE)		7.0	(7.3)	7.3	6.9	(6.5)			21.2		21.2 4
4 AYMAN MOUSA MOHANAD (BAHRAIN SHOTOKAN ACADEMY,BRN)		7.3	(7.4)	7.2	6.8	(6.4)			21.3		21.3 3

R2-G2 Tatami 2 12:05(2023-03-04)

Competitors	Kata	1	2	3	4	5	6	7	TOTAL	Extra	Total Rank
1 ZHADANOV EVGENII (САРАТОВСКАЯ ОБЛАСТЬ,RUS)		7.9	(8.2)	7.6	(6.8)	7.5			23.0		23.0 3
2 RAZVALOV NIKOLAI (TATSUJIN KARATE SCHOOL RUS,RUS)		7.7	(8.0)	7.6	(7.0)	7.7			23.0		23.0 2
3 PEREVOZCHIKOV TIMUR (САРАТОВСКАЯ ОБЛАСТЬ,RUS)		7.5	(7.8)	7.8	(6.9)	7.3			22.6		22.6 4
4 DALATI HAMZA (ISMAILIA MILITARY SPORTS SCHOOL,EGY)		7.7	(8.3)	7.8	(7.4)	7.8			23.3		23.3 1

R3 Bronze Medal Match 1 Tatami 1 12:20(2023-03-04)

Competitors	Kata	1	2	3	4	5	6	7	TOTAL	Extra	Total Rank
1 BOIKO IVAN (САРАТОВСКАЯ ОБЛАСТЬ,RUS)		(7.5)	(6.6)	7.4	7.4	7.1			21.9		21.9 1
2 ZHADANOV EVGENII (САРАТОВСКАЯ ОБЛАСТЬ,RUS)		(7.1)	7.2	7.2	(7.6)	7.4			21.8		21.8 2

R3 Bronze Medal Match 2 Tatami 2 12:20(2023-03-04)

Competitors	Kata	1	2	3	4	5	6	7	TOTAL	Extra	Total Rank
1 AYMAN MOUSA MOHANAD (BAHRAIN SHOTOKAN ACADEMY,BRN)		(6.8)	(7.6)	7.0	7.4	7.2			21.6		21.6 2





EMIRATES SPORTS KARATE OPEN - 2023-03-03

U14 Kata Male



2	RAZVALOV NIKOLAI (TATSUJIN KARATE SCHOOL RUS,RUS)	(6.7)	(8.0)	7.5	7.9	7.0							22.4		22.4	1
---	---	-------	-------	-----	-----	-----	--	--	--	--	--	--	------	--	------	---

R3 Gold Medal Match Tatami 1 12:25(2023-03-04)

Competitors	Kata	1	2	3	4	5	6	7	TOTAL	Extra Total Rank
1 AHMADI ALI (KUWAIT FORCE ACADEMY,KUW)		7.4	(7.5)	7.4	7.5	(7.3)			22.3	22.3 2
2 DALATI HAMZA (ISMAILIA MILITARY SPORTS SCHOOL,EGY)		7.6	(7.9)	7.0	7.8	(6.7)			22.4	22.4 1

Results

1	DALATI HAMZA		EGYPT
2	AHMADI ALI		KUWAIT
3	BOIKO IVAN		RUSSIAN FEDERATION
3	RAZVALOV NIKOLAI		RUSSIAN FEDERATION
5	ZHADANOV EVGENII		RUSSIAN FEDERATION
5	AYMAN MOUSA MOHANAD		BAHRAIN
7	ALMOMANI YOUSEF ISSAM AREF		UNITED ARAB EMIRATES
7	PEREVOZCHIKOV TIMUR		RUSSIAN FEDERATION
9	SANDESH SRAAVAN		UNITED ARAB EMIRATES
9	CRUZ ZACH HASHLEE		PHILIPPINES
11	ALRASHID ABULMALIK		UNITED ARAB EMIRATES
11	SALCEDO TRISTAN LUIS RAPHAEL		PHILIPPINES
13	ABDELHAMID SAYED		UNITED ARAB EMIRATES
13	ISHAN KUNNATH ISHAN		UNITED ARAB EMIRATES
15	CROOX MICHAEL JOHANN		PHILIPPINES
15	FEKKAS NIKOLAOS		UNITED ARAB EMIRATES
17	CABALLERO ETHAN CHRISTOPHER		PHILIPPINES
17	ALGHFELI AHMED		UNITED ARAB EMIRATES
19	RENGARAJ ROSHAN		UNITED ARAB EMIRATES



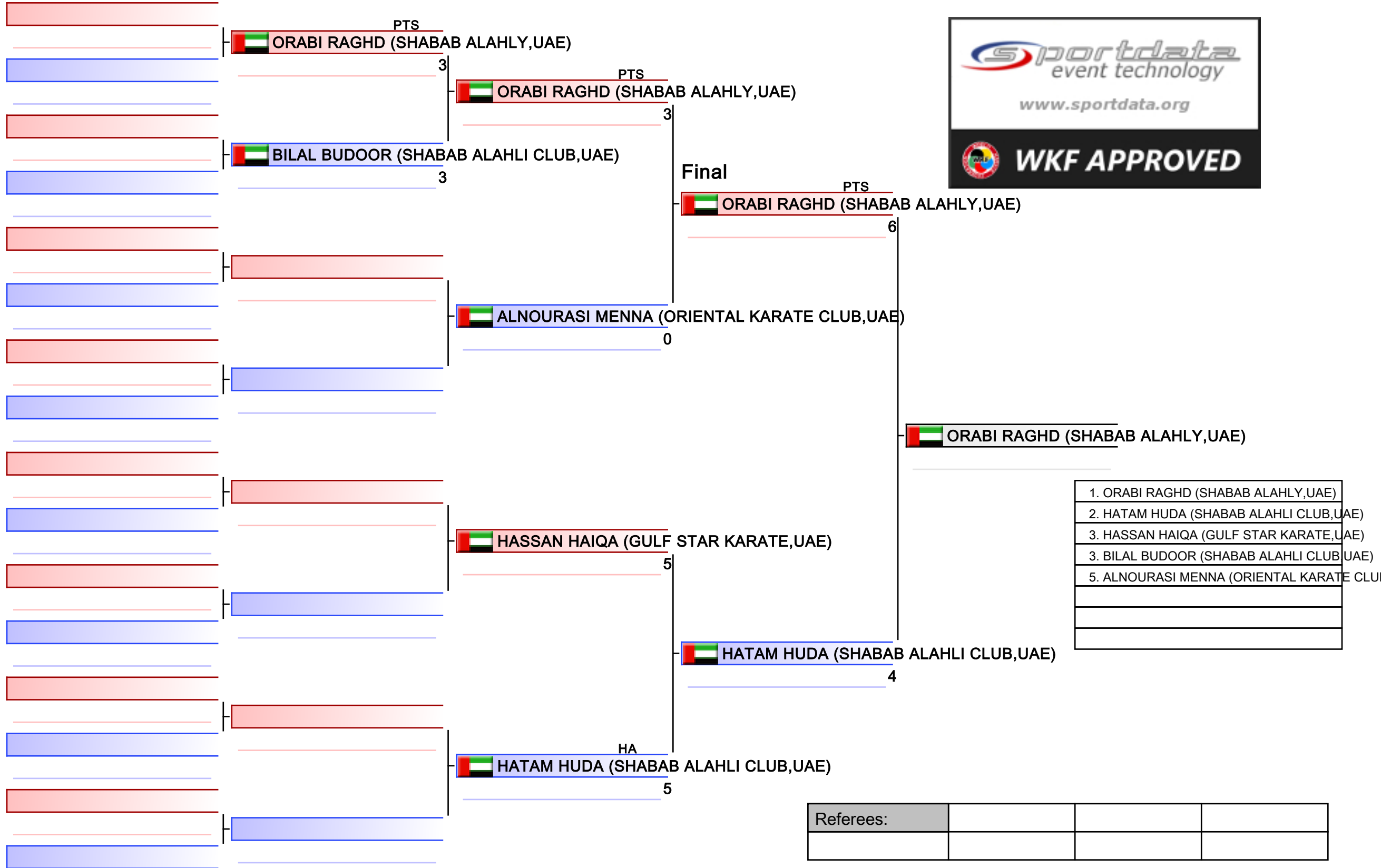

U14 KUMITE FEMALE -42 KG

EMIRATES SPORTS KARATE OPEN

2023-03-04

Tatami
5 14:45

Pool
1

(c)sportdata GmbH & Co KG 2000-2023 (2023-03-05 14:28) v 10.0.0 build 1 (2023-01-21) License: UAE Karate Federation (expire 2023-07-31)

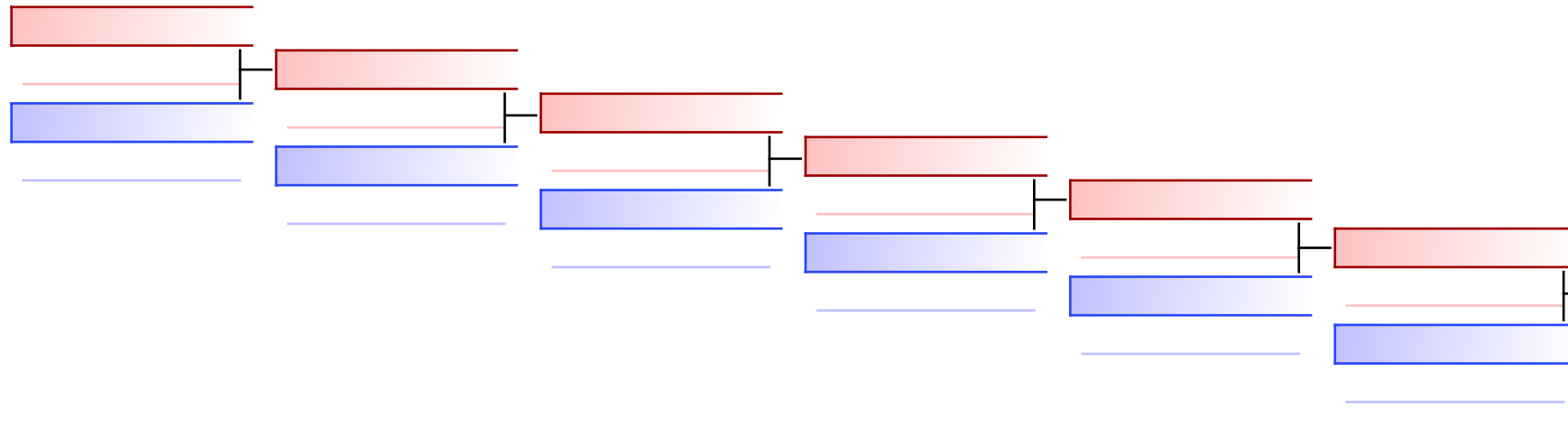

PTS
BILAL BUDOOR (SHABAB ALAHLI CLUB,UAE) 4
ALNOURASI MENNA (ORIENTAL KARATE CLUB,UAE) 0

REPECHAGE: (1)

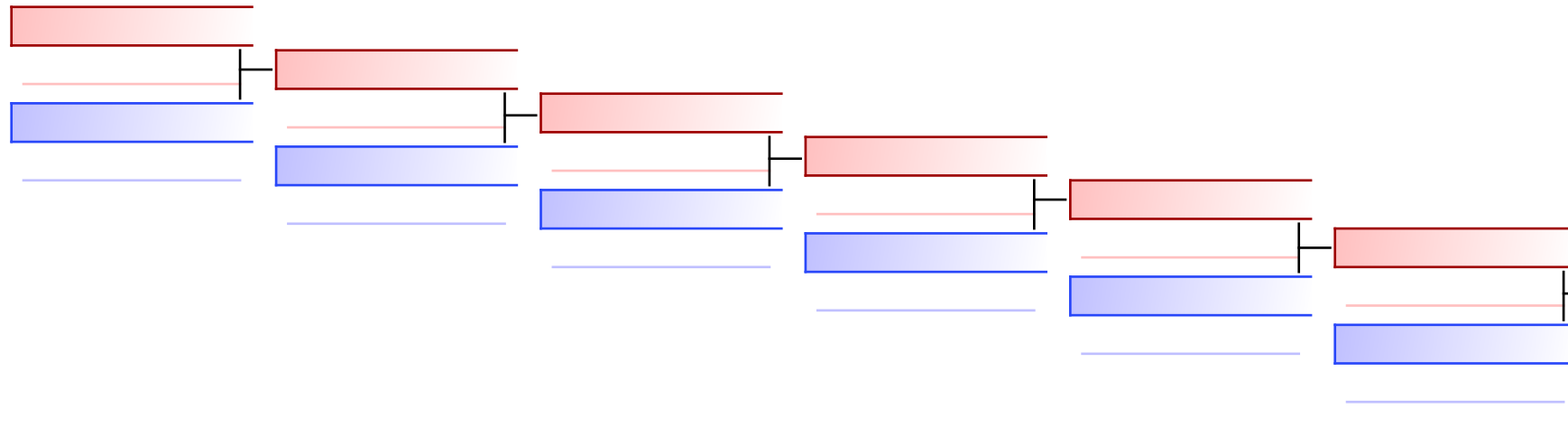

HASSAN HAIQA (GULF STAR K)

Referees:							
-----------	--	--	--	--	--	--	--

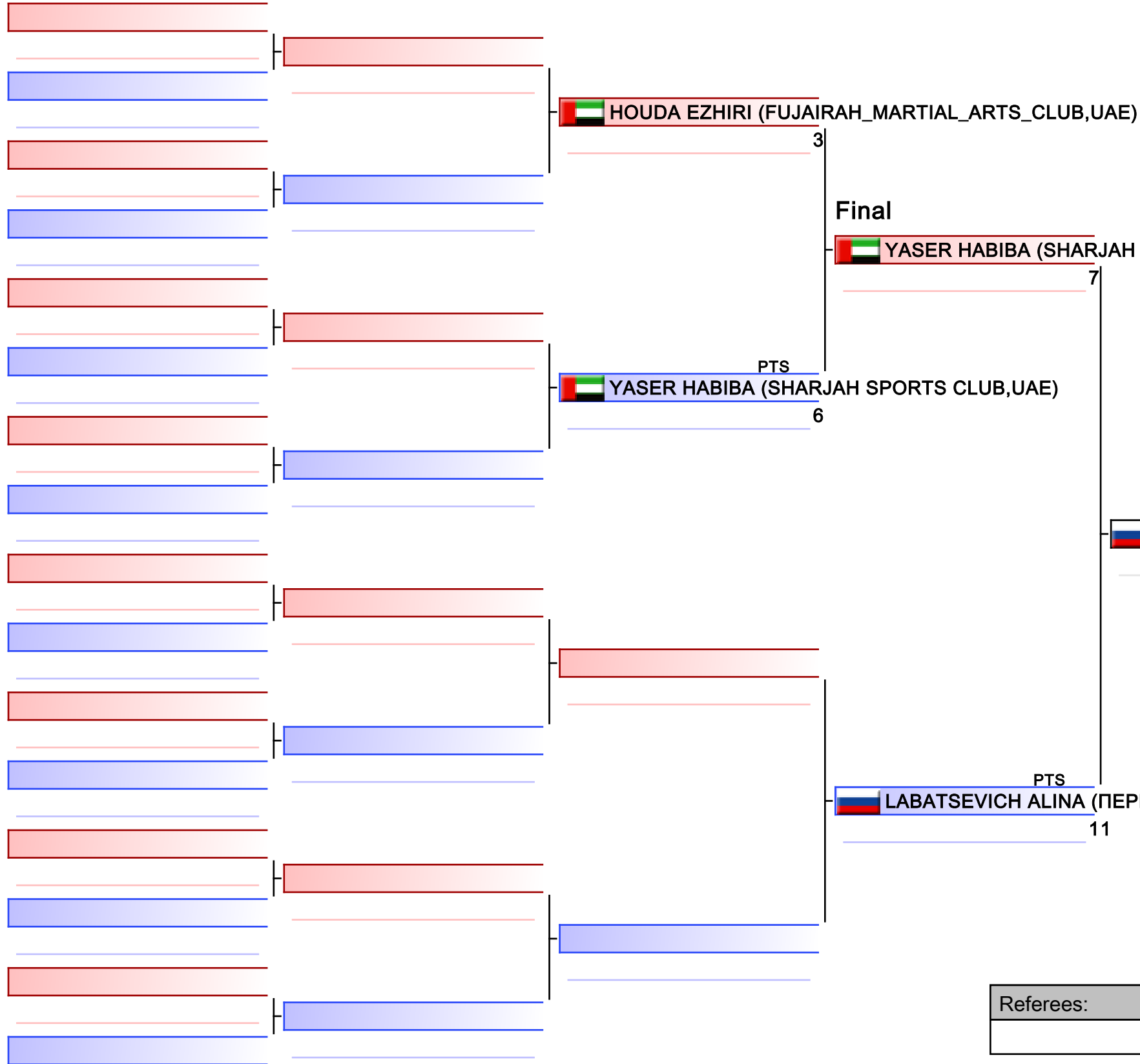

LABATSEVICH ALINA (ПЕРМСКИЙ КРАЙ,RUS)

1. LABATSEVICH ALINA (ПЕРМСКИЙ КРАЙ,RUS)
2. YASER HABIBA (SHARJAH SPORTS CLUB,UAE)

Referees:			

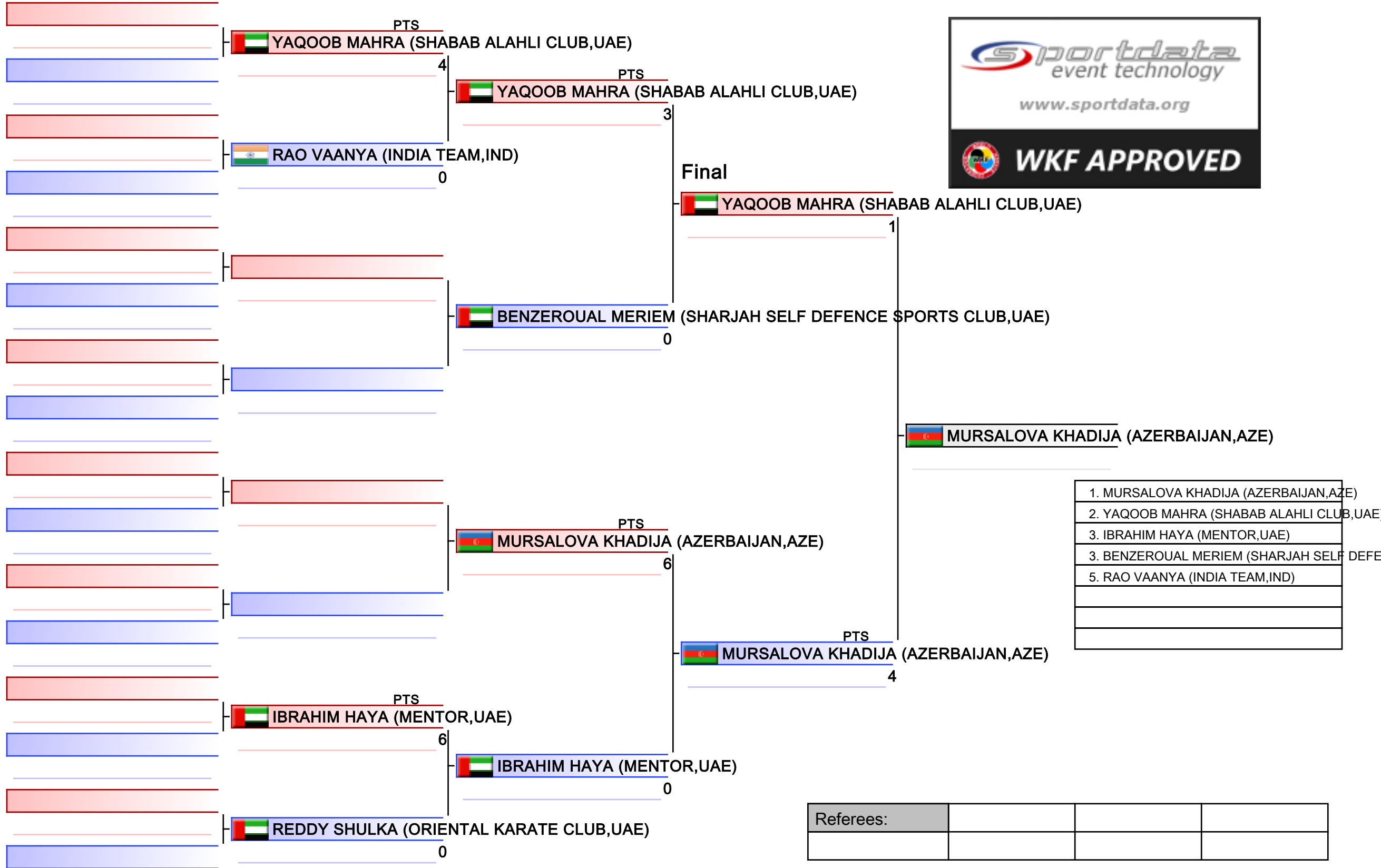

U14 KUMITE FEMALE -52 KG

EMIRATES SPORTS KARATE OPEN

2023-03-04

Tatami
4 14:45

Pool
1

(c)sportdata GmbH & Co KG 2000-2023 (2023-03-05 14:28) v 10.0.0 build 1 (2023-01-21) License: UAE Karate Federation (expire 2023-07-31)

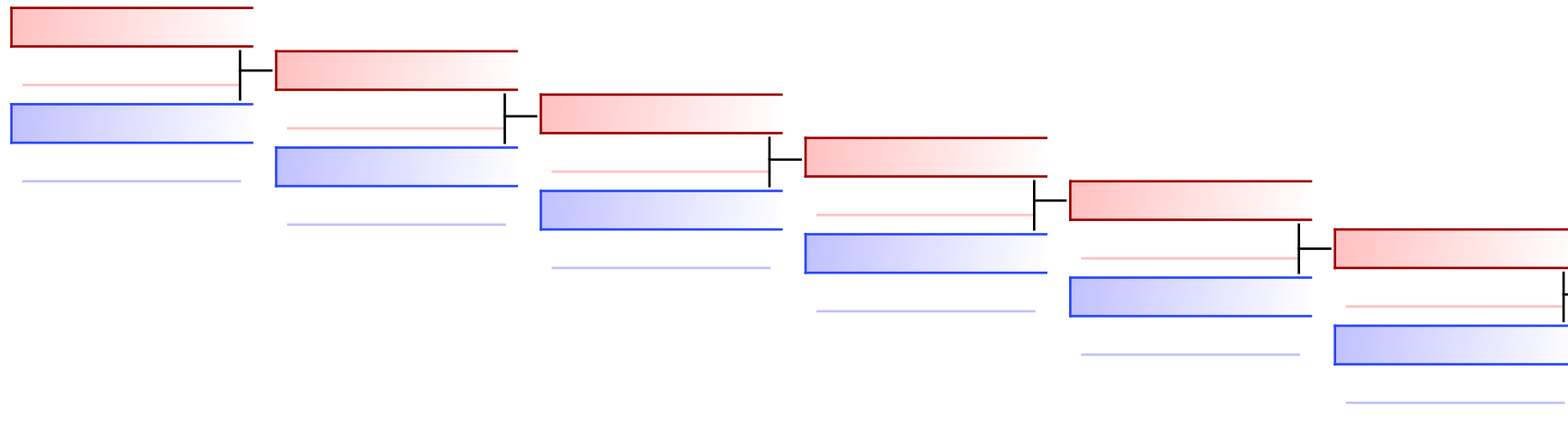

RAO VAANYA (INDIA TEAM,IND)
PTS 0
 BENZEROUAL MERIEM (SHARJAH SELF DEFENCE)
6

REPECHAGE: (1)

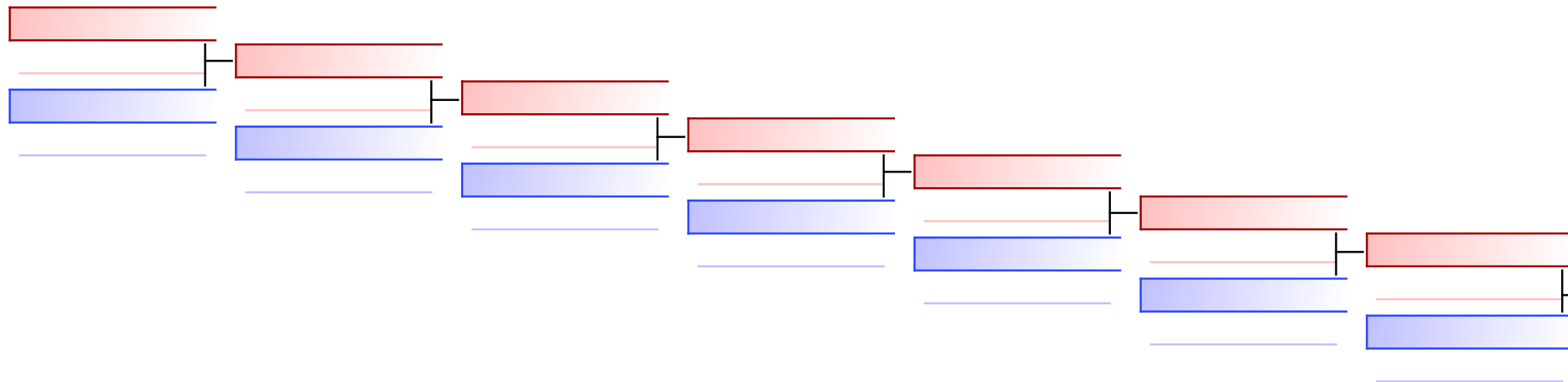

IBRAHIM HAYA (MENTOR,UAE)

Referees:							
-----------	--	--	--	--	--	--	--

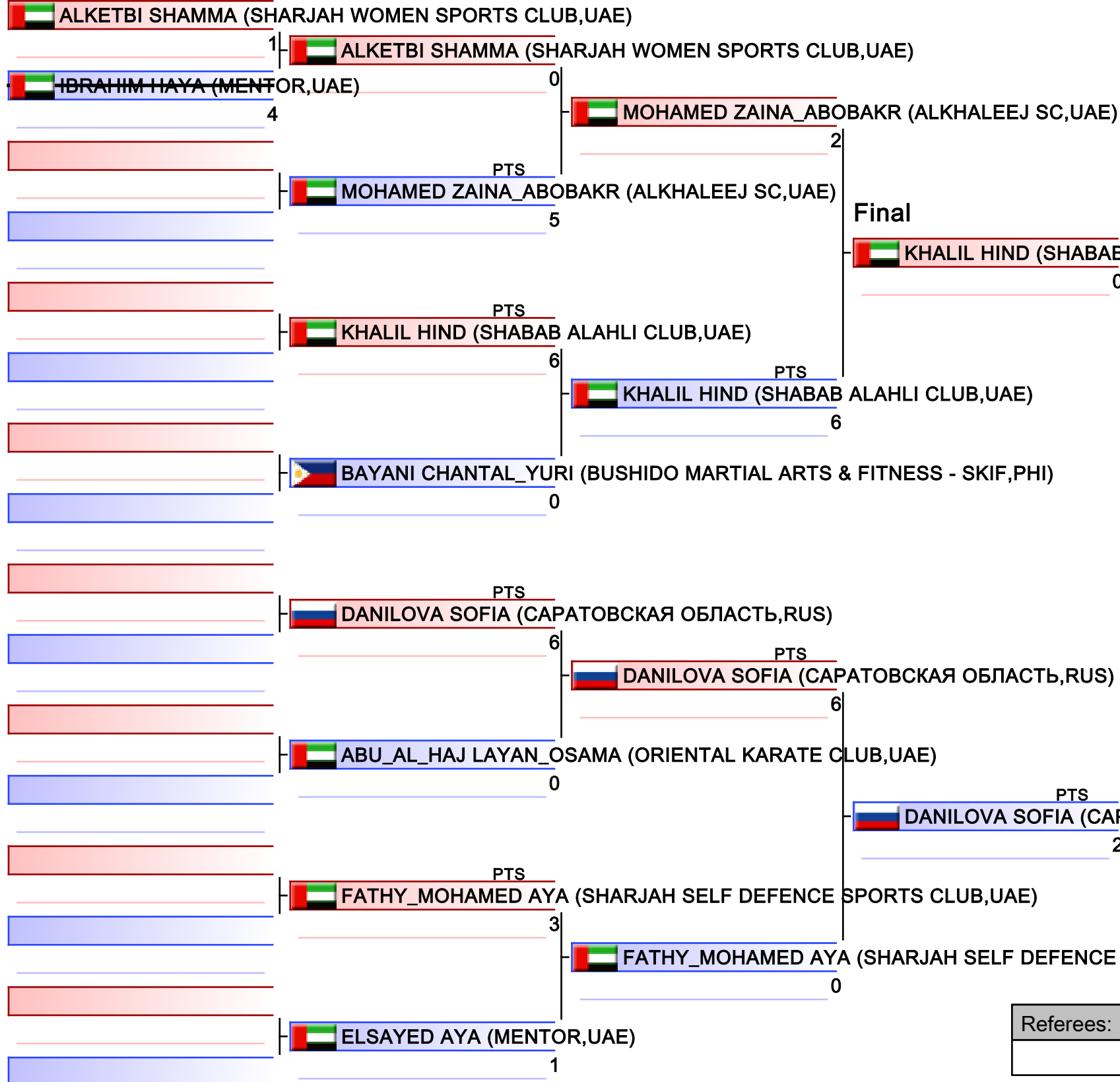

1. DANILOVA SOFIA (CAPATOVSKAYA OBLAST',RUS)
2. KHALIL HIND (SHABAB ALAHLI CLUB,UAE)
3. MOHAMED ZAINA_ABOBAKR (ALKHALEEJ SC,UAE)
3. FATHY_MOHAMED AYA (SHARJAH SELF DEFENCE SPORTS CLUB,UAE)
5. BAYANI CHANTAL_YURI (BUSHIDO MARTIAL ARTS & FITNESS - SKIF,PHI)
5. ABU_AL_HAJ LAYAN_OSAMA (ORIENTAL KARATE CLUB,UAE)

Referees:			

U14 KUMITE FEMALE 52+ KG
EMIRATES SPORTS KARATE OPEN

2023-03-04

Tatami
4 15:10

Pool
1

(c)sportdata GmbH & Co KG 2000-2023 (2023-03-05 14:28) v 10.0.0 build 1 (2023-01-21) License: UAE Karate Federation (expire 2023-07-31)

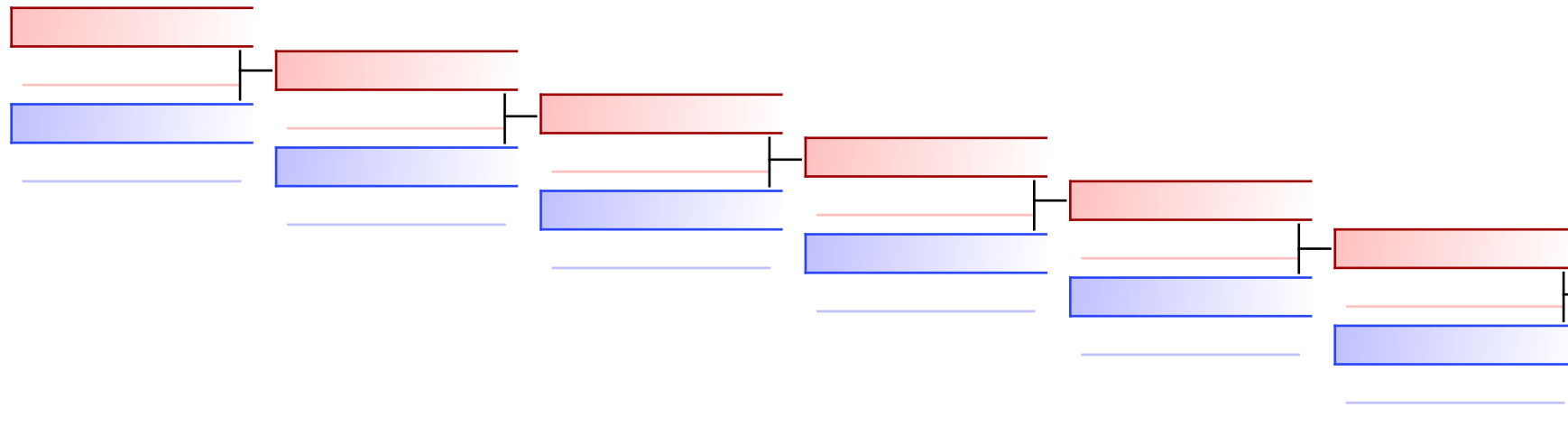

BAYANI CHANTAL_YURI (BUSHIDO MARTIAL ARTS)
 PTS | 0
 MOHAMED ZAINA_ABOBAKR (ALKHALEEJ SC,UAE)
 PTS | 6

REPECHAGE: (1)

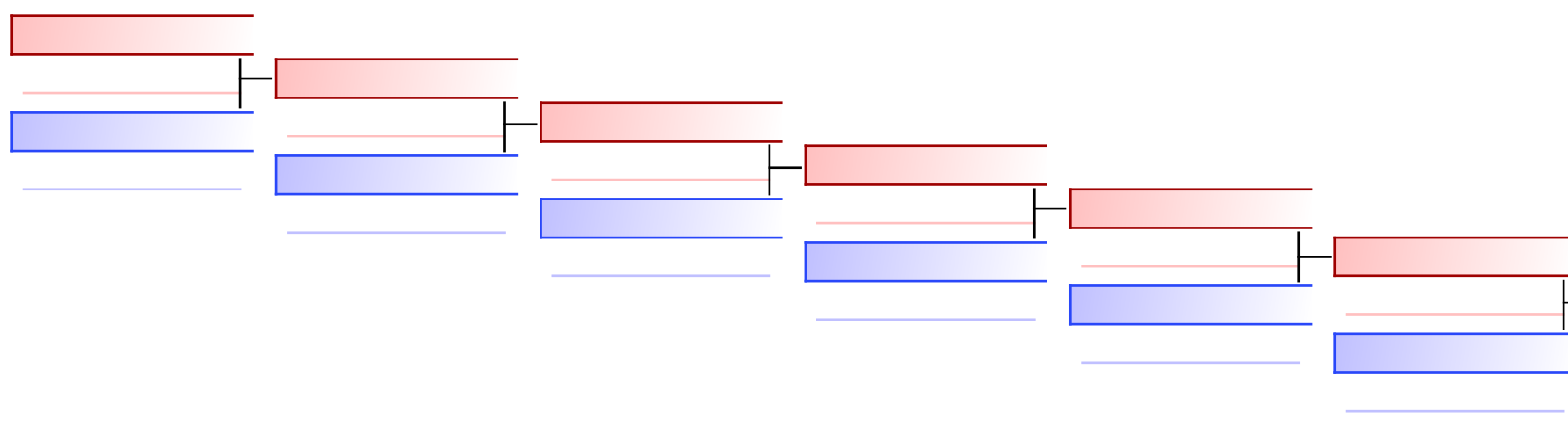

ABU_AL_HAJ LAYAN_OSAMA (ORIENTAL KARATE C)
 PTS | 2
 FATHY_MOHAMED AYA (SHARJAH SELF DEFENCE)
 PTS | 7

Referees:							
-----------	--	--	--	--	--	--	--



- | |
|---|
| 1. GOMAA YOUSIF (SHARJAH SELF DEFENCE SPORTS CLUB, UAE) |
| 2. ABBASLI AMIL (AZERBAIJAN,AZE) |
| 3. TUMINOV MATVEI (САМАРСКАЯ ОБЛАСТЬ, RU) |
| 4. AYMAN MOUSA MOHANAD (BAHRAIN SHOTOKAN ACADEMY, BRN) |
| 5. ELSAYED AHMED (MENTOR,UAE) |
| 5. MOHAMMAD_DHAHER HASHEM (X-FACTOR SPORTS CENTER, QAT) |
| 7. ABDELKAREEM_ALI MOHAMED (SUDAN,SUD) |
| 7. KHALID AHMED (SHARJAH SPORTS CLUB, UAE) |

Referees:			

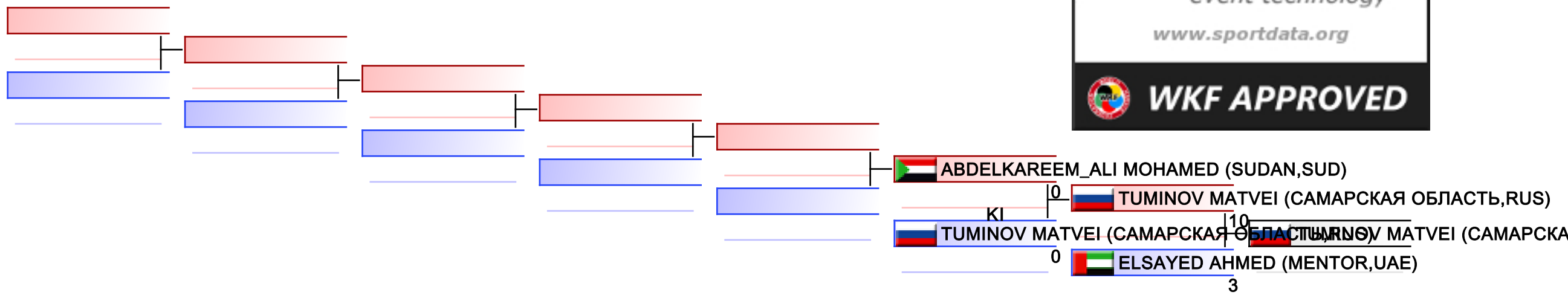

REPECHAGE: (1)

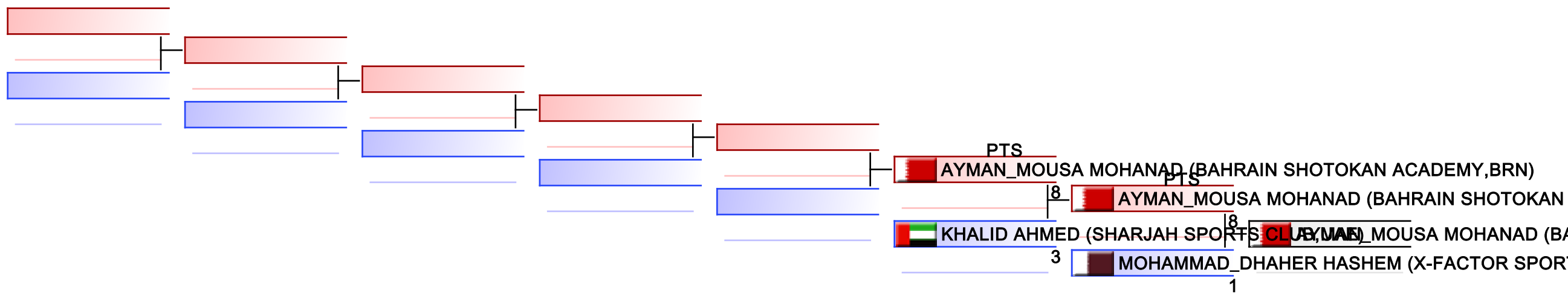

Referees:							
-----------	--	--	--	--	--	--	--

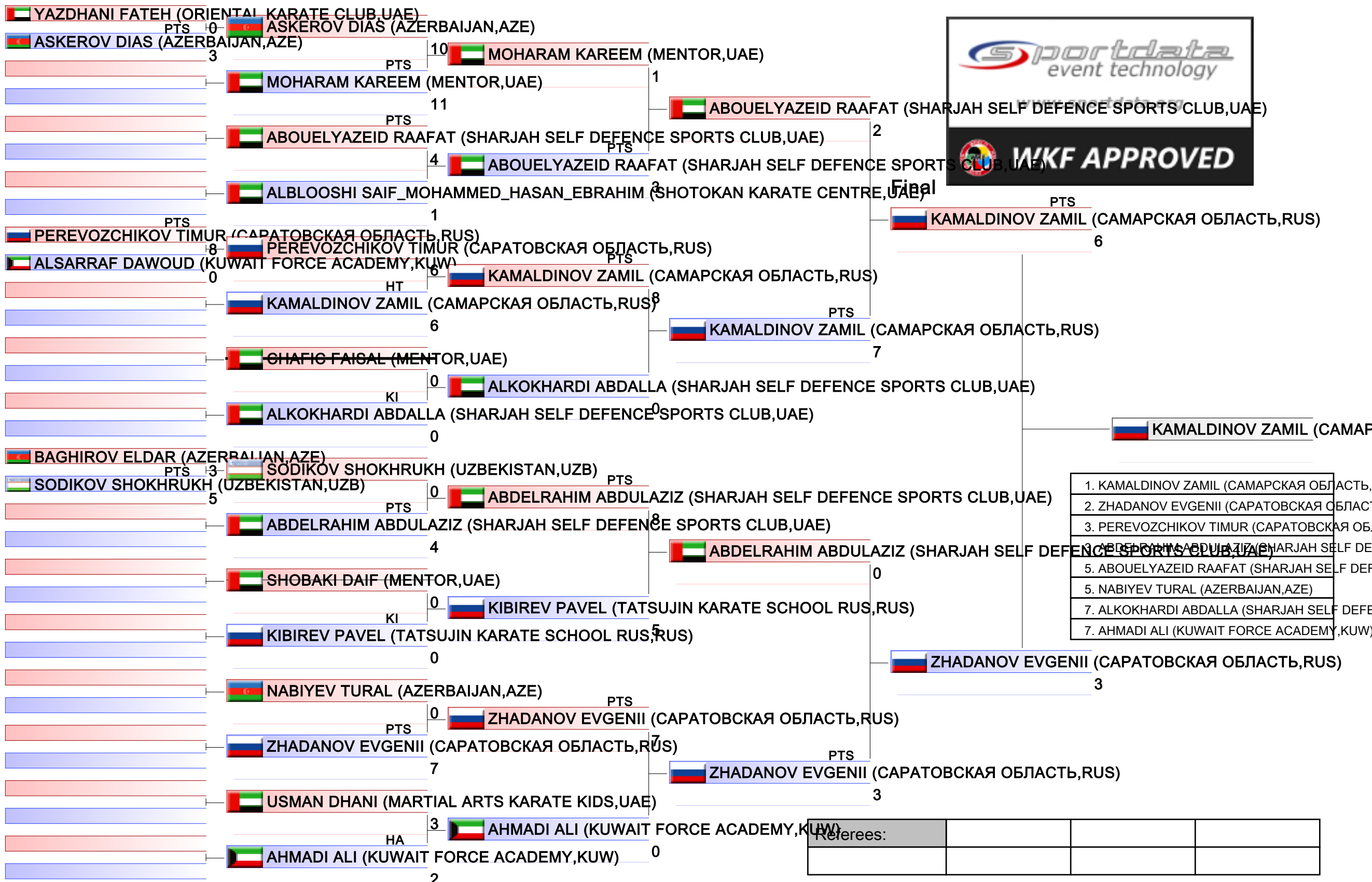

1. KAMALDINOV ZAMIL (САМАРСКАЯ ОБЛАСТЬ,RUS)
2. ZHADANOV EVGENII (САПАТОВСКАЯ ОБЛАСТЬ,RUS)
3. PEREVOZCHIKOV TIMUR (САПАТОВСКАЯ ОБЛАСТЬ,RUS)
3. ABDELRAHIM ABDULAZIZ (SHARJAH SELF DEFENCE SPORTS CLUB,UAE)
5. ABOUELYAZEID RAAFAT (SHARJAH SELF DEFENCE SPORTS CLUB,UAE)
5. NABIYEV TURAL (AZERBAIJAN,AZE)
7. ALKOKHARDI ABDALLA (SHARJAH SELF DEFENCE SPORTS CLUB,UAE)
7. AHMADI ALI (KUWAIT FORCE ACADEMY,KUW)

U14 KUMITE MALE -40 KG
EMIRATES SPORTS KARATE OPEN

2023-03-04

Tatami
1 15:30

Pool
1

(c)sportdata GmbH & Co KG 2000-2023 (2023-03-05 14:28) v 10.0.0 build 1 (2023-01-21) License: UAE Karate Federation (expire 2023-07-31)

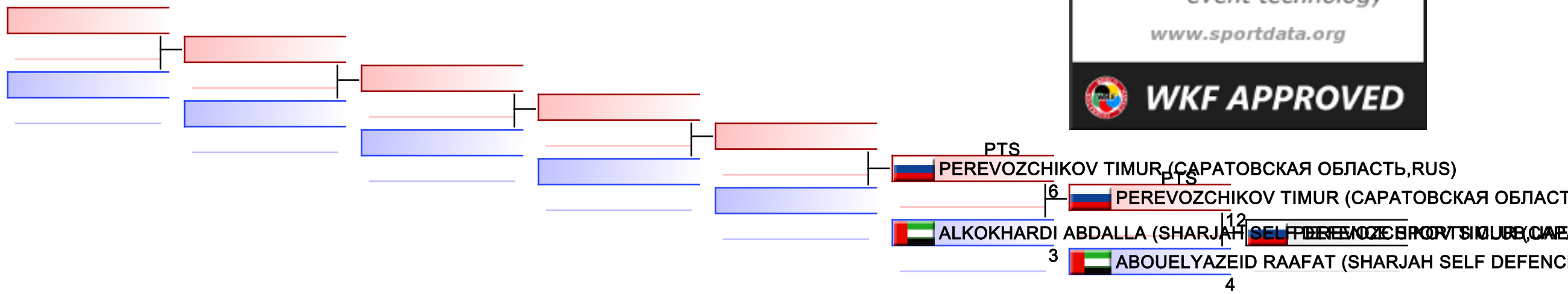

REPECHAGE: (1)

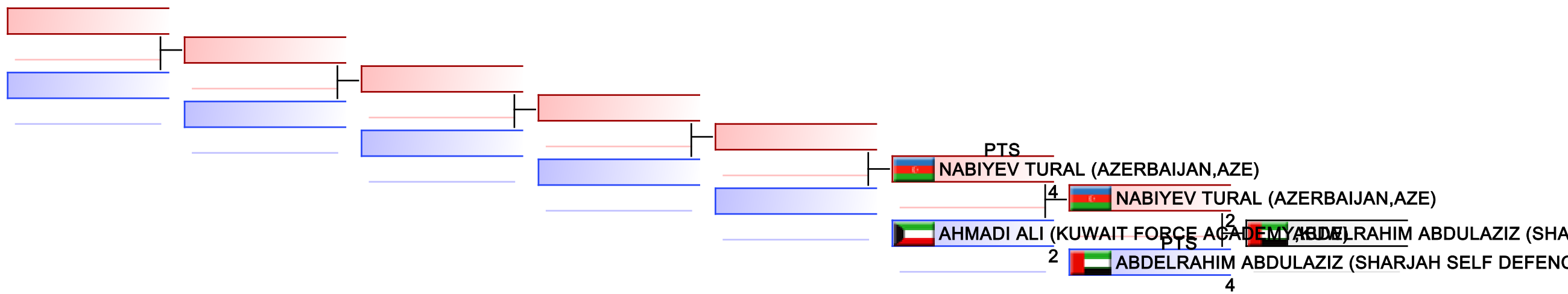

Referees:							
-----------	--	--	--	--	--	--	--

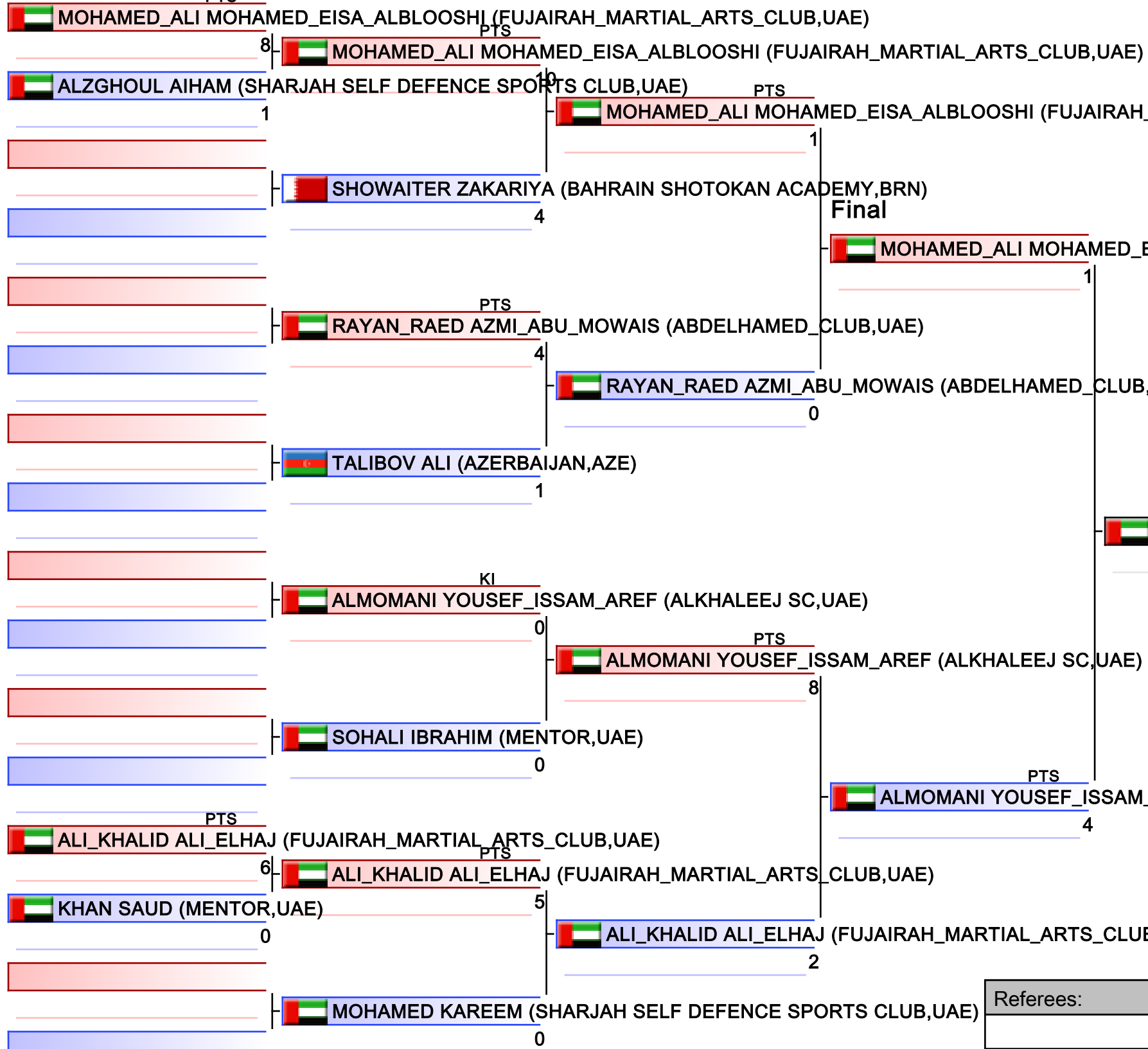

1. ALMOMANI YOUSEF_ISSAM_AREF (ALKHALEEJ SC, UAE)
2. MOHAMED_ALI MOHAMED_EISA_ALBLOOSHI (FUJAIRAH MARTIAL ARTS CLUB, UAE)
3. ALI_KHALID ALI_ELHAJ (FUJAIRAH MARTIAL ARTS CLUB, UAE)
3. RAYAN_RAED AZMI_ABU_MOWAIS (ABDELHAMED CLUB, UAE)
5. SOHALI IBRAHIM (MENTOR, UAE)
5. ALZGHOUL AIHAM (SHARJAH SELF DEFENCE SPORTS CLUB, UAE)
7. SHOWAITER ZAKARIYA (BAHRAIN SHOTOKAN ACADEMY, BRN)

Referees:			

U14 KUMITE MALE -45 KG
EMIRATES SPORTS KARATE OPEN

2023-03-04

Tatami
2 15:25

Pool
1

(c)sportdata GmbH & Co KG 2000-2023 (2023-03-05 14:28) v 10.0.0 build 1 (2023-01-21) License: UAE Karate Federation (expire 2023-07-31)

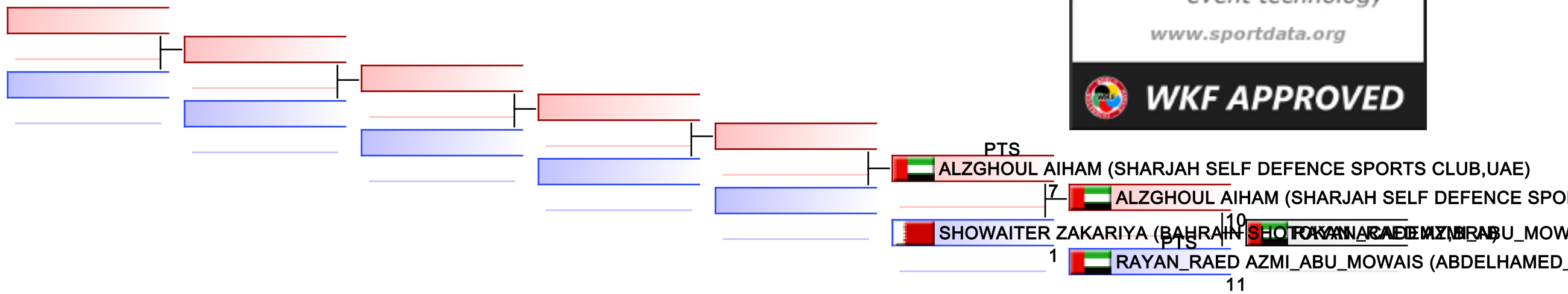

REPECHAGE: (1)

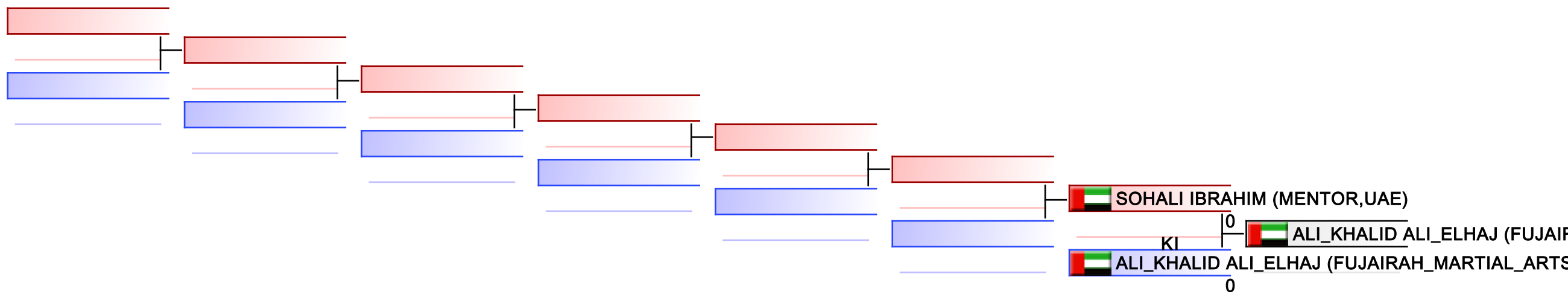

Referees:							
-----------	--	--	--	--	--	--	--

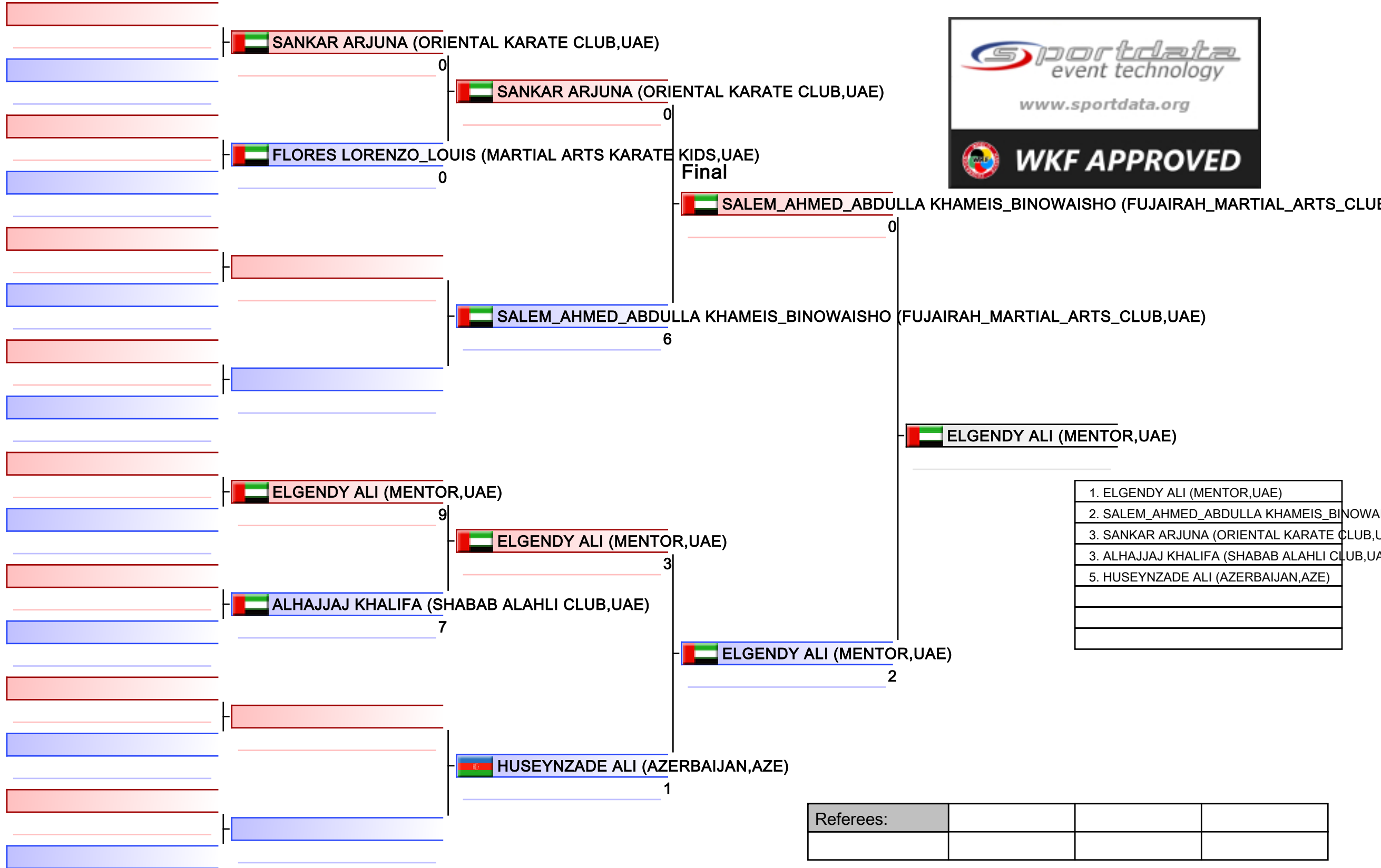

- | |
|---|
| 1. ELGENDY ALI (MENTOR, UAE) |
| 2. SALEM AHMED ABDULLA KHAMEIS BINOWAISHO (FUJAIRAH MARTIAL ARTS CLUB, UAE) |
| 3. SANKAR ARJUNA (ORIENTAL KARATE CLUB, UAE) |
| 3. ALHAJJAJ KHALIFA (SHABAB ALAHLI CLUB, UAE) |
| 5. HUSEYNZADE ALI (AZERBAIJAN, AZE) |
| |
| |

Referees:			

U14 KUMITE MALE -50 KG
EMIRATES SPORTS KARATE OPEN

2023-03-04 3 15:05 Tatami
 1 Pool

(c)sportdata GmbH & Co KG 2000-2023 (2023-03-05 14:28) v 10.0.0 build 1 (2023-01-21) License: UAE Karate Federation (expire 2023-07-31)

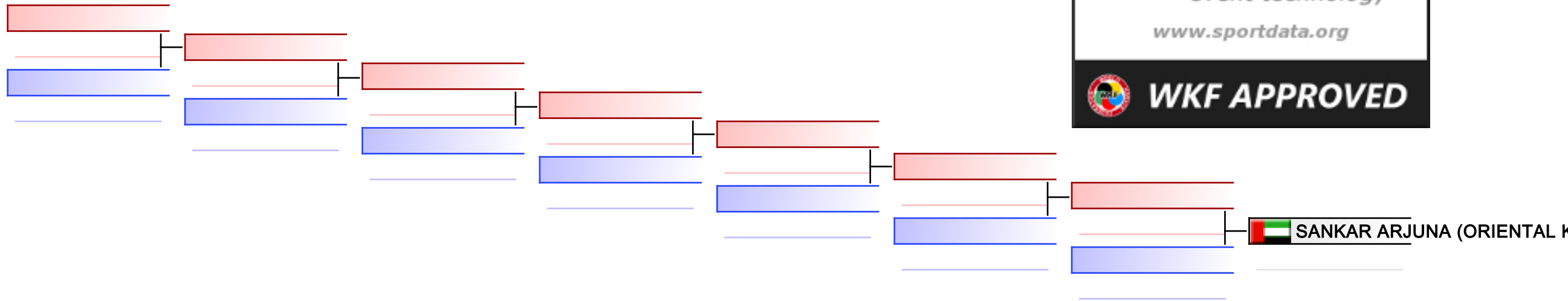

REPECHAGE: (1)

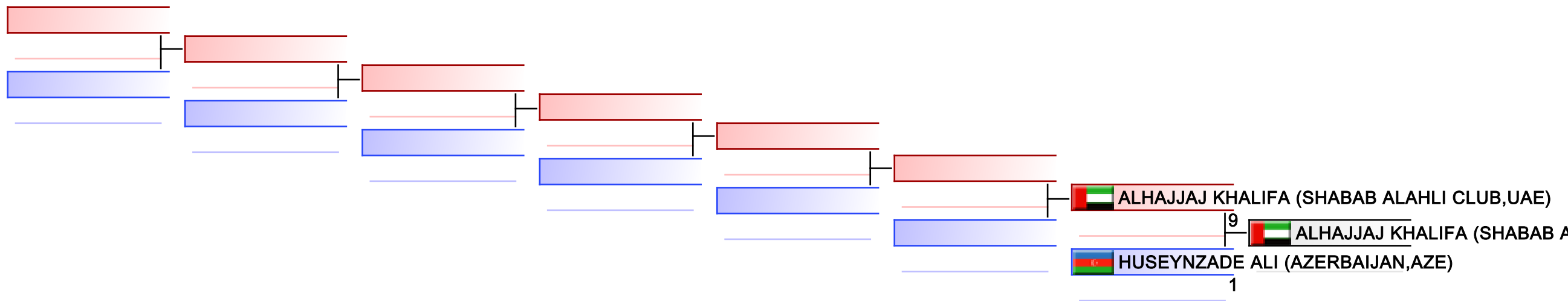

Referees:							
-----------	--	--	--	--	--	--	--

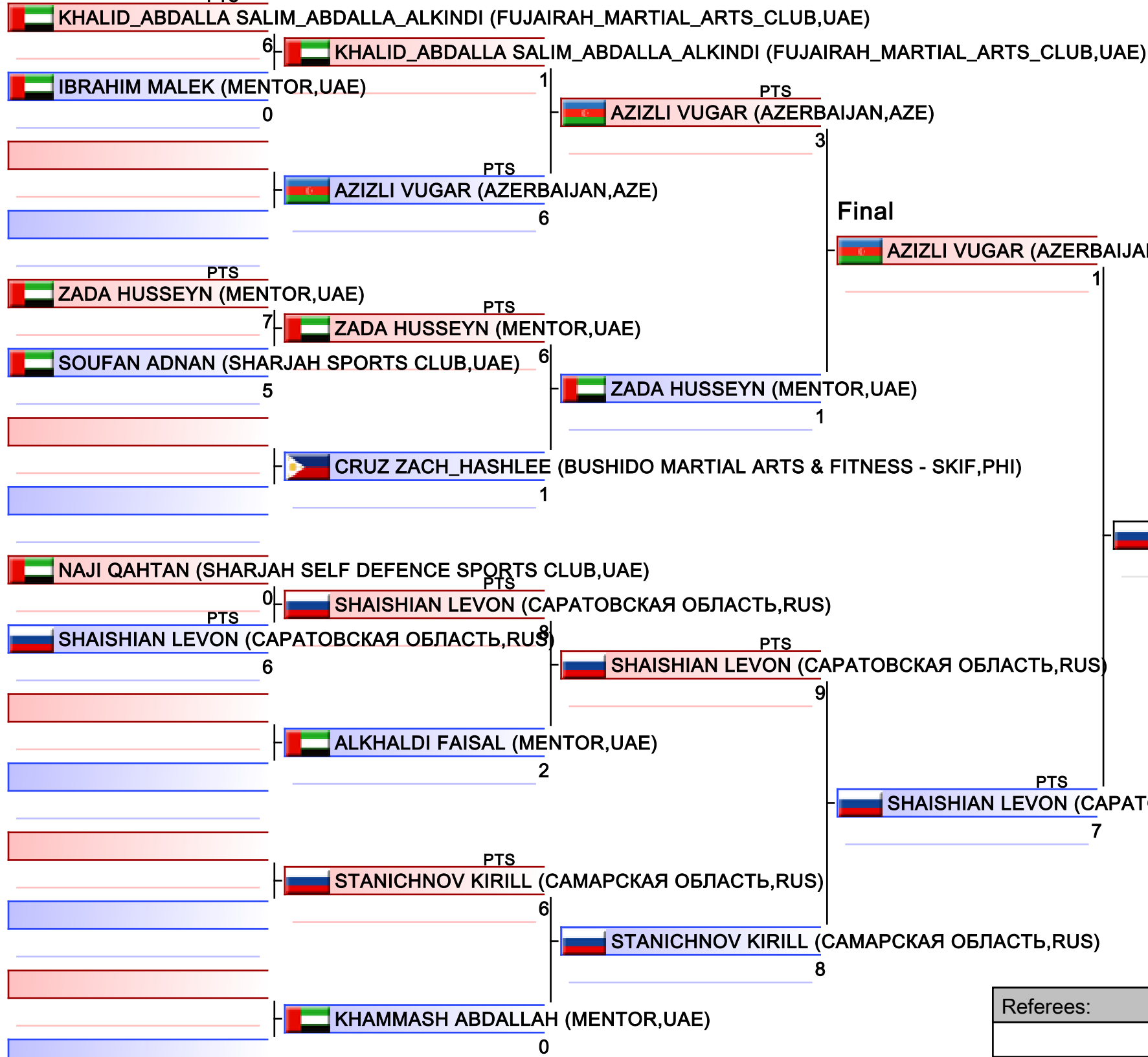

- | |
|--|
| 1. SHAISHIAN LEVON (САРАТОВСКАЯ ОБЛАСТЬ,RUS) |
| 2. AZIZLI VUGAR (AZERBAIJAN,AZE) |
| 3. KHALID_ABDALLA SALIM_ABDALLA_ALKINDI (FUJAIRAH_MARTIAL_ARTS_CLUB,UAE) |
| 3. STANICHNOV KIRILL (САМАРСКАЯ ОБЛАСТЬ,RUS) |
| 5. ZADA HUSSEYN (MENTOR,UAE) |
| 5. ALKHALDI FAISAL (MENTOR,UAE) |
| 7. NAJI QAHTAN (SHARJAH SELF DEFENCE SPORTS CLUB,UAE) |

Referees:			

U14 KUMITE MALE -55 KG
EMIRATES SPORTS KARATE OPEN

2023-03-04 5 15:15 Tatami 1 Pool 1

(c)sportdata GmbH & Co KG 2000-2023 (2023-03-05 14:28) v 10.0.0 build 1 (2023-01-21) License: UAE Karate Federation (expire 2023-07-31)

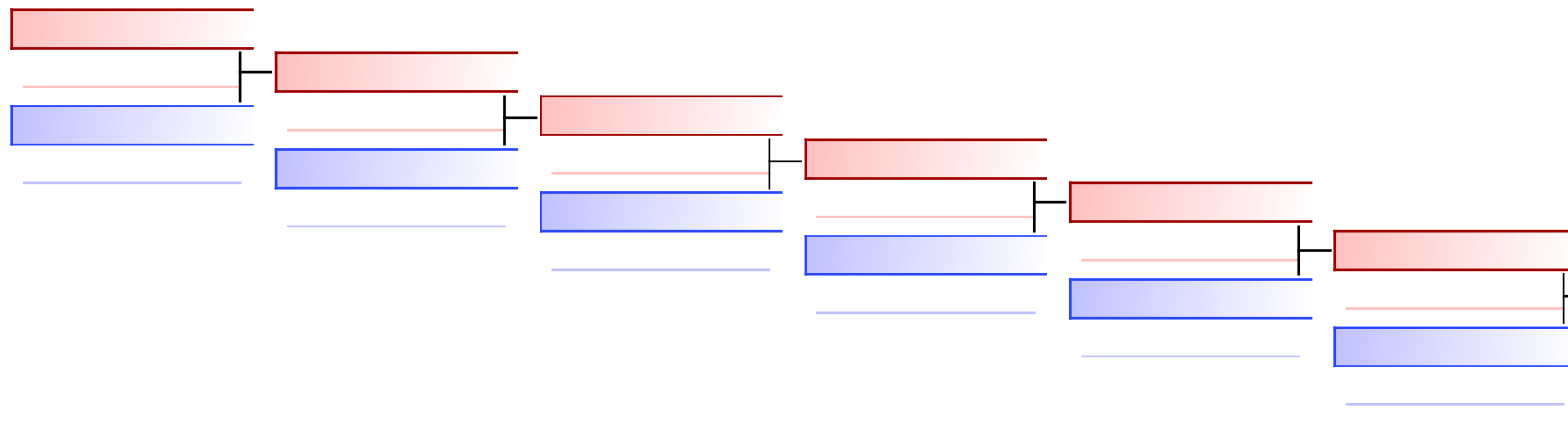

PTS
 KHALID_ABDALLA SALIM_ABDALLA_ALKINDI (FUJA) 5
 KHALID_ABDALLA SALIM_ABDALLA_ALKINDI (FUJA) 0
 ZADA HUSSEYN (MENTOR,UAE) 1

REPECHAGE: (1)

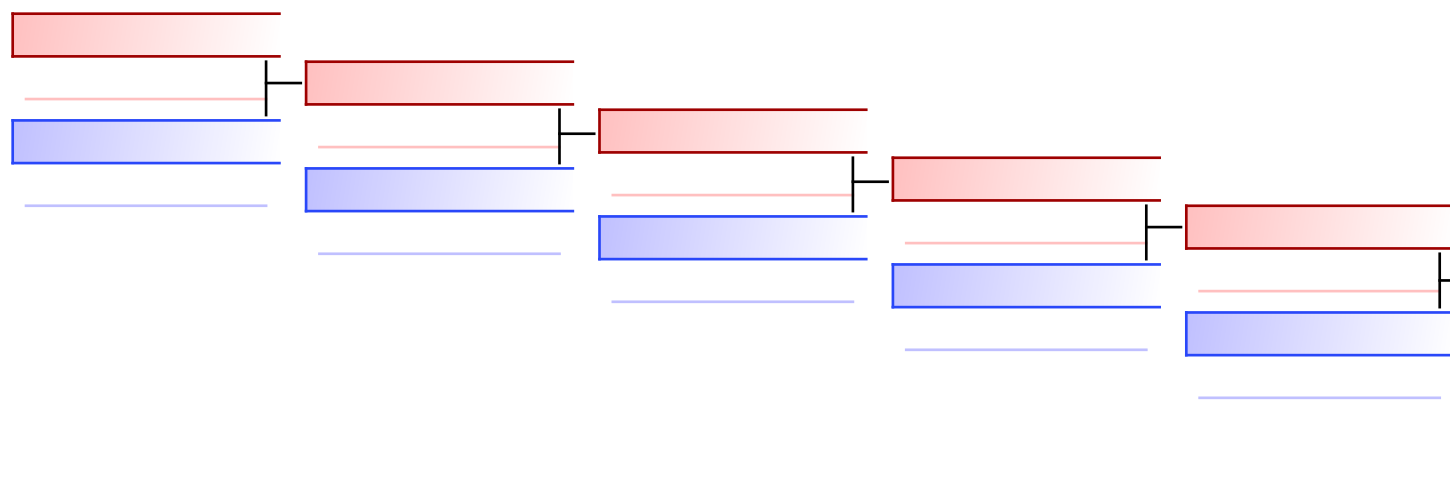

NAJI QAHTAN (SHARJAH SELF DEFENCE SPORTS CLUB,UAE) 0
 ALKHALDI FAISAL (MENTOR,UAE) 0
 KI
 ALKHALDI FAISAL (MENTOR,UAE) 1
 STANICHNOV KIRILL (САМАРСКАЯ ОБЛАСТЬ,RUS) 3

Referees:							
-----------	--	--	--	--	--	--	--



EMIRATES SPORTS KARATE OPEN - 2023-03-03



Official Results

Cadet Kata Female

1	ALBOROM JENA		UAE - UNITED ARAB EMIRATES	
2	PIRIAZEVA VIKTORIIA		RUS - RUSSIAN FEDERATION	
3	TIU NATHANIA ERIKA		UAE - UNITED ARAB EMIRATES	
3	PAGUIO GABRIELLE		PHI - PHILIPPINES	

Cadet Kata Male

1	ZIAD WAEL ABDULAZIM HUSSEIN		UAE - UNITED ARAB EMIRATES	
2	YOUCEF MOKRANI		ALG - ALGERIA	
3	EWAN ABDELHAMID SHAHAT AHMED YOUSSEF		UAE - UNITED ARAB EMIRATES	
3	BEREZIN DANIIL		RUS - RUSSIAN FEDERATION	
5	NIZAR MOKRANI		ALG - ALGERIA	
5	REGINIO JES JOSEPH		PHI - PHILIPPINES	
7	ZAMORA WILFRED II		UAE - UNITED ARAB EMIRATES	
7	CRUZ LANCE JOURNEY EZEKIEL		PHI - PHILIPPINES	
9	SHAH ABDULLA		UAE - UNITED ARAB EMIRATES	
11	SELVARAJ SRIDHAR		UAE - UNITED ARAB EMIRATES	

CADET KUMITE FEMALE -47 KG

1	KHALID ROOH		JOR - JORDAN	
2	ALSOBOH HANEEN		UAE - UNITED ARAB EMIRATES	
3	ARAPOVA ALINA		RUS - RUSSIAN FEDERATION	
3	TAREQ NATTALY		JOR - JORDAN	
5	BARAT AMNA		UAE - UNITED ARAB EMIRATES	
5	MALAK JOUD		UAE - UNITED ARAB EMIRATES	

CADET KUMITE FEMALE -54 KG

1	AKSENOVA VARVARA		RUS - RUSSIAN FEDERATION	
2	ALBOROM JENA		UAE - UNITED ARAB EMIRATES	
3	ALAGUZ JUMANA		UAE - UNITED ARAB EMIRATES	
3	FATHY MOHAMED ALLAA		UAE - UNITED ARAB EMIRATES	
5	AL MALKAWI JANA		UAE - UNITED ARAB EMIRATES	
5	ELMESSIRY ALISSAR		UAE - UNITED ARAB EMIRATES	

CADET KUMITE FEMALE -61 KG

1	FADI OUN AYAH		UAE - UNITED ARAB EMIRATES	
2	AHMED YASSMIN		UAE - UNITED ARAB EMIRATES	
3	JULIAN MAYA		UAE - UNITED ARAB EMIRATES	
3	ASGAROVA AGHGUL		AZE - AZERBAIJAN	
5	ALKETBI SHAIKHA		UAE - UNITED ARAB EMIRATES	

CADET KUMITE FEMALE 61+ KG

1	KOTB MALAK		UAE - UNITED ARAB EMIRATES	
2	SABRI LAMAR MARWAN		UAE - UNITED ARAB EMIRATES	
3	AL -NSOUR NOUF SULEIMAN		UAE - UNITED ARAB EMIRATES	
3	ROUDHER AAYESHA TAJI MOHIDEEN		UAE - UNITED ARAB EMIRATES	





EMIRATES SPORTS KARATE OPEN - 2023-03-03



Official Results

CADET KUMITE MALE -52 KG

1	ASKAROV RINAT		RUS - RUSSIAN FEDERATION	
2	SPIVAK MIKHAIL		RUS - RUSSIAN FEDERATION	
3	MAHYOUB MOHAMMED		UAE - UNITED ARAB EMIRATES	
3	MUKHTARZADE HUSEYN		AZE - AZERBAIJAN	
5	FAZELI ADNAN		UAE - UNITED ARAB EMIRATES	
5	AL-MALIKI ABDULAZIZ		KSA - SAUDI ARABIA	

CADET KUMITE MALE -57 KG

1	YASSER MOHAMED		EGY - EGYPT	
2	SALEEM EISSA		KUW - KUWAIT	
3	REGINIO JES JOSEPH		PHI - PHILIPPINES	
3	KHALIL RASHID		UAE - UNITED ARAB EMIRATES	

CADET KUMITE MALE -63 KG

1	SELEZENEV MATVEI		RUS - RUSSIAN FEDERATION	
2	ALBOROM YASSER		UAE - UNITED ARAB EMIRATES	
3	WAFAI ALAEDDIN		UAE - UNITED ARAB EMIRATES	
3	ROOHI BADR		UAE - UNITED ARAB EMIRATES	
5	CRUZ LANCE JOURNEY EZEKIEL		PHI - PHILIPPINES	
5	ALAZZEH EYAS SAMER		UAE - UNITED ARAB EMIRATES	

CADET KUMITE MALE -70 KG

1	AL-ZAHRANI AZZAM		KSA - SAUDI ARABIA	
2	RAMI KAREEM		JOR - JORDAN	
3	SAIF SALEM MOHAMED EL SHAHAT SALEM MOHAMED		UAE - UNITED ARAB EMIRATES	
3	YOUNES MOHAMED		UAE - UNITED ARAB EMIRATES	

CADET KUMITE MALE 70+ KG

1	GOMAA KHALID		UAE - UNITED ARAB EMIRATES	
2	MUBADDA ABDULHALIM		UAE - UNITED ARAB EMIRATES	
3	MOHAMED ALI		UAE - UNITED ARAB EMIRATES	
3	YOUSIF MOHAMED MOHAMED		SUD - SUDAN	
5	AL-MALEHI FAISAL		KSA - SAUDI ARABIA	

Junior Kata Female

1	TAREQ MAYA		JOR - JORDAN	
2	ALAZZEH LINDA		UAE - UNITED ARAB EMIRATES	
3	JOSHI MIMANSHA		IND - INDIA	
3	MINESHKUMAR DIYA MINESH KUMAR		UAE - UNITED ARAB EMIRATES	

Junior Kata Male

1	MOHAMED ABDULGHANI		UAE - UNITED ARAB EMIRATES	
2	KIAN FARAMARZ		UAE - UNITED ARAB EMIRATES	
3	ALMEJADY ALI		KUW - KUWAIT	
3	GALAL AASEM		EGY - EGYPT	





EMIRATES SPORTS KARATE OPEN - 2023-03-03



Official Results

JUNIOR KUMITE FEMALE -48 KG

1	DAVYDOVA VIKTORIIA		RUS - RUSSIAN FEDERATION	
2	JOSHI MIMANSHA		IND - INDIA	

JUNIOR KUMITE FEMALE -53 KG

1	SADYKOVA AIGUL		RUS - RUSSIAN FEDERATION	
2	SHANIA ANGEL		UAE - UNITED ARAB EMIRATES	

JUNIOR KUMITE FEMALE -59 KG

1	VALIZADA KHADIJA		AZE - AZERBAIJAN	
2	TAMANG BINU MAYA		NEP - NEPAL	
3	ALBAZ RAYYAN		UAE - UNITED ARAB EMIRATES	
3	LABATSEVICH ALISA		RUS - RUSSIAN FEDERATION	
5	AHMED RAZA SALWA		BRN - BAHRAIN	

JUNIOR KUMITE FEMALE -66 KG

1	ALAZZEH LINDA		UAE - UNITED ARAB EMIRATES	
2	MINESHKUMAR DIYA MINESH KUMAR		UAE - UNITED ARAB EMIRATES	

JUNIOR KUMITE MALE -55 KG

1	CHALTOUNI OMAR		UAE - UNITED ARAB EMIRATES	
2	GHOLAMREZA FAZEL		UAE - UNITED ARAB EMIRATES	
3	KHALED GAMAL		EGY - EGYPT	
3	MURATOV ARSENI		RUS - RUSSIAN FEDERATION	
5	GEORGE JOUSHUA		UAE - UNITED ARAB EMIRATES	

JUNIOR KUMITE MALE -61 KG

1	ELSAYED AHMED		EGY - EGYPT	
2	ABBASOV RASUL		AZE - AZERBAIJAN	
3	KHALILOV AMIR		RUS - RUSSIAN FEDERATION	
3	STANICHNOV DANILA		RUS - RUSSIAN FEDERATION	
5	HASSAN ABDULLAH ABDULLA		UAE - UNITED ARAB EMIRATES	

JUNIOR KUMITE MALE -68 KG

1	YOUSSEF OMAR		UAE - UNITED ARAB EMIRATES	
2	AL SHEHHI MANSOUR		UAE - UNITED ARAB EMIRATES	
3	ELGHOROORI LOAI		UAE - UNITED ARAB EMIRATES	
3	MURADOV DAVUD		AZE - AZERBAIJAN	
5	ALMEJADY ALI		KUW - KUWAIT	
5	JAMAL ALBALOOSHI SAM		BRN - BAHRAIN	

JUNIOR KUMITE MALE -76 KG

1	JAFARZADE ZAKI		AZE - AZERBAIJAN	
2	GAD BELAL		UAE - UNITED ARAB EMIRATES	

JUNIOR KUMITE MALE 76+ KG

1	HOSSAM ABDULRAHMAN		UAE - UNITED ARAB EMIRATES	
---	--------------------	--	----------------------------	--





EMIRATES SPORTS KARATE OPEN - 2023-03-03



Official Results

2	ELSAYED YOUSEF		UAE - UNITED ARAB EMIRATES
---	----------------	--	----------------------------

KIDS KATA FEMALE 10 - 11 YEARS

1	KIBIREVA ALEXANDRA		RUS - RUSSIAN FEDERATION
2	AFSHAR SOFI		RUS - RUSSIAN FEDERATION
3	MOHAMED LAMAR		UAE - UNITED ARAB EMIRATES
3	KHALID DANA		UAE - UNITED ARAB EMIRATES
5	EHAB SARA		UAE - UNITED ARAB EMIRATES
5	ALALI DANA		KUW - KUWAIT
7	MOHAMED MAYAR		UAE - UNITED ARAB EMIRATES
7	KANAN EMAN		UAE - UNITED ARAB EMIRATES
9	OUESLATI ISRAA		UAE - UNITED ARAB EMIRATES
9	MAHYOUB RAZAN		UAE - UNITED ARAB EMIRATES
11	MAHMOUD BISAN		UAE - UNITED ARAB EMIRATES
11	SAMSON ELIZABETH		UAE - UNITED ARAB EMIRATES
13	EHAB MALAK		UAE - UNITED ARAB EMIRATES
13	BHIDWAL FATIMA AAMIR		PAK - PAKISTAN
15	ALNAHAR SANA		UAE - UNITED ARAB EMIRATES
15	SAID SALMA		UAE - UNITED ARAB EMIRATES
17	BASUONI DEMA		UAE - UNITED ARAB EMIRATES
17	AASHER ALIZA		UAE - UNITED ARAB EMIRATES
19	NATH KIARA		UAE - UNITED ARAB EMIRATES
19	HAITHAM YARA		UAE - UNITED ARAB EMIRATES

KIDS KATA FEMALE 6 - 7 YEARS

1	ALHAJJAJ ALYAZIA		UAE - UNITED ARAB EMIRATES
2	KAMOUN MALAK		UAE - UNITED ARAB EMIRATES
3	ABDELSALAM ROKAIA		UAE - UNITED ARAB EMIRATES
3	BASUONI REEM		UAE - UNITED ARAB EMIRATES
5	HAMZA KHADEEJAH		UAE - UNITED ARAB EMIRATES
5	SHERIF DOUGANA		UAE - UNITED ARAB EMIRATES
7	GHANIM HALA		UAE - UNITED ARAB EMIRATES
7	ALQATTAN SARA		KUW - KUWAIT
9	AASHER AIZA		UAE - UNITED ARAB EMIRATES
9	ELSHABRAWY LINA		UAE - UNITED ARAB EMIRATES
11	SHAH AAIRA		UAE - UNITED ARAB EMIRATES
11	MAKKI SAFA		UAE - UNITED ARAB EMIRATES
13	ALSHAHRANI RANA		UAE - UNITED ARAB EMIRATES
13	IBRAHIM JOURY		UAE - UNITED ARAB EMIRATES
15	ALSHAHRANI SAMA		UAE - UNITED ARAB EMIRATES

KIDS KATA FEMALE 8 - 9 YEARS

1	KIBIREVA ALEXANDRA		RUS - RUSSIAN FEDERATION
2	TAREQ BERNADETTE		JOR - JORDAN
3	OUESLATI MILIA		UAE - UNITED ARAB EMIRATES
3	LOH CAYLA		UAE - UNITED ARAB EMIRATES





EMIRATES SPORTS KARATE OPEN - 2023-03-03



Official Results

5	SHERIF FARIDA		UAE - UNITED ARAB EMIRATES	
5	CABALLERO YVONNE BETHANY		PHI - PHILIPPINES	
7	KOVALEVSKAYA ANASTASSIYA		UAE - UNITED ARAB EMIRATES	
7	AL ALI AISHA		UAE - UNITED ARAB EMIRATES	
9	HATAM NOUF		UAE - UNITED ARAB EMIRATES	
9	ALADSANI NOURAH		KUW - KUWAIT	
11	SHAH AARIKA		UAE - UNITED ARAB EMIRATES	
13	ALALI FAJIR		UAE - UNITED ARAB EMIRATES	

KIDS KATA MALE 10 - 11 YEARS

1	RAZVALOV NIKOLAI		RUS - RUSSIAN FEDERATION	
2	AKHMETOV EVGENII		RUS - RUSSIAN FEDERATION	
3	EYAD ABDELHAMID SHAHAT AHMED YOUSSEF		UAE - UNITED ARAB EMIRATES	
3	MAJDI MOHAMED		UAE - UNITED ARAB EMIRATES	
5	KAMOUN MOHAMED		UAE - UNITED ARAB EMIRATES	
5	MATAR AHMED		UAE - UNITED ARAB EMIRATES	
7	MARANAN AMMIEL CHUA		UAE - UNITED ARAB EMIRATES	
7	CHANDRA KUMAR TARAN KRISHNA		UAE - UNITED ARAB EMIRATES	
9	AHMED GAMAL AHMED MOHAMED ABDELMOTELEB AMMAR		UAE - UNITED ARAB EMIRATES	
11	QUIME PIERRE GUSTAV		UAE - UNITED ARAB EMIRATES	
13	ALMALKI WALEED		KSA - SAUDI ARABIA	
15	SHARMA TANISH		UAE - UNITED ARAB EMIRATES	
17	ALSHAER YAHYA		UAE - UNITED ARAB EMIRATES	
19	ALI MEHRI		UAE - UNITED ARAB EMIRATES	
21	MISK FARIS		UAE - UNITED ARAB EMIRATES	
23	AYEDH H ABNDAJEM EMAD		UAE - UNITED ARAB EMIRATES	

KIDS KATA MALE 6 - 7 YEARS

1	RAMI BAHY		JOR - JORDAN	
2	ALJAZZAF ALI		KUW - KUWAIT	
3	ABDELSALAM HAMZA		UAE - UNITED ARAB EMIRATES	
3	ELFATEH AHMED		UAE - UNITED ARAB EMIRATES	
5	SHAKER ALEX MARK		UAE - UNITED ARAB EMIRATES	
5	AARON SALDANA ARTHUR		UAE - UNITED ARAB EMIRATES	
7	BEREZIN ANTON		RUS - RUSSIAN FEDERATION	
7	MALIK FAHAD		UAE - UNITED ARAB EMIRATES	
9	MAZDA ZAOSH		UAE - UNITED ARAB EMIRATES	
9	ALSUWAIDI SAIF		UAE - UNITED ARAB EMIRATES	
11	MAHMOUD YAZAN		UAE - UNITED ARAB EMIRATES	
11	SHENOY ATHARV		UAE - UNITED ARAB EMIRATES	
13	BEIG EMAAD		UAE - UNITED ARAB EMIRATES	
13	ABNDAEM LAYTH		UAE - UNITED ARAB EMIRATES	
15	AWAN RAYAAN		UAE - UNITED ARAB EMIRATES	
15	MOSTAFA ANAS		UAE - UNITED ARAB EMIRATES	
17	MOHAMED ABDELRAHMAN		UAE - UNITED ARAB EMIRATES	
17	KHAN SALAH		UAE - UNITED ARAB EMIRATES	





EMIRATES SPORTS KARATE OPEN - 2023-03-03



Official Results

19	ALKHALIDI SAIF		UAE - UNITED ARAB EMIRATES	
19	RIBHE MISK RAYAN		UAE - UNITED ARAB EMIRATES	
21	FAHMY YOUSEF		UAE - UNITED ARAB EMIRATES	

KIDS KATA MALE 8 - 9 YEARS

1	AL-SHOULI YOUSEF		QAT - QATAR	
2	Haidar Mohammad		KUW - KUWAIT	
3	ALSHWAIKER ABDULLAH		KUW - KUWAIT	
3	AKHMETOV EVGENII		RUS - RUSSIAN FEDERATION	
5	ALBLUSHI NASER		KUW - KUWAIT	
5	SULTAN AMMAR		UAE - UNITED ARAB EMIRATES	
7	Ehab Mohamed		UAE - UNITED ARAB EMIRATES	
7	ISSA HISHAM		UAE - UNITED ARAB EMIRATES	
9	RAMI DHAY		JOR - JORDAN	
9	ABDUGAFAROV KAMRONBEK		UAE - UNITED ARAB EMIRATES	
11	SORIANO AVERY ROSH		PHI - PHILIPPINES	
11	HAITHAM YASIN		UAE - UNITED ARAB EMIRATES	
13	ELGENDY OMAR		UAE - UNITED ARAB EMIRATES	
13	CROOX SCOTT CEASAR		PHI - PHILIPPINES	
15	TARIQ MOHAMED		UAE - UNITED ARAB EMIRATES	
15	ZAYAAN MUHAMMED		UAE - UNITED ARAB EMIRATES	
17	PRASAD RYAN		UAE - UNITED ARAB EMIRATES	
17	MAHYOUB HAMDAN		UAE - UNITED ARAB EMIRATES	
17	ARSHAD ZACKAREYA		UAE - UNITED ARAB EMIRATES	
17	MOKHTAR SAIF		UAE - UNITED ARAB EMIRATES	
21	MISK SAMER		UAE - UNITED ARAB EMIRATES	
21	GOHIL VIVAAN VAIBHAV		UAE - UNITED ARAB EMIRATES	
21	SELIM AMR SAYED ALY HANAFY		UAE - UNITED ARAB EMIRATES	
21	HAMZA GAMAL AHMED MOHAMED ABDELMOTELEB AMMAR		UAE - UNITED ARAB EMIRATES	
25	VIJEESH ARJIT		UAE - UNITED ARAB EMIRATES	
25	ASER ABDELHAMID SHAHAT AHMED YOUSSEF		UAE - UNITED ARAB EMIRATES	
25	CHOURASIA SAMYAK		UAE - UNITED ARAB EMIRATES	
25	AHMED JAZSER		UAE - UNITED ARAB EMIRATES	
29	KHAMMASH OWAIS		UAE - UNITED ARAB EMIRATES	
29	KHAJEH ROHAM		UAE - UNITED ARAB EMIRATES	
29	ADEM ELSAWY		UAE - UNITED ARAB EMIRATES	
29	ALMAZRUI LUAY		UAE - UNITED ARAB EMIRATES	
33	AFFANDY EHSAN		UAE - UNITED ARAB EMIRATES	
33	ALALI MAYED		UAE - UNITED ARAB EMIRATES	
33	OMAR EIAD		UAE - UNITED ARAB EMIRATES	
37	ABDELRAHMAN AMR MOHAMED ABDELRAHMAN EL SHABRAWY		UAE - UNITED ARAB EMIRATES	
37	ALGHFELI BUTI		UAE - UNITED ARAB EMIRATES	

KIDS KUMITE FEMALE 10 YEARS

1	MOHAMED MAYAR		UAE - UNITED ARAB EMIRATES	
---	---------------	--	----------------------------	--





EMIRATES SPORTS KARATE OPEN - 2023-03-03



Official Results

2	SINHA MANASVI		UAE - UNITED ARAB EMIRATES	
---	---------------	--	----------------------------	--

KIDS KUMITE FEMALE 11 YEARS

1	AHMED FARIDA		UAE - UNITED ARAB EMIRATES	
2	MOHAMED LAMAR		UAE - UNITED ARAB EMIRATES	
3	KHALID DANA		UAE - UNITED ARAB EMIRATES	
3	MAHYOUB RAZAN		UAE - UNITED ARAB EMIRATES	
5	MANNANOVA SAFIHA		RUS - RUSSIAN FEDERATION	
5	NADA AHMED ABDULLA KHAMEIS BINOWAISHO		UAE - UNITED ARAB EMIRATES	
7	KHALID MAHRA		UAE - UNITED ARAB EMIRATES	
7	GHUBASH AMAL		UAE - UNITED ARAB EMIRATES	

KIDS KUMITE FEMALE 7 YEARS

1	KARIMOVA MUSAINNA		RUS - RUSSIAN FEDERATION	
2	MC KINNON AMANDA		UAE - UNITED ARAB EMIRATES	

KIDS KUMITE FEMALE 8 YEARS

1	ALNOURASI JANA		UAE - UNITED ARAB EMIRATES	
2	AFFANDY EHSAN		UAE - UNITED ARAB EMIRATES	

KIDS KUMITE FEMALE 9 YEARS

1	YOUNES FAREDA		UAE - UNITED ARAB EMIRATES	
2	TAREQ BERNADETTE		JOR - JORDAN	
3	ELSHROMOLSY SAMA		UAE - UNITED ARAB EMIRATES	
3	ELAWADI ENJI		UAE - UNITED ARAB EMIRATES	
5	MAGBITANG MAEGAN JYLL		PHI - PHILIPPINES	
5	CABALLERO YVONNE BETHANY		PHI - PHILIPPINES	

KIDS KUMITE MALE 10 YEARS

1	ISMAYILOV MUSA		AZE - AZERBAIJAN	
2	SHULGIN LEV		RUS - RUSSIAN FEDERATION	
3	AMER SAIF YASER		UAE - UNITED ARAB EMIRATES	
3	GURBANLI ELДАР		AZE - AZERBAIJAN	
5	ALMURADLI SHAHIN		AZE - AZERBAIJAN	
5	SHORUSTAMOV DIYORBЕК		UZB - UZBEKISTAN	
7	MAJDI MOHAMED		UAE - UNITED ARAB EMIRATES	
7	ALI MAHMOD HAMDИ		QAT - QATAR	
9	MALIK FAISAL		UAE - UNITED ARAB EMIRATES	
9	AL KHRISHI KARAM MUNTASER FAWZI		UAE - UNITED ARAB EMIRATES	
11	YULDASHEV KOMRON		UZB - UZBEKISTAN	

KIDS KUMITE MALE 11 YEARS

1	ISMAIL ZIAD		UAE - UNITED ARAB EMIRATES	
2	ROOHI HOSSEIN		UAE - UNITED ARAB EMIRATES	
3	KOLTUKHCHIAN GOR		RUS - RUSSIAN FEDERATION	
3	ABDUNABIYEV TENGIZ		UZB - UZBEKISTAN	
5	ASEM AHMED MOHAMMAD ABU QORAH		UAE - UNITED ARAB EMIRATES	





EMIRATES SPORTS KARATE OPEN - 2023-03-03



Official Results

5	JARROUCHE JASON		UAE - UNITED ARAB EMIRATES	
7	MOHAMED OSAMA ISMAIL FAWZI ISMAIL		UAE - UNITED ARAB EMIRATES	
7	RAIMBERDIYEV SUHROBEEK		UZB - UZBEKISTAN	

KIDS KUMITE MALE 7 YEARS

1	OLIMJONOV ZIYODULLA		UZB - UZBEKISTAN	
2	MUHAMMAD SADINOV		UZB - UZBEKISTAN	
3	MUNJE NIADH		UAE - UNITED ARAB EMIRATES	
3	ALDROOS RASHID		UAE - UNITED ARAB EMIRATES	
5	RAJAB HAMZA		KUW - KUWAIT	
5	NEMATOV IMRON		UZB - UZBEKISTAN	
7	ALJAZZAF ALI		KUW - KUWAIT	
7	RAJESH RISHIE		UAE - UNITED ARAB EMIRATES	

KIDS KUMITE MALE 8 YEARS

1	KHAKIMOV BOBUR		UZB - UZBEKISTAN	
2	IBRAGIMOV ZUBAIR		UZB - UZBEKISTAN	
3	ALNAJEM ABDULATEEF		KUW - KUWAIT	
3	HUSAIN MOHAMMAD		KUW - KUWAIT	
5	IBRAHIM MOWMEN		SUD - SUDAN	
5	ALBAID YAQOUB		KUW - KUWAIT	
7	PATIL ARAV		UAE - UNITED ARAB EMIRATES	
7	ELDAOUDI ADAM		UAE - UNITED ARAB EMIRATES	
9	ALHAMMADI SAUD		UAE - UNITED ARAB EMIRATES	

KIDS KUMITE MALE 9 YEARS

1	ALBOURM ABDULLAH		UAE - UNITED ARAB EMIRATES	
2	SULTAN AMMAR		UAE - UNITED ARAB EMIRATES	
3	MADALIYEV TIMUR		UZB - UZBEKISTAN	
3	ALSHWAIKER ABDULLAH		KUW - KUWAIT	
5	ABBAS HAMAD		KUW - KUWAIT	
5	ШОХРУЗ АЛИМЖАHOВ		UZB - UZBEKISTAN	
7	ZAHNOUNI AHMED		UAE - UNITED ARAB EMIRATES	
7	SADIKOV SAIDBEK		UZB - UZBEKISTAN	
9	SATHISH MITHIRAN		UAE - UNITED ARAB EMIRATES	

Senior kata female

1	SHCHERBINA ANNA		RUS - RUSSIAN FEDERATION	
2	FILIUKOVA NATALIA		RUS - RUSSIAN FEDERATION	
3	BARAVIK VERANIKA		BLR - BELARUS	
3	KHOZYAEVA VALERIYA		RUS - RUSSIAN FEDERATION	
5	ZOTOVA MARIA		RUS - RUSSIAN FEDERATION	
5	VERMA AKANKSHA		IND - INDIA	
7	SHRESTHA SHARMILA		UAE - UNITED ARAB EMIRATES	
7	NAZOURI MOJDEH		UAE - UNITED ARAB EMIRATES	
9	KAMAL SUMIYA		UAE - UNITED ARAB EMIRATES	
9	HAMZA ANSHIDA		UAE - UNITED ARAB EMIRATES	





EMIRATES SPORTS KARATE OPEN - 2023-03-03



Official Results

11	WAHIDI ZAINAB		KUW - KUWAIT	
11	SHAH ABBAS ALI BUSHRA		UAE - UNITED ARAB EMIRATES	

Senior kata male

1	LARIN IVAN		RUS - RUSSIAN FEDERATION	
2	SAIDU SAMROOD		UAE - UNITED ARAB EMIRATES	
3	T R VISHNU		UAE - UNITED ARAB EMIRATES	
3	KARIM WAEL MOHAMED ABDULAZIM		UAE - UNITED ARAB EMIRATES	
5	THARINDU DIMANTHA		UAE - UNITED ARAB EMIRATES	
5	WADEE ABU WAKIM		UAE - UNITED ARAB EMIRATES	
7	GUPTA ANIKET		IND - INDIA	
7	K T MUZAMMIL		UAE - UNITED ARAB EMIRATES	
9	HAMZA WALEED		UAE - UNITED ARAB EMIRATES	
9	HUSAIN MEQDAD		KUW - KUWAIT	

SENIOR KUMITE FEMALE -50 KG

1	GRIGOREVA ELIZAVETA		RUS - RUSSIAN FEDERATION	
2	SHRESTHA SONU		NEP - NEPAL	
3	BASNET PREETI		UAE - UNITED ARAB EMIRATES	
3	VERMA AKANKSHA		IND - INDIA	
5	YOUSIF SHANBAIH FATIMA		BRN - BAHRAIN	

SENIOR KUMITE FEMALE -55 KG

1	CHERNYSHEVA ANNA		RUS - RUSSIAN FEDERATION	
2	PEREVOZCHIKOVA ANNA		RUS - RUSSIAN FEDERATION	
3	OZODA NURIDINOVA		RUS - RUSSIAN FEDERATION	
3	SHARYKHINA IRINA		BLR - BELARUS	
5	MECHERYAKOVA MARGARITA		RUS - RUSSIAN FEDERATION	
5	WAIBA SUSMITA		NEP - NEPAL	

SENIOR KUMITE FEMALE -61 KG

1	STAROSELTSEVA MILANA		RUS - RUSSIAN FEDERATION	
2	RODINA ANNA		RUS - RUSSIAN FEDERATION	
3	AZARAVA MARYIA		BLR - BELARUS	
3	KHOKHLOVA KARINA		RUS - RUSSIAN FEDERATION	
5	FATIMA KANEEZ		UAE - UNITED ARAB EMIRATES	

SENIOR KUMITE FEMALE -68 KG

1	MESHKOVA ALEKSANDRA		RUS - RUSSIAN FEDERATION	
2	ALDROOS JOUD		UAE - UNITED ARAB EMIRATES	
3	KUDRIAVTSEVA ANNA		RUS - RUSSIAN FEDERATION	
3	STADNIK VALERIIA		RUS - RUSSIAN FEDERATION	
5	ALIAKSEYEVA MARYIA		BLR - BELARUS	

SENIOR KUMITE FEMALE 68+ KG

1	KHALIMOVA SUNITA		RUS - RUSSIAN FEDERATION	
2	DHUNGEL ROJITA		NEP - NEPAL	





EMIRATES SPORTS KARATE OPEN - 2023-03-03



Official Results

SENIOR KUMITE MALE -60 KG

1	MELYOKHIN OLEG		BLR - BELARUS	
2	ABDELMENEM BRAA		EGY - EGYPT	
3	SHRESTHA NAVARAJ		UAE - UNITED ARAB EMIRATES	
3	ALIKHADZHIEV KERIM		RUS - RUSSIAN FEDERATION	
5	KV ANJUNATH		UAE - UNITED ARAB EMIRATES	
5	NEPAL PREM PRASAD		NEP - NEPAL	

SENIOR KUMITE MALE -67 KG

1	AKHMEDOV AKHMED		RUS - RUSSIAN FEDERATION	
2	NOURELDIN MOHMED		UAE - UNITED ARAB EMIRATES	
3	KV JAMSHAD		UAE - UNITED ARAB EMIRATES	
3	USMAN NAFIH		UAE - UNITED ARAB EMIRATES	
5	KHEIDRI MOUNIR		UAE - UNITED ARAB EMIRATES	

SENIOR KUMITE MALE -75 KG

1	NHUYEN DEVID		BLR - BELARUS	
2	GABER MAHMOUD		UAE - UNITED ARAB EMIRATES	
3	SHARAFUTDINOV ERNEST		RUS - RUSSIAN FEDERATION	
3	SARKHOUH ABBAS		KUW - KUWAIT	
5	SAH SHREE KISHUN		NEP - NEPAL	
5	HUSSAIN ISABIN		UAE - UNITED ARAB EMIRATES	

SENIOR KUMITE MALE -84 KG

1	MAMMADOV SAMIR		AZE - AZERBAIJAN	
2	ALHARBI JABER		KUW - KUWAIT	

SENIOR KUMITE MALE 84+ KG

1	KAMYSHOV DANIIL		RUS - RUSSIAN FEDERATION	
2	TAMANG AMRIT		NEP - NEPAL	
3	THAPA MOHANLAL		NEP - NEPAL	
3	BELONOGOV KIRILL		RUS - RUSSIAN FEDERATION	
5	KOVALEV KIRILL		RUS - RUSSIAN FEDERATION	

U14 Kata Female

1	RAO VAANYA		IND - INDIA	
2	PIRIAZEVA VIKTORIIA		RUS - RUSSIAN FEDERATION	
3	TAREQ LEMAR		JOR - JORDAN	
3	ABDURAIMOVA MUSHTARIY		UZB - UZBEKISTAN	
5	SALAH DENA		UAE - UNITED ARAB EMIRATES	
5	ALZGHOUL RASEEL		UAE - UNITED ARAB EMIRATES	
7	BAYANI CHANTAL YURI		PHI - PHILIPPINES	
7	ZAMORA STELLA MARIS		UAE - UNITED ARAB EMIRATES	
9	HASSAN HAIQA		UAE - UNITED ARAB EMIRATES	
9	MATAR JANA		UAE - UNITED ARAB EMIRATES	
11	HATAM HUDA		UAE - UNITED ARAB EMIRATES	





EMIRATES SPORTS KARATE OPEN - 2023-03-03



Official Results

11	RAJESH RUDHRA		UAE - UNITED ARAB EMIRATES	
13	SHINEDAS SERAH		UAE - UNITED ARAB EMIRATES	
15	AHMED FARIDA		UAE - UNITED ARAB EMIRATES	
17	JILLIAN MAYZEE		UAE - UNITED ARAB EMIRATES	

U14 Kata Male

1	DALATI HAMZA		EGY - EGYPT	
2	AHMADI ALI		KUW - KUWAIT	
3	BOIKO IVAN		RUS - RUSSIAN FEDERATION	
3	RAZVALOV NIKOLAI		RUS - RUSSIAN FEDERATION	
5	ZHADANOV EVGENII		RUS - RUSSIAN FEDERATION	
5	AYMAN MOUSA MOHANAD		BRN - BAHRAIN	
7	ALMOMANI YOUSEF ISSAM AREF		UAE - UNITED ARAB EMIRATES	
7	PEREVOZCHIKOV TIMUR		RUS - RUSSIAN FEDERATION	
9	SANDESH SRAAVAN		UAE - UNITED ARAB EMIRATES	
9	CRUZ ZACH HASHLEE		PHI - PHILIPPINES	
11	ALRASHID ABULMALIK		UAE - UNITED ARAB EMIRATES	
11	SALCEDO TRISTAN LUIS RAPHAEL		PHI - PHILIPPINES	
13	ABDELHAMID SAYED		UAE - UNITED ARAB EMIRATES	
13	ISHAN KUNNATH ISHAN		UAE - UNITED ARAB EMIRATES	
15	CROOX MICHAEL JOHANN		PHI - PHILIPPINES	
15	FEKKAS NIKOLAOS		UAE - UNITED ARAB EMIRATES	
17	CABALLERO ETHAN CHRISTOPHER		PHI - PHILIPPINES	
17	ALGHFELI AHMED		UAE - UNITED ARAB EMIRATES	
19	RENGARAJ ROSHAN		UAE - UNITED ARAB EMIRATES	

U14 KUMITE FEMALE -42 KG

1	ORABI RAGHD		UAE - UNITED ARAB EMIRATES	
2	HATAM HUDA		UAE - UNITED ARAB EMIRATES	
3	HASSAN HAIQA		UAE - UNITED ARAB EMIRATES	
3	BILAL BUDOOR		UAE - UNITED ARAB EMIRATES	
5	ALNOURASI MENNA		UAE - UNITED ARAB EMIRATES	

U14 KUMITE FEMALE -47 KG

1	LABATSEVICH ALINA		RUS - RUSSIAN FEDERATION	
2	YASER HABIBA		UAE - UNITED ARAB EMIRATES	

U14 KUMITE FEMALE -52 KG

1	MURSALOVA KHADIJA		AZE - AZERBAIJAN	
2	YAQOOB MAHRA		UAE - UNITED ARAB EMIRATES	
3	IBRAHIM HAYA		UAE - UNITED ARAB EMIRATES	
3	BENZEROUAL MERIEM		UAE - UNITED ARAB EMIRATES	
5	RAO VAANYA		IND - INDIA	

U14 KUMITE FEMALE 52+ KG

1	DANILOVA SOFIA		RUS - RUSSIAN FEDERATION	
2	KHALIL HIND		UAE - UNITED ARAB EMIRATES	





EMIRATES SPORTS KARATE OPEN - 2023-03-03



Official Results

3	MOHAMED ZAINA ABOBAKR		UAE - UNITED ARAB EMIRATES	
3	FATHY MOHAMED AYA		UAE - UNITED ARAB EMIRATES	
5	BAYANI CHANTAL YURI		PHI - PHILIPPINES	
5	ABU AL HAJ LAYAN OSAMA		UAE - UNITED ARAB EMIRATES	

U14 KUMITE MALE +55 KG

1	GOMAA YOUSIF		UAE - UNITED ARAB EMIRATES	
2	ABBASLI AMIL		AZE - AZERBAIJAN	
3	TUMINOV MATVEI		RUS - RUSSIAN FEDERATION	
3	AYMAN MOUSA MOHANAD		BRN - BAHRAIN	
5	ELSAYED AHMED		UAE - UNITED ARAB EMIRATES	
5	MOHAMMAD DHAHER HASHEM		QAT - QATAR	
7	ABDELKAREEM ALI MOHAMED		SUD - SUDAN	
7	KHALID AHMED		UAE - UNITED ARAB EMIRATES	

U14 KUMITE MALE -40 KG

1	KAMALDINOV ZAMIL		RUS - RUSSIAN FEDERATION	
2	ZHADANOV EVGENII		RUS - RUSSIAN FEDERATION	
3	PEREVOZCHIKOV TIMUR		RUS - RUSSIAN FEDERATION	
3	ABDELRAHIM ABDULAZIZ		UAE - UNITED ARAB EMIRATES	
5	ABOUELYAZEID RAAFAT		UAE - UNITED ARAB EMIRATES	
5	NABIYEV TURAL		AZE - AZERBAIJAN	
7	ALKOKHARDI ABDALLA		UAE - UNITED ARAB EMIRATES	
7	AHMADI ALI		KUW - KUWAIT	

U14 KUMITE MALE -45 KG

1	ALMOMANI YOUSEF ISSAM AREF		UAE - UNITED ARAB EMIRATES	
2	MOHAMED ALI MOHAMED EISA ALBLOOSHI		UAE - UNITED ARAB EMIRATES	
3	ALI KHALID ALI ELHAJ		UAE - UNITED ARAB EMIRATES	
3	RAYAN RAED AZMI ABU MOWAIS		UAE - UNITED ARAB EMIRATES	
5	SOHALI IBRAHIM		UAE - UNITED ARAB EMIRATES	
5	ALZGHOUL AIHAM		UAE - UNITED ARAB EMIRATES	
7	SHOWAITER ZAKARIYA		BRN - BAHRAIN	

U14 KUMITE MALE -50 KG

1	ELGENDY ALI		UAE - UNITED ARAB EMIRATES	
2	SALEM AHMED ABDULLA KHAMEIS BINOWAISHO		UAE - UNITED ARAB EMIRATES	
3	SANKAR ARJUNA		UAE - UNITED ARAB EMIRATES	
3	ALHAJJAJ KHALIFA		UAE - UNITED ARAB EMIRATES	
5	HUSEYNZADE ALI		AZE - AZERBAIJAN	

U14 KUMITE MALE -55 KG

1	SHAISHIAN LEVON		RUS - RUSSIAN FEDERATION	
2	AZIZLI VUGAR		AZE - AZERBAIJAN	
3	KHALID ABDALLA SALIM ABDALLA ALKINDI		UAE - UNITED ARAB EMIRATES	
3	STANICHNOV KIRILL		RUS - RUSSIAN FEDERATION	





EMIRATES SPORTS KARATE OPEN - 2023-03-03



Official Results

5	ZADA HUSSEYN		UAE - UNITED ARAB EMIRATES	
5	ALKHALDI FAISAL		UAE - UNITED ARAB EMIRATES	
7	NAJI QAHTAN		UAE - UNITED ARAB EMIRATES	





EMIRATES SPORTS KARATE OPEN - 2023-03-03



Medals - Nation

Rank	Nation	1. Place	2. Place	3. Place
1	RUSSIAN FEDERATION, RUS	22	10	21
2	UNITED ARAB EMIRATES, UAE	21	31	52
3	AZERBAIJAN, AZE	5	3	4
4	JORDAN, JOR	3	3	2
5	EGYPT, EGY	3	1	2
6	UZBEKISTAN, UZB	2	2	3
7	BELARUS, BLR	2	0	3
8	INDIA, IND	1	1	2
9	SAUDI ARABIA, KSA	1	0	0
	QATAR, QAT	1	0	0
11	KUWAIT, KUW	0	5	6
12	NEPAL, NEP	0	4	1
13	ALGERIA, ALG	0	1	0
14	PHILIPPINES, PHI	0	0	2
15	SUDAN, SUD	0	0	1
	BAHRAIN, BRN	0	0	1

