



Lista ufficiale dei risultati

15-FRQ_ESORDIENTI_KA_KU KARATE CAMPANIA - 2024-05-12

ESORDIENTI F KATA

Cl.	Atleta		Società		P.ti
1	MERCURIO PUELLA ANNA	2012-11-12	POL BELLIZZI	15SA2188	10
2	NUZZO ALESSANDRA	2011-02-08	UNION TEAM	15CE2566	8
3	IANNONE ANDREANA	2011-07-13	LIFE CHAMPION	15CE4497	6
3	GUALBERTI MELANIE	2012-09-12	LIFE CHAMPION	15CE4497	6
5	LARA VIOLA	2011-08-12	UN.TEAM	15NA4711	4
5	CIFELLI SARA	2011-04-13	UN.TEAM	15NA4711	4
7	PETRUZZIELLO SOPHIE GIORGIA	2012-09-25	TEAM CAPASSO	15CE3074	2
7	ANGELLOTTI ARIANNA	2011-11-25	UN.TEAM	15NA4711	2
11	PALENI GIULIA	2012-09-15	GYM & FITNESS	15CE4455	1
11	DELLI PAOLI ANGELA	2011-10-11	ASD ARTIDASIA	15CE3799	1
11	CORSINI ANGELA	2011-05-17	KARATE SALERNO	15SA4272	1

ESORDIENTI F KUMITE 35 KG

Cl.	Atleta		Società		P.ti
1	ARENA BENEDETTA	2012-01-20	PIELLE CE	15CE4031	10
2	ESPOSITO ANNA SOFIA	2012-10-12	KARATE CENTER	15NA4271	8
3	RUSSO FRANCESCA	2011-06-22	MASAKADO	15AV5013	6
3	PISANO FEDERICA	2012-11-25	POL BELLIZZI	15SA2188	6
5	STOPPELLI IRENE	2012-02-11	ENDURANCE CLUB	15NA3506	4

ESORDIENTI F KUMITE 40 KG

Cl.	Atleta		Società		P.ti
1	NEGRONE VIVIANA	2011-04-01	SHIZOKU KRT AV	15AV0209	10
2	CAPECE GINEVRA OLIMPIA	2012-10-13	YOSHITAKA KARAT	15BN4040	8
3	PANTALEO ALICE MARIA	2012-08-27	KIR ROYAL	15SA3308	6
3	CUCCI ALESSIA	2012-05-13	POL BELLIZZI	15SA2188	6
5	CIOFFI ILENIA	2012-12-05	SHIRAI CLUB	15SA1180	4
5	MEGALE ALESSANDRA	2012-12-22	PIELLE CE	15CE4031	4
7	LAMBERTI MARIA PAOLA	2012-12-19	POL BELLIZZI	15SA2188	2
7	MILO ELEONORA	2012-08-16	OKINAWA KRTCLUB	15NA3850	2
11	RAPPOLLA EMMA	2012-09-21	BODY FORM	15NA5106	1
11	SCHIANO ILARIA	2012-06-12	SPORT E KARATE	15NA3847	1
11	CARUSO FABIANA	2011-09-18	ENDURANCE CLUB	15NA3506	1
11	PIROZZI ELISABETTA	2012-11-28	ENDURANCE CLUB	15NA3506	1
11	SCHIANO GIULIA	2012-06-12	SPORT E KARATE	15NA3847	1

ESORDIENTI F KUMITE 45 KG

Cl.	Atleta		Società		P.ti
1	TODESCA CARMEN	2011-03-02	SHIZOKU KRT AV	15AV0209	10
2	ELAUNI FATIMA	2011-10-08	KARATE AND RESP	15NA3808	8
3	VAIANO GIORGIA	2011-09-18	ASD EVER GREEN	15NA2187	6
3	PYLYPIV DARINA	2012-09-28	ASDLENEA	15SA2185	6
5	RAGONE BENEDETTA	2012-06-11	DANDREA KARATE	15SA3600	4

ESORDIENTI F KUMITE 50 KG					
Cl.	Atleta		Società		P.ti
1	SPINA AURORA	2011-08-13	SHIZOKU KRT AV	15AV0209	10
2	ACERNESE CAMILLA	2012-02-09	SHIZOKU KRT AV	15AV0209	8
3	GIORDANO MORENA	2012-04-20	SHIRAI CLUB	15SA1180	6
3	PIGNATIELLO ROBERTA	2011-11-14	UNIVERSAL CENTE	15NA1862	6
5	MASULLO GAIA	2011-11-07	GEN K	15NA3929	4
5	DE LUCA GINEVRA	2011-06-19	KARATE CENTER	15NA4271	4
7	AIESE FEDERICA	2011-12-01	NAPOLI TOKYO	15NA4085	2
7	CORRADO TULLIA	2011-01-13	SHIRAI CLUB	15SA1180	2
7	RASCATO VERONICA	2011-10-04	ASD EVER GREEN	15NA2187	2
7	DI TARANTO FRANCESCAPIA	2011-05-16	POL BELLIZZI	15SA2188	2
11	CRESCENZO MYRELA ANNA	2011-06-03	SHIRAI CLUB	15SA1180	1
11	MARINIELLO ILARIA	2011-07-28	ASDLENEA	15SA2185	1
11	NATALE CONCETTA	2011-09-23	CHAMPION CENTER	15NA1486	1
11	URSILLO PATRIZIA	2012-08-08	ASDLENEA	15SA2185	1
11	BUCCELLI GINEVRA	2012-05-01	GEN K	15NA3929	1
11	CALIFANO VALENTINA	2012-08-13	SPORTING SAMURA	15SA4666	1
11	ROBILOTTA REBECCA ANNASOFIA	2012-10-27	FITNESS VILLAGE	15NA0896	1
11	PANARO CHIARA	2012-01-23	UNIVERSAL CENTE	15NA1862	1
11	ORSINI LUDOVICA	2012-11-13	SHIRAI CLUB	15SA1180	1
11	PALUMBO GAIA	2011-05-10	BODY FORM	15NA5106	1
11	DE CRISTOFARO MARTINA	2011-10-12	NEW TOP LINE	15CE4044	1
11	CAMELE GIORGIA	2012-06-15	ENDURANCE CLUB	15NA3506	1
11	AMATO ANGELICA	2012-12-24	SHIRAI CLUB	15SA1180	1
11	DERRICO MATILDE	2012-02-04	KARATE AND RESP	15NA3808	1

ESORDIENTI F KUMITE 56 KG					
Cl.	Atleta		Società		P.ti
1	MEROLA SERENA	2011-09-13	GYM & FITNESS	15CE4455	10
2	PETTI ANTONIA	2011-12-12	SPORTING SAMURA	15SA4666	8
3	TOMASETTA GAIA	2011-06-06	SHIZOKU KRT AV	15AV0209	6
3	INGENITO GAIA	2011-08-08	SHIRAI CLUB	15SA1180	6
5	VITAGLIANO LILIANA	2011-01-04	KARATE AND RESP	15NA3808	4
5	DUBBIOSI AURORA	2011-06-25	SHIZOKU KRT AV	15AV0209	4
7	DE MICCO ALESSANDRA	2012-03-30	SHIZOKU KRT AV	15AV0209	2
7	RONGA MARTINA	2011-02-16	TEAM CAPASSO	15CE3074	2
7	CITTADINO ROBERTA	2011-11-14	NAPOLI TOKYO	15NA4085	2
11	PANDOLFI SCIALO ANGUIE PAOLA	2011-01-06	KDK SPORT NA	15NA0135	1

ESORDIENTI F KUMITE 62 KG					
Cl.	Atleta		Società		P.ti
1	FINIZIO MAYA	2011-01-13	KARATE SALERNO	15SA4272	10
2	COTUMACCIO ROBERTA	2011-10-12	ASDLENEA	15SA2185	8
3	BOVE CHIARA	2012-04-12	NADIR T.D.	15SA4412	6
3	ROBILOTTA NOEMI	2011-03-28	FITNESS VILLAGE	15NA0896	6

ESORDIENTI F KUMITE 68 KG					
Cl.	Atleta		Società		P.ti
1	PISCITELLI ARIANNA	2011-02-01	UNION TEAM	15CE2566	10
2	SIEYES SABINA	2011-05-22	ENDURANCE CLUB	15NA3506	8
3	PISCOPO ANGELA	2011-11-10	GOLDEN T.	15NA4721	6

ESORDIENTI F KUMITE 68+ KG					
Cl.	Atleta		Società		P.ti
1	CANGIANO ANGELA	2012-10-18	UNIVERSAL CENTE	15NA1862	10

ESORDIENTI M KATA					
Cl.	Atleta		Società		P.ti
1	MARCHETTI ENRICO	2011-09-14	KARATE SALERNO	15SA4272	10
2	LAMBERTI GIANCARMINE	2011-09-10	P.BUSHIDO	15NA4880	8
3	BENEDUCE SIMONE	2012-10-05	UNION TEAM	15CE2566	6
3	MARTINISI GUIDO	2012-03-14	UNION TEAM	15CE2566	6
5	RIPOSO FRANCESCO	2012-03-03	UNION TEAM	15CE2566	4
5	SALVATI PAOLO	2012-11-26	UNION TEAM	15CE2566	4
7	COZZOLINO ANIELLO	2012-09-13	UNION TEAM	15CE2566	2
7	ARRICHELLO ARMANDO	2011-12-14	TEAM CAPASSO	15CE3074	2
7	LOMBARDI VINCENZO	2012-10-09	TIGERS STYLE	15CE4145	2
7	GIORDANO ANTONIO	2012-05-14	GEN K	15NA3929	2
11	MIDAGLIA LIVIO ALBERTO	2011-02-09	KARATE SALERNO	15SA4272	1
11	FEDELE FRANCESCO	2012-02-08	TEAM CAPASSO	15CE3074	1
11	CAPASSO FRANCESCO	2012-01-02	TEAM CAPASSO	15CE3074	1
11	ALAIA CRISTIAN LEONARDO	2011-03-01	UNION TEAM	15CE2566	1
11	TULLIO SALVATORE	2012-12-27	TEAM CAPASSO	15CE3074	1
11	GRANA TONINO	2011-11-07	P.BUSHIDO	15NA4880	1
11	ALMA FRANCESCO	2011-08-17	KRTFRATTAMINORE	15NA0930	1

ESORDIENTI M KUMITE 38 KG					
Cl.	Atleta		Società		P.ti
1	MOFFA ANTONIO	2012-05-02	OLYMPIC PLANET	15SA1332	10
2	SCALA GIAU ANTONIO PAOLO	2011-01-17	BUSHINKAI	15CE4786	8
3	DUBBIOSI LUIGI	2012-07-29	SHIZOKU KRT AV	15AV0209	6
3	TODESCA ALFONSO	2011-03-02	SHIZOKU KRT AV	15AV0209	6
5	LANDOLFI DIEGO	2012-10-12	CSKI AIROLA	15BN4198	4
5	SAULLE LORENZO	2011-11-04	KARATE SALERNO	15SA4272	4
7	CARRATU DOMENICO	2012-05-24	POL BELLIZZI	15SA2188	2
7	MARIGLIANO GAETANO	2012-09-24	KDK SPORT NA	15NA0135	2
7	AMENDOLA LOIGI	2011-11-25	APDMOSCATI	15NA4298	2
7	SPITALETTA GIULIO	2011-12-06	CSKI AIROLA	15BN4198	2
11	LEPRE LUIGI	2011-11-02	ASDLENEA	15SA2185	1
11	DI BIASE LUIGI	2012-09-25	NAPOLI TOKYO	15NA4085	1
11	CASTELLONE LORENZO	2012-01-30	UNIVERSAL CENTE	15NA1862	1
11	SENAPE CHRISTIAN	2012-05-31	BUSHINKAI	15CE4786	1
11	BALZANO MICHAEL	2012-03-20	APDMOSCATI	15NA4298	1
11	TRAPANI GIUSEPPE	2011-11-09	UNIVERSAL CENTE	15NA1862	1
11	DANTUONO PIETRO	2012-02-07	DANDREA KARATE	15SA3600	1
11	DALBERO PASQUALE	2012-11-25	SHIRAI CLUB	15SA1180	1

ESORDIENTI M KUMITE 43 KG					
Cl.	Atleta		Società		P.ti
1	CANTONE LUIGI	2011-02-03	NEW DYNAMIC	15CE3875	10
2	TALEVI FRANCESCO	2011-08-27	KIR ROYAL	15SA3308	8
3	CONSAGNA SALVATORE	2012-12-06	SHIRAI CLUB	15SA1180	6
3	CASANOVA FRANCESCO PIO	2012-03-13	CHAMPION CENTER	15NA1486	6
5	VISIELLO KRISTIAN	2012-07-25	ASD EVER GREEN	15NA2187	4
5	RUSSO ANDREA	2011-12-28	SHIRAI CLUB	15SA1180	4
7	PECORARO ANDREA	2011-07-30	KDK SPORT NA	15NA0135	2
7	MIGLIORINI SAMUELE	2011-09-01	CSKI AIROLA	15BN4198	2
7	SIANO ENRICO	2011-05-27	KIR ROYAL	15SA3308	2
7	TARANTINO COSTANTINO	2012-03-02	SHIZOKU KRT AV	15AV0209	2
11	RUSSO VINCENZO	2012-07-01	GOLDEN T.	15NA4721	1
11	MARTINO VITTORIO	2012-01-26	SPORTING SAMURA	15SA4666	1
11	FALZARANO GENNARO	2011-03-25	CSKI AIROLA	15BN4198	1
11	SETARO MATTEO	2011-10-11	ASDLENEA	15SA2185	1
11	MEGALE ANTONINO	2011-11-03	PIELLE CE	15CE4031	1
11	CRISPINO ANTONIO	2012-02-15	GOLDEN T.	15NA4721	1
11	LAMBIASE NICOLÒ	2011-08-03	NADIR T.D.	15SA4412	1
11	MARTINO MATTIA	2011-05-26	PROJECT GYM	15NA2157	1

Lista ufficiale dei risultati / 15-FRQ_ESORDIENTI_KA_KU KARATE CAMPANIA - 2024-05-12

11	GRIMALDI ANTONIO	2011-12-02	NADIR T.D.	15SA4412	1
11	ANGELINO ARCANGELO	2012-03-13	CHAMPION CENTER	15NA1486	1
11	CICCHELLA GIANLUCA	2012-07-31	FITNESS VILLAGE	15NA0896	1
11	CARBONE FLAVIO	2011-05-21	IGEA WELLNESS	15NA0489	1
11	GESUELE LORENZO	2011-11-17	C.S. POMILIA	15NA0363	1
11	DANNA FEDERICO	2012-04-20	GEN K	15NA3929	1
11	CARBONE PAOLO	2012-07-10	KDK SPORT NA	15NA0135	1
11	TROTTA CARMINE	2011-07-17	GEN K	15NA3929	1
11	FORTUNATO GIANLUCA	2012-03-07	MASAKADO	15AV5013	1
11	MASTROGIACOMO MARIOPIO	2011-02-24	POL BELLIZZI	15SA2188	1
11	DI BERNARDO CHRISTIAN	2012-10-10	SPORT E KARATE	15NA3847	1
11	ESPOSITO ANTONINO	2011-04-12	KARATE CENTER	15NA4271	1

ESORDIENTI M KUMITE 48 KG

Cl.	Atleta		Società		P.ti
1	MOCCIA GAETANO	2011-10-01	NAPOLI TOKYO	15NA4085	10
2	MARINIELLI PIETRO	2011-06-10	KARATE AND RESP	15NA3808	8
3	DI GUIDA FERDINANDO	2011-12-31	CHAMPION CENTER	15NA1486	6
3	PAGLIONICO VITTORIO	2011-10-06	CHAMPION CENTER	15NA1486	6
5	CARRIOLA PAOLO	2011-01-19	HINNA MAC 82	15NA3942	4
5	SBRIGLIA ANDREA	2011-01-07	CHAMPION CENTER	15NA1486	4
7	CARBONE VITTORIO	2011-05-21	IGEA WELLNESS	15NA0489	2
7	CHIAVAZZO LUIGI	2011-05-13	NADIR T.D.	15SA4412	2
7	FAYE MOHAMED FALLOU	2012-12-10	KARATE CENTER	15NA4271	2
7	CASTAGNOZZI CRISTIAN	2011-03-29	BUSHINKAI	15CE4786	2
11	VERGATI FRANCESCO	2011-04-04	ASDLENEA	15SA2185	1
11	MOSCATO GIANPAOLO	2012-04-11	GOLDEN T.	15NA4721	1
11	DE LUCA LORENZO	2011-01-18	SHIZOKU KRT AV	15AV0209	1
11	DURSO PAOLO	2012-01-12	MASAKADO	15AV5013	1
11	DI MAIO DI MARO GIONA	2011-09-03	NAPOLI TOKYO	15NA4085	1
11	NOBILE SIMONE	2012-08-07	YOSHITAKA KARAT	15BN4040	1
11	FLORIO FRANCESCO	2012-02-20	TEAM CAPASSO	15CE3074	1
11	ESPOSITO ERNESTH	2012-01-20	OKINAWA KRTCLUB	15NA3850	1
11	VOLPE MARIO	2012-10-22	CHAMPION CENTER	15NA1486	1
11	CESA CHRISTIAN	2011-12-25	NAPOLI TOKYO	15NA4085	1
11	INGINO ANTONIO	2011-08-12	TREZZA	15SA4806	1
11	RUFFO ANTONIO GIOVANNI	2012-07-22	BUSHINKAI	15CE4786	1
11	WATERS FRANCESCO ALEXANDER	2011-07-18	TEAM CAPASSO	15CE3074	1
11	ESPOSITO GENNARO	2012-12-30	SHIRAI CLUB	15SA1180	1
11	AVERSANO RAFFAELE	2011-03-30	TEAM CAPASSO	15CE3074	1
11	MAZZOLA ANTONINO	2011-12-23	KARATE CENTER	15NA4271	1
11	GRECO GABRIEL	2012-04-11	NAPOLI TOKYO	15NA4085	1
11	RISPO ANTONIO	2012-10-13	ASDLENEA	15SA2185	1
11	SORRENTINO UMBERTO	2012-07-27	KARATE CENTER	15NA4271	1

ESORDIENTI M KUMITE 53 KG

Cl.	Atleta		Società		P.ti
1	ANNUNZIATA DAVIDE	2011-10-14	UN.TEAM	15NA4711	10
2	BRUSCO GIUSEPPE	2012-02-08	NAPOLI TOKYO	15NA4085	8
3	GALDIERI MATTEO	2011-02-25	CHAMPION CENTER	15NA1486	6
3	RUSSOMANNO EMANUELE	2011-11-10	SHIRAI CLUB	15SA1180	6
5	DIANA GIUSEPPE	2012-05-02	TEAM CAPASSO	15CE3074	4
5	MONA DARIO	2011-10-11	NAPOLI TOKYO	15NA4085	4
7	PICARDI MATTIA	2012-07-11	SHIZOKU KRT AV	15AV0209	2
7	SCOTILLO MARIO	2011-10-26	GSK BRACCIANTE	15SA3982	2
7	BASCIANO PIETRO	2011-10-17	KDK SPORT NA	15NA0135	2
7	MOSCA FRANCESCO	2011-06-17	GEN K	15NA3929	2
11	AMBROSIO SALVATORE PIO	2011-11-07	KRTFRATTAMINORE	15NA0930	1
11	LA GATTA LUIGI	2011-04-22	C.S. POMILIA	15NA0363	1
11	IODICE VINCENZO	2012-01-02	GYM & FITNESS	15CE4455	1
11	RISPOLI FRANCESCO	2011-05-30	GSK BRACCIANTE	15SA3982	1
11	SAVIO EMANUELE	2011-03-16	ASDLENEA	15SA2185	1

Lista ufficiale dei risultati / 15-FRQ_ESORDIENTI_KA_KU KARATE CAMPANIA - 2024-05-12

11	ALBORINO FRANCESCO	2011-05-30	PIELLE CE	15CE4031	1
11	MASINI STEFANO	2012-06-20	CHAMPION CENTER	15NA1486	1
11	IACOMINO LUIGI	2012-11-30	GSK BRACCIANTE	15SA3982	1
11	NOVI ANDREA	2012-08-18	NADIR T.D.	15SA4412	1
11	PALMENTIERI ALFREDO	2012-04-29	CHAMPION CENTER	15NA1486	1
11	IULIANO CARMINE	2011-06-02	ASDLENEA	15SA2185	1
11	SACCO SERGIO KAROL	2012-01-09	GEN K	15NA3929	1
11	SALZANO GIUSEPPE	2011-08-10	OKINAWA KRTCLUB	15NA3850	1
11	GHITTI GABRIELE PIO	2011-09-28	NADIR T.D.	15SA4412	1
11	PIRAMIDE EMILIO	2011-08-09	CHAMPION CENTER	15NA1486	1
11	CELLA GIUSEPPE	2011-04-20	TEAM CAPASSO	15CE3074	1
11	PAGANO RAFFAELE	2012-01-09	NADIR T.D.	15SA4412	1
11	FALCONE UGO	2011-06-13	TEAM CAPASSO	15CE3074	1
11	MEA FRANCESCO	2011-02-11	ASDLENEA	15SA2185	1

ESORDIENTI M KUMITE 58 KG

Cl.	Atleta		Società		P.ti
1	ZACCARIA ALFREDO	2011-04-02	UNION TEAM	15CE2566	10
2	PARRETTA FILIPPO	2011-06-27	CFT C	15NA4891	8
3	OLANDESE FRANCESCO PIO	2011-07-12	C.S. POMILIA	15NA0363	6
3	MANARELLI AGOSTINO	2012-02-09	NADIR T.D.	15SA4412	6
5	MARINO ANTONIO	2011-03-02	SHIZOKU KRT AV	15AV0209	4
5	RICCARDI VINCENZO	2011-05-25	ASDLENEA	15SA2185	4
7	KHADIRI ILIASS	2011-11-30	CSKI AIROLA	15BN4198	2
7	SANNAZZARO MICHELE	2012-05-24	MASAKADO	15AV5013	2
7	BARONE FRANCESCO JUNIOR	2012-01-16	CHAMPION CENTER	15NA1486	2
7	ROSSANO ANTONIO CLAUDIO	2011-02-26	SHIZOKU KRT AV	15AV0209	2
11	CESPEDES MENDOSA JORGE VITTORIO	2011-09-28	BODY FORM	15NA5106	1
11	MARCHESE FRANCESCO DAVIDE	2011-12-06	KARATE AND RESP	15NA3808	1
11	DANIELLO WALTER	2012-09-07	NADIR T.D.	15SA4412	1
11	PISCIOTTA MICHELE	2012-06-23	SHIRAI CLUB	15SA1180	1
11	LOMBARDO ANDREA	2011-03-23	CHAMPION CENTER	15NA1486	1

ESORDIENTI M KUMITE 63 KG

Cl.	Atleta		Società		P.ti
1	BUONDONNO MANUEL	2011-01-25	UN.TEAM	15NA4711	10
2	MUNGIGUERRA GIUSEPPE	2012-06-28	ASD ELAN	15NA0973	8
3	DE GREGORIO VINCENZO	2012-07-14	KARATE CENTER	15NA4271	6
3	IMPRODA GABRIELE	2011-02-19	PIELLE CE	15CE4031	6
5	SCHERILLO MATTEO	2011-05-26	CHAMPION CENTER	15NA1486	4
5	MARINO MAURIZIO	2012-09-02	KARATE CENTER	15NA4271	4
7	TKACHUK DAVIDE	2012-12-18	NAPOLI TOKYO	15NA4085	2
7	BARONE GIANMARCO	2011-04-01	MASAKADO	15AV5013	2
7	ARCUCCI ANTONIO	2011-07-03	SPORT E KARATE	15NA3847	2
7	MINCIONE MARCO	2012-01-04	NAPOLI TOKYO	15NA4085	2
11	STRIANO GABRIEL	2011-06-15	GSK BRACCIANTE	15SA3982	1
11	CURCIO CARMINE	2012-09-10	KIR ROYAL	15SA3308	1
11	DI RUOCCO EDUARDO	2012-02-09	APDMOSCATI	15NA4298	1
11	D'AURIA SIMONE	2011-12-16	SPORT E KARATE	15NA3847	1
11	DE LISO GIOVANNI	2012-10-05	ASDLENEA	15SA2185	1
11	PASCALE BRUNO	2011-12-02	SHIZOKU KRT AV	15AV0209	1

ESORDIENTI M KUMITE 68 KG

Cl.	Atleta		Società		P.ti
1	FOTINO SAMUELE	2011-11-18	SHIZOKU KRT AV	15AV0209	10
2	BATTAGLIA VINCENZO	2011-11-07	NAPOLI TOKYO	15NA4085	8
3	DEL PRETE VINCENZO	2012-07-28	KARATE AND RESP	15NA3808	6
3	VOLPICELLI DOMENICO	2012-08-28	GOLDEN T.	15NA4721	6
5	DI CATERINO DOMENICO	2012-11-10	TEAM CAPASSO	15CE3074	4

ESORDIENTI M KUMITE 75 KG				
Cl.	Atleta		Società	P.ti
1	PAGANO CARMINE	2011-08-08	SHIZOKU KRT AV	15AV0209 10
2	IACULLO LUIGI	2011-02-10	CSKI AIROLA	15BN4198 8
3	PALUMBO ANDREA	2011-11-29	ARTS RECALE	15CE2567 6

ESORDIENTI M KUMITE 75+ KG				
Cl.	Atleta		Società	P.ti
1	RUSSO GIUSEPPE PIO	2011-05-06	TEAM CAPASSO	15CE3074 10
2	CAPOLUONGO ANTONIO SAMUELE	2012-08-10	TEAM CAPASSO	15CE3074 8

ESORDIENTI F KATA

15-FRQ_ESORDIENTI_KA_KU KARATE CAMPANIA, Via Matilde Serao 17b, località Carivita Cercola, ITA

2024-05-12

Tatami
1 09:00

Tabelloni - Pool
1/1

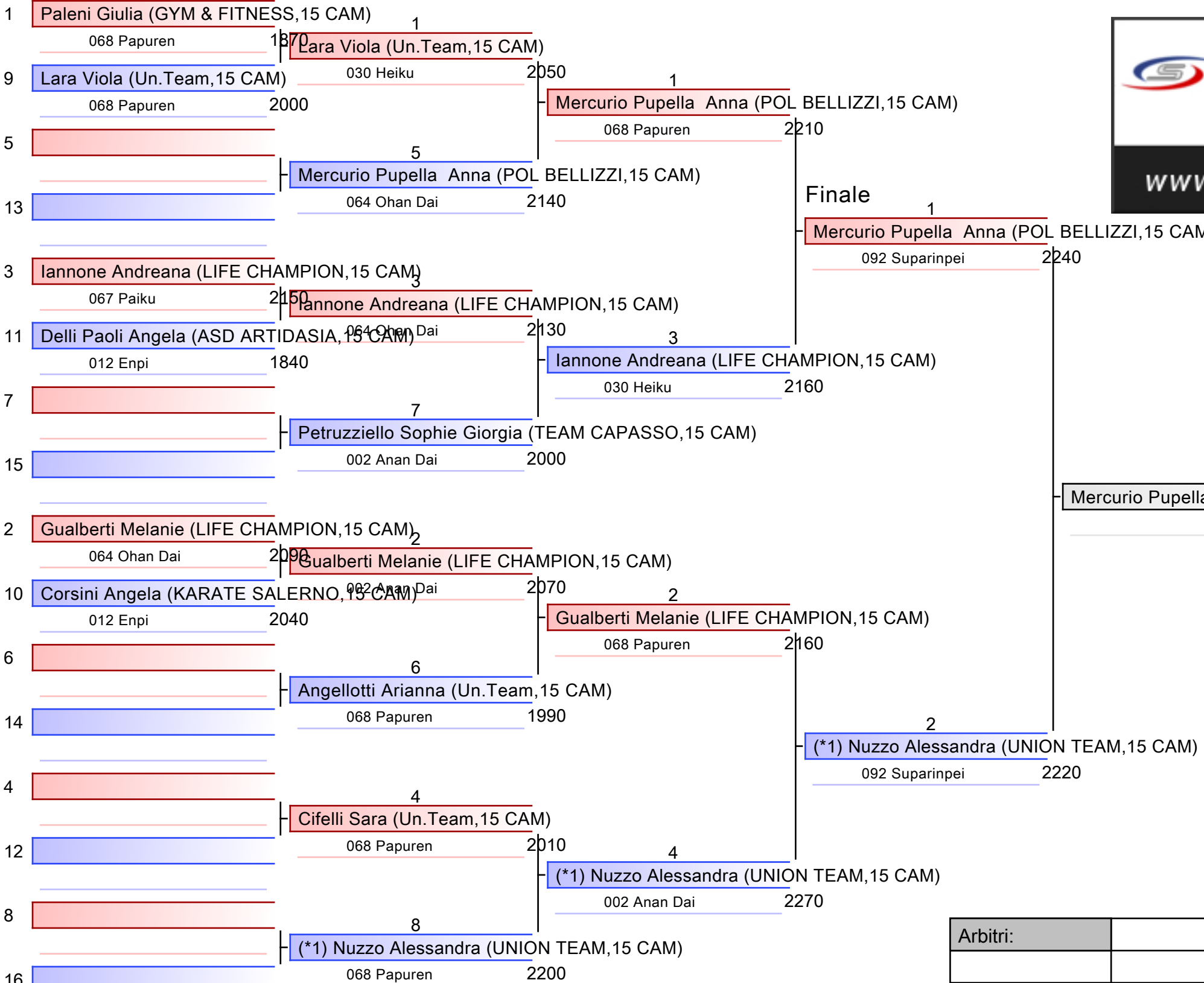

1. MERCURIO PUPELLA ANNA (POL BELLIZZI, 15 CAM)
2. NUZZO ALESSANDRA (UNION TEAM, 15 CAM)
3. IANNONE ANDREANA (LIFE CHAMPION, 15 CAM)
3. GUALBERTI MELANIE (LIFE CHAMPION, 15 CAM)
5. LARA VIOLA (UN.TEAM, 15 CAM)
5. CIFELLI SARA (UN.TEAM, 15 CAM)

*Testa di serie

Arbitri:			

ESORDIENTI F KUMITE 35 KG

15-FRQ_ESORDIENTI_KA_KU KARATE CAMPANIA, Via Matilde Serao 17b, località Carivita Cercola, ITA

2024-05-12

Tatami

2 11:00

Tabelloni - Pool

1/1

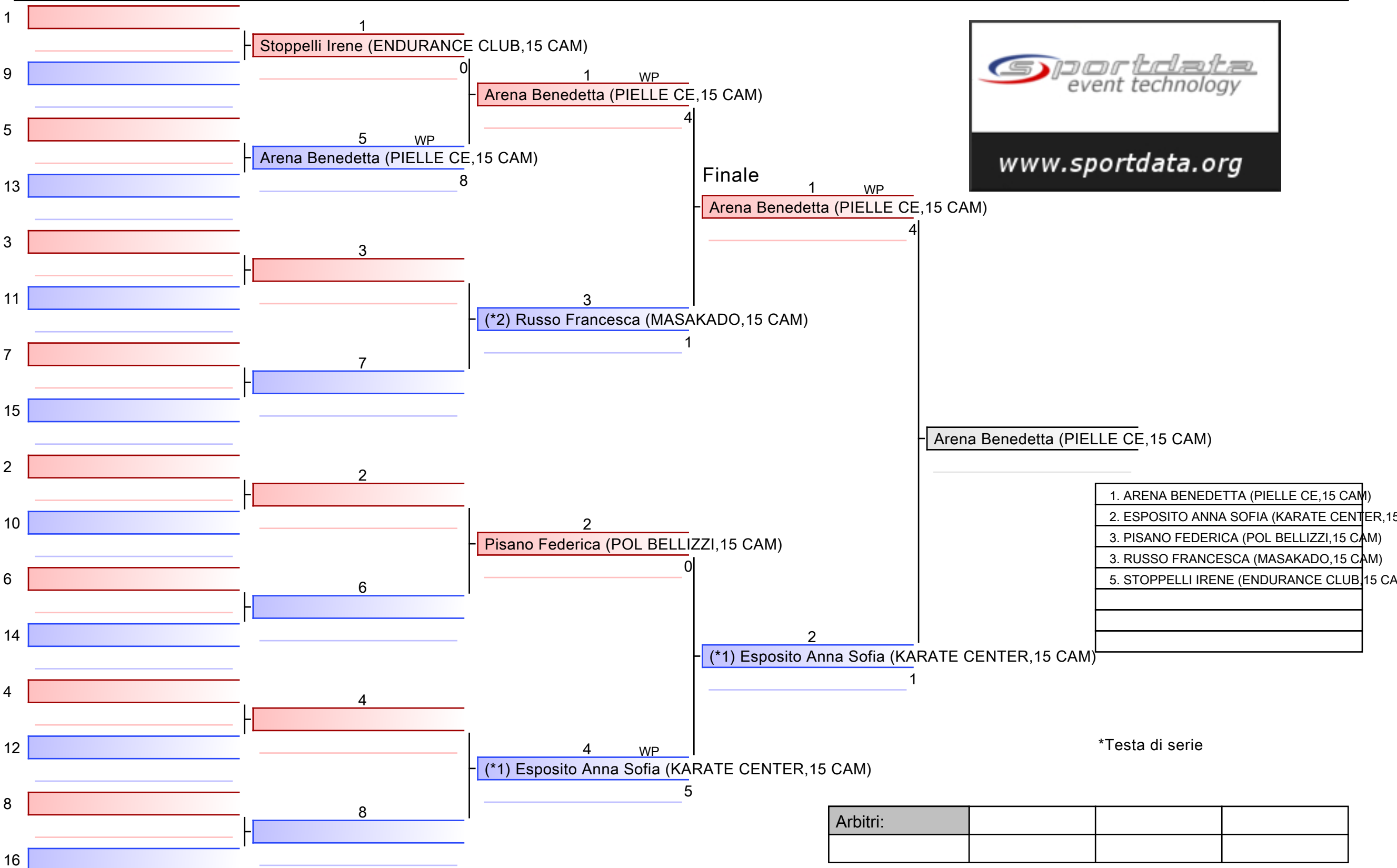

ESORDIENTI F KUMITE 40 KG

15-FRQ_ESORDIENTI_KA_KU KARATE CAMPANIA, Via Matilde Serao 17b, località Carivita Cercola, ITA

2024-05-12

Tatami 3 11:50

Tabelloni - Pool 1/1

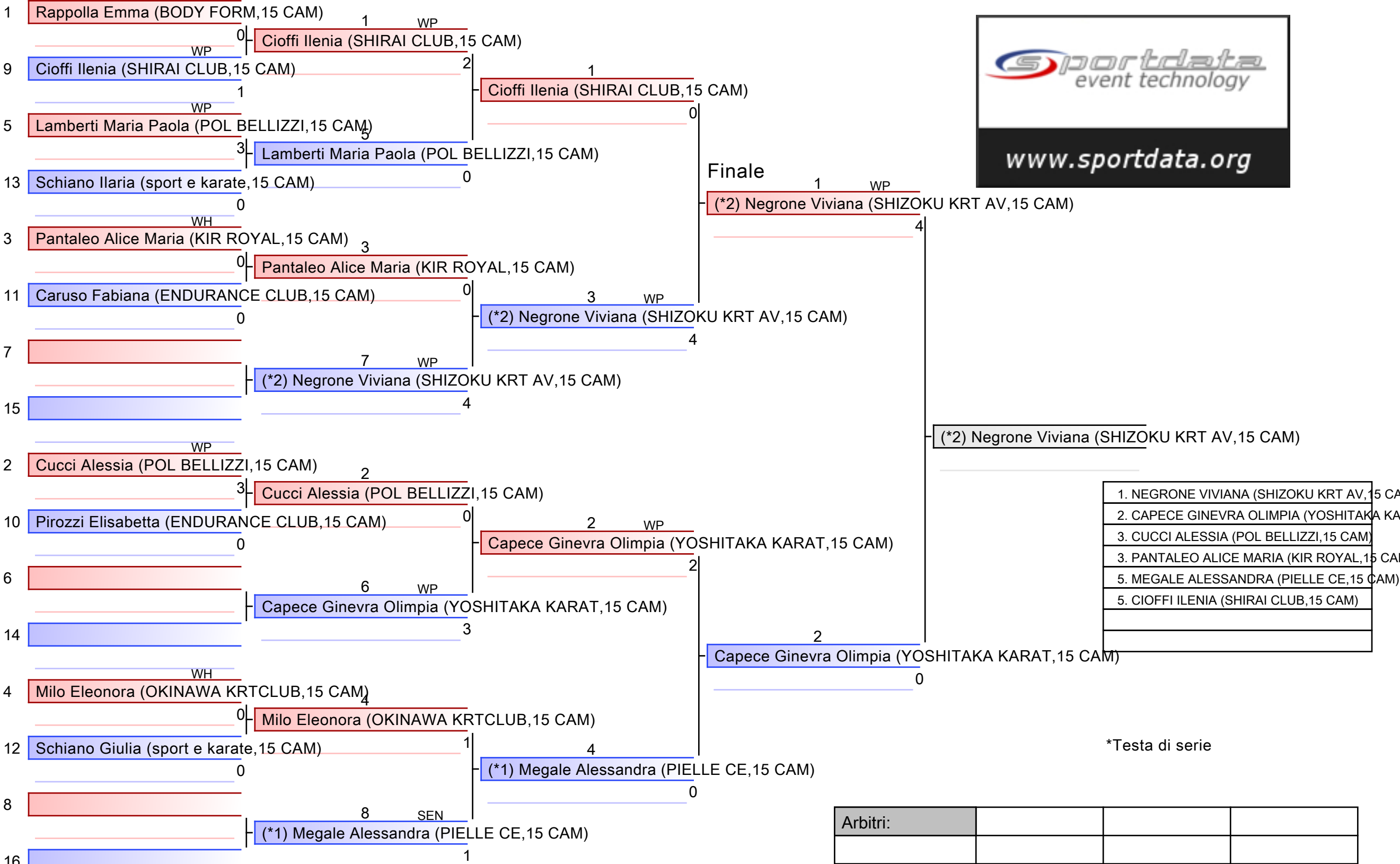

Table with 2 columns: Rank, Name, Club. Contains 6 rows of athlete information.

*Testa di serie

Table for referees: Arbitri: [] [] [] []

ESORDIENTI F KUMITE 45 KG

15-FRQ_ESORDIENTI_KA_KU KARATE CAMPANIA, Via Matilde Serao 17b, località Carivita Cercola, ITA

2024-05-12

Tatami

1 11:00

Tabelloni - Pool

1/1

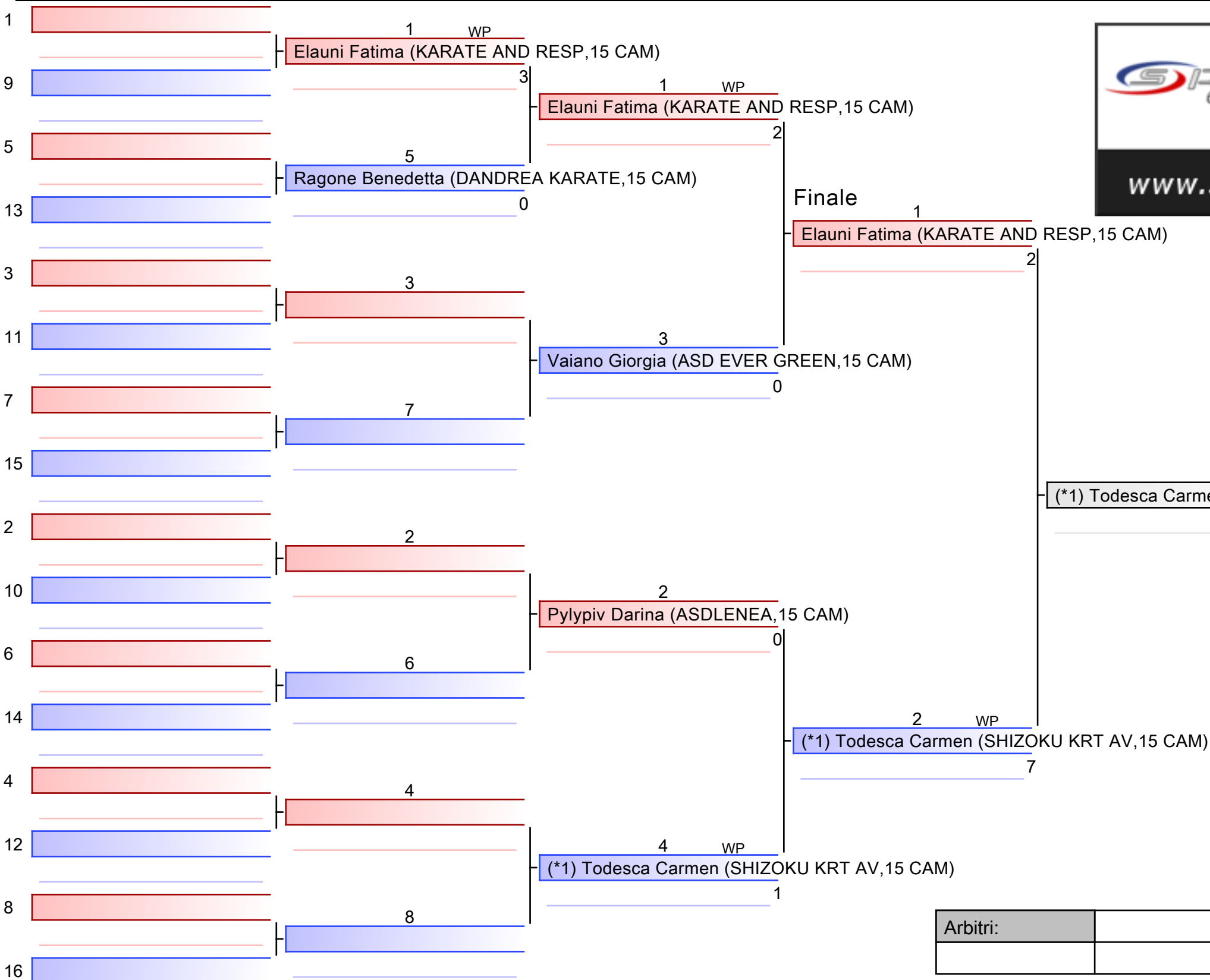

1. TODESCA CARMEN (SHIZOKU KRT AV, 15 CAM)
2. ELAUNI FATIMA (KARATE AND RESP, 15 CAM)
3. PYLYPIV DARINA (ASDLENEA, 15 CAM)
3. VAIANO GIORGIA (ASD EVER GREEN, 15 CAM)
5. RAGONE BENEDETTA (DANDREA KARATE, 15 CAM)

*Testa di serie

Arbitri:			

ESORDIENTI F KUMITE 50 KG

15-FRQ_ESORDIENTI_KA_KU KARATE CAMPANIA, Via Matilde Serao 17b, località Carivita Cercola, ITA

2024-05-12

Tatami

1 11:30

Tabelloni - Pool

1/2

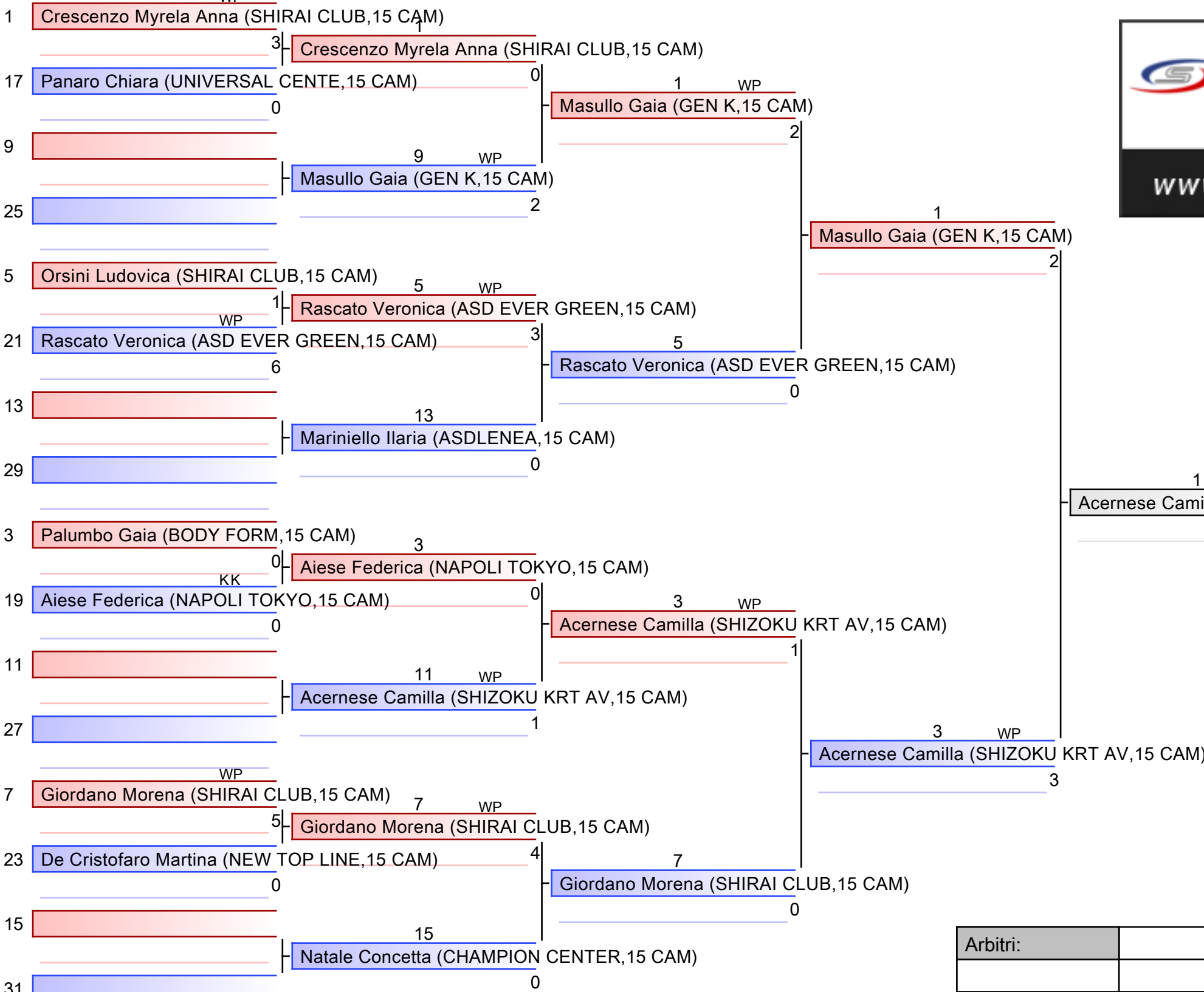

- | |
|--|
| 1. SPINA AURORA (SHIZOKU KRT AV, 15 CAM) |
| 2. ACERNESE CAMILLA (SHIZOKU KRT AV, 15 CAM) |
| 3. GIORDANO MORENA (SHIRAI CLUB, 15 CAM) |
| 3. PIGNATIELLO ROBERTA (UNIVERSAL CENTE, 15 CAM) |
| 5. MASULLO GAIA (GEN K, 15 CAM) |
| 5. DE LUCA GINEVRA (KARATE CENTER, 15 CAM) |
| 7. AIESE FEDERICA (NAPOLI TOKYO, 15 CAM) |
| 7. CORRADO TULLIA (SHIRAI CLUB, 15 CAM) |

Arbitri:			

ESORDIENTI F KUMITE 50 KG

15-FRQ_ESORDIENTI_KA_KU KARATE CAMPANIA, Via Matilde Serao 17b, località Carivita Cercola, ITA

2024-05-12

Tatami

2 11:30

Tabelloni - Pool

2/2

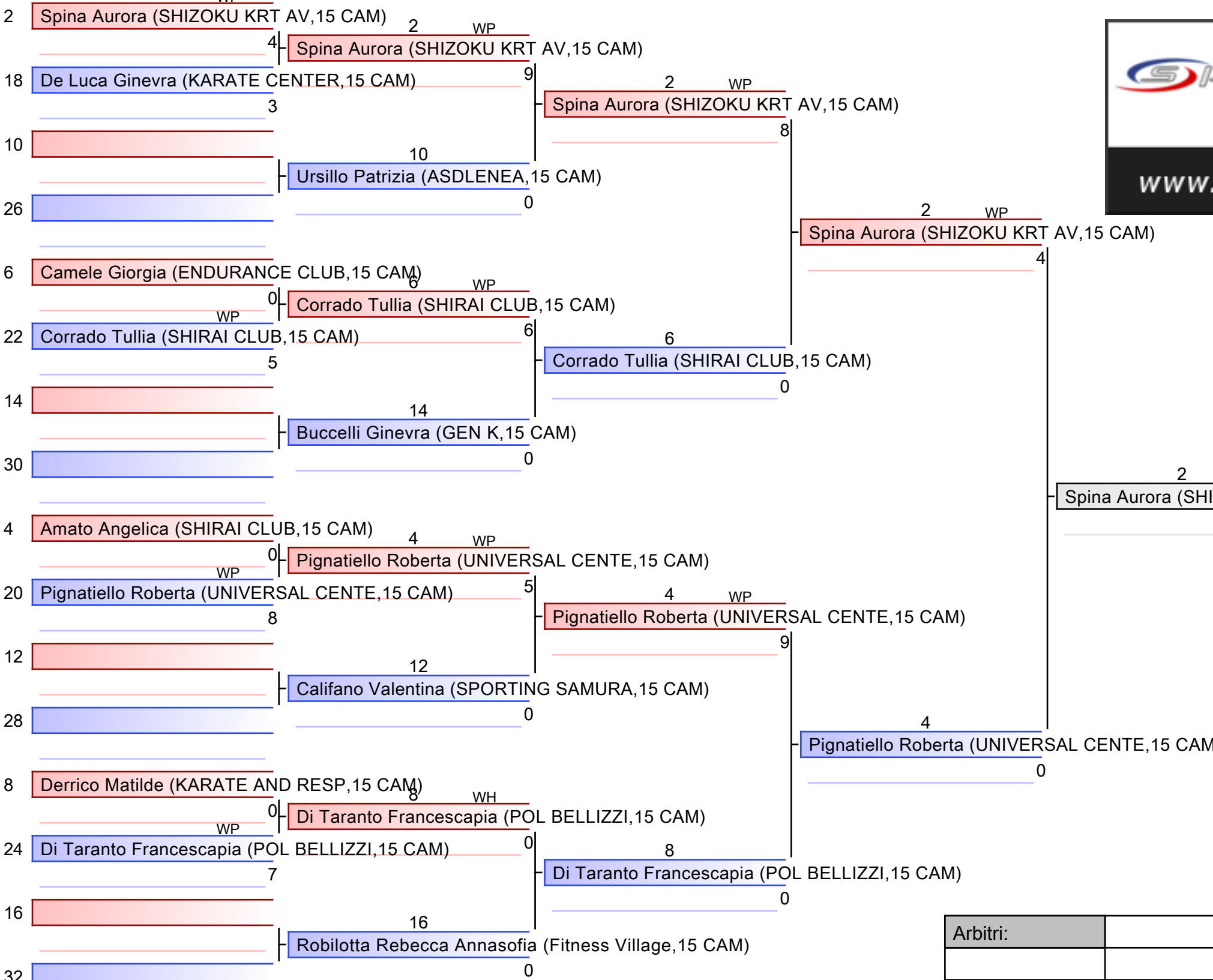

- 1. SPINA AURORA (SHIZOKU KRT AV, 15 CAM)
- 2. ACERNESE CAMILLA (SHIZOKU KRT AV, 15 CAM)
- 3. GIORDANO MORENA (SHIRAI CLUB, 15 CAM)
- 3. PIGNATIELLO ROBERTA (UNIVERSAL CENTE, 15 CAM)
- 5. MASULLO GAIA (GEN K, 15 CAM)
- 5. DE LUCA GINEVRA (KARATE CENTER, 15 CAM)
- 7. AIESE FEDERICA (NAPOLI TOKYO, 15 CAM)
- 7. CORRADO TULLIA (SHIRAI CLUB, 15 CAM)

Arbitri:			

ESORDIENTI F KUMITE 56 KG

15-FRQ_ESORDIENTI_KA_KU KARATE CAMPANIA, Via Matilde Serao 17b, località Carivita Cercola, ITA

2024-05-12

Tatami

3 11:00

Tabelloni - Pool

1/1

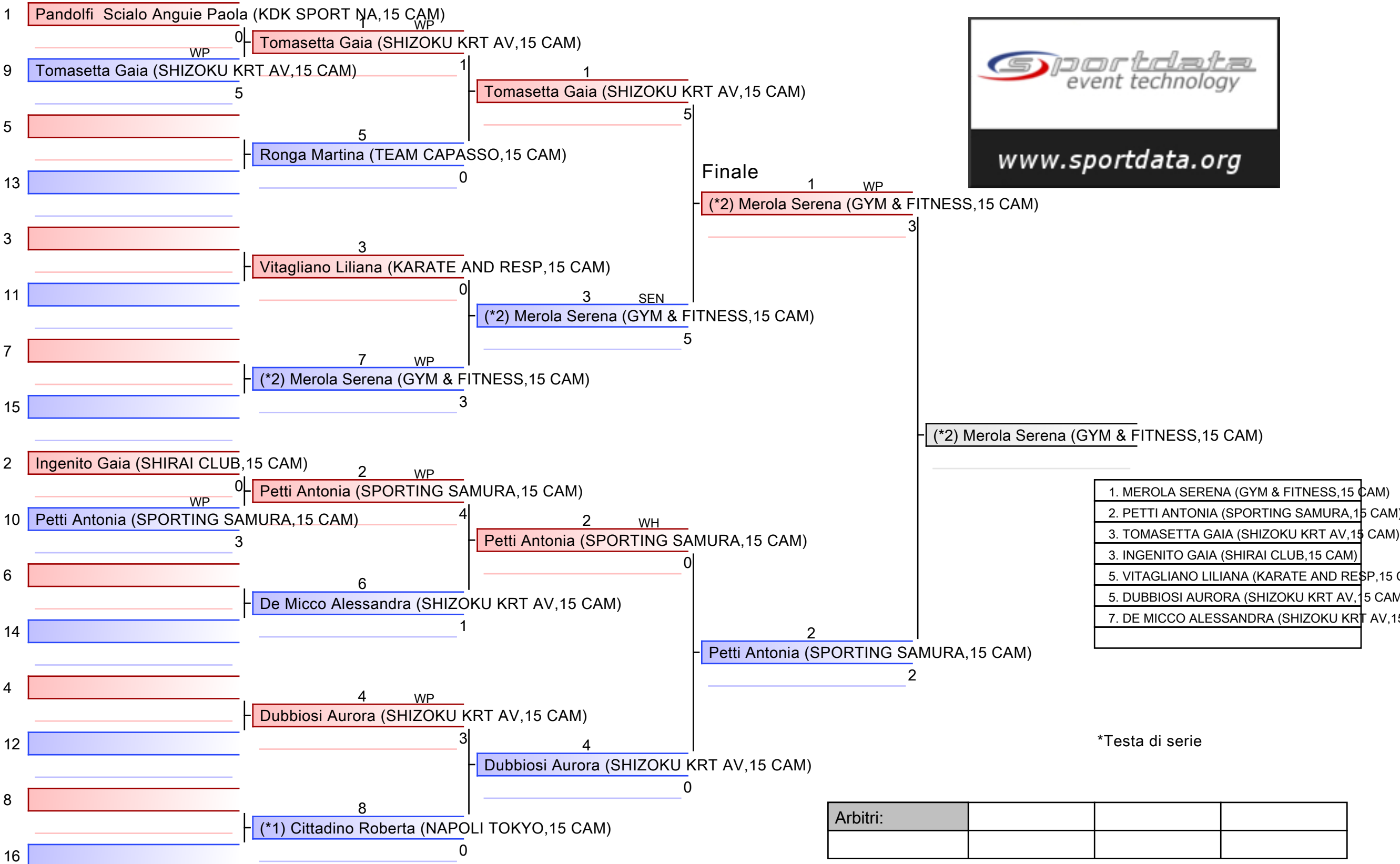

ESORDIENTI F KUMITE 62 KG

15-FRQ_ESORDIENTI_KA_KU KARATE CAMPANIA, Via Matilde Serao 17b, località Carivita Cercola, ITA

2024-05-12

Tatami

2 12:15

Tabelloni - Pool

1/1

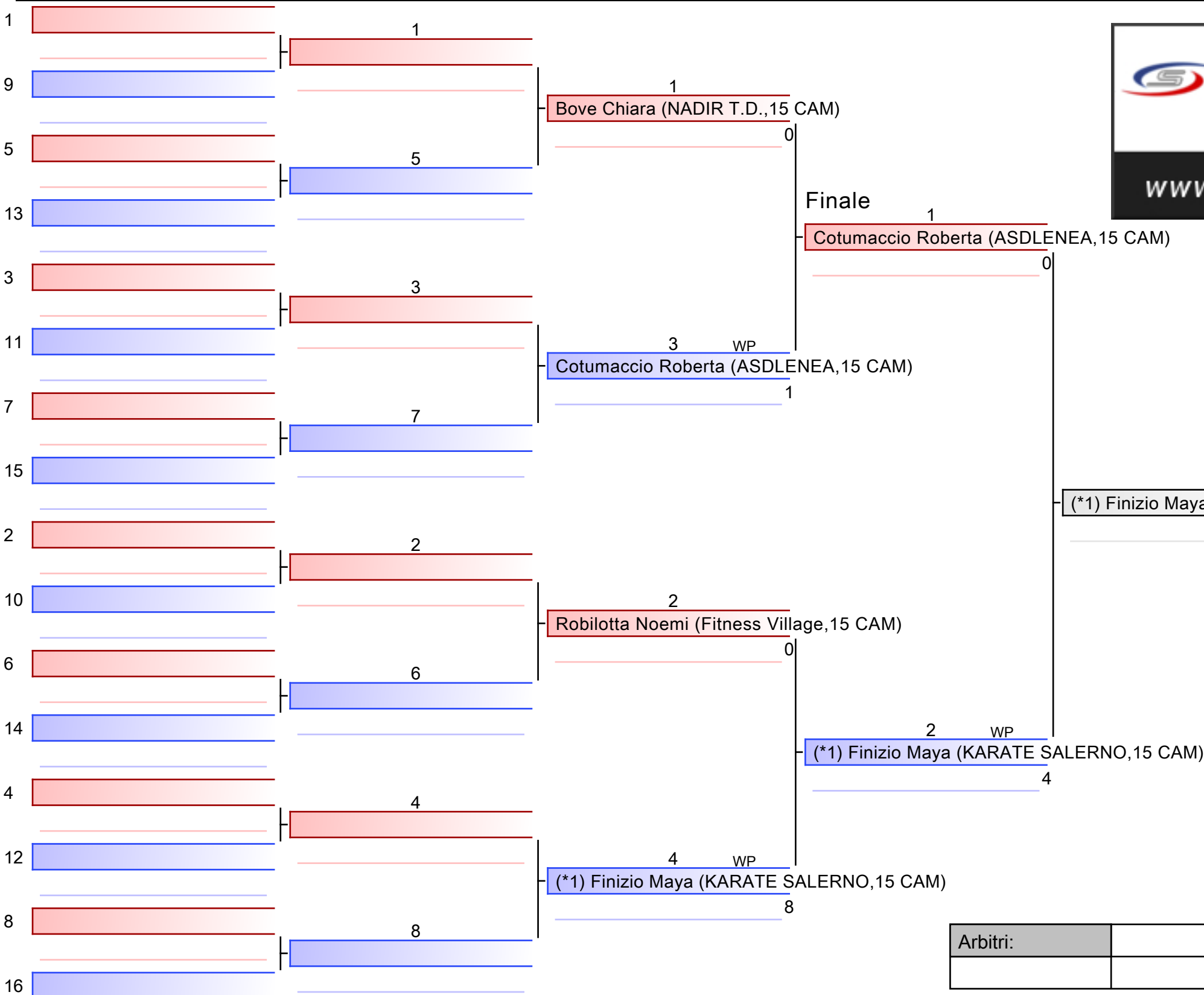

1. FINIZIO MAYA (KARATE SALERNO,15 CAM)
2. COTUMACCIO ROBERTA (ASDLENEA,15 CAM)
3. BOVE CHIARA (NADIR T.D.,15 CAM)
3. ROBILOTTA NOEMI (FITNESS VILLAGE,15 CAM)

*Testa di serie

Arbitri:			

ESORDIENTI F KUMITE 68 KG - Girone all'Italiana (tutti contro tutti)

15-FRQ_ESORDIENTI_KA_KU KARATE CAMPANIA, Via Matilde Serao 17b, località Carivita Cercola, ITA

2024-05-12

Tatami

2 12:30

Tabelloni - Pool

1/1

- 1 Piscitelli Arianna (UNION TEAM, 15 CAM)

2 | Piscitelli Arianna (UNION TEAM, 15 CAM)
- 2 Piscopo Angela (GOLDEN T., 15 CAM)

0
- 3 Sieyes Sabina (ENDURANCE CLUB, 15 CAM)

WP
- 3 Sieyes Sabina (ENDURANCE CLUB, 15 CAM)

3 | Sieyes Sabina (ENDURANCE CLUB, 15 CAM)
- 4 Piscitelli Arianna (UNION TEAM, 15 CAM)

2
- 5 Piscopo Angela (GOLDEN T., 15 CAM)

WP
- 5 Piscopo Angela (GOLDEN T., 15 CAM)

2 | Piscopo Angela (GOLDEN T., 15 CAM)
- 6 Sieyes Sabina (ENDURANCE CLUB, 15 CAM)

1



1. PISCITELLI ARIANNA (UNION TEAM, 15 CAM)
2. SIEYES SABINA (ENDURANCE CLUB, 15 CAM)
3. PISCOPO ANGELA (GOLDEN T., 15 CAM)

Arbitri:				

ESORDIENTI M KATA

15-FRQ_ESORDIENTI_KA_KU KARATE CAMPANIA, Via Matilde Serao 17b, località Carivita Cercola, ITA

2024-05-12

Tatami
2 09:00

Tabelloni - Pool
1/2

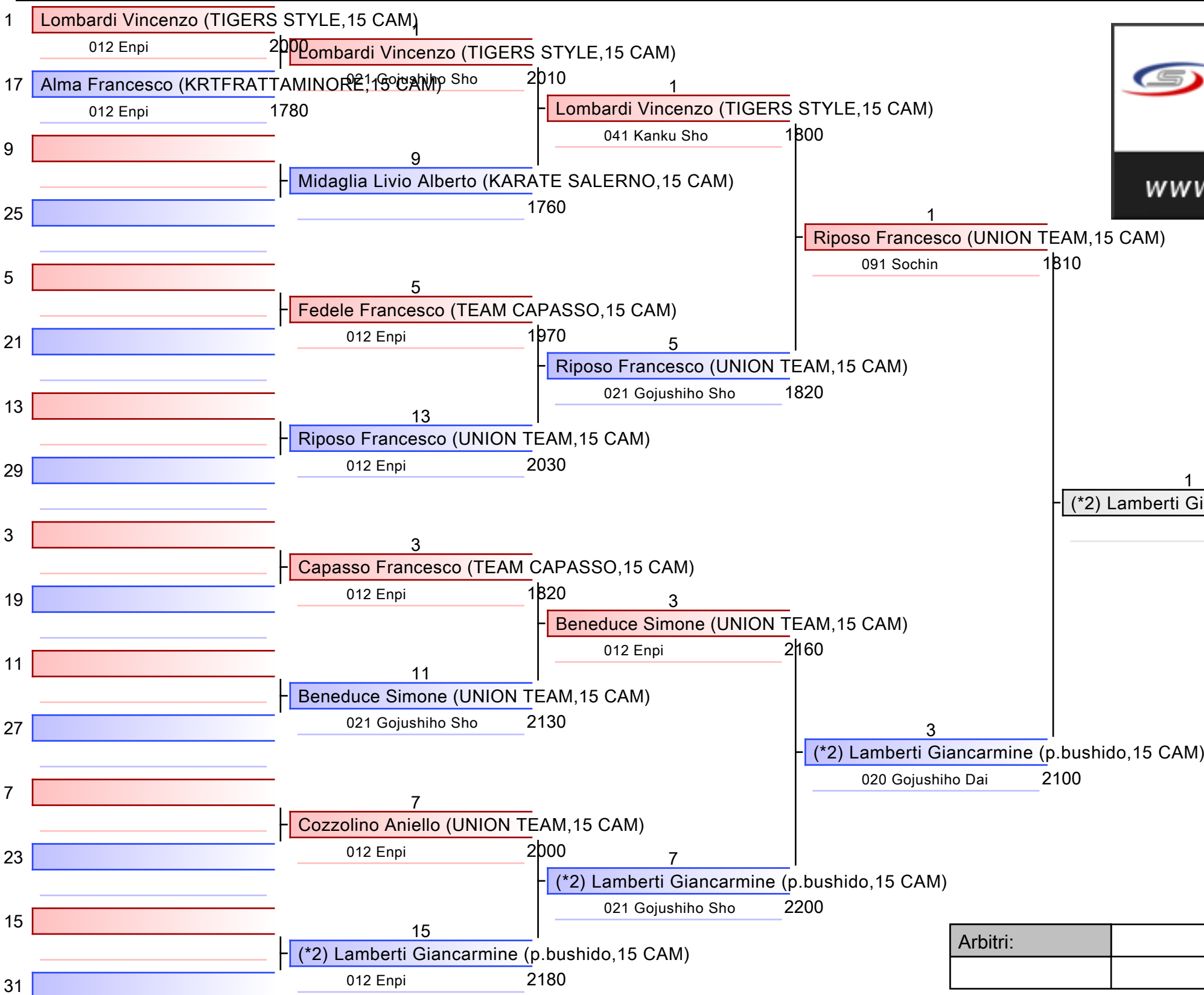

- 1. MARCHETTI ENRICO (KARATE SALERNO, 15 CAM)
- 2. LAMBERTI GIANCARMINE (P.BUSHIDO, 15 CAM)
- 3. MARTINISI GUIDO (UNION TEAM, 15 CAM)
- 3. BENEDUCE SIMONE (UNION TEAM, 15 CAM)
- 5. SALVATI PAOLO (UNION TEAM, 15 CAM)
- 5. RIPOSO FRANCESCO (UNION TEAM, 15 CAM)
- 7. ARRICHELLO ARMANDO (TEAM CAPASSO, 15 CAM)
- 7. COZZOLINO ANIELLO (UNION TEAM, 15 CAM)

*Testa di serie

Arbitri:			

ESORDIENTI M KATA

15-FRQ_ESORDIENTI_KA_KU KARATE CAMPANIA, Via Matilde Serao 17b, località Carivita Cercola, ITA

2024-05-12

Tatami

3 09:00

Tabelloni - Pool

2/2

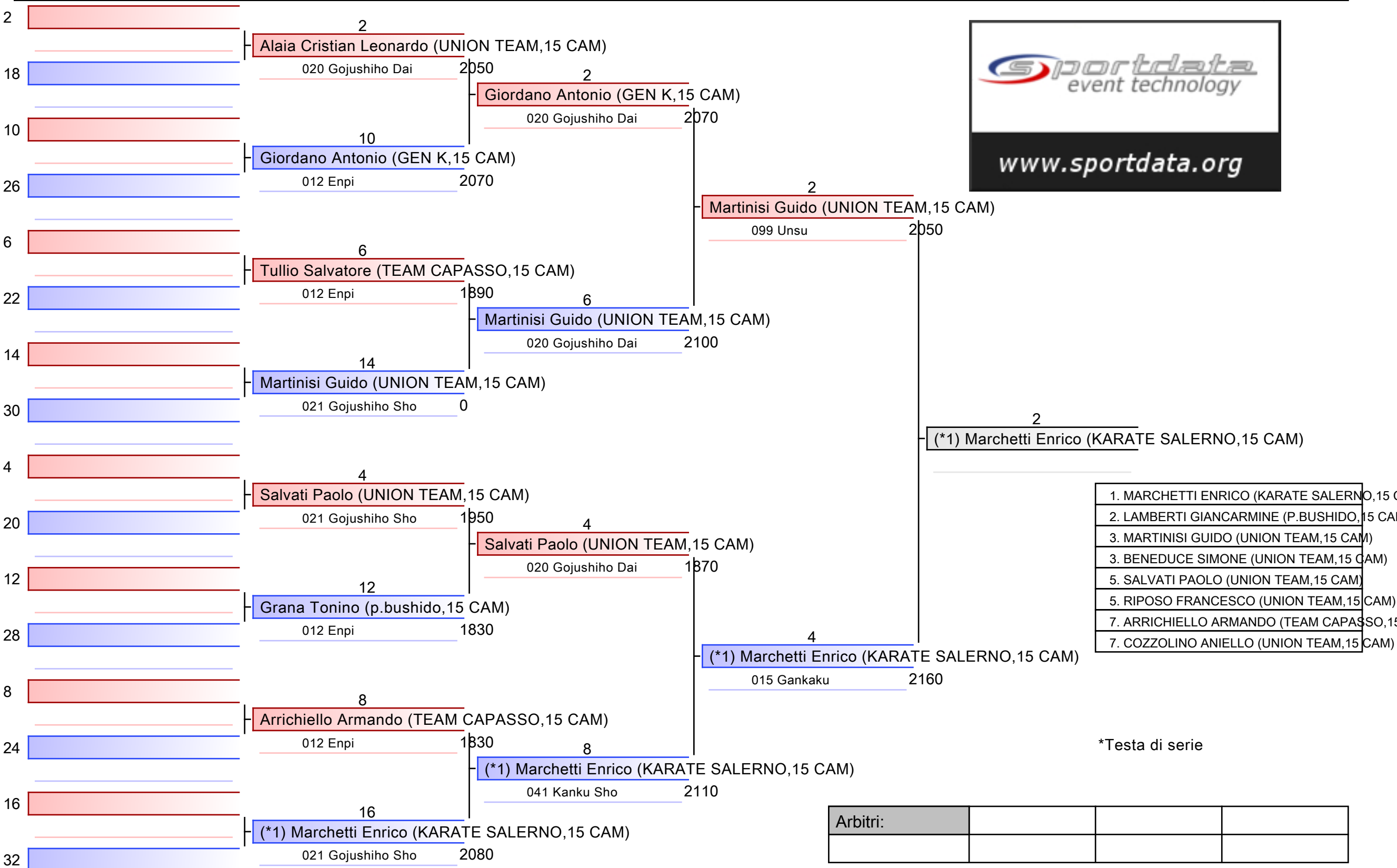

*Testa di serie

Arbitri:			

ESORDIENTI M KUMITE 38 KG

15-FRQ_ESORDIENTI_KA_KU KARATE CAMPANIA, Via Matilde Serao 17b, località Carivita Cercola, ITA

2024-05-12

Tatami
1 13:15

Tabelloni - Pool
1/1

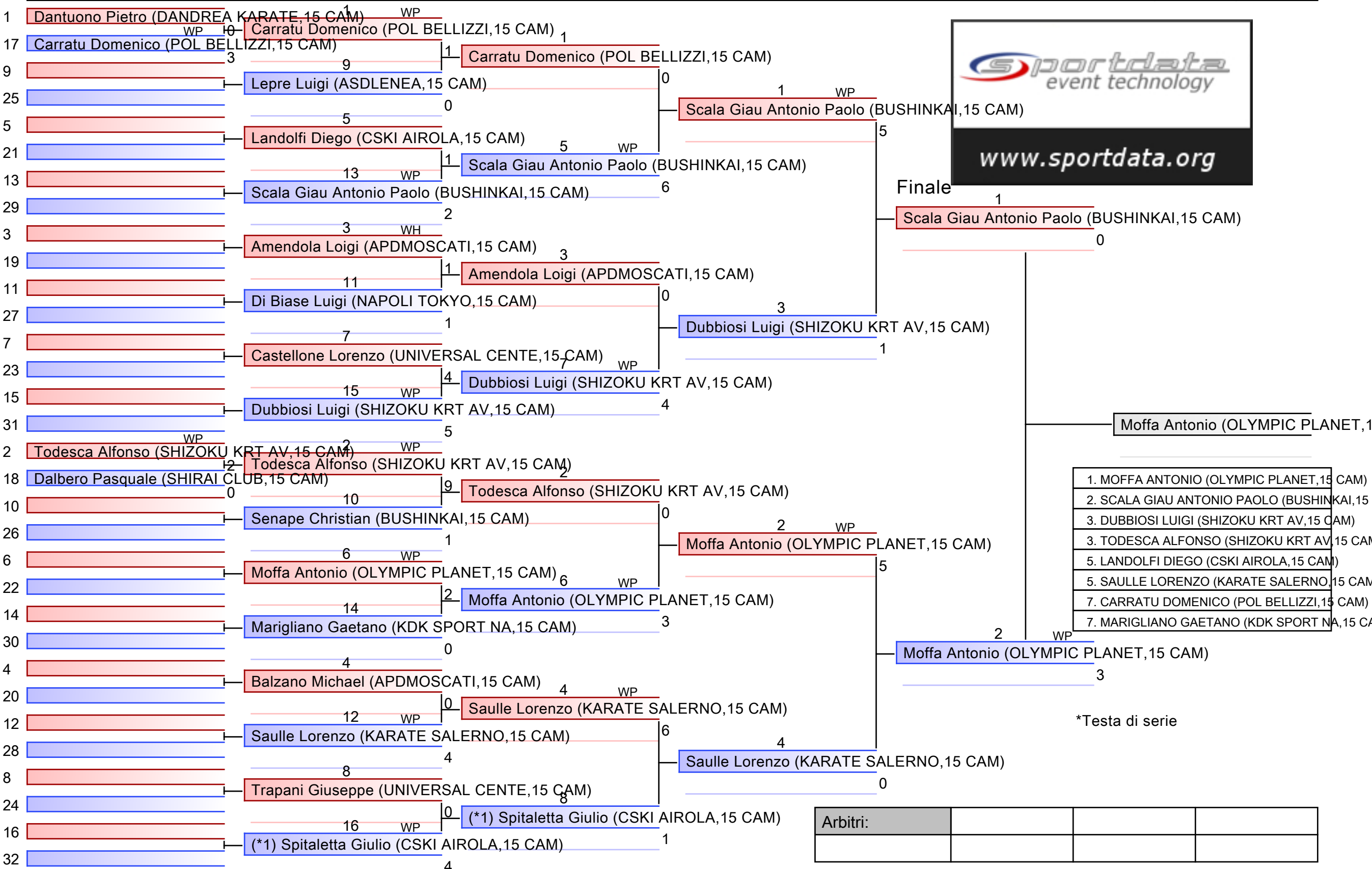

ESORDIENTI M KUMITE 43 KG

15-FRQ_ESORDIENTI_KA_KU KARATE CAMPANIA, Via Matilde Serao 17b, località Carivita Cercola, ITA

2024-05-12

Tatami
2 14:35

Tabelloni - Pool
1/1

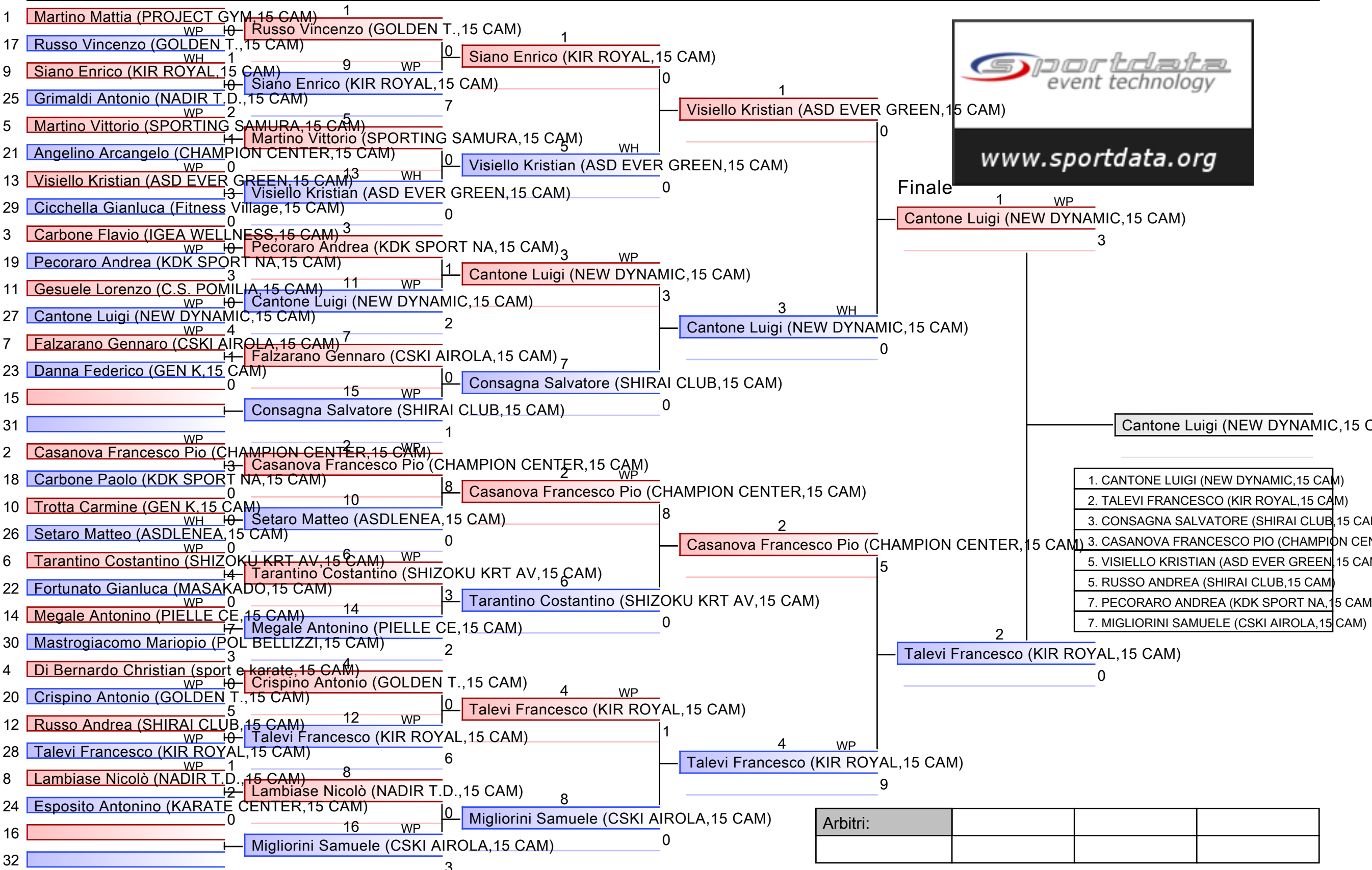

Arbitri:			

ESORDIENTI M KUMITE 48 KG

15-FRQ_ESORDIENTI_KA_KU KARATE CAMPANIA, Via Matilde Serao 17b, località Carivita Cercola, ITA

2024-05-12

Tatami

1 14:50

Tabelloni - Pool

1/2

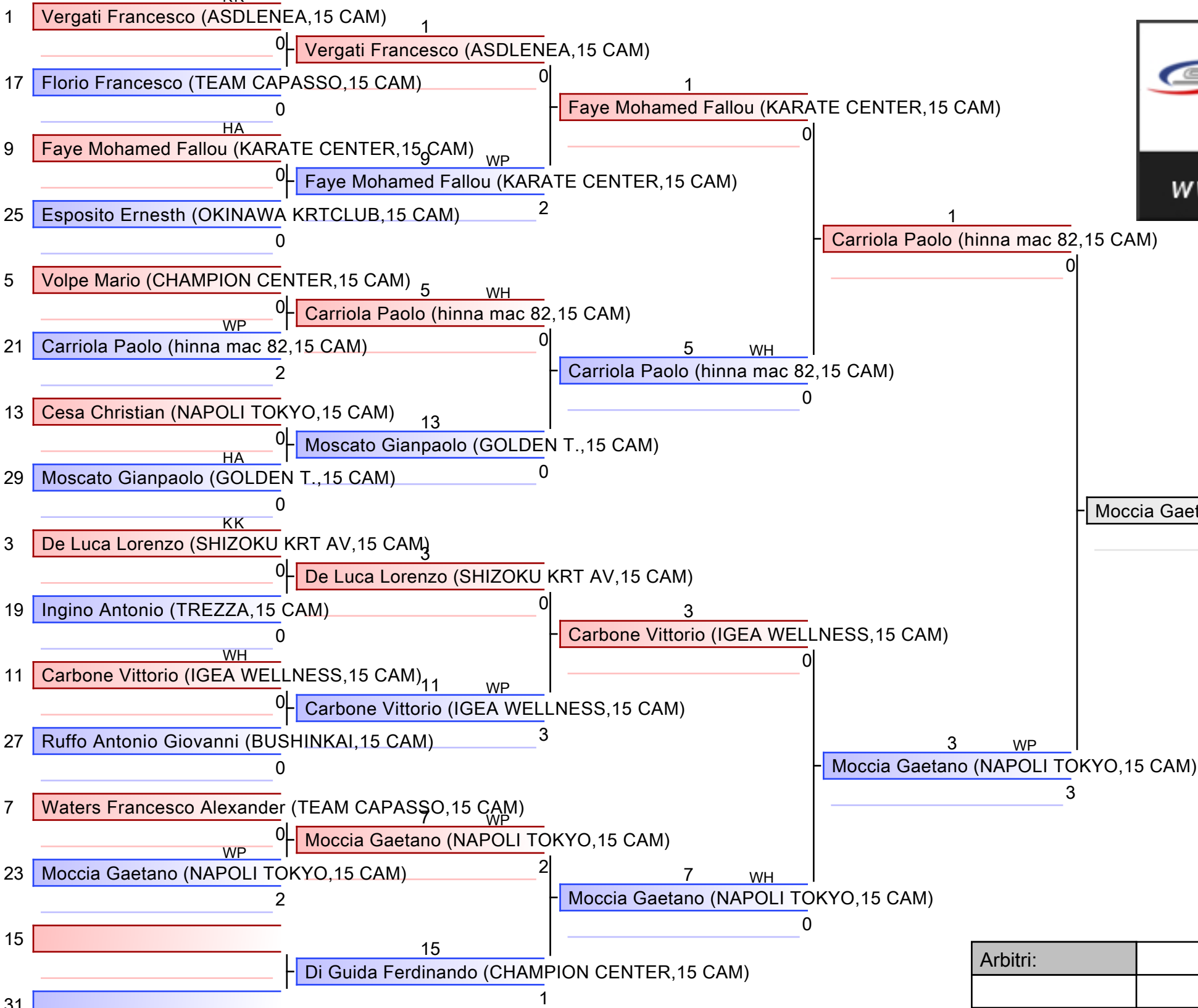

- 1. MOCCIA GAETANO (NAPOLI TOKYO, 15 CAM)
- 2. MARINIELLI PIETRO (KARATE AND RES, 15 CAM)
- 3. DI GUIDA FERDINANDO (CHAMPION CENTER, 15 CAM)
- 3. PAGLIONICO VITTORIO (CHAMPION CENTER, 15 CAM)
- 5. CARRIOLA PAOLO (HINNA MAC 82, 15 CAM)
- 5. SBRIGLIA ANDREA (CHAMPION CENTER, 15 CAM)
- 7. CARBONE VITTORIO (IGEA WELLNESS, 15 CAM)
- 7. CHIAVAZZO LUIGI (NADIR T.D., 15 CAM)

Arbitri:			

ESORDIENTI M KUMITE 48 KG

15-FRQ_ESORDIENTI_KA_KU KARATE CAMPANIA, Via Matilde Serao 17b, località Carivita Cercola, ITA

2024-05-12

Tatami

1 14:50

Tabelloni - Pool

2/2

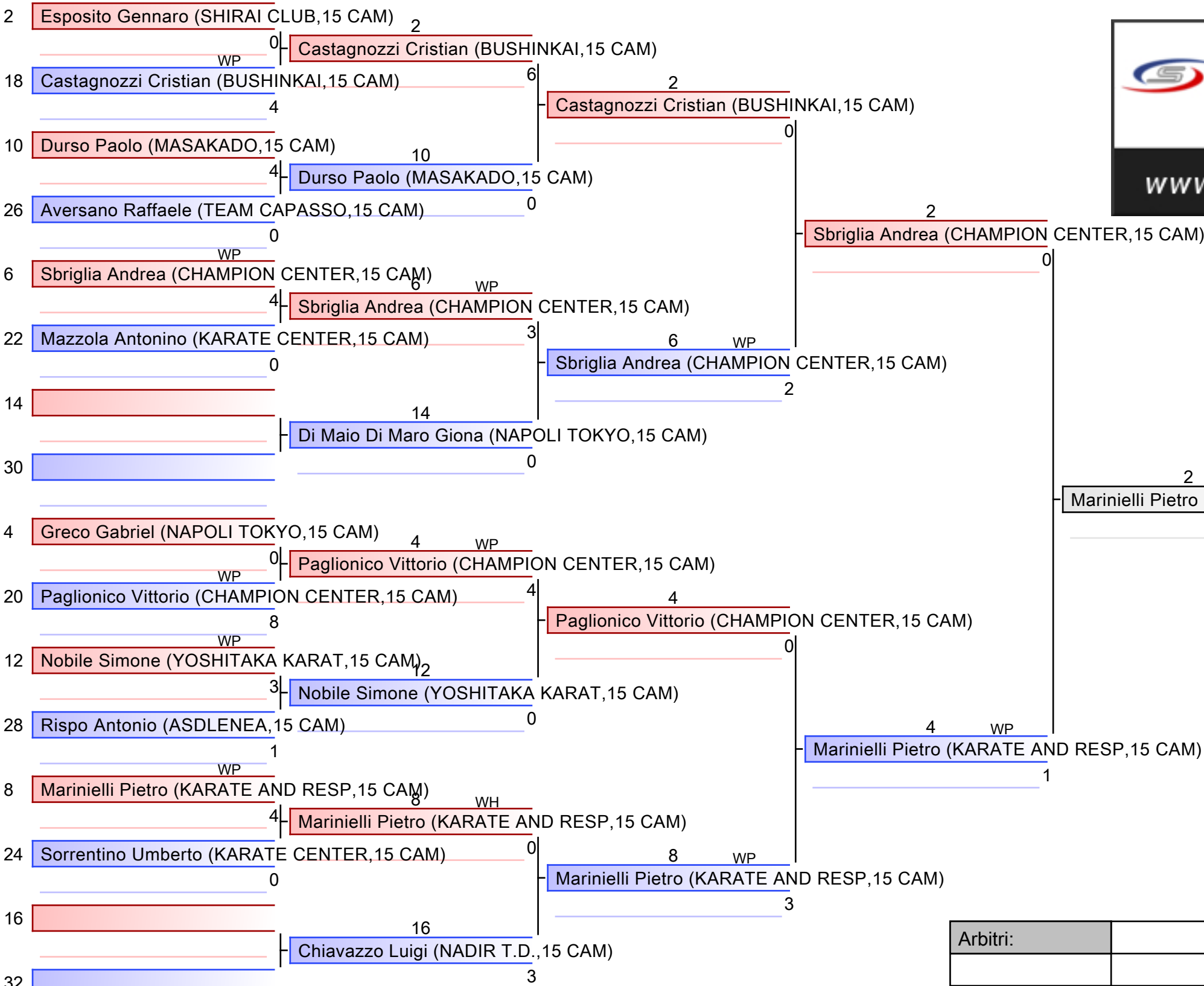

- | |
|--|
| 1. MOCCIA GAETANO (NAPOLI TOKYO, 15 CAM) |
| 2. MARINIELLI PIETRO (KARATE AND RESP, 15 CAM) |
| 3. DI GUIDA FERDINANDO (CHAMPION CENTER, 15 CAM) |
| 3. PAGLIONICO VITTORIO (CHAMPION CENTER, 15 CAM) |
| 5. CARRIOLA PAOLO (HINNA MAC 82, 15 CAM) |
| 5. SBRIGLIA ANDREA (CHAMPION CENTER, 15 CAM) |
| 7. CARBONE VITTORIO (IGEA WELLNESS, 15 CAM) |
| 7. CHIAVAZZO LUIGI (NADIR T.D., 15 CAM) |

Arbitri:			

ESORDIENTI M KUMITE 53 KG

15-FRQ_ESORDIENTI_KA_KU KARATE CAMPANIA, Via Matilde Serao 17b, località Carivita Cercola, ITA

2024-05-12

Tatami

3 13:15

Tabelloni

1/2

Pool

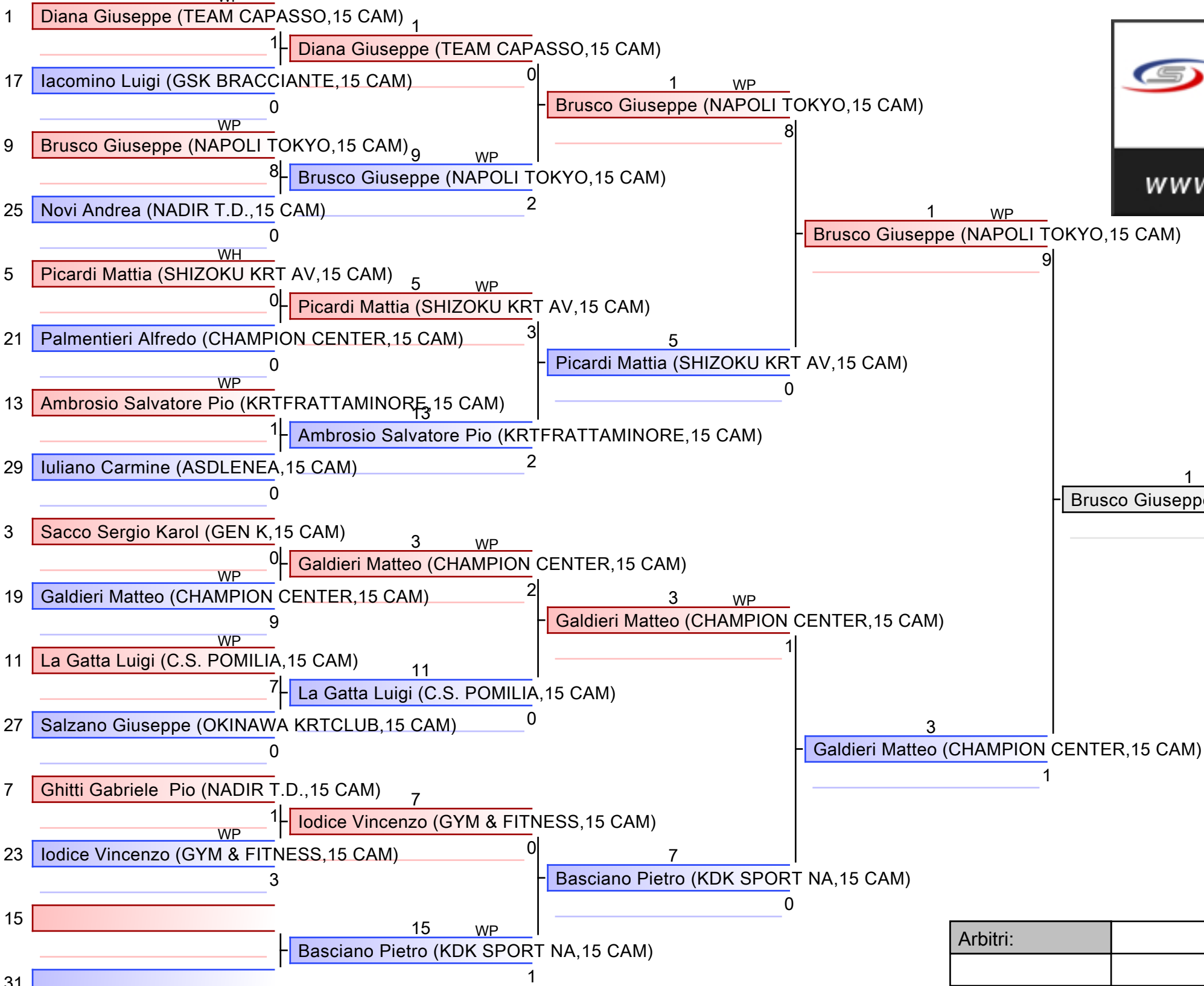

- | |
|---|
| 1. ANNUNZIATA DAVIDE (UN.TEAM,15 CAM) |
| 2. BRUSCO GIUSEPPE (NAPOLI TOKYO,15 CAM) |
| 3. GALDIERI MATTEO (CHAMPION CENTER,15 CAM) |
| 3. RUSSOMANNO EMANUELE (SHIRAI CLUB,15 CAM) |
| 5. DIANA GIUSEPPE (TEAM CAPASSO,15 CAM) |
| 5. MONA DARIO (NAPOLI TOKYO,15 CAM) |
| 7. PICARDI MATTIA (SHIZOKU KRT AV,15 CAM) |
| 7. SCOTILLO MARIO (GSK BRACCIANTE,15 CAM) |

Arbitri:			

ESORDIENTI M KUMITE 53 KG

15-FRQ_ESORDIENTI_KA_KU KARATE CAMPANIA, Via Matilde Serao 17b, località Carivita Cercola, ITA

2024-05-12

Tatami

3 13:15

Tabelloni - Pool

2/2

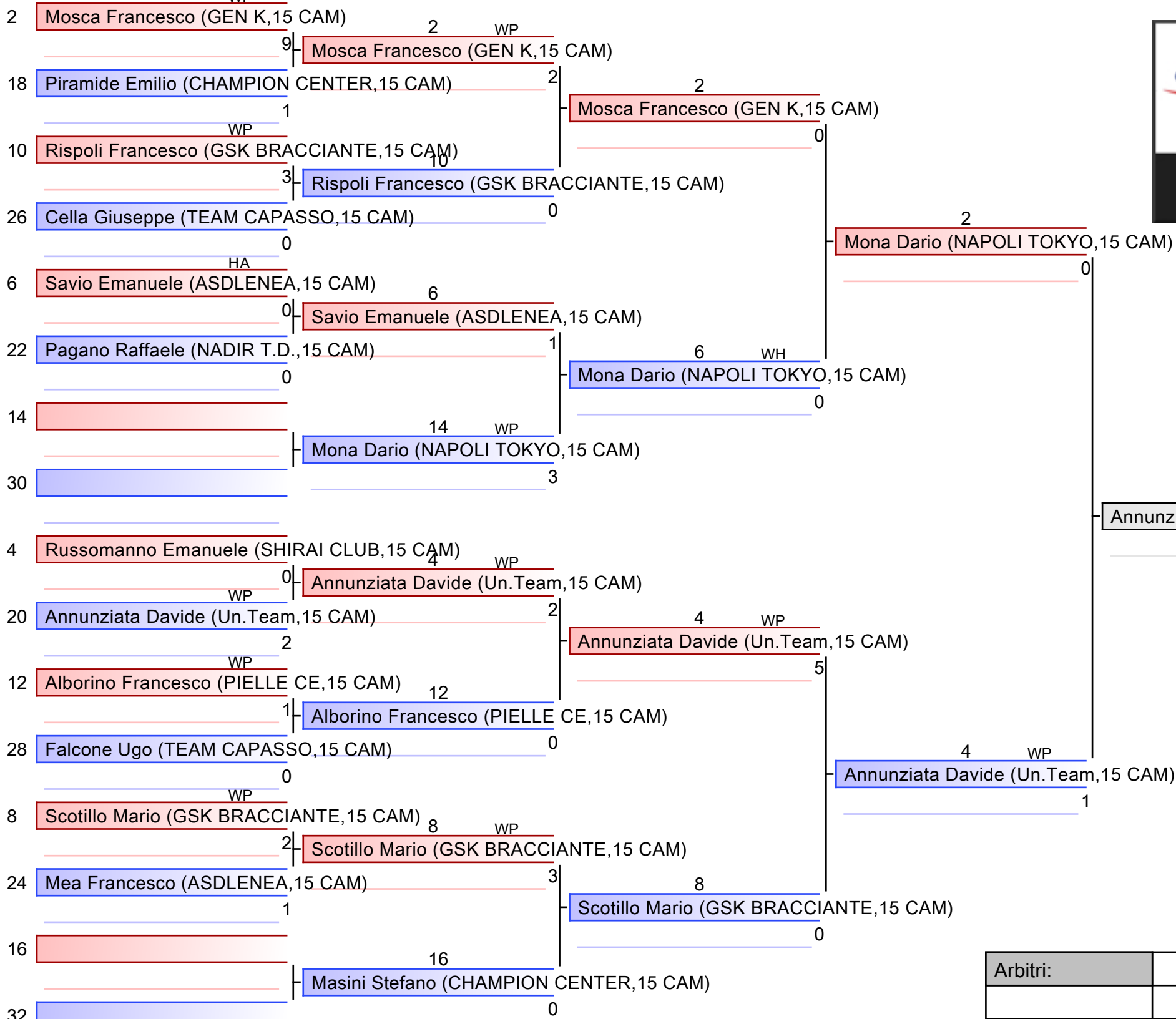

- | |
|--|
| 1. ANNUNZIATA DAVIDE (UN.TEAM, 15 CAM) |
| 2. BRUSCO GIUSEPPE (NAPOLI TOKYO, 15 CAM) |
| 3. GALDIERI MATTEO (CHAMPION CENTER, 15 CAM) |
| 3. RUSSOMANNO EMANUELE (SHIRAI CLUB, 15 CAM) |
| 5. DIANA GIUSEPPE (TEAM CAPASSO, 15 CAM) |
| 5. MONA DARIO (NAPOLI TOKYO, 15 CAM) |
| 7. PICARDI MATTIA (SHIZOKU KRT AV, 15 CAM) |
| 7. SCOTILLO MARIO (GSK BRACCIANTE, 15 CAM) |

Arbitri:			

ESORDIENTI M KUMITE 58 KG

15-FRQ_ESORDIENTI_KA_KU KARATE CAMPANIA, Via Matilde Serao 17b, località Carivita Cercola, ITA

2024-05-12

Tatami

2 13:15

Tabelloni - Pool

1/1

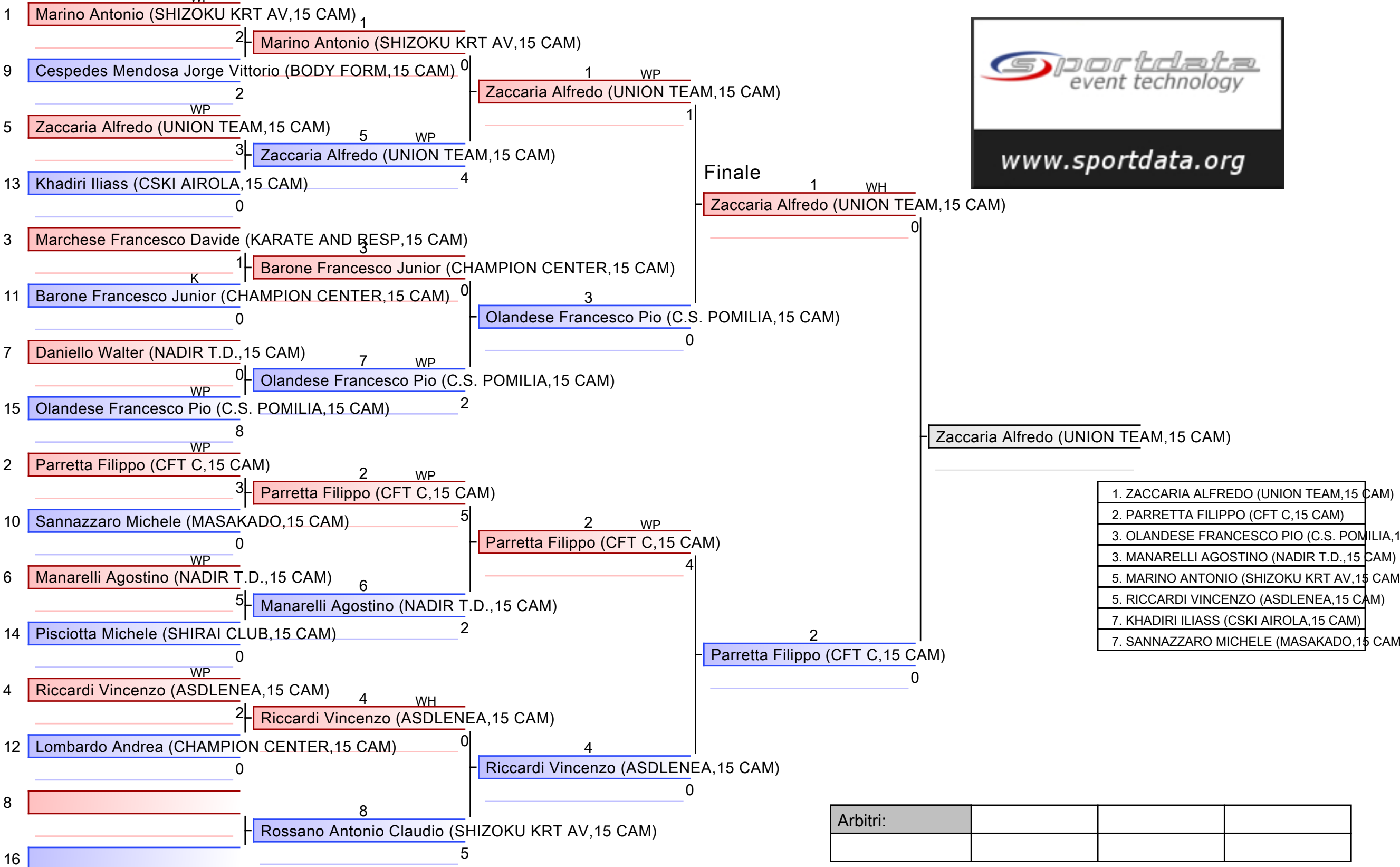

Arbitri:			

ESORDIENTI M KUMITE 63 KG

15-FRQ_ESORDIENTI_KA_KU KARATE CAMPANIA, Via Matilde Serao 17b, località Carivita Cercola, ITA

2024-05-12

Tatami

3 15:40

Tabelloni - Pool

1/1

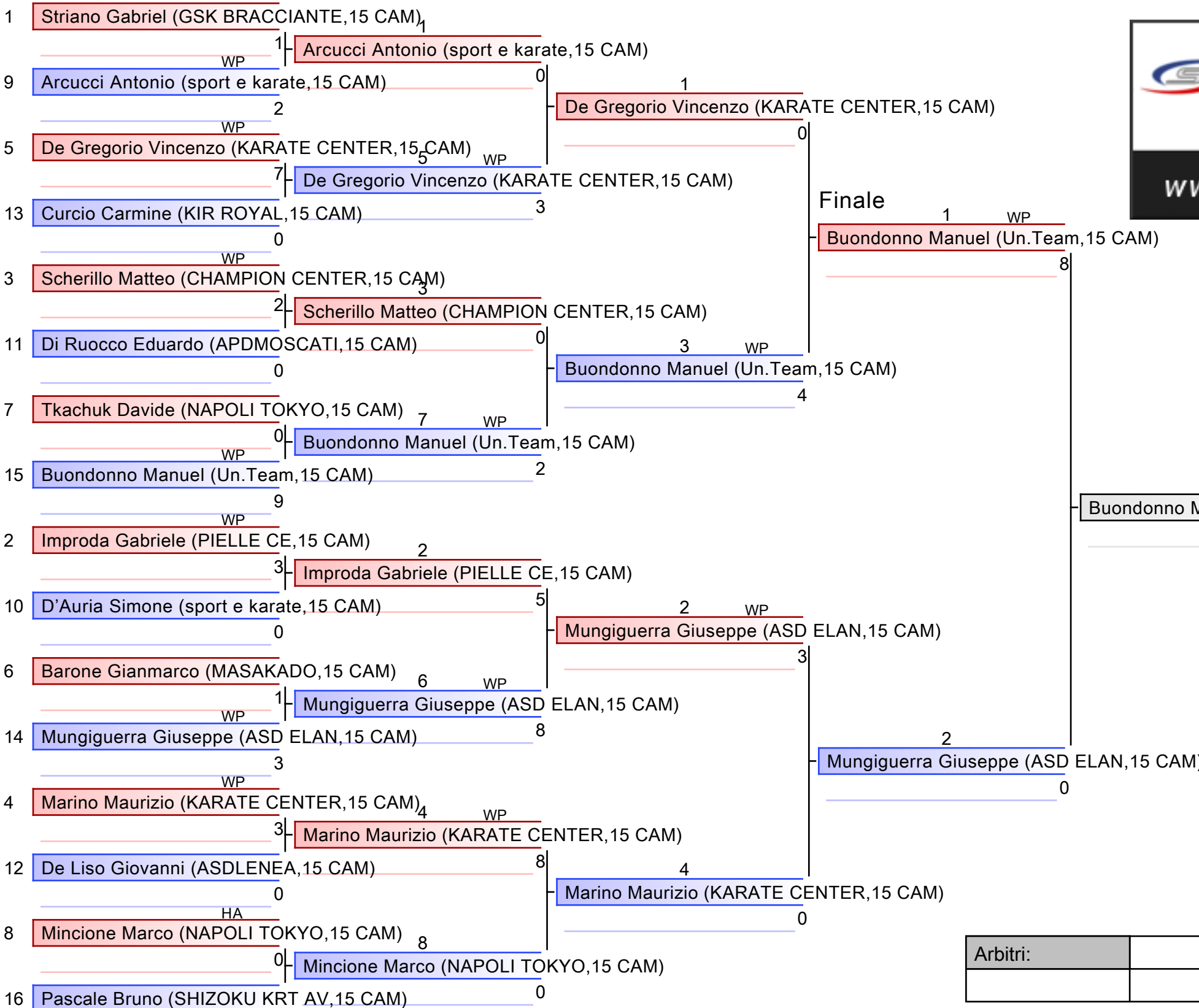

- | |
|---|
| 1. BUONDONNO MANUEL (UN.TEAM, 15 CAM) |
| 2. MUNGIGUERRA GIUSEPPE (ASD ELAN, 15 CAM) |
| 3. DE GREGORIO VINCENZO (KARATE CENTER, 15 CAM) |
| 3. IMPRODA GABRIELE (PIELLE CE, 15 CAM) |
| 5. SCHERILLO MATTEO (CHAMPION CENTER, 15 CAM) |
| 5. MARINO MAURIZIO (KARATE CENTER, 15 CAM) |
| 7. TKACHUK DAVIDE (NAPOLI TOKYO, 15 CAM) |
| 7. BARONE GIANMARCO (MASAKADO, 15 CAM) |

Arbitri:			

ESORDIENTI M KUMITE 68 KG

15-FRQ_ESORDIENTI_KA_KU KARATE CAMPANIA, Via Matilde Serao 17b, località Carivita Cercola, ITA

2024-05-12

Tatami

2 16:50

Tabelloni - Pool

1/1

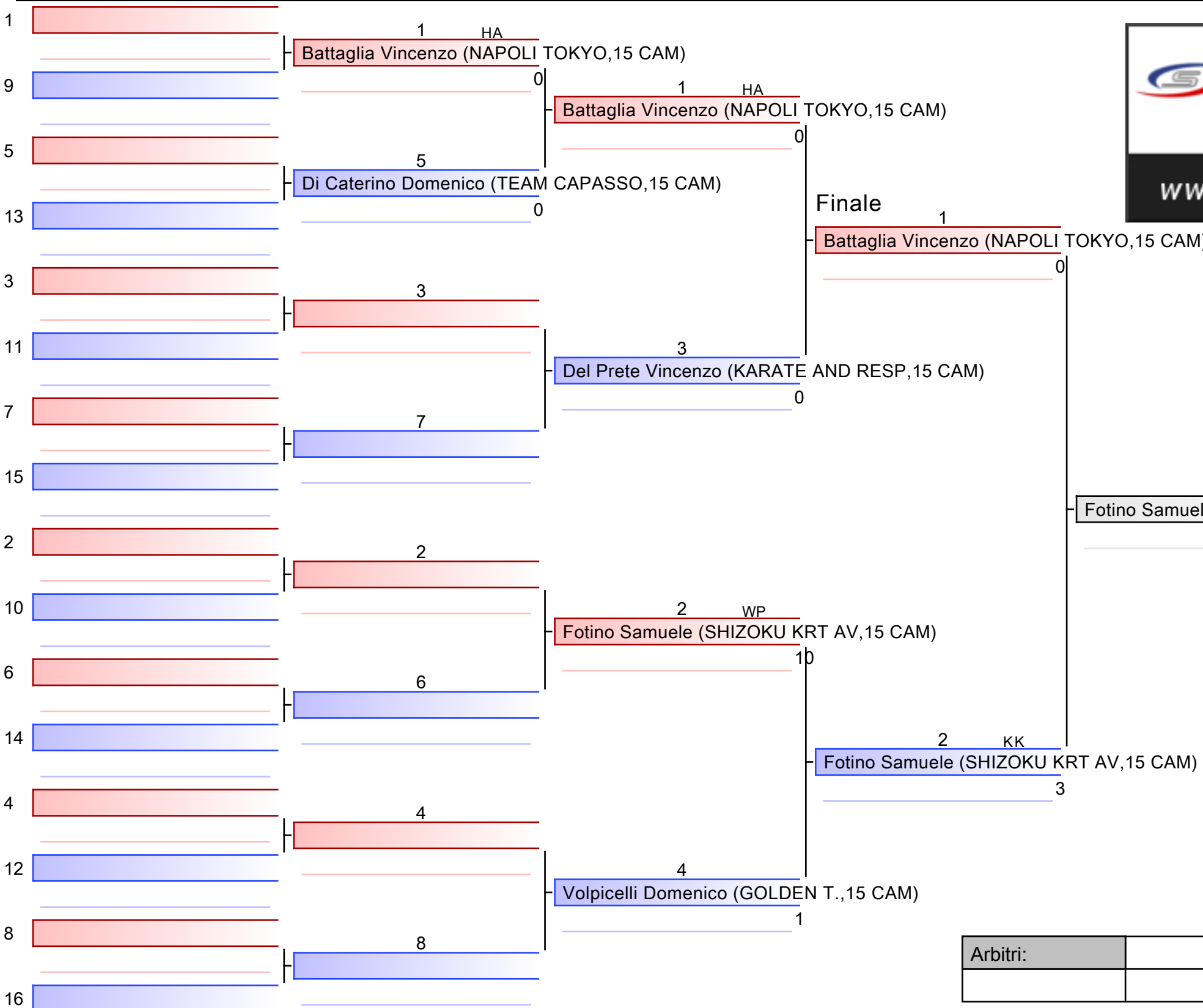

1. FOTINO SAMUELE (SHIZOKU KRT AV, 15 CAM)
2. BATTAGLIA VINCENZO (NAPOLI TOKYO, 15 CAM)
3. VOLPICELLI DOMENICO (GOLDEN T., 15 CAM)
3. DEL PRETE VINCENZO (KARATE AND RESP, 15 CAM)
5. DI CATERINO DOMENICO (TEAM CAPASSO, 15 CAM)

Arbitri:			

ESORDIENTI M KUMITE 75 KG - Girone all'Italiana (tutti contro tutti)

15-FRQ_ESORDIENTI_KA_KU KARATE CAMPANIA, Via Matilde Serao 17b, località Carivita Cercola, ITA

2024-05-12

Tatami

3 17:05

Tabelloni - Pool

1/1

- 1 Iacullo Luigi (CSKI AIROLA, 15 CAM)
 WP 0 | Pagano Carmine (SHIZOKU KRT AV, 15 CAM)
- 2 Pagano Carmine (SHIZOKU KRT AV, 15 CAM)
 5
- 3 Palumbo Andrea (ARTS RECALE, 15 CAM)
 HA 0 | Iacullo Luigi (CSKI AIROLA, 15 CAM)
- 4 Iacullo Luigi (CSKI AIROLA, 15 CAM)
 0 WP
- 5 Pagano Carmine (SHIZOKU KRT AV, 15 CAM)
 2 | Pagano Carmine (SHIZOKU KRT AV, 15 CAM)
- 6 Palumbo Andrea (ARTS RECALE, 15 CAM)
 0



1. PAGANO CARMINE (SHIZOKU KRT AV, 15 CAM)
2. IACULLO LUIGI (CSKI AIROLA, 15 CAM)
3. PALUMBO ANDREA (ARTS RECALE, 15 CAM)

Arbitri:			

ESORDIENTI M KUMITE 75+ KG

15-FRQ_ESORDIENTI_KA_KU KARATE CAMPANIA, Via Matilde Serao 17b, località Carivita Cercola, ITA

2024-05-12

Tatami

1 17:00

Tabelloni - Pool

1/1

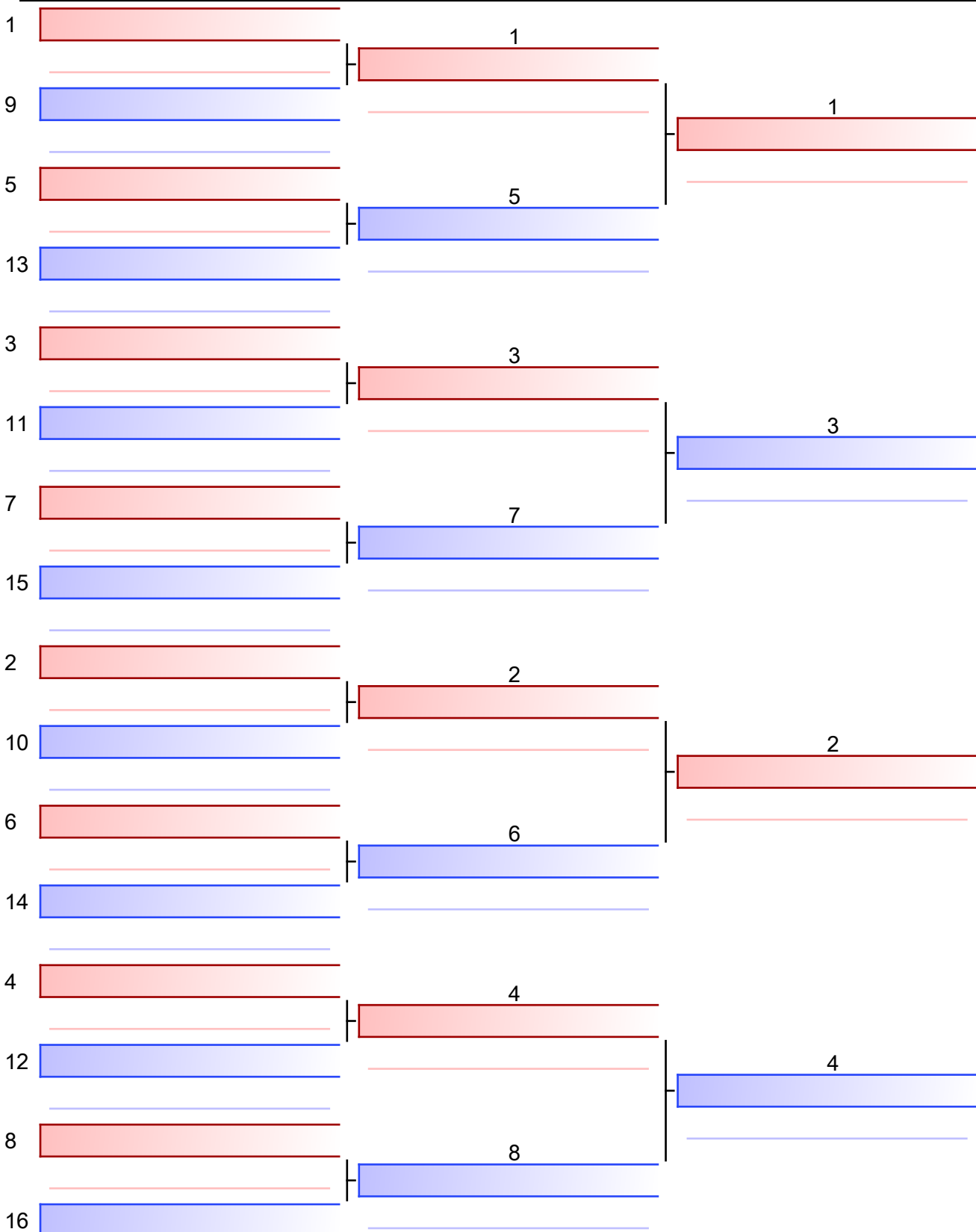

Finale

1 WP
Russo Giuseppe Pio (TEAM CAPASSO, 15 CAM)

Russo Giuseppe Pio (TEAM CAPASSO, 15 CAM)

2
Capoluongo Antonio Samuele (TEAM CAPASSO, 15 CAM)

1. RUSSO GIUSEPPE PIO (TEAM CAPASSO, 15 CAM)
2. CAPOLUONGO ANTONIO SAMUELE (TEAM CAPASSO, 15 CAM)

Arbitri:			

ESORDIENTI F KATA

15-FRQ_ESORDIENTI_KA_KU KARATE CAMPANIA

2024-05-12

Tatami

1 09:00

Tabelloni - Pool

1

(c)sportdata GmbH & Co KG 2000-2024 (2024-05-12 19:34) v 10.1.0 build 1 (2024-02-07 18:12 CET) Licenza: Online_Event_ID-118_15FRQESORDIENTIKAKUKARATECAMPANIA (expire 2024-05-26)

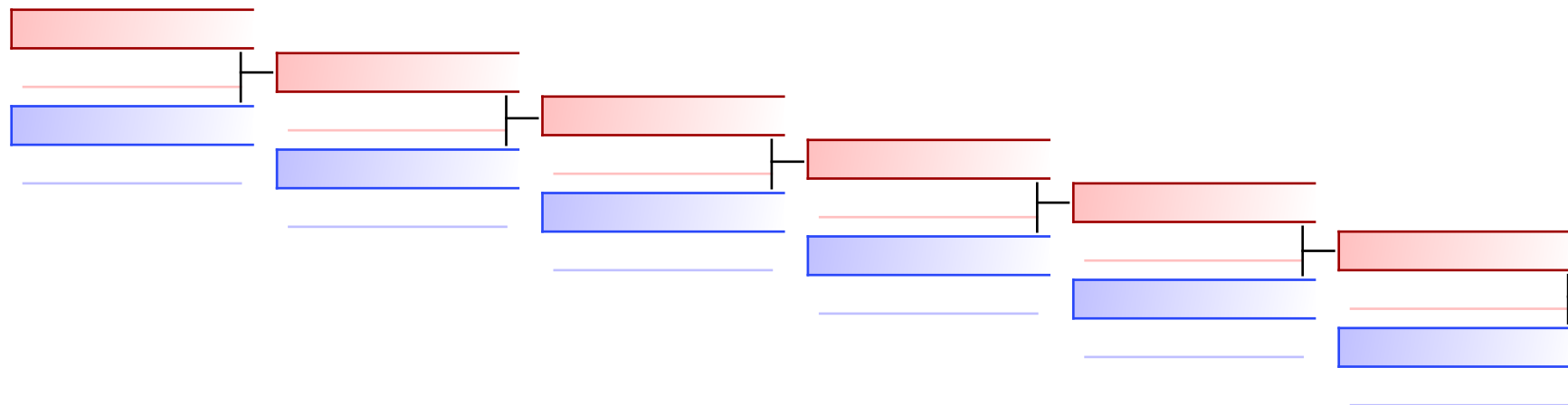

Lara Viola (Un.Team, 15 CAM)

064 Ohan Dai 2020

Iannone Andreana (LIFE CHAMPION, 15 CAM)

Iannone Andreana (LIFE CHAMPION, 15 CAM)

068 Papuren 2180

Ripescaggi: (1)

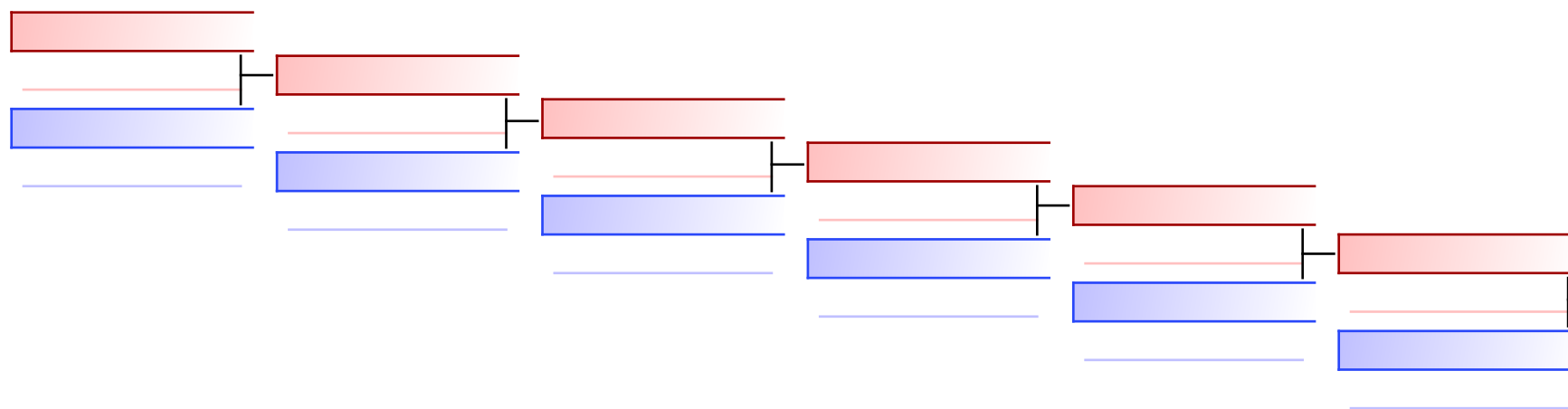

Cifelli Sara (Un.Team, 15 CAM)

064 Ohan Dai 1970

Gualberti Melanie (LIFE CHAMPION, 15 CAM)

Gualberti Melanie (LIFE CHAMPION, 15 CAM)

030 Heiku 2130

Arbitri:							
----------	--	--	--	--	--	--	--

ESORDIENTI F KUMITE 35 KG

15-FRQ_ESORDIENTI_KA_KU KARATE CAMPANIA

2024-05-12

Tatami

2 11:00

Tabelloni - Pool

1

(c)sportdata GmbH & Co KG 2000-2024 (2024-05-12 19:34) v 10.1.0 build 1 (2024-02-07 18:12 CET) Licenza: Online_Event_ID-118_15FRQESORDIENTIKAKUKARATECAMPANIA (expire 2024-05-26)

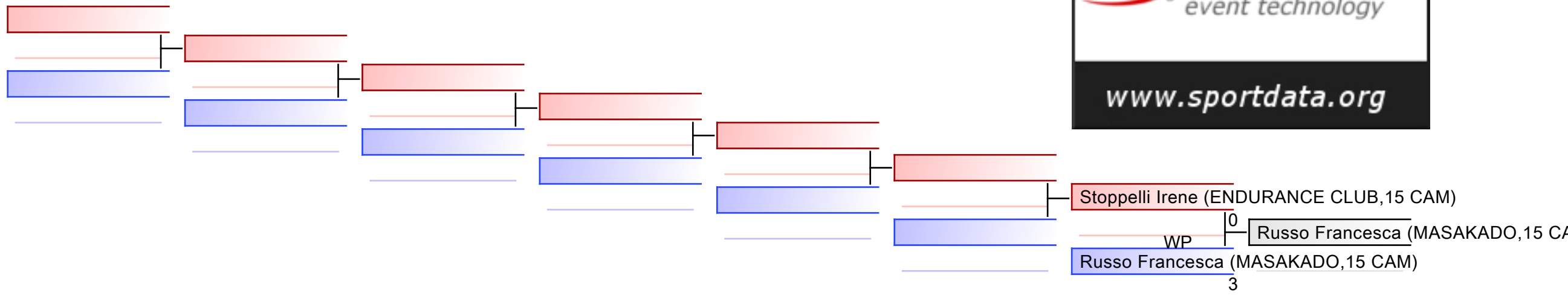

Ripescaggi: (1)

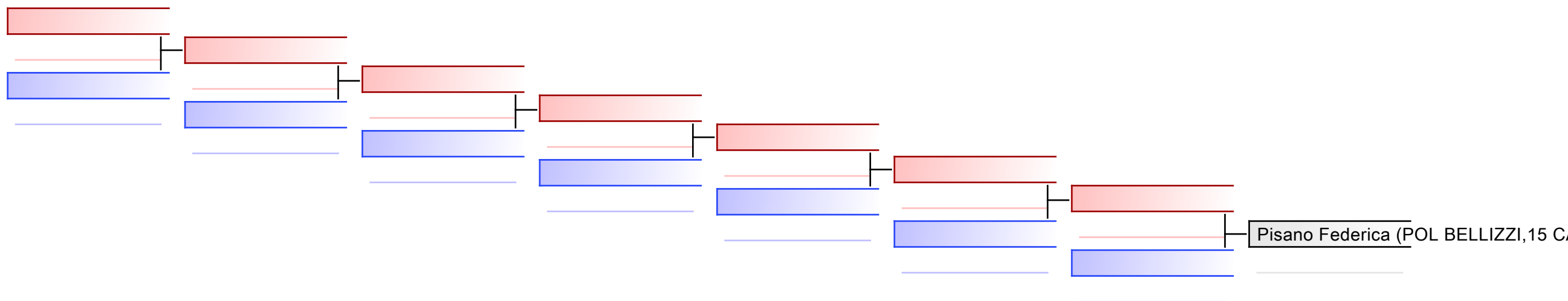

Arbitri:							
----------	--	--	--	--	--	--	--

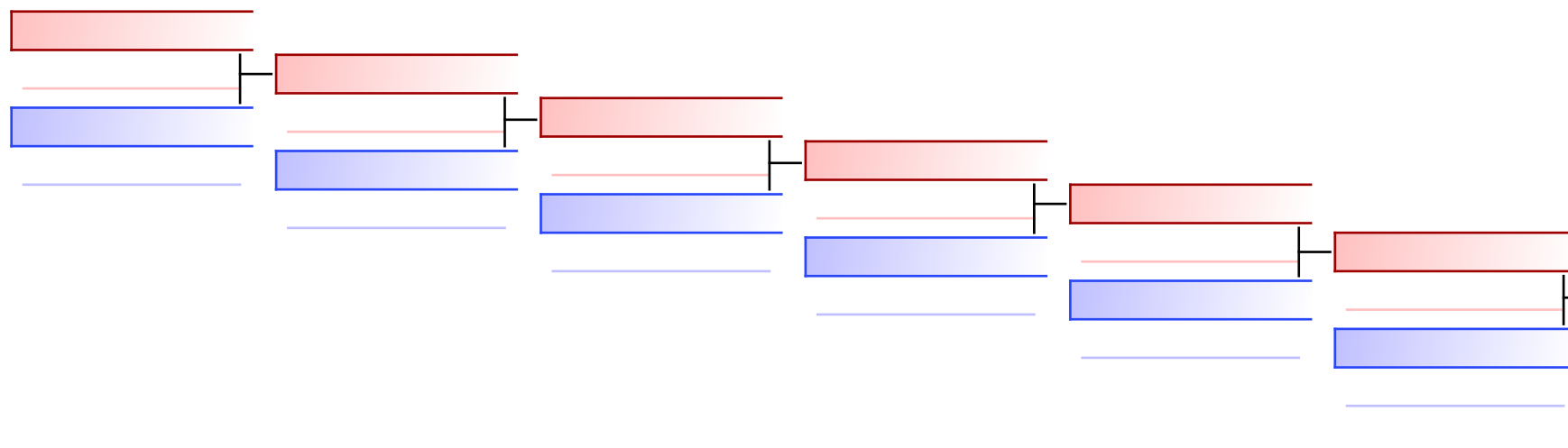

WH
 Pantaleo Alice Maria (KIR ROYAL, 15 CAM) 0
 Cioffi Ilenia (SHIRAI CLUB, 15 CAM) 0

Ripescaggi: (1)

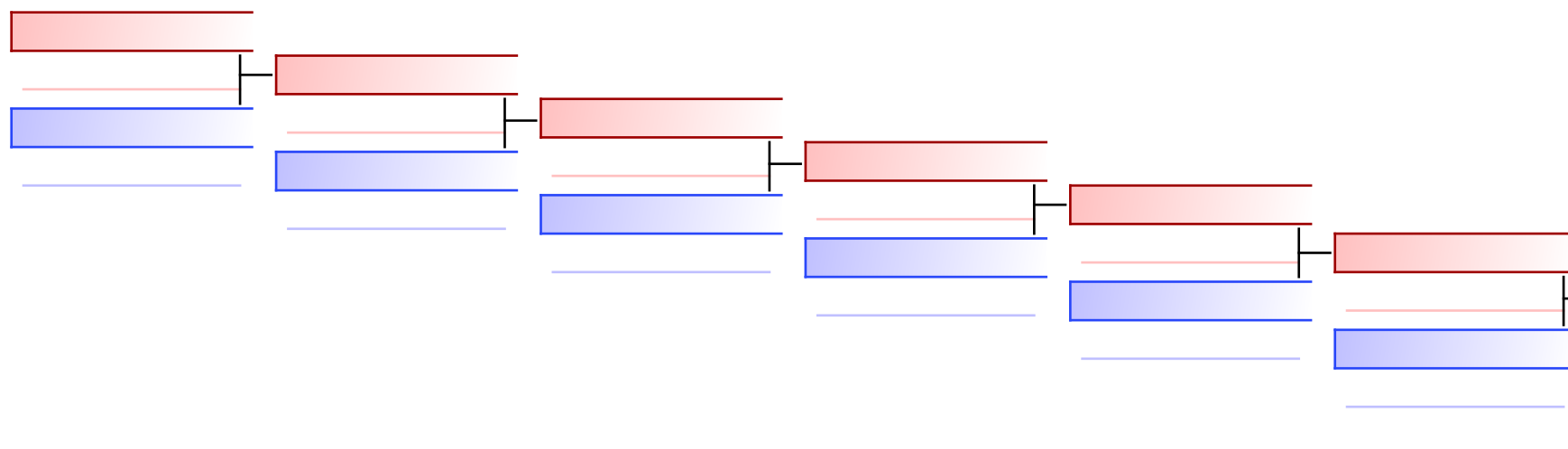

WP
 Cucci Alessia (POL BELLIZZI, 15 CAM) 3
 Megale Alessandra (PIELLE CE, 15 CAM) 0

Arbitri:							
----------	--	--	--	--	--	--	--

ESORDIENTI F KUMITE 45 KG

15-FRQ_ESORDIENTI_KA_KU KARATE CAMPANIA

2024-05-12

Tatami

1 11:00

Tabelloni - Pool

1

(c)sportdata GmbH & Co KG 2000-2024 (2024-05-12 19:34) v 10.1.0 build 1 (2024-02-07 18:12 CET) Licenza: Online_Event_ID-118_15FRQESORDIENTIKAKUKARATECAMPANIA (expire 2024-05-26)

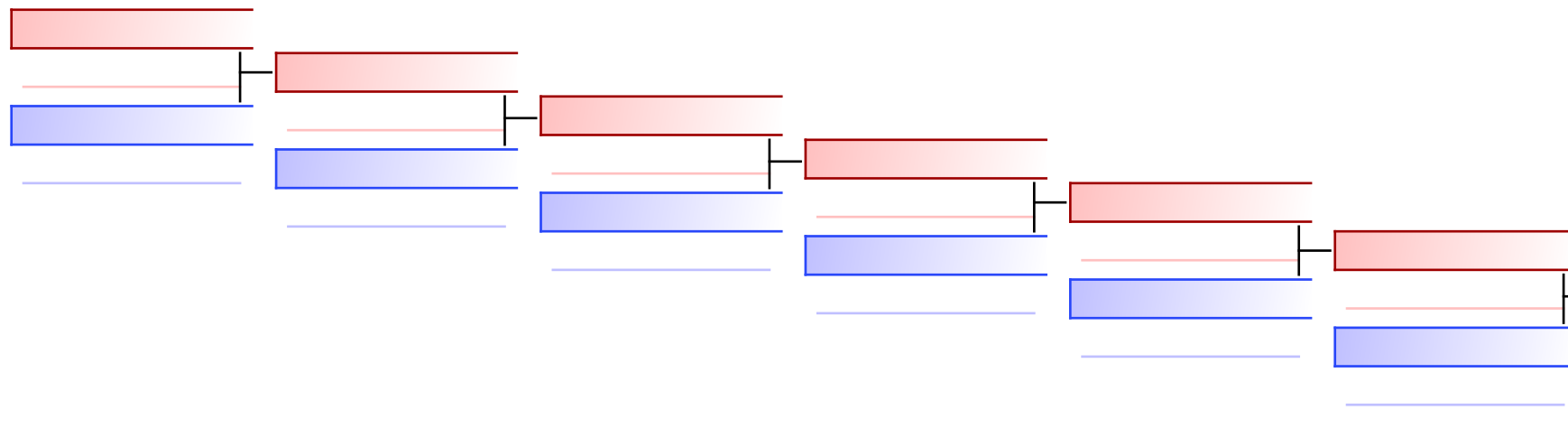

Ragone Benedetta (DANDREA KARATE, 15 CAM)

0 Vaiano Giorgia (ASD EVER GREEN, 15 CAM)

HA

Vaiano Giorgia (ASD EVER GREEN, 15 CAM)

3

Ripescaggi: (1)

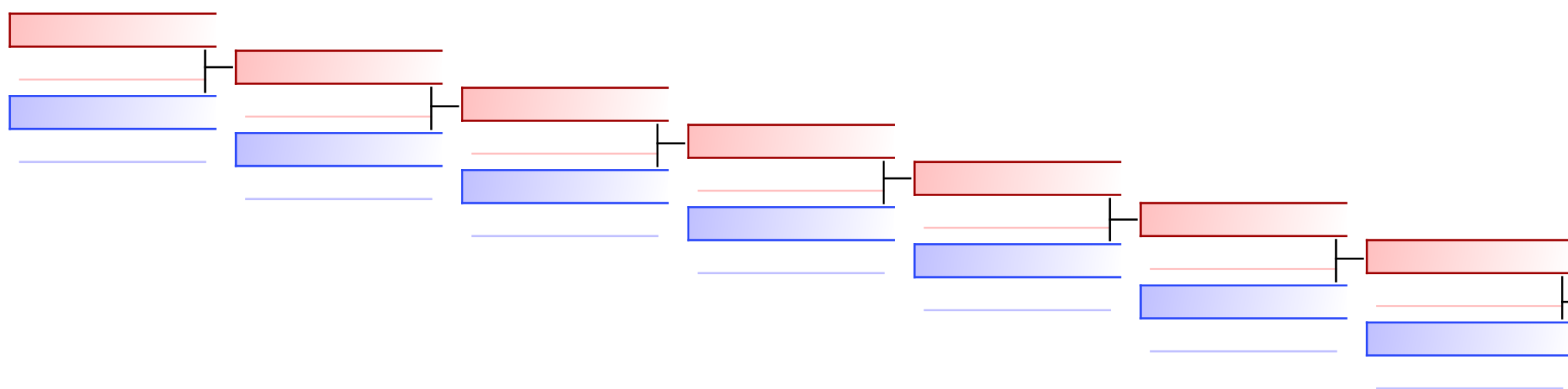

Pylypiv Darina (ASDLENEA, 15 CAM)

Arbitri:							
----------	--	--	--	--	--	--	--

ESORDIENTI F KUMITE 50 KG

15-FRQ_ESORDIENTI_KA_KU KARATE CAMPANIA

2024-05-12

Tatami

1 12:15

Tabelloni - Pool

(c)sportdata GmbH & Co KG 2000-2024 (2024-05-12 19:34) v 10.1.0 build 1 (2024-02-07 18:12 CET) Licenza: Online_Event_ID-118_15FRQESORDIENTIKAKUKARATECAMPANIA (expire 2024-05-26)

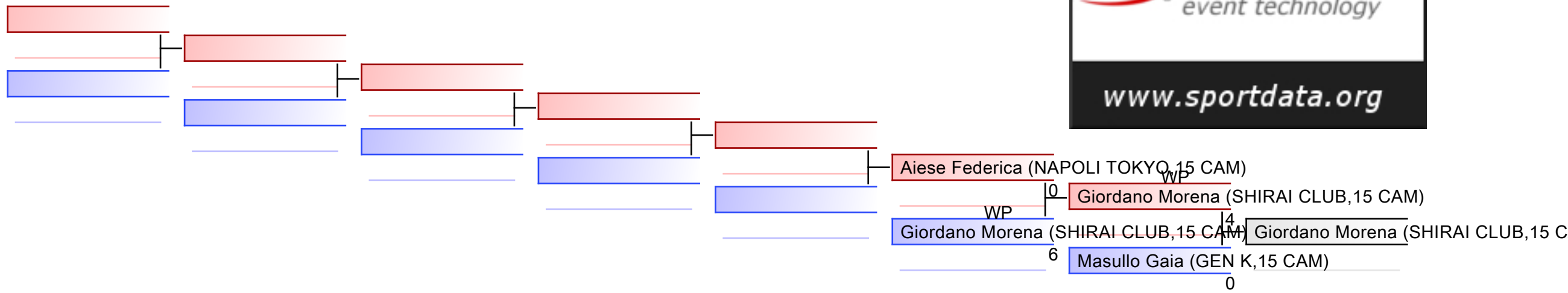

Ripescaggi: (1)

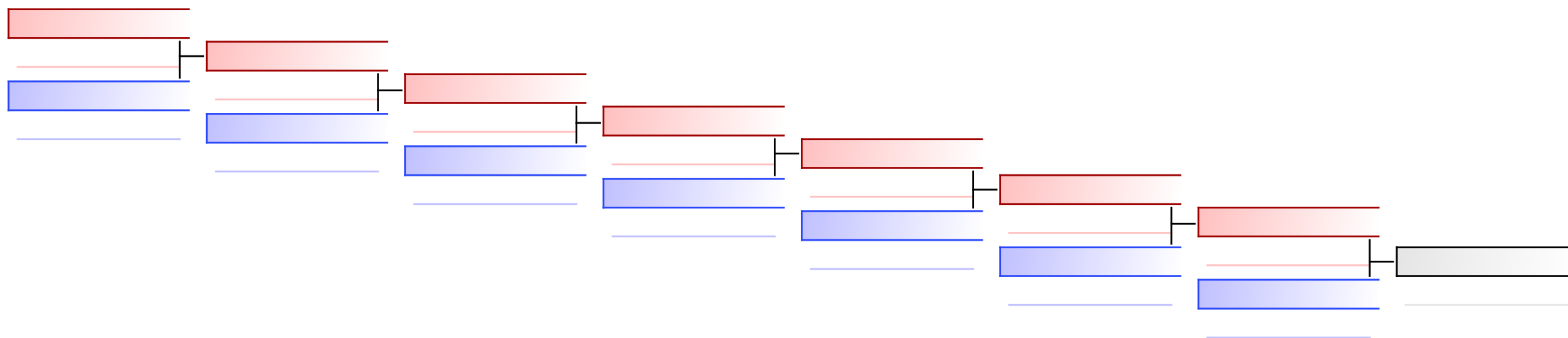

Arbitri:							
----------	--	--	--	--	--	--	--

ESORDIENTI F KUMITE 50 KG

15-FRQ_ESORDIENTI_KA_KU KARATE CAMPANIA

2024-05-12

Tatami

1 12:35

Tabelloni - Pool

2

(c)sportdata GmbH & Co KG 2000-2024 (2024-05-12 19:34) v 10.1.0 build 1 (2024-02-07 18:12 CET) Licenza: Online_Event_ID-118_15FRQESORDIENTIKAKUKARATECAMPANIA (expire 2024-05-26)

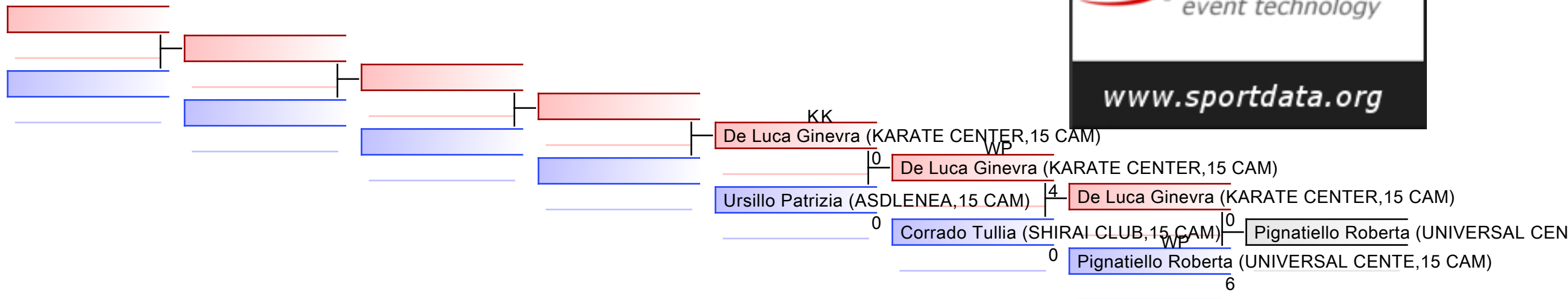

Ripescaggi: (2)

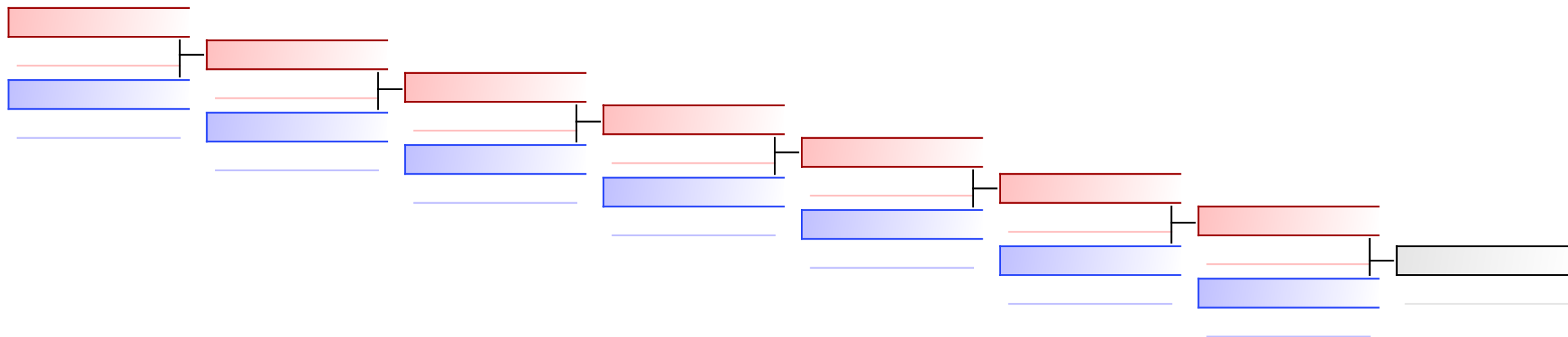

Arbitri:							
----------	--	--	--	--	--	--	--

ESORDIENTI F KUMITE 56 KG

15-FRQ_ESORDIENTI_KA_KU KARATE CAMPANIA

2024-05-12

Tatami

3 11:00

Tabelloni - Pool

1

(c)sportdata GmbH & Co KG 2000-2024 (2024-05-12 19:34) v 10.1.0 build 1 (2024-02-07 18:12 CET) Licenza: Online_Event_ID-118_15FRQESORDIENTIKAKUKARATECAMPANIA (expire 2024-05-26)

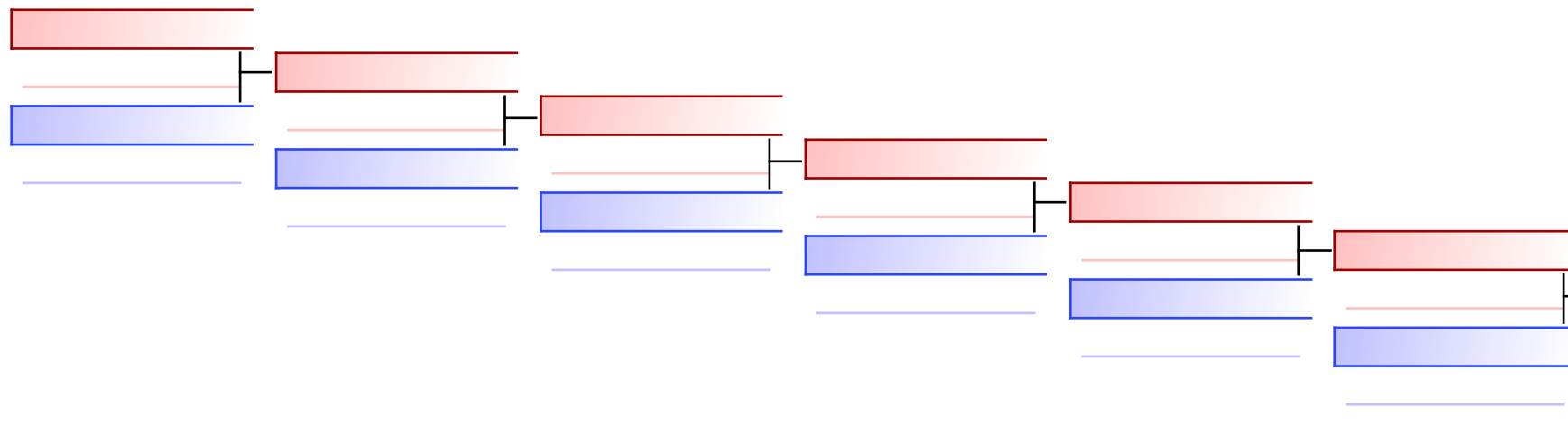

Vitagliano Liliana (KARATE AND RESP,15 CAM)

WP

0

5

Tomasetta Gaia (SHIZOKU KRT AV,15 CAM)

Tomasetta Gaia (SHIZOKU KRT AV,15 CAM)

Ripescaggi: (1)

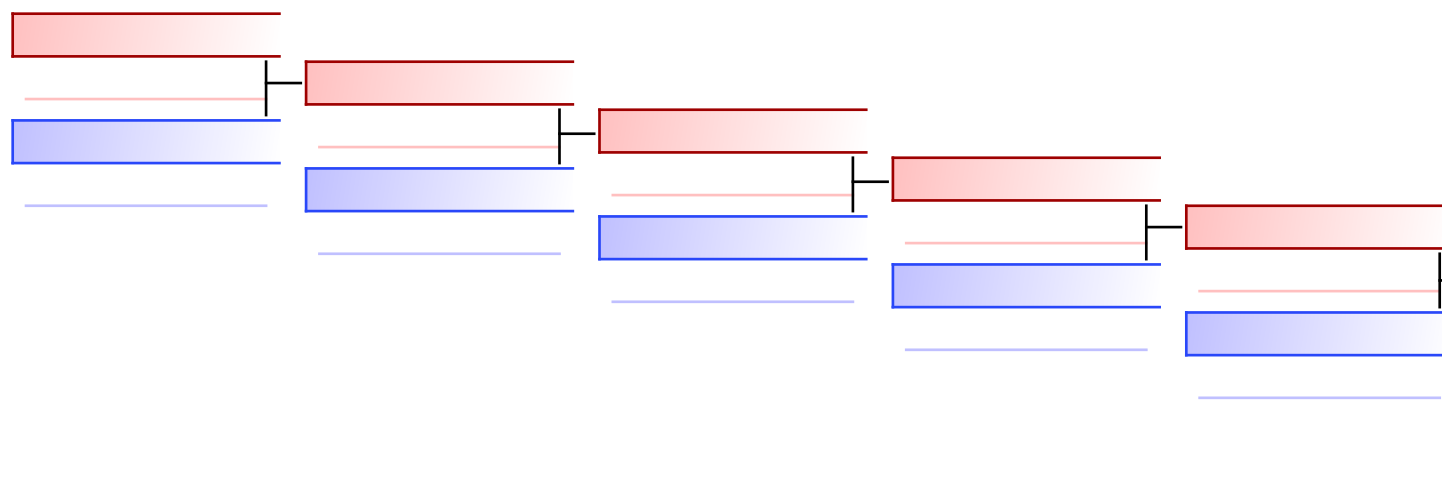

WP

Ingenito Gaia (SHIRAI CLUB,15 CAM)

WP

5

Ingenito Gaia (SHIRAI CLUB,15 CAM)

De Micco Alessandra (SHIZOKU KRT AV,15 CAM)

5

Ingenito Gaia (SHIRAI CLUB,15 CAM)

Dubbiosi Aurora (SHIZOKU KRT AV,15 CAM)

1

1

Arbitri:							
----------	--	--	--	--	--	--	--

ESORDIENTI F KUMITE 62 KG

15-FRQ_ESORDIENTI_KA_KU KARATE CAMPANIA

2024-05-12

Tatami
2 12:15

Tabelloni - Pool
1

(c)sportdata GmbH & Co KG 2000-2024 (2024-05-12 19:34) v 10.1.0 build 1 (2024-02-07 18:12 CET) Licenza: Online_Event_ID-118_15FRQESORDIENTIKAKUKARATECAMPANIA (expire 2024-05-26)

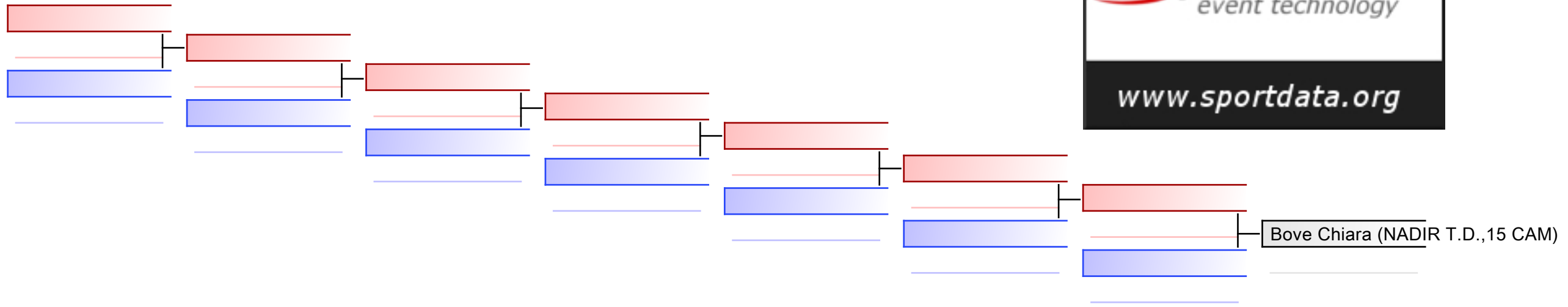

Ripescaggi: (1)

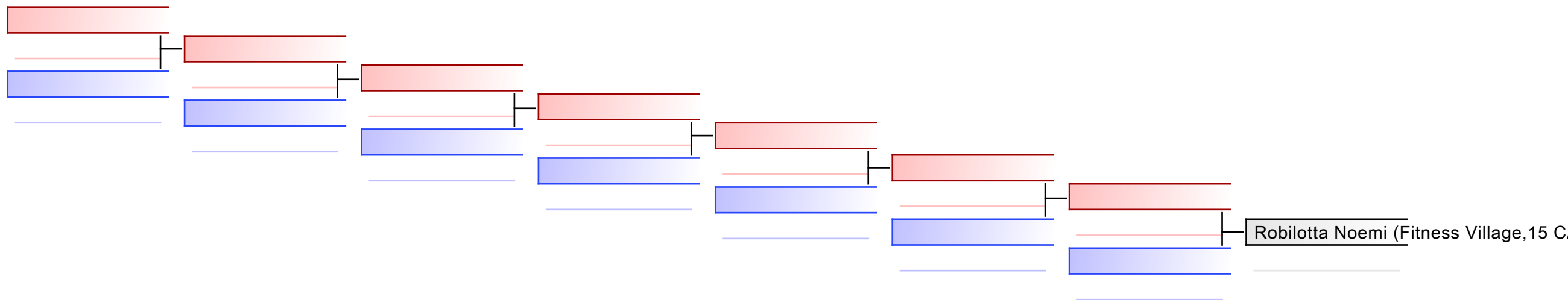

Arbitri:							
----------	--	--	--	--	--	--	--

ESORDIENTI M KATA

15-FRQ_ESORDIENTI_KA_KU KARATE CAMPANIA

2024-05-12

Tatami

3 10:00

Tabelloni - Pool

2

(c)sportdata GmbH & Co KG 2000-2024 (2024-05-12 19:34) v 10.1.0 build 1 (2024-02-07 18:12 CET) Licenza: Online_Event_ID-118_15FRQESORDIENTIKAKUKARATECAMPANIA (expire 2024-05-26)

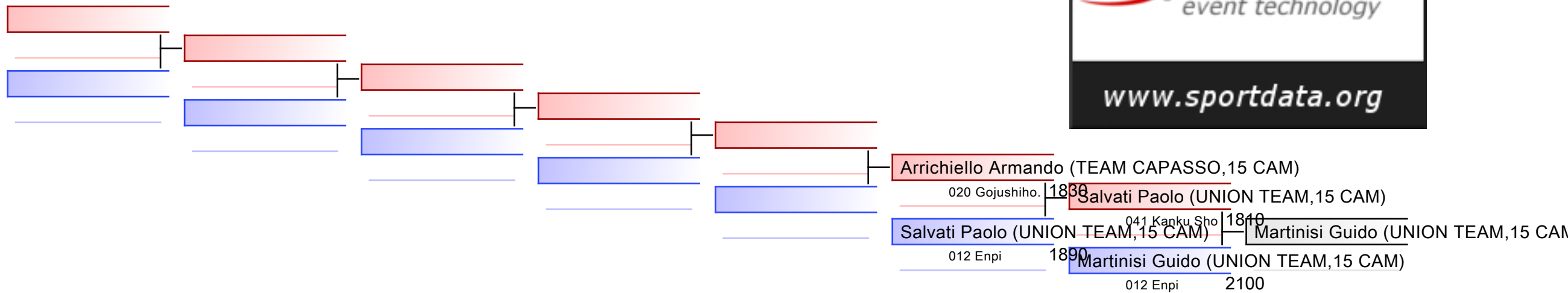

Ripescaggi: (2)

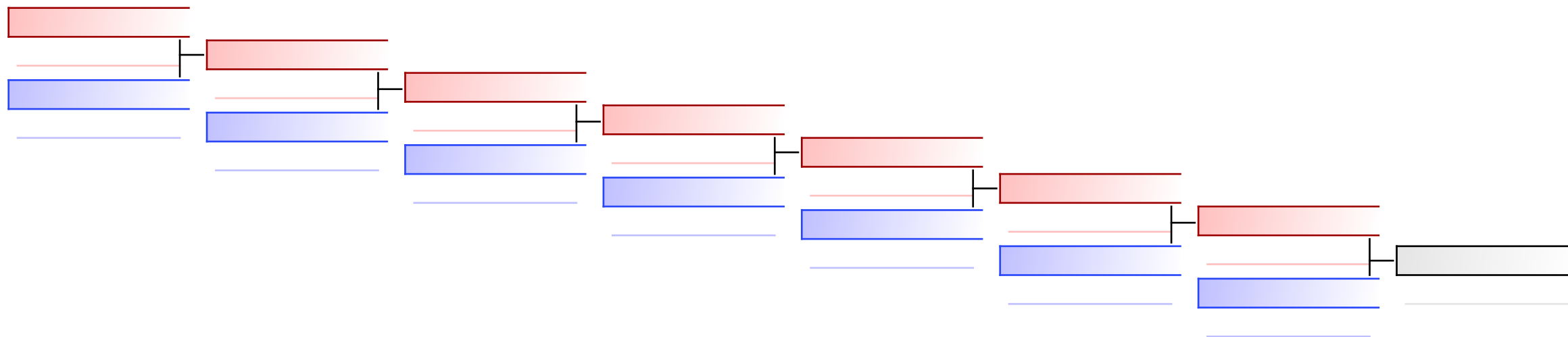

Arbitri:							
----------	--	--	--	--	--	--	--

ESORDIENTI M KATA

15-FRQ_ESORDIENTI_KA_KU KARATE CAMPANIA

2024-05-12

Tatami

2 10:00

Tabelloni - Pool

1

(c)sportdata GmbH & Co KG 2000-2024 (2024-05-12 19:34) v 10.1.0 build 1 (2024-02-07 18:12 CET) Licenza: Online_Event_ID-118_15FRQESORDIENTIKAKUKARATECAMPANIA (expire 2024-05-26)

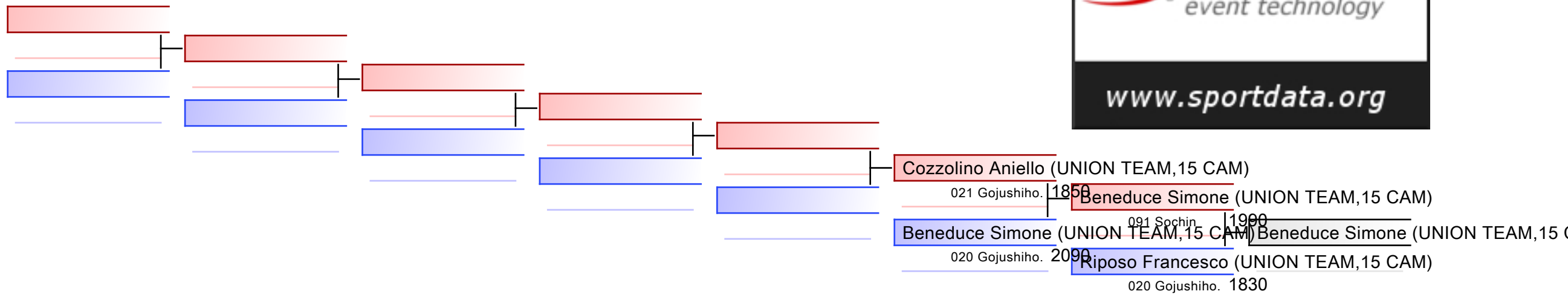

Ripescaggi: (1)

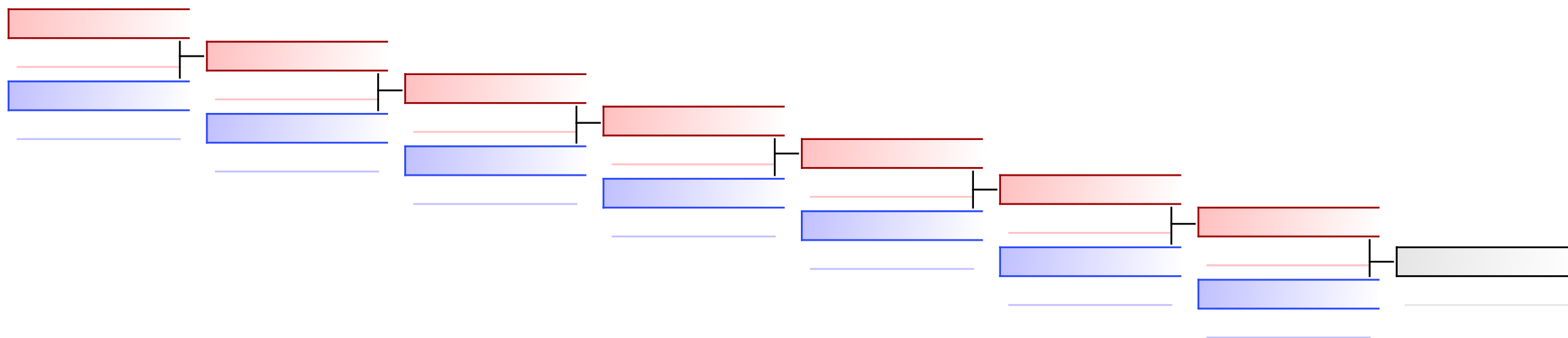

Arbitri:							
----------	--	--	--	--	--	--	--

ESORDIENTI M KUMITE 38 KG
 15-FRQ_ESORDIENTI_KA_KU KARATE CAMPANIA

2024-05-12

Tatami 1 13:15
 Tabelloni - Pool 1

(c)sportdata GmbH & Co KG 2000-2024 (2024-05-12 19:34) v 10.1.0 build 1 (2024-02-07 18:12 CET) Licenza: Online_Event_ID-118_15FRQESORDIENTIKAKUKARATECAMPANIA (expire 2024-05-26)

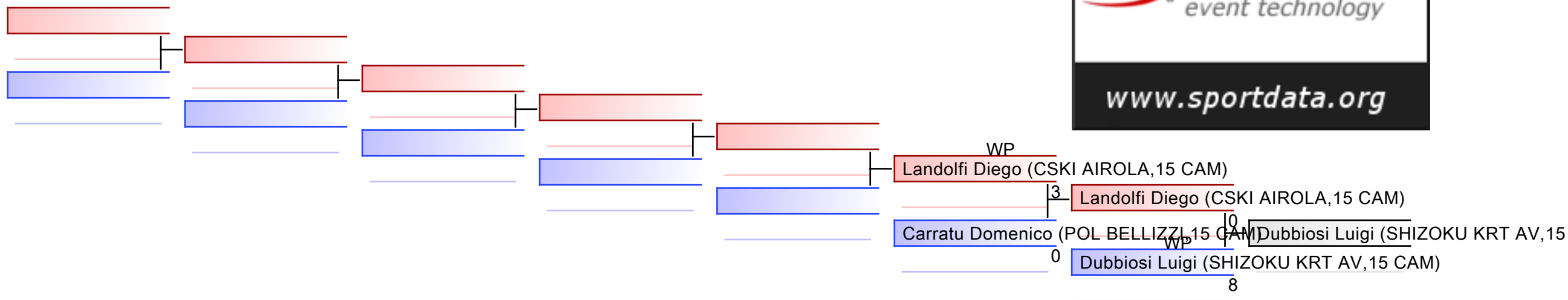

Ripescaggi: (1)

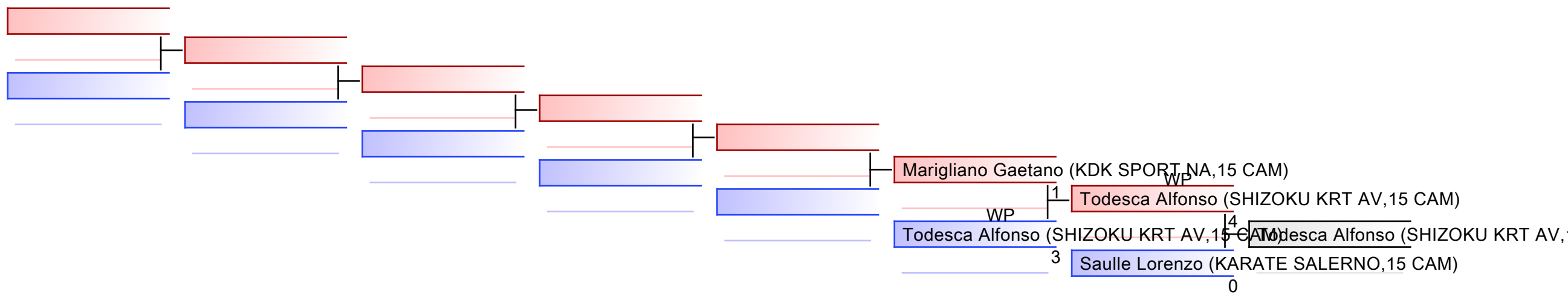

Arbitri:							
----------	--	--	--	--	--	--	--

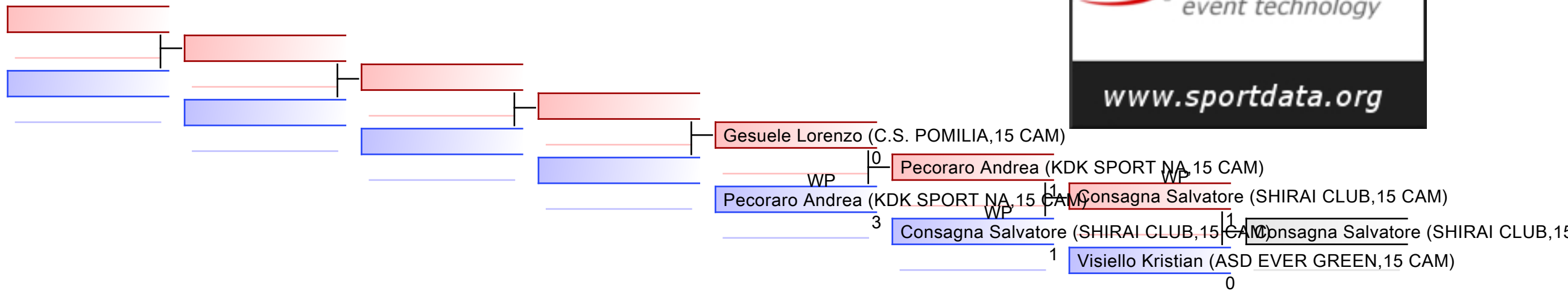

Ripescaggi: (1)

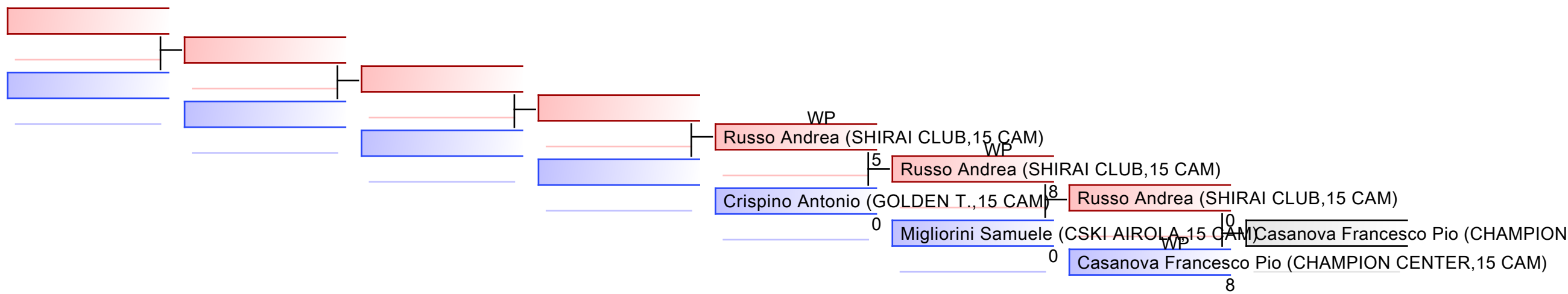

Arbitri:							
----------	--	--	--	--	--	--	--

ESORDIENTI M KUMITE 48 KG

15-FRQ_ESORDIENTI_KA_KU KARATE CAMPANIA

2024-05-12

Tatami

1 14:50

Tabelloni - Pool

1

(c)sportdata GmbH & Co KG 2000-2024 (2024-05-12 19:34) v 10.1.0 build 1 (2024-02-07 18:12 CET) Licenza: Online_Event_ID-118_15FRQESORDIENTIKAKUKARATECAMPANIA (expire 2024-05-26)

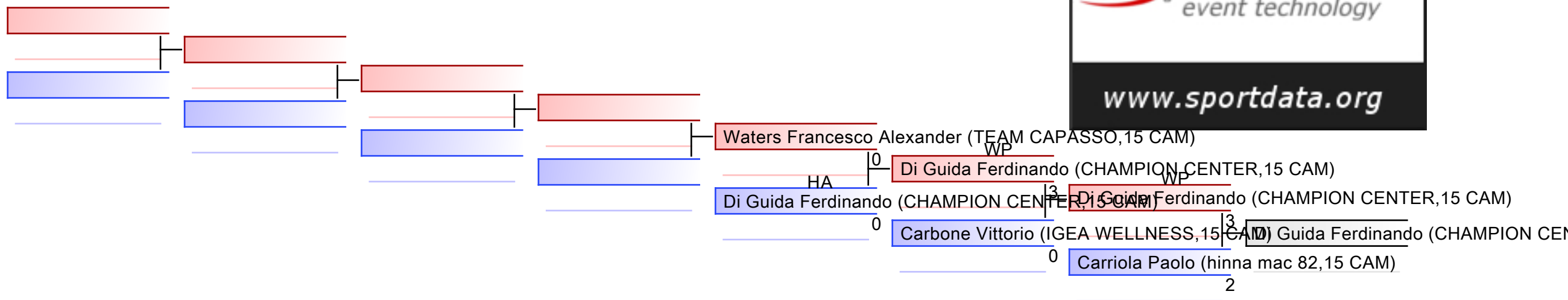

Ripescaggi: (1)

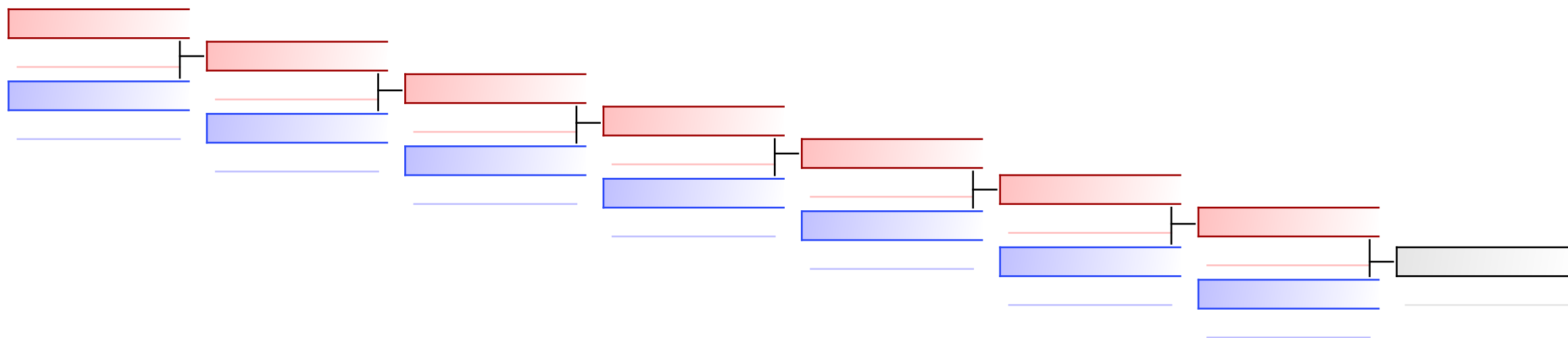

Arbitri:							
----------	--	--	--	--	--	--	--

ESORDIENTI M KUMITE 48 KG

15-FRQ_ESORDIENTI_KA_KU KARATE CAMPANIA

2024-05-12

Tatami

1 14:50

Tabelloni - Pool

2

(c)sportdata GmbH & Co KG 2000-2024 (2024-05-12 19:34) v 10.1.0 build 1 (2024-02-07 18:12 CET) Licenza: Online_Event_ID-118_15FRQESORDIENTIKAKUKARATECAMPANIA (expire 2024-05-26)

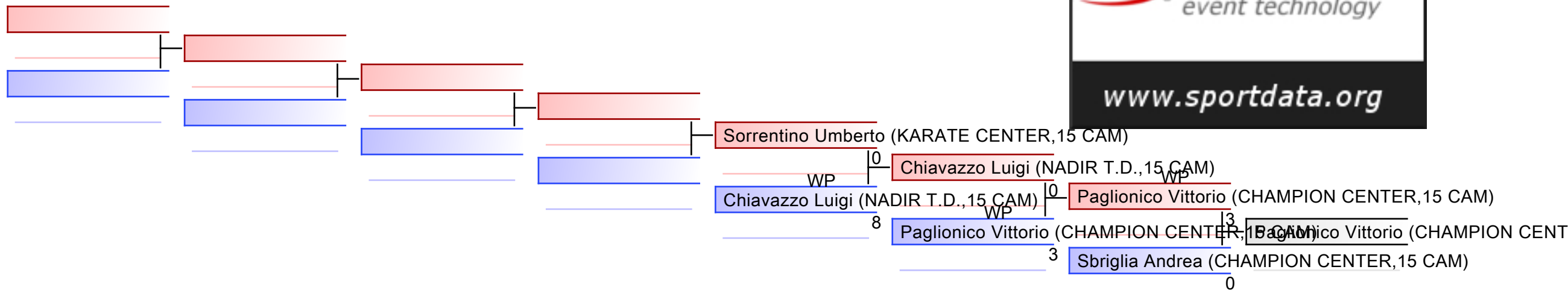

Ripescaggi: (2)

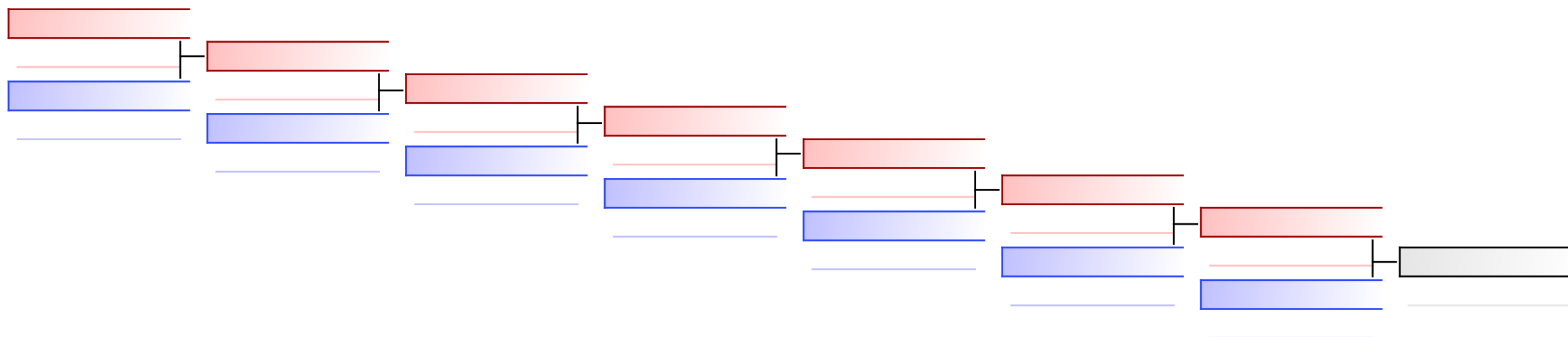

Arbitri:							
----------	--	--	--	--	--	--	--

ESORDIENTI M KUMITE 53 KG

15-FRQ_ESORDIENTI_KA_KU KARATE CAMPANIA

2024-05-12

Tatami

3 13:15

Tabelloni - Pool

1,2

(c)sportdata GmbH & Co KG 2000-2024 (2024-05-12 19:34) v 10.1.0 build 1 (2024-02-07 18:12 CET) Licenza: Online_Event_ID-118_15FRQESORDIENTIKAKUKARATECAMPANIA (expire 2024-05-26)

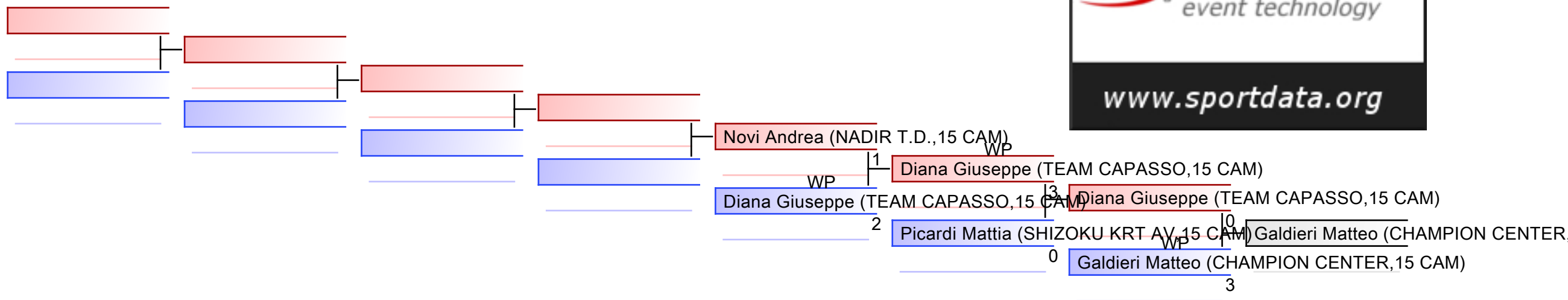

Ripescaggi: (1,2)

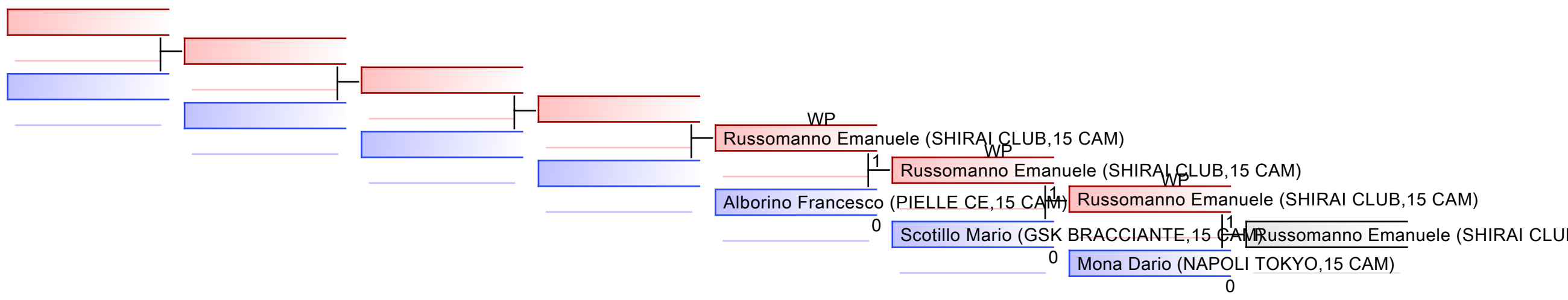

Arbitri:							
----------	--	--	--	--	--	--	--

ESORDIENTI M KUMITE 58 KG
15-FRQ_ESORDIENTI_KA_KU KARATE CAMPANIA

2024-05-12

Tatami 2 13:15
Tabelloni - Pool 1

(c)sportdata GmbH & Co KG 2000-2024 (2024-05-12 19:34) v 10.1.0 build 1 (2024-02-07 18:12 CET) Licenza: Online_Event_ID-118_15FRQESORDIENTIKAKUKARATECAMPANIA (expire 2024-05-26)

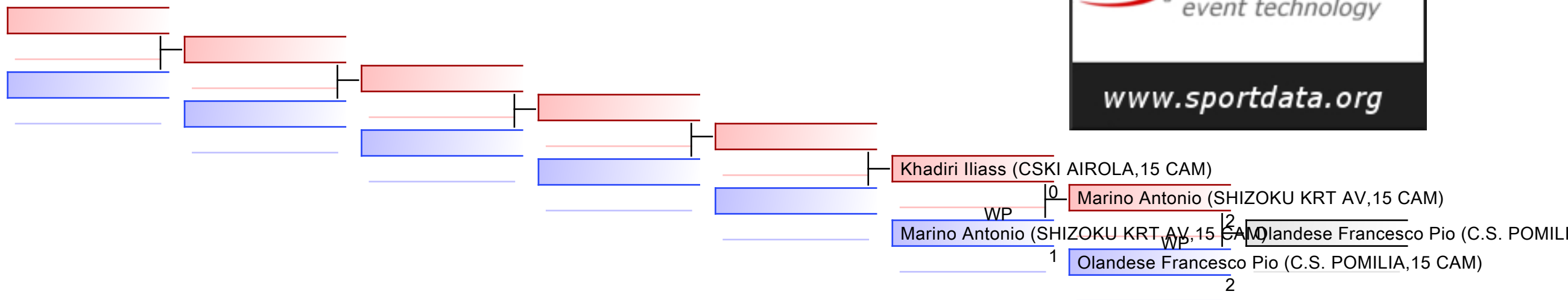

Ripescaggi: (1)

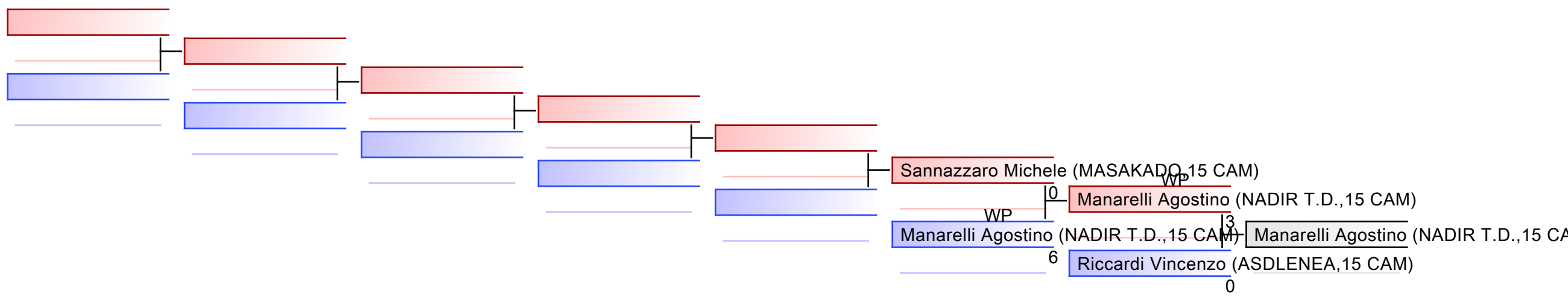

Arbitri:							
----------	--	--	--	--	--	--	--

ESORDIENTI M KUMITE 63 KG

15-FRQ_ESORDIENTI_KA_KU KARATE CAMPANIA

2024-05-12

Tatami

3 15:40

Tabelloni - Pool

1

(c)sportdata GmbH & Co KG 2000-2024 (2024-05-12 19:34) v 10.1.0 build 1 (2024-02-07 18:12 CET) Licenza: Online_Event_ID-118_15FRQESORDIENTIKAKUKARATECAMPANIA (expire 2024-05-26)

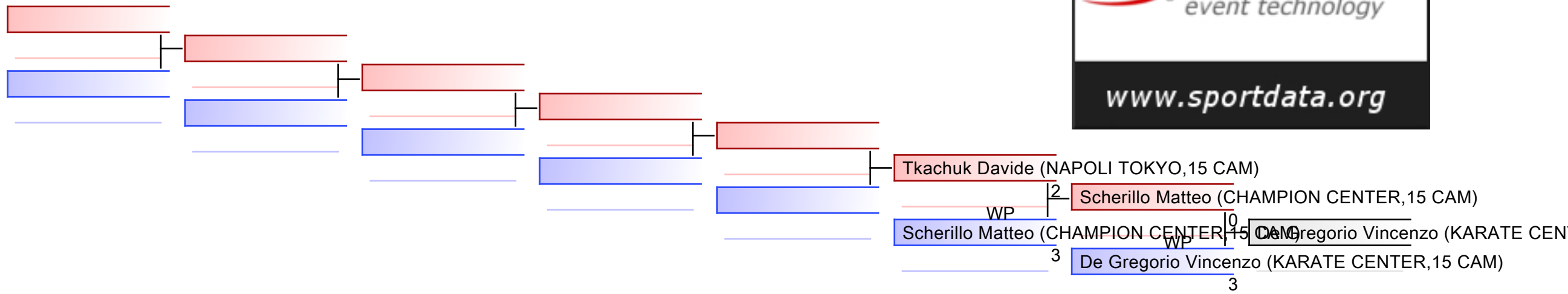

Ripescaggi: (1)

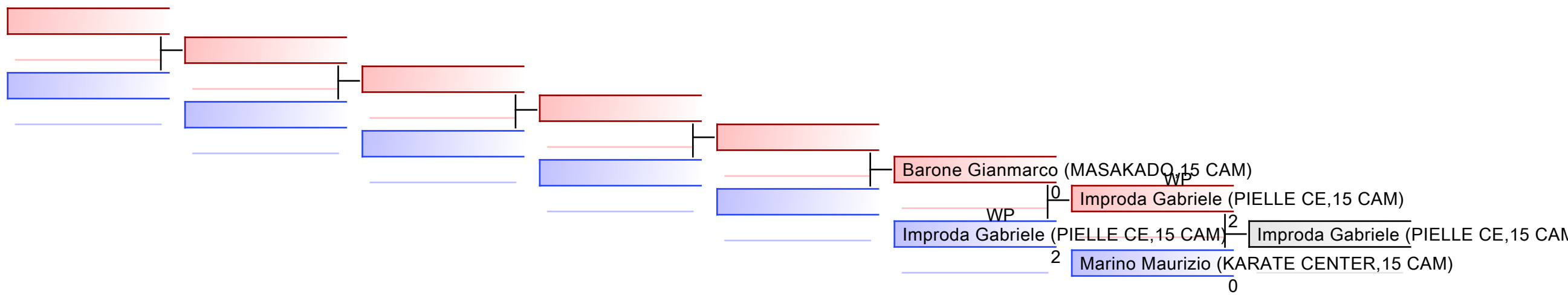

Arbitri:							
----------	--	--	--	--	--	--	--

ESORDIENTI M KUMITE 68 KG

15-FRQ_ESORDIENTI_KA_KU KARATE CAMPANIA

2024-05-12

Tatami

2 16:50

Tabelloni - Pool

1

(c)sportdata GmbH & Co KG 2000-2024 (2024-05-12 19:34) v 10.1.0 build 1 (2024-02-07 18:12 CET) Licenza: Online_Event_ID-118_15FRQESORDIENTIKAKUKARATECAMPANIA (expire 2024-05-26)

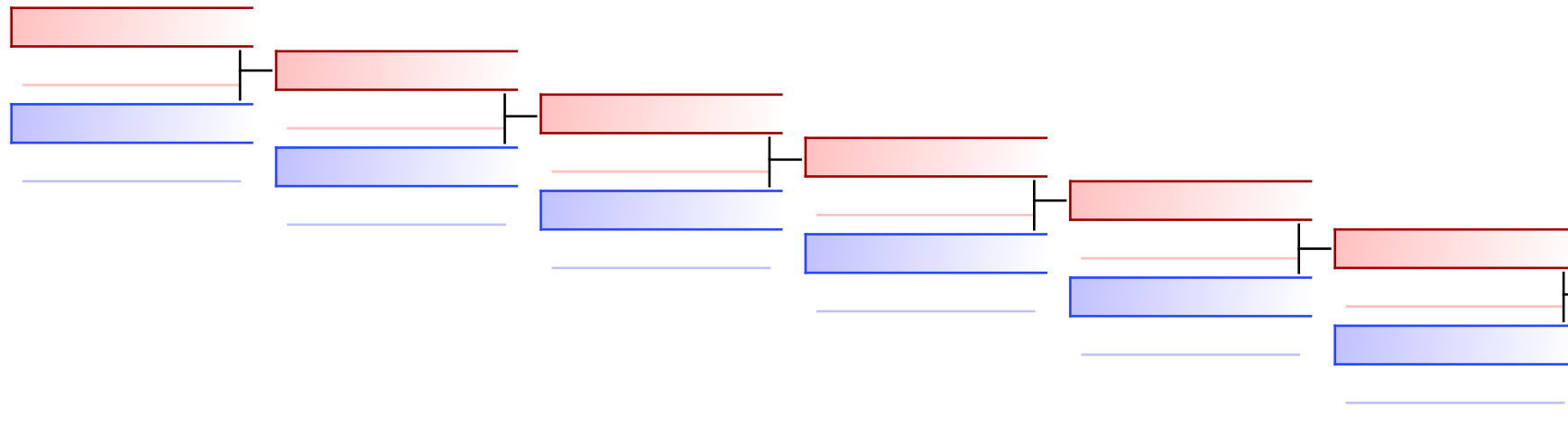

Di Caterino Domenico (TEAM CAPASSO,15 CAM)

WP 0

Del Prete Vincenzo (KARATE AND RE

Del Prete Vincenzo (KARATE AND RESP,15 CAM)

1

Ripescaggi: (1)

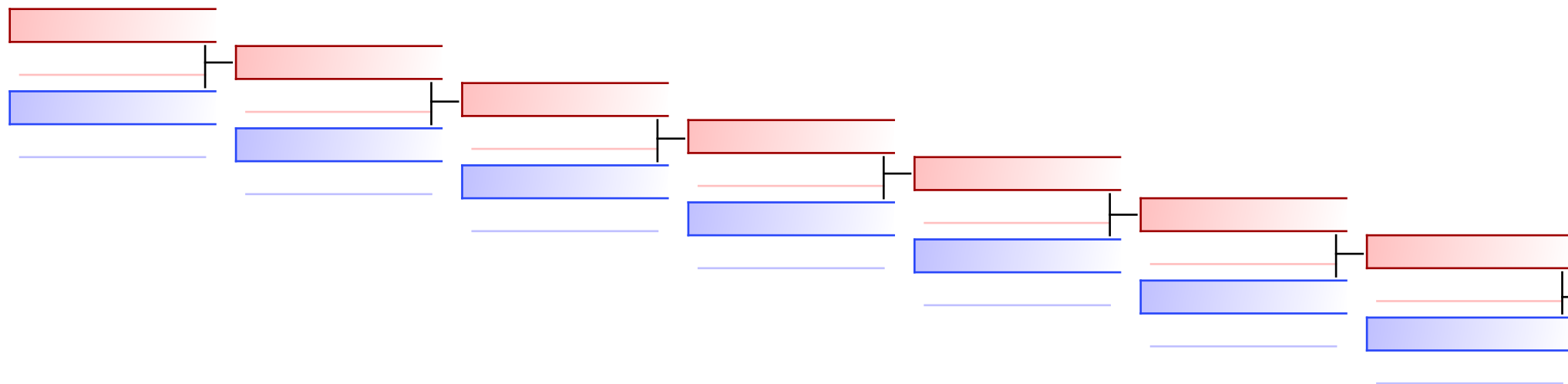

Volpicelli Domenico (GOLDEN T.,15 C

Arbitri:							
----------	--	--	--	--	--	--	--

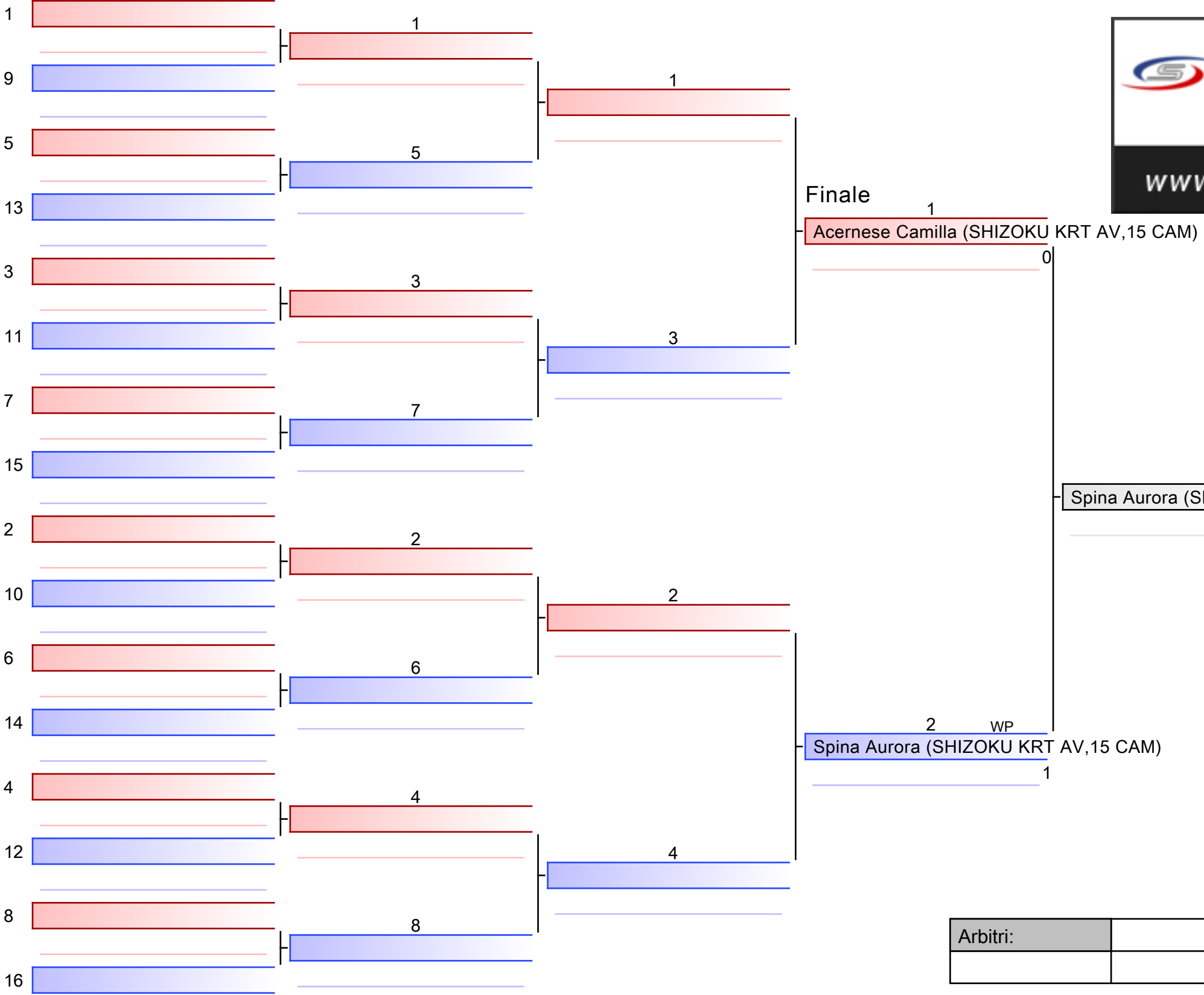

- 1. SPINA AURORA (SHIZOKU KRT AV,15 CAM)
- 2. ACERNESE CAMILLA (SHIZOKU KRT AV,15 CAM)
- 3. GIORDANO MORENA (SHIRAI CLUB,15 CAM)
- 3. PIGNATIELLO ROBERTA (UNIVERSAL CENTE,15 CAM)
- 5. MASULLO GAIA (GEN K,15 CAM)
- 5. DE LUCA GINEVRA (KARATE CENTER,15 CAM)
- 7. AIESE FEDERICA (NAPOLI TOKYO,15 CAM)
- 7. CORRADO TULLIA (SHIRAI CLUB,15 CAM)

Arbitri:			

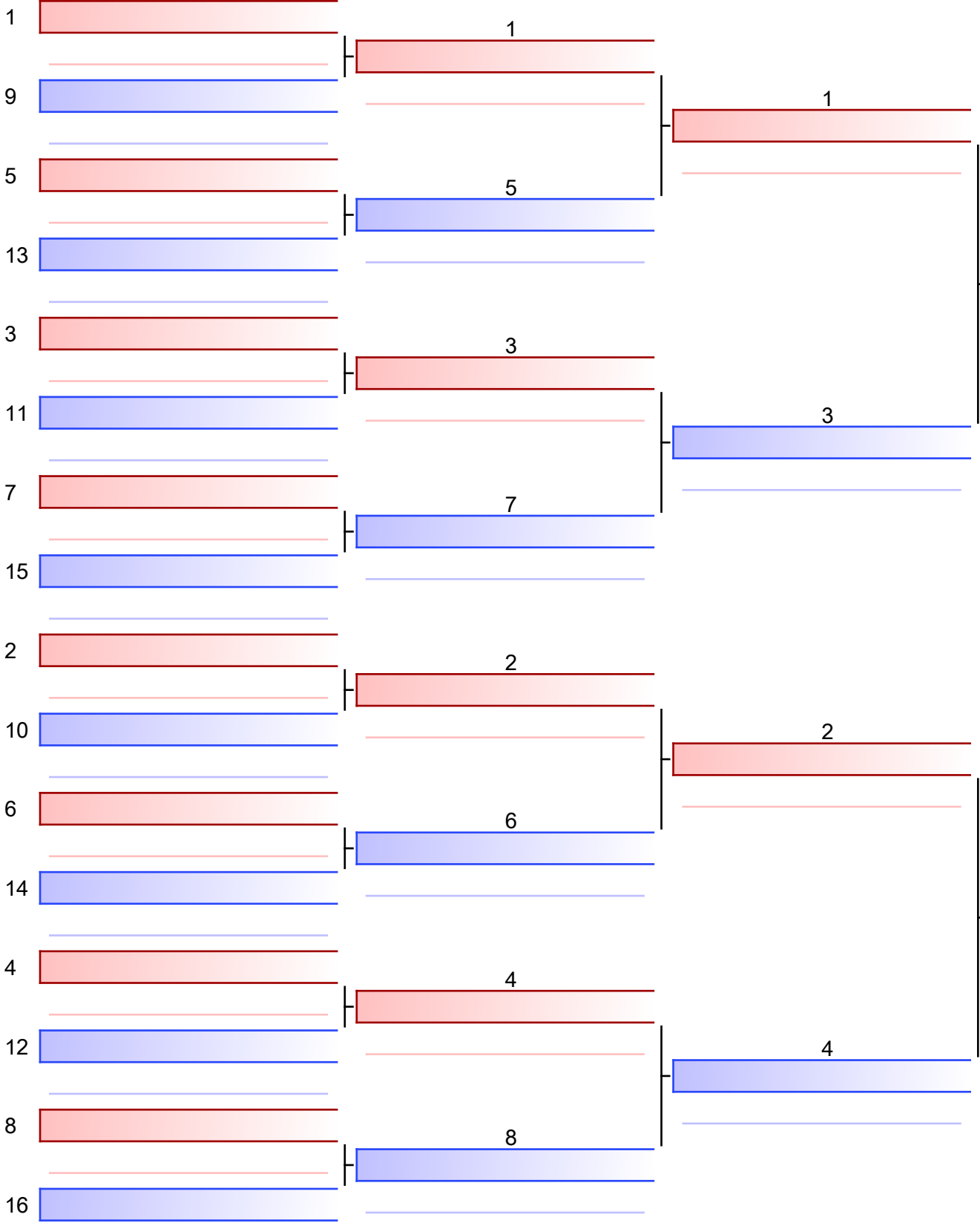

Finale

1
 (*2) Lamberti Giancarmine (p.bushido, 15 CAM)
 060 Nijushiho 2200

(*1) Marchetti Enrico (KARATE SALERNO, 15 CAM)

2
 (*1) Marchetti Enrico (KARATE SALERNO, 15 CAM)
 099 Unsu 2270

- 1. MARCHETTI ENRICO (KARATE SALERNO, 15 CAM)
- 2. LAMBERTI GIANCARMINE (P.BUSHIDO, 15 CAM)
- 3. MARTINISI GUIDO (UNION TEAM, 15 CAM)
- 3. BENEDEUCE SIMONE (UNION TEAM, 15 CAM)
- 5. SALVATI PAOLO (UNION TEAM, 15 CAM)
- 5. RIPOSO FRANCESCO (UNION TEAM, 15 CAM)
- 7. ARRICHELLO ARMANDO (TEAM CAPASSO, 15 CAM)
- 7. COZZOLINO ANIELLO (UNION TEAM, 15 CAM)

*Testa di serie

Arbitri:			

Vincitore di pool-ESORDIENTI M KUMITE 48 KG

15-FRQ_ESORDIENTI_KA_KU KARATE CAMPANIA, Via Matilde Serao 17b, località Carivita Cercola, ITA

2024-05-12

Tatami

1 14:50

Tabelloni - Pool

1/1

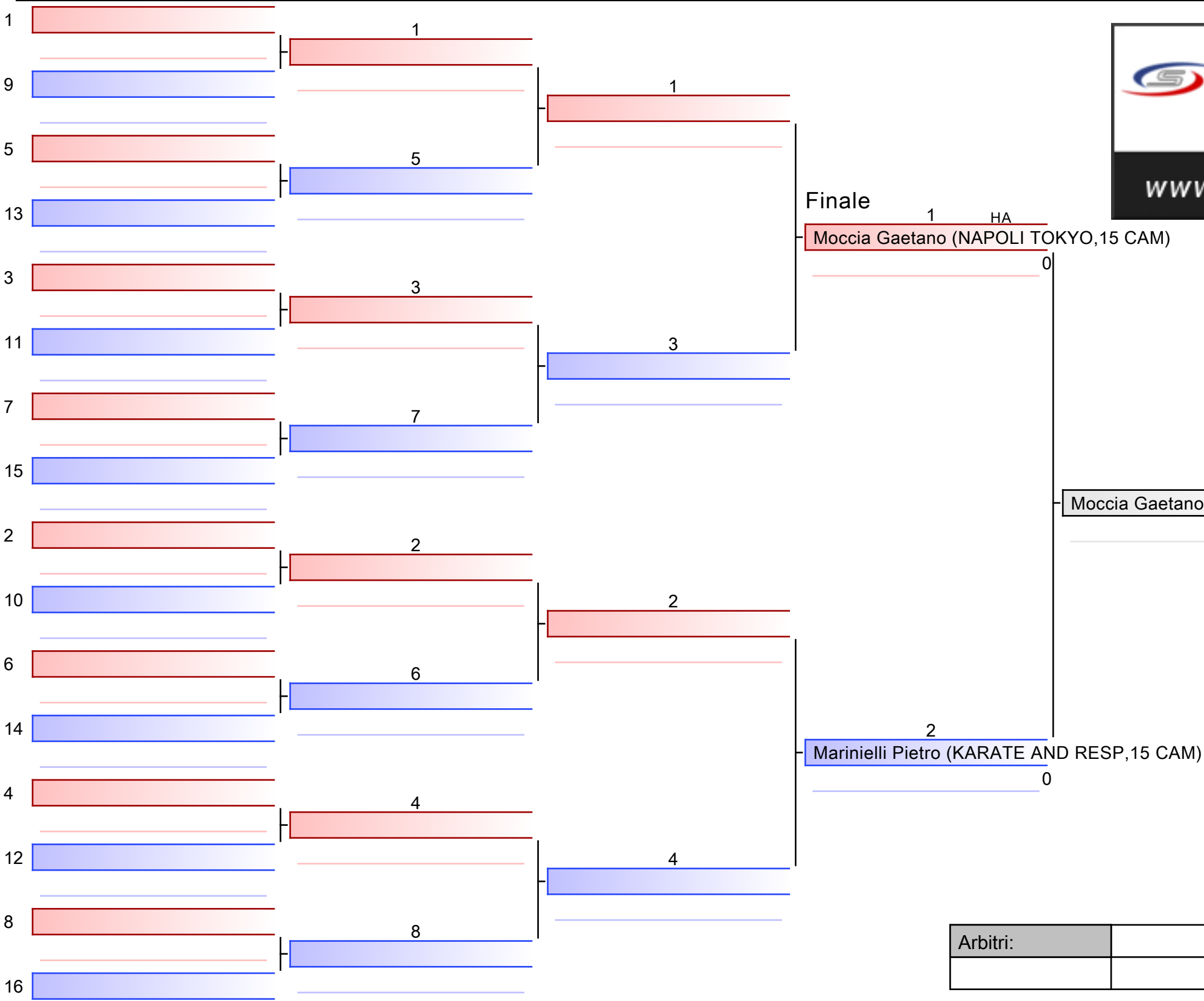

- 1. MOCCIA GAETANO (NAPOLI TOKYO, 15 CAM)
- 2. MARINIELLI PIETRO (KARATE AND RESP, 15 CAM)
- 3. DI GUIDA FERDINANDO (CHAMPION CENTER, 15 CAM)
- 3. PAGLIONICO VITTORIO (CHAMPION CENTER, 15 CAM)
- 5. CARRIOLA PAOLO (HINNA MAC 82, 15 CAM)
- 5. SBRIGLIA ANDREA (CHAMPION CENTER, 15 CAM)
- 7. CARBONE VITTORIO (IGEA WELLNESS, 15 CAM)
- 7. CHIAVAZZO LUIGI (NADIR T.D., 15 CAM)

Arbitri:			

Vincitore di pool-ESORDIENTI M KUMITE 53 KG

15-FRQ_ESORDIENTI_KA_KU KARATE CAMPANIA, Via Matilde Serao 17b, località Carivita Cercola, ITA

2024-05-12

Tatami

3 13:15

Tabelloni - Pool

1/1

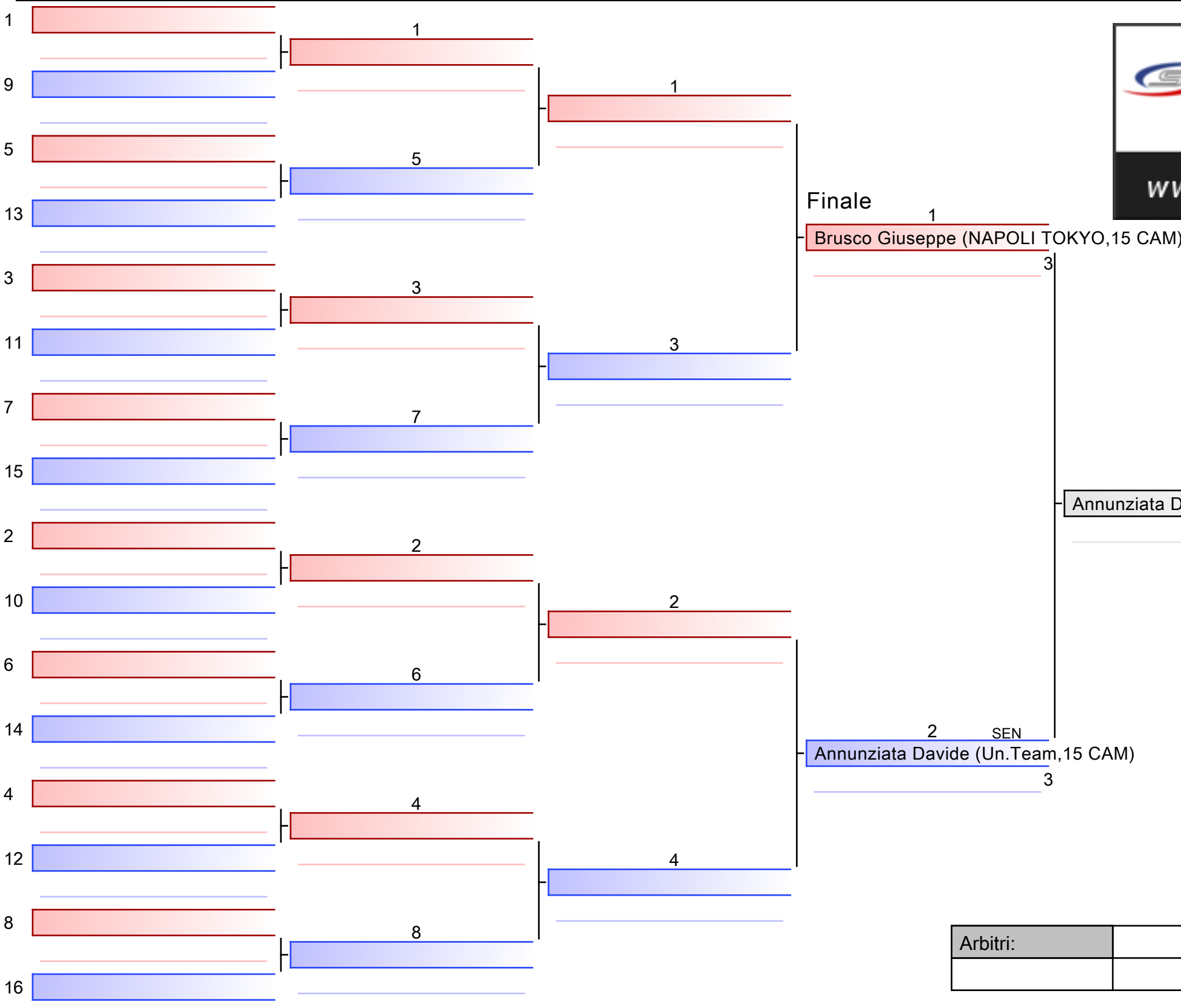

- 1. ANNUNZIATA DAVIDE (UN.TEAM,15 CAM)
- 2. BRUSCO GIUSEPPE (NAPOLI TOKYO,15 CAM)
- 3. GALDIERI MATTEO (CHAMPION CENTER,15 CAM)
- 3. RUSSOMANNO EMANUELE (SHIRAI CLUB,15 CAM)
- 5. DIANA GIUSEPPE (TEAM CAPASSO,15 CAM)
- 5. MONA DARIO (NAPOLI TOKYO,15 CAM)
- 7. PICARDI MATTIA (SHIZOKU KRT AV,15 CAM)
- 7. SCOTILLO MARIO (GSK BRACCIANTE,15 CAM)

Arbitri:			