

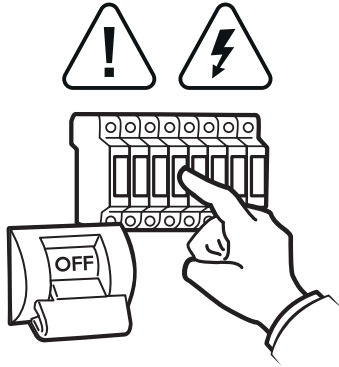

QUESTO PRODOTTO CONTIENE UNA SORGENTE LUMINOSA DI CLASSE DI EFFICIENZA ENERGETICA "D"
THIS PRODUCT CONTAINS A LIGHTING SOURCE OF ENERGY EFFICIENCY CLASS "D"

ESEGUIRE LE OPERAZIONI SEGUENDO L'ORDINE PROGRESSIVO. L'INSTALLAZIONE DI QUESTO APPARECCHIO DEVE ESSERE EFFETTUATA DA PERSONALE QUALIFICATO.
FOLLOW THE ASSEMBLY INSTRUCTIONS BY READING THE NUMERICAL PROGRESSION. THE LIGHTING FITTING SHOULD BE INSTALLED BY A QUALIFIED ELECTRICIAN.



1

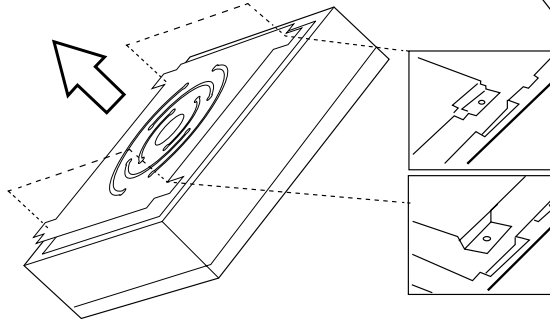

2

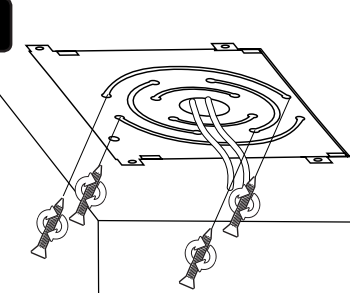
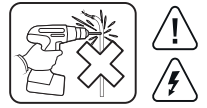
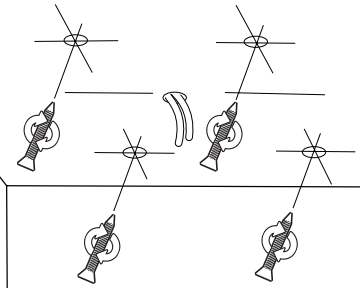

3

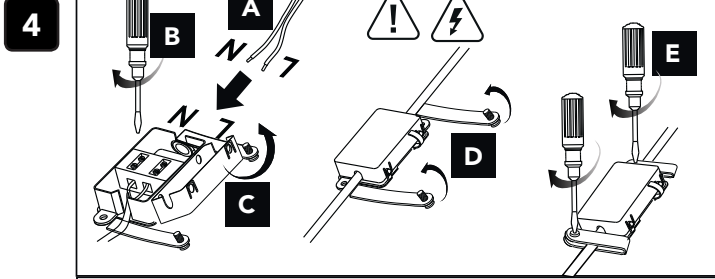

4

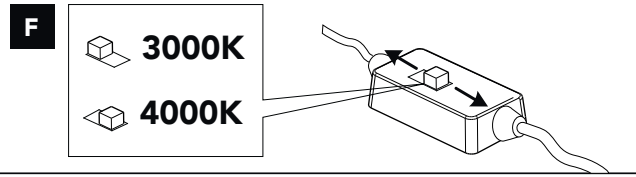

F

3000K
4000K

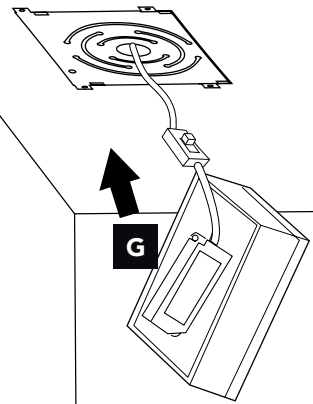

G

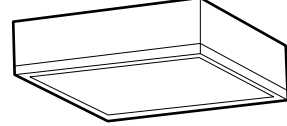
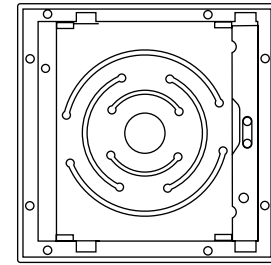
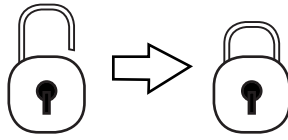
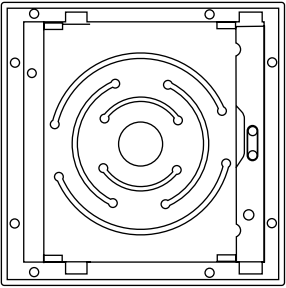
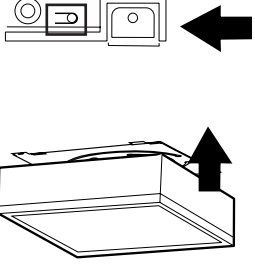

5

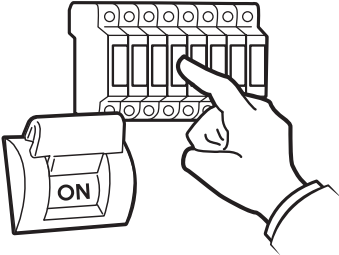

6

