



# FORTRESS POWER

Secure your energy

eFlex MAX 5.4kWh

Installation  
Manual



**Important:** Verify the system configuration before installing.  
A proper system design is required for warranty purposes.  
Improper system configuration will void the warranty.

Information subject to change without notice.  
© 2024 Fortress Power, LLC. All rights reserved.

Updated Documentation  
SCAN HERE



System Design Tool  
SCAN HERE







# FORTRESS POWER

Secure your energy

- 1. INTRODUCTION .....4**
  - 1.1 ABOUT FORTRESS POWER..... 4
  - 1.2 WARRANTY SUPPORT..... 4
- 2. SAFETY .....5**
  - 2.1 SAFETY PRECAUTIONS AND INSTRUCTIONS ..... 5
  - 2.2 TEMPERATURE CONSIDERATIONS..... 6
  - 2.3 TRANSPORTATION AND HANDLING ..... 6
  - 2.4 RESPONSE TO EMERGENCY SITUATIONS ..... 6
- 3. STORAGE .....7**
- 4. PRODUCT SPECIFICATIONS AND SYSTEM DESIGN .....8**
  - 4.1 DATASHEET..... 8
  - 4.2 SYSTEM SIZING ..... 10
- 5. UNBOXING CHECK LIST ..... 11**
- 6. BATTERY ENCLOSURE SPECIFICATIONS ..... 13**
- 7. TOOLS & MATERIALS ..... 14**
- 8. INSTALLATION ..... 14**
  - 8.1 PRE-INSTALLATION CHECKLIST..... 14
  - 8.2 MECHANICAL AND ELECTRICAL INSTALLATION ..... 15
    - 8.2.1 *Wall Mount*..... 15
    - 8.2.2 *Electrical Installation* ..... 20
  - 8.3 CONNECTING TO THE GUARDIAN ..... 22
    - 8.3.1 *Configuration using CAN Closed Loop communication with Envy Inverter* ..... 22
- 9. COMMISSIONING THE SYSTEM ..... 22**
  - 9.1 COMMISSIONING A SINGLE eFLEX MAX BATTERY PACK ..... 22
  - 9.2 LED DEFINITION ..... 24
  - 9.3 COMMISSIONING MULTIPLE eFLEX MAX BATTERIES IN PARALLEL..... 25
  - 9.4 COMMUNICATION PINOUT CONFIGURATION ..... 25
    - 9.4.1 *Voltage and Amperage Settings*..... 28
    - 9.4.2 *Charging Notes*..... 28
    - 9.4.3 *Discharging Notes* ..... 29
    - 9.4.4 *Understanding Charge Stage* ..... 29
  - 9.5 DECOMMISSIONING ..... 29
  - 9.6 KEY POINTS SUMMARY ..... 29
  - 9.7 SYSTEM COMMISSIONING ..... 30
- 10. QUICK TROUBLESHOOTING ..... 30**
- 11. CONTACT INFORMATION ..... 31**



# 1. Introduction

## 1.1 About Fortress Power

Our mission is to provide compact, user-friendly, and affordable energy storage solutions using the latest technology for all homes and businesses. Fortress solar energy storage batteries can easily integrate with new and existing PV systems and work with a wide range of existing inverter and charge controller manufacturers for ease in system design.

### Contact Information

**Corporate Headquarter** Address: 2010 Cabot Blvd West, STE L  
Langhorne, PA 19047  
United States

**Website:** [www.fortresspower.com](http://www.fortresspower.com)

**Email:** [techsupport@fortresspower.com](mailto:techsupport@fortresspower.com)

**Phone:** US: (877) 497-6937  
LATAM: (215) 710-8960

## 1.2 Warranty Support

Unless otherwise submitting a Fortress warranty through the Guardian hub, please submit your eFlex MAX warranty here:

<https://fortresspower.com/warranty>

Beyond this product manual, you may also find our inverter guides useful to system installation and commissioning:

<https://www.fortresspower.com/inverter-guides>

Beyond that, please find additional resources within our Support Portal

<https://support.fortresspower.com/portal/en/kb>

- Create a support ticket.
- Inverter Guides
- Product Manuals
- Firmware Updates
- Warranty Submittal
- System Design
- Application Notes
- Scheduled Meetings
- Accessories
- And more!

Note: Sign into the Support Portal to access all features



## 2. Safety

### 2.1 Safety Precautions and Instructions

All types of damage to the product may lead to a leakage of electrolyte or flammable gas. During installation of the battery, the utility grid and solar input must be disconnected from the Battery Pack wiring. Wiring must be carried out by qualified personnel. The battery pack contains no user serviceable parts. High voltage or current is present in the device. The electronics inside the Battery Pack are vulnerable to electrostatic discharge. Observe the following precautions:

- **Risks of explosion**
  - Do not subject the battery pack to strong impacts.
  - Do not crush or puncture the battery pack.
  - Do not dispose of the battery pack in a fire.
- **Risks of fire**
  - Do not expose the battery pack to temperatures more than 122°F (50°C).
  - Do not place the battery pack near a heat source such as a fireplace.
  - Do not expose the battery pack to direct sunlight.
  - Do not allow the battery connectors to touch conductive objects such as wires.
- **Risks of electric shock**
  - Do not disassemble the battery pack.
  - Do not touch the battery pack with wet hands.
  - Do not expose the battery pack to moisture or liquids.
  - Keep the battery pack away from children and animals.
- **Risks of damage to the battery pack**
  - Do not allow the battery pack to come in contact with liquids.
  - Do not subject the battery pack to high pressures.
  - Do not place any objects on top of the battery pack.



**IMPORTANT NOTE:** Circuit Breakers, Disconnects and Fuses should be employed throughout the energy storage and generation installation to isolate effectively and protect all components of the system against faults, short circuits, polarity reversals or a failure of any component in the overall system. Fuses, breakers, wiring ratings and values should be determined by established standards and evaluated by certified electricians, licensed installers, and regional code authorities. The eFlex MAX Battery Management System (BMS) alone will not protect the batteries from these extreme electrical events. Failure to adhere to installation protocol will void the warranty.



**CAUTION!** Verify polarity at all connections with a digital voltmeter before energizing the system. Reverse polarity at the battery terminals will void the warranty and destroy the batteries. Do not short circuit the batteries.

Most batteries pose some risk of shock or sparking during the installation and initial wiring and connection process. Wearing insulated gloves, clothing and footwear and using electrically insulated tools are required when working with eFlex MAX. Cover or remove jewelry or conductive objects (metal bracelets, rings, belt buckles, metal snaps, zippers, etc.) when working with any electrical or mechanical device. Cover or restrain long hair and loose clothing when working with any electrical or mechanical device. **CAUTION!** Do not disassemble or modify the battery. If the battery housing is damaged, do not touch the exposed contents.



## 2.2 Temperature Considerations



CAUTION! Do not attempt to charge the battery below 32 degrees F (0 degrees C). Attempts to charge at subfreezing temperatures can adversely affect State of Health (SOH) and cycle life and will void the warranty; never charge battery if it is frozen; never charge a visibly damaged battery. Charging the battery near freezing should only be done with a low amperage external charger or closed-loop communication inverter unless the battery bank is heated. There is no need to heat the batteries above 50F.

Do not charge the battery when ambient temperature is freezing or below. Discharge current at sub-freezing temperatures should also be significantly reduced. Consider the Fortress DuraRack cabinet for din-rail friendly heater installation.



**CAUTION! Do Not Operate Fortress Lithium Batteries where average internal battery temperature exceeds 30 °C / 86 °F over the life of the battery.**

### **Recommended operating parameters of charger/Inverters For 3,000 Cycles:**

- Internal battery temperature range: 32 F to 120 F (0 °C to 49°C) without close-loop communication.
- Bulk voltage and absorb voltage should be set to 54.4V if no battery-inverter communication is available.

### **Recommended operating parameters of charger/Inverters For 8,000+ Cycles:**

- Operating temperature range: 50 F to 110 F (10°C to 43°C) per fortress power recommend charge and discharge inverter configuration.

## 2.3 Transportation and Handling

- Do not knock, drop, puncture, or crush the battery.
- Do not expose battery to flames, incinerate or direct sunlight.
- Do not open the battery case or disassemble the battery.
- Do not lift battery by the terminal cables.
- Do not vibrate the battery.
- Do not expose the battery to water or other fluids.
- Do not expose battery to open flame.
- Do not place the product nearby highly flammable materials, it may lead to fire or explosion in case of accident, Store at cool and dry place.
- Do not store in greenhouses and storage areas for hay, straw, chaff, animal feed, fertilizers, vegetables, or fruit products.
- Store the product on a flat surface; A ventilated area is strongly recommended for handling the product.
- Store the product out of reach of children and animals.
- Store the product where it should be minimal dust and dirt in the area; do not transport battery upside down or with the terminals towards the ground.
- Batteries should be discharged to 30% state of charge or 52.0V resting voltage before transporting.

## 2.4 Response To Emergency Situations

- The battery pack consists of multiple batteries and a sophisticated Battery Management System that are designed to prevent hazards resulting from failures. However, Fortress Power cannot guarantee their absolute safety.
- Leaking Batteries



- If the battery pack leaks electrolyte, avoid contact with the leaking liquid or gas. If a person is exposed to the leaked substance, immediately perform the actions described below.
- Inhalation: Evacuate the contaminated area and seek medical attention.
- Contact with eyes: Rinse eyes with flowing water for 15 minutes and seek medical attention.
- Contact with skin: Wash the affected area thoroughly with soap and water and seek medical attention.
- Ingestion: Induce vomiting, and seek medical attention
- Fire
- In case of fire, make sure that an extinguisher is available near the battery pack. If possible, move the battery pack to a safe area before it catches fire.

**Note: Fire extinguisher**

- Water, carbon dioxide, dry chemical powder and foam are the most effective means to extinguish a Lithium Ferrous Phosphate (LFP) battery fire.
- Use ABC Fire extinguisher, if the fire is not from battery and has not spread to it yet.

### 3. Storage

Store batteries away from direct sunlight and in locations with temperatures ranging between 0°C and 35°C (32°F to 95°F) to avoid exposure to high temperatures.

- Turn off the battery during long-term storage to reduce the self-discharge rate, which is about 1% when the SOC is above 20%.
- Maintain a Relative Humidity (RH) level between 5% and 75% in a dry and clean indoor environment. Prevent contact with corrosive materials and keep away from fire and heat sources.
- For storage durations exceeding one month, ensure the battery's State of Charge (SOC) is maintained between 30% to 50%. It is crucial to charge and discharge the battery every six months to maintain health.
- Regularly check the battery every 3 months to ensure the SOC remains above 20% (greater than 51V). If it falls below this level, charge the battery up to 52V before returning it to storage.
- When placing systems into storage, set the SOC to 30~50% and periodically verify that it does not drop below 20%.

If you expect the battery to be left unattended for extended periods, set a higher battery cutoff voltage as a precaution. This is particularly important if the power supply is critical, and the charging sources (like solar panels) may be obstructed by snow or dust. In such scenarios, installing a backup generator with an AutoStart feature is advisable. Note that the inverter and battery management system may impose a minor load on the battery, potentially depleting it over long durations without any charging sources.

Following these guidelines will help ensure your battery's longevity and reliability, even during extended storage periods.





# 4. Product Specifications and System Design

## 4.1 Datasheet

# eFlex MAX 5.4

Lithium Battery Storage

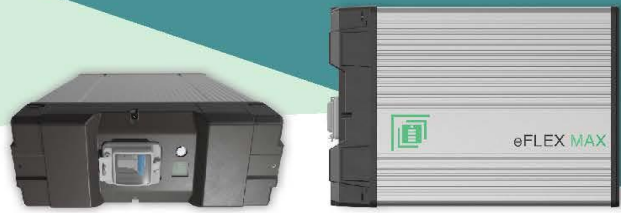

We design the eFlex MAX 5.4 with a goal of building the world most robust lithium battery for all different application scenarios and harsh weather conditions.

- Tier 1 Automotive Prismatic Lithium Iron Phosphate Cell with the highest cycle life.
- Patented Enclosure design achieves 4 times better thermal performance than our competitors.
- IP 65 Dust and Water Proof design for outdoor install.
- Mounting options include wall mount, floor-stand or 19" industrial server rack mount.
- Busbar included.

Our market leading Digital Processor Battery Management System (BMS) includes:

- Minimal idle consumption (2W).
- Integrated 125A breaker.
- Individual cell voltage & temperature monitoring and balancing for maximum reliability and longevity.
- Canbus, Modbus, OTA firmware updates, remote monitoring.
- Advanced closed loop communication with most 48V inverters.

Application Scenarios:

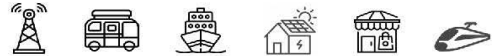

Electrical Specifications	
Nominal Voltage:	51.2V
Nominal Capacity:	105AH
Rated Capacity @ 0.5C (50A):	5.374 kWh
Resistance:	<10 mΩ
Efficiency (at 0.5C):	>98%
Self-Discharge:	<1 % / Month
Maximum Allowed Modules in Parallel:	16 (86.4kWh)
Depth of Discharge	Up to 100%
Warranty	10 Years
Cycle Life	8,000 (@ 80% DoD)

Charge Specifications	
Recommended Charge Current:	<55A
Maximum Charge Current:	100A
Recommended Charge Voltage:	54.4V
BMS Charge Voltage Disconnect:	>56V

Discharge Specifications	
Recommended Continuous Discharge Rate:	60A (3KW DC)
Peak Continuous Discharge Rate:	100A (5 KW 60 Min)
Maximum Surge Power Rate:	125A (6.6 KW 5S)
Recommended Low Voltage Disconnect:	48V
Battery Low Voltage Protection:	<45V
Battery recovery Voltage:	45V
Fault Current:	3000A, 5ms

Temperature Specifications	
Discharge Temperature:	-4°F~131°F (-20°C ~ 55°C)
Charge Temperature:	32°F ~ 114°F (0°C ~ 45°C)
Storage Temperature:	20°F ~ 95°F (-6°C ~ 35°C)

Mechanical Specifications	
Dimensions: (L*W*H)	17.5 x 7.2 x 24.2 inches 446 x 184 x 616 mm
Weight:	108 lbs (49kg)
Terminal Type:	M8
Ring Terminal Size:	3/8ths or larger
Terminal Torque:	7.0 – 7.7 Nm (5.1 – 5.7 ft-lb)
Terminal Cover	1 set, Waterproof
Case Material:	Anodized Aluminum
Enclosure Protection:	IP65
Cell Type Chemistry:	Tier 1 Automotive Prismatic - LiFePO <sub>4</sub>

Compliance Specifications:	
Certifications:	UL1973
Shipping Classification:	UN 38.3, CLASS 9 (Lithium Ion Battery)

Basic Charging Profile	
Bulk + Absorb Charge:	54.4V
Absorb Time:	60 minutes
Float Charge:	54V
Inverter Charging:	2 Stage / No Float
Equalization:	No equalization (typical) 54.6V for 10 seconds (rare)
Temperature Compensation:	None



[www.FortressPower.com](http://www.FortressPower.com)

Sales@FortressPower.com • 877-497-6937





**FORTRESS  
POWER**  
Secure your energy

**BATTERY DIMENSIONS**

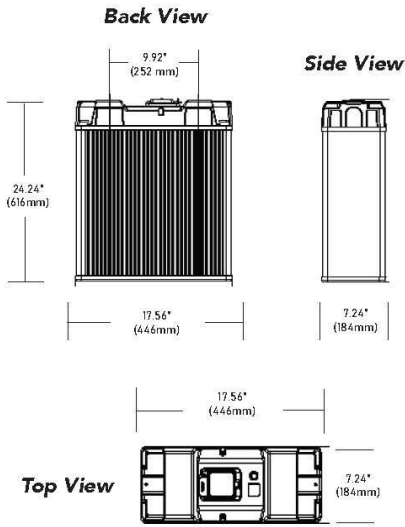

**Included Busbar**    **1 1/4 in Threaded Conduit Fitting**

**VERSATILE CONFIGURATIONS**

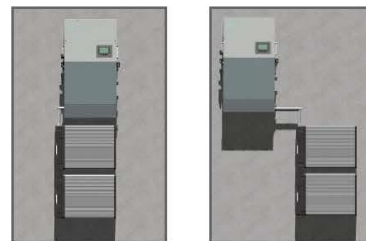
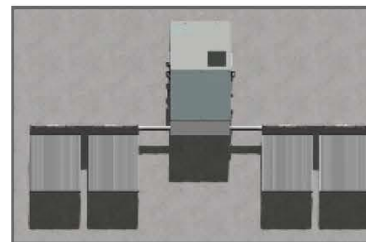
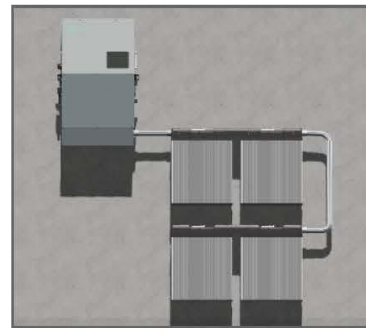
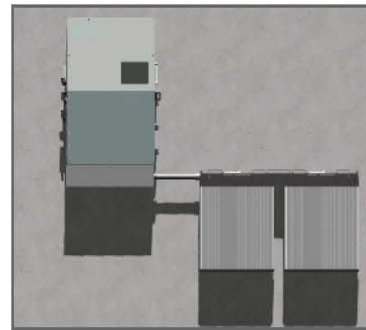

**...and many MORE!**

**WALL MOUNT BRACKET (INCLUDED)  
DIMENSIONS**

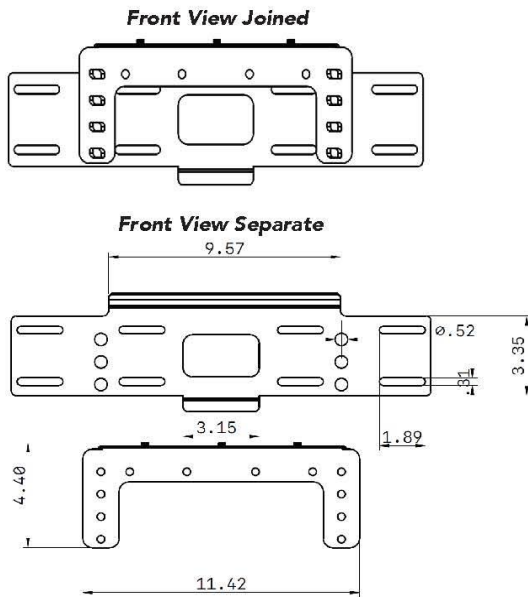

[www.FortressPower.com](http://www.FortressPower.com)

Sales@FortressPower.com • 877-497-6937



## 4.2 System Sizing

Please refer to our sizing guide and warranty letter for appropriate sizes between various inverter models and the eFlex MAX. <https://support.fortresspower.com/portal/en/kb/articles/minimum-battery-sizing>. Instead of memorizing the above chart, a good rule of thumb is a maximum of 3.3kW of power output per eFlex MAX without battery-inverter communication. Alternatively, you could design 5kW of power output per eFlex MAX with battery-inverter communication, but it may limit the inverter burst capacity. Under no circumstance should you install an inverter with charging capacity greater than 100A per eFlex MAX, even if you intend to limit the charge or discharge capacity of the inverter either manually or digitally.

Inverter	eFlex/MAX 5.4 Open Loop	eFlex/MAX 5.4 Closed-Loop
Fortress Power ENVY 8kW	2	2
Fortress Power ENVY 10kW	2	2
Fortress Power ENVY 12kW	3	3
Schneider Electric XW Pro 6848	3	2
Schneider Electric XW+ 6848	3	–
Schneider Electric XW+ 5548	2	–
Schneider Electric SW 4048	2	–
OutBack Power Radian 8048A	3	–
OutBack Power Radian 4048A	2	–
OutBack Power SkyBox SBX 5048	2	–
OutBack Power VFXR 3648A	1	–
OutBack Power FXR 3048A	1	–
Sol-Ark 5K	3	2
Sol-Ark 8K	3	2
Sol-Ark 12K	3	2
Sol-Ark 15K	4	3
SMA Sunny Island 6048	2	2
SMA Sunny Island 4548	2	2
Studer Innotec AJ 400-48	1	1
Studer Innotec AJ 700-48	1	1
Studer Innotec XTS 1400-48	1	1
Studer Innotec XTS 2600-48	2	1
Studer Innotec XTS 4000-48	2	2
Studer Innotec XTS 6000-48	3	3
Studer Innotec XTS 8000-48	4	4
Magnum / Sensata MS 4448	2	–
Magnum / Sensata MS 4048	2	–
Selectronic SP PRO SPMC 481- AU	2	–
Selectronic SP PRO SPMC 482- AU	3	–
Victron Energy Quattro 48/3000/35	1	–
Victron Energy Quattro 48/5000/70	2	–
Victron Energy Quattro 48/10000/140	3	–
Victron Energy Quattro 48/15000/200	5	–



## 5. Unboxing Check List

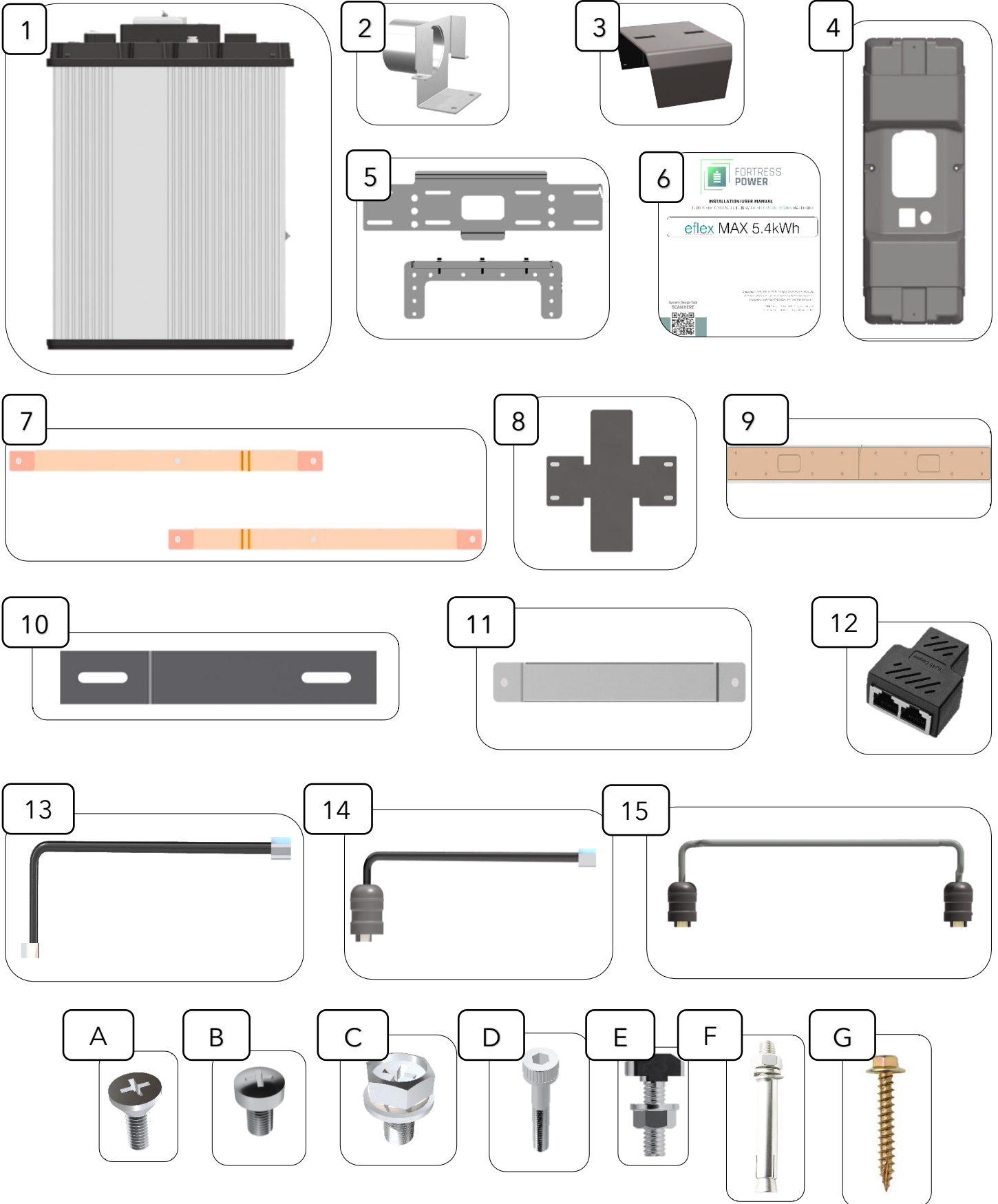



Part	Description	Qty
1	eFlex MAX 5.4kWh	1
2	1¼ -Inch Threaded Conduit Fitting	1
3	Busbar Top Cover	1
4	Top eFlex MAX Cover	1
5	Wall Mount Bracket	1 Pair
6	Manual	1
7	Busbar (300A)	1 Pair
8	Busbar Bottom Cover	1
9	Wall Mount template	1
10	Floor Mount Bracket	1 Pair
11	Back Support	1
12	2-Way RJ45 Splitter / Extender	1
13	ENVY & Sol-Ark Battery-Inverter COMM Cable (2 ft.)	2
14	IP65 Battery-Inverter Comm Cable (9ft.)	1
15	IP65 Battery-Battery Comm Cable	1
A	M4 * 8 Stainless Steel Cross Recessed Countersunk Head Screw	2
B	M4 * 6 Stainless Steel Cross Pan Head Screw	5+1
C	M8 * 16 Combination Cross Groove Recessed Hexagonal Head Bolt	4
D	M4*25 Hexagonal Socket Head Cap Screw	3
E	M6 * 20 European Standard 30, T-bolt & M6 Flange Nut	6+1 extra
F	M8*60 Expansion Screw	4
G	M6*50 Wood Screw	4

## Important

1. After unboxing, turn on unit by pressing the push button and turning on the breaker, wait for the light show to complete.

### Verify battery voltage of EACH battery with a voltmeter.

- Check that voltage between terminals is between 50-55V. If the voltage is too low, a slow charging to 50V is needed. Turn off the eFlex MAX.
  - If the batteries are not within 0.5V of each other, please pre-charge battery within the same voltage range.
  - Take pictures of the battery serial numbers for warranty submittal.
  - Connect RJ45 cable between batteries.
2. Use Fortress inverter guides to program inverter settings at <https://fortresspower.com/inverter-guides>
  3. Take a photo of the battery for submitting your warranty at <https://fortresspower.com/warranty>
  4. Visit <https://support.fortresspower.com> to submit technical support requests.



## 6. Battery Enclosure Specifications

### With Top Cover

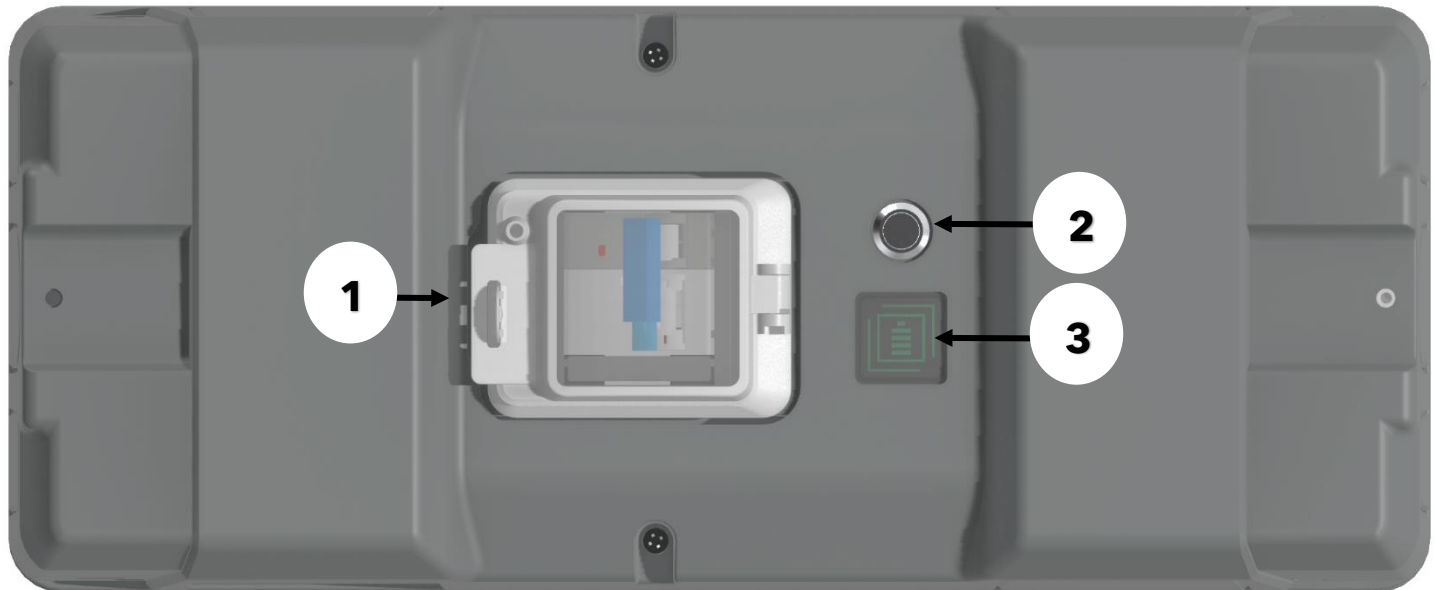

### Without Top Cover

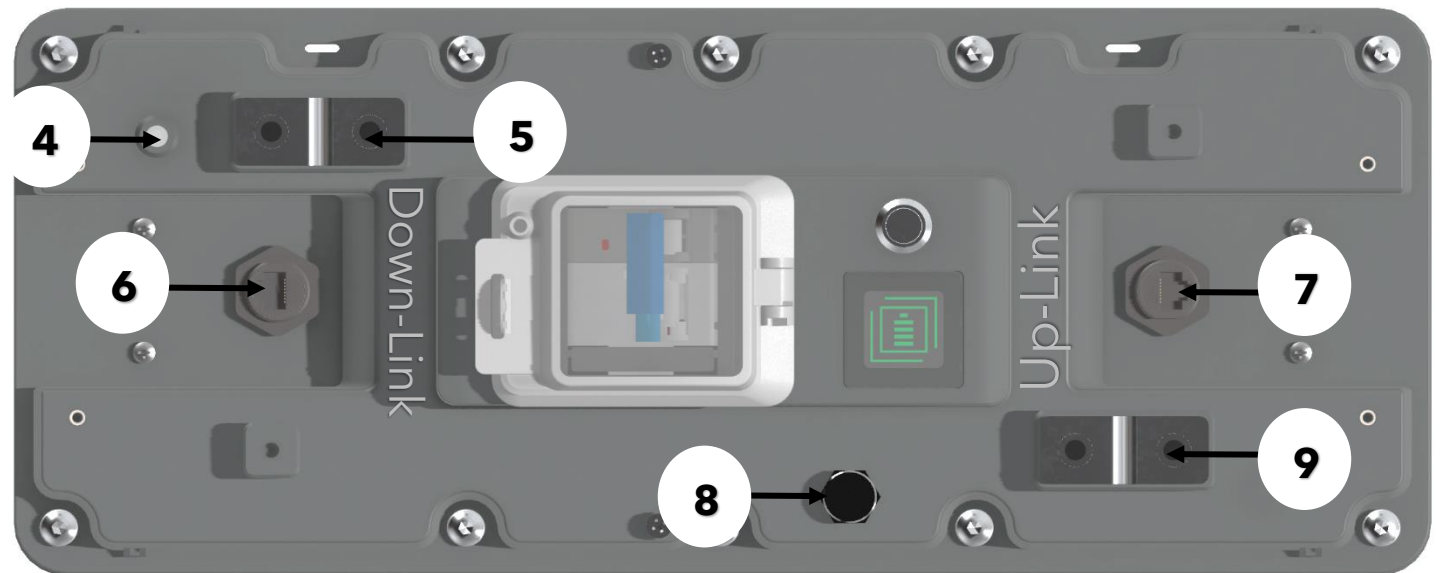

Area	Description
1	125ADC Breaker
2	Power Button
3	LED Indicator
4	Negative Booster Port (Only used for Emergency)
5	Negative Port
6	Down-Link
7	Up-Link
8	Safety Valve
9	Positive Terminal



## 7. Tools & Materials

**The following tools and materials are required and are not included:**

- Rubber Mallet
- OSHA approved personal protective equipment, Safety Shoes, Safety Glasses, Insulated Gloves
- Phillip and Flat Head Screwdriver Set
- Socket Wrench kit or Adjustable Wrench.
- Power Drill
- Positive and negative battery cables, we recommend copper cable starting at 1/0 AWG for runs of less than 10ft. Please refer to your adopted version of the National Electric Code or Local Authority Having Jurisdiction for more guidance (not included)
- UL Battery Cable or Welding Cable & Positive and Negative Terminal lugs. Recommendation: M8 (diameter: 8mm or 5/16in). Note that the ring terminal size for the terminal lug is 3/8ths or larger.
- Basic electrician Tools, Including Electrician Scissors, Wire Stripper and Crimper (Up to 4/0)

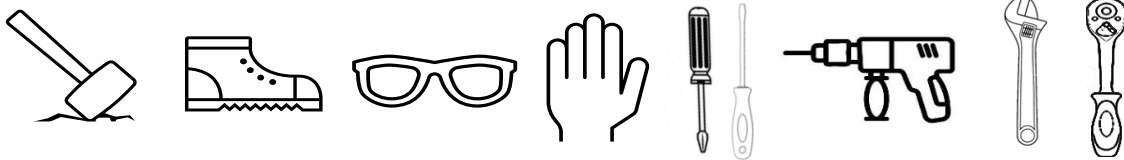

## 8. Installation

The Fortress eFlex MAX is an IP65 battery with a 1/4" thick aluminum case. Installers can choose wall mount or floor mount for indoor and outdoor use, both residential and commercial. Heated battery cabinets are also recommended where operating temperatures are below 32F, even if staying above freezing. Consider the Durack battery cabinet in cold, very hot, or very humid Outdoor environments.

### 8.1 Pre-Installation Checklist

#### Initial Checks

- Inspect Package: Ensure no damage or missing components.
- Check Terminals: Terminals should be clean, without dirt, fluids, or corrosion.
- Cable Integrity: Confirm cables are secure, intact, without damage.
- Verify Bolt Torque: Ensure terminal bolts are properly tightened.
- Replace Damaged Parts: Swap out any damaged batteries or cables.

#### Activation Prep

- Prepare Space: Set battery on a clean, stable surface ensuring terminals don't touch conductive materials.

#### Power On

- Turn On: Activate the eFlex MAX Power Button, BMS, and Breaker, checking for green LED lights indicating correct state of charge.
- Voltage Check: Ensure terminal voltage is between 50V-55V. Below 50V, charge the battery; above 55V, contact Fortress Power.

#### Installation Notes

- Report Issues: Notify of any issues within 7 days of receipt.
- Indoor Installation: Install the battery indoors in a weather-protected, waterproof, level area away from flammable materials, within a 59°F to 95°F temperature range to prevent performance degradation.

#### Caution

- Temperature Warning: Operating outside the recommended temperature range may halt operation and reduce battery life.



## 8.2 Mechanical and Electrical Installation

### 8.2.1 Wall Mount

#### Wall Mount Bracket Dimensions

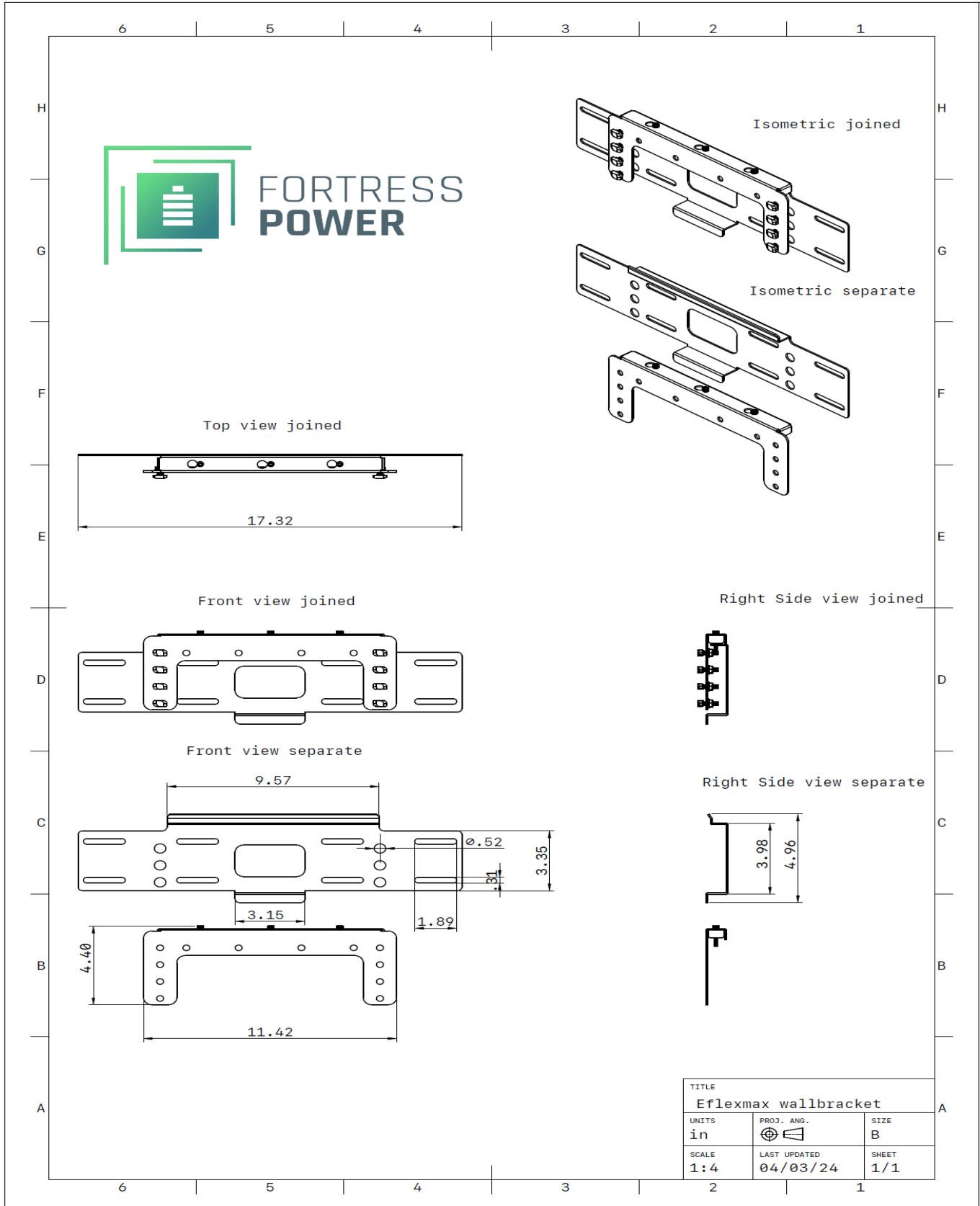





The eFlex MAX should not be installed in direct exposure to the sun. When **wall mounting**, only the following configurations are allowed.



**Do not wall mount the eFlex MAX in any other orientation.**

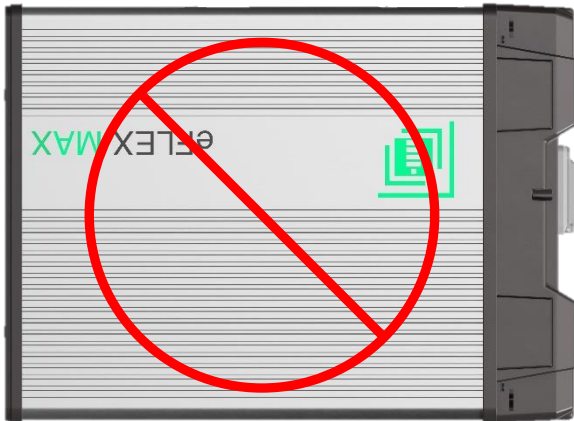



## Mounting the battery pack to a wall

1. Take into consideration the perimeter of the installation side. Ensure the battery is turned off by verifying the LED lights are off and there is no voltage across the terminals.

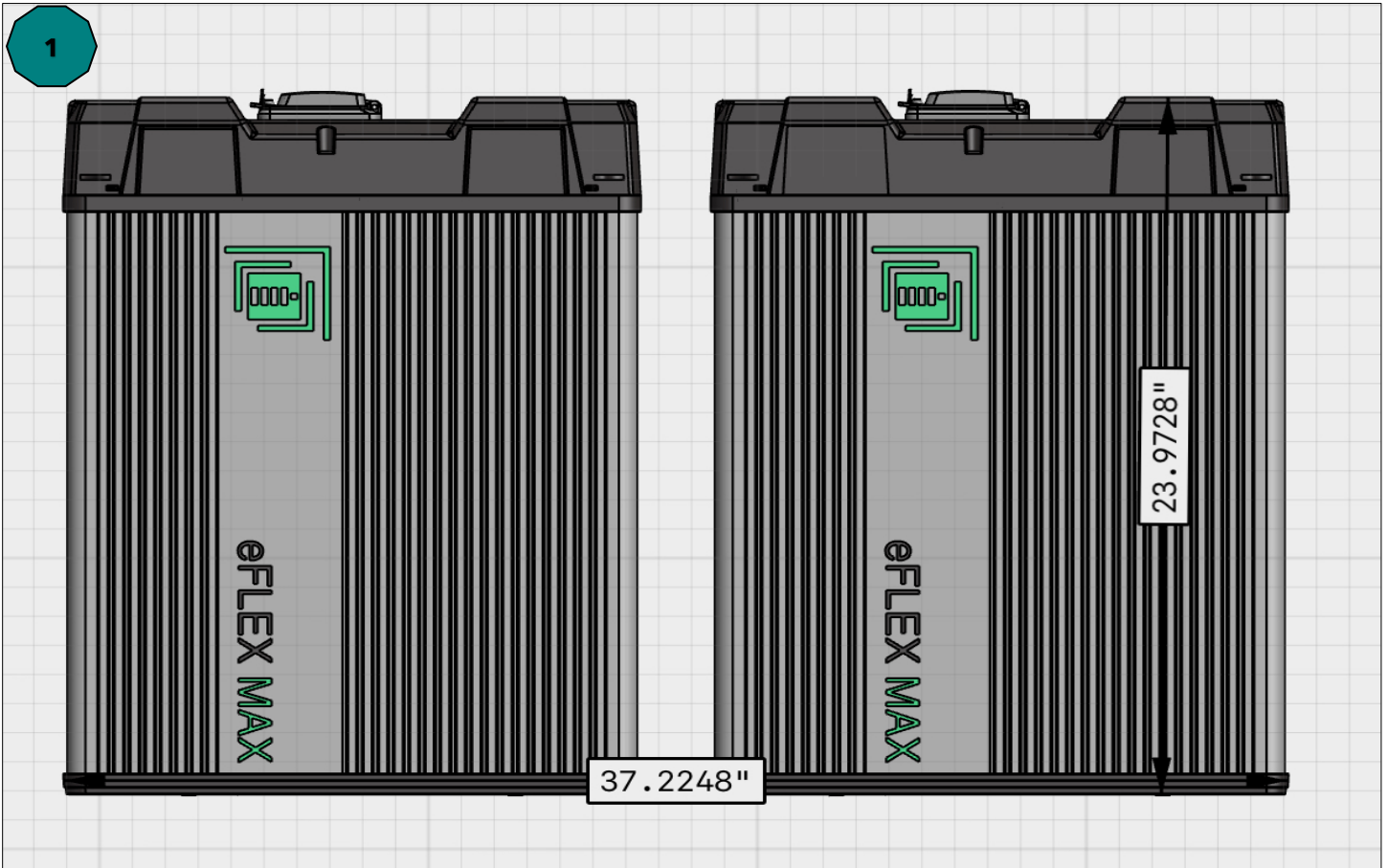

2. Use provided wall mounting template to mark out wall mount position.

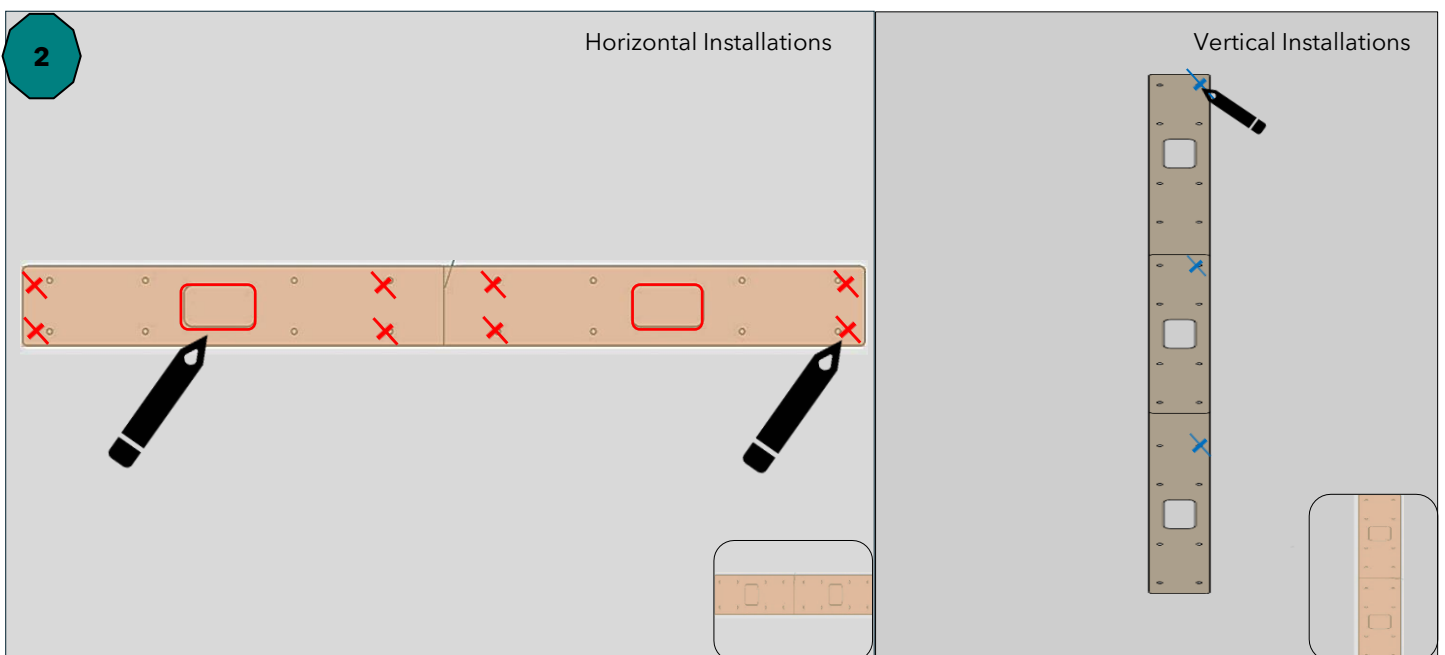



3. Drill the marked spot on the wall if using expansion screws. Otherwise Skip to step 4.

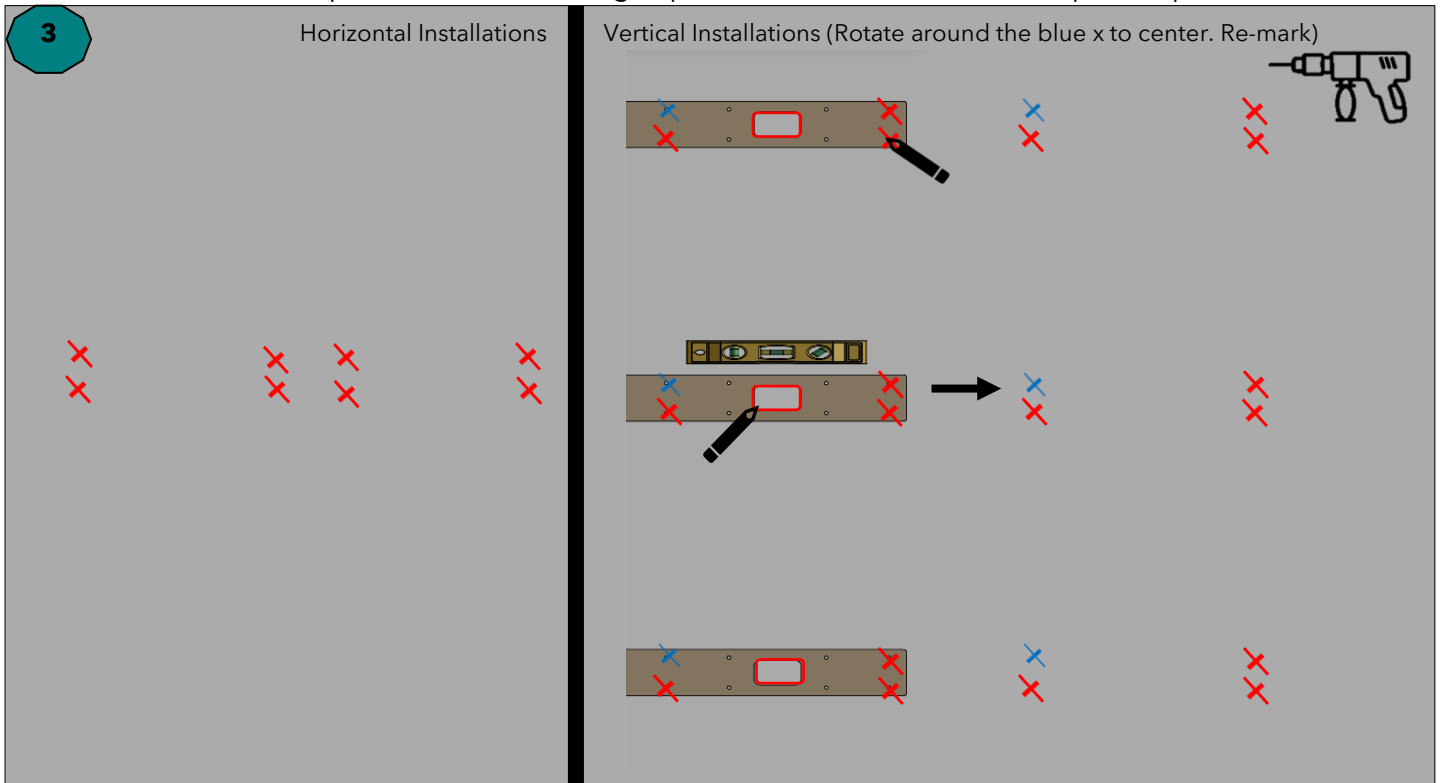

4. Affix the larger mounting bracket into the wall. Make sure that both wall brackets are leveled. Screw in the security screw into the center mounting location using the included hex key. Leave 1/5" inch of room when tightening.

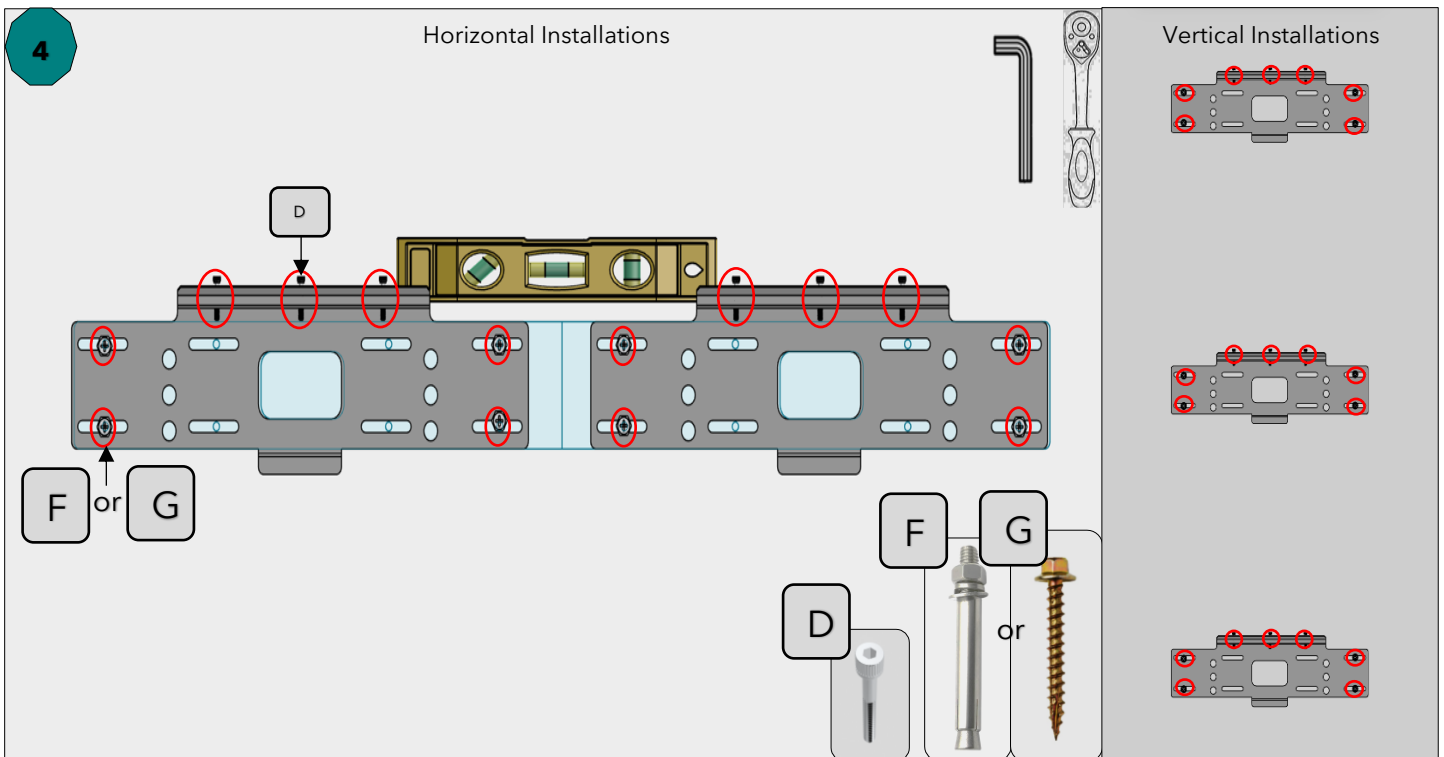



5. Using the T-bolts, install the battery wall hook and the back support. Secure tightly.

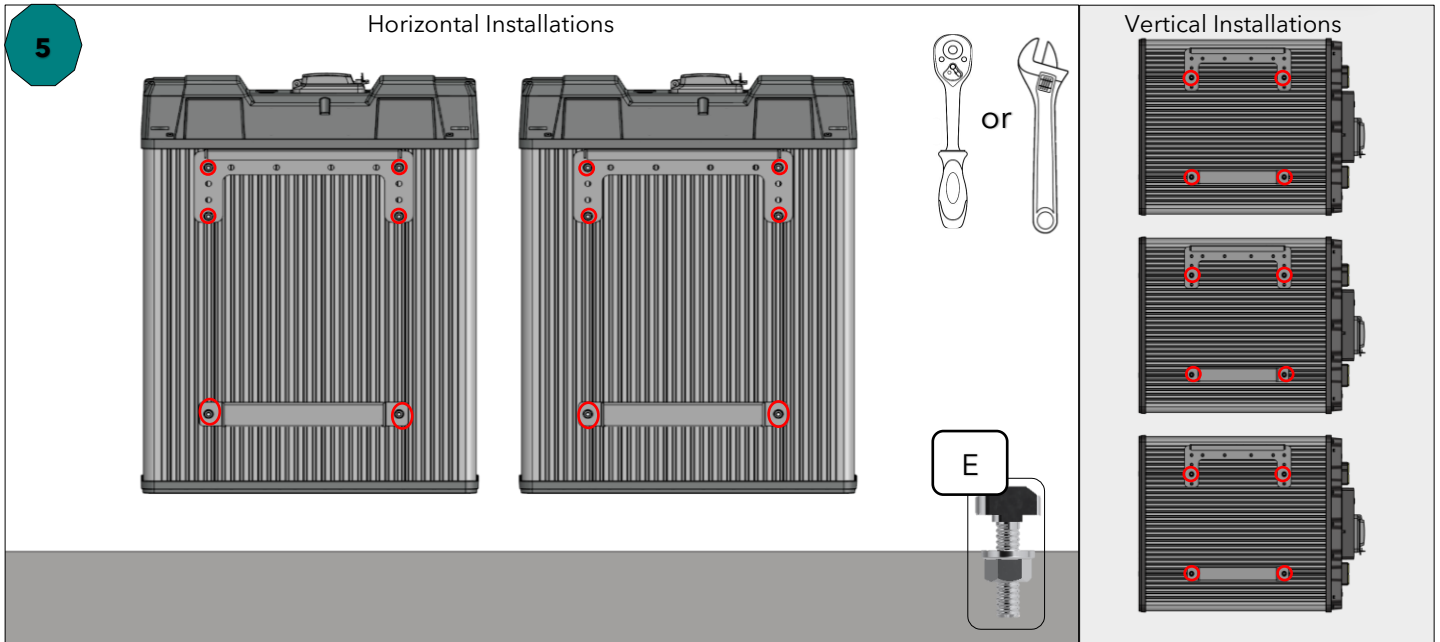

6. Insert a flathead screwdriver and push onwards to disengage the top cover. Do this with all 4 sides and remove the top cover. Using electrician scissors, cut the shaded green areas. Remove the material by twisting or bending the cut area. Optionally, use a rubber mallet and carefully pop the shaded green areas. Note: only remove the center area of the battery nearest to the master inverter as this will serve to install the conduit fitting.

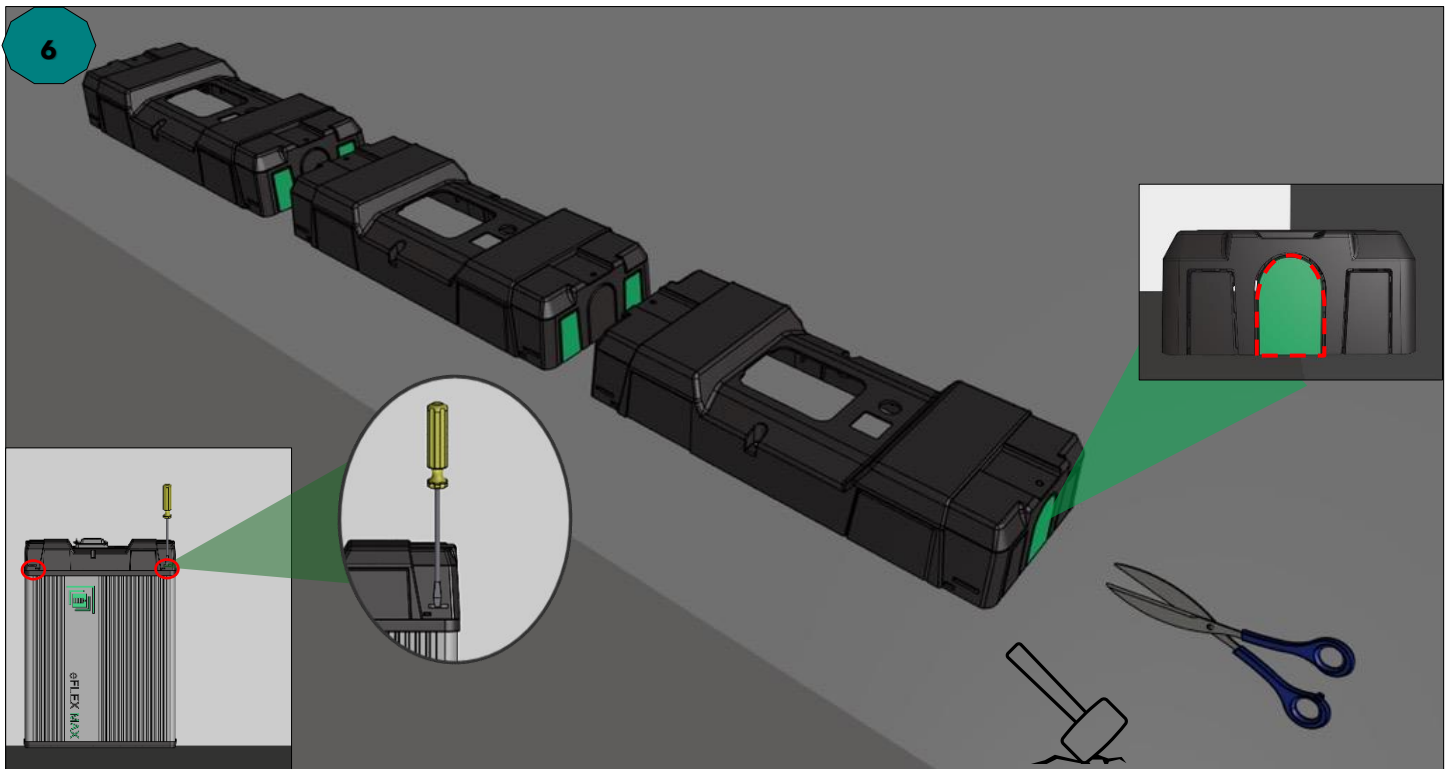



7. Carefully lift the battery with the help of a second person and gently drop it into the wall mounted brackets. Slide the eFlex MAX into the narrow part of the keyhole before tightening the bolt. Finish tightening the security bolt.

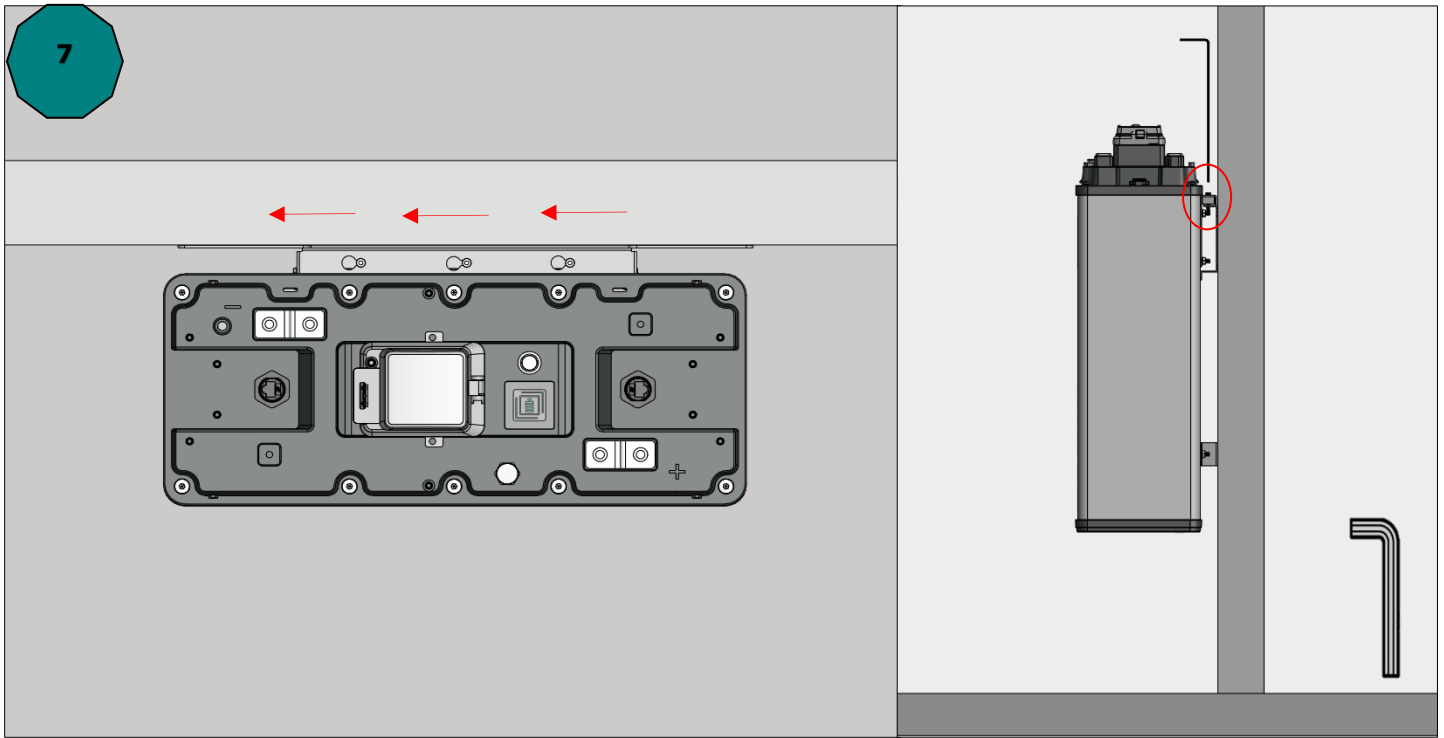

### 8.2.2 Electrical Installation

8. Screw the Conduit Fitting to one side of the battery. Then screw in the bottom busbar covers. Install the battery comm cable between, battery-inverter cable (First battery), Knob Cap (Last Battery). Match the Labels of the battery-battery cable to its designated port.

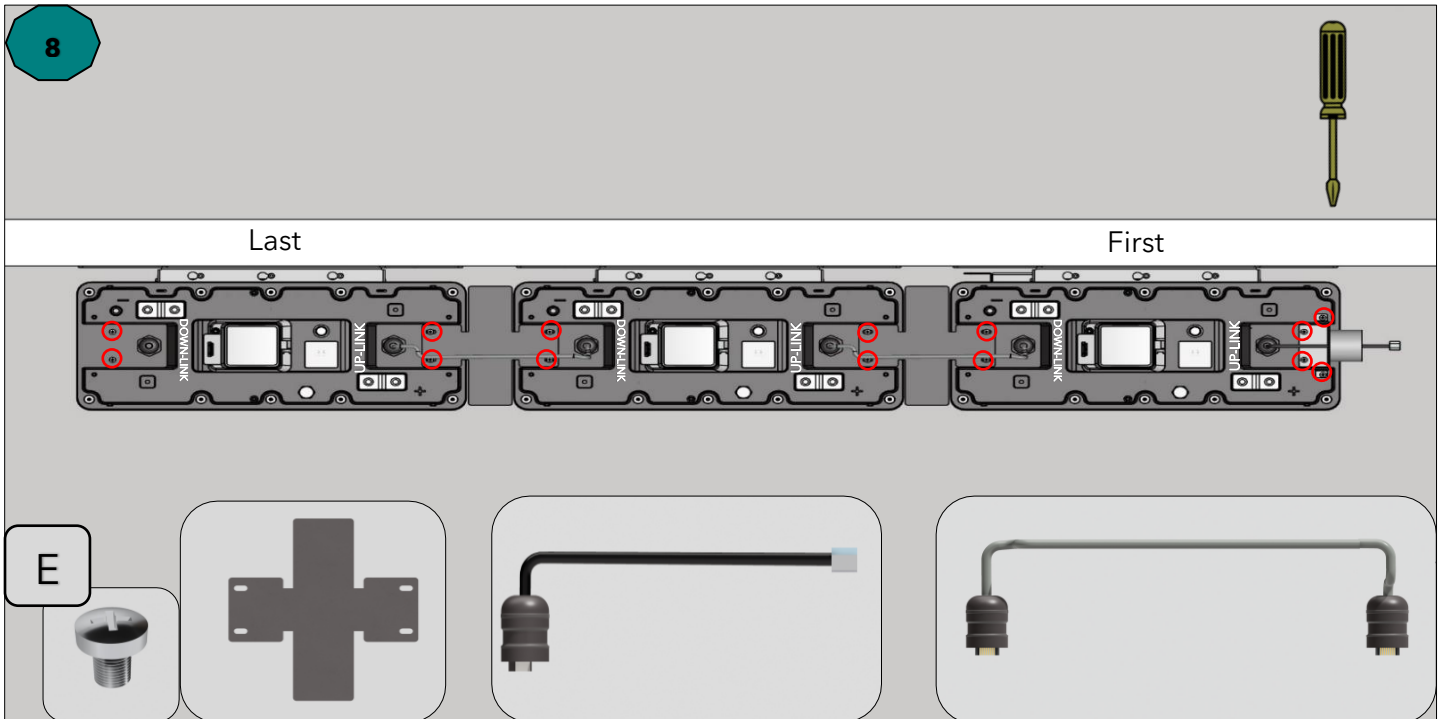



9. Install the included busbars. Run the negative and positive cables to the last and first battery respectively using M8 \* 16 combination cross groove recessed hexagonal head bolts. **Do not reverse polarity the positive and negative terminals;** doing so will void warranty. Use a voltmeter to check polarity before connecting terminals. Also, ensure the terminals are not connected to any metal mounting, fixture, or body part. Slide the battery +/- cables through the included conduit fitting and land on the hybrid inverter's battery port.

9

Ensure the terminals are tightened to the recommended terminal torque of 7.0 - 7.7 Nm (5.1 - 5.7 ft-lb).

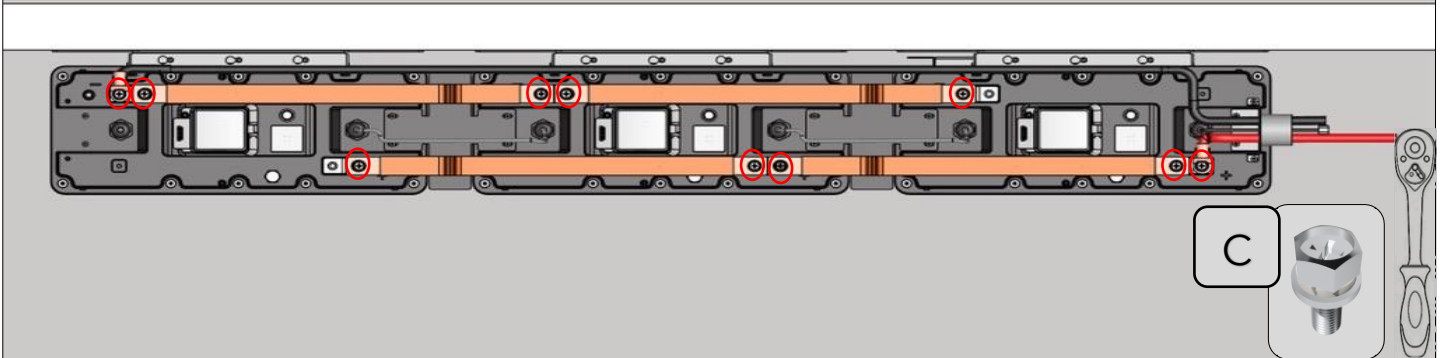

CAUTION! Installation should be designed to minimize the voltage drop between batteries. There are a few best practices: Maintain identical wire length and wire construction from each Fortress Power Battery terminal to the common bus. If Charge and discharge current exceeds 250amps a battery combiner/bus bar is required.



CAUTION! When paralleling the eFlex MAX 5.4 batteries without connecting them via RJ45 cable(s), please make sure the difference between the highest voltage and lowest voltage does not exceed 0.5 volts. A large current flow from the higher voltage battery to the lower voltage battery could potentially damage one or both batteries. Resulting damage to the battery will void the warranty.

10. Mount the top cover by using the M4 \* 8 stainless steel cross recessed countersunk head screw.

10

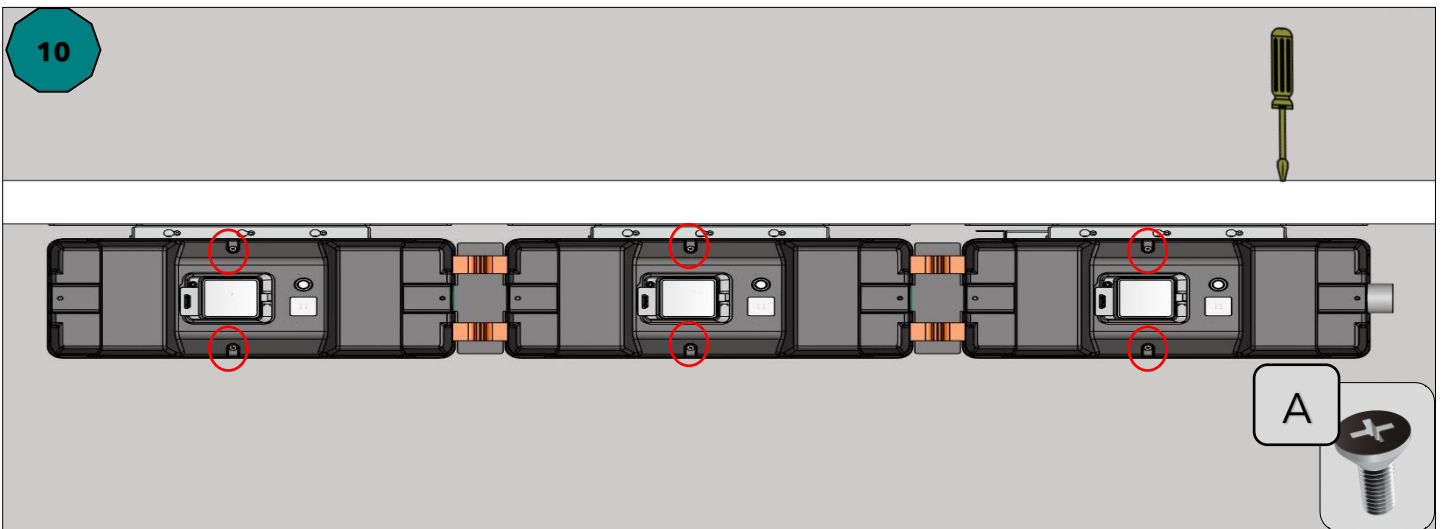



**11.**Mount the top Busbar cover by using the M4 \* 6 stainless steel cross pan head screw.

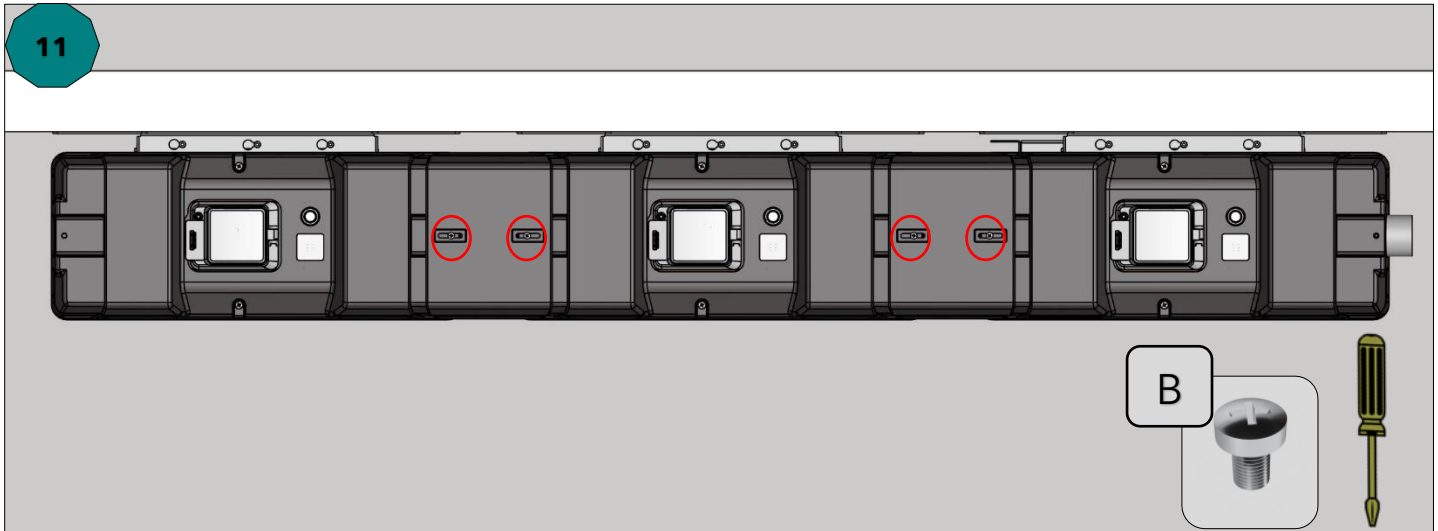

### 8.3 Connecting to the Guardian

The eFlex MAX 5.4 has two universal ports on the lid of the battery, which handle both the battery-battery and battery-inverter communication.

#### 8.3.1 Configuration using CAN Closed Loop communication with Envy Inverter

**12.** Connect the Guardian directly to the Last battery using the included green cable. You may use one of the 2-Way RJ45 splitters as an Extender for cable length extension. Connect the battery-inverter Comm cable from the first Battery to the Battery Comm port in the inverter. You may also use the 2-way splitter for cable extension.

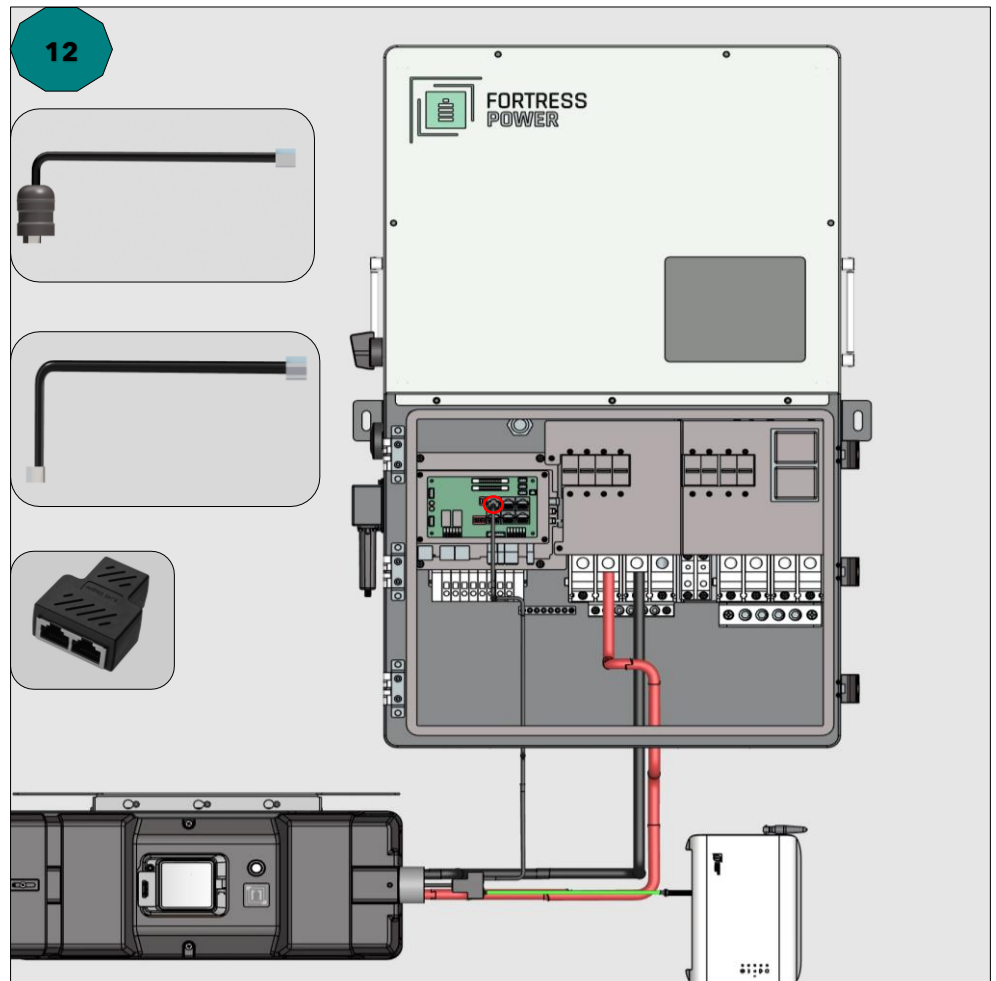

## 9. Commissioning the System

### 9.1 Commissioning a single eFlex MAX battery pack





**13.** Put the inverter disconnect into "OFF" position (if there is any). Make sure the eFlex MAX battery and any charge controllers are off/disconnected as well.

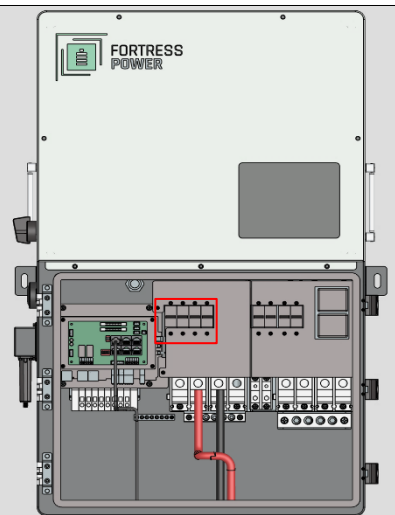
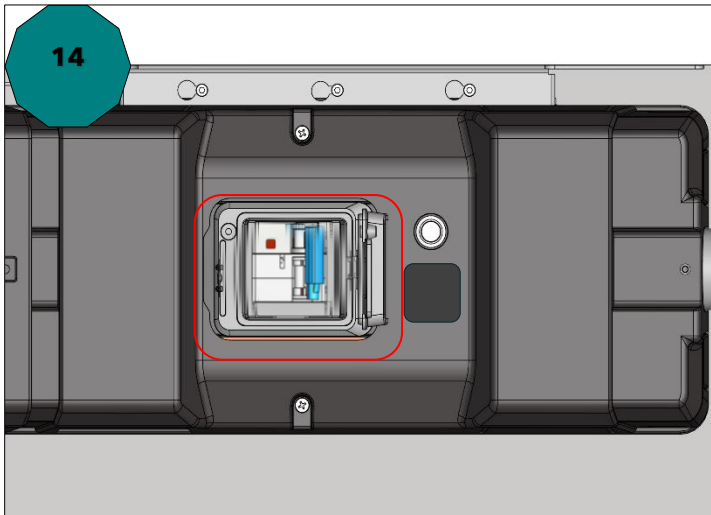
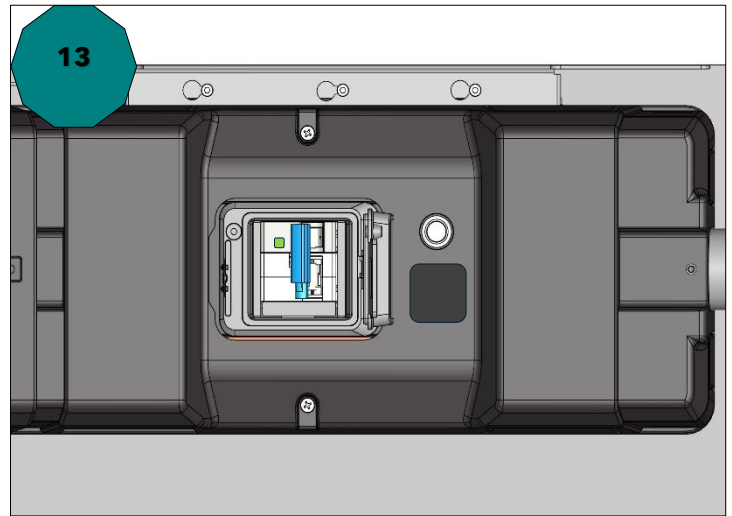

**14.** Turn On the DC Battery Breaker and Hybrid inverter DC Battery Breaker.

**15.** Press and hold the Power Button until you hear a beep, then release. Notice the Fortress Power Logo LED will turn on. Under normal operation, the eFlex MAX LEDs will show state of charge after the diagnostic is complete. The red BMS light should not be on.

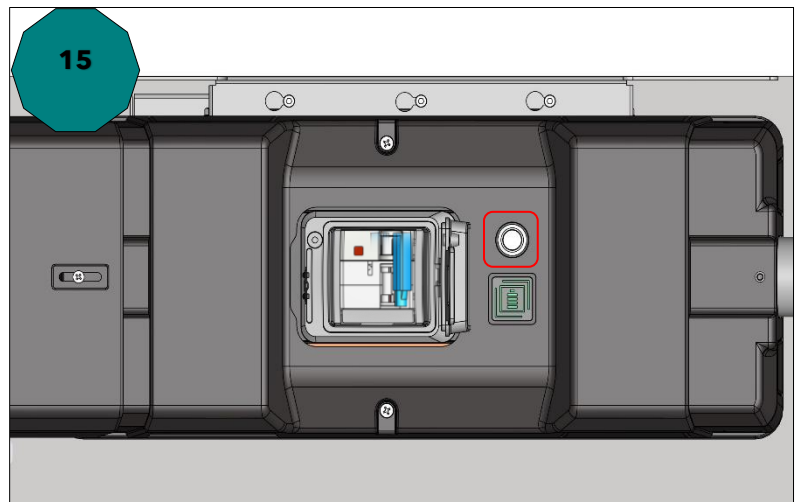



## 9.2 LED Definition

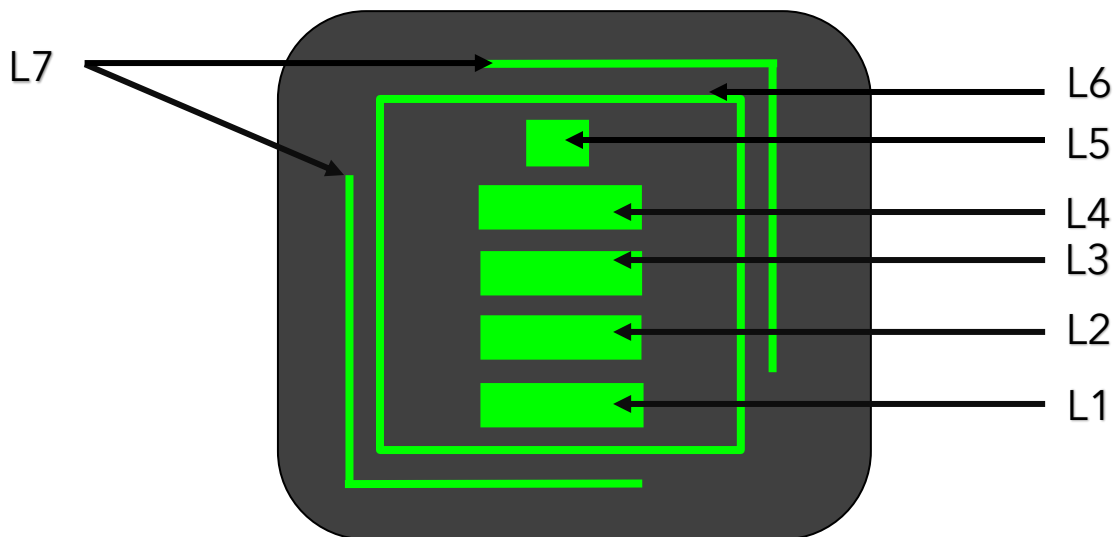

eFlex MAX Light Status Display															
BAT state	Normal/Protection/Warning	SOC%	L-4	L-3	L-2	L-1	L-5	L-6	L-7						
<b>Power ON</b>	N/A	N/A	Bright for 5s												
<b>Power (Charging)</b>		>95	Always				N/A								
		75~95	fast blink	Always											
		50~75	off	fast blink	Always										
		25~50	of	fast blink	Always										
		0~25	off		fast blink										
0%		off													
<b>Power (Discharging)</b>		75~100	slow blink	Always											
		50~75	off	slow blink	Always										
		25~50	off	slow blink	Always										
	0~25	off		slow blink											
	0%	off													
<b>charge</b>	normal	N/A	The indicator is on corresponding to SOC percentage				off	N/A							
	overcharge protection						off								
	over-temperature/under-temperature/overcurrent						slow blink								
	current limiting						off								
<b>discharge</b>	normal						off								
	over-temperature/under-temperature/overcurrent						slow blink								
	failure						Always								
<b>Battery-Battery&amp; Battery-Inverter Communication</b>	success						N/A						Always	Always	
	fail						N/A						off	off	



### 9.3 Commissioning multiple eFlex MAX batteries in parallel

For a maximum battery bank size of 86.4KWH, up to 16 eFlex MAX batteries can be connected in parallel. All wires should be an appropriate gauge and constructed to manage the loads that will be placed upon them. A qualified installer should understand this and must adhere to industry standards and published electrical guidelines. The storage capacity and total permissible charging and discharging amperage are increased by the parallel arrangement. The overall voltage is not changed. Instead, the available amperage from the system is increased with each additional parallel battery. For example, in a parallel system with two batteries, the available charging and discharging current is twice that compared to a single battery. Please follow this procedure to commission eFlex MAX batteries in parallel:

1. Double Check if battery to battery communication cable is connected and secured.
2. Turn On all DC Breakers ON (Battery, Battery port on Hybrid Inverter, Charger Controllers)
3. Turn on the first battery's BMS (the first battery is the one communicating with inverters)
4. Sequentially turn on each additional battery, one after another, ensuring each is activated in the order of their physical arrangement. This step is key to maintaining communication harmony within the battery system. Then Turn on the battery breakers starting with the Master inverter and then others in chronological order.
5. For inverter-specific settings, visit <https://www.fortresspower.com/support> for the most recent integration manual for the specific inverter brand.

### 9.4 Communication Pinout Configuration

If making a communication cable, please refer to the pin out diagram for an RJ45 cable below. Type A format ethernet cable may also be used. PINs 1-4 are the most used pins for Closed Loop Communication.

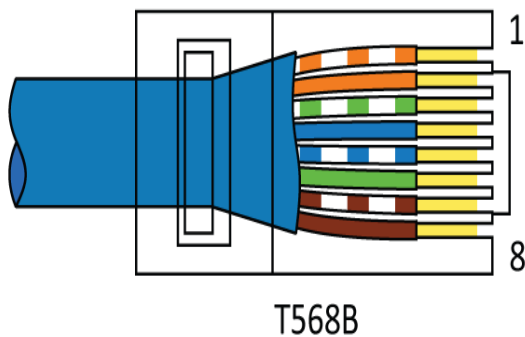

Pin	Color (B format)	Assignment
1	White Orange	CAN1_H
2	Orange	CAN1_L
3	White Green	RS485_A2
4	Blue	RS485_B2
5	White Blue	D1
6	Green	D0
7	White Brown	RS485_A1
8	Brown	RS485_B1



## Complete Installation look (Wire through Optional)



### Configuration Versatile

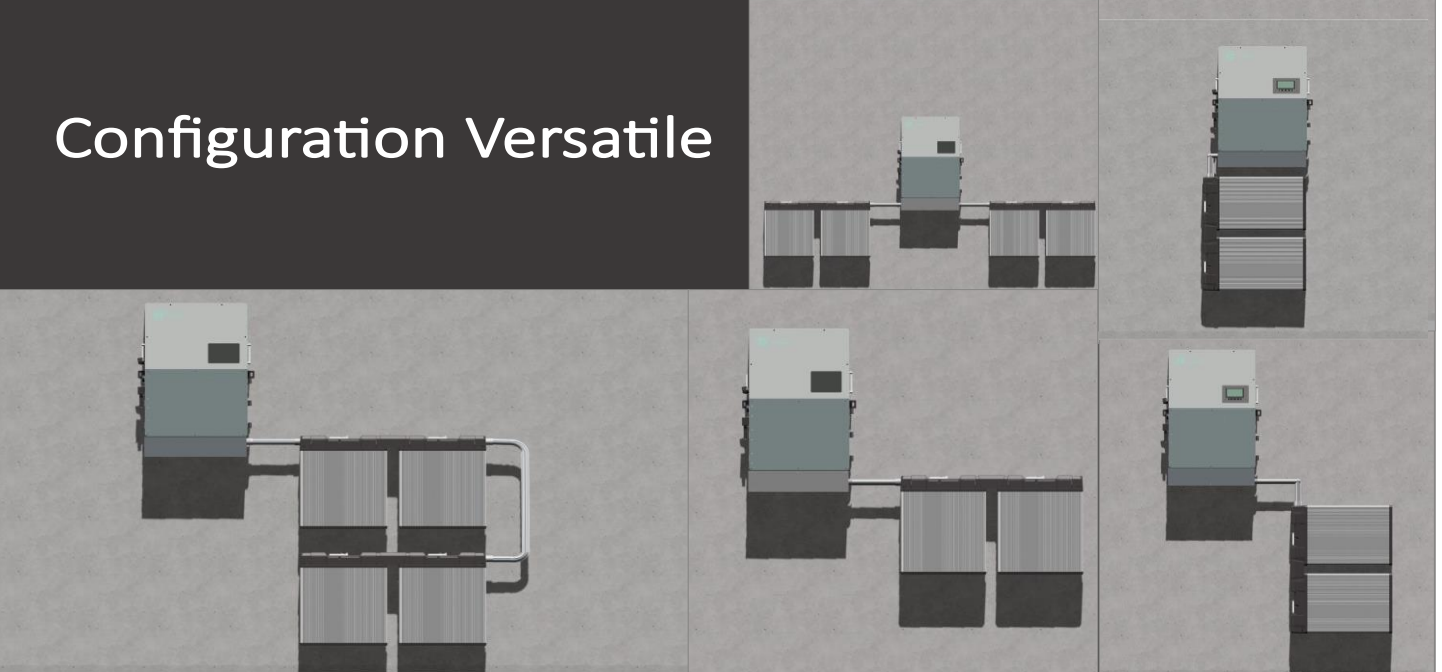



## Floor mount installation

The eFlex MAX 5.4 can be floor-mounted in several orientations. All other orientations are allowed, but regardless of orientation, the included floor mounting bracket must be used to prevent the battery from tipping over. Therefore, it is common to put the back of the eFlex MAX battery against the wall.

Only the Following battery orientation depicted in the images are acceptable.

- Place the eFlex MAX in the preferred orientation.
- Attach the mounting bracket using the T-slot fastener and T-slot groove on the back of the eFlex MAX.
- Screw the mounting bracket into the wall.
- Connect the battery terminals to the corresponding bus bar and inverter.

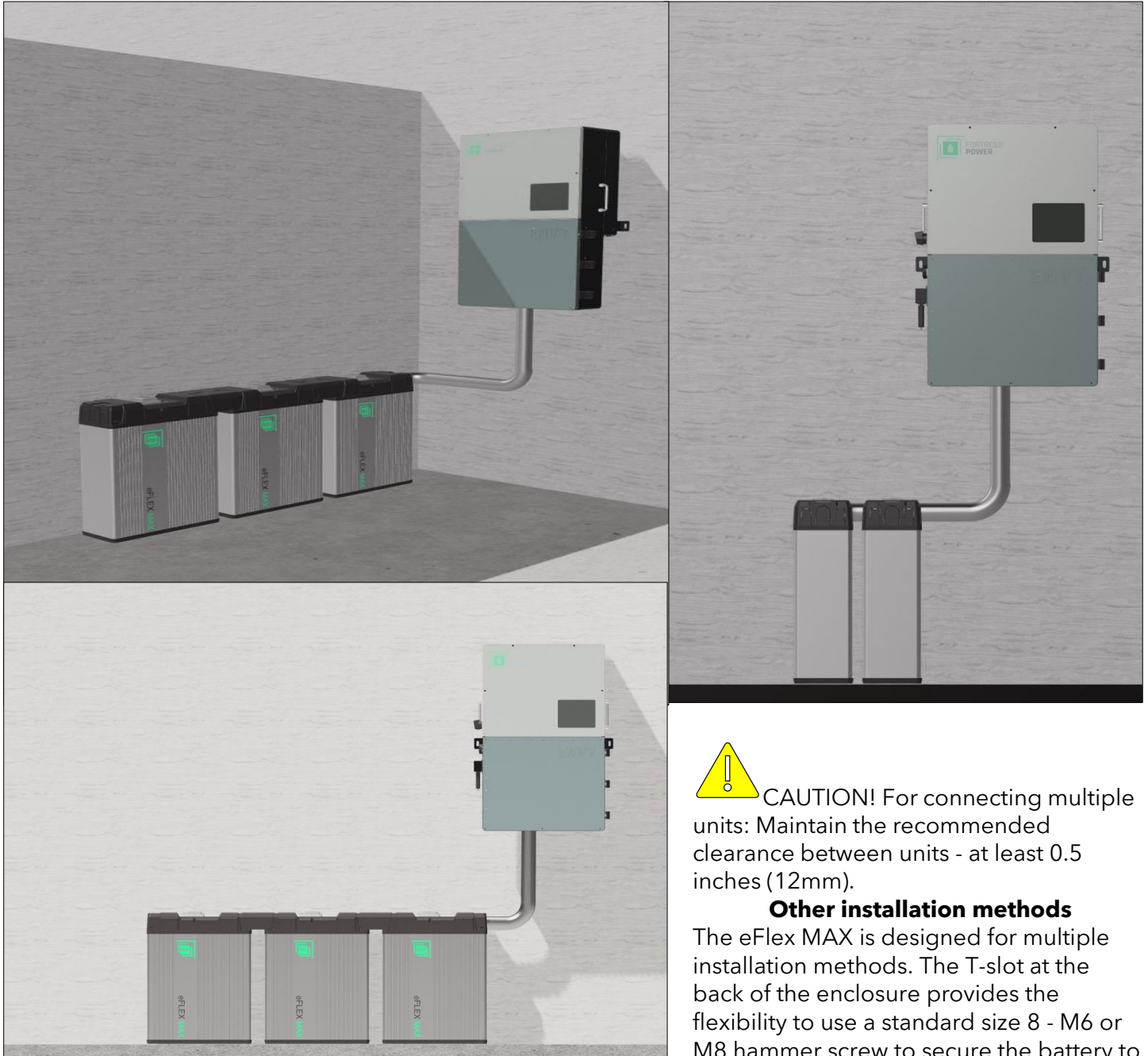

**CAUTION!** For connecting multiple units: Maintain the recommended clearance between units - at least 0.5 inches (12mm).

### Other installation methods

The eFlex MAX is designed for multiple installation methods. The T-slot at the back of the enclosure provides the flexibility to use a standard size 8 - M6 or M8 hammer screw to secure the battery to

a variety of racks, including 19" server racks. In all cases, a clearance of 1" around the eFlex MAX battery is required.



## 9.4.1 Voltage and Amperage Settings



**IMPORTANT** The Hybrid Inverters need to be digitally programmed to comply with correct amperage and voltage stated elsewhere in this guide. Special communication cables may need to be field made. If using battery-inverter communication, please consult our inverter guides:

<https://www.fortresspower.com/inverter-guides>

- Do not use unqualified equipment for charging and discharging, please follow the correct instructions for use.
- Do not discharge the battery when the battery is depleted.
- Do not charge or discharge batteries that are hot, deformed, or leaking.
- The output cable length of the battery should be less than 10 meters long.
- Do not connect a power and load that exceeds the power level to the two ends of the battery.
- Do not mix different batteries. Different manufacturers, chemistry, models, and lifespans cannot be paralleled.

### **Charging Voltage:**

Without battery-inverter communication, eFlex MAX batteries should be charged at 54.4V. With battery-inverter communication, eFlex MAX batteries this voltage may be increased according to the published inverter guides:

<https://www.fortresspower.com/inverter-guides>

### **Low battery cut-off voltage:**

The eFlex MAX battery is below a 20% state-of-charge when its resting voltage is below 51.4V. In order to keep the inverter and battery system powered up while waiting for a charge, this is the recommended low battery cut-off voltage. It is appropriate to lower this to 51V if using a generator or grid charge to automatically maintain or charge the battery at 51.4V or above. Many older battery inverters cannot program a low battery cut-out voltage above 48V. The eFlex MAX has a safety feature that will cut around this voltage level if necessary. If you regularly deep discharge the eFlex MAX down to 48V, please increase your battery size or upgrade your inverter to maintain warranty compliance.

### **Charging and Discharging Amperage**

The eFlex MAX can safely operate at 100A, but its maximum rating is not intended for long duration use. Unless otherwise specified through our inverter guides, set the charge and discharge rates of the eFlex MAX at 60A to comply with the 10-year warranty. Any grid sellback or demand management function should also be limited to 60A per eFlex MAX. Limiting the charge rate of the eFlex MAX to 60A will result in the longest battery life.

Precaution should be taken when adding charging sources which are not controlled by a single inverter or control system (Ex. using different manufacturer's DC charge controllers and inverters, solar + wind inverters, EV chargers etc.) to ensure the total system charges or discharges the battery within its specification. controllers do not charge the battery concurrently, when and if their combined charge current totals are greater than the charge current of the combined battery bank.

Take additional extra precautions when using wind power to charge the battery, or if the inverter and charge controllers are not the same manufacturer.

## 9.4.2 Charging Notes

If the following scenarios occur, the battery must be charged before use, otherwise the battery





damage caused is not covered by the warranty:

- The battery has not been powered on or otherwise discharged without any charging sources available.
- The battery has been turned off for a long period during transportation or storage.
- The battery has been deeply discharged and reached under-voltage protection status.
- The battery has been aggressively recharged during deep discharge conditions through bypassing the BMS.
- The battery has been recharged during freezing condition through bypassing the BMS.
- Bypassing the BMS is not allowed without logging a support ticket with Fortress Technical Support at <https://support.fortresspower.com>

#### 9.4.3 Discharging Notes

- Do not regularly discharge battery below 51V, 20% SoC. This capacity should be reserved for power outages and idling the load until a charging source can be applied.
- Do not discharge battery at rates greater than maximum continuous current.

### Parameter set up guide for Charger/Inverter

Unless explicitly stated in Fortress inverter guides or contrary to the above charging amperages and voltages, charge controller and inverter settings must be programmed per the manufacturer's recommendations. Consult the manufacturer's manuals and/or access technical support. To achieve extended life cycles and to comply with the Warranty, the following guidelines should be followed:

#### 9.4.4 Understanding Charge Stage

1. Bulk Charge: Charge at Constant Current (CC) to Bulk/Absorb Voltage.
2. Absorption Charge: Maintain Constant Bulk/Absorb Voltage (CV). Note - if the battery is not reaching 100% capacity, it is allowable to adjust this voltage from 54.4V to 55V. Any higher charging voltage must be explicitly stated a Fortress inverter guide specific to that brand of inverter.
3. Unless otherwise stated in a Fortress inverter guide, keep float voltages at 54.4V or less to maintain warranty compliance. While most end users will want to enable a float mode of operation if available to keep batteries at 100%, it is healthier for the battery only to use the bulk/absorb cycle - which allows the batteries to exercise daily.

### 9.5 Decommissioning

At the End of Cycle Life retained capacity is equivalent to 70% Year 1 Capacity. eFlex MAX contains scrap material useful to recycling. Dispose of the battery at a local recycling center or ship back to Fortress Power. Transport end-of-life batteries at 30% state-of-charge, <52V resting.

### 9.6 Key Points Summary

1. Each Fortress Lithium Battery contains circuitry that protects the Lithium Ferro Phosphate cells from overcharging, over-discharging, and excessive load amperage. If the values specified are exceeded, the battery will enter a protective shut down state. In some cases, this may result in the need to





reinitialize an inverter charger or other pieces of equipment in the installation. In other cases, the inverter's system settings may be saved within the inverter memory storage and will not need to be reset. This is not an absolute standard but is common among most inverter chargers. Check your inverter manufacturer specifications.

2. Although each Fortress Lithium Battery contains circuitry that protects the Lithium Ferro Phosphate cells from overcharging, over-discharging and excessive load amperage, Fortress Lithium Batteries must always be installed with a charge controller and the appropriate settings to protect the batteries from open PV and other high voltage sources. Fortress Lithium Batteries alone will not protect from extreme electrical phenomena.
3. GRID TIED SYSTEMS: Once the Fortress Lithium Battery has been installed, turn on the entire system to test. Once testing has been completed, please disconnect the batteries from the load center until your local Utility Inspector is ready to turn on the entire system. The charge controllers and inverter monitoring systems can drain the Fortress Lithium Batteries over an extended period when the entire system is not fully operational due to the electrical draw of the system components.
4. OFF GRID SYSTEMS: Do not connect the Fortress Lithium Batteries until the entire system is ready to turn on and is fully operational. 5. See Inverter and Charge Controller Settings on the Fortress Power website for recommended settings at <https://www.fortresspower.com/resources/>.

## 9.7 System Commissioning

Final installation and operation guidelines will be dictated by your Electrician and Installer based on the specifics of your installation and any code requirements that apply to your region. Fortress Power technicians and sales staff are available to provide any additional information on the Fortress Lithium Batteries as needed. Please be aware of the potential electrical hazards before interacting with any and all electrical or mechanical devices. Please take all necessary safety precautions in your projects and installations.

## 10. Quick Troubleshooting

### Alarms



#### 1. Potential Over Current Discharge

- a. Power Off Batteries starting with the Last battery and chronologically leading to the first.
- b. Press and Hold the Power Button until Power down sequence starts. Leave battery DC breakers on, including the battery breaker in the hybrid inverter. Everything else should be left off.
- c. Power on First Battery (battery where comms is connected directly to the battery comms of the inverter (Closed Loop)



#### 2. Communication Error

- a. Make sure that all batteries are connected to each other. Follow the Uplink-to Down-Link Sequence.
- b. Make sure that Battery to Inverter comm cable is connected. Note: It takes about 1 minute for the communication to be established between inverter and battery.



#### 3. Battery Deeply Discharged

- a. Isolate the battery with issue from the system.
- b. Measure Voltage from the negative Booster Port to the positive terminal.
- c. Once confirmed, apply connect a 48V @5ADC MAX to the negative booster port and positive terminal and begin to charge. Once 48V is reached, proceed in commissioning.



## 11. Contact Information



# FORTRESS POWER

Secure your energy

### **For Technical Support Please Contact us at Tech-Support Contact Information**

#### Useful Links

- Phone:  
Tech Support (877) 497-6937  
Tech Support (Spanish) (215) 710-8960
- Support Tickets: <https://www.fortresspower.com/support/>
- Warranty Submittal: <https://www.fortresspower.com/warranty/>

Updated Documentation  
**SCAN HERE**



System Design Tool  
**SCAN HERE**





## NOTES