

Bayerische Meisterschaft Schüler - LK 2023

2023.02.11 - 2023.02.11

Jahnstraße 6, 84508 Burgkirchen an der Alz

GERMANY,GER



Bayerische Meisterschaft Schüler - LK 2023

GERMANY

2023.02.11 - 2023.02.11

Jahnstraße 6, 84508 Burgkirchen an der Alz

Participation List (by Club/Team)

#	Code	Club	Male	Female	Total Entries	Total Athletes
1	 GER	1. FC Schnaittach(1. FC Schnaittach)	0	1	1	1
2	 GER	1. Karate Club Passau[1](e.V.[1])	2	2	4	4
3	 GER	1. Kemptener Karate Dojo im TV Kempten(TVK)	1	0	1	1
4	 GER	1.CKKS Traunreut(1.CKKS)	9	11	20	17
5	 GER	ASV Dachau(ASV Dachau)	3	6	9	6
6	 GER	Asia Sports Karateschule (A.S. Waldkraiburg)	12	15	27	17
7	 GER	ESV München Karate(ESV München)	1	2	3	3
8	 GER	K-C- Shogun Memmingen e. V.(KCSM[6])	6	5	11	9
9	 GER	KD Oki Bayern[1](KD Oki BAYERN[1])	0	1	1	1
10	 GER	KD Straubing(KD Straubing)	7	7	14	10
11	 GER	KaraFLEX Karateclub Günzburg(KaraFlex Günzburg)	2	1	3	3
12	 GER	Karate Centrum Hersbruck e.V. (KC Hersbruck)	0	1	1	1
13	 GER	Karate Dojo Durach-Weidach(KD Durach)	2	0	2	2
14	 GER	Karate Dojo Naila(KDNaila)	0	1	1	1
15	 GER	Karate Dojo Oki BAYERN(KD Oki BAYERN)	8	7	15	10
16	 GER	Karate Dojo TV Haldenwang e.V.(Karate Dojo Haldenwang)	4	1	5	5
17	 GER	Karate Dojo Untermerzbach(KD-Untermerzbach)	0	4	4	4
18	 GER	Karate SV Altenstadt/WN(Karate SV Altenstadt)	0	2	2	1
19	 GER	Karate Verein Herzogenaurach(KVH)	4	2	6	4
20	 GER	Karate-Dojo München I e.V.(KDM1)	2	1	3	3
21	 GER	MTSV Schwabing e.V.(MTSV Schwabing)	0	1	1	1
22	 GER	Okinawa Karate TSV Feichten(Okinawa Karate Feichten)	4	0	4	3
23	 GER	Okinawa Karate Tus Alztal Garching[1](TuS Alztal[1])	3	3	6	6
24	 GER	Polizei-SV Augsburg e.V.(PSV-Augsburg)	4	1	5	5
25	 GER	Post SV Bamberg[DKV](Post SV Bamberg[DKV])	0	4	4	3
26	 GER	SG Moosburg e.V. Abteilung Karate(SG Moosburg Karate)	0	1	1	1
27	 GER	SRS Karate Burgkirchen(SVGB)	2	3	5	5
28	 GER	SV Steinheim e.V.(SV Steinheim e.V.)	7	0	7	4
29	 GER	SV UNSU Karate Mömlingen e.V.[1](UNSU Team)	9	7	16	12
30	 GER	Shotokan Karate Breitenberg(Breitenberg)	6	2	8	7
31	 GER	TG Schweinfurt 1848 e.V.(TG SW)	2	2	4	4
32	 GER	TSV 1888 Waging am See e.V.(TSV Waging)	5	0	5	4
33	 GER	TSV Erding[1](TSV Erding[1])	1	4	5	5















Bayerische Meisterschaft Schüler - LK 2023

GERMANY

2023.02.11 - 2023.02.11

Jahnstraße 6, 84508 Burgkirchen an der Alz

Participation List (by Club/Team)

34		GER	TSV Grabenstätt / Chiemsee e. V.(TSV Grabenstätt)	1	2	3	2
35		GER	TSV Grasbrunn-Neukeferloh(Neukeferloh)	6	0	6	4
36		GER	TSV Jahn 1892 Würzburg e.V.[DKV](TSV Jahn 1892 Würzburg e.V.[DKV])	0	1	1	1
37		GER	TSV Milbertshofen-München(TSV Milbertshofen)	2	3	5	5
38		GER	TSV Monheim e.V.(TSVM)	11	4	15	13
39		GER	TSV Vilsbiburg 1883 e.V.[DKV](TSV Vilsbiburg 1883 e.V.[DKV])	0	1	1	1
40		GER	TSV-Trostberg(Abteilung Karate)	0	2	2	2
41		GER	TV 1911 Vohburg(TVVoh)	5	4	9	9
42		GER	TV Fürth 1860 e.V.[1](TV Fürth[1])	4	1	5	8
43		GER	TV Trennfurt(TVT)	1	0	1	1
44		GER	TV48 Erlangen Karate(TV48 Erlangen)	2	0	2	1
45		GER	Traditionelle Karate Schule München e.V.(TKS München)	4	0	4	2
46		GER	TuS Feuchtwangen(Tus Feuchtwangen)	0	2	2	2
47		GER	TuS Fürstenfeldbruck(TuS FFB)	2	0	2	2
Totals:				144	118	262	216



Bayerische Meisterschaft Schüler - LK 2023

GERMANY

2023.02.11 - 2023.02.11

Jahnstraße 6, 84508 Burgkirchen an der Alz

Tournament Participation (Entries) by Club

 GERMANY					
 1. FC Schnaittach(1. FC Schnaittach)					
ID	Sex	Family Name	Given Name	Category	
1	Female	Perl	Alegra	Kata Schüler A w	

Entries: 1

Bayerische Meisterschaft Schüler - LK 2023

GERMANY

2023.02.11 - 2023.02.11

Jahnstraße 6, 84508 Burgkirchen an der Alz

Tournament Participation (Entries) by Club

 1. Karate Club Passau(e.V.)					
ID	Sex	Family Name	Given Name	Category	
2	Male	Stanciu	Stefan	Kumite Leistungsklasse -67 kg männlich	
3	Male	Stang	Bruno	Kata Schüler A m	
4	Female	Wiedenmann	Franziska	Kata Leistungsklasse weiblich	
5	Female	Wieland	Smilla	Kata Leistungsklasse weiblich	

Entries: 4

Bayerische Meisterschaft Schüler - LK 2023

GERMANY

2023.02.11 - 2023.02.11

Jahnstraße 6, 84508 Burgkirchen an der Alz

Tournament Participation (Entries) by Club

 1. Kemptener Karate Dojo im TV Kempten(TVK)					
ID	Sex	Family Name	Given Name	Category	
6	Male	Grillinger	Jonah	Kumite Schüler A -44kg männlich	

Entries: 1

Bayerische Meisterschaft Schüler - LK 2023

GERMANY

2023.02.11 - 2023.02.11

Jahnstraße 6, 84508 Burgkirchen an der Alz

Tournament Participation (Entries) by Club

 1.CKKS Traunreut(1.CKKS)					
ID	Sex	Family Name	Given Name	Category	
7	Female	Appel	Felicitas	KUMITE TEAM Schüler weiblich	
8	Female	Appel	Felicitas	Kumite Schüler B -30kg weiblich	
9	Female	Cosic	Medina	KUMITE TEAM Schüler weiblich	
10	Female	Cosic	Medina	Kumite Schüler A +49kg weiblich	
11	Female	Dordevic	Teodoira	KUMITE TEAM Schüler weiblich	
12	Female	Dordevic	Teodoira	Kumite Schüler A +49kg weiblich	
13	Male	Fellinger	Philipp	Kumite Team Schüler männlich	
14	Male	Fellinger	Philipp	Kumite Schüler B +38kg männlich	
15	Female	Gastl	Veronika	Kumite Leistungsklasse -61 kg weiblich	
16	Female	Gisser	Isabel	Kumite Leistungsklasse -50 kg weiblich	
17	Male	Gruchot	Maximilian	Kumite Team Schüler männlich	
18	Male	Gruchot	Maximilian	Kumite Schüler B -38kg männlich	
19	Female	Hajduchova	Veronika	Kumite Leistungsklasse -61 kg weiblich	
20	Male	Herrgottschöfer	Nick	Kumite Schüler B -38kg männlich	
21	Female	Hrvoic	Lana	Kumite Leistungsklasse -68 kg weiblich	
22	Male	Jobst	David	Kumite Leistungsklasse -84 kg männlich	
23	Male	Jobst	David	Kumite Team Herren	
24	Male	Medwedew	Daniel	Kumite Schüler B -38kg männlich	
25	Male	Medwedew	Daniel	Kumite Team Schüler männlich	
26	Female	Medwedew	Marie	KUMITE TEAM Schüler weiblich	
27	Female	Medwedew	Marie	Kumite Schüler B -30kg weiblich	
28	Male	Schalch	Pascal	Kumite Team Herren	
29	Male	Schalch	Pascal	Kumite Leistungsklasse +84 kg männlich	
30	Female	Shchelkanova	Mascha	Kumite Schüler B -36kg weiblich	
31	Female	Tejada-Heidenhain	Laura	Kumite Leistungsklasse -68 kg weiblich	
32	Male	Terengin	Wladimir	Kumite Team Herren	
33	Male	Terengin	Wladimir	Kumite Leistungsklasse +84 kg männlich	

Entries: 27

Bayerische Meisterschaft Schüler - LK 2023

GERMANY

2023.02.11 - 2023.02.11

Jahnstraße 6, 84508 Burgkirchen an der Alz

Tournament Participation (Entries) by Club

 Asia Sports Karateschule (A.S. Waldkraiburg)					
ID	Sex	Family Name	Given Name	Category	
34	Male	Akgün	Joel - Leon	Kumite Leistungsklasse -84 kg männlich	
35	Female	Decker	Katharina	Kumite Schüler A +49kg weiblich	
36	Female	Decker	Katharina	Kata Schüler A w	
37	Female	Decker	Katharina	KUMITE TEAM Schüler weiblich	
38	Female	Ehling	Isabella	KUMITE TEAM Schüler weiblich	
39	Female	Ehling	Isabella	Kumite Schüler A -44kg weiblich	
40	Female	Ehling	Magdalena	Kata Schüler A w	
41	Female	Ehling	Magdalena	Kata Team Schüler A+B weiblich	
42	Female	Ehling	Magdalena	KUMITE TEAM Schüler weiblich	
43	Female	Ehling	Magdalena	Kata Schüler A w R3 Bronze Medal Match 1	
44	Female	Ehling	Magdalena	Kata Schüler A w R2-G1	
45	Male	Fischer	Markus	Kata Schüler B Einzel m R2-G1	
46	Male	Fischer	Markus	Kata Team Schüler A+B männlich R2 Gold Medal Match	
47	Male	Fischer	Markus	Kata Schüler B Einzel m	
48	Male	Fischer	Markus	Kumite Schüler B +38kg männlich	
49	Male	Fischer	Markus	Kata Team Schüler A+B männlich	
50	Male	Fischer	Markus	Kumite Team Schüler männlich	
51	Male	Fischer	Markus	Kata Schüler B Einzel m R3 Bronze Medal Match 1	
52	Female	Hapfelmeier	Louisa	Kata Schüler B Einzel w	
53	Female	Hapfelmeier	Louisa	Kata Schüler B Einzel w R3 Gold Medal Match	
54	Female	Hapfelmeier	Louisa	Kata Schüler B Einzel w R2-G1	
55	Female	Hapfelmeier	Louisa	Kata Team Schüler A+B weiblich	
56	Male	Hütter	Michael	Kata Team Schüler A+B männlich R2 Gold Medal Match	
57	Male	Hütter	Michael	Kata Schüler B Einzel m	
58	Male	Hütter	Michael	Kata Team Schüler A+B männlich	
59	Male	Hütter	Michael	Kumite Team Schüler männlich	
60	Male	Hütter	Michael	Kata Schüler B Einzel m R2-G2	
61	Female	Krieger	Lena	KUMITE TEAM Schüler weiblich	
62	Female	Krieger	Lena	Kumite Schüler A +49kg weiblich	
63	Female	Krieger	Lena	Kata Team Schüler A+B weiblich	
64	Female	Krieger	Lena	Kata Schüler A w	
65	Male	Libik	Daniel	Kata Schüler A m	
66	Male	Libik	Daniel	Kata Schüler A m R2-G2	
67	Male	Libik	Daniel	Kata Team Schüler A+B männlich	
68	Male	Libik	Daniel	Kata Schüler A m R3 Bronze Medal Match 2	
69	Male	Libik	Daniel	Kumite Team Schüler männlich	
70	Male	Libik	Daniel	Kumite Schüler A -38kg männlich	
71	Male	Libik	Daniel	Kata Team Schüler A+B männlich R2 Gold Medal Match	
72	Male	Mehlhaff	Alexander	Kumite Team Schüler männlich	
73	Male	Mehlhaff	Alexander	Kata Schüler B Einzel m	
74	Female	Peteratzinger	Stefanie	Kata Leistungsklasse weiblich	
75	Female	Schmidt	Anika	Kata Leistungsklasse weiblich	
76	Female	Schmidt	Lisa	Kata Schüler B Einzel w R3 Bronze Medal Match 1	

Bayerische Meisterschaft Schüler - LK 2023

GERMANY

2023.02.11 - 2023.02.11

Jahnstraße 6, 84508 Burgkirchen an der Alz

Tournament Participation (Entries) by Club

77	Female	Schmidt	Lisa	Kumite Schüler B +36kg weiblich
78	Female	Schmidt	Lisa	Kata Schüler B Einzel w
79	Female	Schmidt	Lisa	Kata Schüler B Einzel w R2-G2
80	Male	Spirkl	Markus	Kumite Leistungsklasse -84 kg männlich
81	Male	Stelzl	Alexander	Kata Leistungsklasse männlich
82	Male	Stelzl	Alexander	Kumite Leistungsklasse -67 kg männlich
83	Female	Vlai	Jessica	Kata Leistungsklasse weiblich R3 Gold Medal Match
84	Female	Vlai	Jessica	Kata Leistungsklasse weiblich R2-G1
85	Female	Vlai	Jessica	Kata Leistungsklasse weiblich
86	Female	Zinecker	Marie	Kata Leistungsklasse weiblich
87	Female	Zinecker	Marie	Kata Leistungsklasse weiblich R2-G2

Entries: **54**

Bayerische Meisterschaft Schüler - LK 2023

GERMANY

2023.02.11 - 2023.02.11

Jahnstraße 6, 84508 Burgkirchen an der Alz

Tournament Participation (Entries) by Club

 ASV Dachau(ASV Dachau)					
ID	Sex	Family Name	Given Name	Category	
88	Female	Burgmeier	Anna	Kata Team Schüler A+B weiblich	
89	Male	Corae	Raoul	Kumite Schüler B -32kg männlich	
90	Female	Dörsch	Rosalie	Kata Team Schüler A+B weiblich	
91	Female	Dörsch	Rosalie	Kata Schüler B Einzel w	
92	Female	Dörsch	Rosalie	Kumite Schüler B -30kg weiblich	
93	Female	Geiger	Julia	Kumite Schüler B -30kg weiblich	
94	Male	Knetemann	Darien	Kumite Schüler B -32kg männlich	
95	Male	Knetemann	Darien	Kata Schüler B Einzel m	
96	Female	Schierack	Anna Sofie	Kumite Schüler B +36kg weiblich	
97	Female	Schierack	Anna Sofie	Kata Team Schüler A+B weiblich	
98	Female	Schierack	Anna Sofie	Kata Schüler B Einzel w	

Entries: 11

Bayerische Meisterschaft Schüler - LK 2023

GERMANY

2023.02.11 - 2023.02.11

Jahnstraße 6, 84508 Burgkirchen an der Alz

Tournament Participation (Entries) by Club

 ESV München Karate(ESV München)					
ID	Sex	Family Name	Given Name	Category	
99	Female	Brand	Kerstin	Kata Leistungsklasse weiblich	
100	Male	Petrovic	Marko	Kata Leistungsklasse männlich R2-G2	
101	Male	Petrovic	Marko	Kata Leistungsklasse männlich	
102	Female	Schröder	Alena	Kata Leistungsklasse weiblich	

Entries: 4

Bayerische Meisterschaft Schüler - LK 2023

GERMANY

2023.02.11 - 2023.02.11

Jahnstraße 6, 84508 Burgkirchen an der Alz

Tournament Participation (Entries) by Club

 K-C- Shogun Memmingen e. V.(KCSM)					
ID	Sex	Family Name	Given Name	Category	
103	Male	Aloisio	Matteo	Kumite Leistungsklasse -60 kg männlich	
104	Male	Aloisio	Matteo	Kumite Team Herren	
105	GER408	Basaran	Abdül-Kadir	Kumite Leistungsklasse -84 kg männlich	
106	GER408	Basaran	Abdül-Kadir	Kumite Team Herren	
107	Female	Chyhasova	Kateryna	KUMITE TEAM Schüler weiblich	
108	Female	Chyhasova	Kateryna	Kumite Schüler B -36kg weiblich	
109	Female	Chyhasova	Taisiia	Kumite Schüler A -44kg weiblich	
110	Female	Chyhasova	Taisiia	KUMITE TEAM Schüler weiblich	
111	Male	Hachichi	Djamel Eddine	Kumite Leistungsklasse +84 kg männlich	
112	Male	Hachichi	Djamel Eddine	Kumite Team Herren	
113	Male	Sayin	Berke	Kumite Leistungsklasse +84 kg männlich	
114	Male	Sayin	Berke	Kumite Team Herren	
115	Female	Walter	Eliza	Kumite Schüler B +36kg weiblich	
116	Female	Walter	Eliza	KUMITE TEAM Schüler weiblich	
117	GER411	YILDIRIM	MERYEM	Kumite Leistungsklasse +68 kg weiblich	
118	Male	Zengin	Muhammed	Kumite Leistungsklasse -75 kg männlich	
119	Male	Zengin	Muhammed	Kumite Team Herren	

Entries: 17

Bayerische Meisterschaft Schüler - LK 2023

GERMANY

2023.02.11 - 2023.02.11

Jahnstraße 6, 84508 Burgkirchen an der Alz

Tournament Participation (Entries) by Club

 KaraFLEX Karateclub Günzburg(KaraFlex Günzburg)					
ID	Sex	Family Name	Given Name	Category	
120	Female	Blank	Meryl	Kumite Leistungsklasse -61 kg weiblich	
121	Male	Smovkin	Alex	Kumite Leistungsklasse -67 kg männlich	
122	Male	Weitmann	Lukas	Kumite Leistungsklasse -75 kg männlich	

Entries: 3

Bayerische Meisterschaft Schüler - LK 2023

GERMANY

2023.02.11 - 2023.02.11

Jahnstraße 6, 84508 Burgkirchen an der Alz

Tournament Participation (Entries) by Club

 Karate Centrum Hersbruck e.V. (KC Hersbruck)					
ID	Sex	Family Name	Given Name	Category	
123	Female	Trenz	Bianca	Kumite Leistungsklasse +68 kg weiblich	

Entries: 1

Bayerische Meisterschaft Schüler - LK 2023

GERMANY

2023.02.11 - 2023.02.11

Jahnstraße 6, 84508 Burgkirchen an der Alz

Tournament Participation (Entries) by Club

 Karate Dojo Durach-Weidach(KD Durach)					
ID	Sex	Family Name	Given Name	Category	
124	Male	Berner	Laurenz	Kata Leistungsklasse männlich R2-G1	
125	Male	Berner	Laurenz	Kata Leistungsklasse männlich	
126	Male	Berner	Laurenz	Kata Leistungsklasse männlich R3 Gold Medal Match	
127	Male	Mathes	Mika	Kata Leistungsklasse männlich R3 Gold Medal Match	
128	Male	Mathes	Mika	Kata Leistungsklasse männlich R2-G2	
129	Male	Mathes	Mika	Kata Leistungsklasse männlich	

Entries: 6

Bayerische Meisterschaft Schüler - LK 2023

GERMANY

2023.02.11 - 2023.02.11

Jahnstraße 6, 84508 Burgkirchen an der Alz

Tournament Participation (Entries) by Club

 Karate Dojo Naila(KDNaila)					
ID	Sex	Family Name	Given Name	Category	
130	Female	Hörner	Frieda	Kumite Schüler B +36kg weiblich	

Entries: 1

Bayerische Meisterschaft Schüler - LK 2023

GERMANY

2023.02.11 - 2023.02.11

Jahnstraße 6, 84508 Burgkirchen an der Alz

Tournament Participation (Entries) by Club

 Karate Dojo Oki BAYERN(KD Oki BAYERN)					
ID	Sex	Family Name	Given Name	Category	
131	Female	Biedemann	Greta	Kata Schüler A w R2-G1	
132	Female	Biedemann	Greta	Kata Schüler A w	
133	Female	Biedemann	Greta	Kata Schüler A w R3 Gold Medal Match	
134	Female	Biedemann	Hannah	Kata Schüler A w	
135	Female	Biedemann	Hannah	Kata Schüler A w R3 Gold Medal Match	
136	Female	Biedemann	Hannah	Kata Schüler A w R2-G2	
137	Male	Mahovkic	Ajdin	Kumite Schüler A -44kg männlich	
138	Male	Mahovkic	Ajdin	Kumite Team Schüler männlich	
139	Female	Mahovkic	Ajna	KUMITE TEAM Schüler weiblich	
140	Male	Maier	Adrian	Kumite Team Schüler männlich	
141	Male	Maier	Adrian	Kumite Schüler A -38kg männlich	
142	Male	Maier	Adrian	Kata Schüler A m	
143	Male	Sabanovic	Omer	Kumite Team Schüler männlich	
144	Male	Sabanovic	Omer	Kumite Schüler A -38kg männlich	
145	Male	Sabanovic	Omer	Kata Schüler A m	
146	Male	Sabanovic	Said	Kumite Team Schüler männlich	
147	Male	Sabanovic	Said	Kumite Schüler A -49kg männlich	
148	Male	Sabanovic	Said	Kata Schüler A m	
149	Female	Saljic	Dalia	Kumite Schüler A -44kg weiblich	
150	Female	Saljic	Dalia	KUMITE TEAM Schüler weiblich	
151	Female	Seidelt	Alina	Kumite Schüler B -30kg weiblich	
152	Female	Seidelt	Alina	Kata Schüler B Einzel w	
153	Female	Seidelt	Alina	KUMITE TEAM Schüler weiblich	
154	Female	Seidelt	Alina	Kata Schüler B Einzel w R2-G2	
155	Female	Tzecheridis	Andriana	Kumite Schüler B +36kg weiblich	
156	Female	Tzecheridis	Andriana	KUMITE TEAM Schüler weiblich	

Entries: 26

Bayerische Meisterschaft Schüler - LK 2023

GERMANY

2023.02.11 - 2023.02.11

Jahnstraße 6, 84508 Burgkirchen an der Alz

Tournament Participation (Entries) by Club

 Karate Dojo TV Haldenwang e.V.(Karate Dojo Haldenwang)					
ID	Sex	Family Name	Given Name	Category	
157	Male	Freudling	Louis	Kata Schüler A m	
158	Male	Freudling	Tobias	Kata Schüler A m	
159	Female	Merlens	Theresa	Kata Schüler A w	
160	Male	Reichart	Lukas	Kumite Leistungsklasse -75 kg männlich	
161	Male	Wörz	Timo	Kata Schüler A m	
162	Male	Wörz	Timo	Kata Schüler A m R2-G2	

Entries: 6

Bayerische Meisterschaft Schüler - LK 2023

GERMANY

2023.02.11 - 2023.02.11

Jahnstraße 6, 84508 Burgkirchen an der Alz

Tournament Participation (Entries) by Club

 Karate Dojo Untermerzbach(KD-Untermerzbach)					
ID	Sex	Family Name	Given Name	Category	
163	Female	Bayer	Nike Emilie	Kumite Schüler B -30kg weiblich	
164	Female	Maempel	Lina	Kumite Schüler A -44kg weiblich	
165	Female	Schmidt-Hammer	Lea	Kumite Leistungsklasse +68 kg weiblich	
166	Female	Schulz	Eva	Kumite Schüler B +36kg weiblich	

Entries: 4

Bayerische Meisterschaft Schüler - LK 2023

GERMANY

2023.02.11 - 2023.02.11

Jahnstraße 6, 84508 Burgkirchen an der Alz

Tournament Participation (Entries) by Club

 Karate SV Altstadt/WN(Karate SV Altstadt)					
ID	Sex	Family Name	Given Name	Category	
167	Female	Baller	Sabrina	Kata Leistungsklasse weiblich	
168	Female	Baller	Sabrina	Kumite Leistungsklasse -61 kg weiblich	

Entries: 2

Bayerische Meisterschaft Schüler - LK 2023

GERMANY

2023.02.11 - 2023.02.11

Jahnstraße 6, 84508 Burgkirchen an der Alz

Tournament Participation (Entries) by Club

 Karate Verein Herzogenaurach(KVH)					
ID	Sex	Family Name	Given Name	Category	
169	Female	Hertwich	Mona	Kumite Leistungsklasse -61 kg weiblich	
170	Female	Hertwich	Mona	Kata Leistungsklasse weiblich	
171	Male	Perthold	Severin	Kumite Schüler A +49kg männlich	
172	Male	Sfar	Fedi	Kata Schüler B Einzel m R3 Bronze Medal Match 2	
173	Male	Sfar	Fedi	Kata Schüler B Einzel m R2-G1	
174	Male	Sfar	Fedi	Kata Schüler B Einzel m	
175	Male	Swiac	Adam	Kata Schüler A m	
176	Male	Swiac	Adam	Kata Schüler A m R2-G2	
177	Male	Swiac	Adam	Kumite Schüler A -44kg männlich	
178	Male	Swiac	Adam	Kata Schüler A m R3 Gold Medal Match	

Entries: **10**

Bayerische Meisterschaft Schüler - LK 2023

GERMANY

2023.02.11 - 2023.02.11

Jahnstraße 6, 84508 Burgkirchen an der Alz

Tournament Participation (Entries) by Club

 Karate-Dojo München I e.V.(KDM1)					
ID	Sex	Family Name	Given Name	Category	
179	Male	Bahret	Jakob	Kumite Leistungsklasse -75 kg männlich	
180	Female	Knezevic	Andrea	Kata Leistungsklasse weiblich	
181	Male	Patitz	Lars	Kumite Leistungsklasse -75 kg männlich	

Entries: 3

Bayerische Meisterschaft Schüler - LK 2023

GERMANY

2023.02.11 - 2023.02.11

Jahnstraße 6, 84508 Burgkirchen an der Alz

Tournament Participation (Entries) by Club

KD Oki Bayern(KD Oki BAYERN)					
ID	Sex	Family Name	Given Name	Category	
182	Female	Mahovkic	Ajna	Kumite Schüler B -30kg weiblich	

Entries: 1

Bayerische Meisterschaft Schüler - LK 2023

GERMANY

2023.02.11 - 2023.02.11

Jahnstraße 6, 84508 Burgkirchen an der Alz

Tournament Participation (Entries) by Club

 KD Straubing(KD Straubing)					
ID	Sex	Family Name	Given Name	Category	
183	Male	Cimolino	Florian	Kumite Leistungsklasse -84 kg männlich	
184	Male	Cimolino	Florian	Kumite Team Herren	
185	Male	Delija	Artur	Kumite Team Herren	
186	Male	Delija	Artur	Kumite Leistungsklasse -75 kg männlich	
187	Male	Heyne	Jakob	Kumite Schüler B -38kg männlich	
188	Male	Kolbinger	Maximilian	Kumite Team Herren	
189	Male	Leistenschneider	Heinrich	Kumite Team Herren	
190	Male	Obermeier	Pascal	Kumite Leistungsklasse -84 kg männlich	
191	Male	Obermeier	Pascal	Kumite Team Herren	
192	Female	Reiswich	Leana	Kumite Schüler B -30kg weiblich	
193	Female	Reiswich	Leana	Kata Team Schüler A+B weiblich	
194	Female	Reiswich	Leana	Kata Schüler B Einzel w	
195	Female	Reiswich	Leana	Kata Schüler B Einzel w R3 Bronze Medal Match 2	
196	Female	Reiswich	Leana	Kata Schüler B Einzel w R2-G1	
197	Female	Schütz	Johanna	Kumite Schüler A -38kg weiblich	
198	Female	Schütz	Johanna	Kata Schüler A w R2-G2	
199	Female	Schütz	Johanna	Kata Team Schüler A+B weiblich	
200	Female	Schütz	Johanna	Kata Schüler A w	
201	Female	Schütz	Johanna	Kata Schüler A w R3 Bronze Medal Match 2	
202	Female	Seidel	Fabienne	Kata Schüler B Einzel w	
203	Female	Seidel	Fabienne	Kata Schüler B Einzel w R3 Gold Medal Match	
204	Female	Seidel	Fabienne	Kata Schüler B Einzel w R2-G2	
205	Female	Seidel	Fabienne	Kumite Schüler B -36kg weiblich	
206	Female	Seidel	Fabienne	Kata Team Schüler A+B weiblich	
207	Male	Wittmer	Leo	Kata Schüler A m R3 Gold Medal Match	
208	Male	Wittmer	Leo	Kata Schüler A m	
209	Male	Wittmer	Leo	Kata Schüler A m R2-G1	
210	Male	Wittmer	Leo	Kumite Schüler A -44kg männlich	

Entries: **28**

Bayerische Meisterschaft Schüler - LK 2023

GERMANY

2023.02.11 - 2023.02.11

Jahnstraße 6, 84508 Burgkirchen an der Alz

Tournament Participation (Entries) by Club

 MTSV Schwabing e.V.(MTSV Schwabing)					
ID	Sex	Family Name	Given Name	Category	
211	Female	Vollmar	Alina	Kata Leistungsklasse weiblich	

Entries: 1

Bayerische Meisterschaft Schüler - LK 2023

GERMANY

2023.02.11 - 2023.02.11

Jahnstraße 6, 84508 Burgkirchen an der Alz

Tournament Participation (Entries) by Club

 Okinawa Karate TSV Feichten(Okinawa Karate Feichten)					
ID	Sex	Family Name	Given Name	Category	
212	Male	Kaiser	Matthias	Kata Team Schüler A+B männlich	
213	Male	Kaiser	Matthias	Kata Team Schüler A+B männlich R2 Gold Medal Match	
214	Male	Kaiser	Matthias	Kata Schüler A m	
215	Male	Steiner	Noah	Kata Schüler B Einzel m R2-G2	
216	Male	Steiner	Noah	Kata Schüler B Einzel m R3 Bronze Medal Match 1	
217	Male	Steiner	Noah	Kata Team Schüler A+B männlich R2 Gold Medal Match	
218	Male	Steiner	Noah	Kata Schüler B Einzel m	
219	Male	Steiner	Noah	Kata Team Schüler A+B männlich	
220	Male	Zwirgmaier	Simon	Kata Schüler B Einzel m	
221	Male	Zwirgmaier	Simon	Kata Team Schüler A+B männlich	
222	Male	Zwirgmaier	Simon	Kata Schüler B Einzel m R2-G1	
223	Male	Zwirgmaier	Simon	Kata Schüler B Einzel m R3 Gold Medal Match	
224	Male	Zwirgmaier	Simon	Kata Team Schüler A+B männlich R2 Gold Medal Match	

Entries: **13**

Bayerische Meisterschaft Schüler - LK 2023

GERMANY

2023.02.11 - 2023.02.11

Jahnstraße 6, 84508 Burgkirchen an der Alz

Tournament Participation (Entries) by Club

 Okinawa Karate Tus Alztal Garching(TuS Alztal)					
ID	Sex	Family Name	Given Name	Category	
225	Male	Cornacchia	Edoardo	Kata Schüler A m R3 Bronze Medal Match 2	
226	Male	Cornacchia	Edoardo	Kata Schüler A m	
227	Male	Cornacchia	Edoardo	Kata Schüler A m R2-G1	
228	Male	Gassner	Thomas	Kata Schüler A m	
229	Male	Gassner	Thomas	Kata Schüler A m R2-G1	
230	Male	Gassner	Thomas	Kata Schüler A m R3 Bronze Medal Match 1	
231	Female	Husicic	Amina	Kata Schüler A w	
232	Female	Iova	Andrada	Kata Schüler A w	
233	Male	Pfeiffer	Thomas	Kata Leistungsklasse männlich	
234	Female	Siebert	Rita	Kata Leistungsklasse weiblich	

Entries: **10**

Bayerische Meisterschaft Schüler - LK 2023

GERMANY

2023.02.11 - 2023.02.11

Jahnstraße 6, 84508 Burgkirchen an der Alz

Tournament Participation (Entries) by Club

 Polizei-SV Augsburg e.V.(PSV-Augsburg)					
ID	Sex	Family Name	Given Name	Category	
235	Female	Friedl	Theresa	Kumite Schüler B -36kg weiblich	
236	Male	Ivanov	Presiyan	Kumite Schüler A -38kg männlich	
237	Male	Kern	Anton	Kumite Schüler A -38kg männlich	
238	Male	Mittelstedt	Moritz	Kumite Leistungsklasse -75 kg männlich	
239	Male	Suka	Lirant	Kumite Leistungsklasse -84 kg männlich	

Entries: 5

Bayerische Meisterschaft Schüler - LK 2023

GERMANY

2023.02.11 - 2023.02.11

Jahnstraße 6, 84508 Burgkirchen an der Alz

Tournament Participation (Entries) by Club

 Post SV Bamberg(Post SV Bamberg)					
ID	Sex	Family Name	Given Name	Category	
240	Female	Nelson	Aleena	Kumite Leistungsklasse -55 kg weiblich	
241	Female	Nelson	Aleena	Kumite Team Damen	
242	Female	Rusticeanu	Monica	Kumite Leistungsklasse -50 kg weiblich	
243	Female	Rusticeanu	Monica	Kata Leistungsklasse weiblich	
244	Female	Rusticeanu	Monica	Kumite Team Damen	
245	Female	Trenz	Bianca	Kumite Team Damen	

Entries: 6

Bayerische Meisterschaft Schüler - LK 2023

GERMANY

2023.02.11 - 2023.02.11

Jahnstraße 6, 84508 Burgkirchen an der Alz

Tournament Participation (Entries) by Club

 SG Moosburg e.V. Abteilung Karate(SG Moosburg Karate)					
ID	Sex	Family Name	Given Name	Category	
246	Female	Klupsch	Emilia	Kata Schüler A w R3 Bronze Medal Match 1	
247	Female	Klupsch	Emilia	Kata Schüler A w R2-G2	
248	Female	Klupsch	Emilia	Kata Schüler A w	

Entries: 3

Bayerische Meisterschaft Schüler - LK 2023

GERMANY

2023.02.11 - 2023.02.11

Jahnstraße 6, 84508 Burgkirchen an der Alz

Tournament Participation (Entries) by Club

 Shotokan Karate Breitenberg(Breitenberg)					
ID	Sex	Family Name	Given Name	Category	
249	Male	Andorfer	Sebastian	Kumite Schüler B -38kg männlich	
250	Male	Andorfer	Sebastian	Kumite Team Schüler männlich	
251	Male	Bogner	Leander	Kumite Team Schüler männlich	
252	Male	Bogner	Leander	Kumite Schüler A -38kg männlich	
253	Male	Drexler	Paul	Kumite Schüler B +38kg männlich	
254	Male	Drexler	Paul	Kumite Team Schüler männlich	
255	Female	Kandlbinder	Milena	Kumite Leistungsklasse -68 kg weiblich	
256	Male	Kandlbinder	Tobias	Kumite Leistungsklasse -75 kg männlich	
257	Female	Schopper	Victoria	Kumite Schüler A +49kg weiblich	
258	Male	Weidinger	Josef	Kumite Team Schüler männlich	
259	Male	Weidinger	Josef	Kumite Schüler A -49kg männlich	

Entries: 11

Bayerische Meisterschaft Schüler - LK 2023

GERMANY

2023.02.11 - 2023.02.11

Jahnstraße 6, 84508 Burgkirchen an der Alz

Tournament Participation (Entries) by Club

 SRS Karate Burgkirchen(SVGB)					
ID	Sex	Family Name	Given Name	Category	
260	Female	Bergmann	Liya	KUMITE TEAM Schüler weiblich	
261	Female	Berisha	Suela	KUMITE TEAM Schüler weiblich	
262	Female	Berisha	Suela	Kumite Schüler B +36kg weiblich	
263	Male	Fuhrmann	Maximilian	Kata Schüler B Einzel m	
264	Male	Henning	Eduard	Kumite Schüler B +38kg männlich	
265	Female	Karacali	Sara	Kumite Schüler B +36kg weiblich	
266	Female	Karacali	Sara	KUMITE TEAM Schüler weiblich	

Entries: 7

Bayerische Meisterschaft Schüler - LK 2023

GERMANY

2023.02.11 - 2023.02.11

Jahnstraße 6, 84508 Burgkirchen an der Alz

Tournament Participation (Entries) by Club

 SV Steinheim e.V.(SV Steinheim e.V.)					
ID	Sex	Family Name	Given Name	Category	
267	Male	Bohn	Liam	Kumite Schüler B +38kg männlich	
268	Male	Bohn	Liam	Kata Team Schüler A+B männlich	
269	Male	Bohn	Liam	Kumite Team Schüler männlich	
270	Male	George	Noel	Kumite Team Schüler männlich	
271	Male	George	Noel	Kumite Schüler B +38kg männlich	
272	Male	George	Noel	Kata Team Schüler A+B männlich	
273	Male	Honold	Tobias	Kumite Schüler B +38kg männlich	
274	Male	Honold	Tobias	Kata Team Schüler A+B männlich	
275	Male	Honold	Tobias	Kumite Team Schüler männlich	
276	Male	Sarraf	Elija Emanuel	Kata Schüler B Einzel m	
277	Male	Sarraf	Elija Emanuel	Kata Team Schüler A+B männlich	
278	Male	Sarraf	Elija Emanuel	Kumite Team Schüler männlich	
279	Male	Sarraf	Elija Emanuel	Kata Schüler B Einzel m R3 Bronze Medal Match 2	
280	Male	Sarraf	Elija Emanuel	Kata Schüler B Einzel m R2-G2	
281	Male	Sarraf	Elija Emanuel	Kumite Schüler B -32kg männlich	

Entries: **15**

Bayerische Meisterschaft Schüler - LK 2023

GERMANY

2023.02.11 - 2023.02.11

Jahnstraße 6, 84508 Burgkirchen an der Alz

Tournament Participation (Entries) by Club

 SV UNSU Karate Mömlingen e.V.(UNSU Team)					
ID	Sex	Family Name	Given Name	Category	
282	Female	Akinci	Nisa Nas	Kata Schüler B Einzel w R2-G1	
283	Female	Akinci	Nisa Nas	Kata Schüler B Einzel w R3 Bronze Medal Match 1	
284	Female	Akinci	Nisa Nas	Kumite Schüler B +36kg weiblich	
285	Female	Akinci	Nisa Nas	Kata Schüler B Einzel w	
286	Female	Braun	Anna	Kata Leistungsklasse weiblich R2-G1	
287	Female	Braun	Anna	Kata Leistungsklasse weiblich R3 Bronze Medal Match 2	
288	Female	Braun	Anna	Kata Leistungsklasse weiblich	
289	Female	Durdevic	Jasna	Kata Leistungsklasse weiblich	
290	Male	Grimm	Lukas	Kata Leistungsklasse männlich	
291	Female	Islam	Nabila	Kumite Leistungsklasse -55 kg weiblich	
292	Male	Islam	Ridwan	Kumite Leistungsklasse -67 kg männlich	
293	Male	Islam	Ridwan	Kumite Team Herren	
294	Male	Islam	Sajjad	Kumite Leistungsklasse -67 kg männlich	
295	Male	Islam	Sajjad	Kata Leistungsklasse männlich	
296	Male	Islam	Sajjad	Kumite Team Herren	
297	Male	Pattanasakoo	Nawapon	Kata Leistungsklasse männlich R2-G2	
298	Male	Pattanasakoo	Nawapon	Kata Leistungsklasse männlich R3 Bronze Medal Match 2	
299	Male	Pattanasakoo	Nawapon	Kata Leistungsklasse männlich	
300	Female	Stößel	Anna	Kata Leistungsklasse weiblich R3 Gold Medal Match	
301	Female	Stößel	Anna	Kata Leistungsklasse weiblich R2-G2	
302	Female	Stößel	Anna	Kata Leistungsklasse weiblich	
303	Male	Thierolf	Julian	Kumite Leistungsklasse -75 kg männlich	
304	Male	Thierolf	Julian	Kata Leistungsklasse männlich R2-G1	
305	Male	Thierolf	Julian	Kata Leistungsklasse männlich	
306	Male	Thierolf	Julian	Kata Leistungsklasse männlich R3 Bronze Medal Match 1	
307	Male	Thierolf	Julian	Kumite Team Herren	
308	Female	Werner	Claudia	Kata Leistungsklasse weiblich	
309	Female	Werner	Claudia	Kata Leistungsklasse weiblich R2-G2	
310	Female	Werner	Claudia	Kata Leistungsklasse weiblich R3 Bronze Medal Match 2	
311	Male	Wolf	Marcus	Kata Leistungsklasse männlich	

Entries: 30

Bayerische Meisterschaft Schüler - LK 2023

GERMANY

2023.02.11 - 2023.02.11

Jahnstraße 6, 84508 Burgkirchen an der Alz

Tournament Participation (Entries) by Club

 TG Schweinfurt 1848 e.V.(TG SW)					
ID	Sex	Family Name	Given Name	Category	
312	Female	Bärwald	Fiona-Isabel	Kumite Schüler A -38kg weiblich	
313	Male	Eckerdt	Daniel	Kumite Schüler B -38kg männlich	
314	Male	Horvath	Sebastian	Kata Leistungsklasse männlich R2-G1	
315	Male	Horvath	Sebastian	Kata Leistungsklasse männlich R3 Bronze Medal Match 2	
316	Male	Horvath	Sebastian	Kata Leistungsklasse männlich	
317	Female	Rostiahai	Hanna	Kumite Leistungsklasse -68 kg weiblich	

Entries: 6

Bayerische Meisterschaft Schüler - LK 2023

GERMANY

2023.02.11 - 2023.02.11

Jahnstraße 6, 84508 Burgkirchen an der Alz

Tournament Participation (Entries) by Club

 Traditionelle Karate Schule München e.V.(TKS München)					
ID	Sex	Family Name	Given Name	Category	
318	Male	Amin	Wenk	Kata Schüler A m	
319	Male	Amin	Wenk	Kumite Schüler A -38kg männlich	
320	Male	Cordes	Leonel	Kata Schüler A m	
321	Male	Cordes	Leonel	Kumite Schüler A +49kg männlich	

Entries: 4

Bayerische Meisterschaft Schüler - LK 2023

GERMANY

2023.02.11 - 2023.02.11

Jahnstraße 6, 84508 Burgkirchen an der Alz

Tournament Participation (Entries) by Club

 TSV 1888 Waging am See e.V.(TSV Waging)					
ID	Sex	Family Name	Given Name	Category	
322	Male	Boukrouh	Ahmed	Kata Team Schüler A+B männlich	
323	Male	Boukrouh	Ahmed	Kumite Team Schüler männlich	
324	Male	Oppacher	Simon	Kata Schüler B Einzel m	
325	Male	Oppacher	Simon	Kata Team Schüler A+B männlich	
326	Male	Oppacher	Simon	Kumite Team Schüler männlich	
327	Male	Traunspurger	Jakob	Kumite Team Schüler männlich	
328	Male	Traunspurger	Jakob	Kata Schüler B Einzel m	
329	Male	Traunspurger	Jakob	Kata Team Schüler A+B männlich	
330	Male	Wimmer	Ben	Kata Schüler B Einzel m	

Entries: **9**

Bayerische Meisterschaft Schüler - LK 2023

GERMANY

2023.02.11 - 2023.02.11

Jahnstraße 6, 84508 Burgkirchen an der Alz

Tournament Participation (Entries) by Club

 TSV Erding(TSV Erding)					
ID	Sex	Family Name	Given Name	Category	
331	Male	Al Hamad	Mehvan	Kata Schüler A m	
332	Male	Al Hamad	Mehvan	Kata Schüler A m R2-G1	
333	Female	Bobbert	Isabella	Kata Leistungsklasse weiblich R2-G2	
334	Female	Bobbert	Isabella	Kata Leistungsklasse weiblich	
335	Female	Bobbert	Isabella	Kata Leistungsklasse weiblich R3 Bronze Medal Match 1	
336	Female	Leopold	Hannah	Kata Schüler B Einzel w	
337	Female	Lingner	Sandra	Kata Leistungsklasse weiblich	
338	Female	Locoge	Maele	Kata Leistungsklasse weiblich	
339	Female	Locoge	Maele	Kata Leistungsklasse weiblich R3 Bronze Medal Match 1	
340	Female	Locoge	Maele	Kata Leistungsklasse weiblich R2-G1	

Entries: **10**

Bayerische Meisterschaft Schüler - LK 2023

GERMANY

2023.02.11 - 2023.02.11

Jahnstraße 6, 84508 Burgkirchen an der Alz

Tournament Participation (Entries) by Club

 TSV Grabenstätt / Chiemsee e. V.(TSV Grabenstätt)					
ID	Sex	Family Name	Given Name	Category	
341	Male	Boukrouh	Ahmed	Kumite Schüler A +49kg männlich	
342	Female	Lampersberger	Emilia	Kumite Schüler A -38kg weiblich	
343	Female	Lampersberger	Emilia	Kata Schüler A w R2-G1	
344	Female	Lampersberger	Emilia	Kata Schüler A w	
345	Female	Lampersberger	Emilia	Kata Schüler A w R3 Bronze Medal Match 2	

Entries: 5

Bayerische Meisterschaft Schüler - LK 2023

GERMANY

2023.02.11 - 2023.02.11

Jahnstraße 6, 84508 Burgkirchen an der Alz

Tournament Participation (Entries) by Club

 TSV Grasbrunn-Neukeferloh(Neukeferloh)					
ID	Sex	Family Name	Given Name	Category	
346	Male	Douchet	Maxim	Kata Schüler A m	
347	Male	Douchet	Maxim	Kumite Schüler A -38kg männlich	
348	Male	Probst	Arthur	Kata Schüler B Einzel m	
349	Male	Probst	Arthur	Kata Schüler B Einzel m R2-G1	
350	Male	Schnaus	Dominik	Kata Leistungsklasse männlich	
351	Male	Schnaus	Dominik	Kata Leistungsklasse männlich R3 Bronze Medal Match 1	
352	Male	Schnaus	Dominik	Kata Leistungsklasse männlich R2-G2	
353	Male	Shamsi	Daniel	Kumite Leistungsklasse -84 kg männlich	
354	Male	Shamsi	Daniel	Kata Leistungsklasse männlich R2-G1	
355	Male	Shamsi	Daniel	Kata Leistungsklasse männlich	

Entries: **10**

Bayerische Meisterschaft Schüler - LK 2023

GERMANY

2023.02.11 - 2023.02.11

Jahnstraße 6, 84508 Burgkirchen an der Alz

Tournament Participation (Entries) by Club

 TSV Jahn 1892 Würzburg e.V.(TSV Jahn 1892 Würzburg e.V.)					
ID	Sex	Family Name	Given Name	Category	
356	Female	Riemensperger	Isabel	Kata Schüler A w R2-G1	
357	Female	Riemensperger	Isabel	Kata Schüler A w	

Entries: 2

Bayerische Meisterschaft Schüler - LK 2023

GERMANY

2023.02.11 - 2023.02.11

Jahnstraße 6, 84508 Burgkirchen an der Alz

Tournament Participation (Entries) by Club

 TSV Milbertshofen-München(TSV Milbertshofen)					
ID	Sex	Family Name	Given Name	Category	
358	Female	Asam	Elina	Kumite Schüler B -36kg weiblich	
359	Female	Ibrahimi	Selma	Kumite Schüler A -44kg weiblich	
360	Male	Karayel	Eren Yüksel	Kumite Schüler B +38kg männlich	
361	Female	Martli	Eysan	Kumite Schüler B +36kg weiblich	
362	Male	Topic	Ryan	Kumite Schüler B -32kg männlich	

Entries: 5

Bayerische Meisterschaft Schüler - LK 2023

GERMANY

2023.02.11 - 2023.02.11

Jahnstraße 6, 84508 Burgkirchen an der Alz

Tournament Participation (Entries) by Club

 TSV Monheim e.V.(TSVM)					
ID	Sex	Family Name	Given Name	Category	
363	Female	Bergmann	Liya	Kumite Schüler A +49kg weiblich	
364	Female	Brandner	Sarah	Kata Leistungsklasse weiblich R2-G1	
365	Female	Brandner	Sarah	Kata Leistungsklasse weiblich	
366	Male	Brandner	Tim	Kumite Leistungsklasse -67 kg männlich	
367	Male	Brandner	Tim	Kumite Team Herren	
368	Female	Cuervo Acebedo	Vega	Kata Schüler B Einzel w	
369	Male	Grünfeld	Philipp	Kumite Team Herren	
370	Male	Hurler	Elijah	Kumite Team Schüler männlich	
371	Male	Hurler	Elijah	Kata Schüler B Einzel m R2-G2	
372	Male	Hurler	Elijah	Kata Schüler B Einzel m R3 Gold Medal Match	
373	Male	Hurler	Elijah	Kumite Schüler B -32kg männlich	
374	Male	Hurler	Elijah	Kata Schüler B Einzel m	
375	Male	Kamerl	Florian	Kumite Team Herren	
376	Male	Meyer	Lui	Kumite Team Schüler männlich	
377	Male	Meyer	Lui	Kumite Schüler A -38kg männlich	
378	Male	Meyer	Lui	Kata Schüler A m	
379	Female	Müller	Sarah	Kata Schüler A w R2-G2	
380	Female	Müller	Sarah	Kata Schüler A w	
381	Male	Naschwitz	Lenny	Kumite Schüler A -44kg männlich	
382	Male	Naschwitz	Lenny	Kumite Team Schüler männlich	
383	Male	Poisel	Ludwig	Kata Schüler A m R3 Bronze Medal Match 1	
384	Male	Poisel	Ludwig	Kata Schüler A m	
385	Male	Poisel	Ludwig	Kata Schüler A m R2-G2	
386	Male	Rossmann	Leon	Kumite Team Schüler männlich	
387	Male	Rossmann	Leon	Kumite Schüler A +49kg männlich	
388	Male	Strauch	Florian	Kumite Team Schüler männlich	
389	Male	Strauch	Florian	Kumite Schüler A +49kg männlich	

Entries: 27

Bayerische Meisterschaft Schüler - LK 2023

GERMANY

2023.02.11 - 2023.02.11

Jahnstraße 6, 84508 Burgkirchen an der Alz

Tournament Participation (Entries) by Club

🇩🇪 TSV Vilsbiburg 1883 e.V.(TSV Vilsbiburg 1883 e.V.)					
ID	Sex	Family Name	Given Name	Category	
390	Female	Zehentbauer	Tina	Kumite Leistungsklasse -61 kg weiblich	

Entries: 1

Bayerische Meisterschaft Schüler - LK 2023

GERMANY

2023.02.11 - 2023.02.11

Jahnstraße 6, 84508 Burgkirchen an der Alz

Tournament Participation (Entries) by Club

 TSV-Trostberg(Abteilung Karate)					
ID	Sex	Family Name	Given Name	Category	
391	Female	Quint	Alisa	Kata Schüler A w	
392	Female	Steiglechner	Johanna	Kumite Leistungsklasse +68 kg weiblich	

Entries: 2

Bayerische Meisterschaft Schüler - LK 2023

GERMANY

2023.02.11 - 2023.02.11

Jahnstraße 6, 84508 Burgkirchen an der Alz

Tournament Participation (Entries) by Club

 TuS Feuchtwangen(Tus Feuchtwangen)					
ID	Sex	Family Name	Given Name	Category	
393	Female	Mohr	Loreen	Kata Schüler B Einzel w	
394	Female	Mohr	Loreen	Kata Schüler B Einzel w R2-G2	
395	Female	Mohr	Loreen	Kata Schüler B Einzel w R3 Bronze Medal Match 2	
396	Female	Tromsa	Sandra	Kata Schüler B Einzel w	
397	Female	Tromsa	Sandra	Kata Schüler B Einzel w R2-G1	

Entries: 5

Bayerische Meisterschaft Schüler - LK 2023

GERMANY

2023.02.11 - 2023.02.11

Jahnstraße 6, 84508 Burgkirchen an der Alz

Tournament Participation (Entries) by Club

 TuS Fürstenfeldbruck(TuS FFB)					
ID	Sex	Family Name	Given Name	Category	
398	Male	Glötz	Vinzent	Kumite Schüler A -38kg männlich	
399	Male	Mahr	Paul	Kumite Schüler A -38kg männlich	

Entries: 2

Bayerische Meisterschaft Schüler - LK 2023

GERMANY

2023.02.11 - 2023.02.11

Jahnstraße 6, 84508 Burgkirchen an der Alz

Tournament Participation (Entries) by Club

 TV 1911 Vohburg(TVVoh)					
ID	Sex	Family Name	Given Name	Category	
400	Male	Baranyai	Vince Bela	Kumite Schüler B -32kg männlich	
401	Male	Grünfeld	Philipp	Kumite Leistungsklasse -75 kg männlich	
402	Male	Hami	Muhammed	Kumite Leistungsklasse -60 kg männlich	
403	Female	Hans	Natalie	Kumite Team Damen	
404	Female	Hans	Natalie	Kumite Leistungsklasse +68 kg weiblich	
405	Male	Kamerl	Florian	Kumite Leistungsklasse -67 kg männlich	
406	Female	Knupfer	Lale	Kumite Team Damen	
407	Female	Knupfer	Lale	Kumite Leistungsklasse -55 kg weiblich	
408	Male	Kürzinger	Timo	Kumite Schüler A -38kg männlich	
409	Female	Mick	Lena	Kumite Leistungsklasse -68 kg weiblich	
410	Female	Mick	Lena	Kumite Team Damen	
411	Female	Yildirim	Meyrem	Kumite Team Damen	

Entries: 12

Bayerische Meisterschaft Schüler - LK 2023

GERMANY

2023.02.11 - 2023.02.11

Jahnstraße 6, 84508 Burgkirchen an der Alz

Tournament Participation (Entries) by Club

 TV Fürth 1860 e.V.(TV Fürth)					
ID	Sex	Family Name	Given Name	Category	
412	Male	Engelhardt	Alessandro	Kumite Leistungsklasse -67 kg männlich	
413	Male	Engelhardt	Alessandro	Kumite Team Herren	
414	Male	Jira	Michael	Kumite Schüler A -44kg männlich	
415	Female	Meyer	Sinah	Kumite Schüler B -30kg weiblich	
416	Male	Mittelstedt	Moritz	Kumite Team Herren	
417	Male	Nguyen	Andreas	Kumite Schüler B -32kg männlich	
418	Male	Smokvin	Aleksandr	Kumite Team Herren	
419	Male	Suka	Lirant	Kumite Team Herren	
420	Male	Weitmann	Lukas	Kumite Team Herren	

Entries: **9**

Bayerische Meisterschaft Schüler - LK 2023

GERMANY

2023.02.11 - 2023.02.11

Jahnstraße 6, 84508 Burgkirchen an der Alz

Tournament Participation (Entries) by Club

 TV Trennfurt(TVT)					
ID	Sex	Family Name	Given Name	Category	
421	Male	Osijuk	Oleg	Kumite Leistungsklasse -67 kg männlich	

Entries: 1

Bayerische Meisterschaft Schüler - LK 2023

GERMANY

2023.02.11 - 2023.02.11

Jahnstraße 6, 84508 Burgkirchen an der Alz

Tournament Participation (Entries) by Club

 TV48 Erlangen Karate(TV48 Erlangen)					
ID	Sex	Family Name	Given Name	Category	
422	Male	Trollmann	Marius	Kumite Leistungsklasse +84 kg männlich	
423	Male	Trollmann	Marius	Kata Leistungsklasse männlich	

Entries: 2

Bayerische Meisterschaft Schüler - LK 2023

GERMANY

2023.02.11 - 2023.02.11

Jahnstraße 6, 84508 Burgkirchen an der Alz

Tournament Participation (Entries) by Club

Total Entries:**423**

Bayerische Meisterschaft Schüler - LK 2023

GERMANY
Jahnstraße 6, 84508 Burgkirchen an der Alz

2023.02.11 - 2023.02.11

Statistics

Participating Countries: 1

Participating Regions: 1

Participating Team/Clubs: 47

	Competitors	Entries
Female	99	118
Male	117	144
Total	216	262

Entries per Category

	Entries	Teams
KUMITE TEAM Schüler weiblich	-	5
Kata Leistungsklasse männlich	14	-
Kata Leistungsklasse weiblich	22	-
Kata Schüler A m	19	-
Kata Schüler A w	15	-
Kata Schüler B Einzel m	14	-
Kata Schüler B Einzel w	12	-
Kata Team Schüler A+B männlich	-	4
Kata Team Schüler A+B weiblich	-	3
Kumite Leistungsklasse +68 kg weiblich	5	-
Kumite Leistungsklasse +84 kg männlich	5	-
Kumite Leistungsklasse -50 kg weiblich	2	-
Kumite Leistungsklasse -55 kg weiblich	3	-
Kumite Leistungsklasse -60 kg männlich	2	-
Kumite Leistungsklasse -61 kg weiblich	6	-
Kumite Leistungsklasse -67 kg männlich	9	-
Kumite Leistungsklasse -68 kg weiblich	5	-
Kumite Leistungsklasse -75 kg männlich	10	-
Kumite Leistungsklasse -84 kg männlich	8	-
Kumite Schüler A +49kg männlich	5	-
Kumite Schüler A +49kg weiblich	6	-
Kumite Schüler A -38kg männlich	12	-
Kumite Schüler A -38kg weiblich	3	-
Kumite Schüler A -44kg männlich	6	-
Kumite Schüler A -44kg weiblich	5	-
Kumite Schüler A -49kg männlich	2	-
Kumite Schüler B +36kg weiblich	10	-
Kumite Schüler B +38kg männlich	8	-
Kumite Schüler B -30kg weiblich	9	-
Kumite Schüler B -32kg männlich	7	-

Bayerische Meisterschaft Schüler - LK 2023

GERMANY

2023.02.11 - 2023.02.11

Jahnstraße 6, 84508 Burgkirchen an der Alz

Statistics

Kumite Schüler B -36kg weiblich	5	-
Kumite Schüler B -38kg männlich	6	-
Kumite Team Damen	-	2
Kumite Team Herren	-	6
Kumite Team Schüler männlich	-	7
Totals:	235	27

**Bayerische Meisterschaft
Schüler - LK 2023 - 2023-02-11
Kata Leistungsklasse männlich**

R1 G1/2 (6) Tatami 1 14:25(2023-02-11)

Teilnehmer	Kata	1	2	3	4	5	6	7	TOTAL	Extra	GesamRang
1 THIEROLF JULIAN (SV UNSU KARATE MÖMLINGEN E.V.)	020 GOJUSHIHO DAI	7.9	8.2	(7.3)	(8.3)	8.2			24.3		24.3 2
2 BERNER LAURENZ (KARATE DOJO DURACH-WEIDACH)	021 GOJUSHIHO SHO	8.3	8.4	(7.9)	(8.7)	8.5			25.2		25.2 1
3 WOLF MARCUS (SV UNSU KARATE MÖMLINGEN E.V.)	021 GOJUSHIHO SHO	(7.9)	(6.8)	6.9	7.3	7.4			21.6		21.6 5
4 HORVATH SEBASTIAN (TG SCHWEINFURT 1848 E.V.)	046 KOUSOUKUN SHO	(7.6)	7.5	7.3	7.5	(7.2)			22.3		22.3 4
5 SHAMSI DANIEL (TSV GRASBRUNN-NEUKEFERLOH)	041 KANKU SHO	(7.9)	7.7	7.2	7.7	(7.0)			22.6		22.6 3
6 ISLAM SAJJAD (SV UNSU KARATE MÖMLINGEN E.V.)											

R1 G2/2 (6) Tatami 1 15:00(2023-02-11)

Teilnehmer	Kata	1	2	3	4	5	6	7	TOTAL	Extra	GesamRang
1 STELZL ALEXANDER (ASIA SPORTS KARATESCHULE)	041 KANKU SHO										
2 PETROVIC MARKO (ESV MÜNCHEN KARATE)	006 BASSAI DAI	(6.7)	(7.2)	7.1	6.9	7.0			21.0		21.0 4
3 TROLLMANN MARIUS (TV48 ERLANGEN KARATE)	006 BASSAI DAI	(6.4)	(6.9)	6.9	6.7	6.6			20.2		20.2 5
4 PATTANASAKOO NAWAPON (SV UNSU KARATE MÖMLINGEN E.V.)	041 KANKU SHO	8.3	(7.7)	(8.4)	8.0	8.4			24.7		24.7 2
5 MATHES MIKA (KARATE DOJO DURACH-WEIDACH)	021 GOJUSHIHO SHO	8.5	8.0	8.2	(7.9)	(8.6)			24.7		24.7 1
6 SCHNAUS DOMINIK (TSV GRASBRUNN-NEUKEFERLOH)	021 GOJUSHIHO SHO	(8.0)	7.8	7.9	(7.7)	7.8			23.5		23.5 3

R2-G1

Teilnehmer	Kata	1	2	3	4	5	6	7	TOTAL	Extra	GesamRang
1 THIEROLF JULIAN (SV UNSU KARATE MÖMLINGEN E.V.)	021 GOJUSHIHO SHO	7.8	(8.3)	8.0	(7.3)	8.3			24.1		24.1 2
2 SHAMSI DANIEL (TSV GRASBRUNN-NEUKEFERLOH)	012 ENPI	7.0	(7.8)	7.5	(6.8)	7.0			21.5		21.5 4
3 HORVATH SEBASTIAN (TG SCHWEINFURT 1848 E.V.)	061 NIPAPO	(6.8)	8.0	(8.2)	8.2	7.1			23.3		23.3 3
4 BERNER LAURENZ (KARATE DOJO DURACH-WEIDACH)	020 GOJUSHIHO DAI	(8.2)	8.5	8.5	8.2	(8.7)			25.2		25.2 1

R2-G2

Teilnehmer	Kata	1	2	3	4	5	6	7	TOTAL	Extra	GesamRang
1 PATTANASAKOO NAWAPON (SV UNSU KARATE MÖMLINGEN E.V.)	099 UNSU	(8.8)	(8.0)	8.4	8.4	8.3			25.1		25.1 2
2 MATHES MIKA (KARATE DOJO DURACH-WEIDACH)	099 UNSU	(9.0)	(7.6)	8.6	8.6	8.5			25.7		25.7 1
3 SCHNAUS DOMINIK (TSV GRASBRUNN-NEUKEFERLOH)	SANSAI	(7.2)	7.2	(8.2)	8.0	7.3			22.5		22.5 3
4 PETROVIC MARKO (ESV MÜNCHEN KARATE)	021 GOJUSHIHO SHO	7.0	(6.7)	(7.2)	7.0	6.8			20.8		20.8 4

R3 Bronze Medal Match 1

Teilnehmer	Kata	1	2	3	4	5	6	7	TOTAL	Extra	GesamRang
1 THIEROLF JULIAN (SV UNSU KARATE MÖMLINGEN E.V.)	099 UNSU	(8.4)	8.3	8.2	8.2	(8.1)	8.2	8.1	41.0		41.0 2
2 SCHNAUS DOMINIK (TSV GRASBRUNN-NEUKEFERLOH)	GANKAKU	8.2	(8.5)	8.4	8.4	(7.9)	8.4	8.3	41.7		41.7 1

R3 Bronze Medal Match 2









Teilnehmer	Kata	1	2	3	4	5	6	7	TOTAL	Extra	GesamRang
1 HORVATH SEBASTIAN (TG SCHWEINFURT 1848 E.V.)	092 SUPARINPEI	7.6	(7.3)	7.8	(7.9)	7.7	7.5	7.4	38.0		38.0 2
2 PATTANASAKOO NAWAPON (SV UNSU KARATE MÖMLINGEN E.V.)	015 GANKAKU	8.6	(8.3)	8.6	8.4	(8.7)	8.5	8.6	42.7		42.7 1

R3 Gold Medal Match

Teilnehmer	Kata	1	2	3	4	5	6	7	TOTAL	Extra	GesamRang
1 BERNER LAURENZ (KARATE DOJO DURACH-WEIDACH)	099 UNSU	(8.9)	8.7	8.5	8.5	(8.4)	8.5	8.8	43.0		43.0 1
2 MATHES MIKA (KARATE DOJO DURACH-WEIDACH)	020 GOJUSHIHO DAI	(9.1)	8.6	(8.3)	8.4	8.4	8.4	9.0	42.8		42.8 2

Results

**Bayerische Meisterschaft
Schüler - LK 2023 - 2023-02-11
Kata Leistungsklasse männlich**

1	BERNER LAURENZ	KARATE DOJO DURACH-WEIDACH		GERMANY
2	MATHES MIKA	KARATE DOJO DURACH-WEIDACH		GERMANY
3	SCHNAUS DOMINIK	TSV GRASBRUNN-NEUKEFERLOH		GERMANY
3	PATTANASAKOO NAWAPON	SV UNSU KARATE MÖMLINGEN E.V.		GERMANY
5	THIEROLF JULIAN	SV UNSU KARATE MÖMLINGEN E.V.		GERMANY
5	HORVATH SEBASTIAN	TG SCHWEINFURT 1848 E.V.		GERMANY
7	SHAMSI DANIEL	TSV GRASBRUNN-NEUKEFERLOH		GERMANY
7	PETROVIC MARKO	ESV MÜNCHEN KARATE		GERMANY

**Bayerische Meisterschaft
Schüler - LK 2023 - 2023-02-11
Kata Leistungsklasse weiblich**

R1 G1/2 (11) Tatami 2 16:15(2023-02-11)

Teilnehmer	Kata	1	2	3	4	5	6	7	TOTAL	ExtrGesamRang
1 HERTWICH MONA (KARATE VEREIN HERZOGENAURACH)	021 GOJUSHIHO SHO	7.3	(7.4)	7.3	(6.8)	7.0			21.6	21.6 6
2 PETERATZINGER STEFANIE (ASIA SPORTS KARATESCHULE)	002 ANAN DAI									
3 BALLER SABRINA (KARATE SV ALTENSTADT/WN)	091 SOCHIN	7.0	(7.2)	7.2	(6.4)	6.7			20.9	20.9 8
4 LOCOGE MAELLE (TSV ERDING)	092 SUPARINPEI	8.0	(8.2)	(7.6)	7.8	7.7			23.5	23.5 2
5 DURDEVIC JASNA (SV UNSU KARATE MÖMLINGEN E.V.)	041 KANKU SHO	6.4	(6.5)	6.5	(5.8)	6.2			19.1	19.1 9
6 VLAI JESSICA (ASIA SPORTS KARATESCHULE)	068 PAPUREN	8.4	(8.5)	(8.2)	8.5	8.2			25.1	25.1 1
7 BRAUN ANNA (SV UNSU KARATE MÖMLINGEN E.V.)	002 ANAN DAI	7.9	(8.2)	(7.1)	7.4	7.4			22.7	22.7 3
8 BRAND KERSTIN (ESV MÜNCHEN KARATE)	002 ANAN DAI	7.6	(7.9)	(7.0)	7.2	7.1			21.9	21.9 5
9 WIEDENMANN FRANZISKA (1. KARATE CLUB PASSAU)	012 ENPI	(6.2)	(5.6)	6.2	6.2	6.0			18.4	18.4 10
10 BRANDNER SARAH (TSV MONHEIM E.V.)	021 GOJUSHIHO SHO	(7.5)	7.4	(7.1)	7.5	7.5			22.4	22.4 4
11 RUSTICEANU MONICA (POST SV BAMBERG)	021 GOJUSHIHO SHO	(7.1)	7.1	7.0	(6.7)	6.9			21.0	21.0 7

R1 G2/2 (10) Tatami 3 15:45(2023-02-11)

Teilnehmer	Kata	1	2	3	4	5	6	7	TOTAL	ExtrGesamRang
1 ZINECKER MARIE (ASIA SPORTS KARATESCHULE)	068 PAPUREN	7.2	7.2	7.3	(7.6)	(7.0)			21.7	21.7 4
2 LINGNER SANDRA (TSV ERDING)	068 PAPUREN	(6.8)	(7.6)	7.1	7.2	7.3			21.6	21.6 5
3 KNEZEVIC ANDREA (KARATE-DOJO MÜNCHEN I E.V.)	021 GOJUSHIHO SHO	6.3	6.4	(6.5)	6.5	(6.1)			19.2	19.2 8
4 STÖSSEL ANNA (SV UNSU KARATE MÖMLINGEN E.V.)	068 PAPUREN	(7.4)	7.7	7.7	(7.9)	7.5			22.9	22.9 2
5 VOLLMAR ALINA (MTSV SCHWABING E.V.)	047 KURURUNFA	7.1	(7.4)	(6.9)	7.2	6.9			21.2	21.2 6
6 SCHMIDT ANIKA (ASIA SPORTS KARATESCHULE)	068 PAPUREN	(7.2)	6.8	7.2	7.2	(6.7)			21.2	21.2 7
7 BOBBERT ISABELLA (TSV ERDING)	008 CHATANYARA KUSHANKU	7.5	(8.0)	7.3	7.3	(7.1)			22.1	22.1 3
8 WIELAND SMILLA (1. KARATE CLUB PASSAU)	021 GOJUSHIHO SHO	6.3	(6.7)	6.2	(6.1)	6.1			18.6	18.6 10
9 WERNER CLAUDIA (SV UNSU KARATE MÖMLINGEN E.V.)	047 KURURUNFA	7.8	(7.5)	7.6	(8.0)	7.5			22.9	22.9 1
10 SCHRÖDER ALENA (ESV MÜNCHEN KARATE)	006 BASSAI DAI	(6.0)	6.5	6.4	6.2	(6.7)			19.1	19.1 9

R2-G1

Teilnehmer	Kata	1	2	3	4	5	6	7	TOTAL	ExtrGesamRang
1 BRANDNER SARAH (TSV MONHEIM E.V.)	099 UNSU	6.9	(7.6)	(6.8)	7.2	7.2			21.3	21.3 4
2 BRAUN ANNA (SV UNSU KARATE MÖMLINGEN E.V.)	068 PAPUREN	7.5	(7.7)	(7.3)	7.6	7.5			22.6	22.6 3
3 VLAI JESSICA (ASIA SPORTS KARATESCHULE)	002 ANAN DAI	(8.3)	(7.9)	8.0	8.0	8.3			24.3	24.3 1
4 LOCOGE MAELLE (TSV ERDING)	009 CHIBANA NO KUSHANKU	7.9	(8.0)	8.0	(7.7)	8.0			23.9	23.9 2

R2-G2

Teilnehmer	Kata	1	2	3	4	5	6	7	TOTAL	ExtrGesamRang
1 STÖSSEL ANNA (SV UNSU KARATE MÖMLINGEN E.V.)	009 CHIBANA NO KUSHANKU	7.7	7.9	(8.1)	(7.5)	8.0			23.6	23.6 1
2 WERNER CLAUDIA (SV UNSU KARATE MÖMLINGEN E.V.)	092 SUPARINPEI	7.9	7.7	(7.6)	(8.0)	7.6			23.2	23.2 2
3 BOBBERT ISABELLA (TSV ERDING)	068 PAPUREN	7.6	(7.8)	(7.2)	7.6	7.8			23.0	23.0 3
4 ZINECKER MARIE (ASIA SPORTS KARATESCHULE)	002 ANAN DAI	(7.5)	7.5	(7.0)	7.5	7.4			22.4	22.4 4

R3 Bronze Medal Match 1

Teilnehmer	Kata	1	2	3	4	5	6	7	TOTAL	ExtrGesamRang
1 BOBBERT ISABELLA (TSV ERDING)	092 SUPARINPEI	7.5	7.4	7.5	(8.0)	7.4	7.6	(7.3)	37.4	37.4 2
2 LOCOGE MAELLE (TSV ERDING)	068 PAPUREN	(7.6)	7.7	7.8	7.9	7.6	7.7	(8.0)	38.7	38.7 1

R3 Bronze Medal Match 2

Teilnehmer	Kata	1	2	3	4	5	6	7	TOTAL	ExtrGesamRang
1 WERNER CLAUDIA (SV UNSU KARATE MÖMLINGEN E.V.)	068 PAPUREN	(7.4)	(8.1)	8.0	8.1	7.7	7.8	7.8	39.4	39.4 2

**Bayerische Meisterschaft
Schüler - LK 2023 - 2023-02-11
Kata Leistungsklasse weiblich**

2	BRAUN ANNA (SV UNSU KARATE MÖMLINGEN E.V.)	064 OHAN DAI	7.7	(8.3)	7.9	8.2	7.9	7.7	(7.6)	39.4		39.4	1
---	--	--------------	-----	-------	-----	-----	-----	-----	-------	------	--	------	---

R3 Gold Medal Match

	Teilnehmer	Kata	1	2	3	4	5	6	7	TOTAL	Extr	GesamRang
1	STÖSSEL ANNA (SV UNSU KARATE MÖMLINGEN E.V.)	092 SUPARINPEI	8.2	8.2	8.2	(8.3)	8.0	(7.9)	8.2	40.8		40.8 2
2	VLAI JESSICA (ASIA SPORTS KARATESCHULE)	092 SUPARINPEI	8.1	8.5	8.4	8.4	8.4	(7.8)	(8.6)	41.8		41.8 1

Results

1	VLAI JESSICA	ASIA SPORTS KARATESCHULE		GERMANY
2	STÖSSEL ANNA	SV UNSU KARATE MÖMLINGEN E.V.		GERMANY
3	LOCOGE MAELLE	TSV ERDING		GERMANY
3	BRAUN ANNA	SV UNSU KARATE MÖMLINGEN E.V.		GERMANY
5	BOBBERT ISABELLA	TSV ERDING		GERMANY
5	WERNER CLAUDIA	SV UNSU KARATE MÖMLINGEN E.V.		GERMANY
7	BRANDNER SARAH	TSV MONHEIM E.V.		GERMANY
7	ZINECKER MARIE	ASIA SPORTS KARATESCHULE		GERMANY

**Bayerische Meisterschaft
Schüler - LK 2023 - 2023-02-11
Kata Schüler A m**

R1 G1/2 (10) Tatami 3 09:00(2023-02-11)

Teilnehmer	Kata	1	2	3	4	5	6	7	TOTAL	ExtrGesamRang
1 AMIN WENK (TRADITIONELLE KARATE SCHULE MÜNCHEN E.V.)	006 BASSAI DAI	(6.0)	6.0	(6.1)	6.0	6.0			18.0	18.0 9
2 SABANOVIC SAID (KARATE DOJO OKI BAYERN)	036 JION	(6.8)	6.6	6.6	6.5	(6.2)			19.7	19.7 5
3 STANG BRUNO (1. KARATE CLUB PASSAU)	029 HEIAN GODAN	(6.6)	6.4	(6.2)	6.6	6.4			19.4	19.4 6
4 FREUDLING TOBIAS (KARATE DOJO TV HALDENWANG E.V.)	027 HEIAN SANDAN	(5.9)	6.6	6.4	(6.8)	6.3			19.3	19.3 7
5 GASSNER THOMAS (OKINAWA KARATE TUS ALZTAL GARCHING)	013 FUKYGATA ICHI	(6.7)	(7.1)	6.7	7.0	6.8			20.5	20.5 3
6 WITTMER LEO (KD STRAUBING)	012 ENPI	(7.4)	7.4	(7.6)	7.6	7.6			22.6	22.6 1
7 CORNACCHIA EDOARDO (OKINAWA KARATE TUS ALZTAL GARCHING)	013 FUKYGATA ICHI	(7.0)	7.0	7.0	6.9	(6.5)			20.9	20.9 2
8 AL_HAMAD MEHVAN (TSV ERDING)	017 GEKISAI ICHI	6.6	6.7	(7.1)	6.6	(6.3)			19.9	19.9 4
9 MEYER LUI (TSV MONHEIM E.V.)										
10 DOUCHET MAXIM (TSV GRASBRUNN-NEUKEFERLOH)	012 ENPI	6.2	6.4	(5.6)	6.4	(6.6)			19.0	19.0 8

R1 G2/2 (9) Tatami 3 09:40(2023-02-11)

Teilnehmer	Kata	1	2	3	4	5	6	7	TOTAL	ExtrGesamRang
1 KAISER MATTHIAS (OKINAWA KARATE TSV FEICHTEN)	102 WANSHU	(5.9)	(6.2)	6.0	6.0	6.0			18.0	18.0 8
2 LIBIK DANIEL (ASIA SPORTS KARATESCHULE)	006 BASSAI DAI	(6.9)	7.2	7.3	(7.6)	7.5			22.0	22.0 1
3 MAIER ADRIAN (KARATE DOJO OKI BAYERN)	029 HEIAN GODAN	6.1	(5.9)	6.5	6.2	(6.7)			18.8	18.8 5
4 SWIAC ADAM (KARATE VEREIN HERZOGENAURACH)	021 GOJUSHIHO SHO	7.2	6.9	(6.4)	7.2	(7.5)			21.3	21.3 2
5 WÖRZ TIMO (KARATE DOJO TV HALDENWANG E.V.)	025 HEIAN SHODAN	(6.0)	6.5	(6.8)	6.7	6.0			19.2	19.2 4
6 FREUDLING LOUIS (KARATE DOJO TV HALDENWANG E.V.)	027 HEIAN SANDAN	5.9	(6.8)	6.4	6.5	(5.8)			18.8	18.8 6
7 SABANOVIC OMER (KARATE DOJO OKI BAYERN)	026 HEIAN NIDAN	6.1	6.1	(6.6)	6.1	(5.9)			18.3	18.3 7
8 POISEL LUDWIG (TSV MONHEIM E.V.)	029 HEIAN GODAN	(6.9)	6.4	6.9	(6.3)	6.4			19.7	19.7 3
9 CORDES LEONEL (TRADITIONELLE KARATE SCHULE MÜNCHEN E.V.)	006 BASSAI DAI	6.0	(6.4)	6.0	5.9	(5.5)			17.9	17.9 9

R2-G1

Teilnehmer	Kata	1	2	3	4	5	6	7	TOTAL	ExtrGesamRang
1 CORNACCHIA EDOARDO (OKINAWA KARATE TUS ALZTAL GARCHING)	102 WANSHU	(6.9)	(6.4)	6.4	6.6	6.4			19.4	19.4 3
2 AL_HAMAD MEHVAN (TSV ERDING)	070 PINAN SHODAN	6.5	6.5	(5.8)	(6.8)	6.0			19.0	19.0 4
3 WITTMER LEO (KD STRAUBING)	036 JION	7.3	(7.6)	7.6	(7.1)	7.4			22.3	22.3 1
4 GASSNER THOMAS (OKINAWA KARATE TUS ALZTAL GARCHING)	102 WANSHU	(6.8)	(6.9)	6.8	6.8	6.8			20.4	20.4 2

R2-G2

Teilnehmer	Kata	1	2	3	4	5	6	7	TOTAL	ExtrGesamRang
1 SWIAC ADAM (KARATE VEREIN HERZOGENAURACH)	041 KANKU SHO	(6.8)	7.0	(7.4)	7.4	7.3			21.7	21.7 1
2 LIBIK DANIEL (ASIA SPORTS KARATESCHULE)	021 GOJUSHIHO SHO	7.0	(6.8)	(7.6)	7.2	7.1			21.3	21.3 2
3 WÖRZ TIMO (KARATE DOJO TV HALDENWANG E.V.)	027 HEIAN SANDAN	6.3	(6.2)	(6.6)	6.6	6.5			19.4	19.4 3
4 POISEL LUDWIG (TSV MONHEIM E.V.)	036 JION	(5.7)	6.7	(6.9)	6.3	5.7			18.7	18.7 4

R3 Bronze Medal Match 1

Teilnehmer	Kata	1	2	3	4	5	6	7	TOTAL	ExtrGesamRang
1 GASSNER THOMAS (OKINAWA KARATE TUS ALZTAL GARCHING)	086 SEISAN	6.8	(6.4)	6.4	(6.9)	6.5	6.5	6.8	33.0	33.0 1
2 POISEL LUDWIG (TSV MONHEIM E.V.)	012 ENPI	6.2	6.5	(6.6)	6.4	(5.7)	5.8	6.5	31.4	31.4 2

R3 Bronze Medal Match 2

Teilnehmer	Kata	1	2	3	4	5	6	7	TOTAL	ExtrGesamRang
1 CORNACCHIA EDOARDO (OKINAWA KARATE TUS ALZTAL GARCHING)	086 SEISAN	6.2	(6.0)	6.5	6.8	(6.9)	6.9	6.3	32.7	32.7 2
2 LIBIK DANIEL (ASIA SPORTS KARATESCHULE)	020 GOJUSHIHO DAI	7.0	6.8	7.0	(6.7)	(7.2)	7.2	7.1	35.1	35.1 1







R3 Gold Medal Match

Teilnehmer	Kata	1	2	3	4	5	6	7	TOTAL	ExtrGesamRang
------------	------	---	---	---	---	---	---	---	-------	---------------

**Bayerische Meisterschaft
Schüler - LK 2023 - 2023-02-11
Kata Schüler A m**

1	WITTMER LEO (KD STRAUBING)	021 GOJUSHIHO SHO	7.2	7.4	7.2	(7.8)	7.3	7.1	(7.0)	36.2		36.2	2
2	SWIAC ADAM (KARATE VEREIN HERZOGENAURACH)	012 ENPI	7.4	(7.6)	(6.9)	7.6	6.9	7.3	7.5	36.7		36.7	1

Results

1	SWIAC ADAM	KARATE VEREIN HERZOGENAURACH		GERMANY
2	WITTMER LEO	KD STRAUBING		GERMANY
3	GASSNER THOMAS	OKINAWA KARATE TUS ALZTAL GARCHING		GERMANY
3	LIBIK DANIEL	ASIA SPORTS KARATESCHULE		GERMANY
5	POISEL LUDWIG	TSV MONHEIM E.V.		GERMANY
5	CORNACCHIA EDOARDO	OKINAWA KARATE TUS ALZTAL GARCHING		GERMANY
7	AL HAMAD MEHVAN	TSV ERDING		GERMANY

**Bayerische Meisterschaft
Schüler - LK 2023 - 2023-02-11
Kata Schüler A w**

R1 G1/2 (8) Tatami 3 11:20(2023-02-11)

Teilnehmer	Kata	1	2	3	4	5	6	7	TOTAL	ExtrGesamRang
1 BIEDEMANN GRETA (KARATE DOJO OKI BAYERN)	041 KANKU SHO	(7.5)	(6.2)	6.9	7.3	7.2			21.4	21.4 1
2 EHLING MAGDALENA (ASIA SPORTS KARATESCHULE)	002 ANAN DAI	7.1	(6.6)	6.7	7.0	(7.4)			20.8	20.8 3
3 IOVA ANDRADA (OKINAWA KARATE TUS ALZTAL GARCHING)	102 WANSHU	5.9	(6.4)	(5.8)	5.9	5.8			17.6	17.6 7
4 MERLENS THERESA (KARATE DOJO TV HALDENWANG E.V.)	025 HEIAN SHODAN	6.0	(6.3)	6.0	(5.9)	6.2			18.2	18.2 6
5 LAMPERSBERGER EMILIA (TSV GRABENSTÄTT / CHIEMSEE E. V.)	006 BASSAI DAI	6.9	(7.2)	6.8	6.6	(6.5)			20.3	20.3 4
6 RIEMENSBERGER ISABEL (TSV JAHN 1892 WÜRZBURG E.V.)	021 GOJUSHIHO SHO	7.0	(6.7)	6.9	(7.3)	7.3			21.2	21.2 2
7 QUINT ALISA (TSV-TROSTBERG)										
8 HUSICIC AMINA (OKINAWA KARATE TUS ALZTAL GARCHING)	013 FUKYGATA ICHI	(6.7)	6.4	6.5	(5.8)	6.6			19.5	19.5 5

R1 G2/2 (7) Tatami 1 11:20(2023-02-11)

Teilnehmer	Kata	1	2	3	4	5	6	7	TOTAL	ExtrGesamRang
1 SCHÜTZ JOHANNA (KD STRAUBING)	006 BASSAI DAI	(7.1)	7.0	(6.5)	6.9	6.9			20.8	20.8 2
2 PERL ALEGRA (1. FC SCHNAITTACH)	020 GOJUSHIHO DAI	(6.9)	6.6	(6.0)	6.3	6.7			19.6	19.6 7
3 DECKER KATHARINA (ASIA SPORTS KARATESCHULE)	029 HEIAN GODAN	6.8	(7.2)	(6.3)	6.7	6.9			20.4	20.4 5
4 MÜLLER SARAH (TSV MONHEIM E.V.)	021 GOJUSHIHO SHO	(7.3)	6.8	(6.3)	7.0	6.8			20.6	20.6 3
5 KLUPSCH EMILIA (SG MOOSBURG E.V. ABTEILUNG KARATE)	012 ENPI	(7.0)	6.7	(6.4)	6.8	7.0			20.5	20.5 4
6 KRIEGER LENA (ASIA SPORTS KARATESCHULE)	006 BASSAI DAI	(6.9)	6.5	(5.9)	6.5	6.9			19.9	19.9 6
7 BIEDEMANN HANNAH (KARATE DOJO OKI BAYERN)	015 GANKAKU	7.5	(7.8)	(7.2)	7.6	7.6			22.7	22.7 1

R2-G1

Teilnehmer	Kata	1	2	3	4	5	6	7	TOTAL	ExtrGesamRang
1 EHLING MAGDALENA (ASIA SPORTS KARATESCHULE)	068 PAPUREN	7.0	(6.4)	7.2	(7.4)	7.2			21.4	21.4 2
2 RIEMENSBERGER ISABEL (TSV JAHN 1892 WÜRZBURG E.V.)	041 KANKU SHO	6.8	(6.2)	6.3	(7.1)	7.0			20.1	20.1 4
3 LAMPERSBERGER EMILIA (TSV GRABENSTÄTT / CHIEMSEE E. V.)	021 GOJUSHIHO SHO	6.5	(7.4)	(6.4)	6.9	6.8			20.2	20.2 3
4 BIEDEMANN GRETA (KARATE DOJO OKI BAYERN)	078 SANSAI	7.1	(7.0)	7.4	(7.7)	7.5			22.0	22.0 1

R2-G2

Teilnehmer	Kata	1	2	3	4	5	6	7	TOTAL	ExtrGesamRang
1 BIEDEMANN HANNAH (KARATE DOJO OKI BAYERN)	041 KANKU SHO	(7.6)	(7.2)	7.4	7.2	7.4			22.0	22.0 1
2 KLUPSCH EMILIA (SG MOOSBURG E.V. ABTEILUNG KARATE)	006 BASSAI DAI	6.4	(6.7)	6.6	6.5	(5.7)			19.5	19.5 3
3 SCHÜTZ JOHANNA (KD STRAUBING)	036 JION	(6.8)	7.0	(7.1)	6.9	6.8			20.7	20.7 2
4 MÜLLER SARAH (TSV MONHEIM E.V.)	041 KANKU SHO	(6.2)	6.4	(6.9)	6.6	6.4			19.4	19.4 4

R3 Bronze Medal Match 1

Teilnehmer	Kata	1	2	3	4	5	6	7	TOTAL	ExtrGesamRang
1 KLUPSCH EMILIA (SG MOOSBURG E.V. ABTEILUNG KARATE)	029 HEIAN GODAN	(7.0)	6.6	6.8	6.8	6.6	(6.5)	6.8	33.6	33.6 2
2 EHLING MAGDALENA (ASIA SPORTS KARATESCHULE)	009 CHIBANA NO KUSHANKU	(7.4)	7.1	7.0	7.0	(6.5)	6.8	7.0	34.9	34.9 1

R3 Bronze Medal Match 2





Teilnehmer	Kata	1	2	3	4	5	6	7	TOTAL	ExtrGesamRang
1 SCHÜTZ JOHANNA (KD STRAUBING)	021 GOJUSHIHO SHO	7.1	7.0	7.0	(7.2)	7.0	7.2	(6.8)	35.3	35.3 1
2 LAMPERSBERGER EMILIA (TSV GRABENSTÄTT / CHIEMSEE E. V.)	012 ENPI	6.9	6.8	(6.7)	(7.4)	6.8	6.8	6.9	34.2	34.2 2

R3 Gold Medal Match

Teilnehmer	Kata	1	2	3	4	5	6	7	TOTAL	ExtrGesamRang
1 BIEDEMANN HANNAH (KARATE DOJO OKI BAYERN)	099 UNSU	7.1	(7.4)	7.0	(6.8)	7.2	7.2	7.2	35.7	35.7 1
2 BIEDEMANN GRETA (KARATE DOJO OKI BAYERN)	099 UNSU	(7.3)	7.2	(6.8)	7.0	7.0	7.0	6.9	35.1	35.1 2

**Bayerische Meisterschaft
Schüler - LK 2023 - 2023-02-11
Kata Schüler A w**

Results

1	BIEDEMANN HANNAH	KARATE DOJO OKI BAYERN		GERMANY
2	BIEDEMANN GRETA	KARATE DOJO OKI BAYERN		GERMANY
3	EHLING MAGDALENA	ASIA SPORTS KARATESCHULE		GERMANY
3	SCHÜTZ JOHANNA	KD STRAUBING		GERMANY
5	KLUPSCH EMILIA	SG MOOSBURG E.V. ABTEILUNG KARATE		GERMANY
5	LAMPERSBERGER EMILIA	TSV GRABENSTÄTT / CHIEMSEE E. V.		GERMANY
7	RIEMENSBERGER ISABEL	TSV JAHN 1892 WÜRZBURG E.V.		GERMANY

**Bayerische Meisterschaft
Schüler - LK 2023 - 2023-02-11
Kata Schüler B Einzel m**

R1 G1/2 (7) Tatami 1 09:00(2023-02-11)

Teilnehmer	Kata	1	2	3	4	5	6	7	TOTAL	ExtrGesamRang
1 FUHRMANN MAXIMILIAN (SRS KARATE BURGKIRCHEN)	003 ANANKO	6.7	6.5	(7.2)	(6.3)	7.0			20.2	20.2 5
2 OPPACHER SIMON (TSV 1888 WAGING AM SEE E.V.)	026 HEIAN NIDAN	6.3	(5.9)	(6.7)	6.0	6.5			18.8	18.8 6
3 FISCHER MARKUS (ASIA SPORTS KARATESCHULE)	006 BASSAI DAI	(7.0)	7.3	(7.5)	7.4	7.1			21.8	21.8 2
4 SFAR FEDI (KARATE VEREIN HERZOGENAURACH)	029 HEIAN GODAN	(6.7)	7.1	(7.6)	6.8	6.9			20.8	20.8 4
5 MEHLHAFF ALEXANDER (ASIA SPORTS KARATESCHULE)										
6 PROBST ARTHUR (TSV GRASBRUNN-NEUKEFERLOH)	012 ENPI	7.2	(7.0)	(7.8)	7.4	7.1			21.7	21.7 3
7 ZWIRGLMAIER SIMON (OKINAWA KARATE TSV FEICHTEN)	102 WANSHU	7.4	7.6	(8.0)	7.6	(7.3)			22.6	22.6 1

R1 G2/2 (7) Tatami 1 09:30(2023-02-11)

Teilnehmer	Kata	1	2	3	4	5	6	7	TOTAL	ExtrGesamRang
1 KNETEMANN DARIEN (ASV DACHAU)	029 HEIAN GODAN	6.6	(6.4)	(6.8)	6.6	6.5			19.7	19.7 5
2 HURLER ELIAH (TSV MONHEIM E.V.)	029 HEIAN GODAN	(7.2)	7.1	7.2	(6.8)	6.9			21.2	21.2 2
3 SARRAF ELIJA EMANUEL (SV STEINHEIM E.V.)	026 HEIAN NIDAN	6.8	(6.6)	(7.0)	6.8	6.7			20.3	20.3 3
4 WIMMER BEN (TSV 1888 WAGING AM SEE E.V.)										
5 TRAUNSPURGER JAKOB (TSV 1888 WAGING AM SEE E.V.)	026 HEIAN NIDAN	5.8	5.7	(6.4)	(5.6)	5.9			17.4	17.4 6
6 HÜTTER MICHAEL (ASIA SPORTS KARATESCHULE)	006 BASSAI DAI	(7.5)	(7.4)	7.4	7.5	7.5			22.4	22.4 1
7 STEINER NOAH (OKINAWA KARATE TSV FEICHTEN)	013 FUKYGATA ICHI	6.7	(6.2)	6.8	6.7	(7.1)			20.2	20.2 4

R2-G1

Teilnehmer	Kata	1	2	3	4	5	6	7	TOTAL	ExtrGesamRang
1 PROBST ARTHUR (TSV GRASBRUNN-NEUKEFERLOH)	041 KANKU SHO	(7.4)	(6.2)	7.0	6.4	6.8			20.2	20.2 4
2 FISCHER MARKUS (ASIA SPORTS KARATESCHULE)	021 GOJUSHIHO SHO	(7.6)	(6.6)	7.5	7.3	7.2			22.0	22.0 2
3 SFAR FEDI (KARATE VEREIN HERZOGENAURACH)	027 HEIAN SANDAN	7.1	7.2	(7.3)	(6.9)	6.9			21.2	21.2 3
4 ZWIRGLMAIER SIMON (OKINAWA KARATE TSV FEICHTEN)	086 SEISAN	(7.8)	7.7	7.7	7.7	(7.6)			23.1	23.1 1

R2-G2

Teilnehmer	Kata	1	2	3	4	5	6	7	TOTAL	ExtrGesamRang
1 HURLER ELIAH (TSV MONHEIM E.V.)	036 JION	6.7	(6.6)	6.6	7.0	(7.2)			20.3	20.3 1
2 HÜTTER MICHAEL (ASIA SPORTS KARATESCHULE)	021 GOJUSHIHO SHO	6.5	(6.2)	6.4	(6.8)	6.3			19.2	19.2 4
3 SARRAF ELIJA EMANUEL (SV STEINHEIM E.V.)	027 HEIAN SANDAN	6.7	(6.3)	(6.9)	6.7	6.7			20.1	20.1 2
4 STEINER NOAH (OKINAWA KARATE TSV FEICHTEN)	102 WANSHU	6.3	(6.0)	(7.0)	6.9	6.5			19.7	19.7 3

R3 Bronze Medal Match 1

Teilnehmer	Kata	1	2	3	4	5	6	7	TOTAL	ExtrGesamRang
1 FISCHER MARKUS (ASIA SPORTS KARATESCHULE)	029 HEIAN GODAN	6.8	7.0	(6.6)	7.1	(7.2)	7.2	7.0	35.1	35.1 1
2 STEINER NOAH (OKINAWA KARATE TSV FEICHTEN)	086 SEISAN									

R3 Bronze Medal Match 2







Teilnehmer	Kata	1	2	3	4	5	6	7	TOTAL	ExtrGesamRang
1 SFAR FEDI (KARATE VEREIN HERZOGENAURACH)	028 HEIAN YONDAN	6.6	6.4	(6.2)	(7.0)	6.5	6.4	6.7	32.6	32.6 2
2 SARRAF ELIJA EMANUEL (SV STEINHEIM E.V.)	025 HEIAN SHODAN	(7.3)	7.2	(6.8)	7.2	7.0	7.2	7.3	35.9	35.9 1

R3 Gold Medal Match

Teilnehmer	Kata	1	2	3	4	5	6	7	TOTAL	ExtrGesamRang
1 ZWIRGLMAIER SIMON (OKINAWA KARATE TSV FEICHTEN)	036 JION	(7.2)	7.4	7.5	(7.6)	7.6	7.5	7.4	37.4	37.4 1
2 HURLER ELIAH (TSV MONHEIM E.V.)	012 ENPI	(6.2)	7.2	7.0	7.0	7.4	7.6	(7.7)	36.2	36.2 2

Results

**Bayerische Meisterschaft
Schüler - LK 2023 - 2023-02-11
Kata Schüler B Einzel m**

1	ZWIRGLMAIER SIMON	OKINAWA KARATE TSV FEICHTEN		GERMANY
2	HURLER ELIAH	TSV MONHEIM E.V.		GERMANY
3	FISCHER MARKUS	ASIA SPORTS KARATESCHULE		GERMANY
3	SARRAF ELIJA EMANUEL	SV STEINHEIM E.V.		GERMANY
5	SFAR FEDI	KARATE VEREIN HERZOGENAURACH		GERMANY
7	PROBST ARTHUR	TSV GRASBRUNN-NEUKEFERLOH		GERMANY
7	HÜTTER MICHAEL	ASIA SPORTS KARATESCHULE		GERMANY

**Bayerische Meisterschaft
Schüler - LK 2023 - 2023-02-11
Kata Schüler B Einzel w**

R1 G1/2 (6) Tatami 2 09:00(2023-02-11)

Teilnehmer	Kata	1	2	3	4	5	6	7	TOTAL	ExtrGesamRang
1 HAPFELMEIER LOUISA (ASIA SPORTS KARATESCHULE)	021 GOJUSHIHO SHO	(7.4)	(7.0)	7.1	7.3	7.2			21.6	21.6 1
2 AKINCI NISA_NAS (SV UNSU KARATE MÖMLINGEN E.V.)	012 ENPI	(6.8)	6.8	7.1	(7.5)	7.5			21.4	21.4 2
3 DÖRSCH ROSALIE (ASV DACHAU)	026 HEIAN NIDAN	6.3	6.2	(6.5)	6.3	(6.0)			18.8	18.8 6
4 TROMSA SANDRA (TUS FEUCHTWANGEN)	026 HEIAN NIDAN	7.0	(7.2)	(6.8)	6.9	6.8			20.7	20.7 3
5 REISWICH LEANA (KD STRAUBING)	027 HEIAN SANDAN	6.6	6.9	6.5	(7.0)	(6.4)			20.0	20.0 4
6 LEOPOLD HANNAH (TSV ERDING)	017 GEKISAI ICHI	6.4	(6.6)	6.4	6.2	(6.1)			19.0	19.0 5

R1 G2/2 (6) Tatami 2 09:25(2023-02-11)

Teilnehmer	Kata	1	2	3	4	5	6	7	TOTAL	ExtrGesamRang
1 SCHIERACK ANNA_SOFIE (ASV DACHAU)	006 BASSAI DAI	(6.6)	6.2	(5.8)	6.4	6.2			18.8	18.8 6
2 SEIDELT ALINA (KARATE DOJO OKI BAYERN)	026 HEIAN NIDAN	6.2	6.5	(6.1)	(6.6)	6.4			19.1	19.1 4
3 MOHR LOREEN (TUS FEUCHTWANGEN)	026 HEIAN NIDAN	(6.8)	7.0	6.8	7.0	(7.2)			20.8	20.8 2
4 SCHMIDT LISA (ASIA SPORTS KARATESCHULE)	028 HEIAN YONDAN	6.5	(6.9)	(6.3)	6.7	6.9			20.1	20.1 3
5 SEIDEL FABIENNE (KD STRAUBING)	006 BASSAI DAI	(6.9)	7.2	7.1	7.3	(7.4)			21.6	21.6 1
6 CUERVO_ACEBEDO VEGA (TSV MONHEIM E.V.)	026 HEIAN NIDAN	(6.3)	6.3	(5.9)	6.3	6.3			18.9	18.9 5

R2-G1

Teilnehmer	Kata	1	2	3	4	5	6	7	TOTAL	ExtrGesamRang
1 AKINCI NISA_NAS (SV UNSU KARATE MÖMLINGEN E.V.)	041 KANKU SHO	7.0	(6.8)	(7.2)	7.1	6.8			20.9	20.9 2
2 TROMSA SANDRA (TUS FEUCHTWANGEN)	036 JION	6.4	6.7	(6.3)	(6.8)	6.6			19.7	19.7 4
3 HAPFELMEIER LOUISA (ASIA SPORTS KARATESCHULE)	068 PAPUREN	(7.6)	(7.0)	7.5	7.2	7.4			22.1	22.1 1
4 REISWICH LEANA (KD STRAUBING)	026 HEIAN NIDAN	(6.8)	(6.5)	6.6	6.8	6.7			20.1	20.1 3

R2-G2

Teilnehmer	Kata	1	2	3	4	5	6	7	TOTAL	ExtrGesamRang
1 SEIDELT ALINA (KARATE DOJO OKI BAYERN)	025 HEIAN SHODAN	(7.3)	6.8	6.7	(6.4)	6.6			20.1	20.1 4
2 SCHMIDT LISA (ASIA SPORTS KARATESCHULE)	026 HEIAN NIDAN	(7.6)	7.1	6.6	(6.0)	6.9			20.6	20.6 3
3 MOHR LOREEN (TUS FEUCHTWANGEN)	036 JION	(7.8)	7.2	7.3	7.2	(7.1)			21.7	21.7 2
4 SEIDEL FABIENNE (KD STRAUBING)	036 JION	(8.0)	7.5	7.5	7.4	(7.0)			22.4	22.4 1

R3 Bronze Medal Match 1

Teilnehmer	Kata	1	2	3	4	5	6	7	TOTAL	ExtrGesamRang
1 AKINCI NISA_NAS (SV UNSU KARATE MÖMLINGEN E.V.)	021 GOJUSHIHO SHO	7.0	(7.5)	7.2	7.0	(6.8)	7.0	7.1	35.3	35.3 1
2 SCHMIDT LISA (ASIA SPORTS KARATESCHULE)	021 GOJUSHIHO SHO	(6.7)	6.7	6.6	6.5	(6.2)	6.6	6.4	32.8	32.8 2



R3 Bronze Medal Match 2

Teilnehmer	Kata	1	2	3	4	5	6	7	TOTAL	ExtrGesamRang
1 REISWICH LEANA (KD STRAUBING)	025 HEIAN SHODAN	7.0	(7.1)	6.9	(6.5)	7.0	6.8	6.9	34.6	34.6 2
2 MOHR LOREEN (TUS FEUCHTWANGEN)	006 BASSAI DAI	7.5	(7.7)	7.1	(7.0)	7.7	7.3	7.1	36.7	36.7 1

R3 Gold Medal Match

Teilnehmer	Kata	1	2	3	4	5	6	7	TOTAL	ExtrGesamRang
1 HAPFELMEIER LOUISA (ASIA SPORTS KARATESCHULE)	002 ANAN DAI	7.2	7.3	7.2	(7.0)	7.1	7.3	(7.4)	36.1	36.1 2
2 SEIDEL FABIENNE (KD STRAUBING)	021 GOJUSHIHO SHO	7.3	(7.6)	7.4	7.5	7.4	(7.1)	7.2	36.8	36.8 1

Results

1	SEIDEL FABIENNE	KD STRAUBING		GERMANY
2	HAPFELMEIER LOUISA	ASIA SPORTS KARATESCHULE		GERMANY
3	AKINCI NISA NAS	SV UNSU KARATE MÖMLINGEN E.V.		GERMANY

**Bayerische Meisterschaft
Schüler - LK 2023 - 2023-02-11
Kata Schüler B Einzel w**

3	MOHR LOREEN	TUS FEUCHTWANGEN		GERMANY
5	SCHMIDT LISA	ASIA SPORTS KARATESCHULE		GERMANY
5	REISWICH LEANA	KD STRAUBING		GERMANY
7	TROMSA SANDRA	TUS FEUCHTWANGEN		GERMANY
7	SEIDELT ALINA	KARATE DOJO OKI BAYERN		GERMANY

**Bayerische Meisterschaft
Schüler - LK 2023 - 2023-02-11
Kata Team Schüler A+B männlich**

Kata Team Schüler A+B männlich R1 G1/2 (2) Tatami 2 10:50(2023-02-11)

Teilnehmer	Kata	1	2	3	4	5	6	7	TOTAL	ExtrGesamRang
1 OKINAWA KARATE TSV FEICHTEN (KAISER, STEINER, ZWIRGLMAIER) (OKINAWA KARATE TSV FEICHTEN)	013 FUKYGATA ICHI	7.0	7.0	(6.3)	(7.2)	7.2			21.2	21.2 1
2 TSV 1888 WAGING AM SEE E.V. (BOUKROUH, OPPACHER, TRAUNSPURGER) (TSV 1888 WAGING AM SEE E.V.)	026 HEIAN NIDAN	6.5	(6.8)	(5.8)	6.8	6.2			19.5	19.5 2

Kata Team Schüler A+B männlich R1 G2/2 (2) Tatami 2 11:05(2023-02-11)

Teilnehmer	Kata	1	2	3	4	5	6	7	TOTAL	ExtrGesamRang
1 ASIA SPORTS KARATESCHULE (FISCHER, HÜTTER, LIBIK) (ASIA SPORTS KARATESCHULE)	006 BASSAI DAI	7.2	7.2	(6.5)	(7.4)	7.4			21.8	21.8 1
2 SV STEINHEIM E.V. (BOHN, GEORGE, HONOLD, SARRAF) (SV STEINHEIM E.V.)	025 HEIAN SHODAN	6.8	7.0	(6.2)	(7.1)	7.0			20.8	20.8 2

Kata Team Schüler A+B männlich R2 Gold Medal Match

Teilnehmer	Kata	1	2	3	4	5	6	7	TOTAL	ExtrGesamRang
1 OKINAWA KARATE TSV FEICHTEN (KAISER, STEINER, ZWIRGLMAIER) (OKINAWA KARATE TSV FEICHTEN)	102 WANSHU	7.0	7.0	(7.2)	7.2	7.2	7.2	(6.8)	35.6	35.6 1
2 ASIA SPORTS KARATESCHULE (FISCHER, HÜTTER, LIBIK) (ASIA SPORTS KARATESCHULE)	021 GOJUSHIHO SHO	(7.2)	7.2	7.2	7.0	(6.8)	7.0	7.0	35.4	35.4 2

Results



1 OKINAWA KARATE TSV FEICHTEN - ZWIRGLMAIER SIMON - STEINER NOAH - KAISER MATTHIAS	OKINAWA KARATE TSV FEICHTEN		GERMANY
2 ASIA SPORTS KARATESCHULE - HÜTTER MICHAEL - FISCHER MARKUS - LIBIK DANIEL	ASIA SPORTS KARATESCHULE		GERMANY
3 TSV 1888 WAGING AM SEE E.V. - OPPACHER SIMON - TRAUNSPURGER JAKOB - BOUKROUH AHMED	TSV 1888 WAGING AM SEE E.V.		GERMANY
3 SV STEINHEIM E.V. - GEORGE NOEL - HONOLD TOBIAS - SARRAF ELIJA_EMANUEL - BOHN LIAM	SV STEINHEIM E.V.		GERMANY

**Bayerische Meisterschaft
Schüler - LK 2023 - 2023-02-11
Kata Team Schüler A+B weiblich**

Kata Team Schüler A+B weiblich R1 G1/1 (3) Tatami 1 11:00(2023-02-11)

	Teilnehmer	Kata	1	2	3	4	5	6	7	TOTAL	Extr	Gesam	Rang
1	ASIA SPORTS KARATESCHULE (EHLING, HAPFELMEIER, KRIEGER) (ASIA SPORTS KARATESCHULE)	002 ANAN DAI	7.4	(7.6)	7.5	7.4	(7.2)			22.3		22.3	1
2	ASV DACHAU (BURGMEIER, DÖRSCH, SCHIERACK) (ASV DACHAU)	026 HEIAN NIDAN	(6.7)	6.2	6.5	6.6	(5.8)			19.3		19.3	3
3	KD STRAUBING (REISWICH, SCHÜTZ, SEIDEL) (KD STRAUBING)	026 HEIAN NIDAN	7.2	(7.0)	(7.5)	7.2	7.1			21.5		21.5	2

Results

1	ASIA SPORTS KARATESCHULE - KRIEGER LENA - HAPFELMEIER LOUISA - EHLING MAGDALENA	ASIA SPORTS KARATESCHULE		GERMANY
2	KD STRAUBING - SEIDEL FABIENNE - SCHÜTZ JOHANNA - REISWICH LEANA	KD STRAUBING		GERMANY
3	ASV DACHAU - SCHIERACK ANNA_SOFIE - DÖRSCH ROSALIE - BURGMEIER ANNA	ASV DACHAU		GERMANY

Kumite Leistungsklasse +68 kg weiblich

Bayerische Meisterschaft Schüler - LK 2023, Jahnstraße 6, 84508 Burgkirchen an der Alz, GER

2023-02-11

Tatami
1 16:45

Pool
1/1

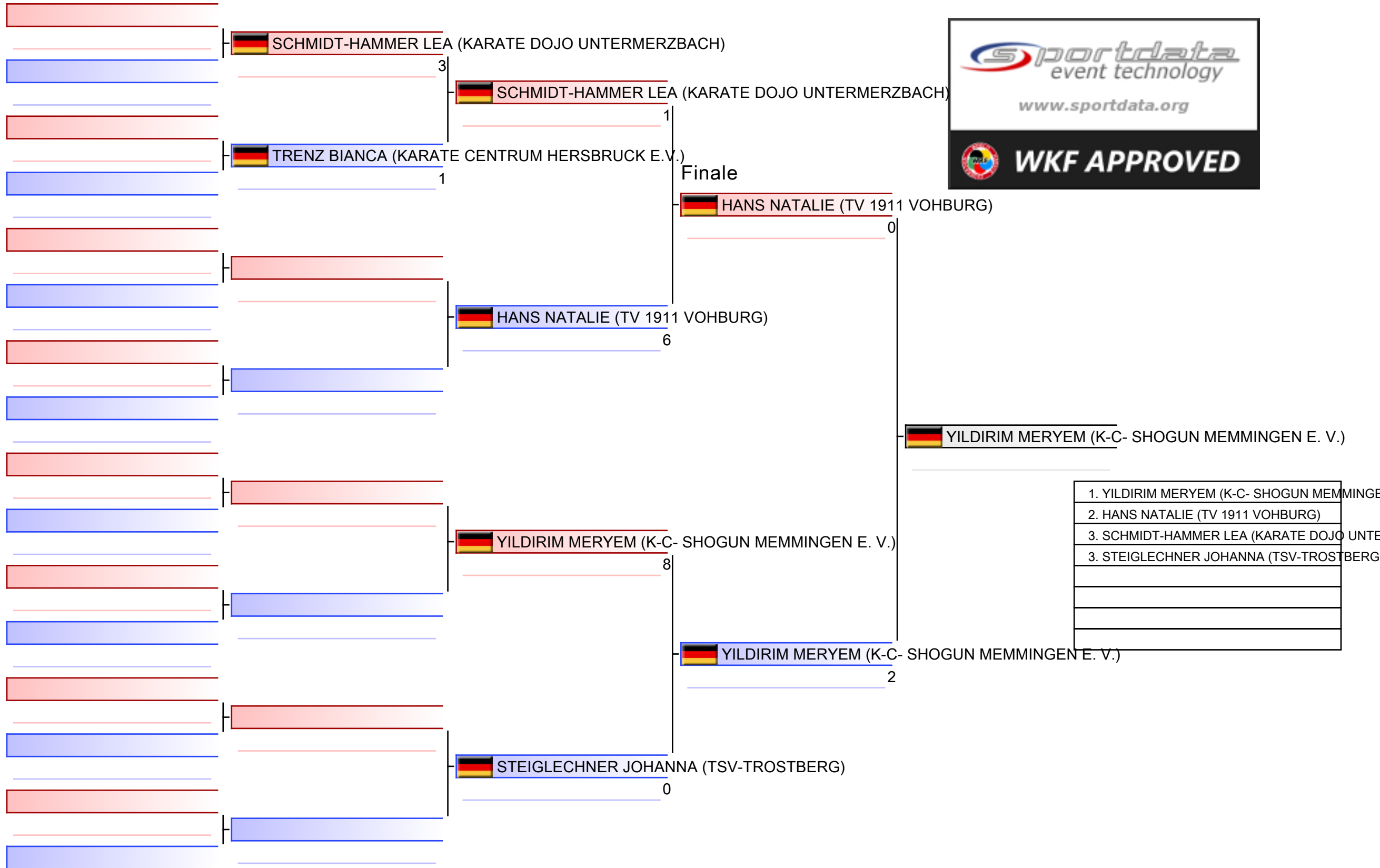

Kumite Leistungsklasse +68 kg weiblich

Bayerische Meisterschaft Schüler - LK 2023

2023-02-11

Tatami
1 17:05

Pool
1

(c)sportdata GmbH & Co KG 2000-2023 (2023-02-12 15:58) v 10.0.0 build 1 (2023-01-21) Lizenz: Online_Event_ID-6952_BayerischeMeisterschaftSchlerLK2023 (expire 2023-02-26)

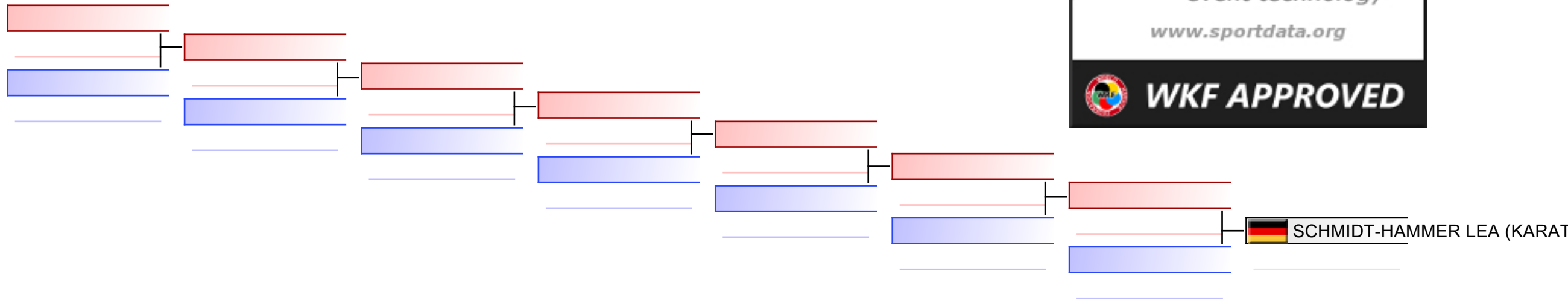

TROSTRUNDE: (1)

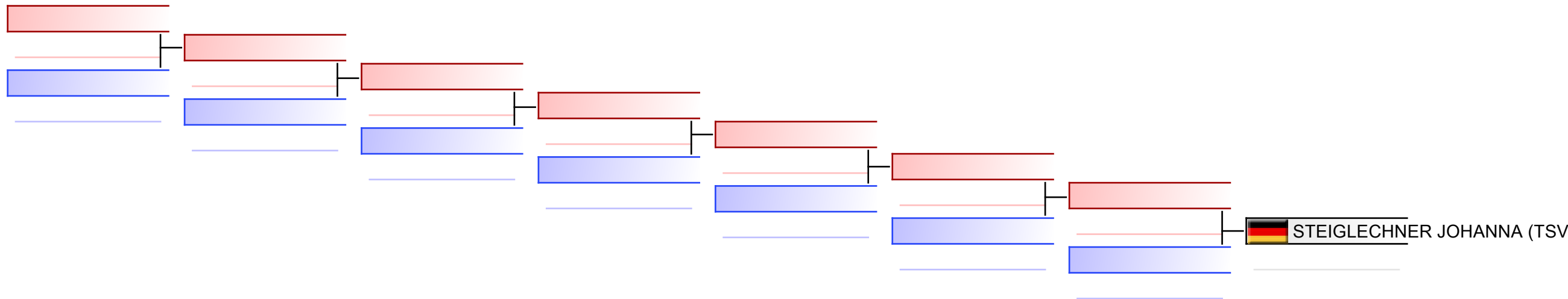

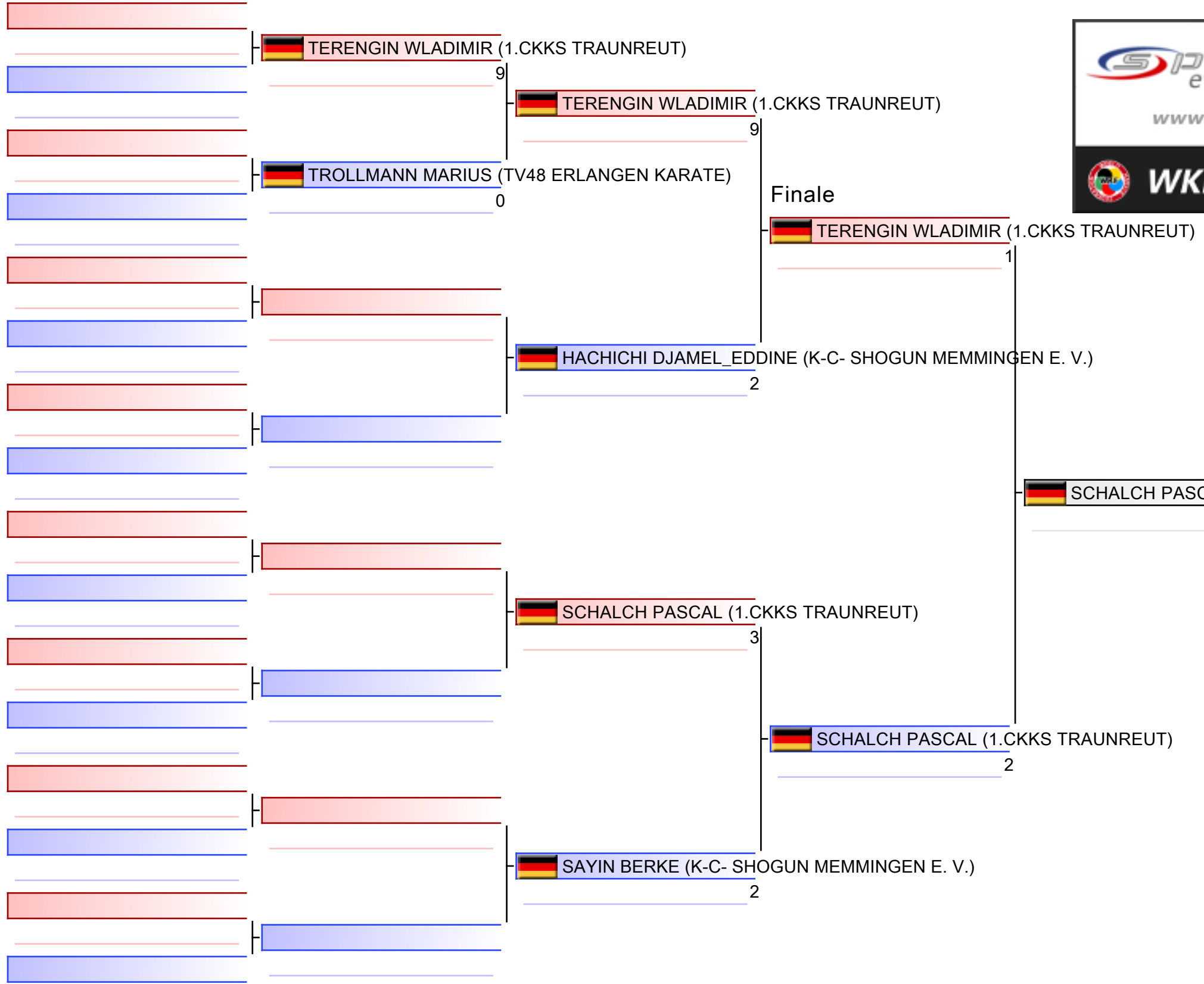

1. SCHALCH PASCAL (1.CKKS TRAUNREUT)
2. TERENGIN WLADIMIR (1.CKKS TRAUNREUT)
3. SAYIN BERKE (K-C- SHOGUN MEMMINGEN E. V.)
3. HACHICHI DJAMEL_EDDINE (K-C- SHOGUN MEMMINGEN E. V.)
5. TROLLMANN MARIUS (TV48 ERLANGEN KARATE)

Kumite Leistungsklasse +84 kg männlich

Bayerische Meisterschaft Schüler - LK 2023

2023-02-11

Tatami
2 17:30

Pool
1

(c)sportdata GmbH & Co KG 2000-2023 (2023-02-12 15:58) v 10.0.0 build 1 (2023-01-21) Lizenz: Online_Event_ID-6952_BayerischeMeisterschaftSchlerLK2023 (expire 2023-02-26)

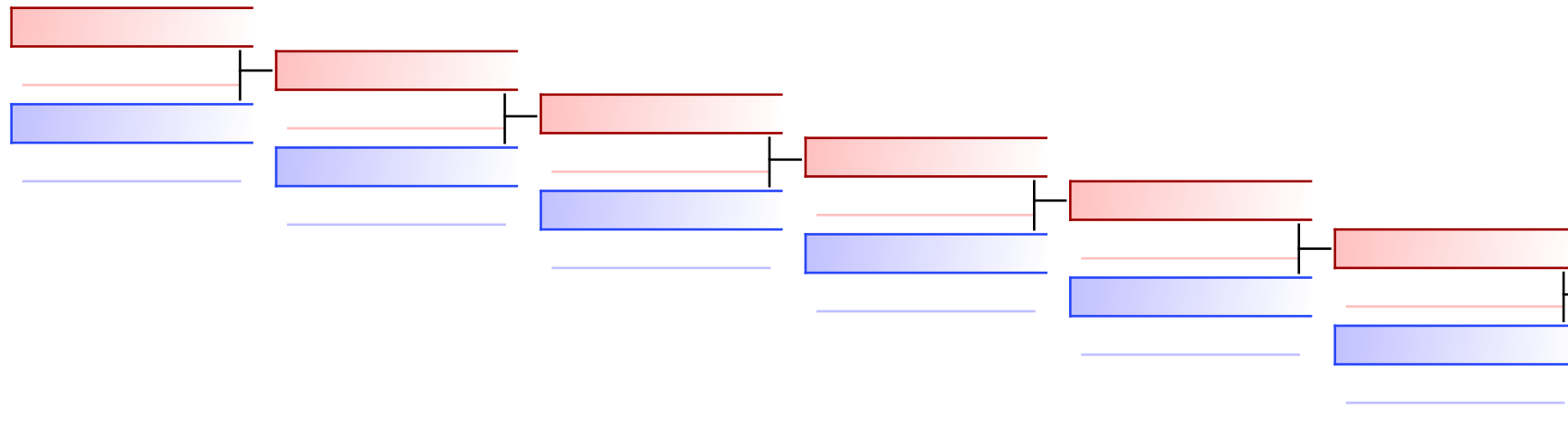

 TROLLMANN MARIUS (TV48 ERLANGEN KARATE)
0
 HACHICHI DJAMEL_EDDINE (K-C- SHOGUN MEMMING)
8
 HACHICHI DJAMEL_EDDINE (K-C- SHOGUN MEMMING)

TROSTRUNDE: (1)

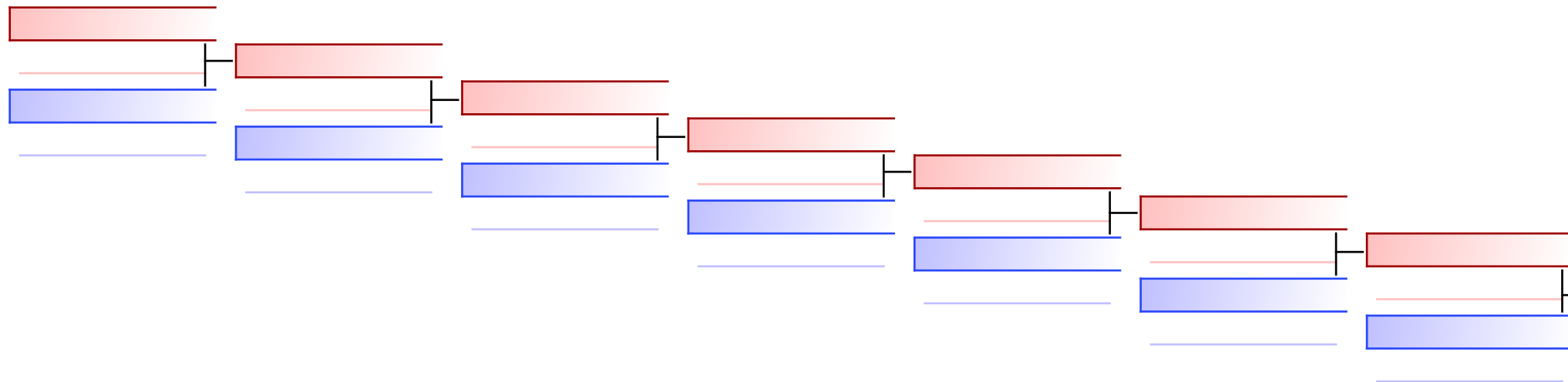

 SAYIN BERKE (K-C- SHOGUN MEMMING)

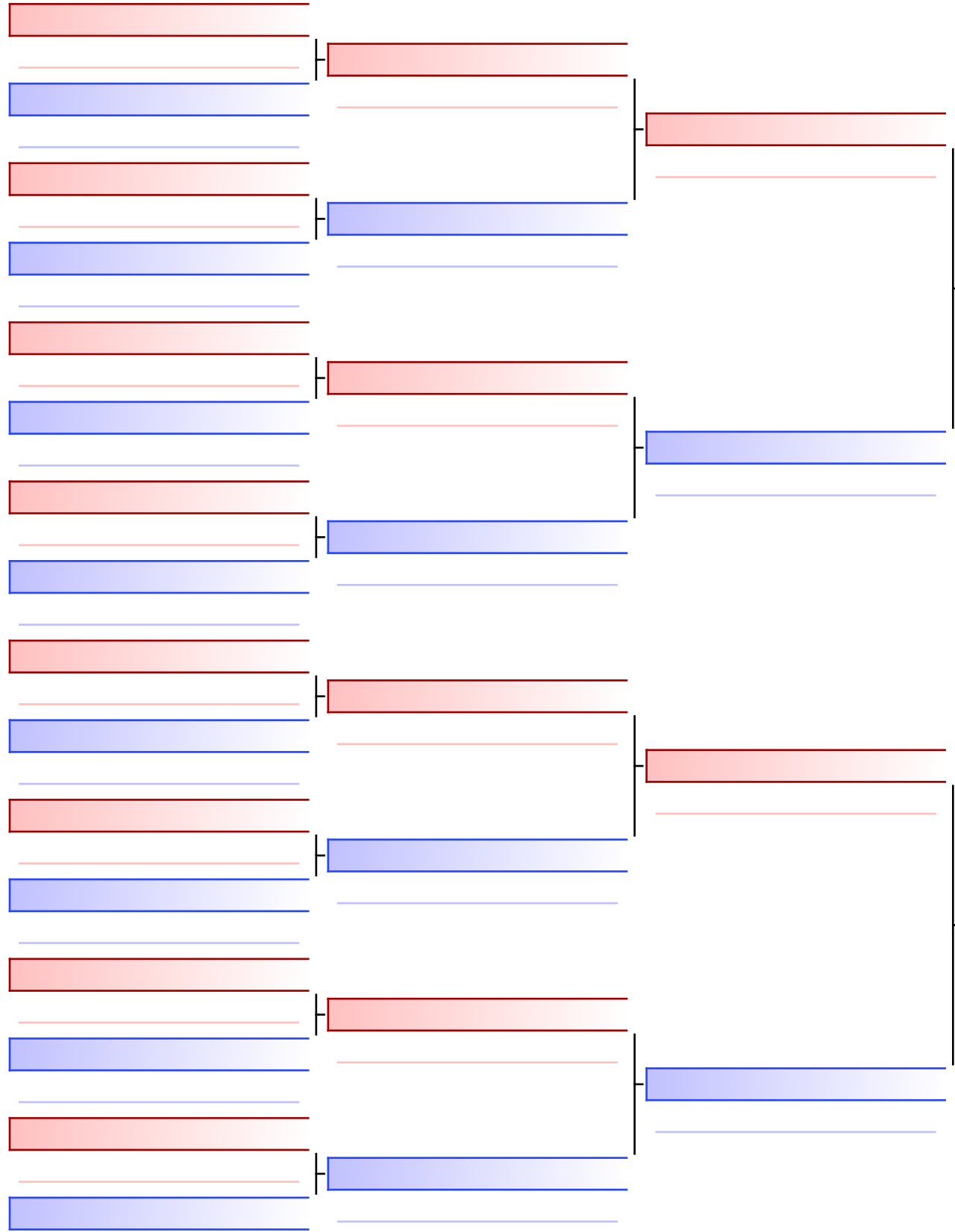

Finale

RUSTICEANU MONICA (POST SV BAMBERG)
1

GISSER ISABEL (1.CKKS TRAUNREUT)

GISSER ISABEL (1.CKKS TRAUNREUT)
4

1. GISSER ISABEL (1.CKKS TRAUNREUT)
2. RUSTICEANU MONICA (POST SV BAMBERG)









Kumite Leistungsklasse -55 kg weiblich - Round Robin (jeder gegen jeden)

Bayerische Meisterschaft Schüler - LK 2023, Jahnstraße 6, 84508 Burgkirchen an der Alz, GER

2023-02-11

Tatami
1 17:30

Pool
1/1

- 1  KNUPFER LALE (TV 1911 VOHBURG)
6 |  KNUPFER LALE (TV 1911 VOHBURG)
- 2  NELSON ALEENA (POST SV BAMBERG)
0
- 3  KNUPFER LALE (TV 1911 VOHBURG)
8 |  KNUPFER LALE (TV 1911 VOHBURG)
- 4  ISLAM NABILA (SV UNSU KARATE MÖMLINGEN E.V.)
1
- 5  NELSON ALEENA (POST SV BAMBERG)
0 |  NELSON ALEENA (POST SV BAMBERG)
- 6  ISLAM NABILA (SV UNSU KARATE MÖMLINGEN E.V.)
6



1. KNUPFER LALE (TV 1911 VOHBURG)
2. ISLAM NABILA (SV UNSU KARATE MÖMLINGEN E.V.)
3. NELSON ALEENA (POST SV BAMBERG)

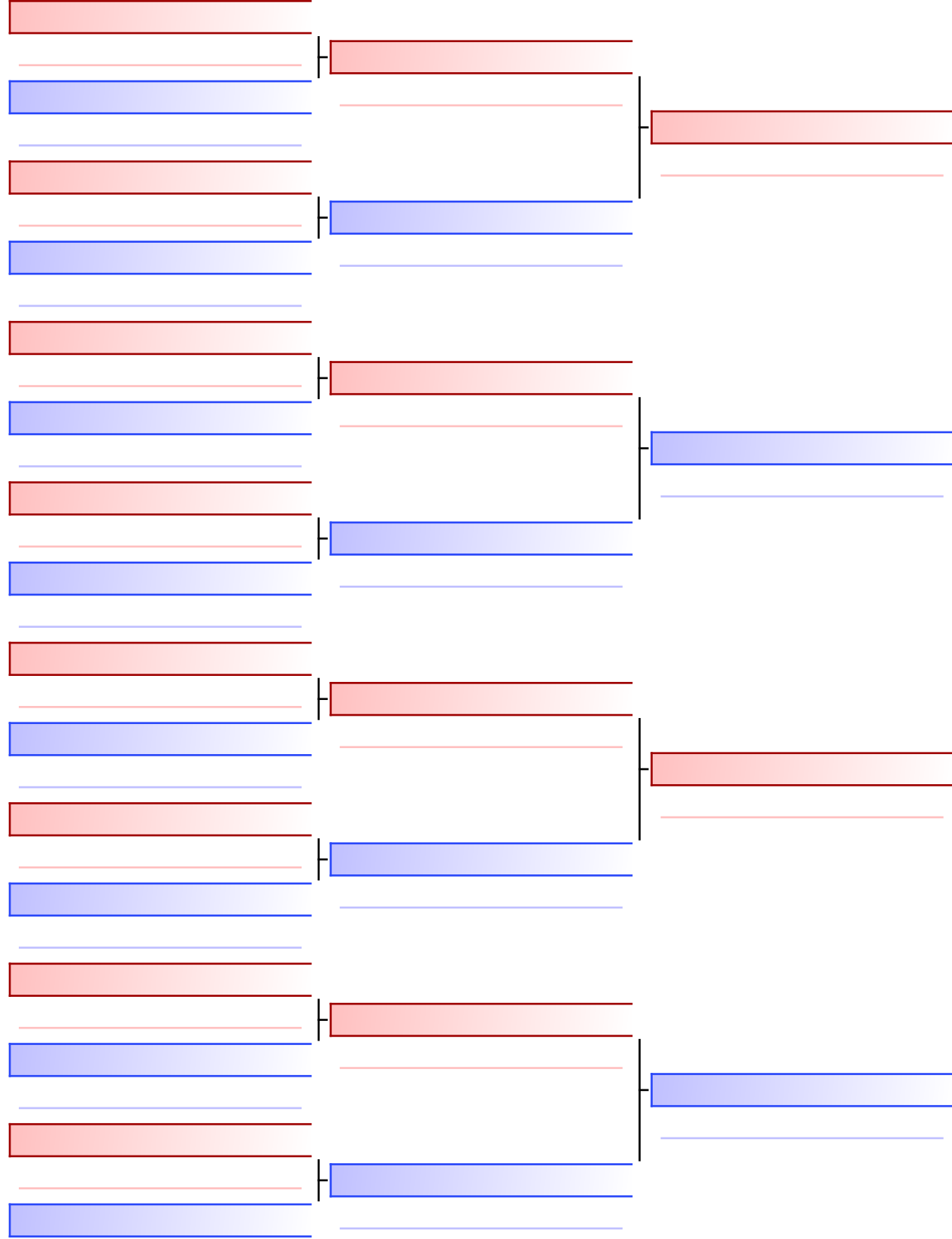

Finale

HAMI MUHAMMED (TV 1911 VOHBURG)

0

ALOISIO MATTEO (K-C- SHOGUN MEMMINGEN E. V.)

ALOISIO MATTEO (K-C- SHOGUN MEMMINGEN E. V.)

0

1. ALOISIO MATTEO (K-C- SHOGUN MEMMINGEN E. V.)
2. HAMI MUHAMMED (TV 1911 VOHBURG)

Kumite Leistungsklasse -61 kg weiblich

Bayerische Meisterschaft Schüler - LK 2023, Jahnstraße 6, 84508 Burgkirchen an der Alz, GER

2023-02-11

Tatami
2 17:55

Pool
1/1

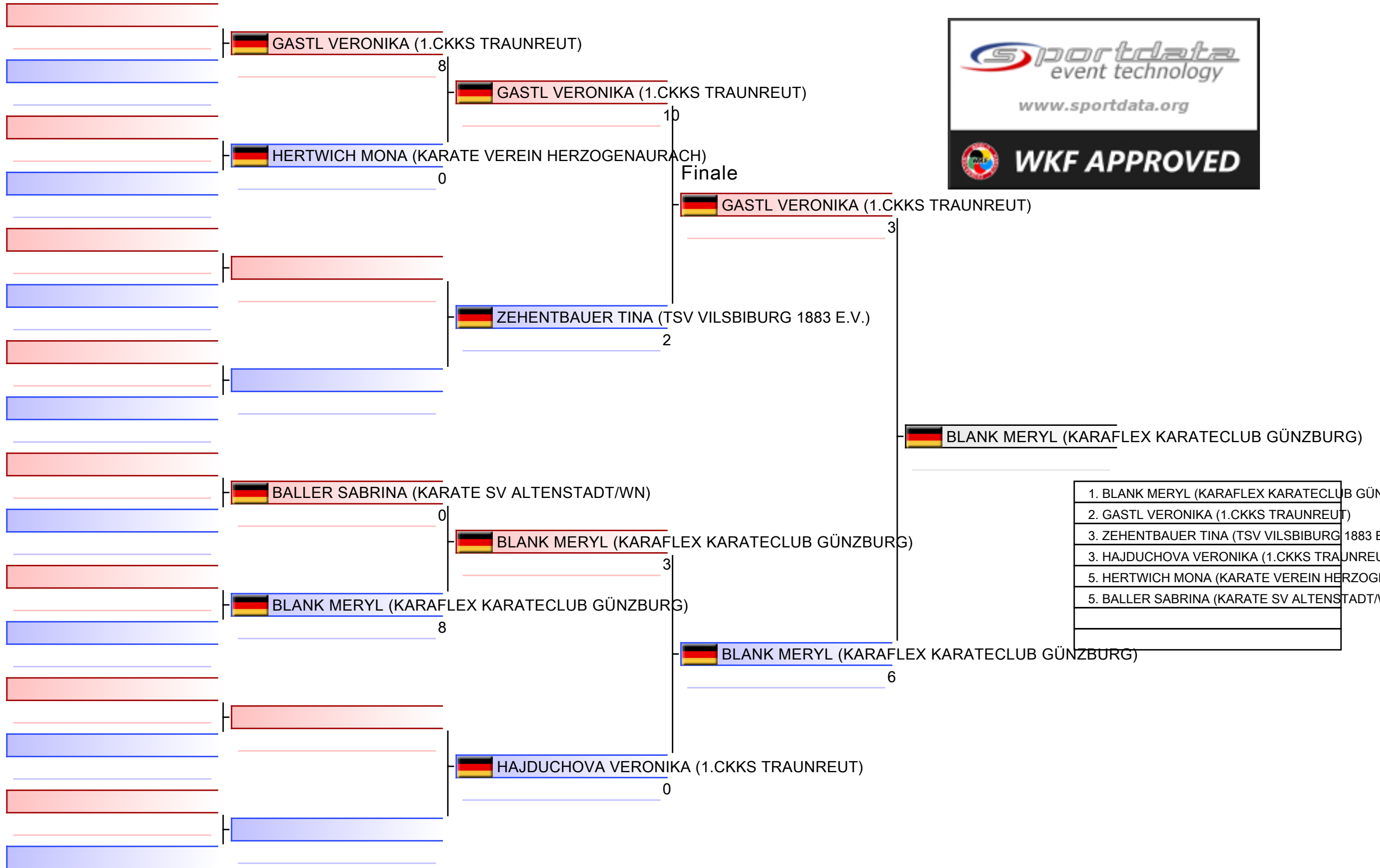

1. BLANK MERYL (KARAFLEX KARATECLUB GÜNZBURG)
2. GASTL VERONIKA (1.CKKS TRAUNREUT)
3. ZEHENTBAUER TINA (TSV VILSBIBURG 1883 E.V.)
3. HAJDUCHOVA VERONIKA (1.CKKS TRAUNREUT)
5. HERTWICH MONA (KARATE VEREIN HERZOGENAURACH)
5. BALLER SABRINA (KARATE SV ALTENSTADT/WN)

Kumite Leistungsklasse -61 kg weiblich

Bayerische Meisterschaft Schüler - LK 2023

2023-02-11

Tatami
2 18:20

Pool
1

(c)sportdata GmbH & Co KG 2000-2023 (2023-02-12 15:58) v 10.0.0 build 1 (2023-01-21) Lizenz: Online_Event_ID-6952_BayerischeMeisterschaftSchlerLK2023 (expire 2023-02-26)

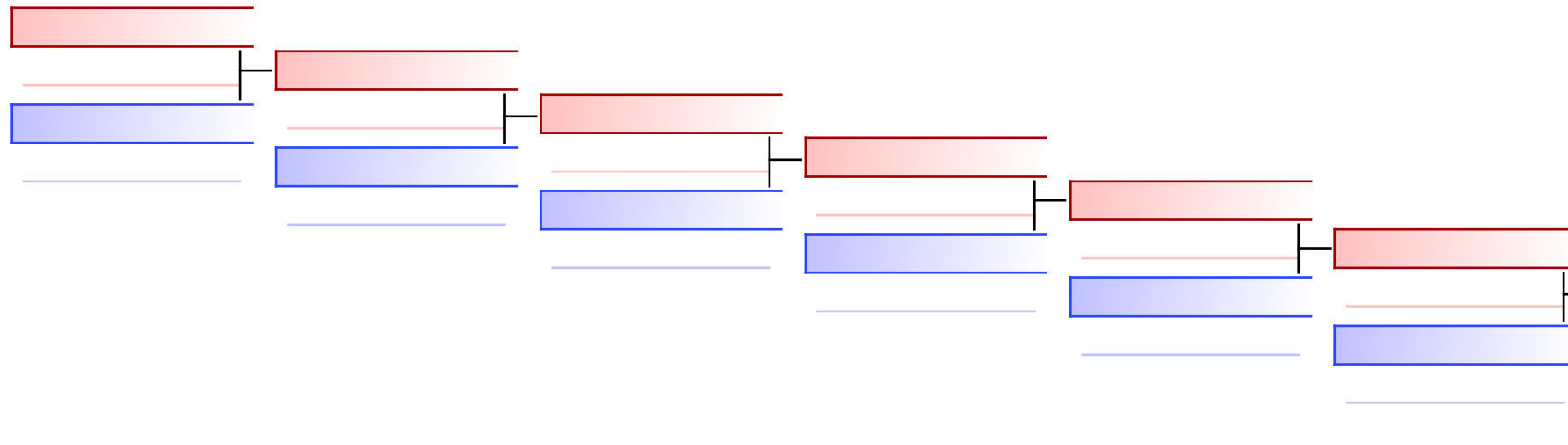

TROSTRUNDE: (1)

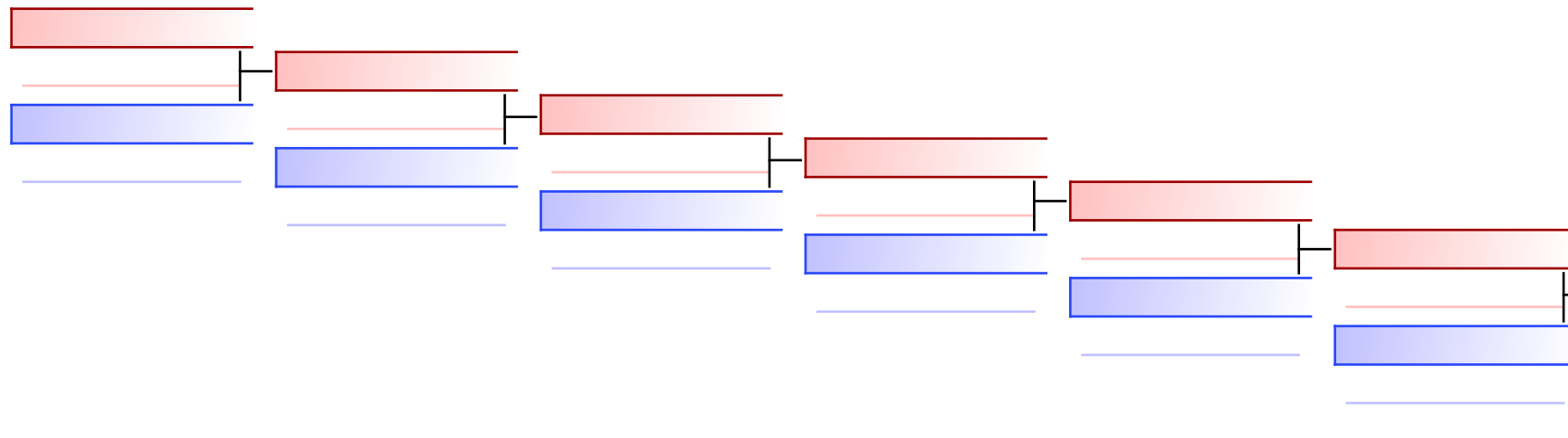

Kumite Leistungsklasse -67 kg männlich

Bayerische Meisterschaft Schüler - LK 2023, Jahnstraße 6, 84508 Burgkirchen an der Alz, GER

2023-02-11

Tatami
3 17:50

Pool
1/1

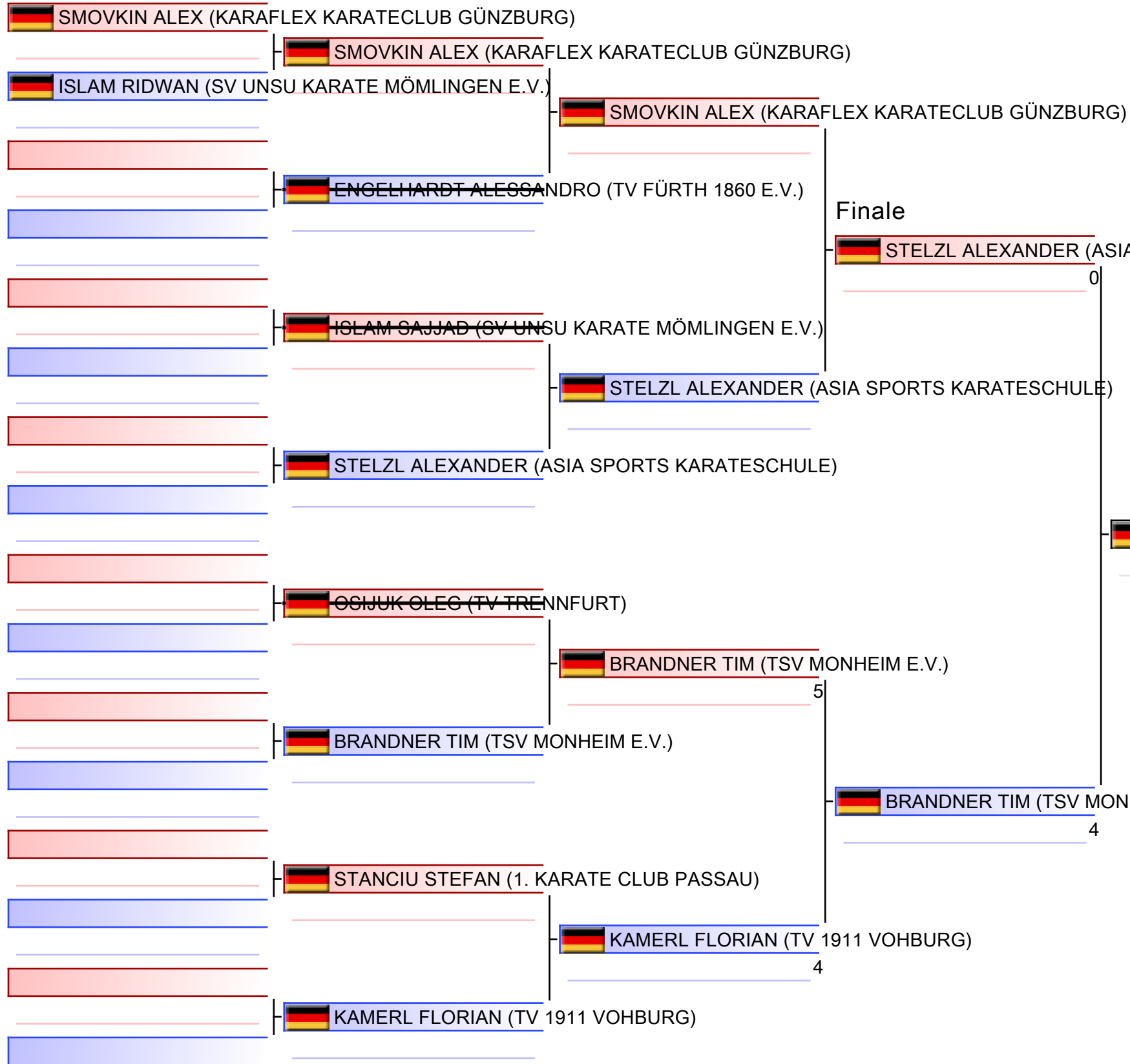

1. BRANDNER TIM (TSV MONHEIM E.V.)
2. STELZL ALEXANDER (ASIA SPORTS KARATESCHULE)
3. SMOVKIN ALEX (KARAFLEX KARATECLUB GÜNZBURG)
3. KAMERL FLORIAN (TV 1911 VOHBURG)

Kumite Leistungsklasse -67 kg männlich

Bayerische Meisterschaft Schüler - LK 2023

2023-02-11

Tatami
3 18:35

Pool
1

(c)sportdata GmbH & Co KG 2000-2023 (2023-02-12 15:58) v 10.0.0 build 1 (2023-01-21) Lizenz: Online_Event_ID-6952_BayerischeMeisterschaftSchlerLK2023 (expire 2023-02-26)

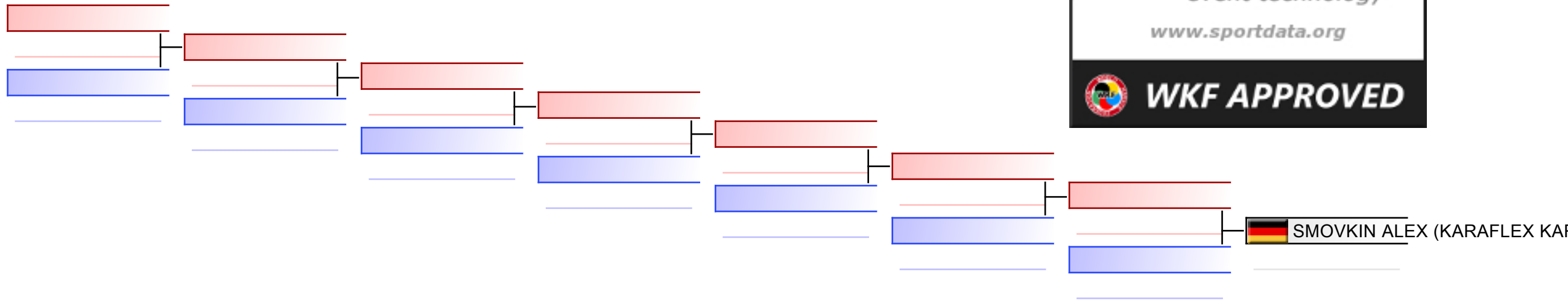

TROSTRUNDE: (1)

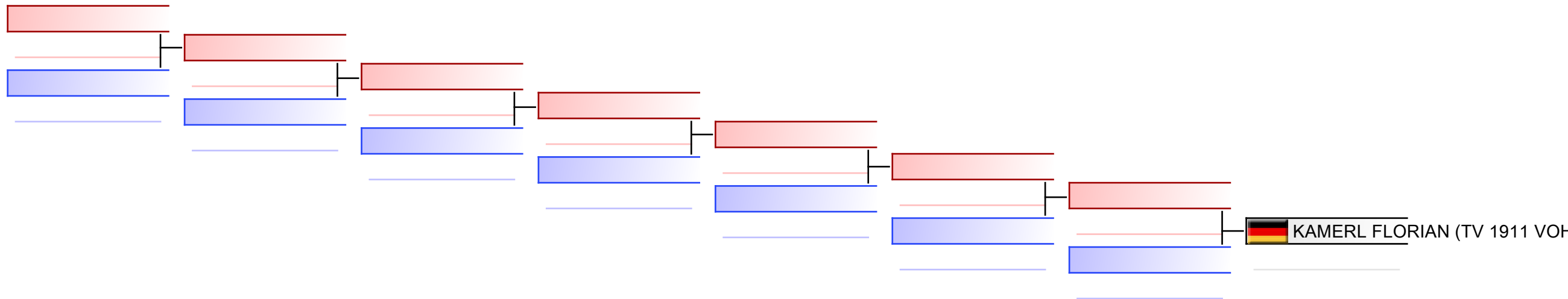

Kumite Leistungsklasse -68 kg weiblich

Bayerische Meisterschaft Schüler - LK 2023, Jahnstraße 6, 84508 Burgkirchen an der Alz, GER

2023-02-11

Tatami
1 17:50

Pool
1/1

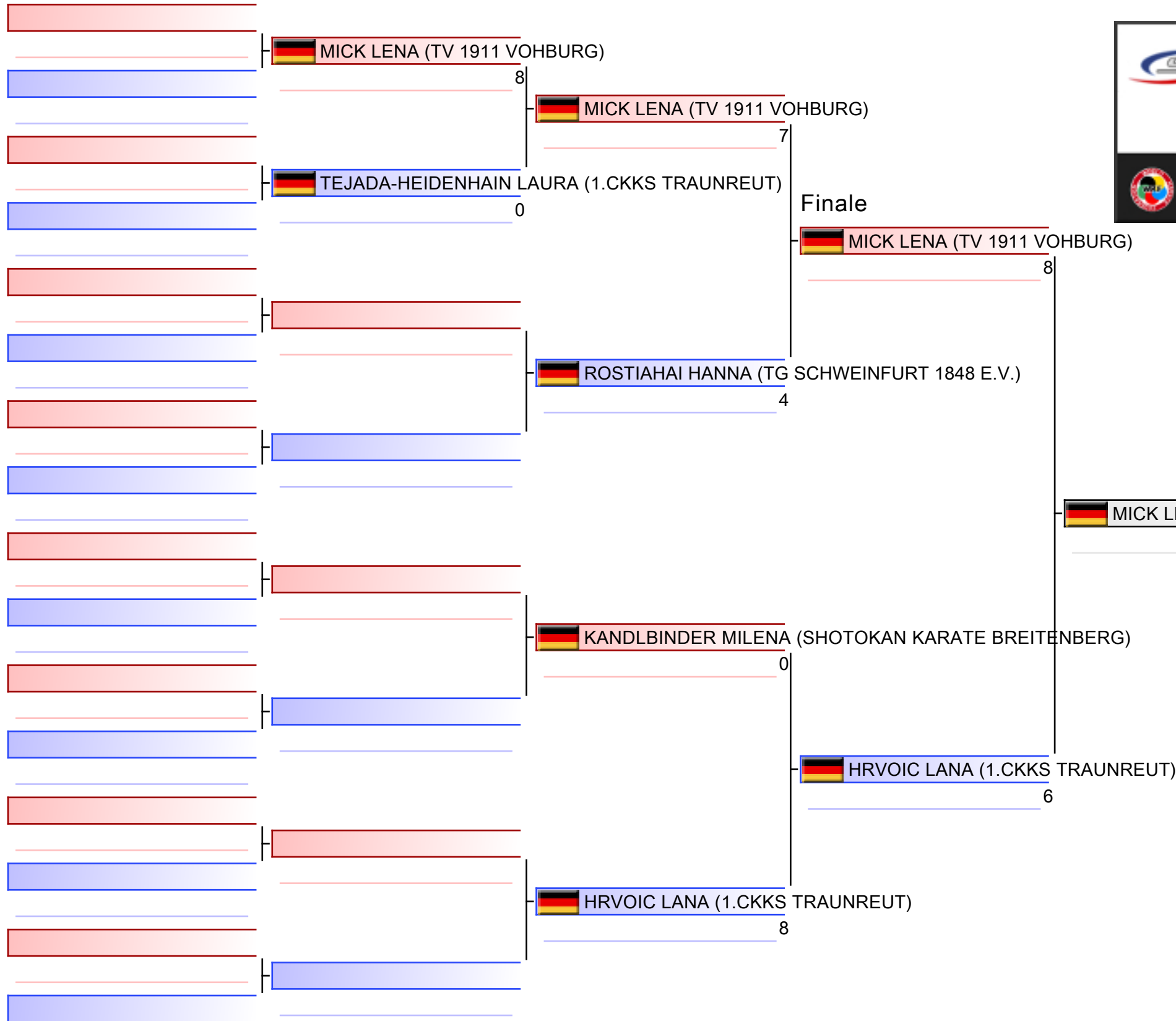

1. MICK LENA (TV 1911 VOHBURG)
2. HRVOIC LANA (1.CKKS TRAUNREUT)
3. KANDBINDER MILENA (SHOTOKAN KARATE BREITENBERG)
3. ROSTIAHAI HANNA (TG SCHWEINFURT 1848 E.V.)
5. TEJADA-HEIDENHAIN LAURA (1.CKKS TRAUNREUT)

Kumite Leistungsklasse -68 kg weiblich

Bayerische Meisterschaft Schüler - LK 2023

2023-02-11

Tatami
1 18:10

Pool
1

(c)sportdata GmbH & Co KG 2000-2023 (2023-02-12 15:58) v 10.0.0 build 1 (2023-01-21) Lizenz: Online_Event_ID-6952_BayerischeMeisterschaftSchlerLK2023 (expire 2023-02-26)

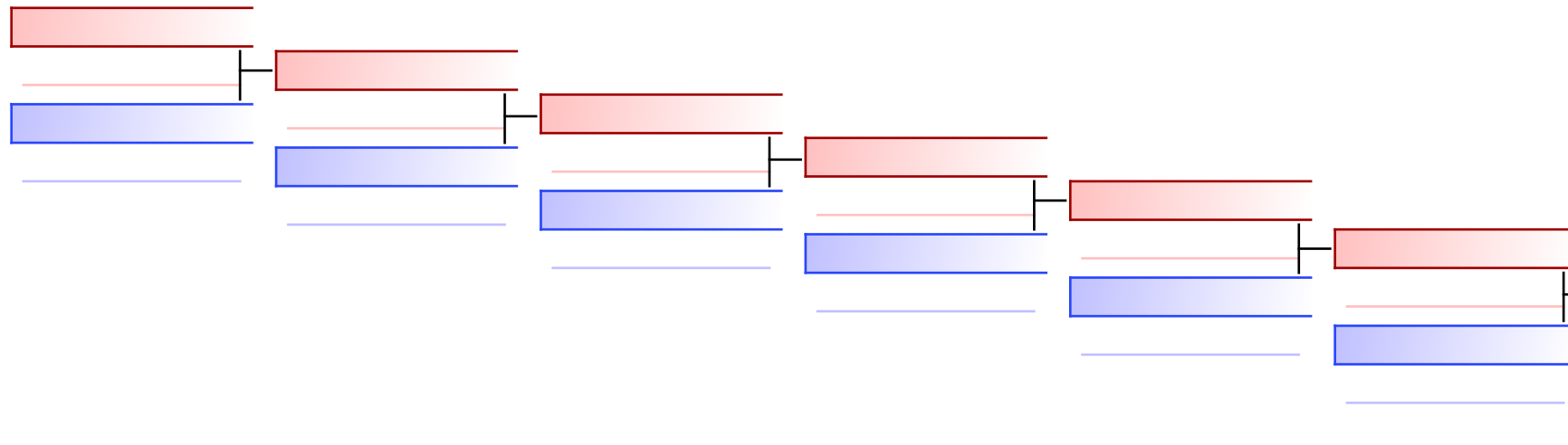

TEJADA-HEIDENHAIN LAURA (1.CKKS TRAUNREUT)
0
 ROSTIAHAI HANNA (TG SCHWEINFURT 1848 E.V.)
8

TROSTRUNDE: (1)

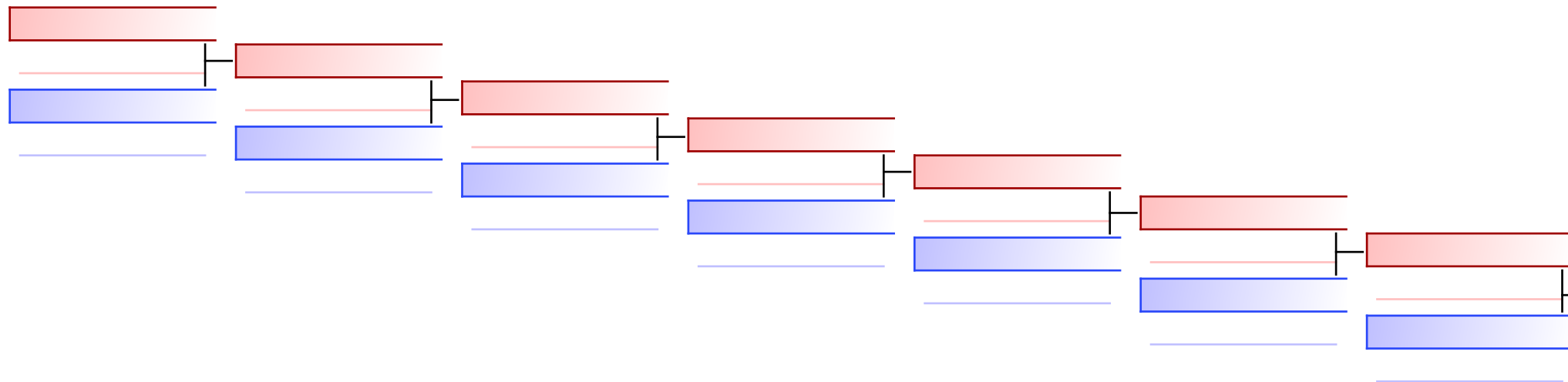

KANDLBINDER MILENA (SHOTOKAN)

Kumite Leistungsklasse -75 kg männlich

Bayerische Meisterschaft Schüler - LK 2023, Jahnstraße 6, 84508 Burgkirchen an der Alz, GER

2023-02-11

Tatami
1 18:30

Pool
1/1

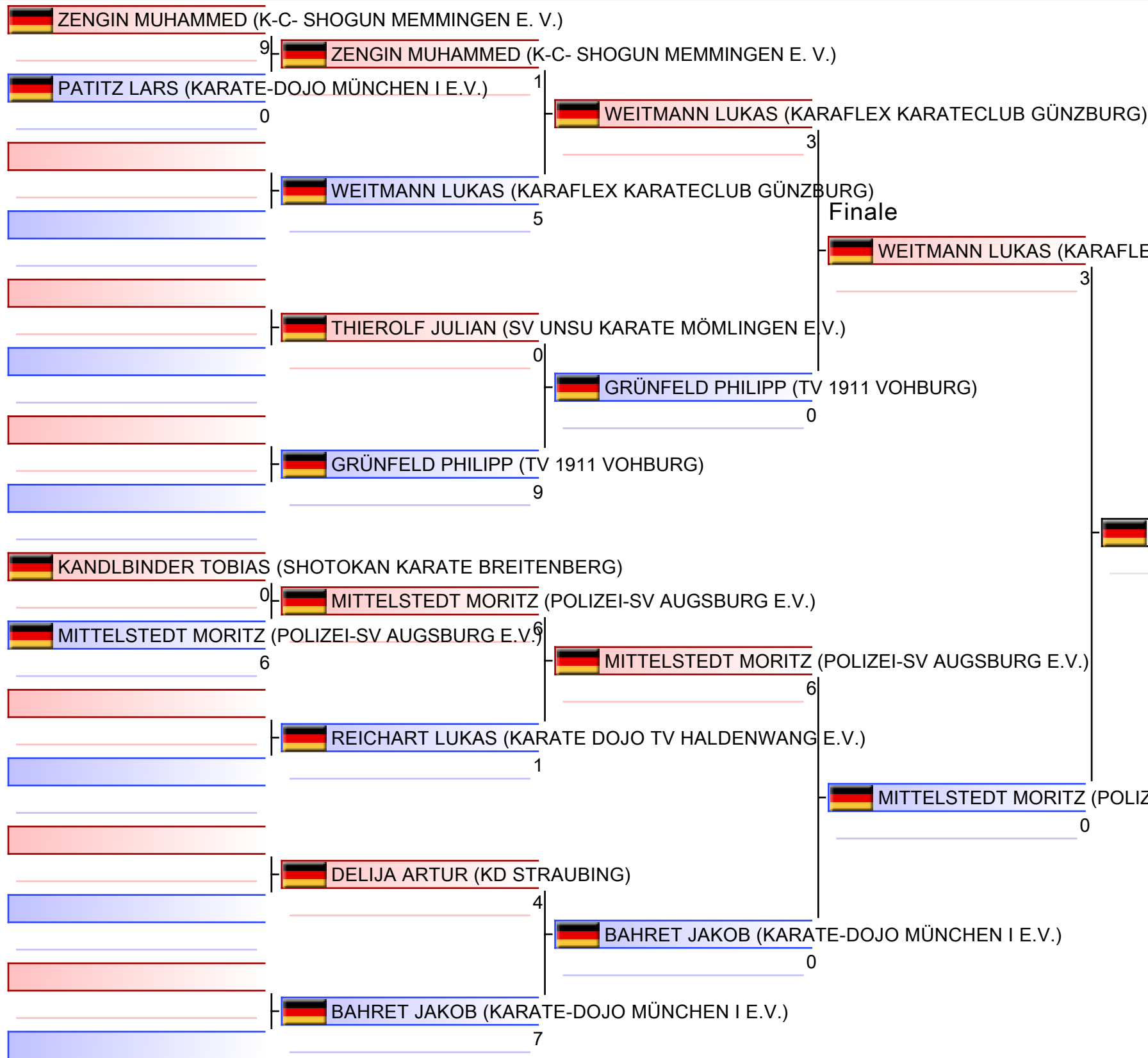

1. WEITMANN LUKAS (KARAFLEX KARATECLUB GÜNZBURG)
2. MITTELSTEDT MORITZ (POLIZEI-SV AUGSBURG E.V.)
3. GRÜNFELD PHILIPP (TV 1911 VOHBURG)
3. BAHRET JAKOB (KARATE-DOJO MÜNCHEN I E.V.)
5. ZENGIN MUHAMMED (K-C- SHOGUN MEMMINGEN E.V.)
5. KANDBINDER TOBIAS (SHOTOKAN KARATE BREITENBERG)
7. REICHART LUKAS (KARATE DOJO TV HALDENWANG E.V.)

Kumite Leistungsklasse -75 kg männlich

Bayerische Meisterschaft Schüler - LK 2023

2023-02-11

Tatami
1 19:20

Pool
1

(c)sportdata GmbH & Co KG 2000-2023 (2023-02-12 15:58) v 10.0.0 build 1 (2023-01-21) Lizenz: Online_Event_ID-6952_BayerischeMeisterschaftSchlerLK2023 (expire 2023-02-26)



ZENGIN MUHAMMED (K-C- SHOGUN MEMMINGEN E.
2
GRÜNFELD PHILIPP (TV 1911 VO
GRÜNFELD PHILIPP (TV 1911 VOHBURG)
2

TROSTRUNDE: (1)

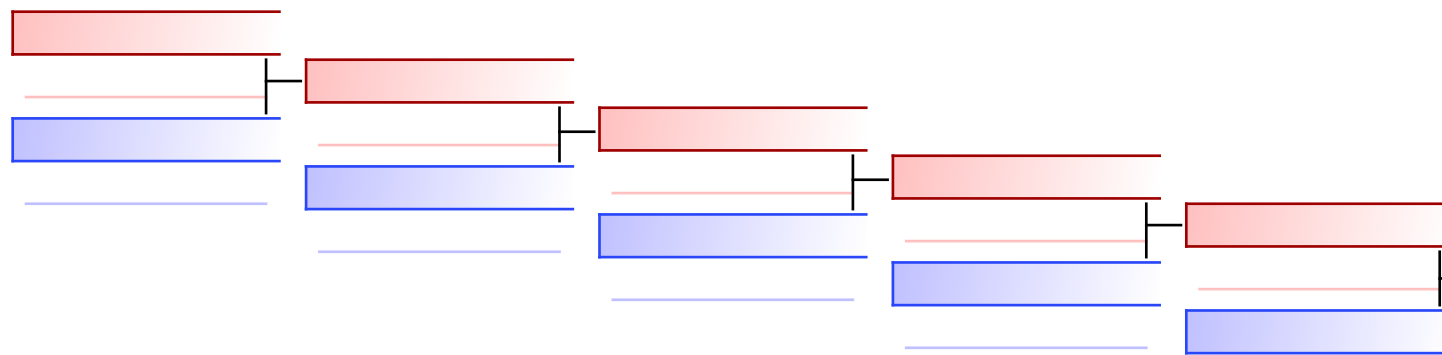

KANDLBINDER TOBIAS (SHOTOKAN KARATE BREITENBERG)
1
KANDLBINDER TOBIAS (SHOTOKAN KARATE BREITENBERG)
REICHART LUKAS (KARATE DOJO TV HABERWANGEN) 10
BAHR JAKOB (KARATE-DOJO MÜNCHEN I.E.V.)
0
BAHRET JAKOB (KARATE-DOJO MÜNCHEN I.E.V.)
0

Kumite Leistungsklasse -84 kg männlich

Bayerische Meisterschaft Schüler - LK 2023, Jahnstraße 6, 84508 Burgkirchen an der Alz, GER

2023-02-11

Tatami
2 18:40

Pool
1/1

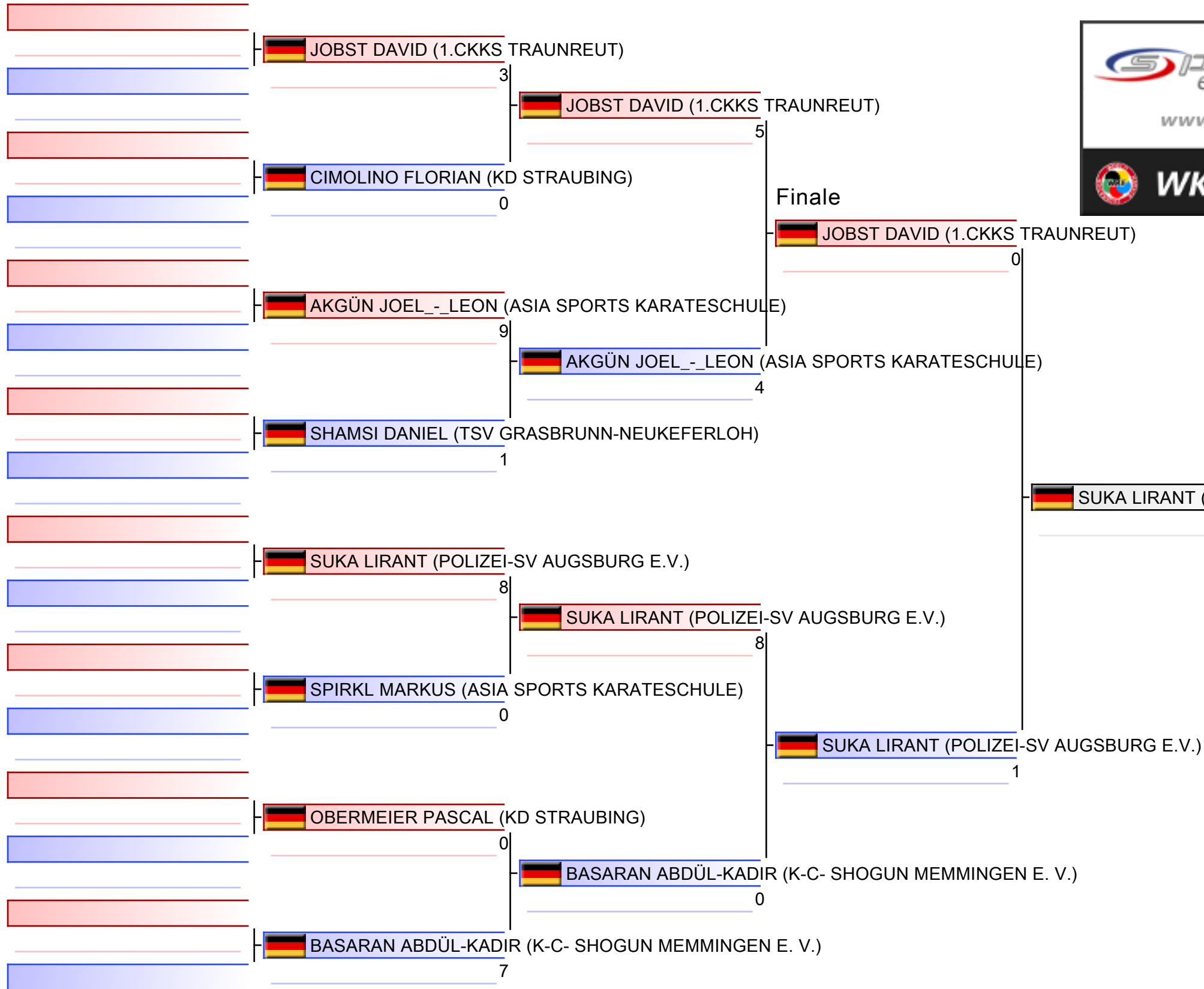

1. SUKA LIRANT (POLIZEI-SV AUGSBURG E.V.)
2. JOBST DAVID (1.CKKS TRAUNREUT)
3. AKGÜN JOEL_-LEON (ASIA SPORTS KARATESCHULE)
3. BASARAN ABDÜL-KADIR (K-C- SHOGUN MEMMINGEN E. V.)
5. CIMOLINO FLORIAN (KD STRAUBING)
5. SPIRKL MARKUS (ASIA SPORTS KARATESCHULE)

Kumite Leistungsklasse -84 kg männlich

Bayerische Meisterschaft Schüler - LK 2023

2023-02-11

Tatami
2 19:10

Pool
1

(c)sportdata GmbH & Co KG 2000-2023 (2023-02-12 15:58) v 10.0.0 build 1 (2023-01-21) Lizenz: Online_Event_ID-6952_BayerischeMeisterschaftSchlerLK2023 (expire 2023-02-26)

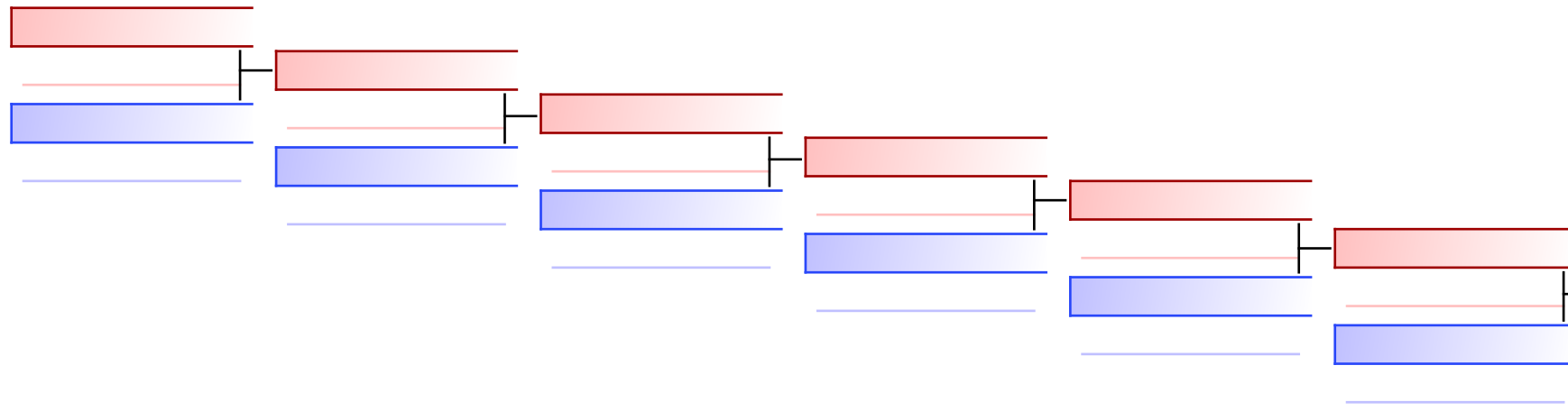

CIMOLINO FLORIAN (KD STRAUBING)
0
 AKGÜN JOEL_-LEON (ASIA SP...)
 AKGÜN JOEL_-LEON (ASIA SPORTS KARATESCHU...)
2

TROSTRUNDE: (1)

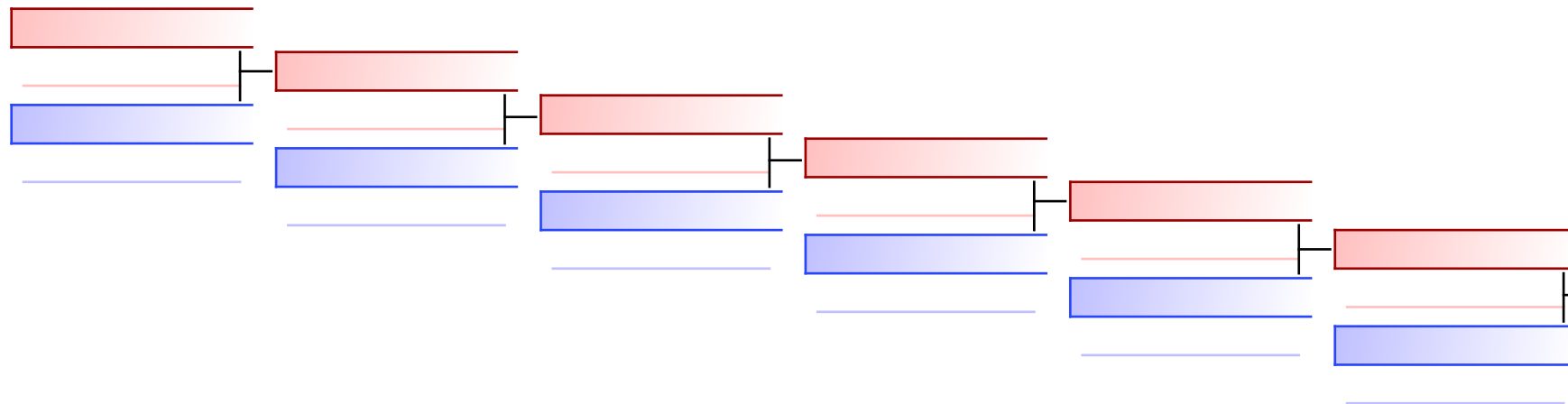

SPIRKL MARKUS (ASIA SPORTS KARATESCHULE)
0
 BASARAN ABDÜL-KADIR (K-C- S...)
 BASARAN ABDÜL-KADIR (K-C- SHOGUN MEMMINGE...)
8

Kumite Schüler A +49kg männlich

Bayerische Meisterschaft Schüler - LK 2023, Jahnstraße 6, 84508 Burgkirchen an der Alz, GER

2023-02-11

Tatami
3 13:20

Pool
1/1

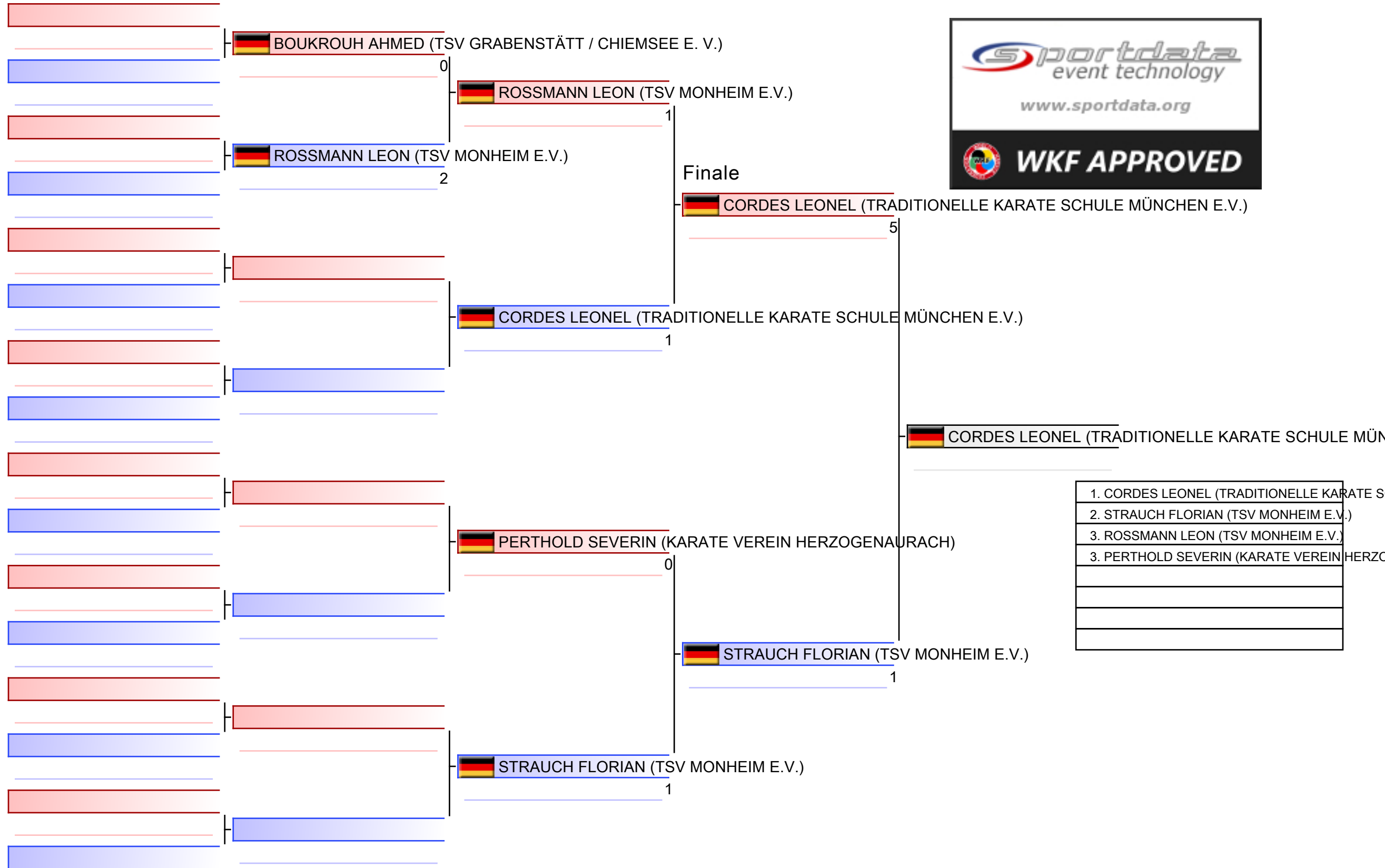

Kumite Schüler A +49kg männlich

Bayerische Meisterschaft Schüler - LK 2023

2023-02-11

Tatami
3 13:35

Pool
1

(c)sportdata GmbH & Co KG 2000-2023 (2023-02-12 15:58) v 10.0.0 build 1 (2023-01-21) Lizenz: Online_Event_ID-6952_BayerischeMeisterschaftSchlerLK2023 (expire 2023-02-26)

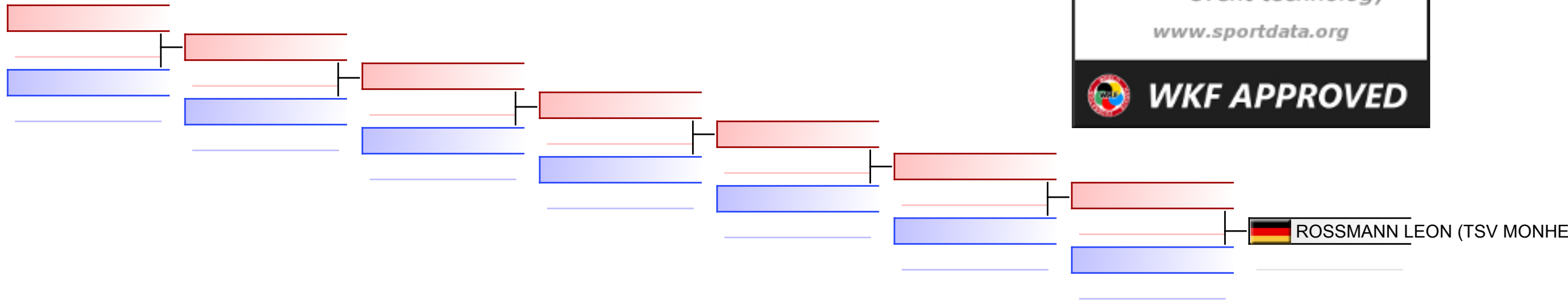

TROSTRUNDE: (1)

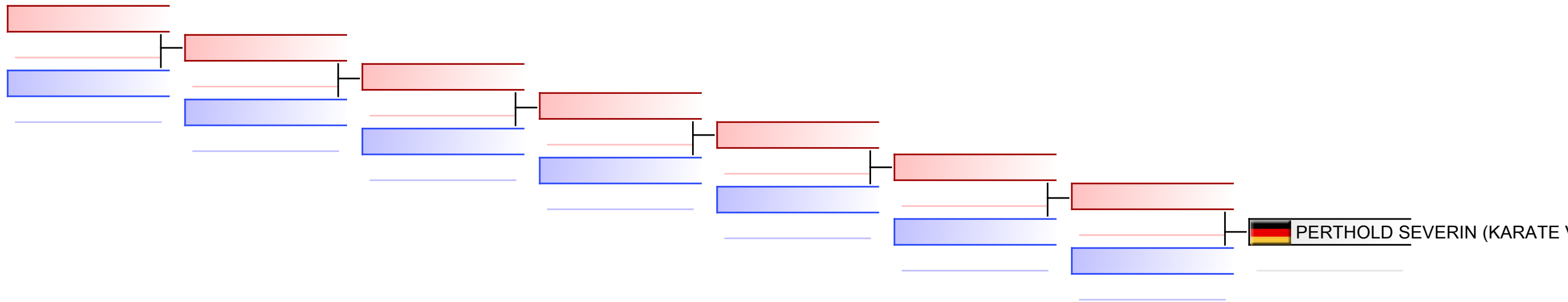

Kumite Schüler A +49kg weiblich

Bayerische Meisterschaft Schüler - LK 2023, Jahnstraße 6, 84508 Burgkirchen an der Alz, GER

2023-02-11

Tatami
1 13:20

Pool
1/1

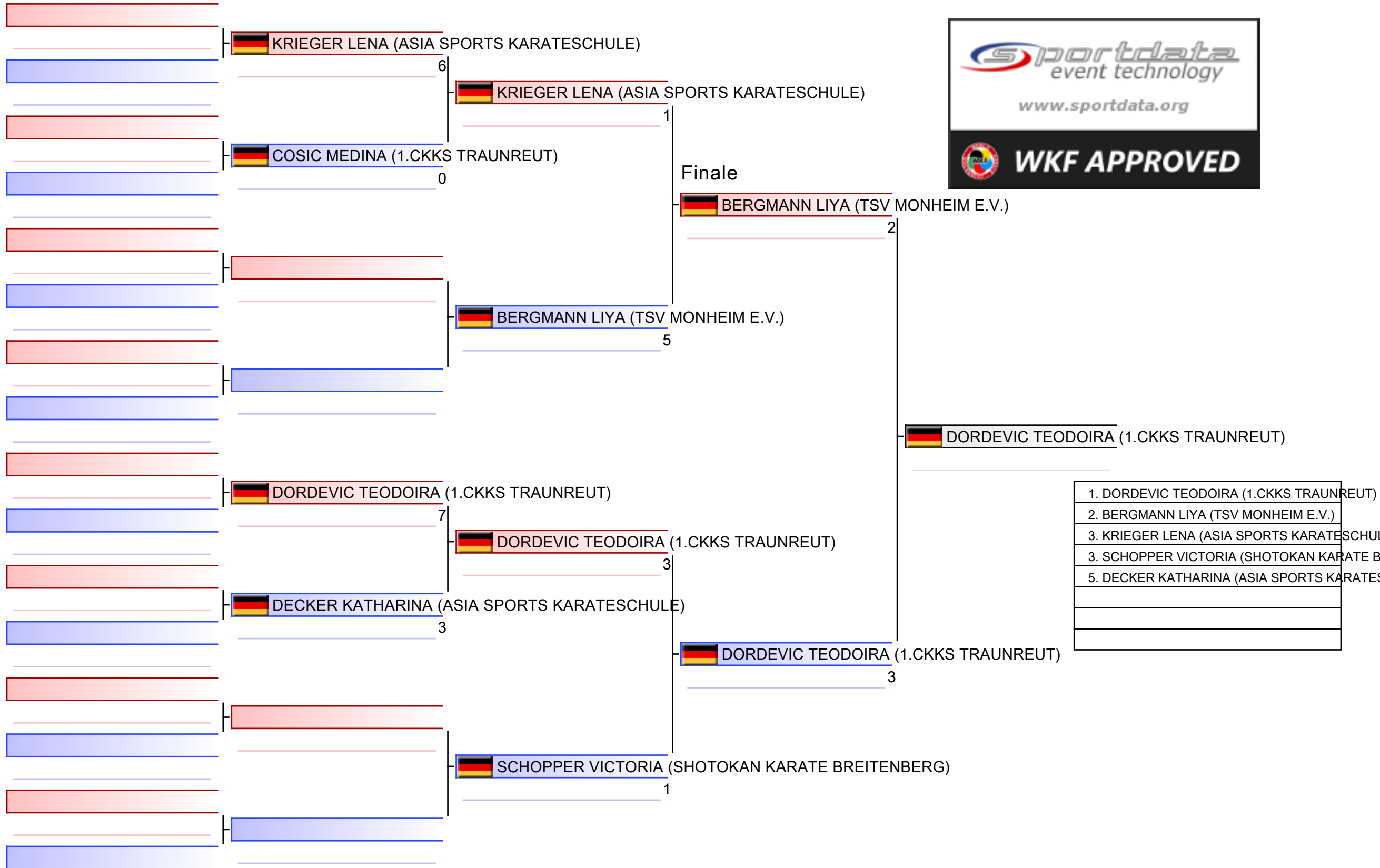

Kumite Schüler A +49kg weiblich

Bayerische Meisterschaft Schüler - LK 2023

2023-02-11

Tatami
1 13:35

Pool
1

(c)sportdata GmbH & Co KG 2000-2023 (2023-02-12 15:58) v 10.0.0 build 1 (2023-01-21) Lizenz: Online_Event_ID-6952_BayerischeMeisterschaftSchlerLK2023 (expire 2023-02-26)

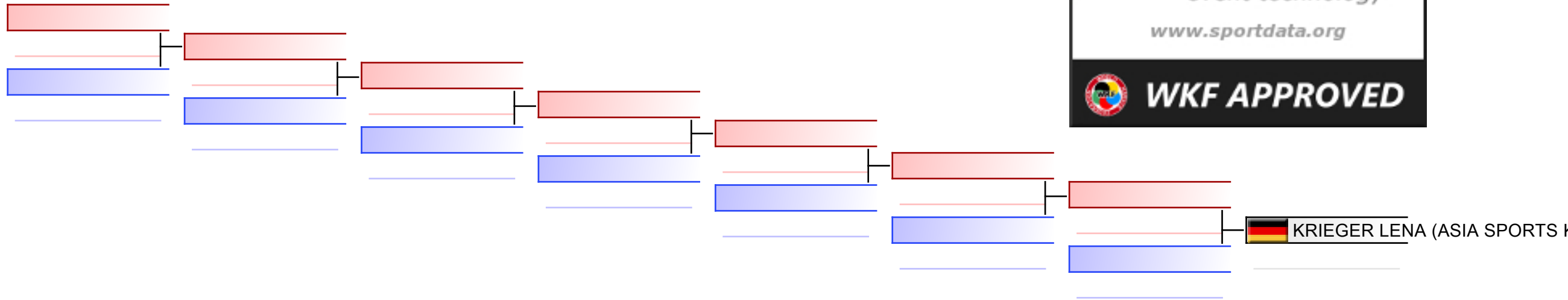

TROSTRUNDE: (1)

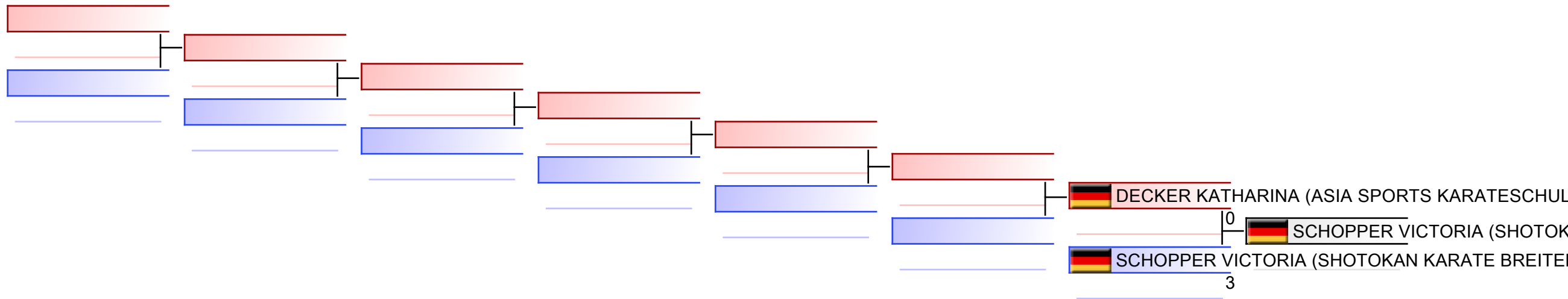

Kumite Schüler A -38kg männlich

Bayerische Meisterschaft Schüler - LK 2023, Jahnstraße 6, 84508 Burgkirchen an der Alz, GER

2023-02-11

Tatami
2 13:35

Pool
1/1

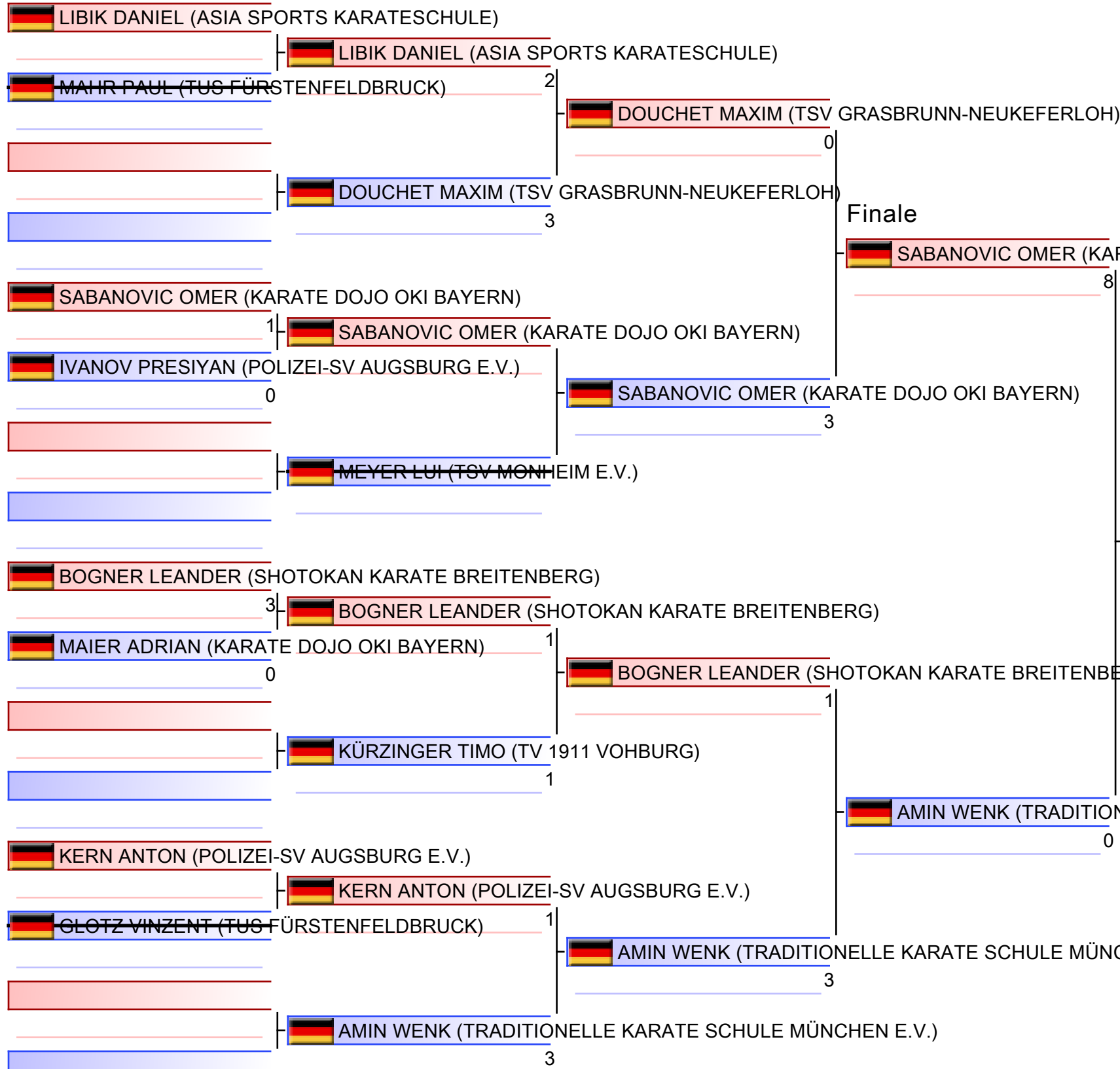

1.	SABANOVIC OMER (KARATE DOJO OKI BAYERN)
2.	AMIN WENK (TRADITIONELLE KARATE SCHULE MÜNCHEN E.V.)
3.	DOUCHET MAXIM (TSV GRASBRUNN-NEUKEFERLOH)
3.	BOGNER LEANDER (SHOTOKAN KARATE BREITENBERG)
5.	IVANOV PRESIYAN (POLIZEI-SV AUGSBURG E.V.)
5.	KERN ANTON (POLIZEI-SV AUGSBURG E.V.)

Kumite Schüler A -38kg männlich

Bayerische Meisterschaft Schüler - LK 2023

2023-02-11

Tatami
2 14:15

Pool
1

(c)sportdata GmbH & Co KG 2000-2023 (2023-02-12 15:58) v 10.0.0 build 1 (2023-01-21) Lizenz: Online_Event_ID-6952_BayerischeMeisterschaftSchlerLK2023 (expire 2023-02-26)



IVANOV PRESIYAN (POLIZEI-SV AUGSBURG E.V.)
1
DOUCHET MAXIM (TSV GRASBRUNN-NEUKEFERLOH)
3

TROSTRUNDE: (1)

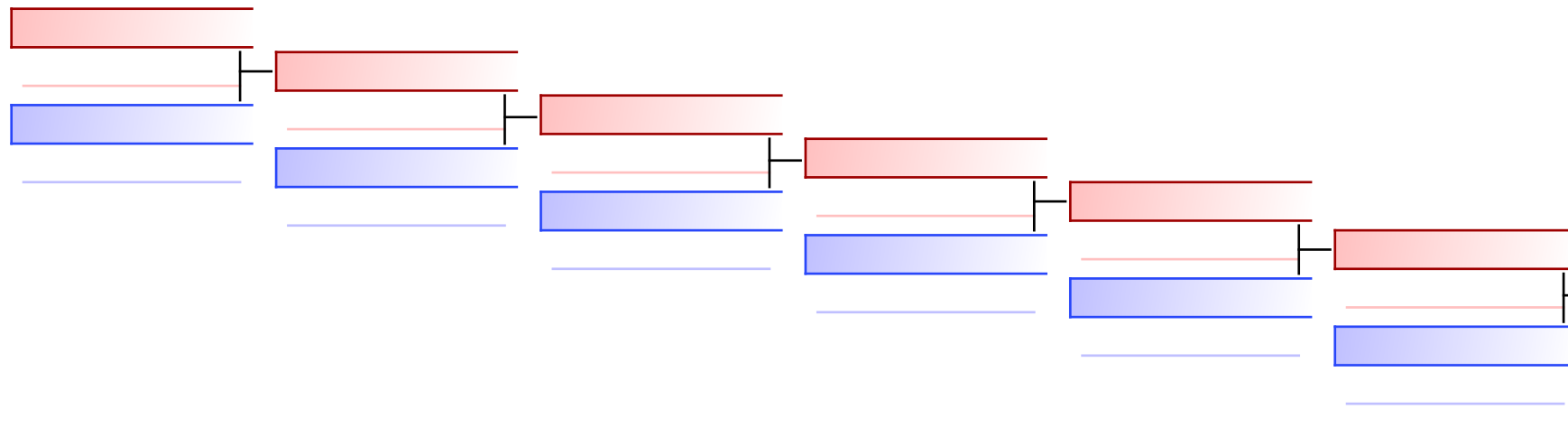

KERN ANTON (POLIZEI-SV AUGSBURG E.V.)
0
BOGNER LEANDER (SHOTOKAN KARATE BREITENBURG)
8

Kumite Schüler A -38kg weiblich

Bayerische Meisterschaft Schüler - LK 2023, Jahnstraße 6, 84508 Burgkirchen an der Alz, GER

2023-02-11

Tatami
3 13:50

Pool
1/1

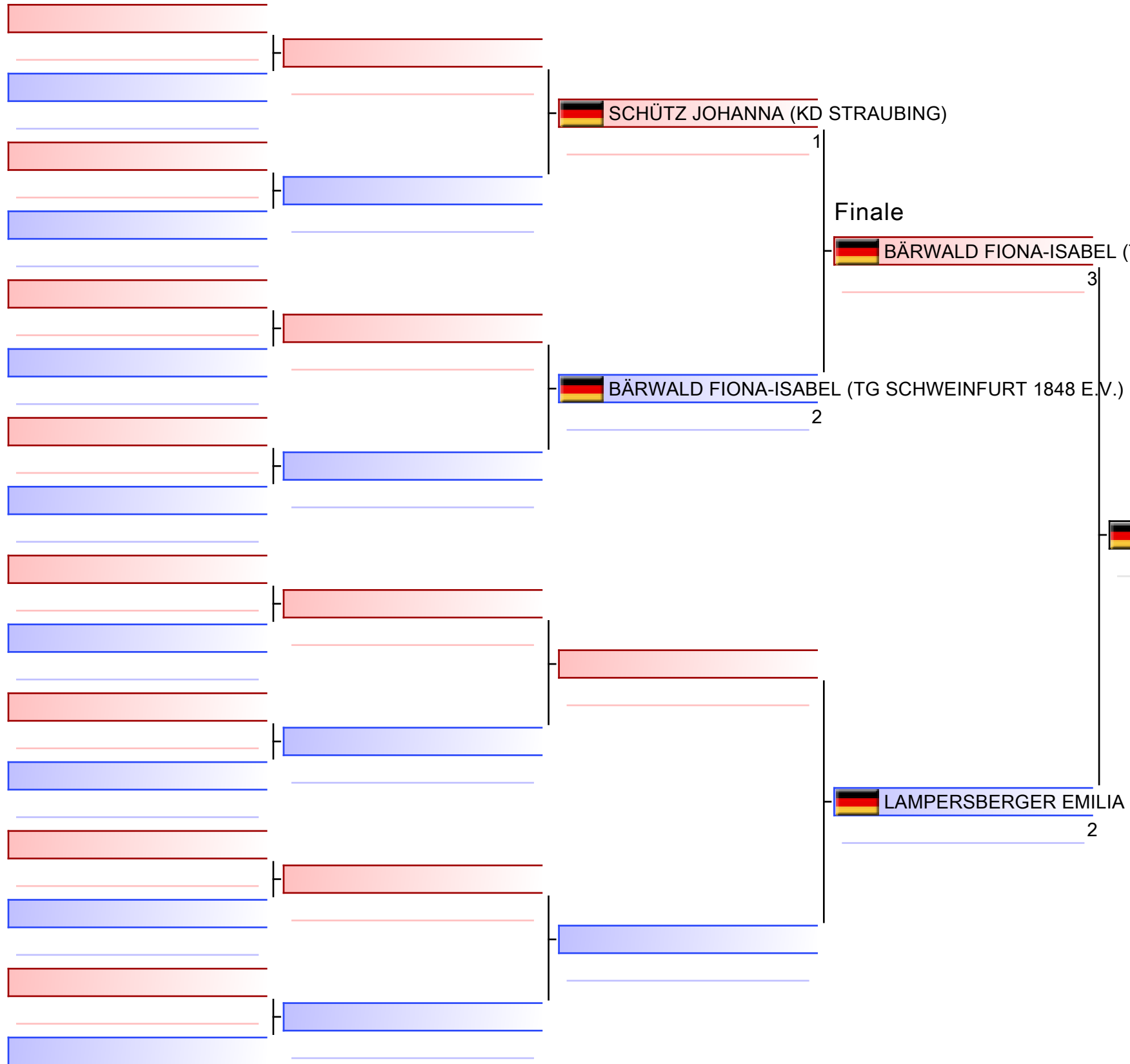

BÄRWALD FIONA-ISABEL (TG SCHWEINFURT 1848 E.V.)

1. BÄRWALD FIONA-ISABEL (TG SCHWEINFURT 1848 E.V.)
2. LAMPERSBERGER EMILIA (TSV GRABENSTÄTT / CHIEMSEE E. V.)
3. SCHÜTZ JOHANNA (KD STRAUBING)

Kumite Schüler A -38kg weiblich

Bayerische Meisterschaft Schüler - LK 2023

Tatami

Pool
1

(c)sportdata GmbH & Co KG 2000-2023 (2023-02-12 15:58) v 10.0.0 build 1 (2023-01-21) Lizenz: Online_Event_ID-6952_BayerischeMeisterschaftSchlerLK2023 (expire 2023-02-26)

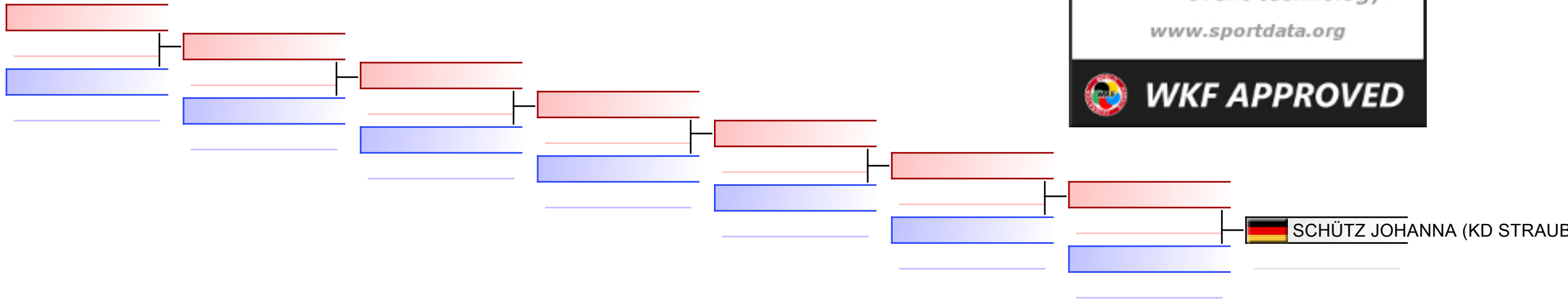

TROSTRUNDE: (1)

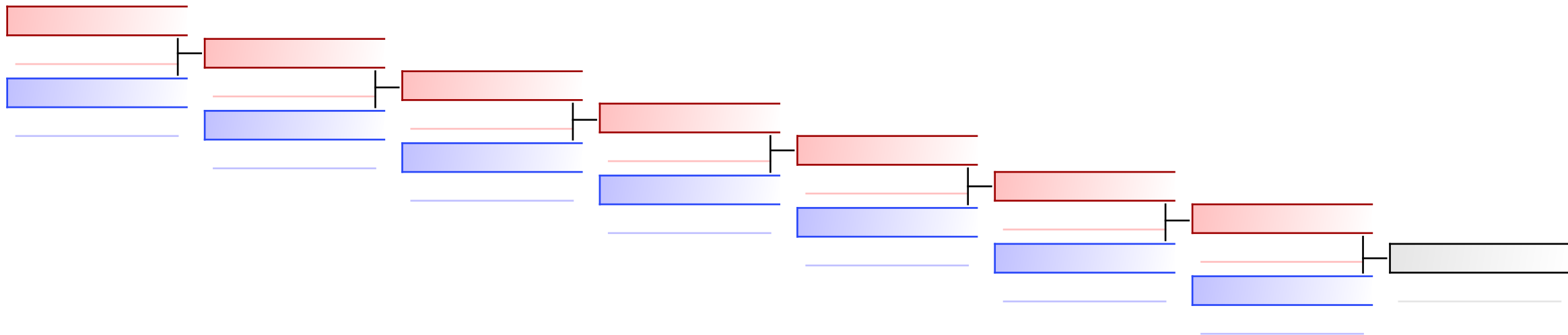

Kumite Schüler A -44kg männlich

Bayerische Meisterschaft Schüler - LK 2023, Jahnstraße 6, 84508 Burgkirchen an der Alz, GER

2023-02-11

Tatami
1 13:50

Pool
1/1

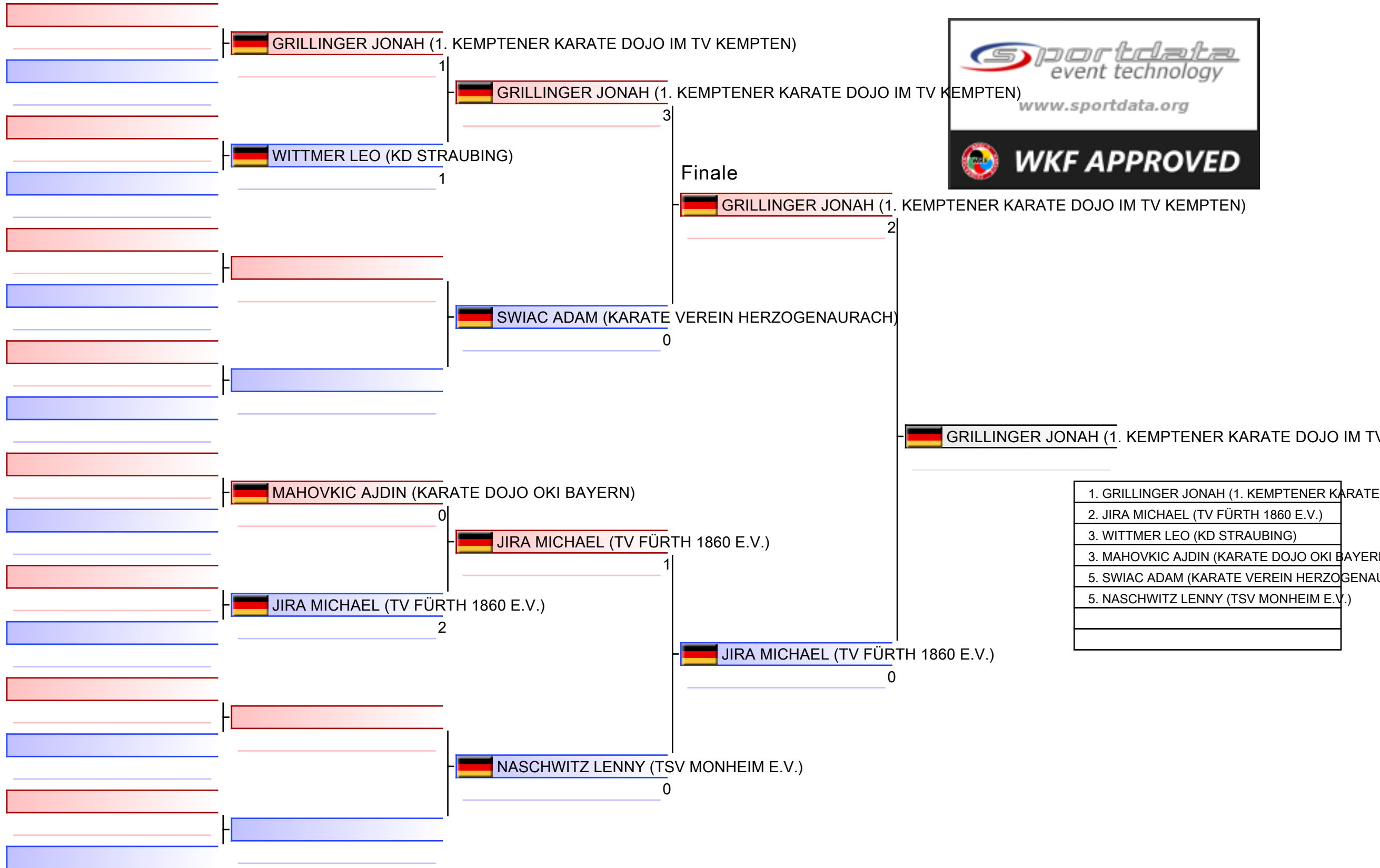

1. GRILLINGER JONAH (1. KEMPTENER KARATE DOJO IM TV KEMPTEN)
2. JIRA MICHAEL (TV FÜRTH 1860 E.V.)
3. WITTMER LEO (KD STRAUBING)
3. MAHOVKIC AJDIN (KARATE DOJO OKI BAYERN)
5. SWIAC ADAM (KARATE VEREIN HERZOGENAURACH)
5. NASCHWITZ LENNY (TSV MONHEIM E.V.)

Kumite Schüler A -44kg männlich

Bayerische Meisterschaft Schüler - LK 2023

2023-02-11

Tatami
1 14:05

Pool
1

(c)sportdata GmbH & Co KG 2000-2023 (2023-02-12 15:58) v 10.0.0 build 1 (2023-01-21) Lizenz: Online_Event_ID-6952_BayerischeMeisterschaftSchlerLK2023 (expire 2023-02-26)

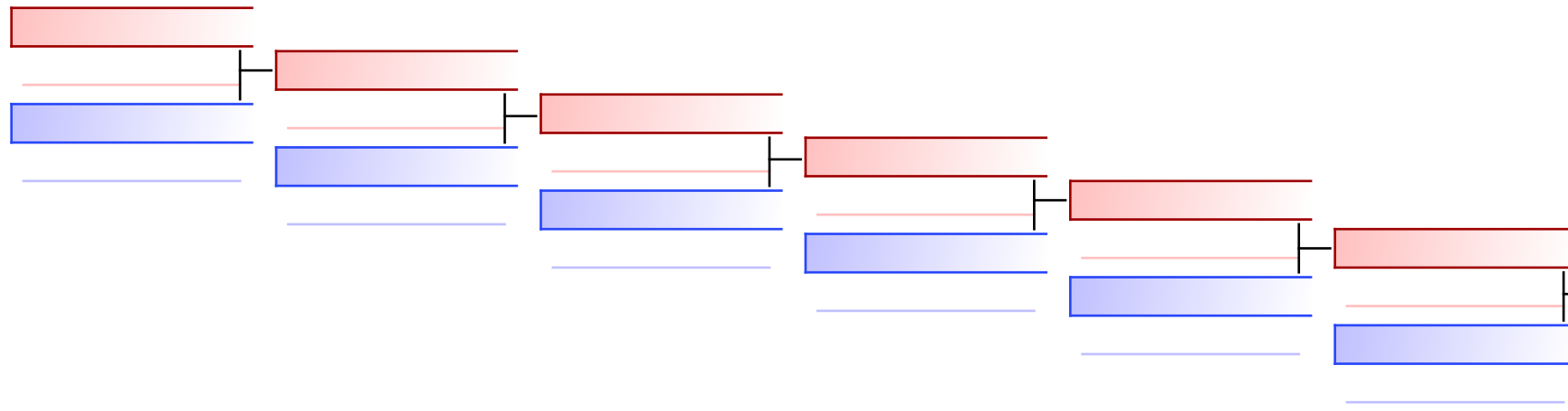

WITTMER LEO (KD STRAUBING) 4
WITTMER LEO (KD STRAUBING)
SWIAC ADAM (KARATE VEREIN HERZOGENAURACH) 0

TROSTRUNDE: (1)

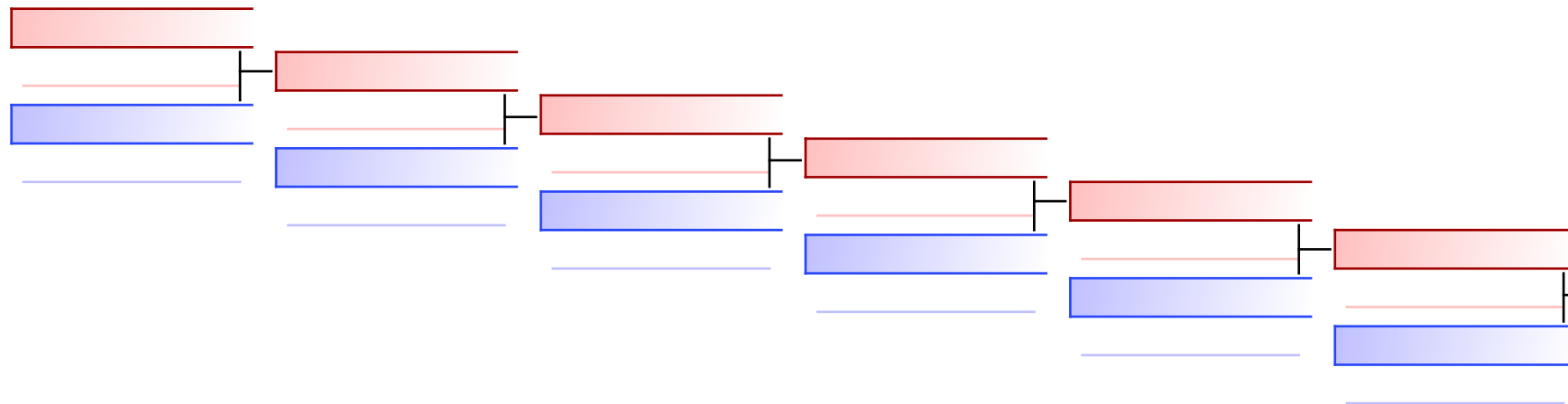

MAHOVKIC AJDIN (KARATE DOJO OKI BAYERN) 2
MAHOVKIC AJDIN (KARATE DOJ...
NASCHWITZ LENNY (TSV MONHEIM E.V.) 0

Kumite Schüler A -44kg weiblich

Bayerische Meisterschaft Schüler - LK 2023, Jahnstraße 6, 84508 Burgkirchen an der Alz, GER

2023-02-11

Tatami
3 14:00

Pool
1/1

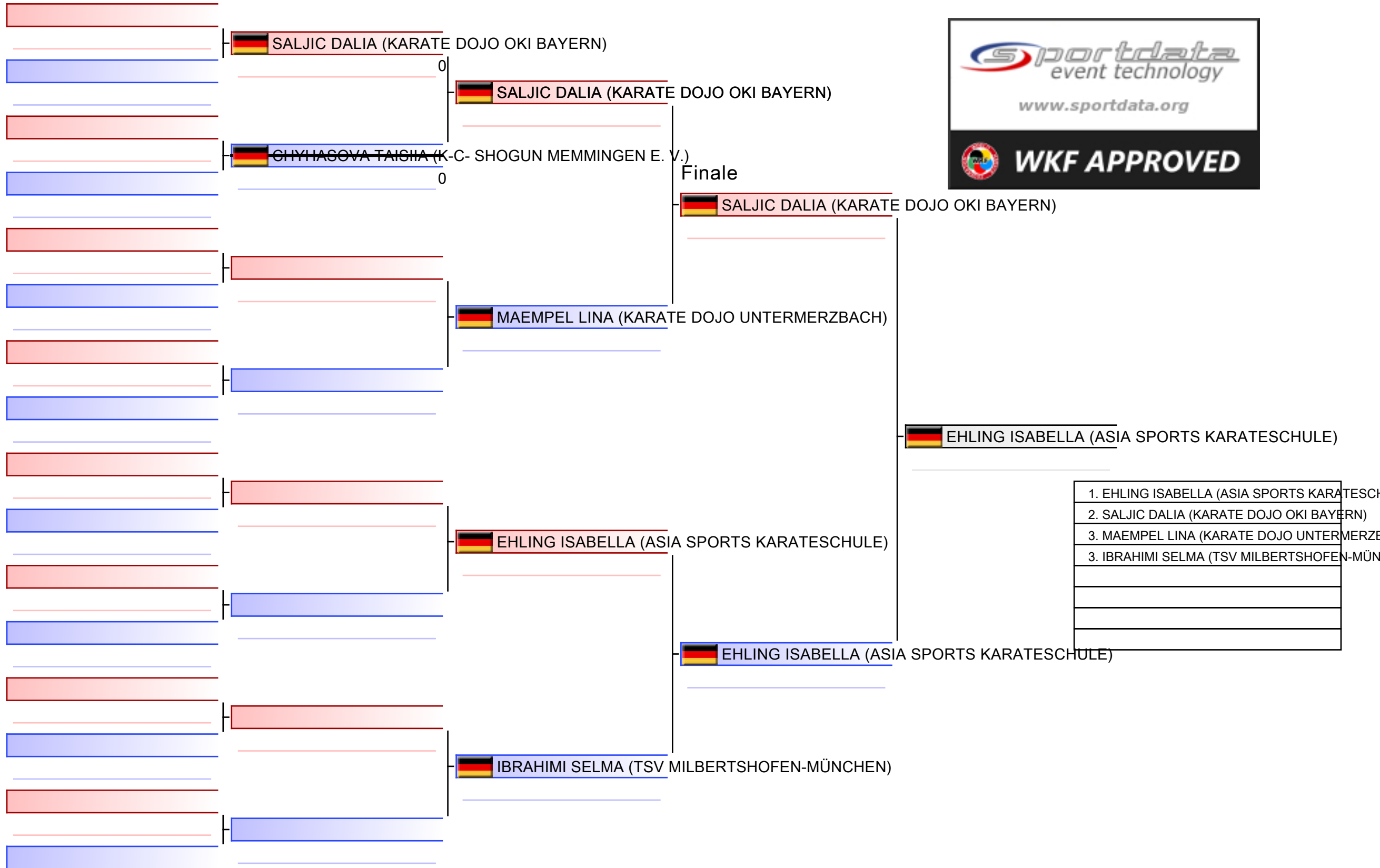

1. EHLING ISABELLA (ASIA SPORTS KARATESCHULE)
2. SALJIC DALIA (KARATE DOJO OKI BAYERN)
3. MAEMPEL LINA (KARATE DOJO UNTERMERZBACH)
3. IBRAHIMI SELMA (TSV MILBERTSHOFEN-MÜNCHEN)

Kumite Schüler A -44kg weiblich

Bayerische Meisterschaft Schüler - LK 2023

2023-02-11

Tatami
3 14:15

Pool
1

(c)sportdata GmbH & Co KG 2000-2023 (2023-02-12 15:58) v 10.0.0 build 1 (2023-01-21) Lizenz: Online_Event_ID-6952_BayerischeMeisterschaftSchlerLK2023 (expire 2023-02-26)

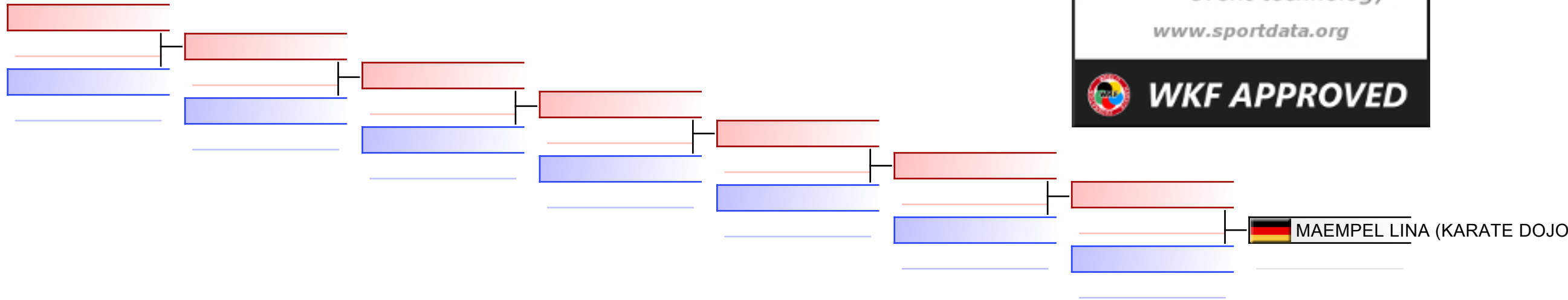

TROSTRUNDE: (1)

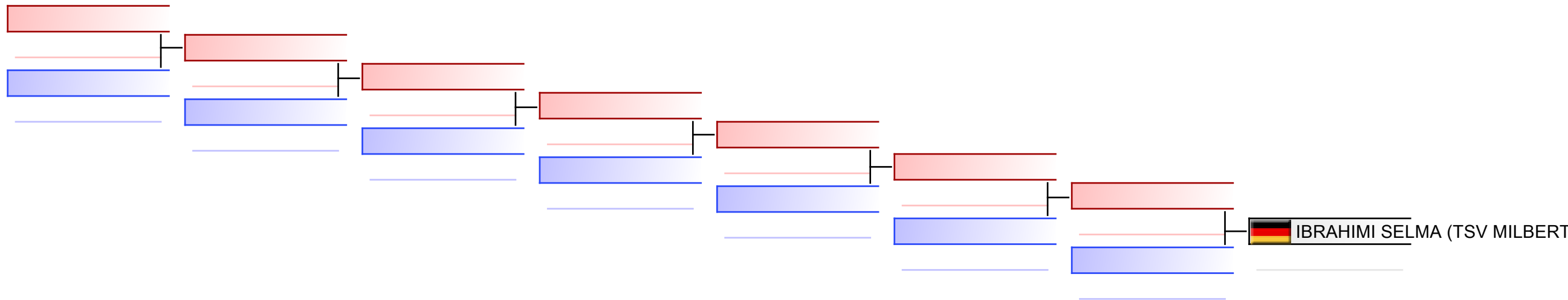

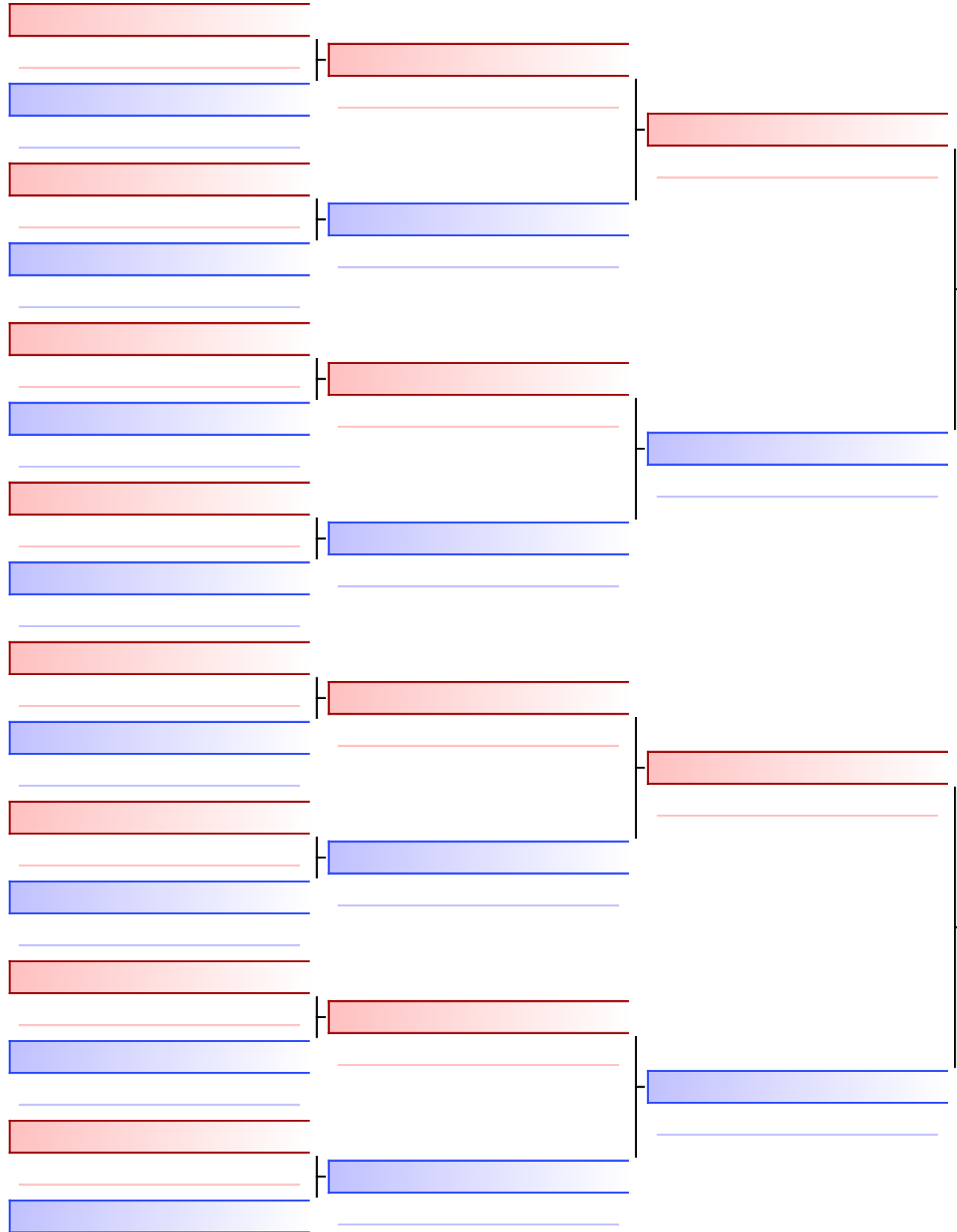

Finale

WEIDINGER JOSEF (SHOTOKAN KARATE BREITENBERG)

0

SABANOVIC SAID (KARATE DOJO OKI BAYERN)

SABANOVIC SAID (KARATE DOJO OKI BAYERN)

1

1. SABANOVIC SAID (KARATE DOJO OKI BAYERN)
2. WEIDINGER JOSEF (SHOTOKAN KARATE BREITENBERG)

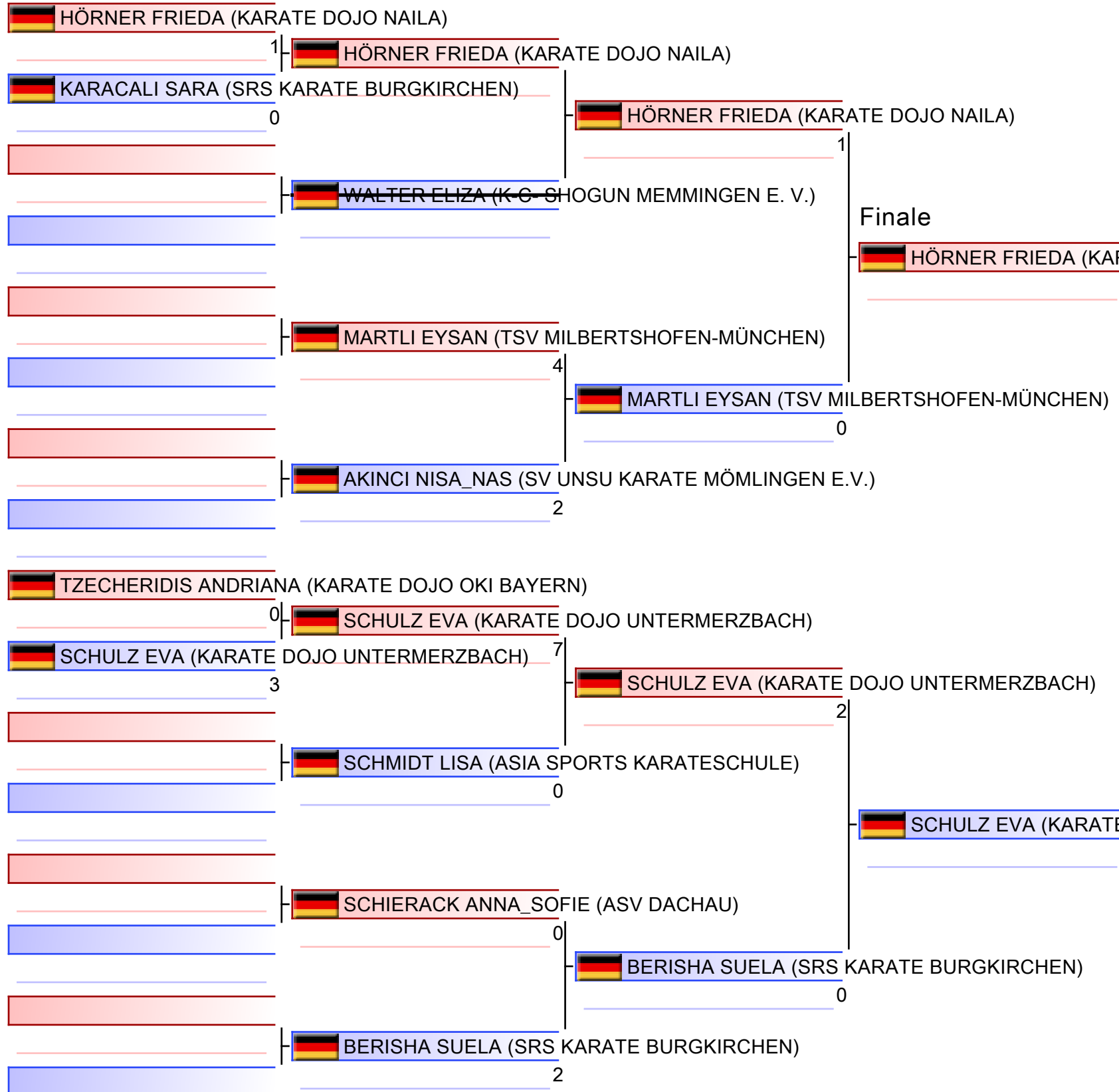

- | |
|--|
| 1. SCHULZ EVA (KARATE DOJO UNTERMERZBACH) |
| 2. HÖRNER FRIEDA (KARATE DOJO NAILA) |
| 3. MARTLI EYSAN (TSV MILBERTSHOFEN-MÜNCHEN) |
| 3. TZECHERIDIS ANDRIANA (KARATE DOJO OKI BAYERN) |
| 5. KARACALI SARA (SRS KARATE BURGKIRCHEN) |
| 5. BERISHA SUELA (SRS KARATE BURGKIRCHEN) |
| 7. SCHMIDT LISA (ASIA SPORTS KARATESCHULE) |

Kumite Schüler B +36kg weiblich

Bayerische Meisterschaft Schüler - LK 2023

2023-02-11

Tatami
2 12:10

Pool
1

(c)sportdata GmbH & Co KG 2000-2023 (2023-02-12 15:58) v 10.0.0 build 1 (2023-01-21) Lizenz: Online_Event_ID-6952_BayerischeMeisterschaftSchlerLK2023 (expire 2023-02-26)

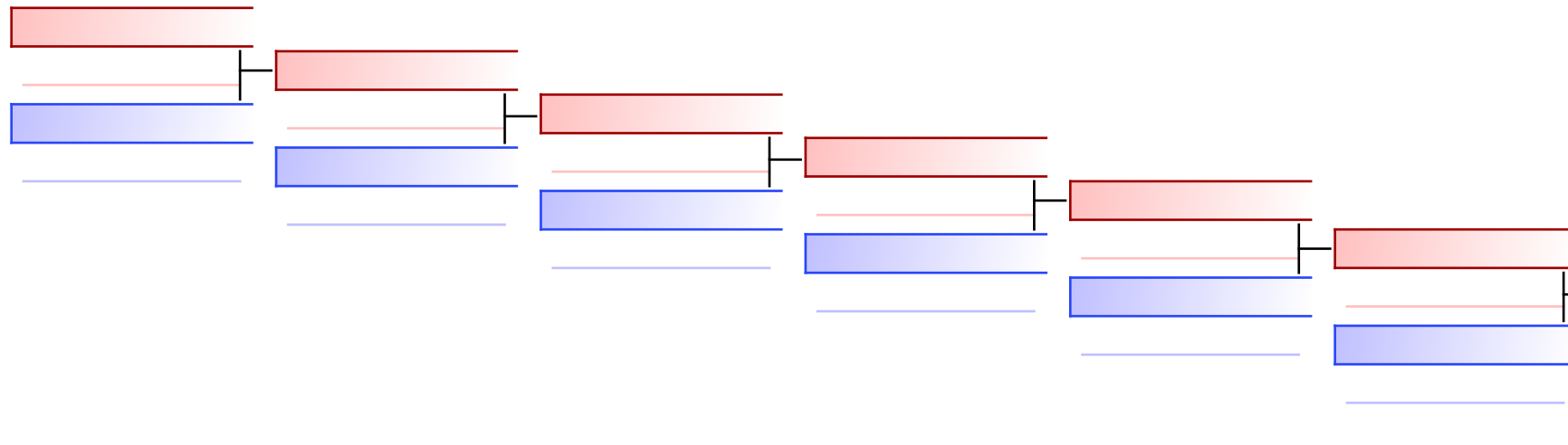

KARACALI SARA (SRS KARATE BURGKIRCHEN)
0
 MARTLI EYSAN (TSV MILBERTS
 MARTLI EYSAN (TSV MILBERTSHOFEN-MÜNCHEN)
6

TROSTRUNDE: (1)

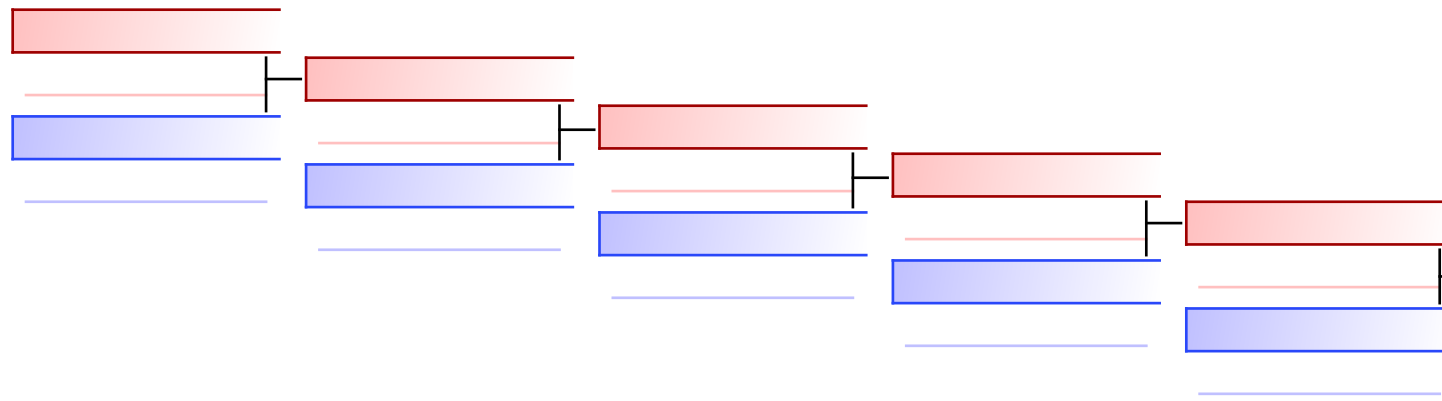

TZECHERIDIS ANDRIANA (KARATE DOJO OKI BAYERN)
5
 TZECHERIDIS ANDRIANA (KARATE DOJO OKI BAYER
 SCHMIDT LISA (ASIA SPORTS KARATE SCHLEIBACH)
0
 BERISHA SUELA (SRS KARATE BURGKIRCHEN)
0

Kumite Schüler B +38kg männlich

Bayerische Meisterschaft Schüler - LK 2023, Jahnstraße 6, 84508 Burgkirchen an der Alz, GER

2023-02-11

Tatami
3 11:50

Pool
1/1

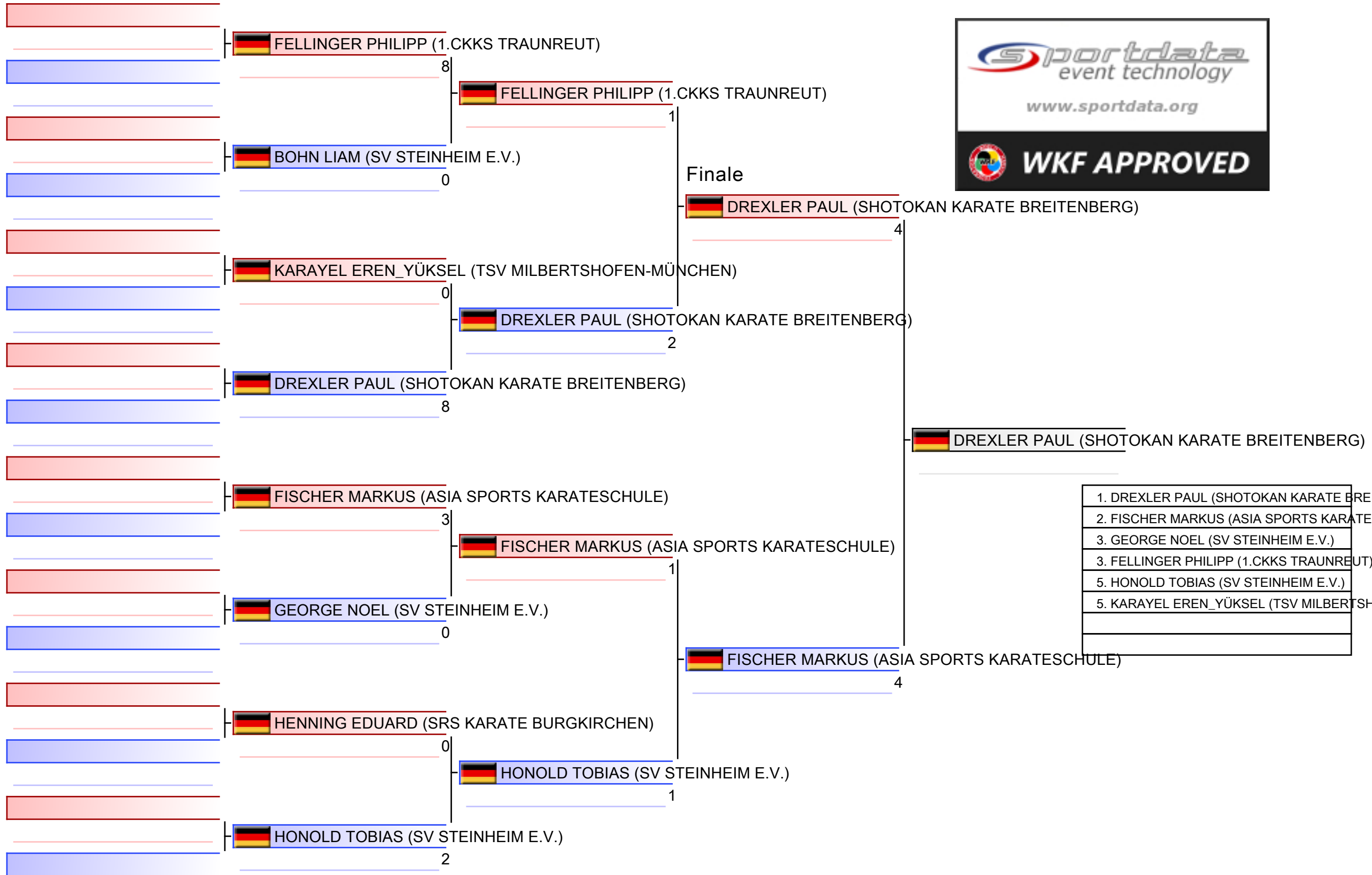

Kumite Schüler B +38kg männlich

Bayerische Meisterschaft Schüler - LK 2023

2023-02-11

Tatami
3 12:15

Pool
1

(c)sportdata GmbH & Co KG 2000-2023 (2023-02-12 15:58) v 10.0.0 build 1 (2023-01-21) Lizenz: Online_Event_ID-6952_BayerischeMeisterschaftSchlerLK2023 (expire 2023-02-26)

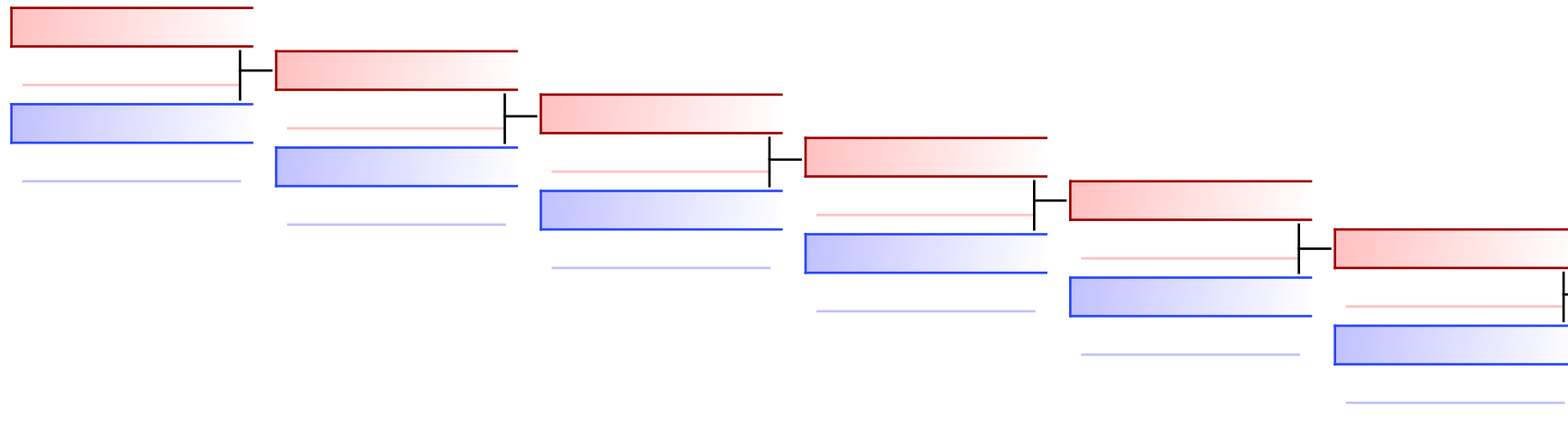

KARAYEL EREN_YÜKSEL (TSV MILBERTSHOFEN-MÜ...)
0
 FELLINGER PHILIPP (1.CKKS TR...)
 FELLINGER PHILIPP (1.CKKS TRAUNREUT)
9

TROSTRUNDE: (1)

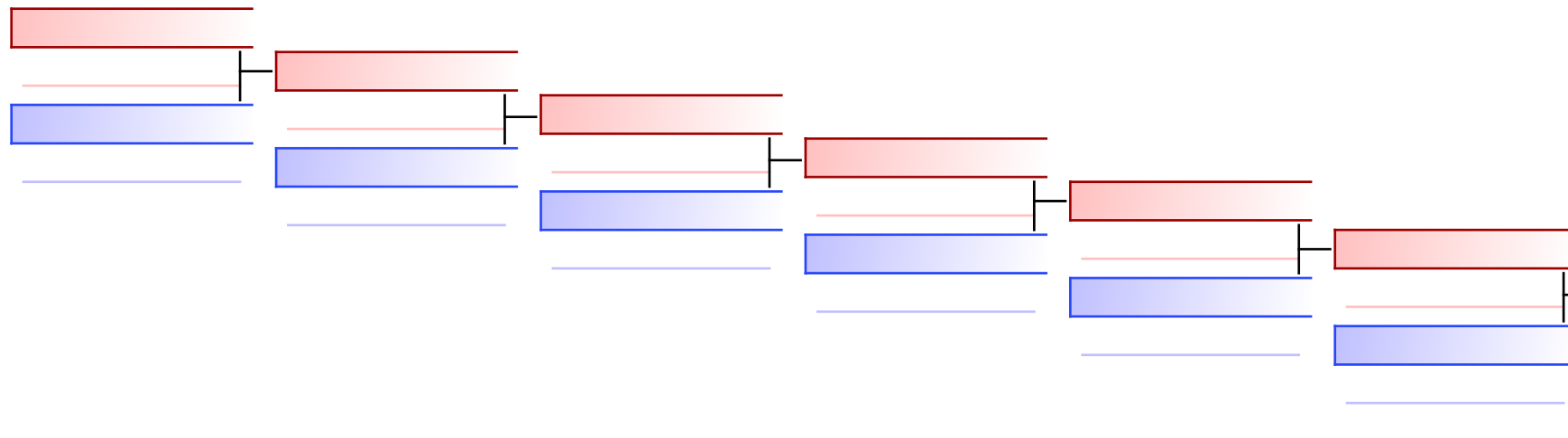

GEORGE NOEL (SV STEINHEIM E.V.)
4
 GEORGE NOEL (SV STEINHEIM E.V.)
 HONOLD TOBIAS (SV STEINHEIM E.V.)
2

Kumite Schüler B -30kg weiblich

Bayerische Meisterschaft Schüler - LK 2023, Jahnstraße 6, 84508 Burgkirchen an der Alz, GER

2023-02-11

Tatami
3 12:30

Pool
1/1

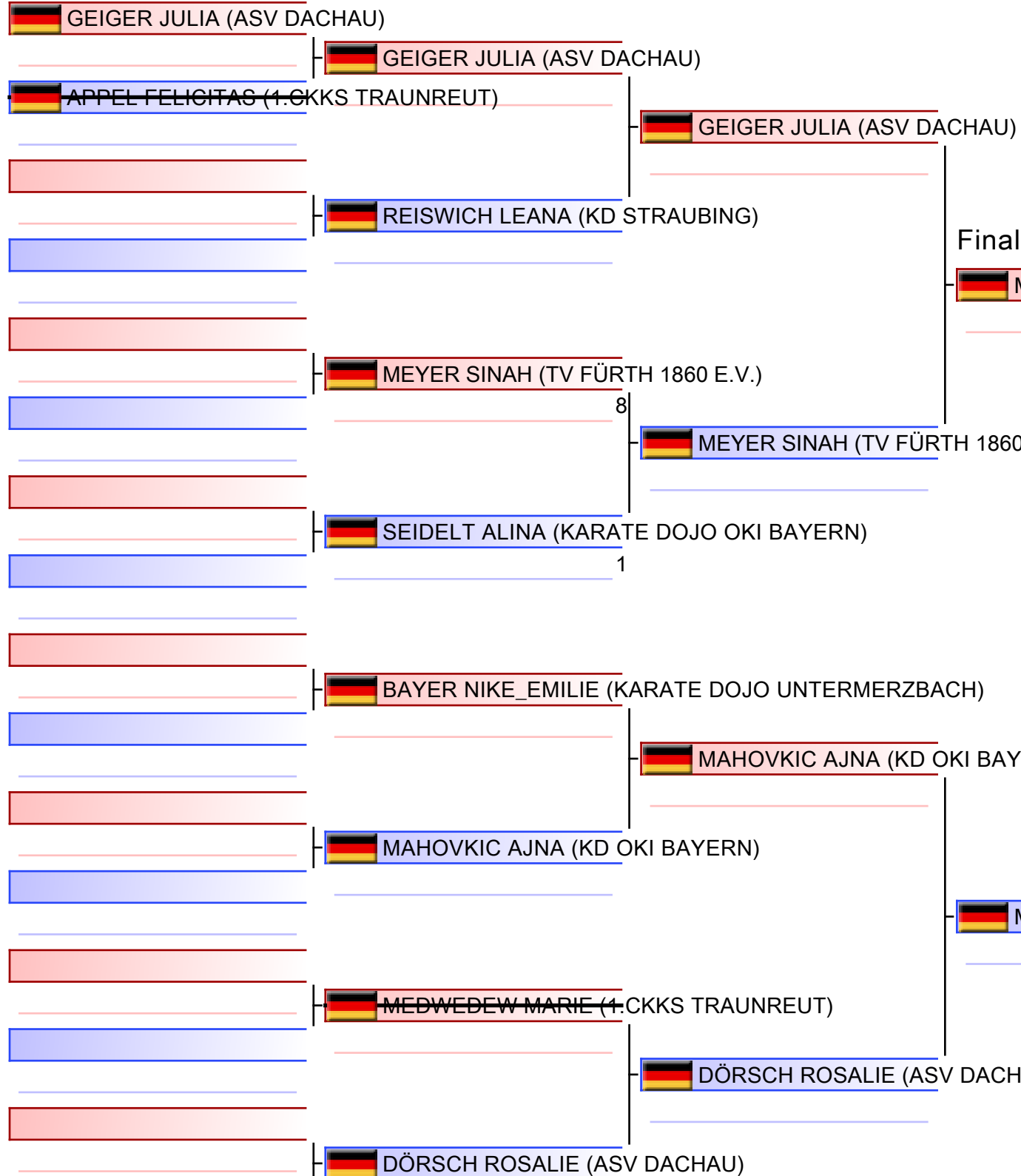

1. MAHOVKIC AJNA (KD OKI BAYERN)
2. MEYER SINAH (TV FÜRTH 1860 E.V.)
3. SEIDELT ALINA (KARATE DOJO OKI BAYERN)
3. DÖRSCH ROSALIE (ASV DACHAU)
5. BAYER NIKE_EMILIE (KARATE DOJO UNTERMERZBACH)
5. GEIGER JULIA (ASV DACHAU)

Kumite Schüler B -30kg weiblich

Bayerische Meisterschaft Schüler - LK 2023

2023-02-11

Tatami
3 13:00

Pool
1

(c)sportdata GmbH & Co KG 2000-2023 (2023-02-12 15:58) v 10.0.0 build 1 (2023-01-21) Lizenz: Online_Event_ID-6952_BayerischeMeisterschaftSchlerLK2023 (expire 2023-02-26)

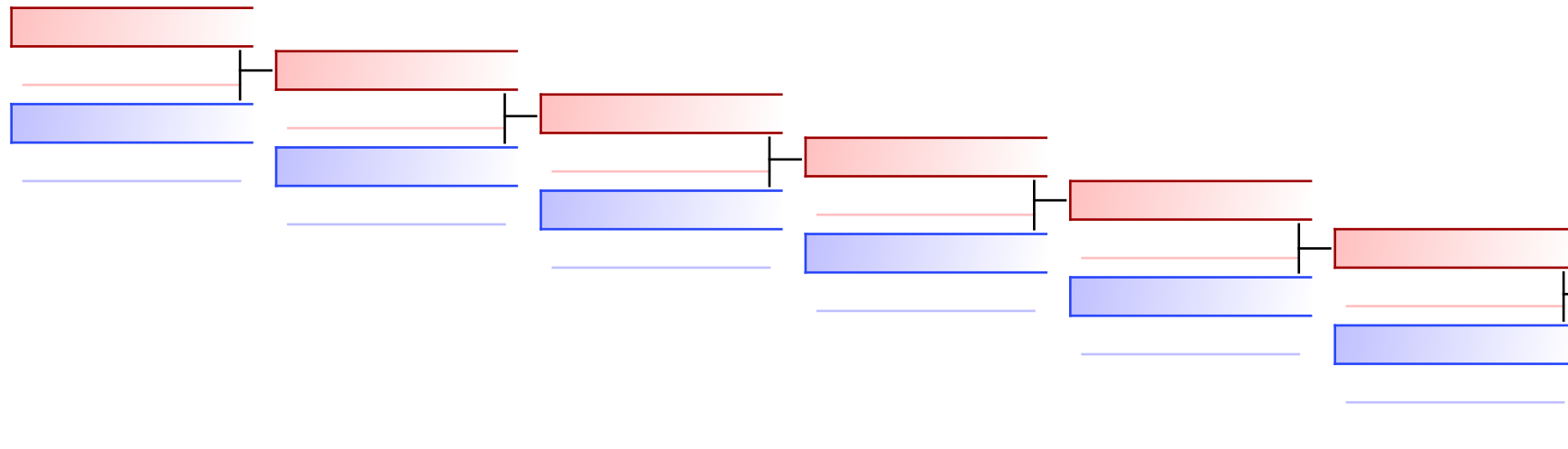

 SEIDELT ALINA (KARATE DOJO OKI BAYERN)

 SEIDELT ALINA (KARATE DOJO)

 GEIGER JULIA (ASV DACHAU)

TROSTRUNDE: (1)

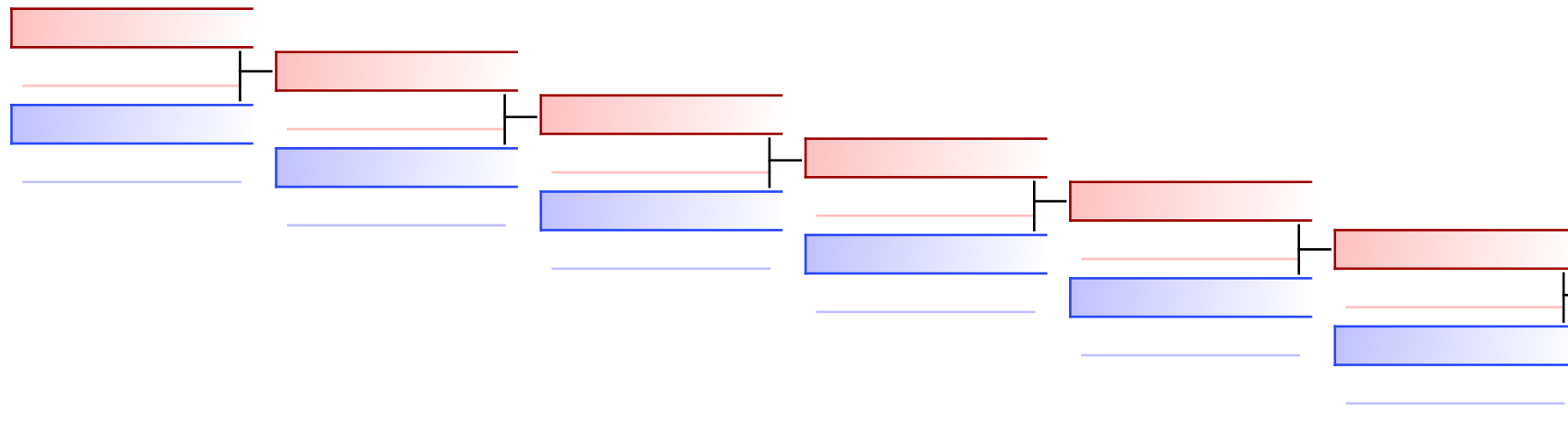

 BAYER NIKE_EMILIE (KARATE DOJO UNTERMERZBA)

0  DÖRSCH ROSALIE (ASV DACHAU)

 DÖRSCH ROSALIE (ASV DACHAU)

0

Kumite Schüler B -32kg männlich

Bayerische Meisterschaft Schüler - LK 2023, Jahnstraße 6, 84508 Burgkirchen an der Alz, GER

2023-02-11

Tatami
2 12:30

Pool
1/1

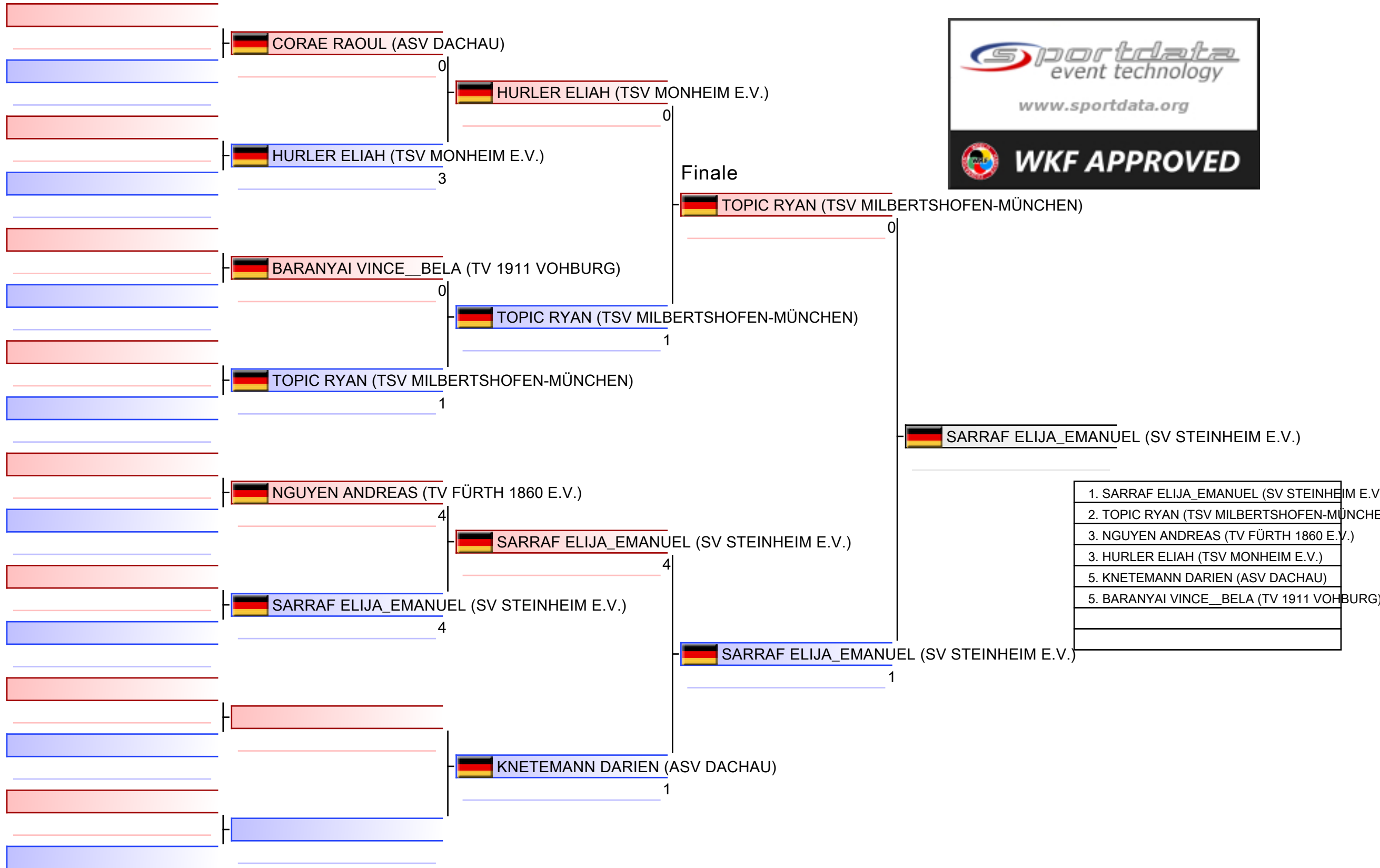

1. SARRAF ELIJA_EMANUEL (SV STEINHEIM E.V.)
2. TOPIC RYAN (TSV MILBERTSHOFEN-MÜNCHEN)
3. NGUYEN ANDREAS (TV FÜRTH 1860 E.V.)
3. HURLER ELIAH (TSV MONHEIM E.V.)
5. KNETEMANN DARIEN (ASV DACHAU)
5. BARANYAI VINCE_BELA (TV 1911 VOHBURG)

Kumite Schüler B -32kg männlich

Bayerische Meisterschaft Schüler - LK 2023

2023-02-11

Tatami
2 12:50

Pool
1

(c)sportdata GmbH & Co KG 2000-2023 (2023-02-12 15:58) v 10.0.0 build 1 (2023-01-21) Lizenz: Online_Event_ID-6952_BayerischeMeisterschaftSchlerLK2023 (expire 2023-02-26)

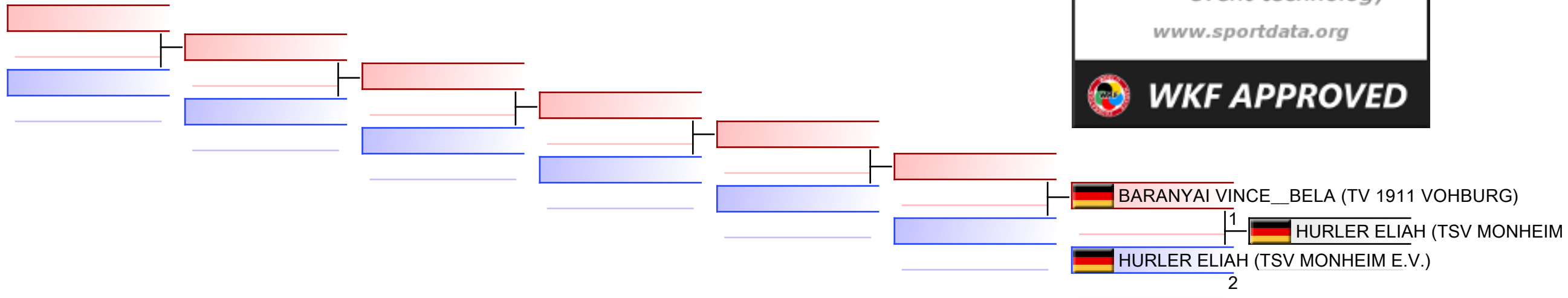

TROSTRUNDE: (1)

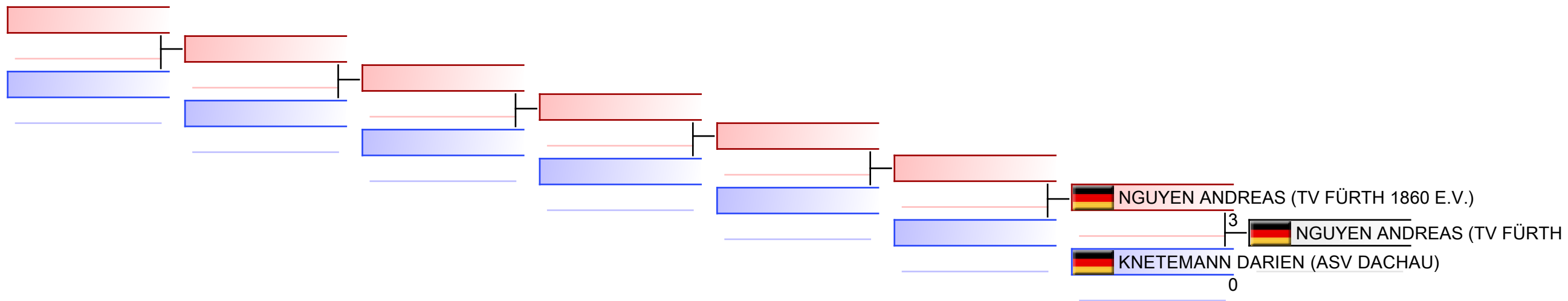

Kumite Schüler B -36kg weiblich

Bayerische Meisterschaft Schüler - LK 2023, Jahnstraße 6, 84508 Burgkirchen an der Alz, GER

2023-02-11

Tatami
2 13:05

Pool
1/1

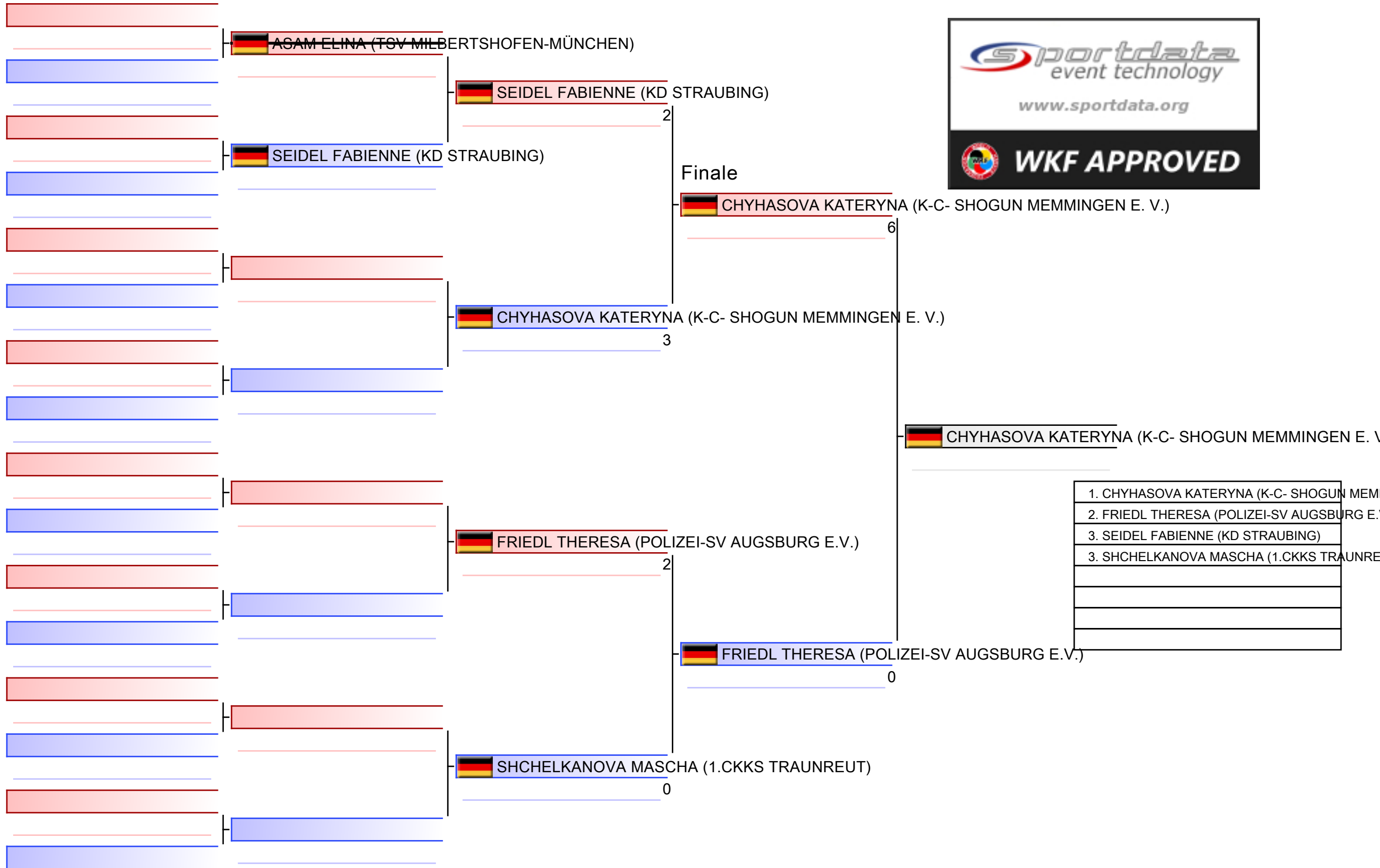

1. CHYHASOVA KATERYNA (K-C- SHOGUN MEMMINGEN E. V.)
2. FRIEDL THERESA (POLIZEI-SV AUGSBURG E. V.)
3. SEIDEL FABIENNE (KD STRAUBING)
3. SHCHELKANOVA MASCHA (1.CKKS TRAUNREUT)

Kumite Schüler B -36kg weiblich

Bayerische Meisterschaft Schüler - LK 2023

2023-02-11

Tatami
2 13:20

Pool
1

(c)sportdata GmbH & Co KG 2000-2023 (2023-02-12 15:58) v 10.0.0 build 1 (2023-01-21) Lizenz: Online_Event_ID-6952_BayerischeMeisterschaftSchlerLK2023 (expire 2023-02-26)

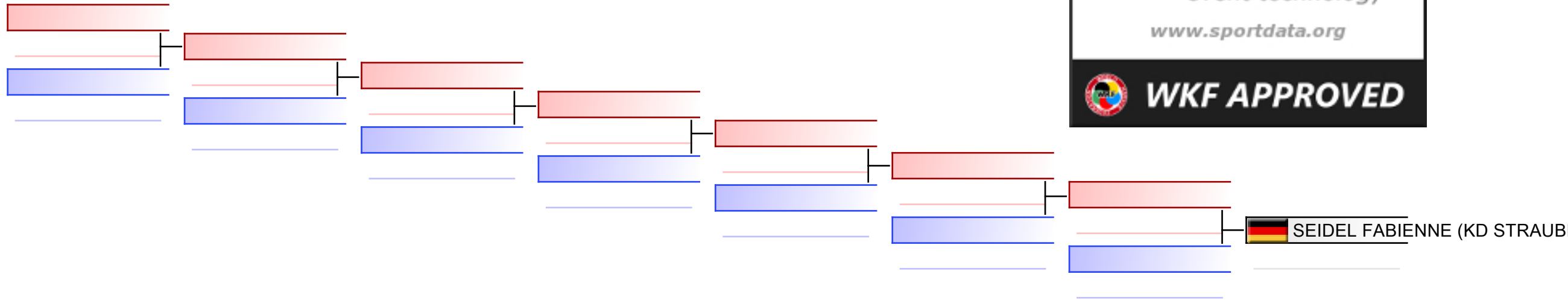

TROSTRUNDE: (1)

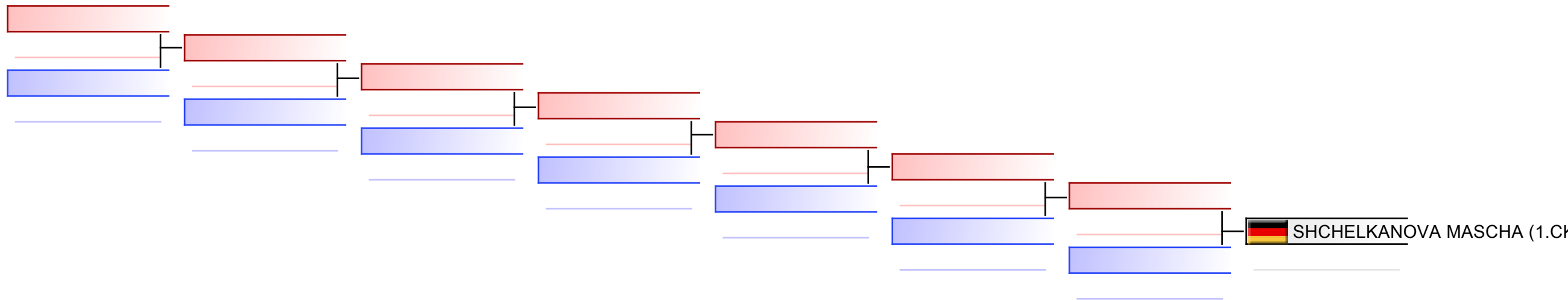

Kumite Schüler B -38kg männlich

Bayerische Meisterschaft Schüler - LK 2023, Jahnstraße 6, 84508 Burgkirchen an der Alz, GER

2023-02-11

Tatami
1 12:50

Pool
1/1

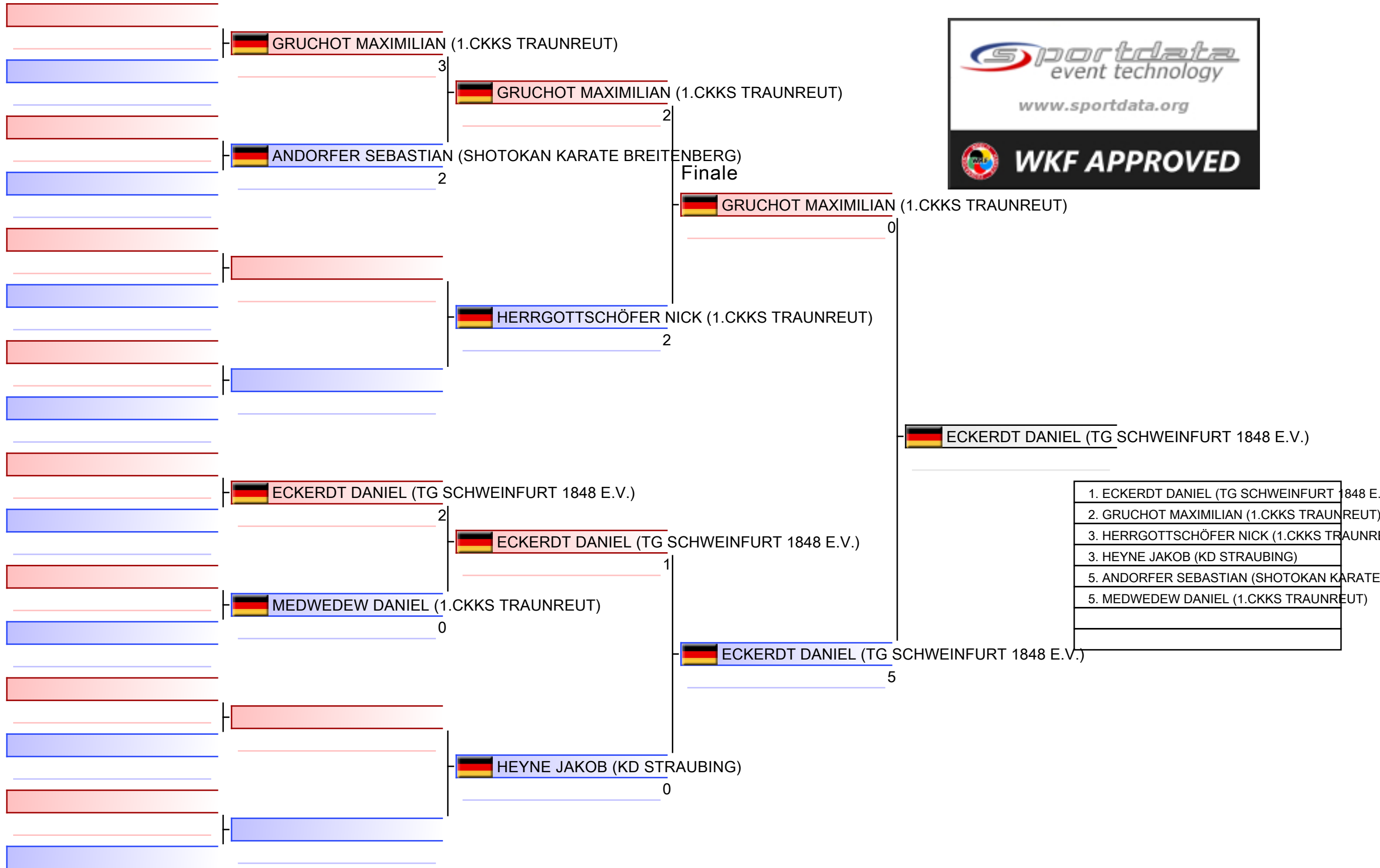

Kumite Schüler B -38kg männlich

Bayerische Meisterschaft Schüler - LK 2023

2023-02-11

Tatami
1 13:05

Pool
1

(c)sportdata GmbH & Co KG 2000-2023 (2023-02-12 15:58) v 10.0.0 build 1 (2023-01-21) Lizenz: Online_Event_ID-6952_BayerischeMeisterschaftSchlerLK2023 (expire 2023-02-26)

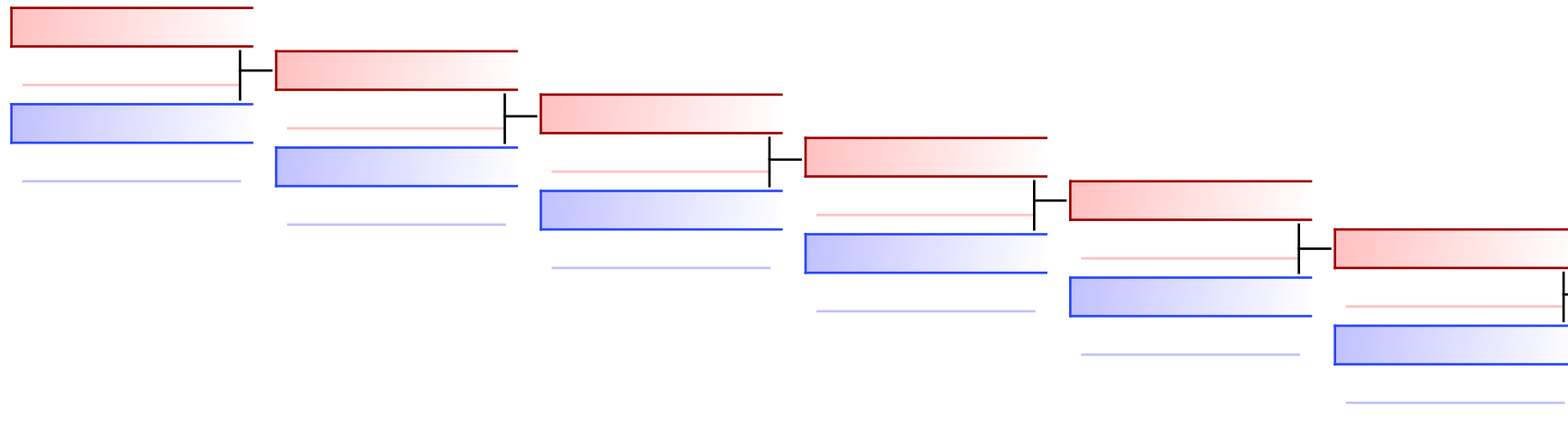

ANDORFER SEBASTIAN (SHOTOKAN KARATE BREITENBURG)
0
 HERRGOTTSCHÖFER NICK (1.CKKS TRAUNREUT)
2

TROSTRUNDE: (1)

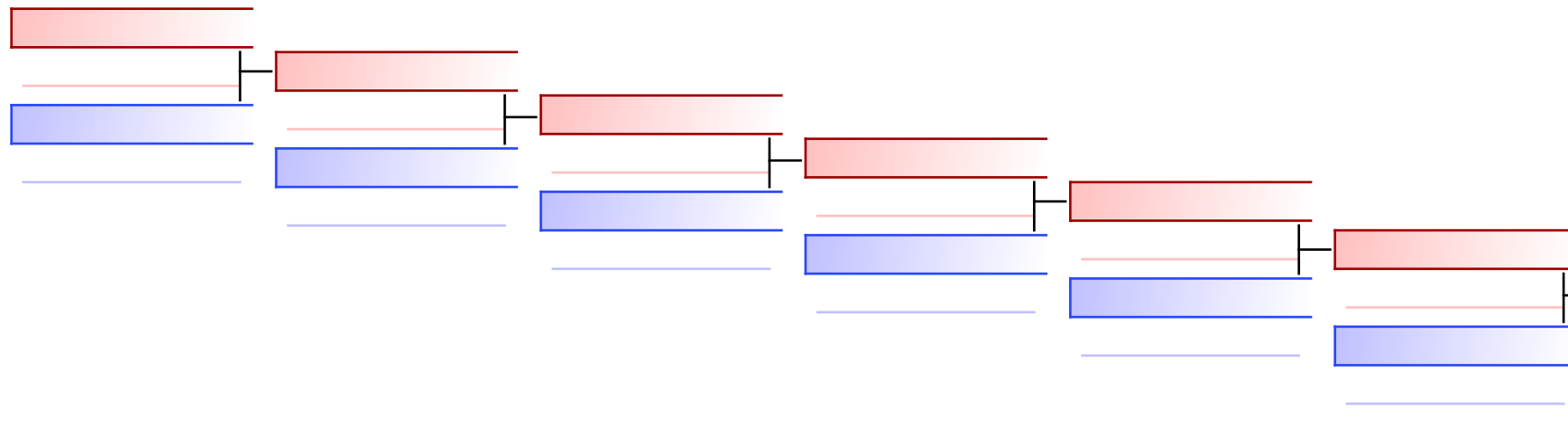

MEDWEDEW DANIEL (1.CKKS TRAUNREUT)
0
 HEYNE JAKOB (KD STRAUBING)
3

Kumite Team Damen

Bayerische Meisterschaft Schüler - LK 2023, Jahnstraße 6, 84508 Burgkirchen an der Alz, GER

Tatami

Pool
1/1

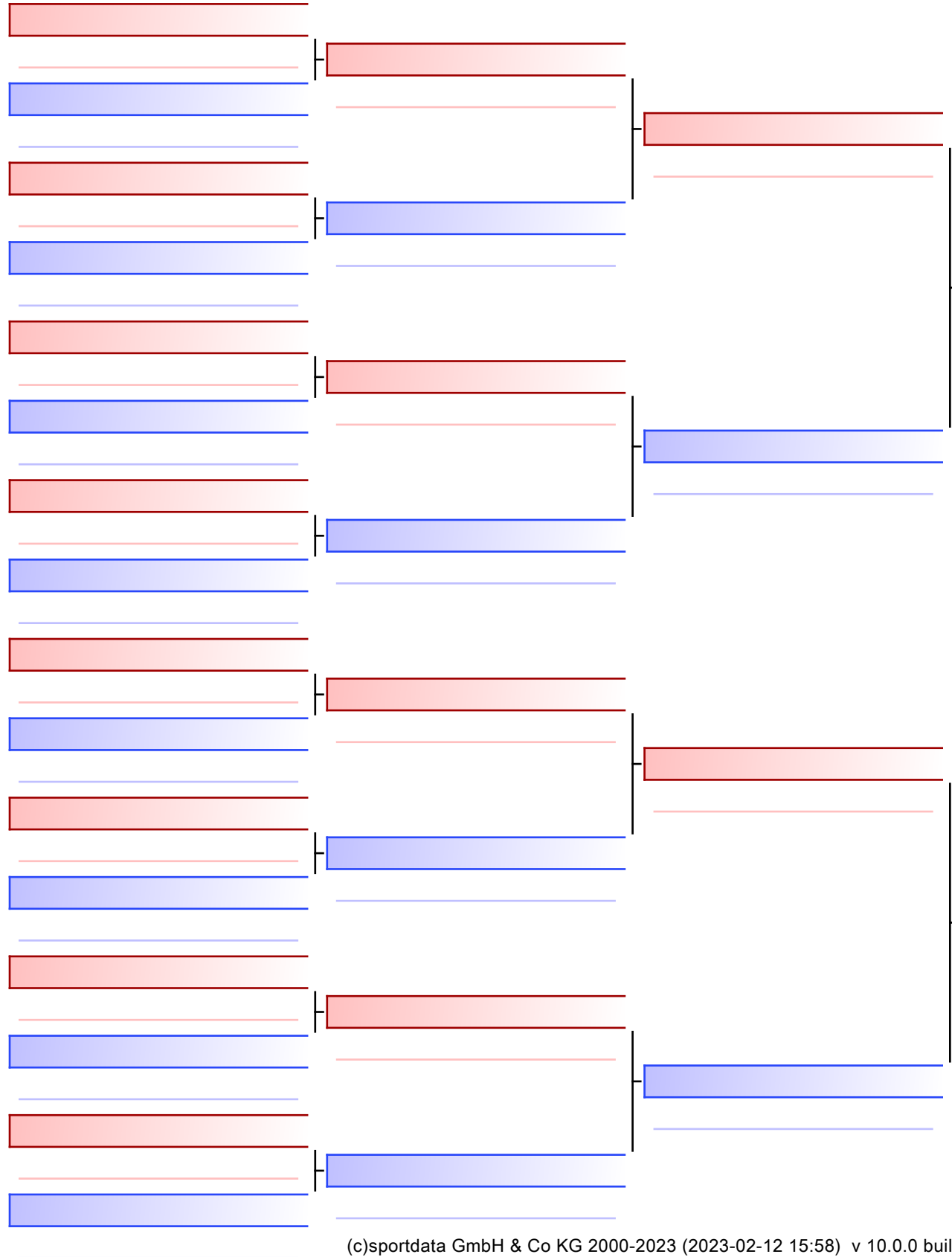

Finale

 KG BAMBERG/HERSBRUCK (POST SV BAMBERG)

 KG VOHBURG/MEMMINGEN (TV 1911 VOHBURG)

 KG VOHBURG/MEMMINGEN (TV 1911 VOHBURG)

1. KG VOHBURG/MEMMINGEN (TV 1911 VOHBURG)

2. KG BAMBERG/HERSBRUCK (POST SV BAMBERG)

Kumite Team Herren

Bayerische Meisterschaft Schüler - LK 2023, Jahnstraße 6, 84508 Burgkirchen an der Alz, GER

Tatami

Pool
1/1

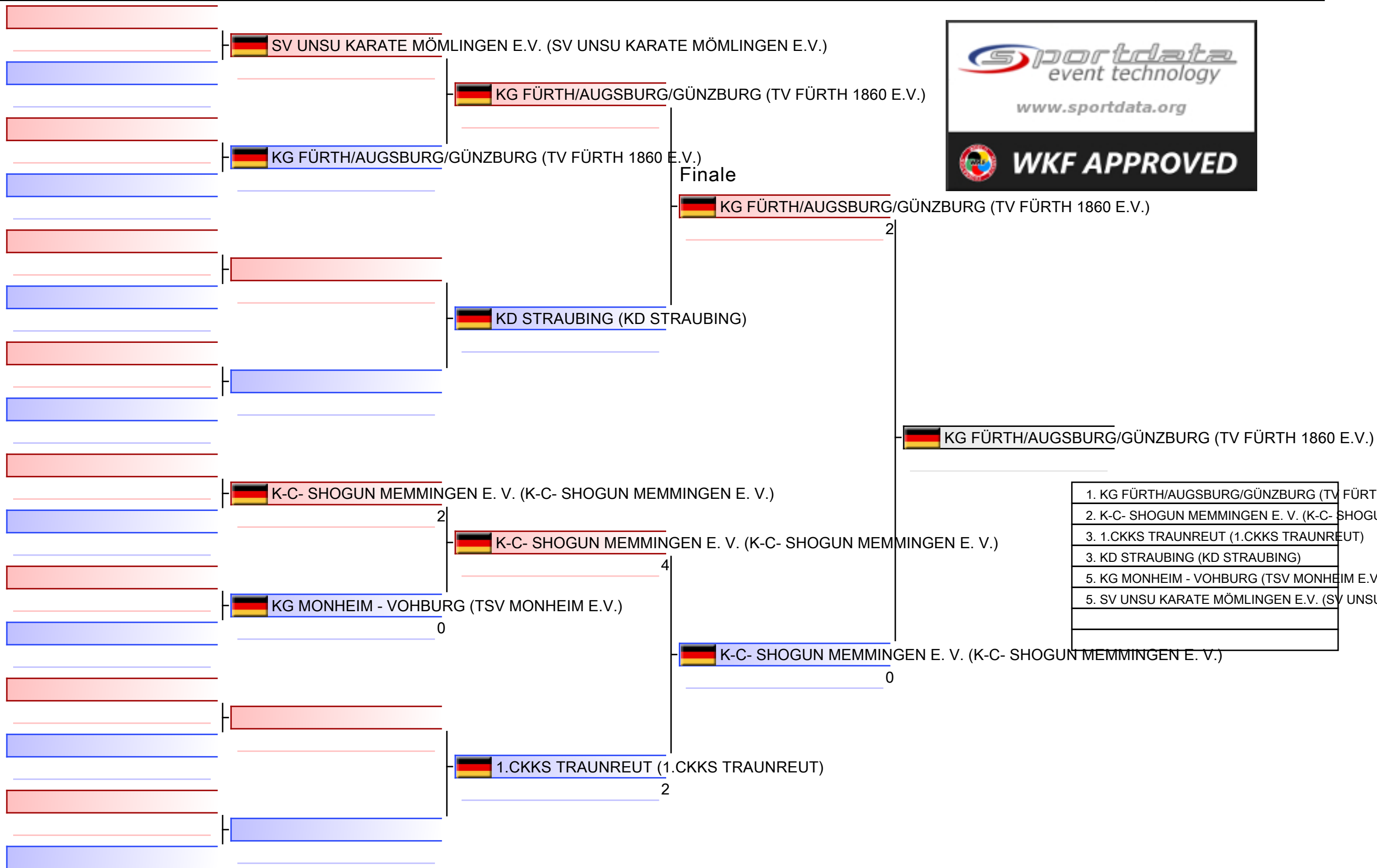

Kumite Team Herren

Bayerische Meisterschaft Schüler - LK 2023

Tatami

Pool

1

(c)sportdata GmbH & Co KG 2000-2023 (2023-02-12 15:58) v 10.0.0 build 1 (2023-01-21) Lizenz: Online_Event_ID-6952_BayerischeMeisterschaftSchlerLK2023 (expire 2023-02-26)

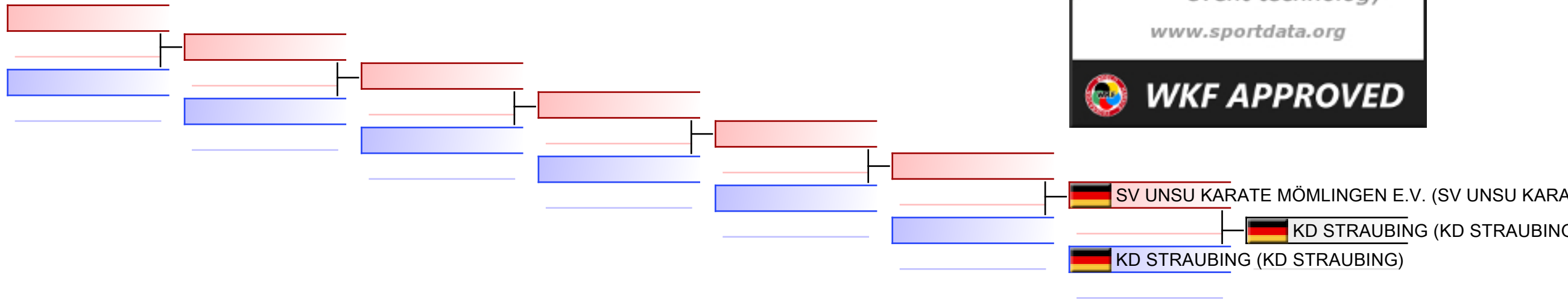

TROSTRUNDE: (1)

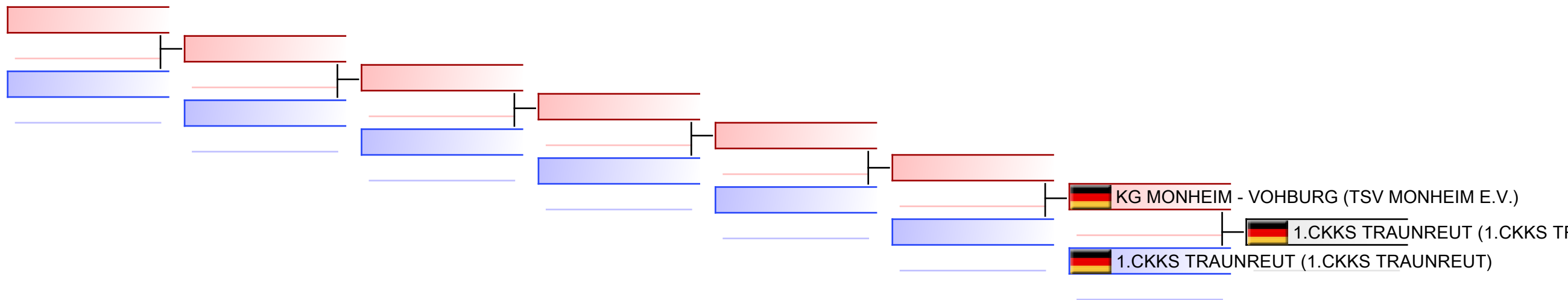

Kumite Team Schüler männlich

Bayerische Meisterschaft Schüler - LK 2023, Jahnstraße 6, 84508 Burgkirchen an der Alz, GER

2023-02-11

Tatami
2 14:35

Pool
1/1

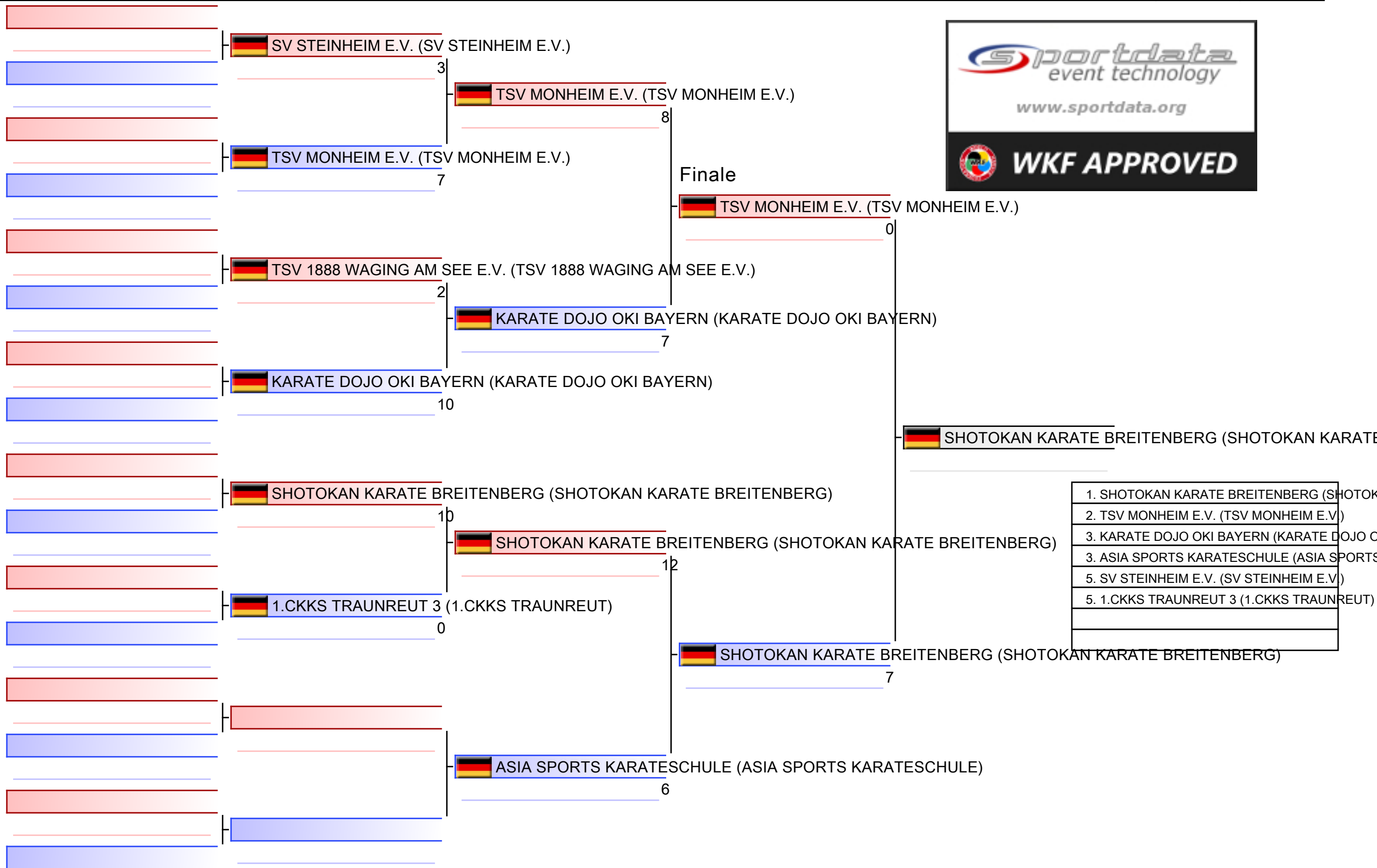

1. SHOTOKAN KARATE BREITENBERG (SHOTOKAN KARATE BREITENBERG)
2. TSV MONHEIM E.V. (TSV MONHEIM E.V.)
3. KARATE DOJO OKI BAYERN (KARATE DOJO OKI BAYERN)
3. ASIA SPORTS KARATESCHULE (ASIA SPORTS KARATESCHULE)
5. SV STEINHEIM E.V. (SV STEINHEIM E.V.)
5. 1.CKKS TRAUNREUT 3 (1.CKKS TRAUNREUT)

Kumite Team Schüler männlich

Bayerische Meisterschaft Schüler - LK 2023

2023-02-11

Tatami
2 15:35

Pool
1

(c)sportdata GmbH & Co KG 2000-2023 (2023-02-12 15:58) v 10.0.0 build 1 (2023-01-21) Lizenz: Online_Event_ID-6952_BayerischeMeisterschaftSchlerLK2023 (expire 2023-02-26)



 SV STEINHEIM E.V. (SV STEINHEIM E.V.)
0
 KARATE DOJO OKI BAYERN (KA
10
 KARATE DOJO OKI BAYERN (KARATE DOJO OKI BA

TROSTRUNDE: (1)

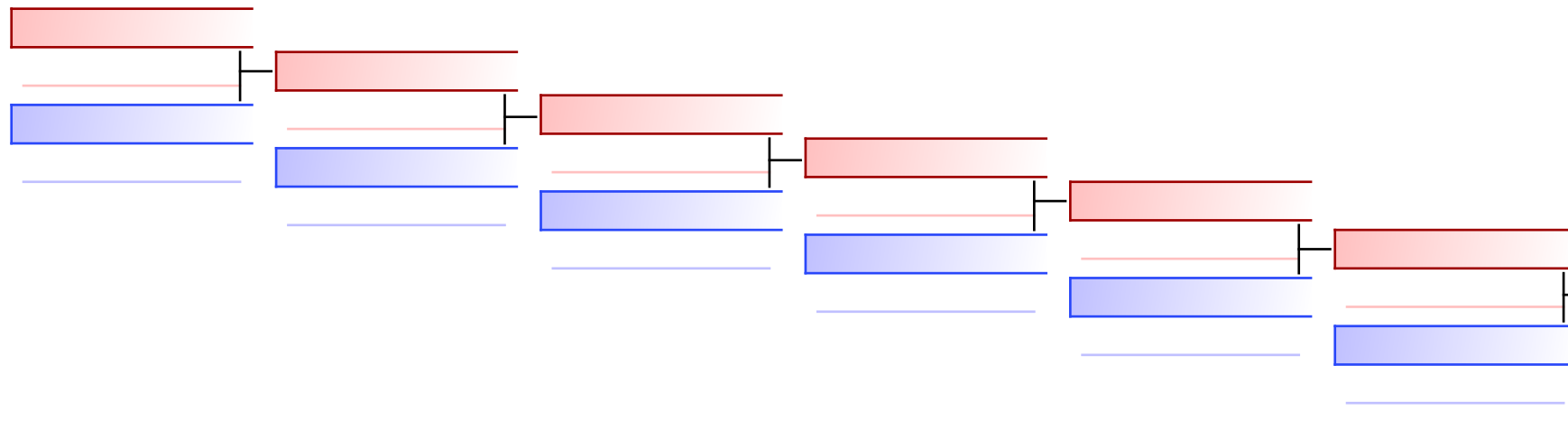

 1.CKKS TRAUNREUT 3 (1.CKKS TRAUNREUT)
2
 ASIA SPORTS KARATESCHULE
5
 ASIA SPORTS KARATESCHULE (ASIA SPORTS KARA

KUMITE TEAM Schüler weiblich

Bayerische Meisterschaft Schüler - LK 2023, Jahnstraße 6, 84508 Burgkirchen an der Alz, GER

2023-02-11

Tatami
3 14:30

Pool
1/1

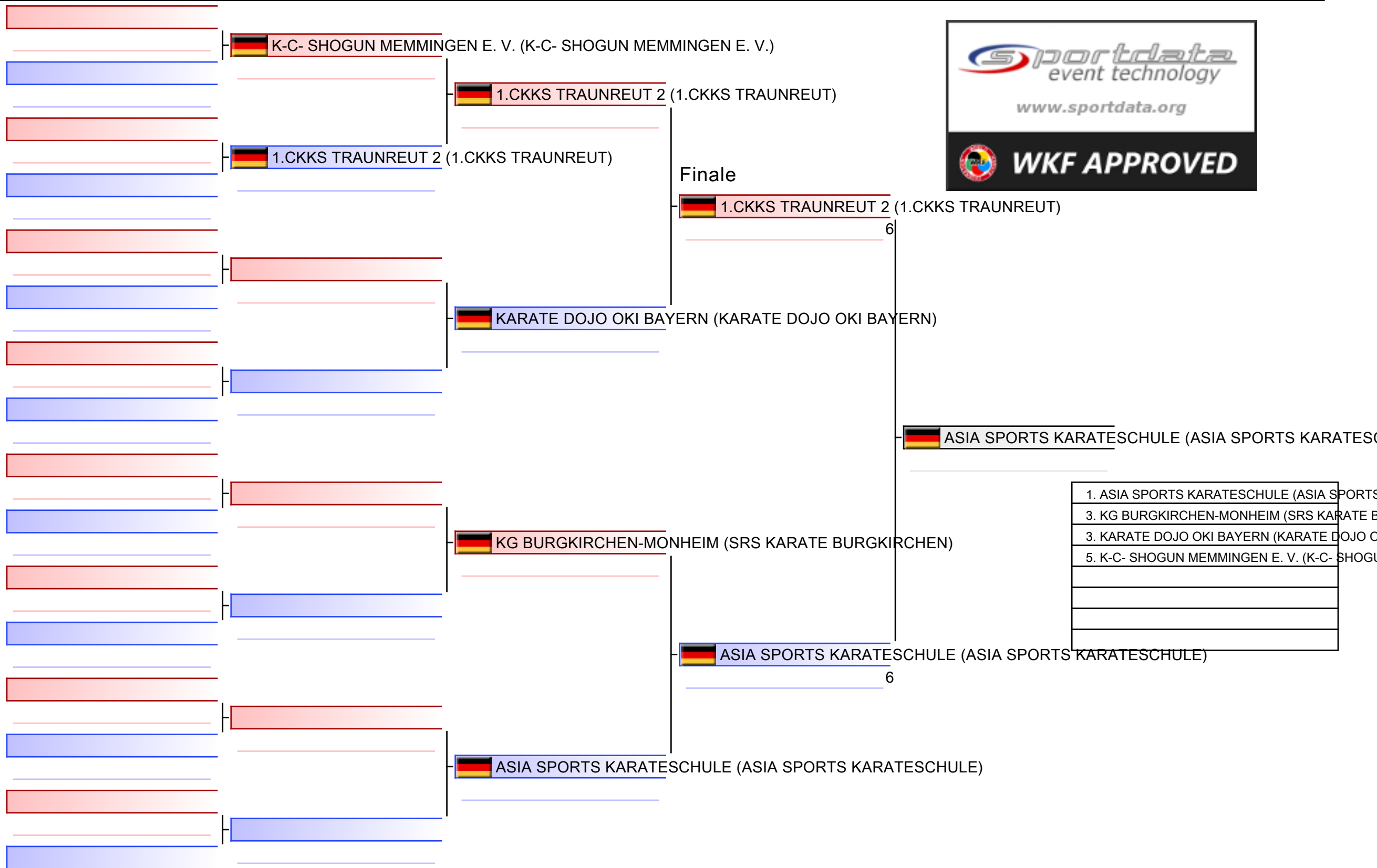

1. ASIA SPORTS KARATESCHULE (ASIA SPORTS KARATESCHULE)
3. KG BURGKIRCHEN-MONHEIM (SRS KARATE BURGKIRCHEN)
3. KARATE DOJO OKI BAYERN (KARATE DOJO OKI BAYERN)
5. K-C- SHOGUN MEMMINGEN E. V. (K-C- SHOGUN MEMMINGEN E. V.)

KUMITE TEAM Schüler weiblich

Bayerische Meisterschaft Schüler - LK 2023

2023-02-11

Tatami
3 15:05

Pool
1

(c)sportdata GmbH & Co KG 2000-2023 (2023-02-12 15:58) v 10.0.0 build 1 (2023-01-21) Lizenz: Online_Event_ID-6952_BayerischeMeisterschaftSchlerLK2023 (expire 2023-02-26)

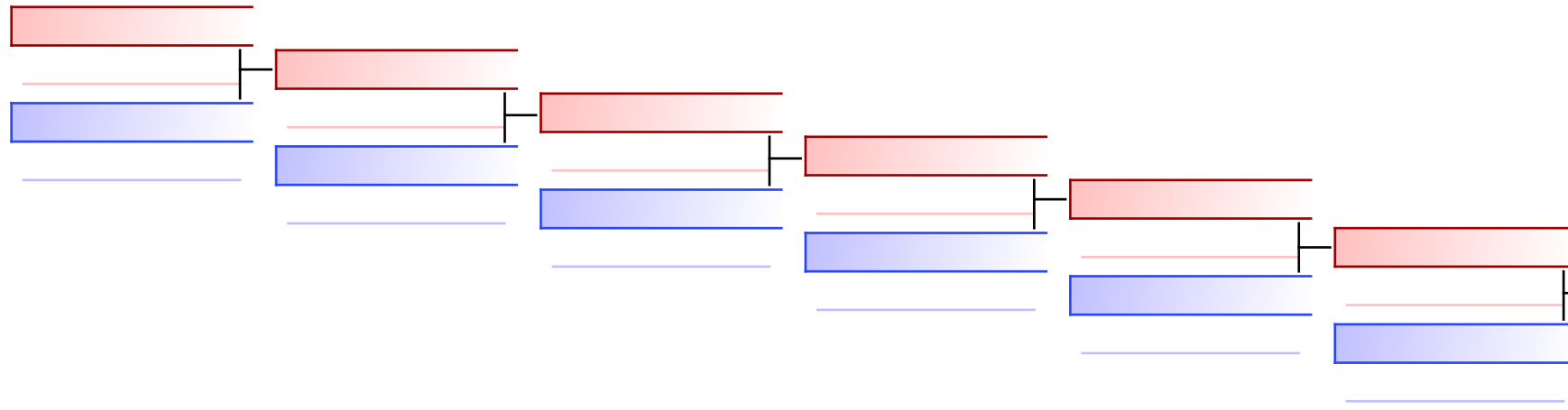

 K-C- SHOGUN MEMMINGEN E. V. (K-C- SHOGUN MEMMINGEN E. V.)
 KARATE DOJO OKI BAYERN (KARATE DOJO OKI BAYERN)
 KARATE DOJO OKI BAYERN (KARATE DOJO OKI BAYERN)

TROSTRUNDE: (1)

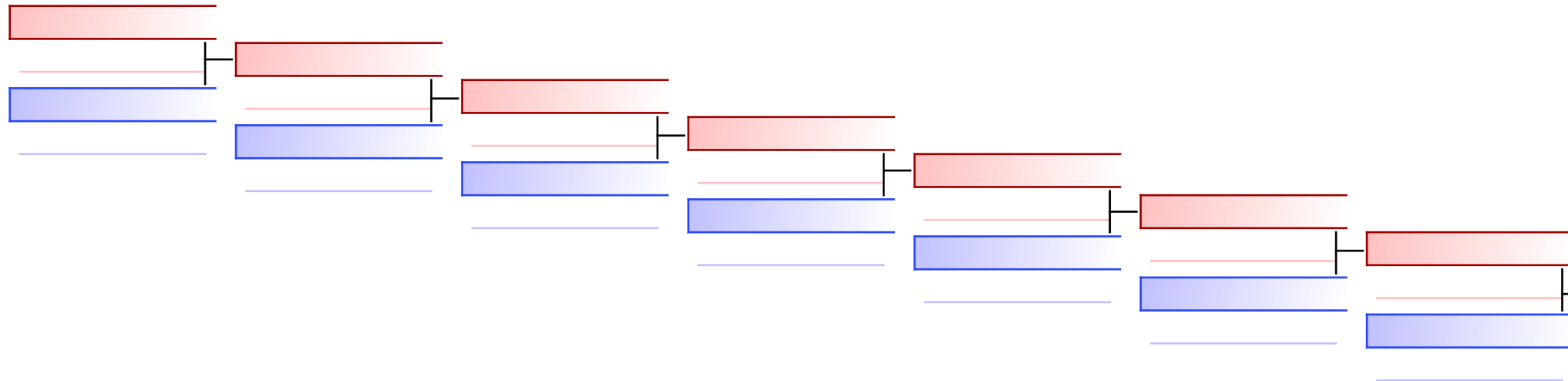

 KG BURGKIRCHEN-MONHEIM (S)

**Bayerische Meisterschaft
Schüler - LK 2023 - 2023-02-11**

Offizielle Ergebnisliste

Kata Leistungsklasse männlich				
1	BERNER LAURENZ	KARATE DOJO DURACH-WEIDACH		GER - GERMANY
2	MATHES MIKA	KARATE DOJO DURACH-WEIDACH		GER - GERMANY
3	SCHNAUS DOMINIK	TSV GRASBRUNN- NEUKEFERLOH		GER - GERMANY
3	PATTANASAKOO NAWAPON	SV UNSU KARATE MÖMLINGEN E.V.		GER - GERMANY
5	THIEROLF JULIAN	SV UNSU KARATE MÖMLINGEN E.V.		GER - GERMANY
5	HORVATH SEBASTIAN	TG SCHWEINFURT 1848 E.V.		GER - GERMANY
7	SHAMSI DANIEL	TSV GRASBRUNN- NEUKEFERLOH		GER - GERMANY
7	PETROVIC MARKO	ESV MÜNCHEN KARATE		GER - GERMANY
9	TROLLMANN MARIUS	TV48 ERLANGEN KARATE		GER - GERMANY

Kata Leistungsklasse weiblich				
1	VLAI JESSICA	ASIA SPORTS KARATESCHULE		GER - GERMANY
2	STÖSSEL ANNA	SV UNSU KARATE MÖMLINGEN E.V.		GER - GERMANY
3	LOGOGE MAELLE	TSV ERDING		GER - GERMANY
3	BRAUN ANNA	SV UNSU KARATE MÖMLINGEN E.V.		GER - GERMANY
5	BOBBERT ISABELLA	TSV ERDING		GER - GERMANY
5	WERNER CLAUDIA	SV UNSU KARATE MÖMLINGEN E.V.		GER - GERMANY
7	BRANDNER SARAH	TSV MONHEIM E.V.		GER - GERMANY
7	ZINECKER MARIE	ASIA SPORTS KARATESCHULE		GER - GERMANY
9	BRAND KERSTIN	ESV MÜNCHEN KARATE		GER - GERMANY
9	LINGNER SANDRA	TSV ERDING		GER - GERMANY
11	HERTWICH MONA	KARATE VEREIN HERZOGENAURACH		GER - GERMANY
11	VOLLMAR ALINA	MTSV SCHWABING E.V.		GER - GERMANY
13	RUSTICEANU MONICA	POST SV BAMBERG		GER - GERMANY
13	SCHMIDT ANIKA	ASIA SPORTS KARATESCHULE		GER - GERMANY
15	BALLER SABRINA	KARATE SV ALTENSTADT/WN		GER - GERMANY
15	KNEZEVIC ANDREA	KARATE-DOJO MÜNCHEN I E.V.		GER - GERMANY
17	DURDEVIC JASNA	SV UNSU KARATE MÖMLINGEN E.V.		GER - GERMANY
17	SCHRÖDER ALENA	ESV MÜNCHEN KARATE		GER - GERMANY
19	WIEDENMANN FRANZISKA	1. KARATE CLUB PASSAU		GER - GERMANY
19	WIELAND SMILLA	1. KARATE CLUB PASSAU		GER - GERMANY

**Bayerische Meisterschaft
Schüler - LK 2023 - 2023-02-11**

Offizielle Ergebnisliste

Kata Schüler A m				
1	SWIAC ADAM	KARATE VEREIN HERZOGENAURACH		GER - GERMANY
2	WITTMER LEO	KD STRAUBING		GER - GERMANY
3	GASSNER THOMAS	OKINAWA KARATE TUS ALZTAL GARCHING		GER - GERMANY
3	LIBIK DANIEL	ASIA SPORTS KARATESCHULE		GER - GERMANY
5	POISEL LUDWIG	TSV MONHEIM E.V.		GER - GERMANY
5	CORNACCHIA EDOARDO	OKINAWA KARATE TUS ALZTAL GARCHING		GER - GERMANY
7	AL HAMAD MEHVAN	TSV ERDING		GER - GERMANY
9	SABANOVIC SAID	KARATE DOJO OKI BAYERN		GER - GERMANY
9	MAIER ADRIAN	KARATE DOJO OKI BAYERN		GER - GERMANY
11	STANG BRUNO	1. KARATE CLUB PASSAU		GER - GERMANY
11	FREUDLING LOUIS	KARATE DOJO TV HALDENWANG E.V.		GER - GERMANY
13	FREUDLING TOBIAS	KARATE DOJO TV HALDENWANG E.V.		GER - GERMANY
13	SABANOVIC OMER	KARATE DOJO OKI BAYERN		GER - GERMANY
15	DOUCHET MAXIM	TSV GRASBRUNN- NEUKEFERLOH		GER - GERMANY
15	KAISER MATTHIAS	OKINAWA KARATE TSV FEICHTEN		GER - GERMANY
17	AMIN WENK	TRADITIONELLE KARATE SCHULE MÜNCHEN E.V.		GER - GERMANY
17	CORDES LEONEL	TRADITIONELLE KARATE SCHULE MÜNCHEN E.V.		GER - GERMANY

Kata Schüler A w				
1	BIEDEMANN HANNAH	KARATE DOJO OKI BAYERN		GER - GERMANY
2	BIEDEMANN GRETA	KARATE DOJO OKI BAYERN		GER - GERMANY
3	EHLING MAGDALENA	ASIA SPORTS KARATESCHULE		GER - GERMANY
3	SCHÜTZ JOHANNA	KD STRAUBING		GER - GERMANY
5	KLUPSCH EMILIA	SG MOOSBURG E.V. ABTEILUNG KARATE		GER - GERMANY
5	LAMPERSBERGER EMILIA	TSV GRABENSTÄTT / CHIEMSEE E. V.		GER - GERMANY
7	RIEMENSBERGER ISABEL	TSV JAHN 1892 WÜRZBURG E.V.		GER - GERMANY
9	HUSICIC AMINA	OKINAWA KARATE TUS ALZTAL GARCHING		GER - GERMANY
9	DECKER KATHARINA	ASIA SPORTS KARATESCHULE		GER - GERMANY
11	MERLENS THERESA	KARATE DOJO TV HALDENWANG E.V.		GER - GERMANY

**Bayerische Meisterschaft
Schüler - LK 2023 - 2023-02-11**

Offizielle Ergebnisliste

11	KRIEGER LENA	ASIA SPORTS KARATESCHULE		GER - GERMANY	
13	IOVA ANDRADA	OKINAWA KARATE TUS ALZTAL GARCHING		GER - GERMANY	
13	PERL ALEGRA	1. FC SCHNAITTACH		GER - GERMANY	

Kata Schüler B Einzel m

1	ZWIRGLMAIER SIMON	OKINAWA KARATE TSV FEICHTEN		GER - GERMANY	
2	HURLER ELIAH	TSV MONHEIM E.V.		GER - GERMANY	
3	FISCHER MARKUS	ASIA SPORTS KARATESCHULE		GER - GERMANY	
3	SARRAF ELIJA EMANUEL	SV STEINHEIM E.V.		GER - GERMANY	
5	SFAR FEDI	KARATE VEREIN HERZOGENAURACH		GER - GERMANY	
7	PROBST ARTHUR	TSV GRASBRUNN- NEUKEFERLOH		GER - GERMANY	
7	HÜTTER MICHAEL	ASIA SPORTS KARATESCHULE		GER - GERMANY	
9	FUHRMANN MAXIMILIAN	SRS KARATE BURGKIRCHEN		GER - GERMANY	
9	KNETEMANN DARIEN	ASV DACHAU		GER - GERMANY	
11	OPPACHER SIMON	TSV 1888 WAGING AM SEE E.V.		GER - GERMANY	
11	TRAUNSPURGER JAKOB	TSV 1888 WAGING AM SEE E.V.		GER - GERMANY	

Kata Schüler B Einzel w

1	SEIDEL FABIENNE	KD STRAUBING		GER - GERMANY	
2	HAPFELMEIER LOUISA	ASIA SPORTS KARATESCHULE		GER - GERMANY	
3	AKINCI NISA NAS	SV UNSU KARATE MÖMLINGEN E.V.		GER - GERMANY	
3	MOHR LOREEN	TUS FEUCHTWANGEN		GER - GERMANY	
5	SCHMIDT LISA	ASIA SPORTS KARATESCHULE		GER - GERMANY	
5	REISWICH LEANA	KD STRAUBING		GER - GERMANY	
7	TROMSA SANDRA	TUS FEUCHTWANGEN		GER - GERMANY	
7	SEIDELT ALINA	KARATE DOJO OKI BAYERN		GER - GERMANY	
9	LEOPOLD HANNAH	TSV ERDING		GER - GERMANY	
9	CUERVO ACEBEDO VEGA	TSV MONHEIM E.V.		GER - GERMANY	
11	DÖRSCH ROSALIE	ASV DACHAU		GER - GERMANY	
11	SCHIERACK ANNA SOFIE	ASV DACHAU		GER - GERMANY	

Kata Team Schüler A+B männlich

1	OKINAWA KARATE TSV FEICHTEN - ZWIRGLMAIER SIMON - STEINER NOAH - KAISER MATTHIAS	OKINAWA KARATE TSV FEICHTEN		GER - GERMANY	
2	ASIA SPORTS KARATESCHULE	ASIA SPORTS KARATESCHULE		GER - GERMANY	

**Bayerische Meisterschaft
Schüler - LK 2023 - 2023-02-11**

Offizielle Ergebnisliste

	- HÜTTER MICHAEL - FISCHER MARKUS - LIBIK DANIEL				
3	TSV 1888 WAGING AM SEE E.V. - OPPACHER SIMON - TRAUNSPURGER JAKOB - BOUKROUH AHMED	TSV 1888 WAGING AM SEE E.V.		GER - GERMANY	
3	SV STEINHEIM E.V. - GEORGE NOEL - HONOLD TOBIAS - SARRAF ELIJA_EMANUEL - BOHN LIAM	SV STEINHEIM E.V.		GER - GERMANY	

Kata Team Schüler A+B weiblich

1	ASIA SPORTS KARATESCHULE - KRIEGER LENA - HAPFELMEIER LOUISA - EHLING MAGDALENA	ASIA SPORTS KARATESCHULE		GER - GERMANY	
2	KD STRAUBING - SEIDEL FABIENNE - SCHÜTZ JOHANNA - REISWICH LEANA	KD STRAUBING		GER - GERMANY	
3	ASV DACHAU - SCHIERACK ANNA_SOFIE - DÖRSCH ROSALIE - BURGMEIER ANNA	ASV DACHAU		GER - GERMANY	

Kumite Leistungsklasse +68 kg weiblich

1	YILDIRIM MERYEM	K-C- SHOGUN MEMMINGEN E. V.		GER - GERMANY	
2	HANS NATALIE	TV 1911 VOHBURG		GER - GERMANY	
3	SCHMIDT-HAMMER LEA	KARATE DOJO UNTERMERZBACH		GER - GERMANY	
3	STEIGLECHNER JOHANNA	TSV-TROSTBERG		GER - GERMANY	

Kumite Leistungsklasse +84 kg männlich

1	SCHALCH PASCAL	1.CKKS TRAUNREUT		GER - GERMANY	
2	TERENGIN WLADIMIR	1.CKKS TRAUNREUT		GER - GERMANY	
3	SAYIN BERKE	K-C- SHOGUN MEMMINGEN E. V.		GER - GERMANY	
3	HACHICHI DJAMEL EDDINE	K-C- SHOGUN MEMMINGEN E. V.		GER - GERMANY	
5	TROLLMANN MARIUS	TV48 ERLANGEN KARATE		GER - GERMANY	

Kumite Leistungsklasse -50 kg weiblich

1	GISSER ISABEL	1.CKKS TRAUNREUT		GER - GERMANY	
2	RUSTICEANU MONICA	POST SV BAMBERG		GER - GERMANY	

Kumite Leistungsklasse -55 kg weiblich

1	KNUPFER LALE	TV 1911 VOHBURG		GER - GERMANY	
2	ISLAM NABILA	SV UNSU KARATE MÖMLINGEN E.V.		GER - GERMANY	
3	NELSON ALEENA	POST SV BAMBERG		GER - GERMANY	

**Bayerische Meisterschaft
Schüler - LK 2023 - 2023-02-11**

Offizielle Ergebnisliste

Kumite Leistungsklasse -60 kg männlich				
1	ALOISIO MATTEO	K-C- SHOGUN MEMMINGEN E. V.		GER - GERMANY
2	HAMI MUHAMMED	TV 1911 VOHBURG		GER - GERMANY

Kumite Leistungsklasse -61 kg weiblich				
1	BLANK MERYL	KARAFLEX KARATECLUB GÜNZBURG		GER - GERMANY
2	GASTL VERONIKA	1.CKKS TRAUNREUT		GER - GERMANY
3	ZEHENTBAUER TINA	TSV VILSBIBURG 1883 E.V.		GER - GERMANY
3	HAJDUCHOVA VERONIKA	1.CKKS TRAUNREUT		GER - GERMANY
5	HERTWICH MONA	KARATE VEREIN HERZOGENAURACH		GER - GERMANY
5	BALLER SABRINA	KARATE SV ALTENSTADT/WN		GER - GERMANY

Kumite Leistungsklasse -67 kg männlich				
1	BRANDNER TIM	TSV MONHEIM E.V.		GER - GERMANY
2	STELZL ALEXANDER	ASIA SPORTS KARATESCHULE		GER - GERMANY
3	SMOVKIN ALEX	KARAFLEX KARATECLUB GÜNZBURG		GER - GERMANY
3	KAMERL FLORIAN	TV 1911 VOHBURG		GER - GERMANY

Kumite Leistungsklasse -68 kg weiblich				
1	MICK LENA	TV 1911 VOHBURG		GER - GERMANY
2	HRVOIC LANA	1.CKKS TRAUNREUT		GER - GERMANY
3	KANDBINDER MILENA	SHOTOKAN KARATE BREITENBERG		GER - GERMANY
3	ROSTIAHAI HANNA	TG SCHWEINFURT 1848 E.V.		GER - GERMANY
5	TEJADA-HEIDENHAIN LAURA	1.CKKS TRAUNREUT		GER - GERMANY

Kumite Leistungsklasse -75 kg männlich				
1	WEITMANN LUKAS	KARAFLEX KARATECLUB GÜNZBURG		GER - GERMANY
2	MITTELSTEDT MORITZ	POLIZEI-SV AUGSBURG E.V.		GER - GERMANY
3	GRÜNFELD PHILIPP	TV 1911 VOHBURG		GER - GERMANY
3	BAHRET JAKOB	KARATE-DOJO MÜNCHEN I E.V.		GER - GERMANY
5	ZENGIN MUHAMMED	K-C- SHOGUN MEMMINGEN E. V.		GER - GERMANY
5	KANDBINDER TOBIAS	SHOTOKAN KARATE BREITENBERG		GER - GERMANY
7	REICHART LUKAS	KARATE DOJO TV HALDENWANG E.V.		GER - GERMANY

Kumite Leistungsklasse -84 kg männlich				
1	SUKA LIRANT	POLIZEI-SV AUGSBURG E.V.		GER - GERMANY

**Bayerische Meisterschaft
Schüler - LK 2023 - 2023-02-11**

Offizielle Ergebnisliste

2	JOBST DAVID	1.CKKS TRAUNREUT		GER - GERMANY	
3	AKGÜN JOEL - LEON	ASIA SPORTS KARATESCHULE		GER - GERMANY	
3	BASARAN ABDÜL-KADIR	K-C- SHOGUN MEMMINGEN E. V.		GER - GERMANY	
5	CIMOLINO FLORIAN	KD STRAUBING		GER - GERMANY	
5	SPIRKL MARKUS	ASIA SPORTS KARATESCHULE		GER - GERMANY	

Kumite Schüler A +49kg männlich

1	CORDES LEONEL	TRADITIONELLE KARATE SCHULE MÜNCHEN E.V.		GER - GERMANY	
2	STRAUCH FLORIAN	TSV MONHEIM E.V.		GER - GERMANY	
3	ROSSMANN LEON	TSV MONHEIM E.V.		GER - GERMANY	
3	PERTHOLD SEVERIN	KARATE VEREIN HERZOGENAURACH		GER - GERMANY	

Kumite Schüler A +49kg weiblich

1	DORDEVIC TEODOIRA	1.CKKS TRAUNREUT		GER - GERMANY	
2	BERGMANN LIYA	TSV MONHEIM E.V.		GER - GERMANY	
3	KRIEGER LENA	ASIA SPORTS KARATESCHULE		GER - GERMANY	
3	SCHOPPER VICTORIA	SHOTOKAN KARATE BREITENBERG		GER - GERMANY	
5	DECKER KATHARINA	ASIA SPORTS KARATESCHULE		GER - GERMANY	

Kumite Schüler A -38kg männlich

1	SABANOVIC OMER	KARATE DOJO OKI BAYERN		GER - GERMANY	
2	AMIN WENK	TRADITIONELLE KARATE SCHULE MÜNCHEN E.V.		GER - GERMANY	
3	DOUCHET MAXIM	TSV GRASBRUNN- NEUKEFERLOH		GER - GERMANY	
3	BOGNER LEANDER	SHOTOKAN KARATE BREITENBERG		GER - GERMANY	
5	IVANOV PRESIYAN	POLIZEI-SV AUGSBURG E.V.		GER - GERMANY	
5	KERN ANTON	POLIZEI-SV AUGSBURG E.V.		GER - GERMANY	

Kumite Schüler A -38kg weiblich

1	BÄRWALD FIONA-ISABEL	TG SCHWEINFURT 1848 E.V.		GER - GERMANY	
2	LAMPERSBERGER EMILIA	TSV GRABENSTÄTT / CHIEMSEE E. V.		GER - GERMANY	
3	SCHÜTZ JOHANNA	KD STRAUBING		GER - GERMANY	

Kumite Schüler A -44kg männlich

1	GRILLINGER JONAH	1. KEMPTENER KARATE DOJO IM TV KEMPTEN		GER - GERMANY	
2	JIRA MICHAEL	TV FÜRTH 1860 E.V.		GER - GERMANY	
3	WITTMER LEO	KD STRAUBING		GER - GERMANY	

**Bayerische Meisterschaft
Schüler - LK 2023 - 2023-02-11**

Offizielle Ergebnisliste

3	MAHOVKIC AJDIN	KARATE DOJO OKI BAYERN		GER - GERMANY	
5	SWIAC ADAM	KARATE VEREIN HERZOGENAURACH		GER - GERMANY	
5	NASCHWITZ LENNY	TSV MONHEIM E.V.		GER - GERMANY	





Kumite Schüler A -44kg weiblich

1	EHLING ISABELLA	ASIA SPORTS KARATESCHULE		GER - GERMANY	
2	SALJIC DALIA	KARATE DOJO OKI BAYERN		GER - GERMANY	
3	MAEMPEL LINA	KARATE DOJO UNTERMERZBACH		GER - GERMANY	
3	IBRAHIMI SELMA	TSV MILBERTSHOFEN- MÜNCHEN		GER - GERMANY	

Kumite Schüler A -49kg männlich

1	SABANOVIC SAID	KARATE DOJO OKI BAYERN		GER - GERMANY	
2	WEIDINGER JOSEF	SHOTOKAN KARATE BREITENBERG		GER - GERMANY	

Kumite Schüler B +36kg weiblich

1	SCHULZ EVA	KARATE DOJO UNTERMERZBACH		GER - GERMANY	
2	HÖRNER FRIEDA	KARATE DOJO NAILA		GER - GERMANY	
3	MARTLI EYSAN	TSV MILBERTSHOFEN- MÜNCHEN		GER - GERMANY	
3	TZECHERIDIS ANDRIANA	KARATE DOJO OKI BAYERN		GER - GERMANY	
5	KARACALI SARA	SRS KARATE BURGKIRCHEN		GER - GERMANY	
5	BERISHA SUELA	SRS KARATE BURGKIRCHEN		GER - GERMANY	
7	SCHMIDT LISA	ASIA SPORTS KARATESCHULE		GER - GERMANY	

Kumite Schüler B +38kg männlich

1	DREXLER PAUL	SHOTOKAN KARATE BREITENBERG		GER - GERMANY	
2	FISCHER MARKUS	ASIA SPORTS KARATESCHULE		GER - GERMANY	
3	GEORGE NOEL	SV STEINHEIM E.V.		GER - GERMANY	
3	FELLINGER PHILIPP	1.CKKS TRAUNREUT		GER - GERMANY	
5	HONOLD TOBIAS	SV STEINHEIM E.V.		GER - GERMANY	
5	KARAYEL EREN YÜKSEL	TSV MILBERTSHOFEN- MÜNCHEN		GER - GERMANY	

Kumite Schüler B -30kg weiblich

1	MAHOVKIC AJNA	KD OKI BAYERN		GER - GERMANY	
2	MEYER SINAH	TV FÜRTH 1860 E.V.		GER - GERMANY	
3	SEIDELT ALINA	KARATE DOJO OKI BAYERN		GER - GERMANY	

**Bayerische Meisterschaft
Schüler - LK 2023 - 2023-02-11**

Offizielle Ergebnisliste

3	DÖRSCH ROSALIE	ASV DACHAU		GER - GERMANY	
5	BAYER NIKE EMILIE	KARATE DOJO UNTERMERZBACH		GER - GERMANY	
5	GEIGER JULIA	ASV DACHAU		GER - GERMANY	

Kumite Schüler B -32kg männlich

1	SARRAF ELIJA EMANUEL	SV STEINHEIM E.V.		GER - GERMANY	
2	TOPIC RYAN	TSV MILBERTSHOFEN- MÜNCHEN		GER - GERMANY	
3	NGUYEN ANDREAS	TV FÜRTH 1860 E.V.		GER - GERMANY	
3	HURLER ELIAH	TSV MONHEIM E.V.		GER - GERMANY	
5	KNETEMANN DARIEN	ASV DACHAU		GER - GERMANY	
5	BARANYAI VINCE BELA	TV 1911 VOHBURG		GER - GERMANY	

Kumite Schüler B -36kg weiblich

1	CHYHASOVA KATERYNA	K-C- SHOGUN MEMMINGEN E. V.		GER - GERMANY	
2	FRIEDL THERESA	POLIZEI-SV AUGSBURG E.V.		GER - GERMANY	
3	SEIDEL FABIENNE	KD STRAUBING		GER - GERMANY	
3	SHCHELKANOVA MASCHA	1.CKKS TRAUNREUT		GER - GERMANY	

Kumite Schüler B -38kg männlich

1	ECKERDT DANIEL	TG SCHWEINFURT 1848 E.V.		GER - GERMANY	
2	GRUCHOT MAXIMILIAN	1.CKKS TRAUNREUT		GER - GERMANY	
3	HERRGOTTSCHÖFER NICK	1.CKKS TRAUNREUT		GER - GERMANY	
3	HEYNE JAKOB	KD STRAUBING		GER - GERMANY	
5	ANDORFER SEBASTIAN	SHOTOKAN KARATE BREITENBERG		GER - GERMANY	
5	MEDWEDEW DANIEL	1.CKKS TRAUNREUT		GER - GERMANY	

Kumite Team Damen

1	KG VOHBURG/MEMMINGEN - YILDIRIM MEYREM - MICK LENA - KNUPFER LALE - HANS NATALIE	TV 1911 VOHBURG		GER - GERMANY	
2	KG BAMBERG/HERSBRUCK - NELSON ALEENA - TRENZ BIANCA - RUSTICEANU MONICA	POST SV BAMBERG		GER - GERMANY	

Kumite Team Herren







1	KG FÜRTH/AUGSBURG/ GÜNZBURG - SUKA LIRANT - SMOKVIN ALEKSANDR - MITTELSTEDT MORITZ - WEITMANN LUKAS - ENGELHARDT ALESSANDRO	TV FÜRTH 1860 E.V.		GER - GERMANY	
2	K-C- SHOGUN MEMMINGEN E. V.	K-C- SHOGUN MEMMINGEN E. V.		GER - GERMANY	

**Bayerische Meisterschaft
Schüler - LK 2023 - 2023-02-11**

Offizielle Ergebnisliste

	- SAYIN BERKE - ZENGIN MUHAMMED - BASARAN ABDÜL-KADIR - ALOISIO MATTEO - HACHICHI DJAMEL_EDDINE				
3	1.CKKS TRAUNREUT - TERENGIN WLADIMIR - SCHALCH PASCAL - JOBST DAVID	1.CKKS TRAUNREUT		GER - GERMANY	
3	KD STRAUBING - LEISTENSCHNEIDER HEINRICH - KOLBINGER MAXIMILIAN - CIMOLINO FLORIAN - DELIJA ARTUR - OBERMEIER PASCAL	KD STRAUBING		GER - GERMANY	
5	KG MONHEIM - VOHBURG - KAMERL FLORIAN - GRÜNFELD PHILIPP - BRANDNER TIM	TSV MONHEIM E.V.		GER - GERMANY	
5	SV UNSU KARATE MÖMLINGEN E.V. - ISLAM RIDWAN - ISLAM SAJJAD - THIEROLF JULIAN	SV UNSU KARATE MÖMLINGEN E.V.		GER - GERMANY	

Kumite Team Schüler männlich

1	SHOTOKAN KARATE BREITENBERG - DREXLER PAUL - BOGNER LEANDER - ANDORFER SEBASTIAN - WEIDINGER JOSEF	SHOTOKAN KARATE BREITENBERG		GER - GERMANY	
2	TSV MONHEIM E.V. - NASCHWITZ LENNY - MEYER LUI - HURLER ELIAH - STRAUCH FLORIAN - ROSSMANN LEON	TSV MONHEIM E.V.		GER - GERMANY	
3	KARATE DOJO OKI BAYERN - SABANOVIC SAID - SABANOVIC OMER - MAIER ADRIAN - MAHOVKIC AJDIN	KARATE DOJO OKI BAYERN		GER - GERMANY	
3	ASIA SPORTS KARATESCHULE - MEHLHAFF ALEXANDER - LIBIK DANIEL - HÜTTER MICHAEL - FISCHER MARKUS	ASIA SPORTS KARATESCHULE		GER - GERMANY	
5	SV STEINHEIM E.V. - SARRAF ELIJA_EMANUEL - HONOLD TOBIAS - BOHN LIAM - GEORGE NOEL	SV STEINHEIM E.V.		GER - GERMANY	
5	1.CKKS TRAUNREUT 3 - GRUCHOT MAXIMILIAN - FELLINGER PHILIPP - MEDWEDEW DANIEL	1.CKKS TRAUNREUT		GER - GERMANY	

KUMITE TEAM Schüler weiblich

1	ASIA SPORTS KARATESCHULE	ASIA SPORTS KARATESCHULE		GER - GERMANY	
---	--------------------------	--------------------------	---	---------------	--

**Bayerische Meisterschaft
Schüler - LK 2023 - 2023-02-11**

Offizielle Ergebnisliste

	- DECKER KATHARINA - EHLING MAGDALENA - KRIEGER LENA - EHLING ISABELLA				
3	KG BURGKIRCHEN-MONHEIM - KARACALI SARA - BERISHA SUELA - BERGMANN LIYA	SRS KARATE BURGKIRCHEN		GER - GERMANY	
3	KARATE DOJO OKI BAYERN - SEIDELT ALINA - SALJIC DALIA - MAHOVKIC AJNA - TZECHERIDIS ANDRIANA	KARATE DOJO OKI BAYERN		GER - GERMANY	
5	K-C- SHOGUN MEMMINGEN E. V. - WALTER ELIZA - CHYHASOVA TAIISIA - CHYHASOVA KATERYNA	K-C- SHOGUN MEMMINGEN E. V.		GER - GERMANY	

**Bayerische Meisterschaft
Schüler - LK 2023 - 2023-02-11**

Medallenspiegel - Verein

Rang	Verein	1. Platz	2. Platz	3. Platz
1	 ASIA SPORTS KARATESCHULE, GER	4	4	6
2	 1.CKKS TRAUNREUT, GER	3	5	5
3	 KARATE DOJO OKI BAYERN, GER	3	2	5
4	 TV 1911 VOHBURG, GER	3	2	2
5	 K-C- SHOGUN MEMMINGEN E. V., GER	3	1	3
6	 SHOTOKAN KARATE BREITENBERG, GER	2	1	3
7	 KARAFLEX KARATECLUB GÜNZBURG, GER	2	0	1
	 TG SCHWEINFURT 1848 E.V., GER	2	0	1
9	 OKINAWA KARATE TSV FEICHTEN, GER	2	0	0
10	 TSV MONHEIM E.V., GER	1	4	2
11	 KD STRAUBING, GER	1	2	6
12	 TV FÜRTH 1860 E.V., GER	1	2	1
13	 POLIZEI-SV AUGSBURG E.V., GER	1	2	0
14	 TRADITIONELLE KARATE SCHULE MÜNCHEN E.V., GER	1	1	0
	 KARATE DOJO DURACH-WEIDACH, GER	1	1	0
16	 SV STEINHEIM E.V., GER	1	0	3
17	 KARATE DOJO UNTERMERZBACH, GER	1	0	2
18	 KARATE VEREIN HERZOGENAURACH, GER	1	0	1
19	 1. KEMPTENER KARATE DOJO IM TV KEMPTEN, GER	1	0	0
	 KD OKI BAYERN, GER	1	0	0
21	 SV UNSU KARATE MÖMLINGEN E.V., GER	0	2	3
22	 POST SV BAMBERG, GER	0	2	1
23	 TSV MILBERTSHOFEN-MÜNCHEN, GER	0	1	2
24	 KARATE DOJO NAILA, GER	0	1	0
	 TSV GRABENSTÄTT / CHIEMSEE E. V., GER	0	1	0
26	 TSV GRASBRUNN-NEUKEFERLOH, GER	0	0	2
	 ASV DACHAU, GER	0	0	2
28	 OKINAWA KARATE TUS ALZTAL GARCHING, GER	0	0	1
	 TUS FEUCHTWANGEN, GER	0	0	1
	 TSV VILSBIBURG 1883 E.V., GER	0	0	1
	 TSV 1888 WAGING AM SEE E.V., GER	0	0	1
	 TSV-TROSTBERG, GER	0	0	1
	 TSV ERDING, GER	0	0	1
	 KARATE-DOJO MÜNCHEN I E.V., GER	0	0	1
	 SRS KARATE BURGKIRCHEN, GER	0	0	1