

Campeonato Centroamericano y del Caribe de Karate 2023

2023.03.02 - 2023.03.04

Carretera Cocoyoc - Oaxtepec Km 2.5, Centro, 62738 Oaxtepec

MEXICO,MEX



**Campeonato Centroamericano y del
Caribe de Karate 2023 - 2023-03-02**
CADET AND JUNIOR KATA TEAM FEMALE

R1 G1/1 (1) Tatami 2 11:00(2023-03-03)

Competitors		Kata	1	2	3	4	5	6	7	TOTAL	Extra Total Rank
1	DESCIDERIO (DE_LA_O_GARCIA, MARTINEZ_RETA, MARTINEZ_ZAPATA) (MEX)	001 ANAN	7.9	(8.4)	7.8	7.7	(7.3)			23.4	23.4 1

Results



1	DESCIDERIO - DE_LA_O_GARCIA XIMENA - MARTINEZ_RETA MARIA_FERNANDA - MARTINEZ_ZAPATA ANA_YURIDIA	MEXICO		MEXICO
---	--	--------	---	--------

**Campeonato Centroamericano y del
Caribe de Karate 2023 - 2023-03-02
CADET AND JUNIOR KATA TEAM MALE**

R1 G1/1 (3) Tatami 1 10:15(2023-03-03)

	Competitors	Kata	1	2	3	4	5	6	7	TOTAL	Extra Total Rank
1	FSK (DELGADO_POSADAS, GONZALEZ_PAZ, GRANADOS_HERRERA, MORENO_CASTRO) (FSK)	001 ANAN	7.6	7.4	(7.7)	(7.0)	7.3			22.3	22.3 3
2	COLOMBIA (IZQUIERDO, MUNOZ_PINTO, RIASCOS) (COL)	099 UNSU	(8.0)	7.6	8.0	7.5	(7.3)			23.1	23.1 1
3	DESCIDERIO (MACIAS_CASTELLANOS, RETIZ_CAMPOS, SALDAÑA_MARKUS) (MEX)	064 OHAN DAI	(8.5)	(7.3)	7.8	7.3	7.6			22.7	22.7 2

Results

1	COLOMBIA - IZQUIERDO_GERMAN - MUNOZ_PINTO SAMUEL - RIASCOS IVAN_DAVID	COLOMBIA		COLOMBIA
2	DESCIDERIO - MACIAS_CASTELLANOS JUANN_PABLO - RETIZ_CAMPOS RODRIGO_ADRIAN - SALDAÑA_MARKUS EMILIO	MEXICO		MEXICO
3	FSK - DELGADO_POSADAS BRYAN MAURICIO - GONZALEZ_PAZ CARLOS_ERNESTO - GRANADOS_HERRERA ANGEL_EMILIO - MORENO_CASTRO CESAR_ENRIQUE	FSK		EL SALVADOR

**Campeonato Centroamericano y del
Caribe de Karate 2023 - 2023-03-02
Cadet Kata Female**

R1 G1/2 (4) Tatami 3 09:00(2023-03-02)

Competitors	Kata	1	2	3	4	5	6	7	TOTAL	Extra Total Rank
1 SALAZAR PEÑA MONSERRAT (VOLQUEZ)	068 PAPUREN	(7.6)	6.7	6.9	(6.1)	7.4			21.0	21.0 3
2 QUINTERO_AVAS YUBIA_MARINA (MEX)	068 PAPUREN	(7.8)	7.0	7.2	(6.6)	7.6			21.8	21.8 2
3 OLIGINO DIANA (KARATE DO)	068 PAPUREN	7.9	(8.0)	7.6	(7.2)	7.8			23.3	23.3 1
4 ZAMORA HEYDY (COL)	092 SUPARINPEI	6.9	6.8	(7.2)	(6.2)	7.2			20.9	20.9 4

R1 G2/2 (4) Tatami 3 09:15(2023-03-02)

Competitors	Kata	1	2	3	4	5	6	7	TOTAL	Extra Total Rank
1 RIOS_BERNAL ELIA_XIMENA (MEX)	001 ANAN	7.2	7.5	(6.8)	6.8	(7.7)			21.5	21.5 3
2 CORNIEL_UREÑA JOHANLYZ (VOLQUEZ)										
3 FERREIRA STEPHANY (KARATE DO)	068 PAPUREN	(7.9)	7.7	7.2	(7.0)	7.5			22.4	22.4 1
4 JUAREZ_MARTINEZ STEPHANIE_SARAI (FSK)	068 PAPUREN	7.1	(7.6)	(7.0)	7.2	7.3			21.6	21.6 2

R2 Bronze Medal Match 1 Tatami 3 09:35(2023-03-02)

Competitors	Kata	1	2	3	4	5	6	7	TOTAL	Extra Total Rank
1 QUINTERO_AVAS YUBIA_MARINA (MEX)	043 KISHIMOTO NO KUSHANKU	(7.5)	6.7	7.2	(6.5)	7.2			21.1	21.1 2
2 RIOS_BERNAL ELIA_XIMENA (MEX)	092 SUPARINPEI	(7.8)	7.0	7.4	(6.8)	7.4			21.8	21.8 1







R2 Bronze Medal Match 2 Tatami 3 09:45(2023-03-02)

Competitors	Kata	1	2	3	4	5	6	7	TOTAL	Extra Total Rank
1 SALAZAR PEÑA MONSERRAT (VOLQUEZ)	065 OYADOMARI NO PASSAI	6.7	(7.2)	7.0	7.0	(6.3)			20.7	20.7 2
2 JUAREZ_MARTINEZ STEPHANIE_SARAI (FSK)	008 CHATANYARA KUSHANKU	6.9	(7.3)	7.2	7.2	(6.1)			21.3	21.3 1

R2 Gold Medal Match Tatami 3 09:55(2023-03-02)

Competitors	Kata	1	2	3	4	5	6	7	TOTAL	Extra Total Rank
1 OLIGINO DIANA (KARATE DO)	008 CHATANYARA KUSHANKU	(8.0)	8.0	7.5	(7.4)	7.4			22.9	22.9 1
2 FERREIRA STEPHANY (KARATE DO)	043 KISHIMOTO NO KUSHANKU	(7.7)	7.7	7.6	(7.2)	7.2			22.5	22.5 2

Results

1	OLIGINO DIANA	KARATE DO		VENEZUELA
2	FERREIRA STEPHANY	KARATE DO		VENEZUELA
3	RIOS BERNAL ELIA XIMENA	MEXICO		MEXICO
3	JUAREZ MARTINEZ STEPHANIE SARAI	FSK		EL SALVADOR
5	QUINTERO AVAS YUBIA MARINA	MEXICO		MEXICO
5	SALAZAR PEÑA MONSERRAT	VOLQUEZ		DOMINICAN REPUBLIC
7	ZAMORA HEYDY	COLOMBIA		COLOMBIA

**Campeonato Centroamericano y del
Caribe de Karate 2023 - 2023-03-02**

Cadet Kata Male

R1 G1/2 (6) Tatami 4 09:00(2023-03-02)

Competitors	Kata	1	2	3	4	5	6	7	TOTAL	Extra Total Rank
1 CASTRO OSCAR_ALEJANDRO (COL)	041 KANKU SHO	6.8	(7.6)	6.7	(6.2)	6.5			20.0	6
2 GRECO GIANLUCA (KARATE DO)	008 CHATANYARA KUSHANKU	7.5	(7.9)	7.4	7.4	(7.2)			22.3	2
3 JIMENEZ MATIAS (FECOKA)	041 KANKU SHO	7.0	(7.1)	6.8	(6.4)	6.6			20.4	5
4 GRANADOS_HERRERA ANGEL_EMILIO (FSK)	068 PAPUREN	7.1	(7.5)	7.1	(6.6)	7.0			21.2	4
5 LIZARDO_REYES GERMAN_EDUARDO (VOLQUEZ)	021 GOJUSHIHO SHO	(7.3)	(7.6)	7.5	7.3	7.5			22.3	1
6 HONORATO_ARRIAGA DANTE_ZAHIR (MEX)	001 ANAN	7.2	(7.3)	7.0	7.0	(6.8)			21.2	3

R1 G2/2 (6) Tatami 4 09:25(2023-03-02)

Competitors	Kata	1	2	3	4	5	6	7	TOTAL	Extra Total Rank
1 GARCIA_VALADEZ JUAN_PABLO (MEX)	008 CHATANYARA KUSHANKU	7.2	(7.4)	7.3	7.4	(7.0)			21.9	2
2 LAFEE DIEGO (KARATE DO)	021 GOJUSHIHO SHO	7.3	(7.5)	7.4	(7.1)	7.2			21.9	1
3 MORENO_CASTRO CESAR_ENRIQUE (FSK)	001 ANAN	6.9	(7.2)	6.8	(6.2)	6.6			20.3	6
4 RODRIGUEZ SEBASTIAN (FECOKA)	015 GANKAKU	7.0	(6.8)	(7.1)	6.9	7.0			20.9	4
5 RIVEROS LUIS_RICARDO (COL)	021 GOJUSHIHO SHO	(6.9)	6.8	(6.7)	6.8	6.8			20.4	5
6 VERA_BISONO YUSEF (VOLQUEZ)	064 OHAN DAI	(7.4)	(7.1)	7.2	7.2	7.2			21.6	3

R2-G1 Tatami 4 09:55(2023-03-02)

Competitors	Kata	1	2	3	4	5	6	7	TOTAL	Extra Total Rank
1 GRECO GIANLUCA (KARATE DO)	068 PAPUREN	(7.4)	(7.9)	7.4	7.4	7.4			22.2	2
2 HONORATO_ARRIAGA DANTE_ZAHIR (MEX)	068 PAPUREN	7.0	(7.5)	7.0	(6.9)	7.2			21.2	4
3 GRANADOS_HERRERA ANGEL_EMILIO (FSK)	008 CHATANYARA KUSHANKU	7.2	(7.6)	7.2	7.2	(7.0)			21.6	3
4 LIZARDO_REYES GERMAN_EDUARDO (VOLQUEZ)	015 GANKAKU	(7.3)	(7.9)	7.5	7.7	7.5			22.7	1

R2-G2 Tatami 4 10:10(2023-03-02)

Competitors	Kata	1	2	3	4	5	6	7	TOTAL	Extra Total Rank
1 VERA_BISONO YUSEF (VOLQUEZ)	002 ANAN DAI	(7.4)	7.4	7.0	(6.8)	7.2			21.6	3
2 RODRIGUEZ SEBASTIAN (FECOKA)	020 GOJUSHIHO DAI	(7.0)	(7.3)	7.2	7.0	7.0			21.2	4
3 LAFEE DIEGO (KARATE DO)	099 UNSU	7.4	7.5	7.4	(7.6)	(7.3)			22.3	1
4 GARCIA_VALADEZ JUAN_PABLO (MEX)	092 SUPARINPEI	(7.2)	(7.6)	7.2	7.3	7.5			22.0	2

R3 Bronze Medal Match 1 Tatami 4 10:25(2023-03-02)

Competitors	Kata	1	2	3	4	5	6	7	TOTAL	Extra Total Rank
1 GRECO GIANLUCA (KARATE DO)	065 OYADOMARI NO PASSAI	(7.4)	7.5	7.4	7.4	(7.9)			22.3	1
2 VERA_BISONO YUSEF (VOLQUEZ)	008 CHATANYARA KUSHANKU	7.2	7.3	(6.8)	7.1	(7.7)			21.6	2





R3 Bronze Medal Match 2 Tatami 4 10:35(2023-03-02)

Competitors	Kata	1	2	3	4	5	6	7	TOTAL	Extra Total Rank
1 GRANADOS_HERRERA ANGEL_EMILIO (FSK)	001 ANAN	7.3	(8.0)	(7.2)	7.3	7.3			21.9	2
2 GARCIA_VALADEZ JUAN_PABLO (MEX)	009 CHIBANA NO KUSHANKU	7.2	(8.2)	7.6	(7.1)	7.5			22.3	1







R3 Gold Medal Match Tatami 4 10:45(2023-03-02)

Competitors	Kata	1	2	3	4	5	6	7	TOTAL	Extra Total Rank
1 LIZARDO_REYES GERMAN_EDUARDO (VOLQUEZ)	020 GOJUSHIHO DAI	(7.4)	7.5	7.5	7.5	(7.7)			22.5	2
2 LAFEE DIEGO (KARATE DO)	015 GANKAKU	7.5	(7.3)	(8.1)	7.3	7.9			22.7	1

Results

1 LAFEE DIEGO	KARATE DO		VENEZUELA
2 LIZARDO REYES GERMAN EDUARDO	VOLQUEZ		DOMINICAN REPUBLIC
3 GRECO GIANLUCA	KARATE DO		VENEZUELA
3 GARCIA VALADEZ JUAN PABLO	MEXICO		MEXICO
5 VERA BISONO YUSEF	VOLQUEZ		DOMINICAN REPUBLIC

**Campeonato Centroamericano y del
Caribe de Karate 2023 - 2023-03-02
Cadet Kata Male**

5	GRANADOS HERRERA ANGEL EMILIO	FSK		EL SALVADOR
7	HONORATO ARRIAGA DANTE ZAHIR	MEXICO		MEXICO
7	RODRIGUEZ SEBASTIAN	FEDERACION COSTARRICENSE DE KARATE		COSTA RICA
9	JIMENEZ MATIAS	FEDERACION COSTARRICENSE DE KARATE		COSTA RICA
9	RIVEROS LUIS RICARDO	COLOMBIA		COLOMBIA
11	CASTRO OSCAR ALEJANDRO	COLOMBIA		COLOMBIA
11	MORENO CASTRO CESAR ENRIQUE	FSK		EL SALVADOR

CADET KUMITE FEMALE -47 KG

Campeonato Centroamericano y del Caribe de Karate 2023, Carretera Cocoyoc - Oaxtepec Km 2.5, Centro, 62738 Oaxtepec, MEX

2023-03-02

Tatami
4 12:10

Pool
1/1

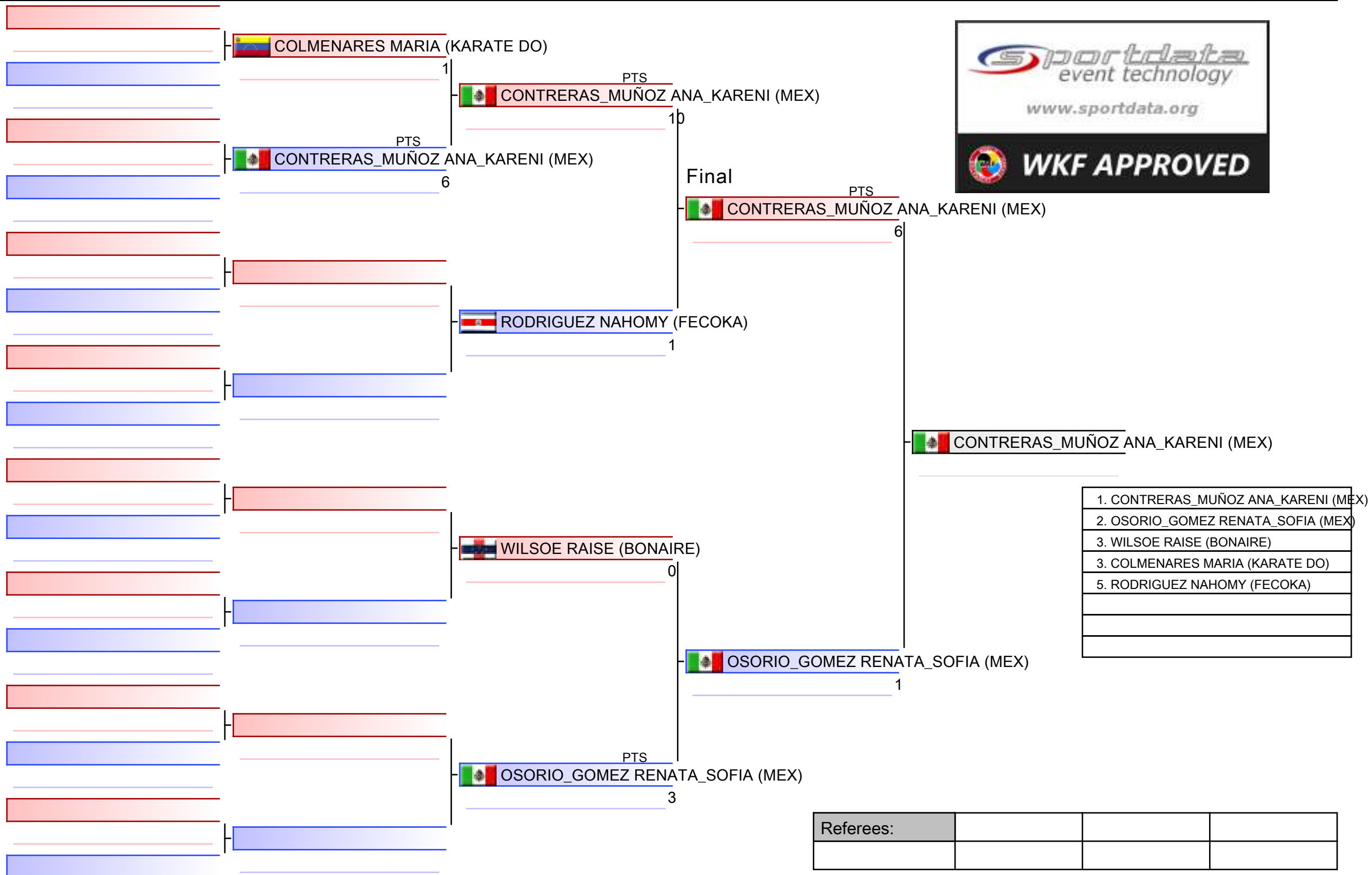

1. CONTRERAS_MUÑOZ ANA_KARENI (MEX)
2. OSORIO_GOMEZ RENATA_SOFIA (MEX)
3. WILSOE RAISE (BONAIRE)
3. COLMENARES MARIA (KARATE DO)
5. RODRIGUEZ NAHOMY (FECOKA)

Referees:			

CADET KUMITE FEMALE -47 KG

Campeonato Centroamericano y del Caribe de Karate 2023

2023-03-02

Tatami
4 12:25

Pool
1

(c)sportdata GmbH & Co KG 2000-2023 (2023-03-04 18:02) v 10.0.0 build 1 (2023-02-10) License: Online_Event_ID-6936_CampeonatoCentroamericanoydelCaribedeKarate2023 (expire 2023-03-18)

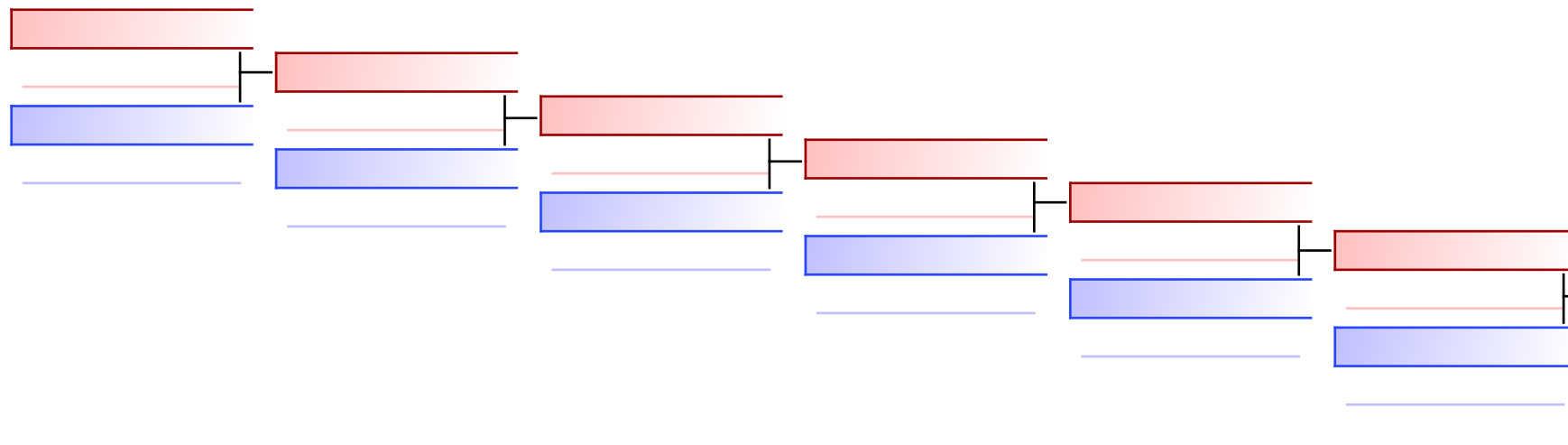

PTS	
COLMENARES MARIA (KARATE DO)	6
RODRIGUEZ NAHOMY (FECOKA)	0

REPECHAGE: (1)

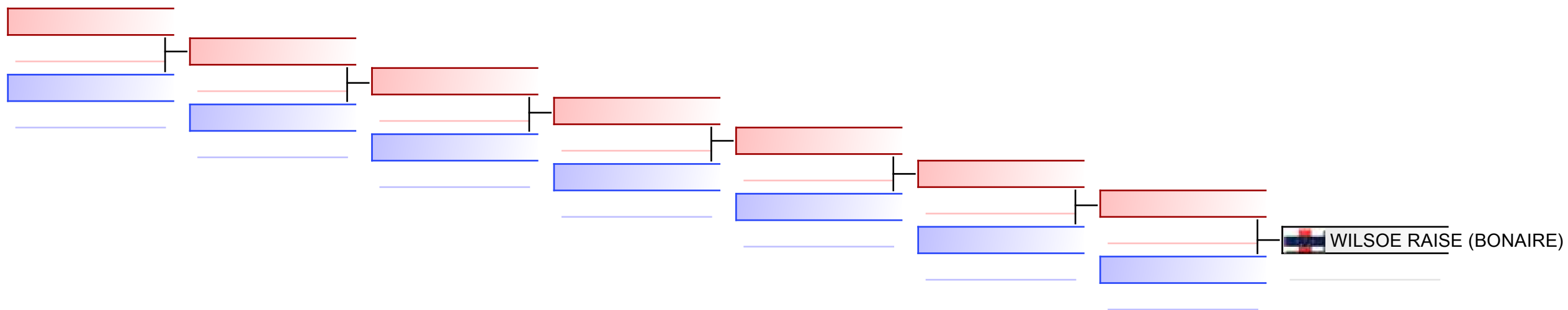

Referees:							
-----------	--	--	--	--	--	--	--

CADET KUMITE FEMALE -54 KG

Campeonato Centroamericano y del Caribe de Karate 2023, Carretera Cocoyoc - Oaxtepec Km 2.5, Centro, 62738 Oaxtepec, MEX

2023-03-02

Tatami
4 12:45

Pool
1/1

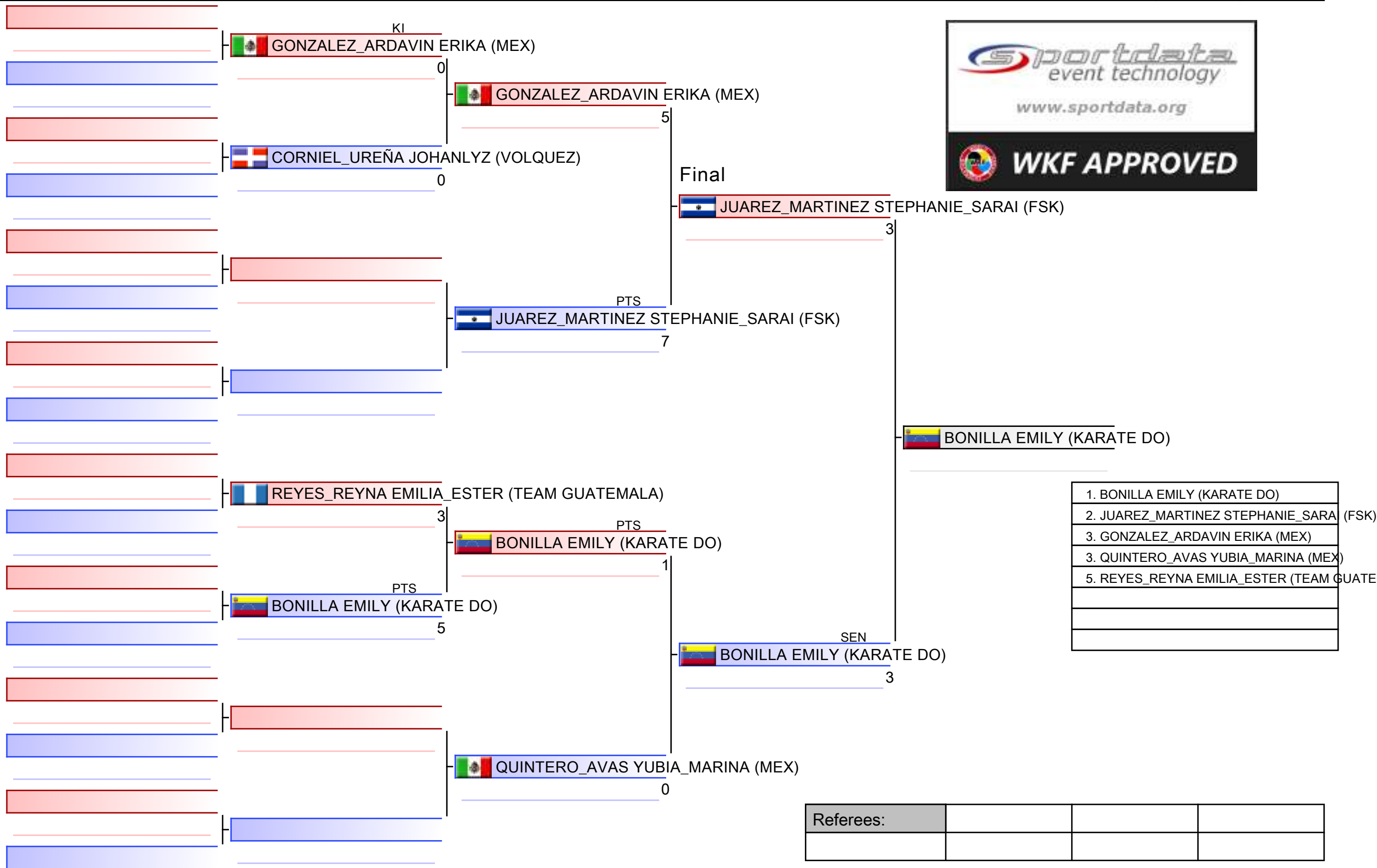

CADET KUMITE FEMALE -54 KG

Campeonato Centroamericano y del Caribe de Karate 2023

2023-03-02

Tatami
4 13:05

Pool
1

(c)sportdata GmbH & Co KG 2000-2023 (2023-03-04 18:02) v 10.0.0 build 1 (2023-02-10) License: Online_Event_ID-6936_CampeonatoCentroamericanoydelCaribedeKarate2023 (expire 2023-03-18)

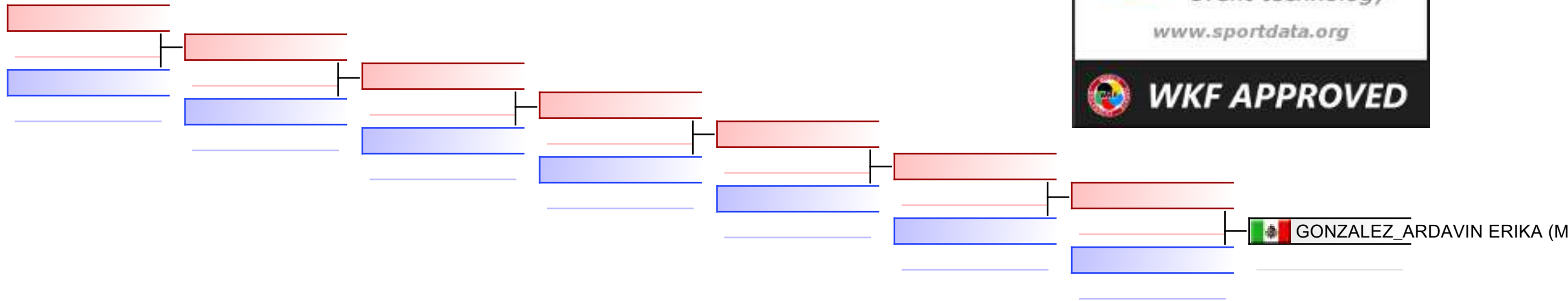

REPECHAGE: (1)

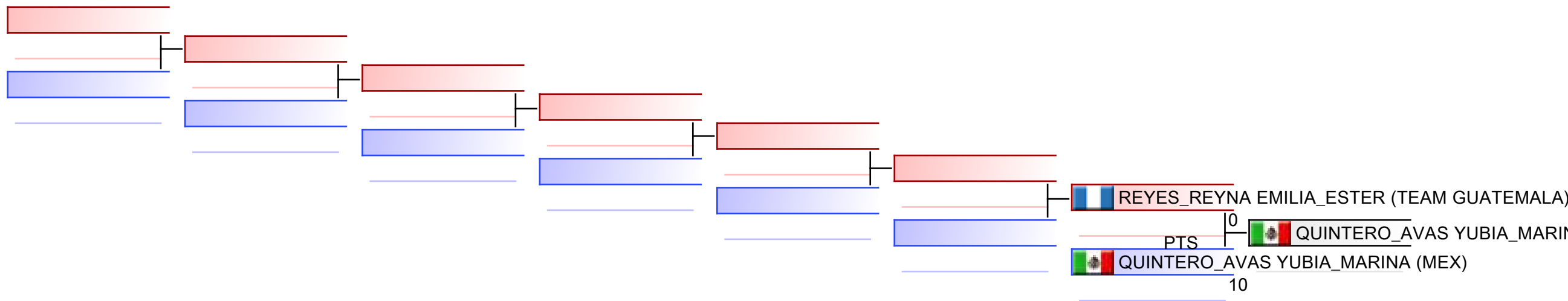

Referees:							
-----------	--	--	--	--	--	--	--

CADET KUMITE FEMALE -61 KG

Campeonato Centroamericano y del Caribe de Karate 2023, Carretera Cocoyoc - Oaxtepec Km 2.5, Centro, 62738 Oaxtepec, MEX

2023-03-02

Tatami
3 12:40

Pool
1/1

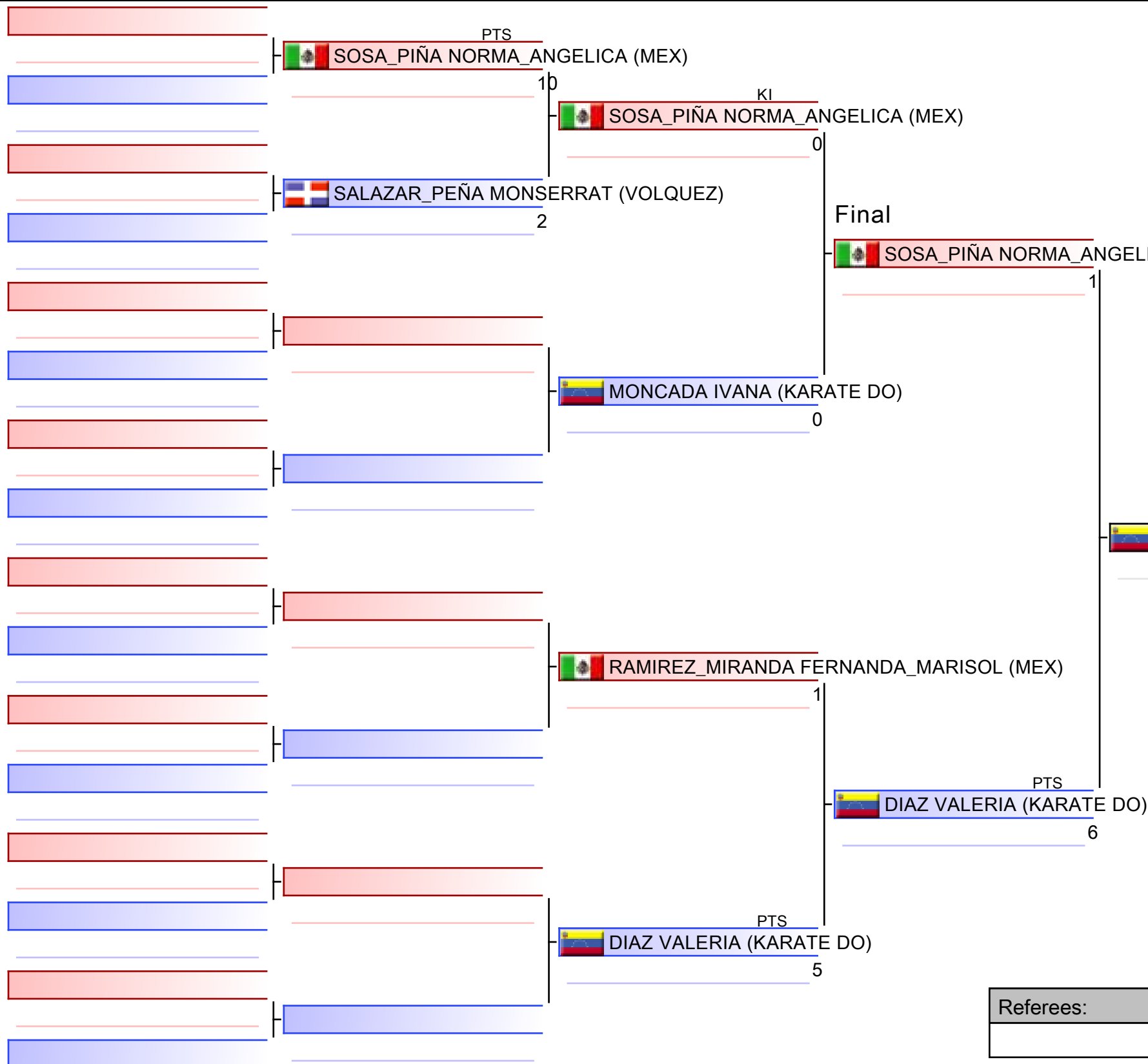

1. DIAZ VALERIA (KARATE DO)
2. SOSA_PIÑA NORMA_ANGELICA (MEX)
3. RAMIREZ_MIRANDA FERNANDA_MARISOL (MEX)
3. SALAZAR_PEÑA MONSERRAT (VOLQUEZ)
5. MONCADA IVANA (KARATE DO)

Referees:			

CADET KUMITE FEMALE -61 KG

Campeonato Centroamericano y del Caribe de Karate 2023

2023-03-02

Tatami
3 12:55

Pool
1

(c)sportdata GmbH & Co KG 2000-2023 (2023-03-04 18:03) v 10.0.0 build 1 (2023-02-10) License: Online_Event_ID-6936_CampeonatoCentroamericanoydelCaribedeKarate2023 (expire 2023-03-18)

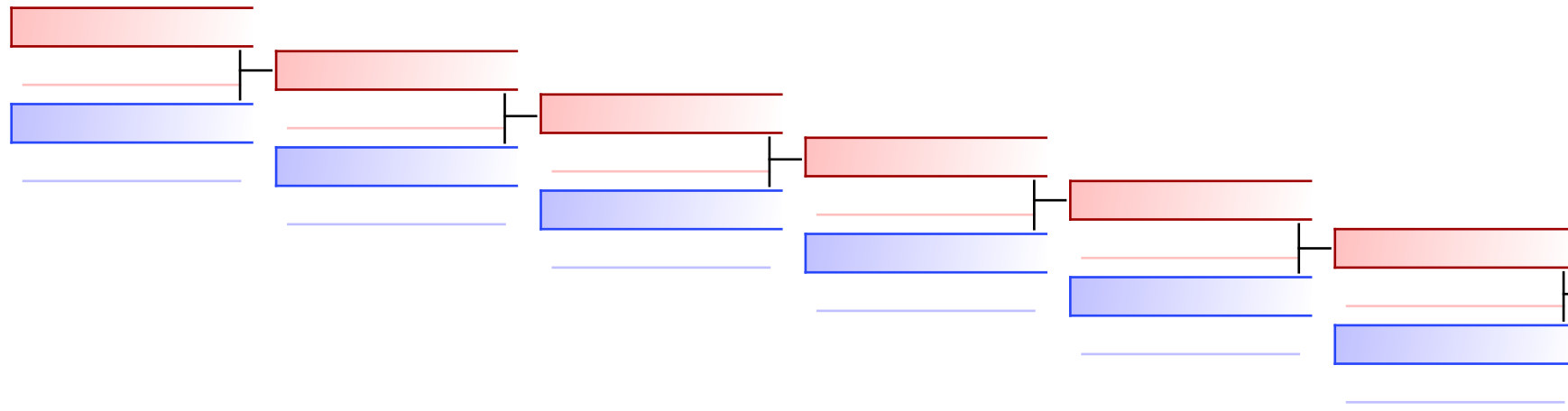

 SALAZAR_PEÑA MONSERRAT (VOLQUEZ)
KI  SALAZAR_PEÑA MONSERRAT (VOLQUEZ)
 MONCADA IVANA (KARATE DO)

REPECHAGE: (1)

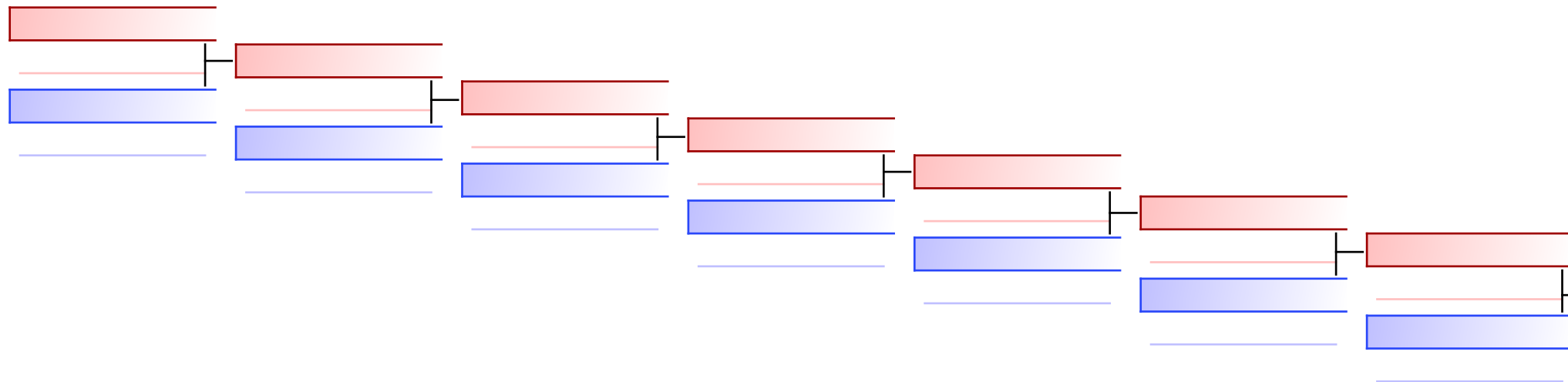

 RAMIREZ_MIRANDA FERNANDA

Referees:							
-----------	--	--	--	--	--	--	--

CADET KUMITE FEMALE 61+ KG

Campeonato Centroamericano y del Caribe de Karate 2023, Carretera Cocoyoc - Oaxtepec Km 2.5, Centro, 62738 Oaxtepec, MEX

2023-03-02

Tatami
4 13:25

Pool
1/1

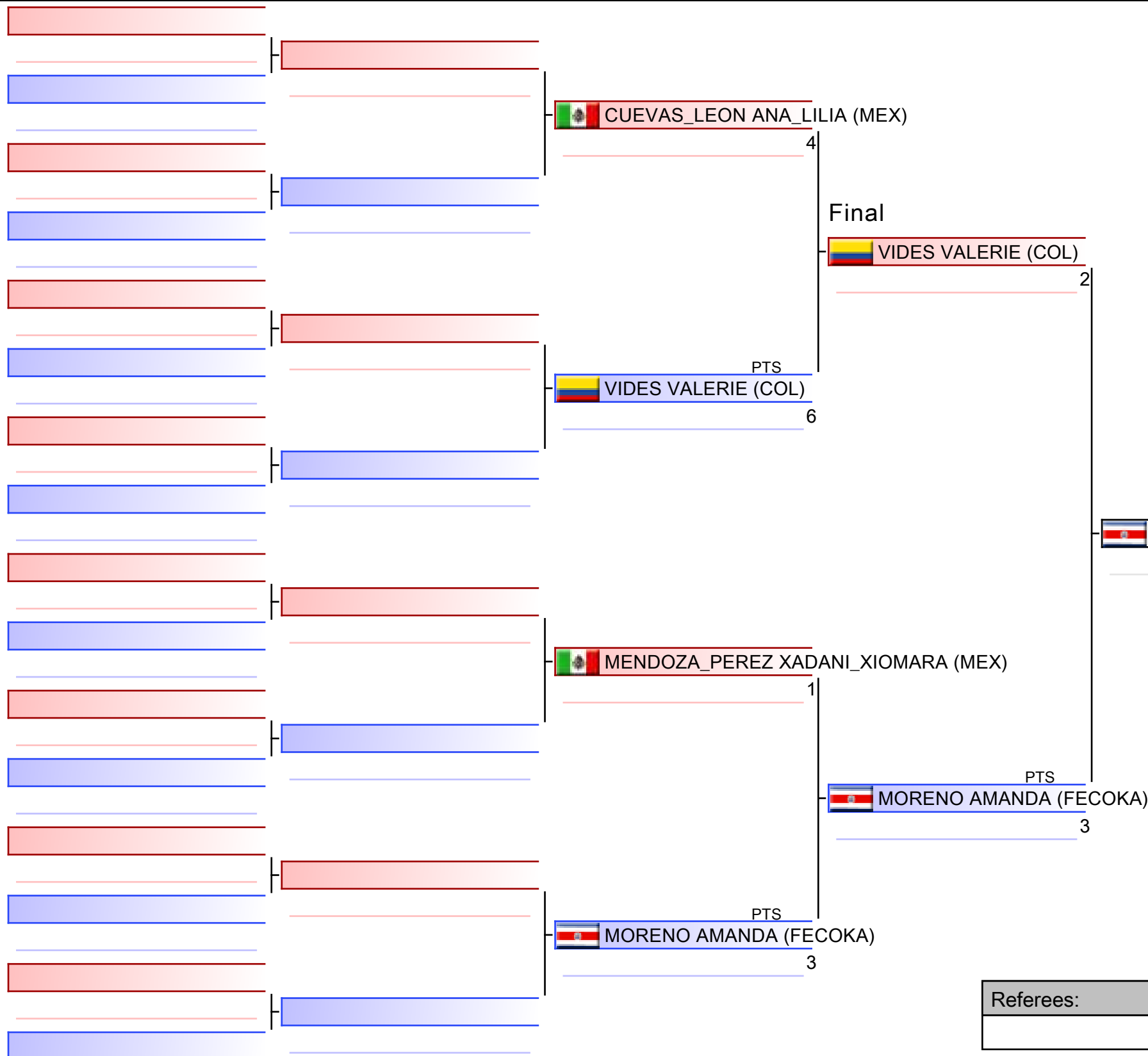

MORENO AMANDA (FECOKA)

1. MORENO AMANDA (FECOKA)
2. VIDES VALERIE (COL)
3. CUEVAS_LEON ANA_LILIA (MEX)
3. MENDOZA_PEREZ XADANI_XIOMARA (MEX)

Referees:			

CADET KUMITE FEMALE 61+ KG

Campeonato Centroamericano y del Caribe de Karate 2023

Tatami

Pool
1

(c)sportdata GmbH & Co KG 2000-2023 (2023-03-04 18:03) v 10.0.0 build 1 (2023-02-10) License: Online_Event_ID-6936_CampeonatoCentroamericanoydelCaribedeKarate2023 (expire 2023-03-18)

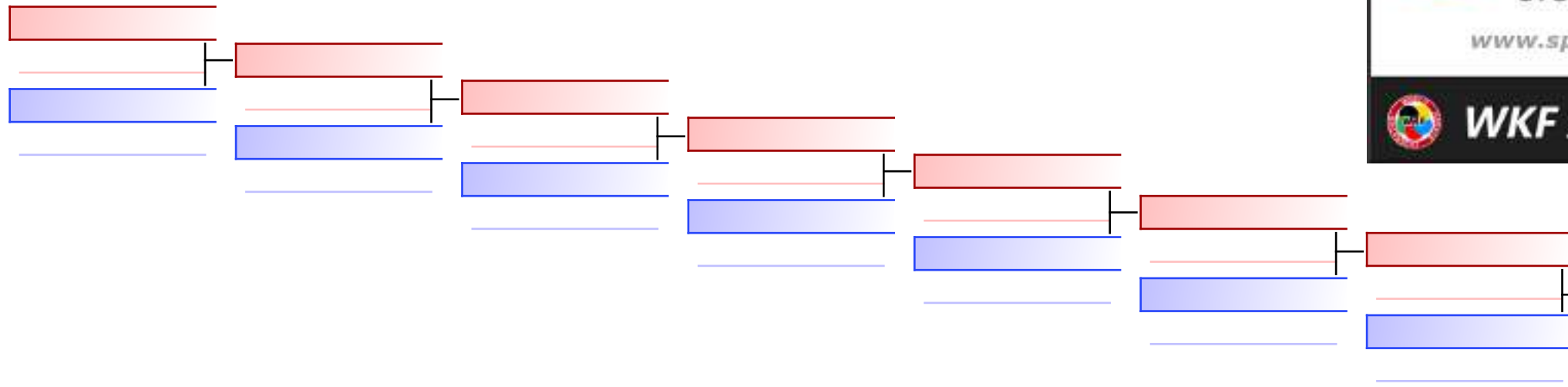

REPECHAGE: (1)

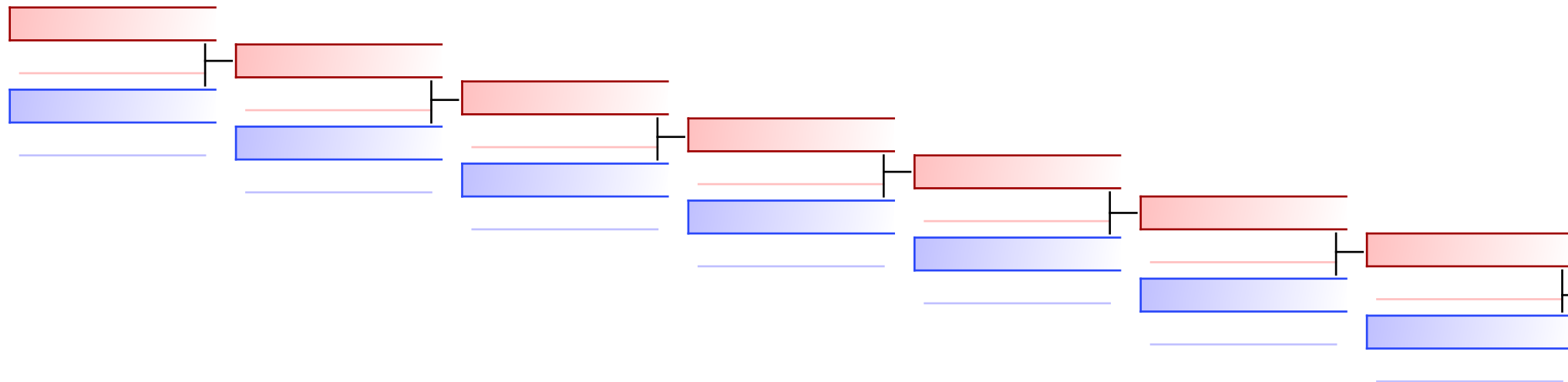

Referees:							
-----------	--	--	--	--	--	--	--

CADET KUMITE MALE -52 KG

Campeonato Centroamericano y del Caribe de Karate 2023, Carretera Cocoyoc - Oaxtepec Km 2.5, Centro, 62738 Oaxtepec, MEX

2023-03-02

Tatami
1 12:10

Pool
1/1

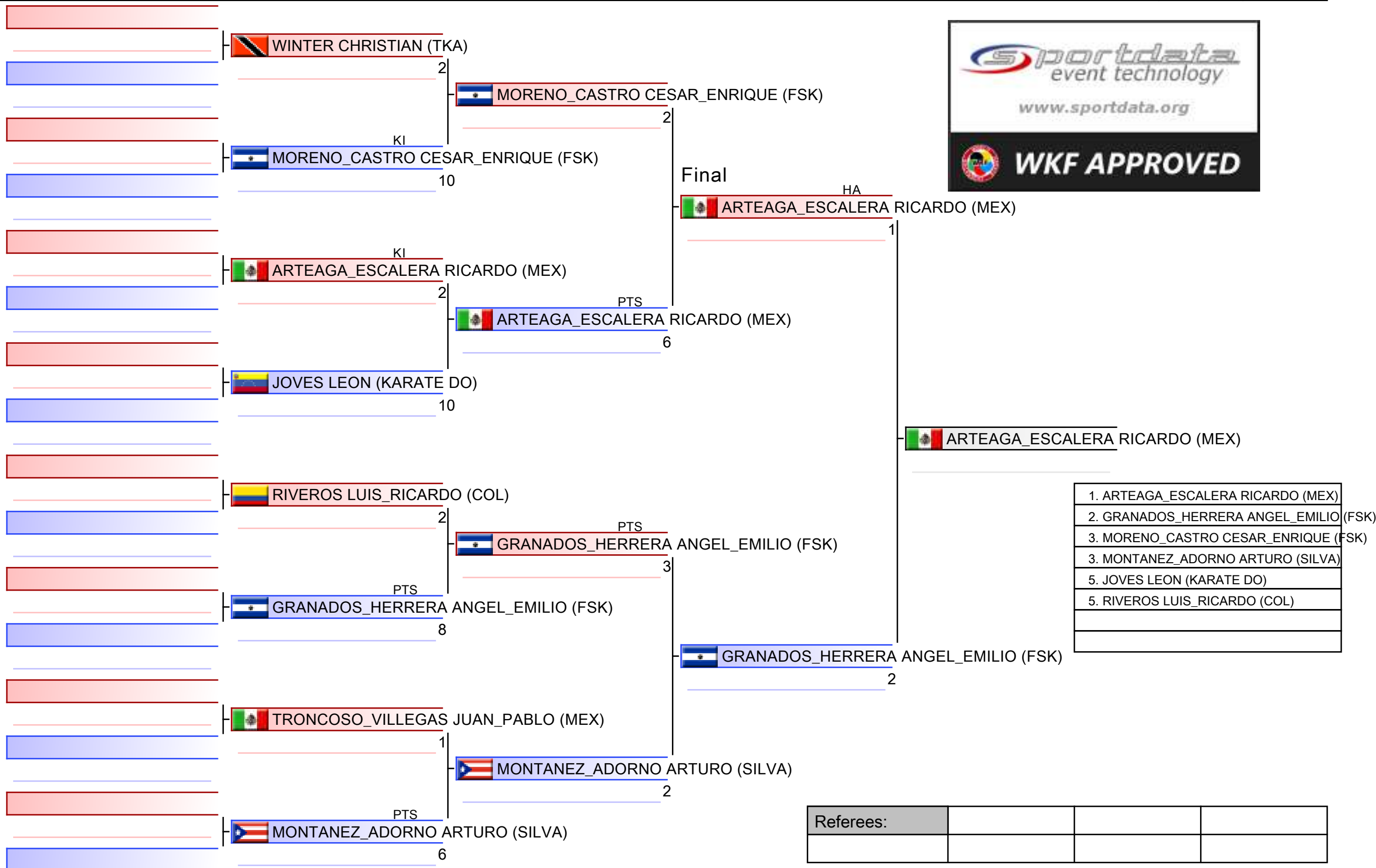

1. ARTEAGA_ESCALERA RICARDO (MEX)
2. GRANADOS_HERRERA ANGEL_EMILIO (FSK)
3. MORENO_CASTRO CESAR_ENRIQUE (FSK)
3. MONTANEZ_ADORNO ARTURO (SILVA)
5. JOVES LEON (KARATE DO)
5. RIVEROS LUIS_RICARDO (COL)

Referees:			

CADET KUMITE MALE -52 KG

Campeonato Centroamericano y del Caribe de Karate 2023

2023-03-02

Tatami
1 12:40

Pool
1

(c)sportdata GmbH & Co KG 2000-2023 (2023-03-04 18:03) v 10.0.0 build 1 (2023-02-10) License: Online_Event_ID-6936_CampeonatoCentroamericanoydelCaribedeKarate2023 (expire 2023-03-18)

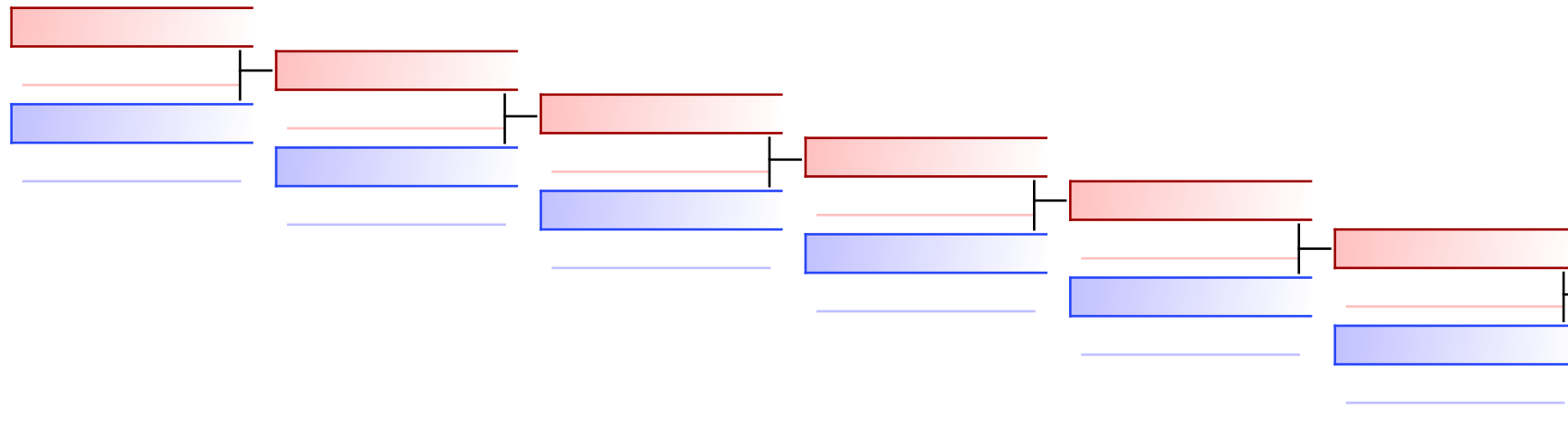

JOVES LEON (KARATE DO)
 KI | 0
 MORENO_CASTRO CESAR_ENR
 MORENO_CASTRO CESAR_ENRIQUE (FSK)
 0

REPECHAGE: (1)

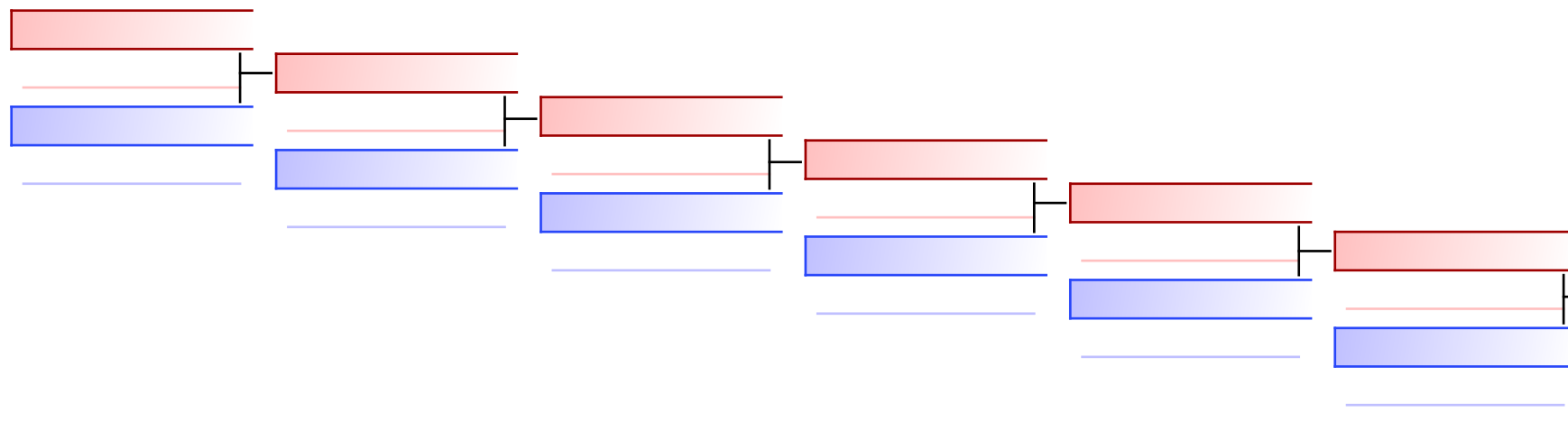

RIVEROS LUIS_RICARDO (COL)
 PTS | 1
 MONTANEZ_ADORNO ARTURO
 MONTANEZ_ADORNO ARTURO (SILVA)
 6

Referees:							
-----------	--	--	--	--	--	--	--

CADET KUMITE MALE -57 KG

Campeonato Centroamericano y del Caribe de Karate 2023, Carretera Cocoyoc - Oaxtepec Km 2.5, Centro, 62738 Oaxtepec, MEX

2023-03-02

Tatami
2 12:15

Pool
1/1

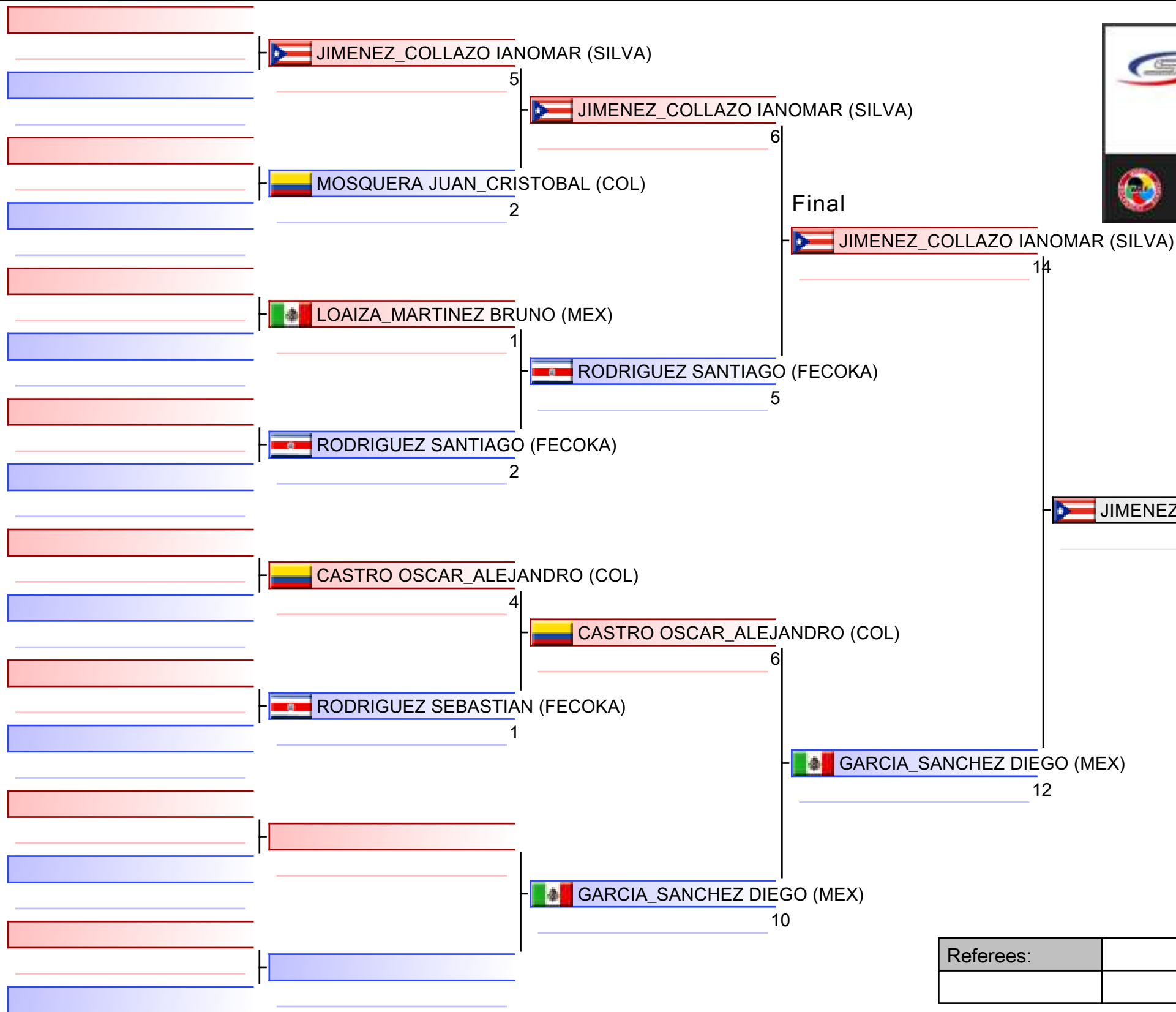

1. JIMENEZ_COLLAZO IANOMAR (SILVA)
2. GARCIA_SANCHEZ DIEGO (MEX)
3. CASTRO OSCAR_ALEJANDRO (COL)
3. RODRIGUEZ SANTIAGO (FECOKA)
5. MOSQUERA JUAN_CRISTOBAL (COL)

Referees:			

CADET KUMITE MALE -57 KG

Campeonato Centroamericano y del Caribe de Karate 2023

2023-03-02

Tatami
2 12:40

Pool
1

(c)sportdata GmbH & Co KG 2000-2023 (2023-03-04 18:03) v 10.0.0 build 1 (2023-02-10) License: Online_Event_ID-6936_CampeonatoCentroamericanoydelCaribedeKarate2023 (expire 2023-03-18)

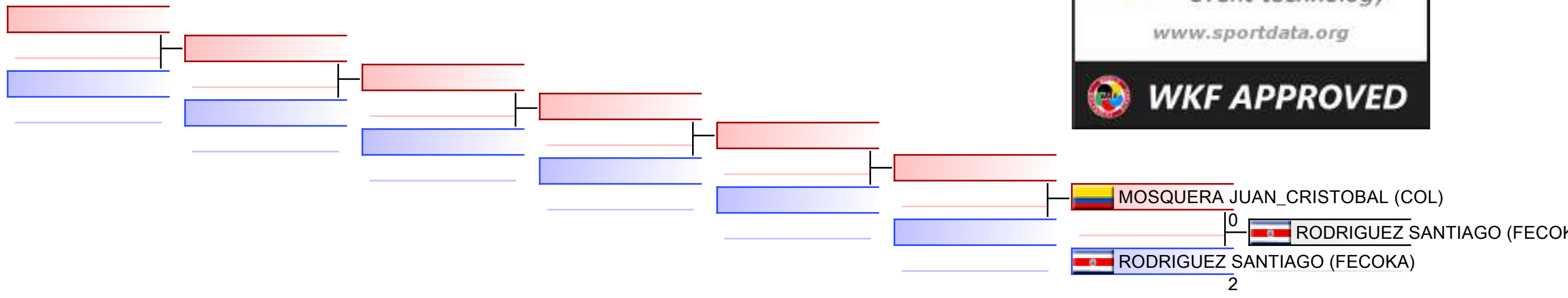

REPECHAGE: (1)

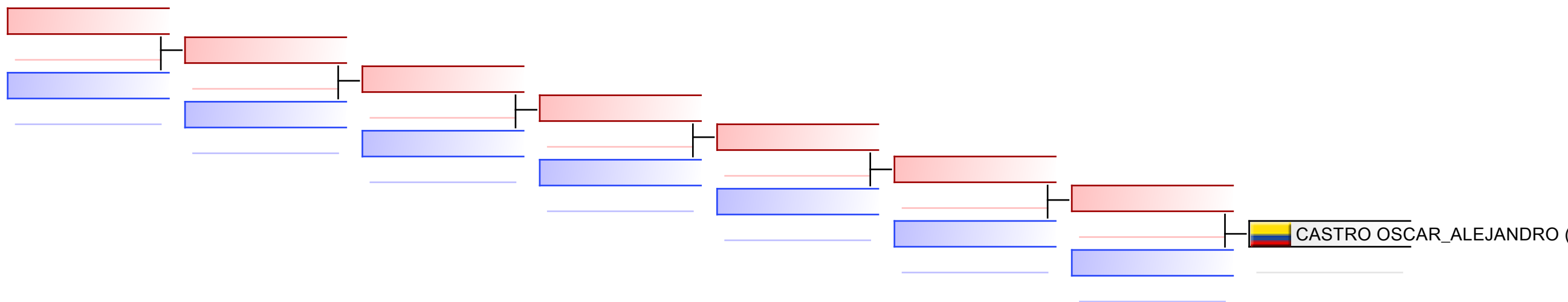

Referees:							
-----------	--	--	--	--	--	--	--

CADET KUMITE MALE -63 KG

Campeonato Centroamericano y del Caribe de Karate 2023, Carretera Cocoyoc - Oaxtepec Km 2.5, Centro, 62738 Oaxtepec, MEX

2023-03-02

Tatami
1 13:00

Pool
1/1

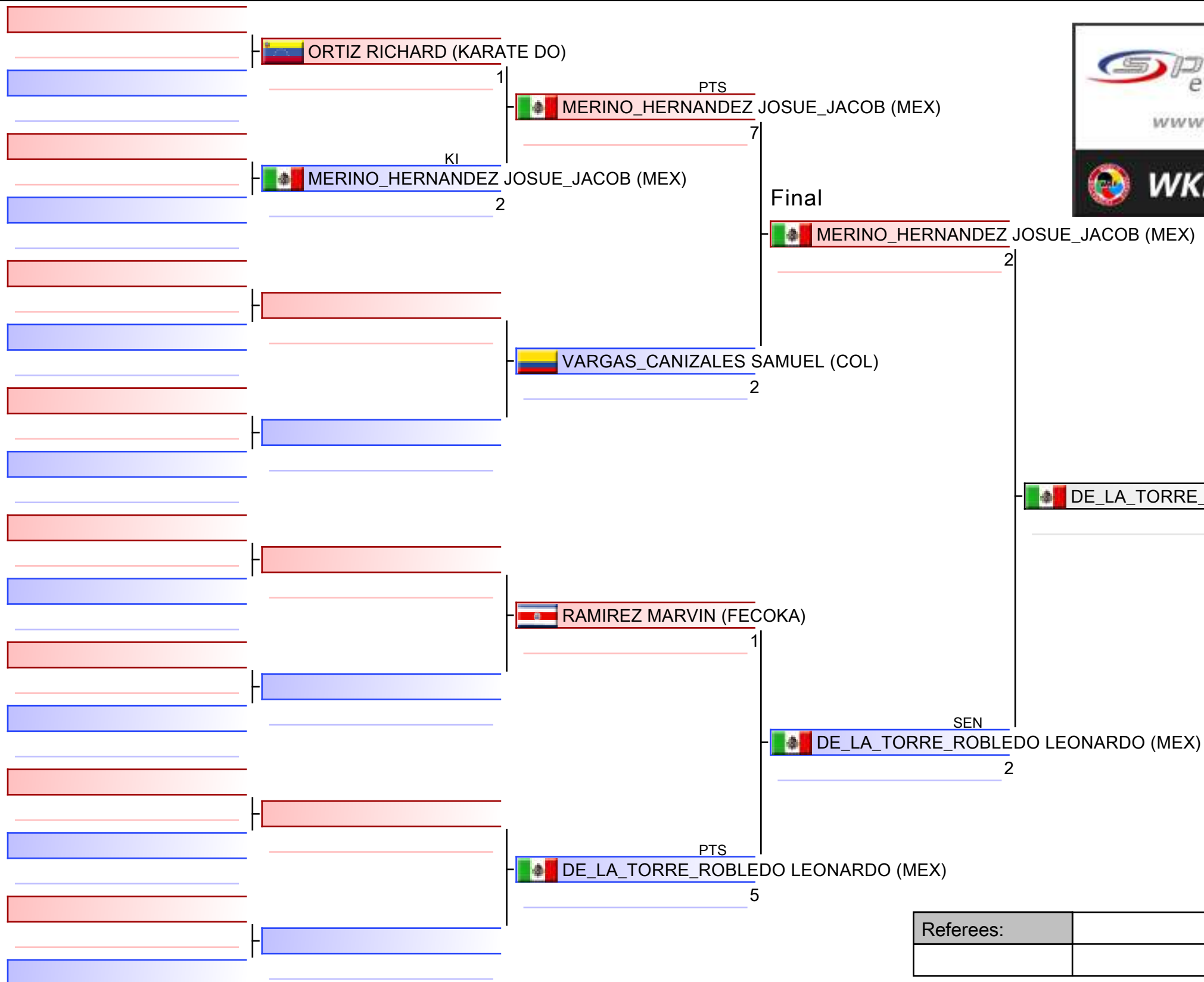

1. DE_LA_TORRE_ROBLEDO LEONARDO (MEX)
2. MERINO_HERNANDEZ JOSUE_JACOB (MEX)
3. RAMIREZ MARVIN (FECOKA)
3. VARGAS_CANIZALES SAMUEL (COL)
5. ORTIZ RICHARD (KARATE DO)

Referees:			

CADET KUMITE MALE -63 KG

Campeonato Centroamericano y del Caribe de Karate 2023



2023-03-02

Tatami
1 13:15

Pool
1

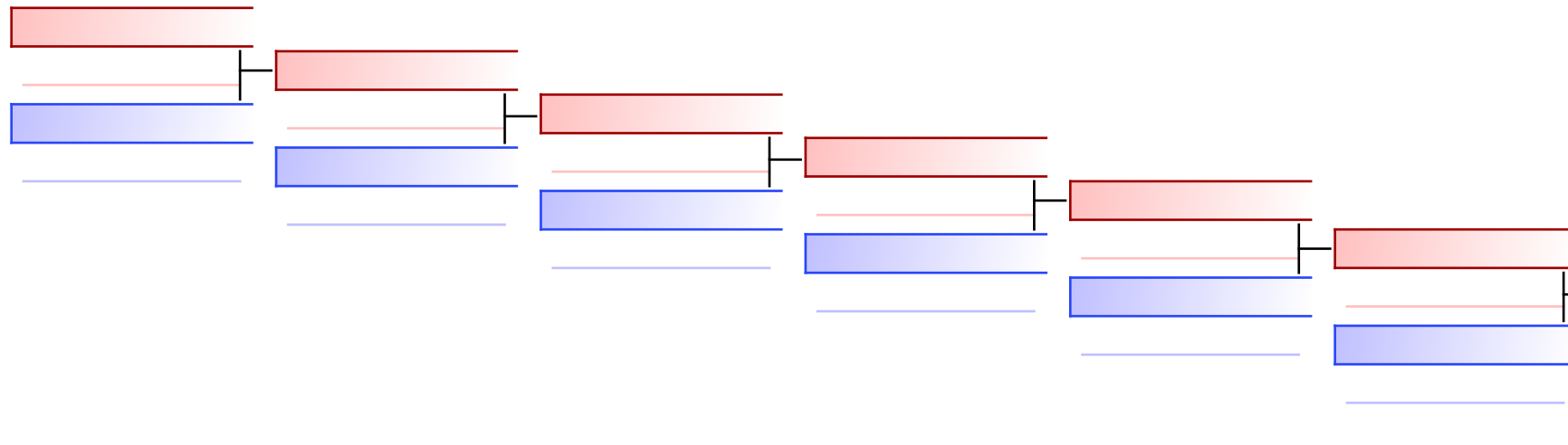
(c)sportdata GmbH & Co KG 2000-2023 (2023-03-04 18:03) v 10.0.0 build 1 (2023-02-10) License: Online_Event_ID-6936_CampeonatoCentroamericanoydelCaribedeKarate2023 (expire 2023-03-18)



 **ORTIZ RICHARD (KARATE DO)**
KI  **VARGAS_CANIZALES SAMUEL (COL)**

REPECHAGE: (1)

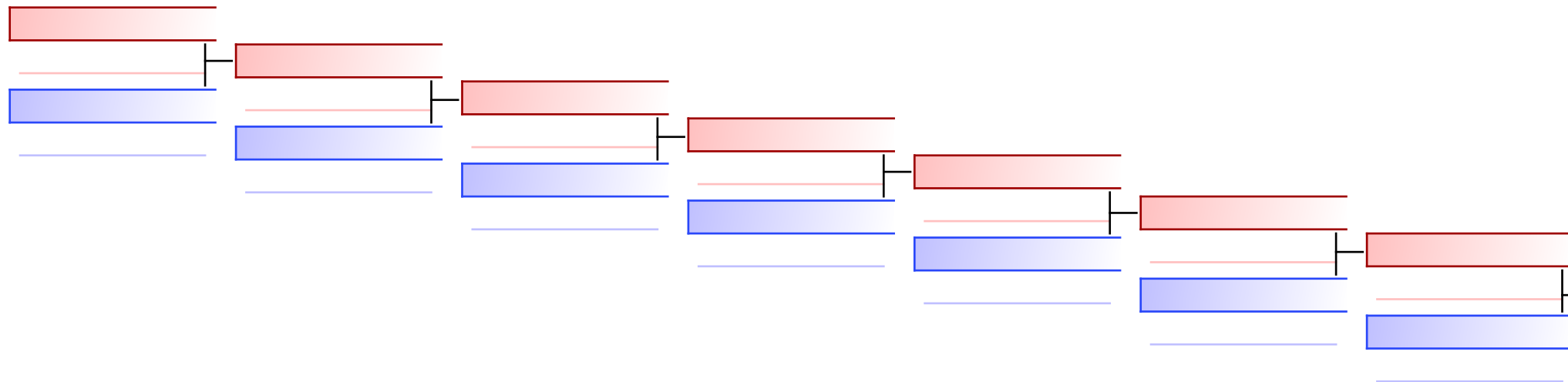

 **RAMIREZ MARVIN (FECOKA)**

Referees:							
-----------	--	--	--	--	--	--	--

CADET KUMITE MALE -70 KG

Campeonato Centroamericano y del Caribe de Karate 2023, Carretera Cocoyoc - Oaxtepec Km 2.5, Centro, 62738 Oaxtepec, MEX

2023-03-02

Tatami
2 13:00

Pool
1/1

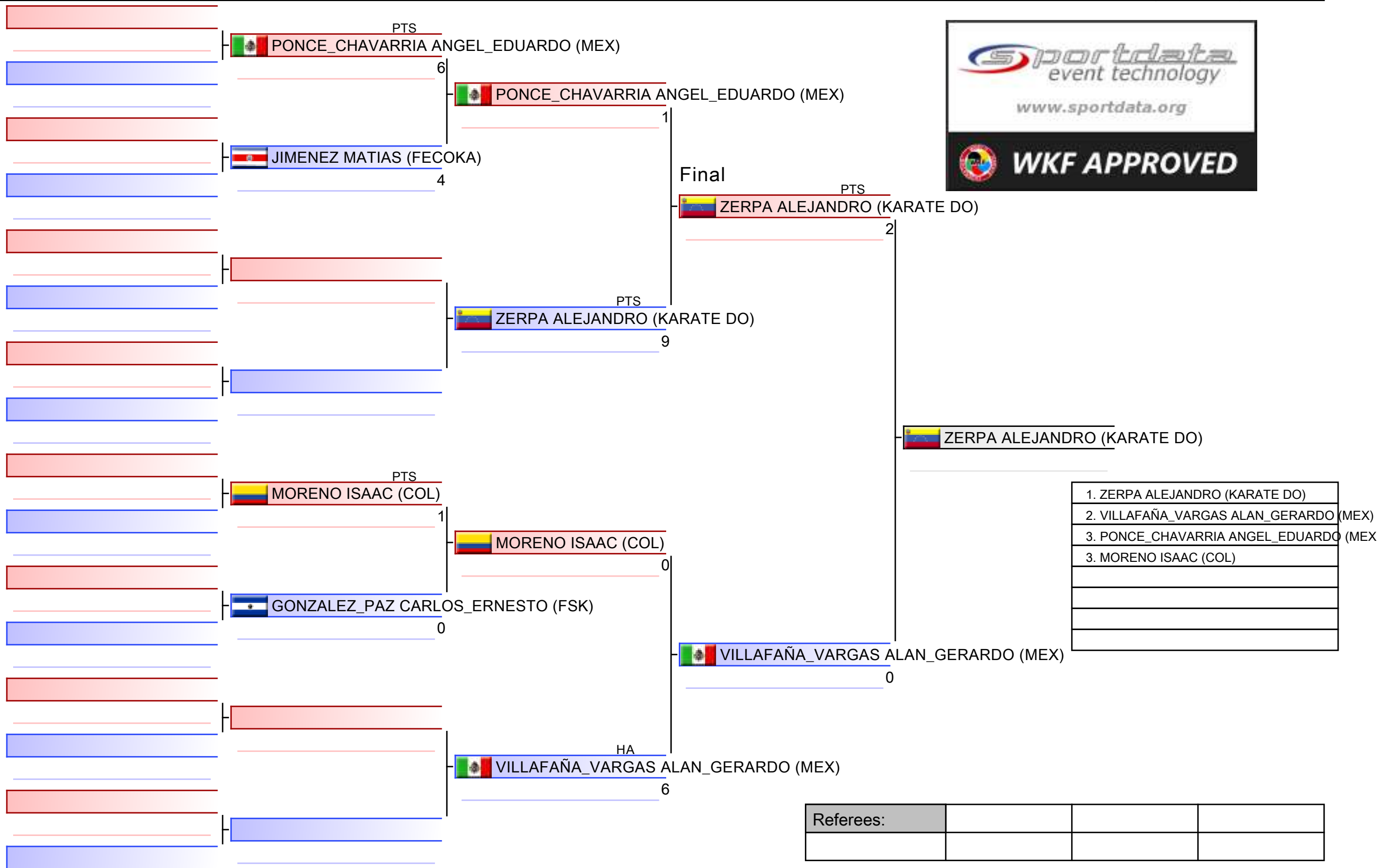

CADET KUMITE MALE -70 KG

Campeonato Centroamericano y del Caribe de Karate 2023

2023-03-02

Tatami
2 13:20

Pool
1

(c)sportdata GmbH & Co KG 2000-2023 (2023-03-04 18:03) v 10.0.0 build 1 (2023-02-10) License: Online_Event_ID-6936_CampeonatoCentroamericanoydelCaribedeKarate2023 (expire 2023-03-18)

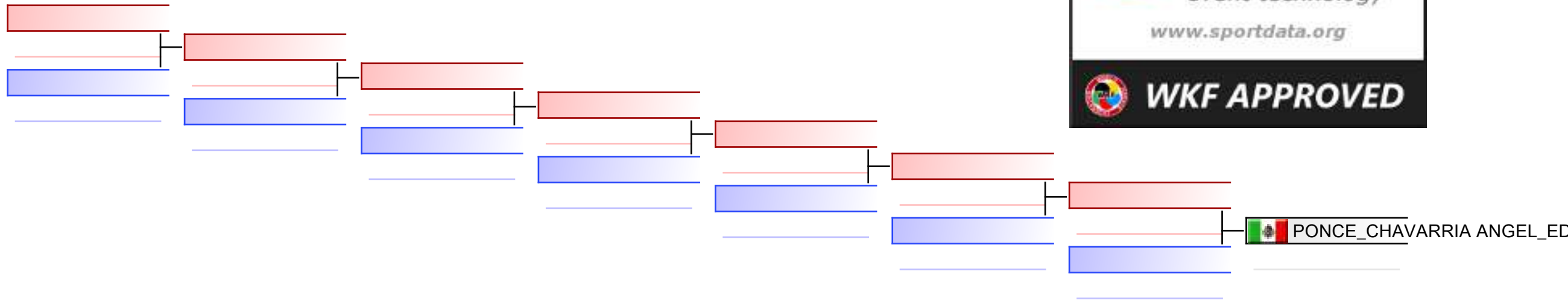

REPECHAGE: (1)

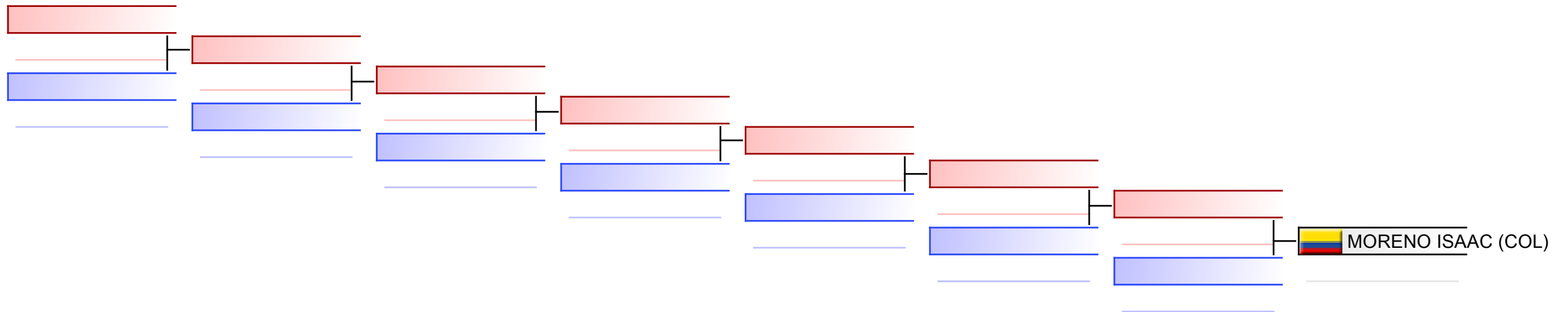

Referees:							
-----------	--	--	--	--	--	--	--

CADET KUMITE MALE 70+ KG

Campeonato Centroamericano y del Caribe de Karate 2023, Carretera Cocoyoc - Oaxtepec Km 2.5, Centro, 62738 Oaxtepec, MEX

2023-03-02

Tatami
1 13:35

Pool
1/1

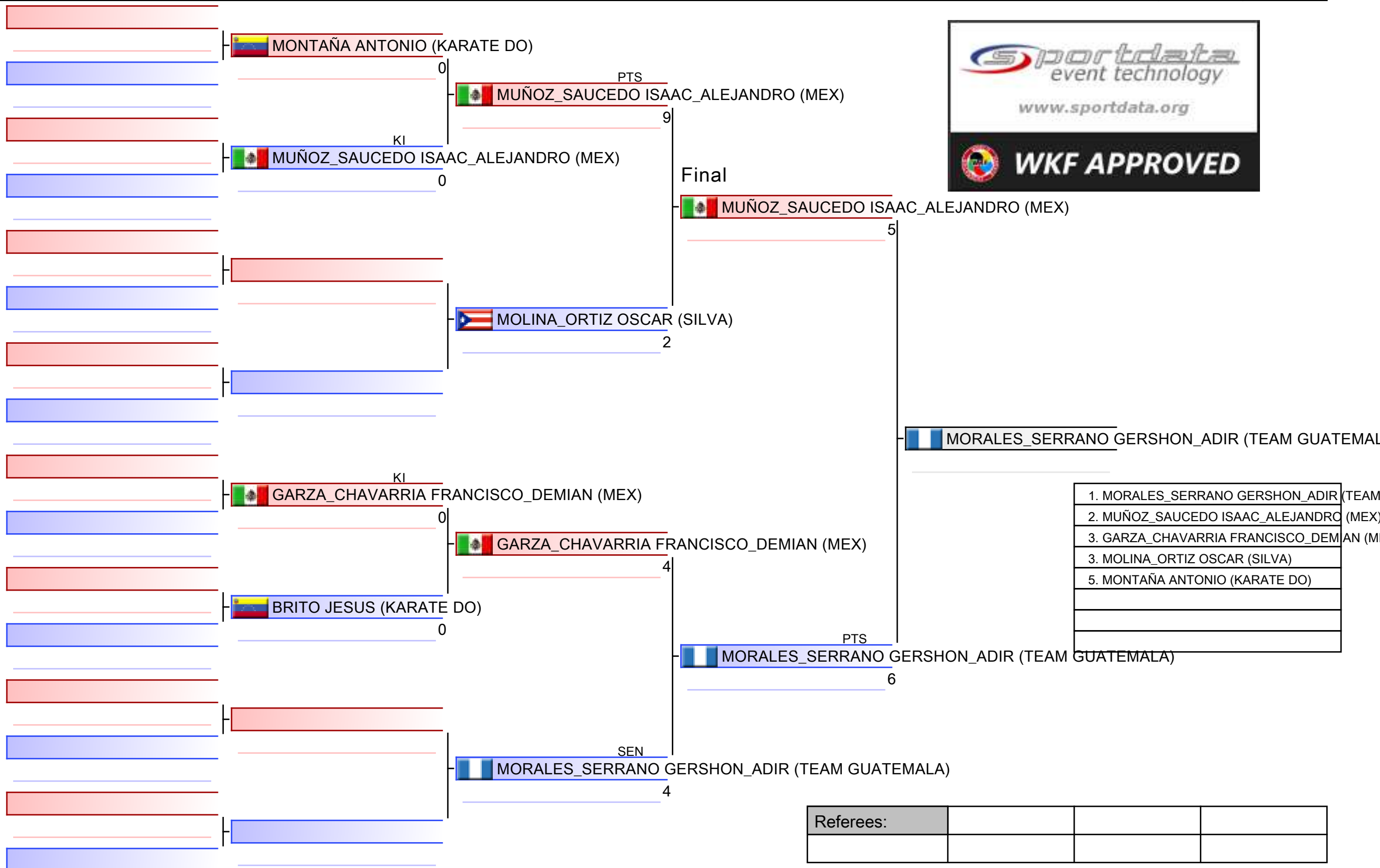

1. MORALES_SERRANO GERSHON_ADIR (TEAM GUATEMALA)
2. MUÑOZ_SAUCEDO ISAAC_ALEJANDRO (MEX)
3. GARZA_CHAVARRIA FRANCISCO_DEMIAN (MEX)
3. MOLINA_ORTIZ OSCAR (SILVA)
5. MONTAÑA ANTONIO (KARATE DO)

CADET KUMITE MALE 70+ KG

Campeonato Centroamericano y del Caribe de Karate 2023

2023-03-02

Tatami
1 13:55

Pool
1

(c)sportdata GmbH & Co KG 2000-2023 (2023-03-04 18:03) v 10.0.0 build 1 (2023-02-10) License: Online_Event_ID-6936_CampeonatoCentroamericanoydelCaribedeKarate2023 (expire 2023-03-18)

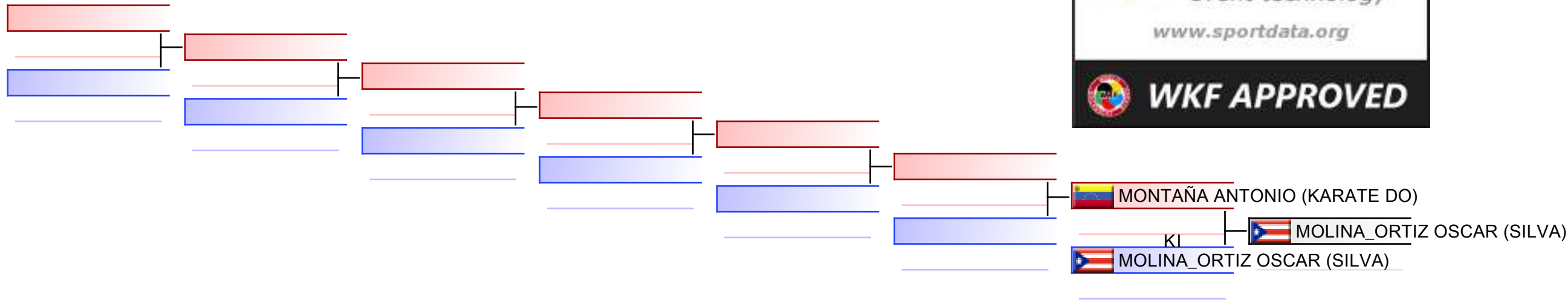

REPECHAGE: (1)

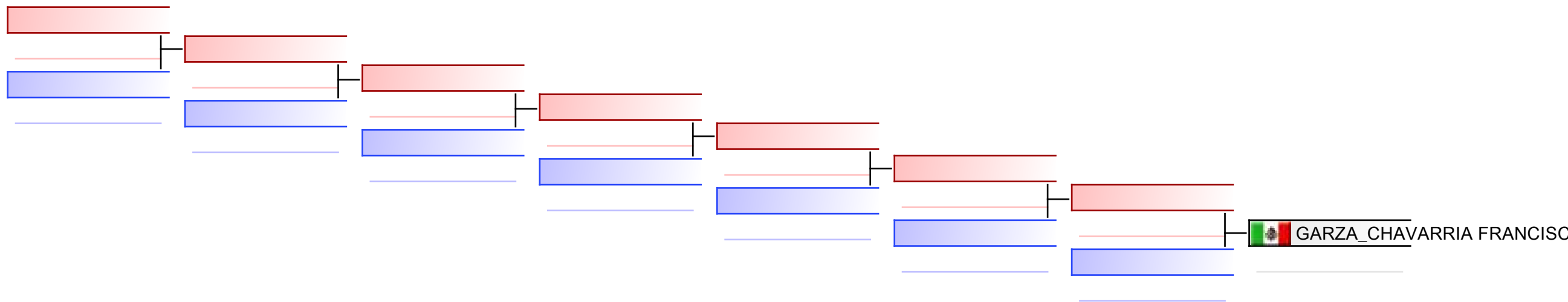

Referees:							
-----------	--	--	--	--	--	--	--

**Campeonato Centroamericano y del
Caribe de Karate 2023 - 2023-03-02**

Female kata

R1 G1/2 (10) Tatami 1 09:00(2023-03-04)

Competitors	Kata	1	2	3	4	5	6	7	TOTAL	Extra Total Rank
1 OCANA LAYLA (SILVA)										
2 RODRIGUEZ SASHA_SERENA (VOLQUEZ)	068 PAPUREN	(7.2)	7.5	8.1	(8.2)	7.3			22.9	22.9 3
3 IZAGUIRRE_GALDAMEZ ESTEFANY_RACHEL (FSK)	008 CHATANYARA KUSHANKU	(7.4)	7.2	7.1	(7.0)	7.2			21.5	21.5 8
4 TINOCO_MUNOZ JOYSI (FENIKA DO)	068 PAPUREN	(7.5)	7.1	(6.9)	7.5	7.2			21.8	21.8 7
5 BURGOS_QUELLE CLAUDIA (TEAM)	009 CHIBANA NO KUSHANKU	7.3	(7.2)	7.6	(7.8)	7.3			22.2	22.2 6
6 SILVA YETSERI (KARATE DO)	065 OYADOMARI NO PASSAI	7.8	7.7	7.9	(8.0)	(7.3)			23.4	23.4 2
7 MONGE VALERIA (FECOKA)	021 GOJUSHIHO SHO	(7.9)	7.4	7.8	7.3	(7.2)			22.5	22.5 5
8 CRUZ_ROMANO VICTORIA (MEX)	002 ANAN DAI	(7.8)	7.5	7.6	7.6	(7.4)			22.7	22.7 4
9 SANDOVAL_COELLO GRACIA MARIA (FEDERACIÓN DE KARATE DE HONDURAS)	008 CHATANYARA KUSHANKU	6.9	6.9	(6.8)	6.8	(7.1)			20.6	20.6 9
10 ZAPATA_MACHADO VALENTINA (COL)	092 SUPARINPEI	8.2	7.8	8.0	(8.4)	(7.3)			24.0	24.0 1

R1 G2/2 (10) Tatami 2 09:00(2023-03-04)

Competitors	Kata	1	2	3	4	5	6	7	TOTAL	Extra Total Rank
1 BARRERA_PAC NATHALIE_GABRIELA (TEAM GUATEMALA)	001 ANAN	(7.8)	7.5	7.8	7.5	(7.4)			22.8	22.8 5
2 QUIROZ_CASTILLO YANETH (MEX)	009 CHIBANA NO KUSHANKU	7.7	(7.6)	7.7	7.6	(8.1)			23.0	23.0 3
3 PACHON_MUNOZ NATALIA_SOFIA (COL)	064 OHAN DAI	7.8	7.7	7.7	(7.5)	(7.9)			23.2	23.2 2
4 ZOLOTAROVA VALENTYNA (TEAM VALY 2020)	021 GOJUSHIHO SHO	7.5	7.2	7.4	(7.7)	(6.9)			22.1	22.1 9
5 SANCHEZ MARIANA (FECOKA)	020 GOJUSHIHO DAI	7.4	7.3	(7.6)	7.5	(7.0)			22.2	22.2 7
6 PERALTA_AQUINO PERLA_GISSELL (VOLQUEZ)	068 PAPUREN	7.6	(7.5)	7.7	7.6	(7.8)			22.9	22.9 4
7 GALAN_CRUZ HELEN_GEORGINA (FSK)	008 CHATANYARA KUSHANKU	7.4	7.4	(7.5)	7.5	(7.3)			22.3	22.3 6
8 MOHAN CHELSEA (TKA)										
9 ARGUELLO_BACA STEFAPHANY_FERNANDA_DE_LOS_ANGELES (FENIKA DO)	002 ANAN DAI	7.3	(7.4)	7.4	7.4	(7.1)			22.1	22.1 8
10 ARMADA ANDREA (KARATE DO)	021 GOJUSHIHO SHO	7.7	7.8	(7.6)	7.7	(8.2)			23.2	23.2 1

R2-G1 Tatami 1 09:45(2023-03-04)

Competitors	Kata	1	2	3	4	5	6	7	TOTAL	Extra Total Rank
1 CRUZ_ROMANO VICTORIA (MEX)	008 CHATANYARA KUSHANKU	(7.9)	7.5	(7.4)	7.6	7.5			22.6	22.6 4
2 RODRIGUEZ SASHA_SERENA (VOLQUEZ)	008 CHATANYARA KUSHANKU	(8.2)	(6.8)	7.9	7.4	8.1			23.4	23.4 2
3 SILVA YETSERI (KARATE DO)	064 OHAN DAI	8.1	(7.2)	(8.2)	7.2	7.9			23.2	23.2 3
4 ZAPATA_MACHADO VALENTINA (COL)	008 CHATANYARA KUSHANKU	(8.4)	(7.0)	8.3	7.4	8.3			24.0	24.0 1

R2-G2 Tatami 2 09:45(2023-03-04)

Competitors	Kata	1	2	3	4	5	6	7	TOTAL	Extra Total Rank
1 ARMADA ANDREA (KARATE DO)	099 UNSU	(7.7)	7.7	7.8	7.8	(8.0)			23.3	23.3 1
2 PERALTA_AQUINO PERLA_GISSELL (VOLQUEZ)	065 OYADOMARI NO PASSAI	(7.8)	7.6	7.5	7.5	(7.4)			22.6	22.6 4
3 PACHON_MUNOZ NATALIA_SOFIA (COL)	068 PAPUREN	(7.9)	7.5	7.7	(7.4)	7.8			23.0	23.0 3
4 QUIROZ_CASTILLO YANETH (MEX)	068 PAPUREN	7.7	7.8	(7.5)	7.7	(7.9)			23.2	23.2 2

R3 Bronze Medal Match 1 Tatami 1 10:05(2023-03-04)

Competitors	Kata	1	2	3	4	5	6	7	TOTAL	Extra Total Rank
1 RODRIGUEZ SASHA_SERENA (VOLQUEZ)	064 OHAN DAI	7.7	8.0	(8.2)	8.1	(7.4)			23.8	23.8 1
2 PACHON_MUNOZ NATALIA_SOFIA (COL)	002 ANAN DAI	7.4	7.5	(7.9)	7.9	(7.1)			22.8	22.8 2

R3 Bronze Medal Match 2 Tatami 2 10:05(2023-03-04)

Competitors	Kata	1	2	3	4	5	6	7	TOTAL	Extra Total Rank
1 SILVA YETSERI (KARATE DO)	068 PAPUREN	7.6	7.6	(7.7)	7.6	(7.0)			22.8	22.8 2
2 QUIROZ_CASTILLO YANETH (MEX)	008 CHATANYARA KUSHANKU	(7.8)	7.8	7.6	7.8	(6.8)			23.2	23.2 1

















R3 Gold Medal Match Tatami 1 10:15(2023-03-04)

**Campeonato Centroamericano y del
Caribe de Karate 2023 - 2023-03-02**

Female kata

	Competitors	Kata	1	2	3	4	5	6	7	TOTAL	Extra Total Rank
1	ZAPATA_MACHADO VALENTINA (COL)	052 MATSUMURA BASSAI	(7.9)	8.0	8.3	(8.5)	7.9			24.2	24.2 1
2	ARMADA ANDREA (KARATE DO)	091 SOCHIN	8.1	(7.7)	8.1	(8.4)	7.8			24.0	24.0 2

Results

1	ZAPATA MACHADO VALENTINA	COLOMBIA		COLOMBIA
2	ARMADA ANDREA	KARATE DO		VENEZUELA
3	RODRIGUEZ SASHA SERENA	VOLQUEZ		DOMINICAN REPUBLIC
3	QUIROZ CASTILLO YANETH	MEXICO		MEXICO
5	PACHON MUNOZ NATALIA SOFIA	COLOMBIA		COLOMBIA
5	SILVA YETSERI	KARATE DO		VENEZUELA
7	CRUZ ROMANO VICTORIA	MEXICO		MEXICO
7	PERALTA AQUINO PERLA GISSELL	VOLQUEZ		DOMINICAN REPUBLIC
9	MONGE VALERIA	FEDERACION COSTARRICENSE DE KARATE		COSTA RICA
9	BARRERA PAC NATHALIE GABRIELA	TEAM GUATEMALA		GUATEMALA
11	BURGOS QUELLE CLAUDIA	TEAM		CUBA
11	GALAN CRUZ HELEN GEORGINA	FSK		EL SALVADOR
13	TINOCO MUÑOZ JOYSI	FEDERACION NICARAGUENSE DE KARATE		NICARAGUA
13	SANCHEZ MARIANA	FEDERACION COSTARRICENSE DE KARATE		COSTA RICA
15	IZAGUIRRE GALDAMEZ ESTEFANY RACHEL	FSK		EL SALVADOR
15	ARGUELLO BACA STEFAPHANY FERNANDA DE LOS ANGELES	FEDERACION NICARAGUENSE DE KARATE		NICARAGUA
17	SANDOVAL COELLO GRACIA MARIA	FEDERACION DE KARATE DE HONDURAS		HONDURAS
17	ZOLOTAROVA VALENTYNA	TEAM VALY 2020		JAMAICA

**Campeonato Centroamericano y del
Caribe de Karate 2023 - 2023-03-02
FEMALE KATA TEAM**

R1 G1/2 (2) Tatami 1 10:30(2023-03-04)

Competitors	Kata	1	2	3	4	5	6	7	TOTAL	Extra Total Rank
1 COLOMBIA (BOLANOS_MARTINEZ, BOLANOS_MARTINEZ, MONTERO) (COL)	021 GOJUSHIHO SHO	7.7	(7.8)	7.5	(7.2)	7.3			22.5	22.5 1
2 FSK (GALAN_CRUZ, IZAGUIRRE_GALDAMEZ, IZAGUIRRE_GALDAMEZ) (FSK)	008 CHATANYARA KUSHANKU	(7.4)	6.8	7.2	(6.7)	7.0			21.0	21.0 2

R1 G2/2 (2) Tatami 2 10:30(2023-03-04)

Competitors	Kata	1	2	3	4	5	6	7	TOTAL	Extra Total Rank
1 DESCIDERIO (CRUZ_ROMANO, DE_LA_RUE_VILLALPANDO, QUIROZ_CASTILLO) (MEX)	068 PAPUREN	7.7	7.7	(7.6)	(7.9)	7.6			23.0	23.0 1
2 FEDERACION COSTARRICENSE DE KARATE (MONGE, MONGE, SANCHEZ) (FECOKA)	020 GOJUSHIHO DAI	7.6	7.8	7.4	(8.3)	(7.2)			22.8	22.8 2

R2 Gold Medal Match Tatami 1 10:40(2023-03-04)

Competitors	Kata	1	2	3	4	5	6	7	TOTAL	Extra Total Rank
1 COLOMBIA (BOLANOS_MARTINEZ, BOLANOS_MARTINEZ, MONTERO) (COL)	099 UNSU	7.9	(8.1)	(6.8)	7.8	7.7			23.4	23.4 1
2 DESCIDERIO (CRUZ_ROMANO, DE_LA_RUE_VILLALPANDO, QUIROZ_CASTILLO) (MEX)	001 ANAN	8.3	(8.4)	7.2	(7.0)	7.8			23.3	23.3 2

Results

1	COLOMBIA - BOLANOS_MARTINEZ ASTRID_CAROLINA - BOLANOS_MARTINEZ SANDRÁ_PATRICIA - MONTERO KIMBERLY	COLOMBIA		COLOMBIA
2	DESCIDERIO - CRUZ_ROMANO VICTORIA - DE_LA_RUE_VILLALPANDO - CINTHIA_ODETTE - QUIROZ_CASTILLO YANETH	MEXICO		MEXICO
3	FSK - GALAN_CRUZ HELEN_GEORGINA - IZAGUIRRE_GALDAMEZ - ESTEFANY_RACHEL - IZAGUIRRE_GALDAMEZ - GABRIELLA_ROSMERY	FSK		EL SALVADOR
3	FEDERACION COSTARRICENSE DE KARATE - MONGE VALERIA - MONGE YEILIN - SANCHEZ MARIANA	FEDERACION COSTARRICENSE DE KARATE		COSTA RICA

Female Kumite -50 kg

Campeonato Centroamericano y del Caribe de Karate 2023, Carretera Cocoyoc - Oaxtepec Km 2.5, Centro, 62738 Oaxtepec, MEX

2023-03-04

Tatami
1 11:00

Pool
1/1

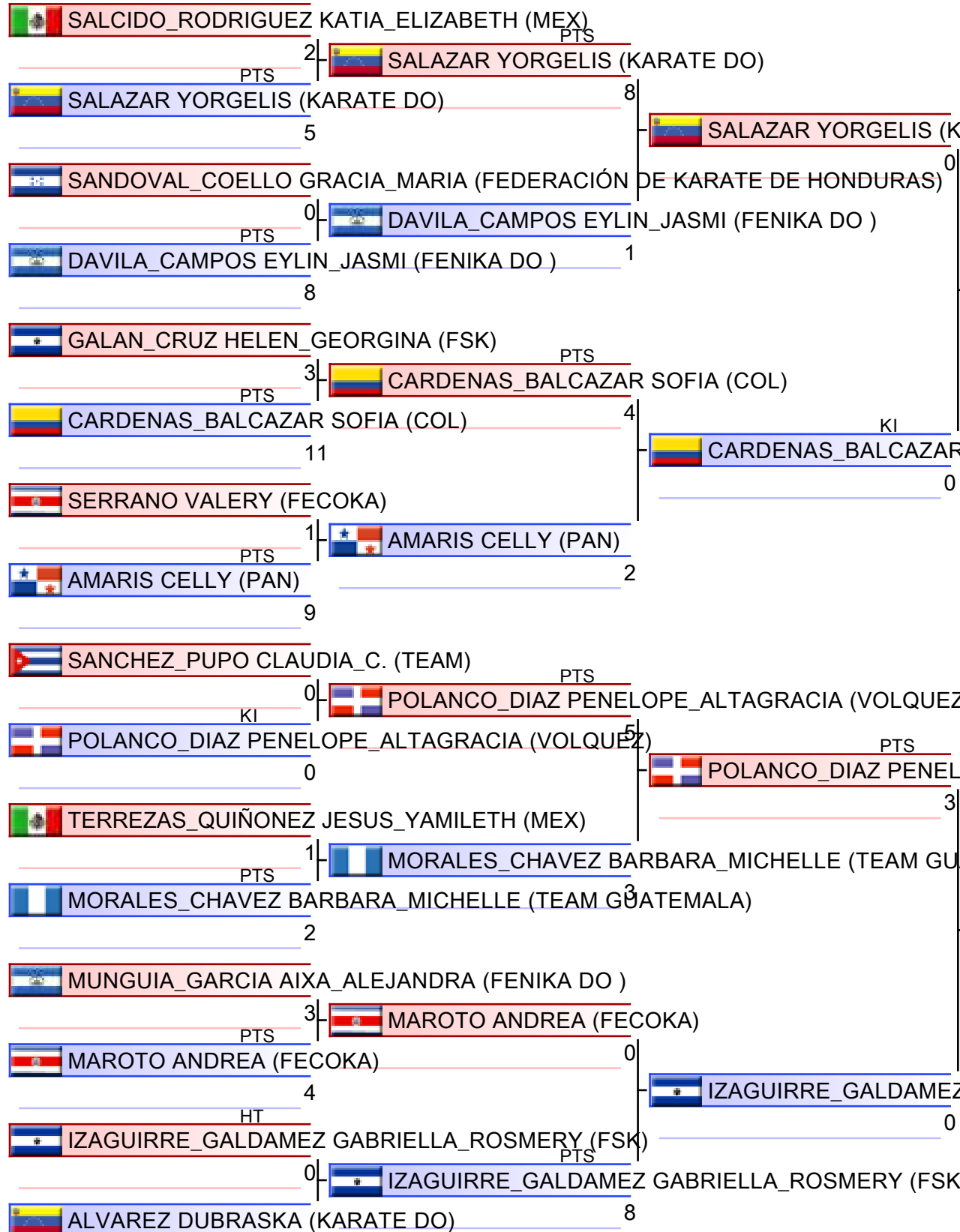

- | |
|---|
| 1. CARDENAS_BALCAZAR SOFIA (COL) |
| 2. POLANCO_DIAZ PENELOPE_ALTAGRACIA (VOLQUEZ) |
| 3. AMARIS CELLY (PAN) |
| 3. MORALES_CHAVEZ BARBARA_MICHELLE (TEAM GUATEMALA) |
| 5. SALAZAR YORGELIS (KARATE DO) |
| 5. IZAGUIRRE_GALDAMEZ GABRIELLA_ROSMERY (FSK) |
| 7. GALAN_CRUZ HELEN_GEORGINA (FSK) |
| 7. SANCHEZ_PUPO CLAUDIA_C. (TEAM) |

Referees:			

Female Kumite -50 kg

Campeonato Centroamericano y del Caribe de Karate 2023

2023-03-04

Tatami
1 12:25

Pool
1

(c)sportdata GmbH & Co KG 2000-2023 (2023-03-04 18:03) v 10.0.0 build 1 (2023-02-10) License: Online_Event_ID-6936_CampeonatoCentroamericanoydelCaribedeKarate2023 (expire 2023-03-18)

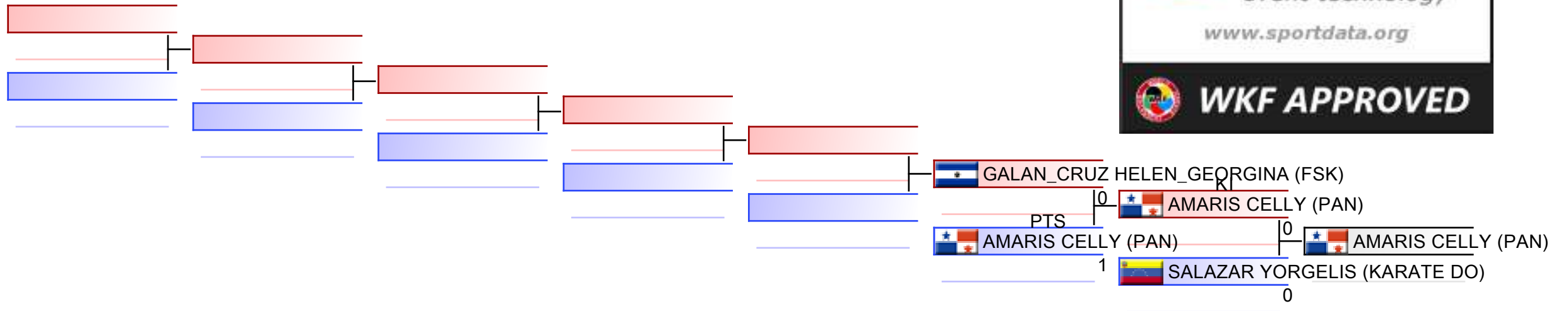

REPECHAGE: (1)

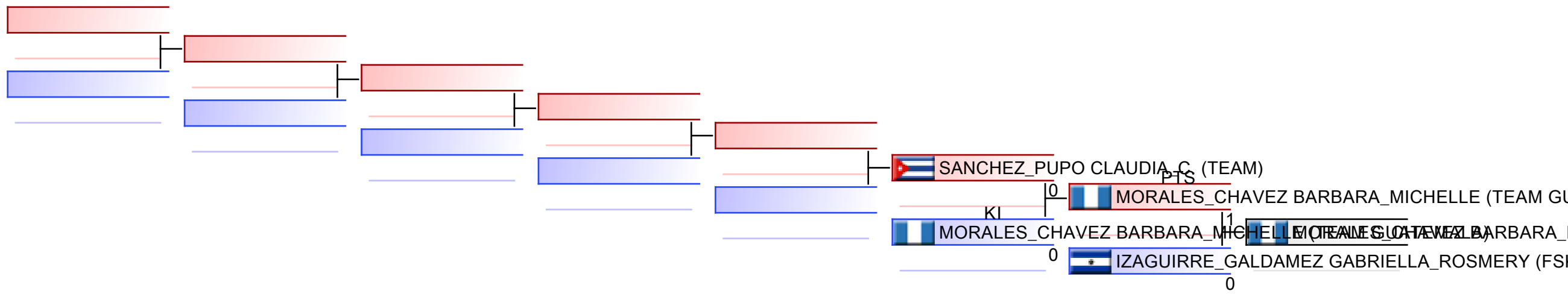

Referees:							
-----------	--	--	--	--	--	--	--

Female Kumite -55 kg

Campeonato Centroamericano y del Caribe de Karate 2023, Carretera Cocoyoc - Oaxtepec Km 2.5, Centro, 62738 Oaxtepec, MEX

2023-03-04

Tatami
2 11:00

Pool
1/1

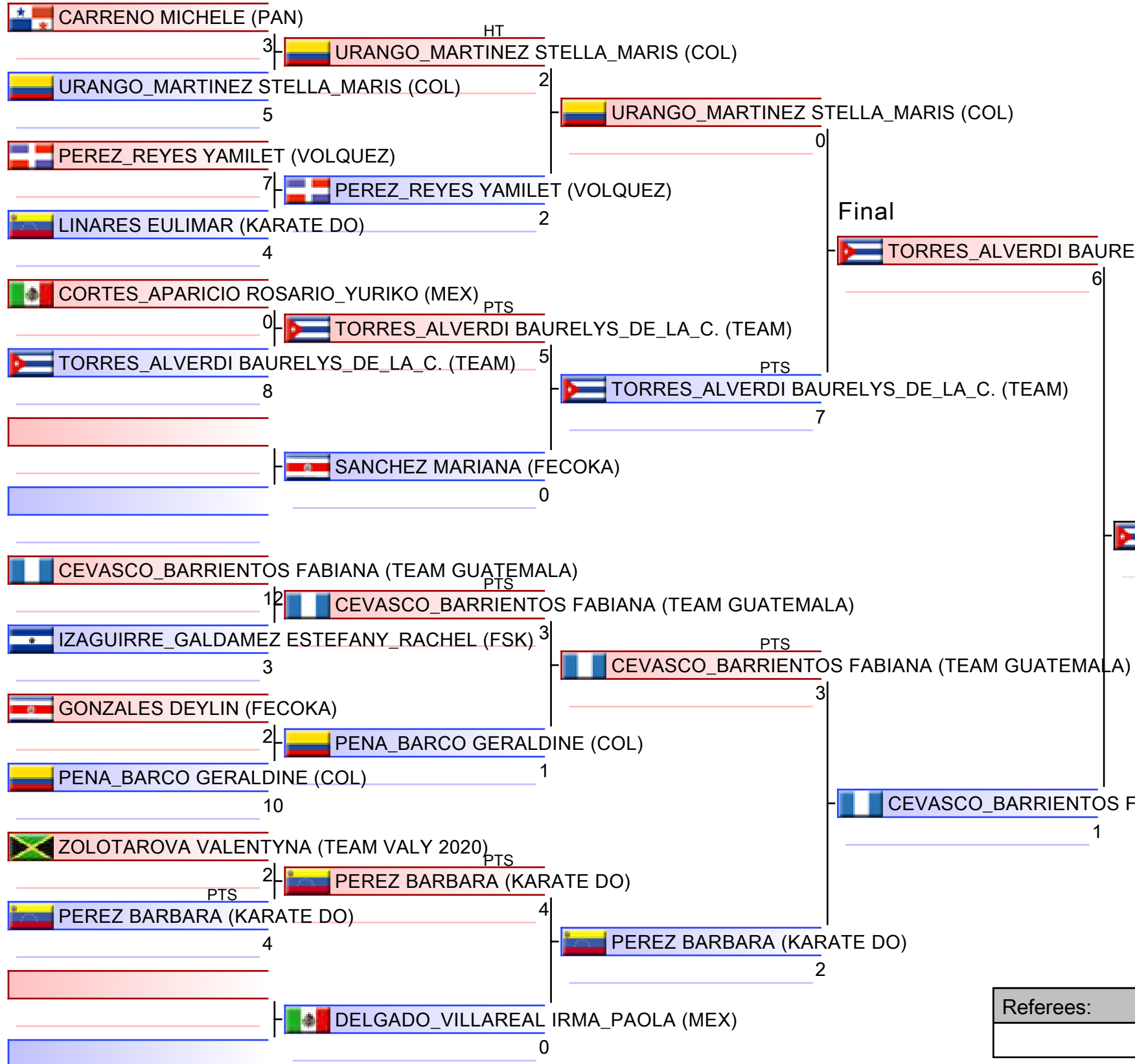

1. TORRES_ALVERDI BAURELYS_DE_LA_C. (TEAM)
2. CEVASCO_BARRIENTOS FABIANA (TEAM GUATEMALA)
3. URANGO_MARTINEZ STELLA_MARIS (COL)
3. PENA_BARCO GERALDINE (COL)
5. CORTES_APARICIO ROSARIO_YURIKO (MEX)
5. PEREZ BARBARA (KARATE DO)
7. SANCHEZ MARIANA (FECOKA)
7. IZAGUIRRE_GALDAMEZ ESTEFANY_RACHEL (FSK)

Referees:			

Female Kumite -61 kg

Campeonato Centroamericano y del Caribe de Karate 2023

2023-03-04

Tatami
1 13:55

Pool
1

(c)sportdata GmbH & Co KG 2000-2023 (2023-03-04 18:03) v 10.0.0 build 1 (2023-02-10) License: Online_Event_ID-6936_CampeonatoCentroamericanoydelCaribedeKarate2023 (expire 2023-03-18)

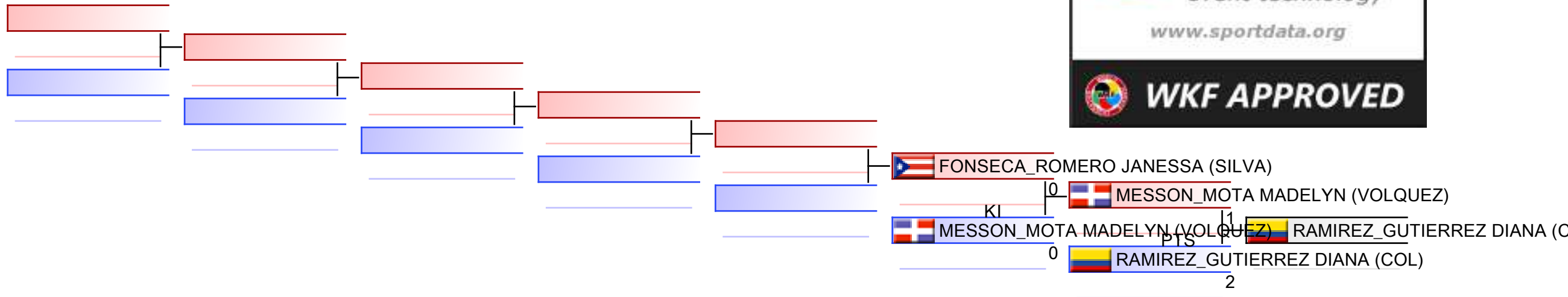

REPECHAGE: (1)

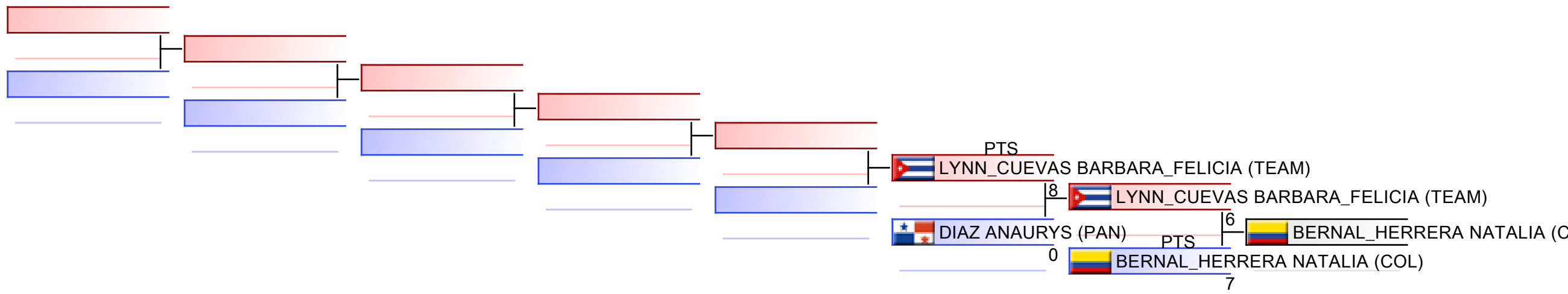

Referees:							
-----------	--	--	--	--	--	--	--

Female Kumite -68 kg

Campeonato Centroamericano y del Caribe de Karate 2023, Carretera Cocoyoc - Oaxtepec Km 2.5, Centro, 62738 Oaxtepec, MEX

2023-03-04

Tatami
3 11:00

Pool
1/1

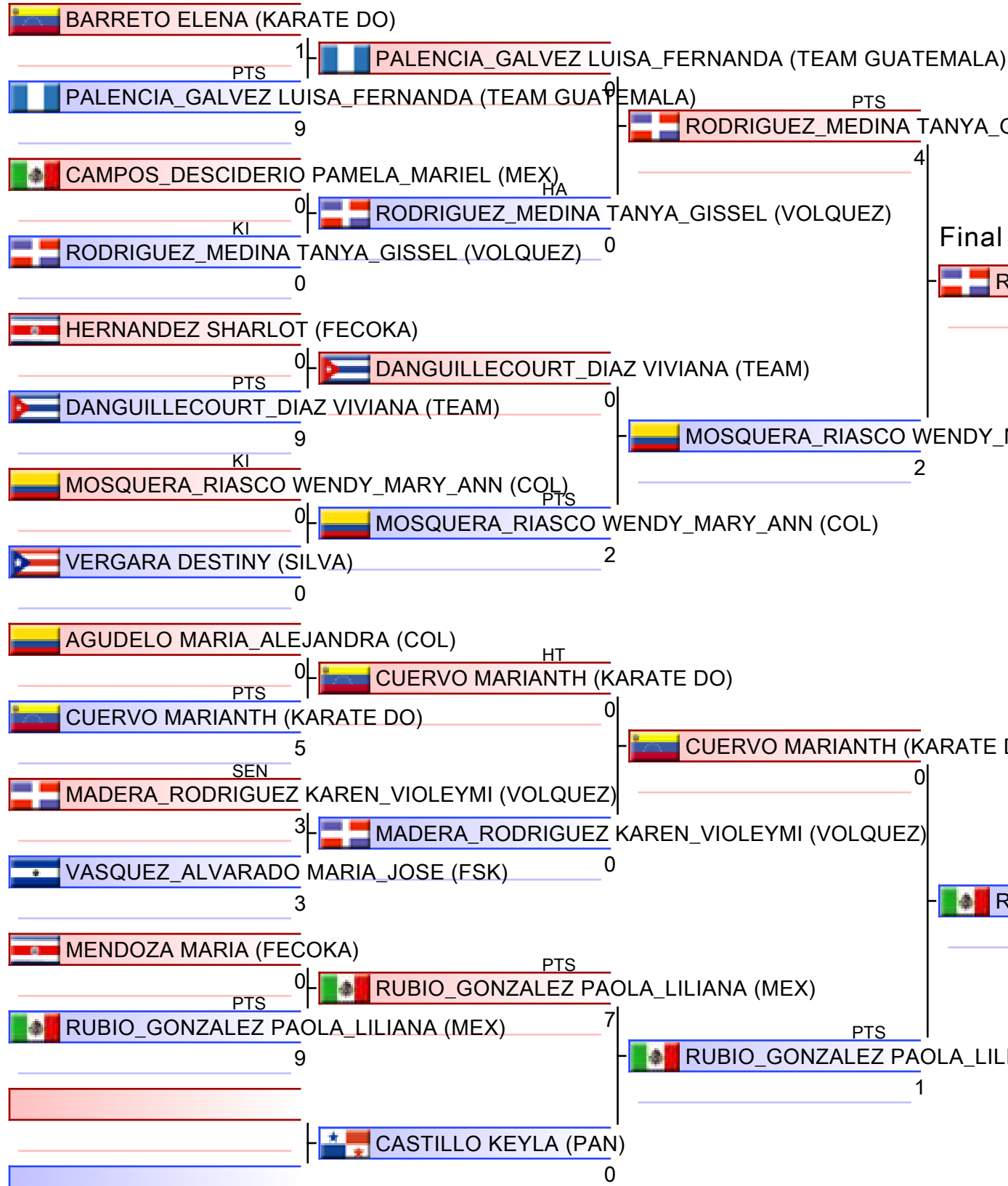

- | |
|--|
| 1. RUBIO_GONZALEZ PAOLA_LILIANA (MEX) |
| 2. RODRIGUEZ_MEDINA TANYA_GISSEL (VOLQUEZ) |
| 3. PALENCIA_GALVEZ LUISA_FERNANDA (TEAM GUATEMALA) |
| 3. CUERVO MARIANTH (KARATE DO) |
| 5. MOSQUERA_RIASCO WENDY_MARY_ANN (COL) |
| 5. CASTILLO KEYLA (PAN) |
| 7. CAMPOS_DESCIDERIO PAMELA_MARIEL (MEX) |
| 7. MENDOZA MARIA (FECOKA) |

Referees:			

Female Kumite -68 kg

Campeonato Centroamericano y del Caribe de Karate 2023

2023-03-04

Tatami
3 12:20

Pool
1

(c)sportdata GmbH & Co KG 2000-2023 (2023-03-04 18:03) v 10.0.0 build 1 (2023-02-10) License: Online_Event_ID-6936_CampeonatoCentroamericanoydelCaribedeKarate2023 (expire 2023-03-18)

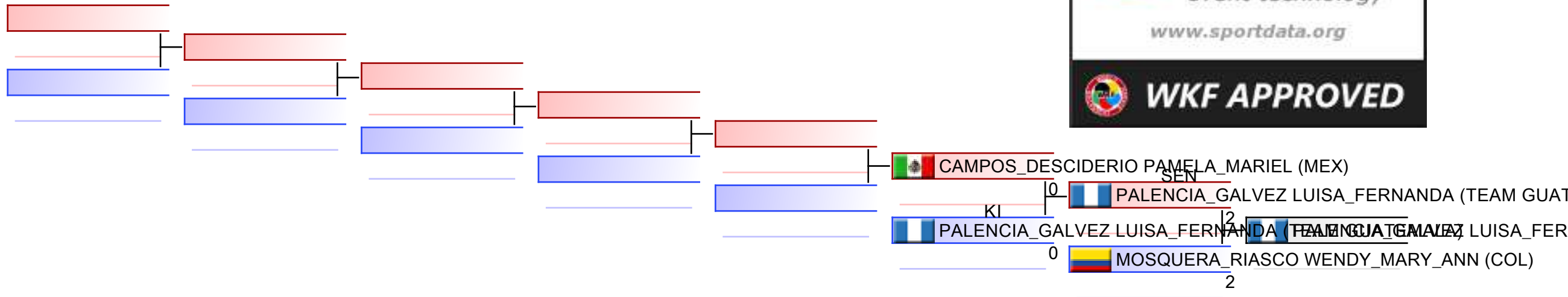

REPECHAGE: (1)

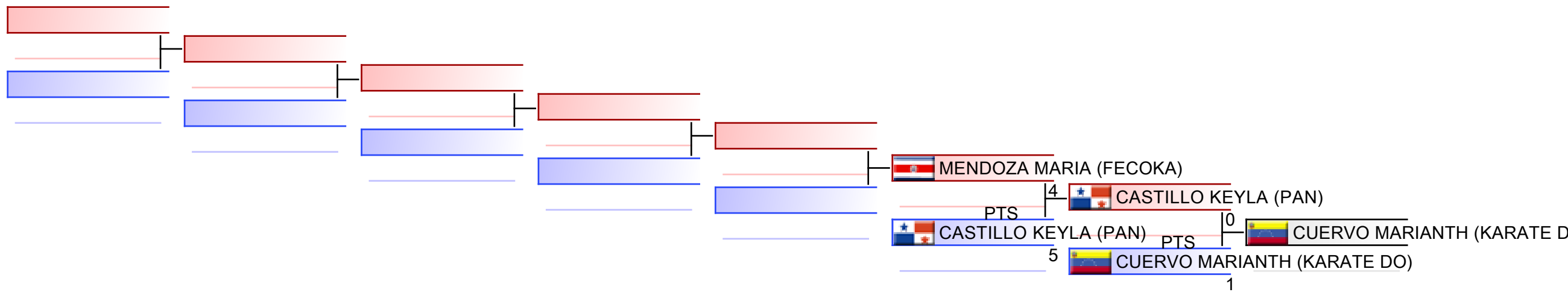

Referees:							
-----------	--	--	--	--	--	--	--

FEMALE KUMITE 68+ KG

Campeonato Centroamericano y del Caribe de Karate 2023, Carretera Cocoyoc - Oaxtepec Km 2.5, Centro, 62738 Oaxtepec, MEX

2023-03-04

Tatami
2 12:50

Pool
1/1

CASTRO KEYLISS (FECOKA)

PTS | HENRY HELENA (PAN) | 0

HENRY HELENA (PAN) | 5

PTS | RODRIGUEZ ORIANA (KARATE DO) | 0

RODRIGUEZ ORIANA (KARATE DO) | 5

KI | HERNANDEZ_SANCHEZ MEZTLI_SARAH (MEX) | 0

HERNANDEZ_SANCHEZ MEZTLI_SARAH (MEX) | 0

PTS | TORRES_DONCEL SHANEE (COL) | 0

TORRES_DONCEL SHANEE (COL) | 0

PTS | RUIZ_MENDEZ ANDREA_DE_LOS_ANGELES (FSK) | 0

RUIZ_MENDEZ ANDREA_DE_LOS_ANGELES (FSK) | 9

KI | SOLIS KYLIE (FECOKA) | 0

SOLIS KYLIE (FECOKA) | 0

PTS | RODRIGUEZ PAMELA (VOLQUEZ) | 2

RODRIGUEZ PAMELA (VOLQUEZ) | 0

PTS | OSORIO_UPEGUI SAYAKA_YURANI (COL) | 0

OSORIO_UPEGUI SAYAKA_YURANI (COL) | 3

PTS | QUINTAL_CATZIN GUADALUPE_CONCEPCION (MEX) | 1

QUINTAL_CATZIN GUADALUPE_CONCEPCION (MEX) | 0

KI | BRICEÑO ARIAMNA (KARATE DO) | 0

BRICEÑO ARIAMNA (KARATE DO) | 0

PTS | HENRY HELENA (PAN) | 0

HENRY HELENA (PAN) | 5

PTS | RODRIGUEZ ORIANA (KARATE DO) | 12

RODRIGUEZ ORIANA (KARATE DO) | 5

KI | HERNANDEZ_SANCHEZ MEZTLI_SARAH (MEX) | 0

HERNANDEZ_SANCHEZ MEZTLI_SARAH (MEX) | 0

PTS | RUIZ_MENDEZ ANDREA_DE_LOS_ANGELES (FSK) | 0

RUIZ_MENDEZ ANDREA_DE_LOS_ANGELES (FSK) | 4

PTS | RUIZ_MENDEZ ANDREA_DE_LOS_ANGELES (FSK) | 9

KI | SOLIS KYLIE (FECOKA) | 0

SOLIS KYLIE (FECOKA) | 2

PTS | OSORIO_UPEGUI SAYAKA_YURANI (COL) | 1

OSORIO_UPEGUI SAYAKA_YURANI (COL) | 3

PTS | QUINTAL_CATZIN GUADALUPE_CONCEPCION (MEX) | 1

QUINTAL_CATZIN GUADALUPE_CONCEPCION (MEX) | 0

PTS | QUINTAL_CATZIN GUADALUPE_CONCEPCION (MEX) | 3

KI | HERNANDEZ_POLLEDO ONELIS (TEAM) | 0

HERNANDEZ_POLLEDO ONELIS (TEAM) | 0

PTS | RODRIGUEZ ORIANA (KARATE DO) | 12

RODRIGUEZ ORIANA (KARATE DO) | 5

Final PTS | RODRIGUEZ ORIANA (KARATE DO) | 5

RUIZ_MENDEZ ANDREA_DE_LOS_ANGELES (FSK) | 4

RUIZ_MENDEZ ANDREA_DE_LOS_ANGELES (FSK) | 9

OSORIO_UPEGUI SAYAKA_YURANI (COL) | 1

QUINTAL_CATZIN GUADALUPE_CONCEPCION (MEX) | 3

QUINTAL_CATZIN GUADALUPE_CONCEPCION (MEX) | 3

QUINTAL_CATZIN GUADALUPE_CONCEPCION (MEX) | 3

QUINTAL_CATZIN GUADALUPE_CONCEPCION (MEX) | 3

QUINTAL_CATZIN GUADALUPE_CONCEPCION (MEX) | 3

QUINTAL_CATZIN GUADALUPE_CONCEPCION (MEX) | 3

QUINTAL_CATZIN GUADALUPE_CONCEPCION (MEX) | 3

QUINTAL_CATZIN GUADALUPE_CONCEPCION (MEX) | 3

QUINTAL_CATZIN GUADALUPE_CONCEPCION (MEX) | 3



- | |
|--|
| 1. RODRIGUEZ ORIANA (KARATE DO) |
| 2. QUINTAL_CATZIN GUADALUPE_CONCEPCION (MEX) |
| 3. HENRY HELENA (PAN) |
| 3. OSORIO_UPEGUI SAYAKA_YURANI (COL) |
| 5. RUIZ_MENDEZ ANDREA_DE_LOS_ANGELES (FSK) |
| 5. BRICEÑO ARIAMNA (KARATE DO) |
| 7. HERNANDEZ_POLLEDO ONELIS (TEAM) |

Referees:			

FEMALE KUMITE 68+ KG

Campeonato Centroamericano y del Caribe de Karate 2023

2023-03-04

Tatami
2 13:50

Pool
1

(c)sportdata GmbH & Co KG 2000-2023 (2023-03-04 18:03) v 10.0.0 build 1 (2023-02-10) License: Online_Event_ID-6936_CampeonatoCentroamericanoydelCaribedeKarate2023 (expire 2023-03-18)

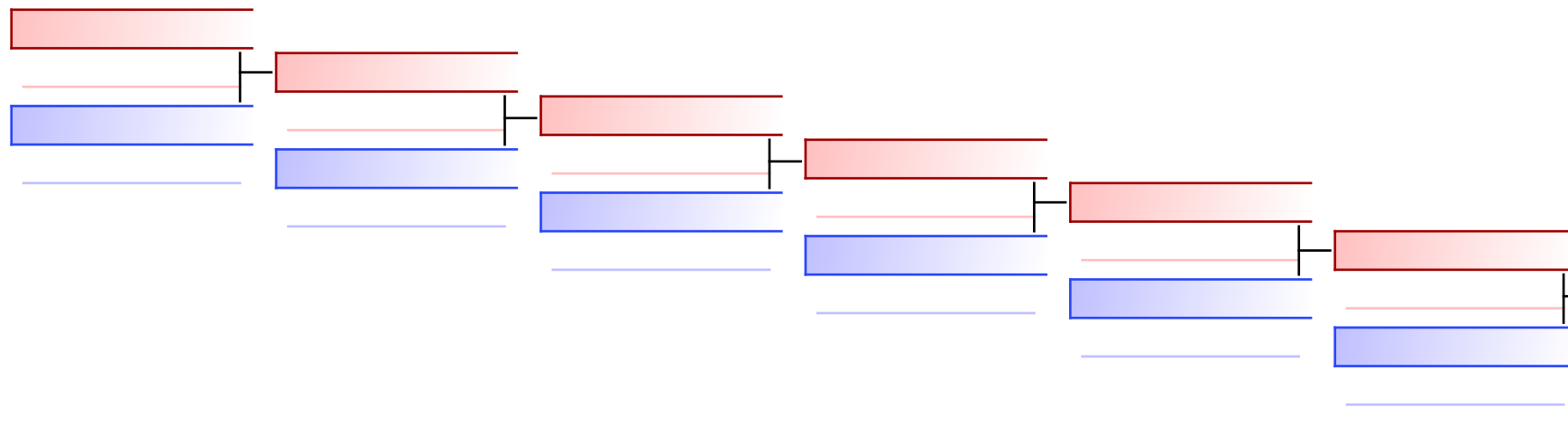

PTS
 HENRY HELENA (PAN) | 2
 RUIZ_MENDEZ ANDREA_DE_LOS_ANGELES (FSK) | 1

REPECHAGE: (1)

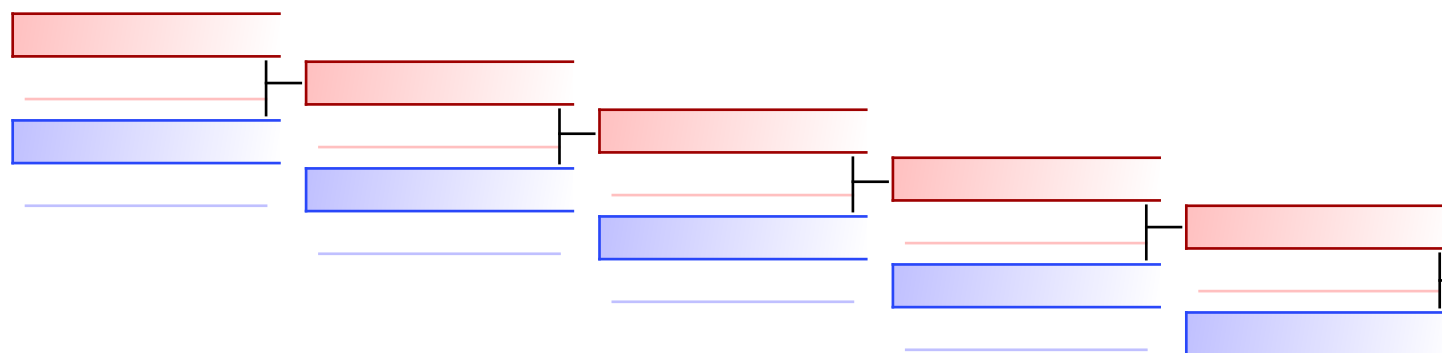

KI
 BRICEÑO ARIAMNA (KARATE DO) | 0
 HERNANDEZ_POLLEDO ONELIS (TEAM) | 1
 OSORIO_UEGUI SAYAKA_YURANI (COL) | 4

Referees:							
-----------	--	--	--	--	--	--	--

Female Kumite Team

Campeonato Centroamericano y del Caribe de Karate 2023, Carretera Cocoyoc - Oaxtepec Km 2.5, Centro, 62738 Oaxtepec, MEX

2023-03-04

Tatami
2 17:00

Pool
1/1

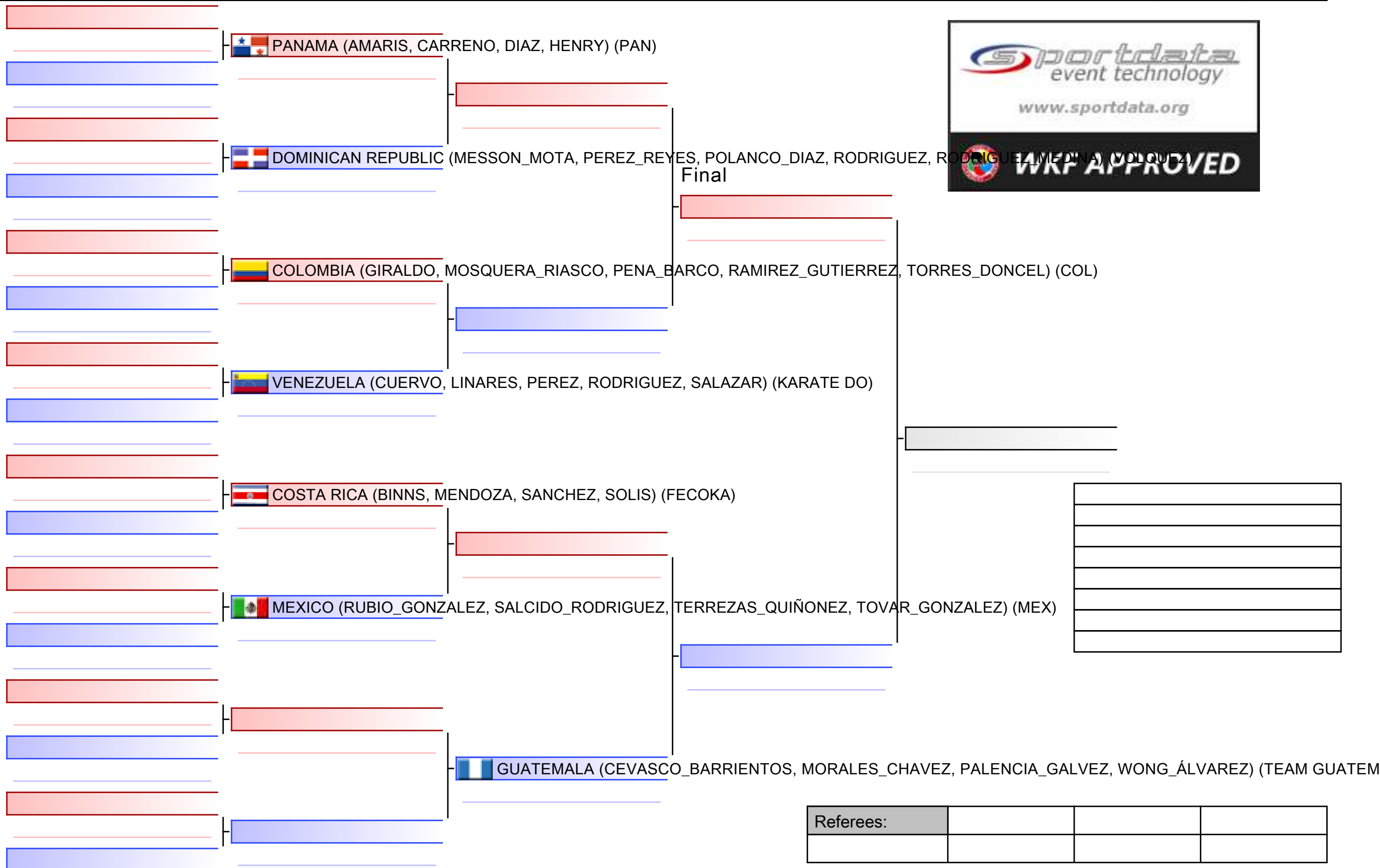

Referees:			

**Campeonato Centroamericano y del
Caribe de Karate 2023 - 2023-03-02
Junior Kata Female**

R1 G1/2 (6) Tatami 2 09:00(2023-03-03)

Competitors	Kata	1	2	3	4	5	6	7	TOTAL	Extra Total Rank
1 PERALTA_AQUINO PERLA_GISSELL (VOLQUEZ)	068 PAPUREN	(8.0)	7.5	7.5	7.7	(7.3)			22.7	1
2 OCANA LAYLA (SILVA)	068 PAPUREN	(7.8)	7.4	(7.3)	7.3	7.5			22.2	3
3 DIAZ MIRELYS (KARATE DO)	092 SUPARINPEI	(7.9)	7.5	(7.4)	7.5	7.4			22.4	2
4 DE_LA_O_GARCIA XIMENA (MEX)	001 ANAN	7.4	(7.3)	7.3	(7.6)	7.4			22.1	4
5 SIBAJA MARIEDITH (FECOKA)	021 GOJUSHIHO SHO	(7.5)	7.2	7.2	(7.1)	7.1			21.5	6
6 TINOCO_MUÑOZ JOYSI (FENIKA DO)	068 PAPUREN	7.3	7.4	(7.1)	(7.6)	7.2			21.9	5

R1 G2/2 (5) Tatami 2 09:25(2023-03-03)

Competitors	Kata	1	2	3	4	5	6	7	TOTAL	Extra Total Rank
1 CALVO ARIELA (FECOKA)	021 GOJUSHIHO SHO	7.0	(7.1)	(6.8)	7.1	7.0			21.1	4
2 MARTINEZ_ZAPATA ANA_YURIDIA (MEX)	065 OYADOMARI NO PASSAI	(7.5)	7.5	7.5	7.4	(7.2)			22.4	1
3 CAMPOS_GUZMAN DORIAN (SILVA)	068 PAPUREN	7.4	(7.3)	7.4	(7.6)	7.3			22.1	2
4 WINTER CHELSEA (TKA)										
5 ARGUELLO_BACA STEFAPHANY_FERNANDA_DE_LOS_ANGELES (FENIKA DO)	002 ANAN DAI	7.2	7.4	(7.5)	7.3	(7.1)			21.9	3

R2-G1 Tatami 2 09:50(2023-03-03)

Competitors	Kata	1	2	3	4	5	6	7	TOTAL	Extra Total Rank
1 DE_LA_O_GARCIA XIMENA (MEX)	002 ANAN DAI	(7.6)	7.6	(7.4)	7.5	7.4			22.5	3
2 PERALTA_AQUINO PERLA_GISSELL (VOLQUEZ)	065 OYADOMARI NO PASSAI	7.7	(7.8)	7.6	7.6	(7.3)			22.9	1
3 OCANA LAYLA (SILVA)	097 TOMARI BASSAI	(7.4)	7.4	7.5	(7.6)	7.5			22.4	4
4 DIAZ MIRELYS (KARATE DO)	002 ANAN DAI	7.6	(7.7)	7.7	7.5	(7.3)			22.8	2

R2-G2 Tatami 2 10:05(2023-03-03)

Competitors	Kata	1	2	3	4	5	6	7	TOTAL	Extra Total Rank
1 MARTINEZ_ZAPATA ANA_YURIDIA (MEX)	068 PAPUREN	(7.6)	7.6	7.4	7.5	(7.3)			22.5	1
2 CAMPOS_GUZMAN DORIAN (SILVA)	008 CHATANYARA KUSHANKU	7.3	(7.4)	(7.1)	7.4	7.4			22.1	3
3 CALVO ARIELA (FECOKA)	015 GANKAKU	(7.0)	7.3	7.2	(7.5)	7.2			21.7	4
4 ARGUELLO_BACA STEFAPHANY_FERNANDA_DE_LOS_ANGELES (FENIKA DO)	008 CHATANYARA KUSHANKU	(7.4)	7.4	7.4	7.3	(7.2)			22.1	2

R3 Bronze Medal Match 1 Tatami 2 10:25(2023-03-03)

Competitors	Kata	1	2	3	4	5	6	7	TOTAL	Extra Total Rank
1 DIAZ MIRELYS (KARATE DO)	068 PAPUREN	(7.7)	7.6	7.6	7.6	(7.4)			22.8	1
2 CAMPOS_GUZMAN DORIAN (SILVA)	002 ANAN DAI	(7.4)	7.4	7.4	7.4	(7.3)			22.2	2







R3 Bronze Medal Match 2 Tatami 2 10:35(2023-03-03)

Competitors	Kata	1	2	3	4	5	6	7	TOTAL	Extra Total Rank
1 DE_LA_O_GARCIA XIMENA (MEX)	008 CHATANYARA KUSHANKU	(7.3)	7.4	(7.8)	7.5	7.8			22.7	1
2 ARGUELLO_BACA STEFAPHANY_FERNANDA_DE_LOS_ANGELES (FENIKA DO)	068 PAPUREN									



R3 Gold Medal Match Tatami 2 10:45(2023-03-03)

Competitors	Kata	1	2	3	4	5	6	7	TOTAL	Extra Total Rank
1 PERALTA_AQUINO PERLA_GISSELL (VOLQUEZ)	008 CHATANYARA KUSHANKU	(7.4)	7.4	(7.6)	7.6	7.5			22.5	2
2 MARTINEZ_ZAPATA ANA_YURIDIA (MEX)	009 CHIBANA NO KUSHANKU	(7.9)	(7.6)	7.7	7.8	7.7			23.2	1

Results

1	MARTINEZ ZAPATA ANA YURIDIA	MEXICO		MEXICO
2	PERALTA AQUINO PERLA GISSELL	VOLQUEZ		DOMINICAN REPUBLIC
3	DIAZ MIRELYS	KARATE DO		VENEZUELA
3	DE LA O GARCIA XIMENA	MEXICO		MEXICO
5	CAMPOS GUZMAN DORIAN	SILVA		PUERTO RICO
7	OCANA LAYLA	SILVA		PUERTO RICO

**Campeonato Centroamericano y del
Caribe de Karate 2023 - 2023-03-02**
Junior Kata Female

7	CALVO ARIELA	FEDERACION COSTARRICENSE DE KARATE		COSTA RICA
9	TINOCO MUNOZ JOYSI	FEDERACION NICARAGUENSE DE KARATE		NICARAGUA
11	SIBAJA MARIEDITH	FEDERACION COSTARRICENSE DE KARATE		COSTA RICA

**Campeonato Centroamericano y del
Caribe de Karate 2023 - 2023-03-02
Junior Kata Male**

R1 G1/2 (5) Tatami 1 09:00(2023-03-03)

Competitors	Kata	1	2	3	4	5	6	7	TOTAL	Extra Total Rank
1 LOPEZ GABRIEL_ALEJANDRO (COL)	092 SUPARINPEI	7.7	7.3	(8.0)	(7.2)	7.7			22.7	22.7 2
2 DELGADO_POSADAS BRYAN MAURICIO (FSK)	008 CHATANYARA KUSHANKU	(7.3)	7.1	7.1	7.1	(7.0)			21.3	21.3 5
3 LEON JUAN JOSE (FECOKA)	021 GOJUSHIHO SHO	(6.9)	(7.5)	7.2	7.0	7.5			21.7	21.7 4
4 MACIAS CASTELLANOS JUANN PABLO (MEX)	002 ANAN DAI	(7.0)	7.7	7.2	7.2	(8.0)			22.1	22.1 3
5 VILLALTA LUIS (KARATE DO)	021 GOJUSHIHO SHO	(8.1)	7.9	8.1	(7.2)	7.6			23.6	23.6 1

R1 G2/2 (4) Tatami 1 09:20(2023-03-03)

Competitors	Kata	1	2	3	4	5	6	7	TOTAL	Extra Total Rank
1 PACAS_RYLATT EMMANUEL DAVID (FSK)	008 CHATANYARA KUSHANKU	(6.9)	6.9	(7.3)	6.9	6.9			20.7	20.7 2
2 MENESES NELSON (KARATE DO)	099 UNSU	6.8	(6.7)	(7.5)	7.0	6.9			20.7	20.7 3
3 ESCOBAR LEONARDO (FECOKA)	099 UNSU	(6.6)	6.6	(7.1)	6.6	6.7			19.9	19.9 4
4 SALDANA_MARKUS EMILIO (MEX)	002 ANAN DAI	(8.1)	(7.2)	7.6	7.5	7.3			22.4	22.4 1

R2 Bronze Medal Match 1 Tatami 1 09:40(2023-03-03)

Competitors	Kata	1	2	3	4	5	6	7	TOTAL	Extra Total Rank
1 LOPEZ GABRIEL_ALEJANDRO (COL)	041 KANKU SHO	(8.0)	7.3	7.6	7.5	(7.2)			22.4	22.4 2
2 MENESES NELSON (KARATE DO)	092 SUPARINPEI	(8.5)	8.1	8.0	7.8	(7.6)			23.9	23.9 1









R2 Bronze Medal Match 2 Tatami 1 09:50(2023-03-03)

Competitors	Kata	1	2	3	4	5	6	7	TOTAL	Extra Total Rank
1 MACIAS CASTELLANOS JUANN PABLO (MEX)	064 OHAN DAI	(8.0)	7.4	7.7	(7.3)	7.5			22.6	22.6 1
2 PACAS_RYLATT EMMANUEL DAVID (FSK)	068 PAPUREN	7.4	(7.8)	(7.0)	7.6	7.2			22.2	22.2 2

R2 Gold Medal Match Tatami 1 10:00(2023-03-03)

Competitors	Kata	1	2	3	4	5	6	7	TOTAL	Extra Total Rank
1 VILLALTA LUIS (KARATE DO)	078 SANSAN	(8.2)	7.9	8.1	(7.5)	7.6			23.6	23.6 1
2 SALDANA_MARKUS EMILIO (MEX)	064 OHAN DAI	8.0	(7.6)	(8.5)	7.8	7.7			23.5	23.5 2

Results

1	VILLALTA LUIS	KARATE DO		VENEZUELA
2	SALDANA MARKUS EMILIO	MEXICO		MEXICO
3	MENESES NELSON	KARATE DO		VENEZUELA
3	MACIAS CASTELLANOS JUANN PABLO	MEXICO		MEXICO
5	LOPEZ GABRIEL_ALEJANDRO	COLOMBIA		COLOMBIA
5	PACAS_RYLATT EMMANUEL DAVID	FSK		EL SALVADOR
7	LEON JUAN JOSE	FEDERACION COSTARRICENSE DE KARATE		COSTA RICA
7	ESCOBAR LEONARDO	FEDERACION COSTARRICENSE DE KARATE		COSTA RICA
9	DELGADO POSADAS BRYAN MAURICIO	FSK		EL SALVADOR

JUNIOR KUMITE FEMALE -48 KG

Campeonato Centroamericano y del Caribe de Karate 2023, Carretera Cocoyoc - Oaxtepec Km 2.5, Centro, 62738 Oaxtepec, MEX

2023-03-03

Tatami
1 11:15

Pool
1/1

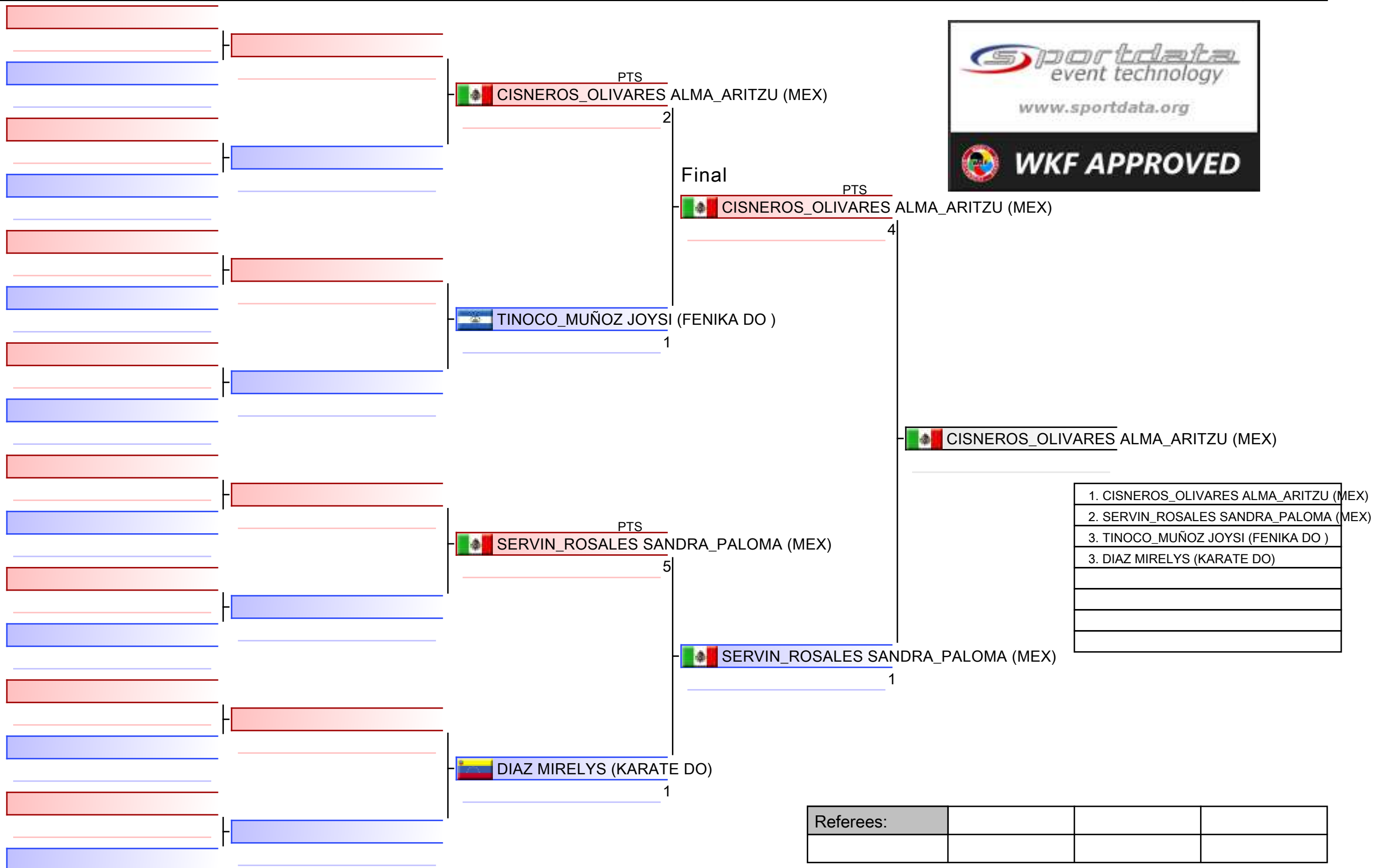

1. CISNEROS_OLIVARES ALMA_ARITZU (MEX)
2. SERVIN_ROSALES SANDRA_PALOMA (MEX)
3. TINOCO_MUÑOZ JOYSI (FENIKA DO)
3. DIAZ MIRELYS (KARATE DO)

Referees:			

JUNIOR KUMITE FEMALE -48 KG

Campeonato Centroamericano y del Caribe de Karate 2023

Tatami

Pool
1

(c)sportdata GmbH & Co KG 2000-2023 (2023-03-04 17:55) v 10.0.0 build 1 (2023-02-10) License: Online_Event_ID-6936_CampeonatoCentroamericanoydelCaribedeKarate2023 (expire 2023-03-18)

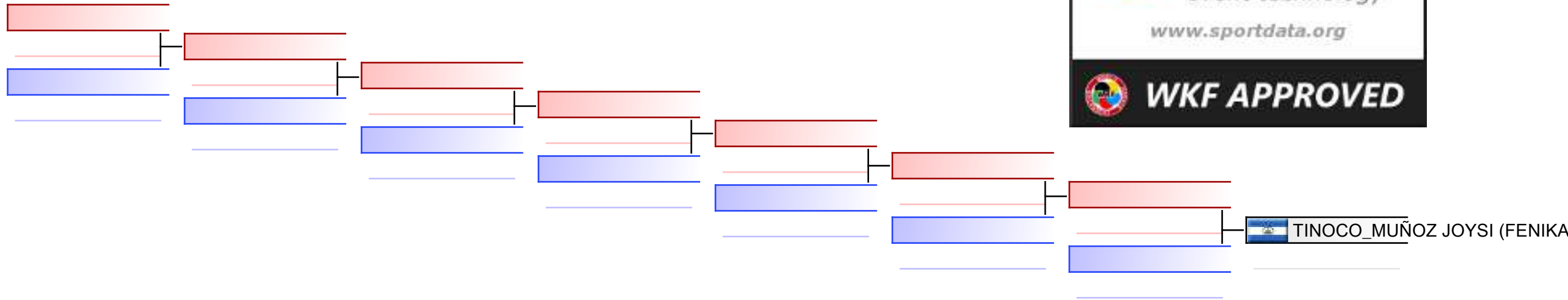

REPECHAGE: (1)

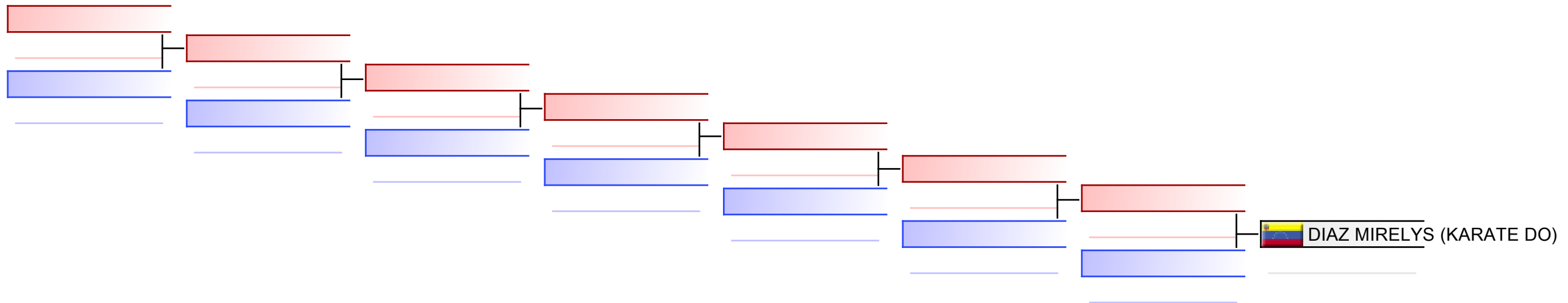

Referees:							
-----------	--	--	--	--	--	--	--

JUNIOR KUMITE FEMALE -53 KG

Campeonato Centroamericano y del Caribe de Karate 2023, Carretera Cocoyoc - Oaxtepec Km 2.5, Centro, 62738 Oaxtepec, MEX

2023-03-03

Tatami
2 11:15

Pool
1/1

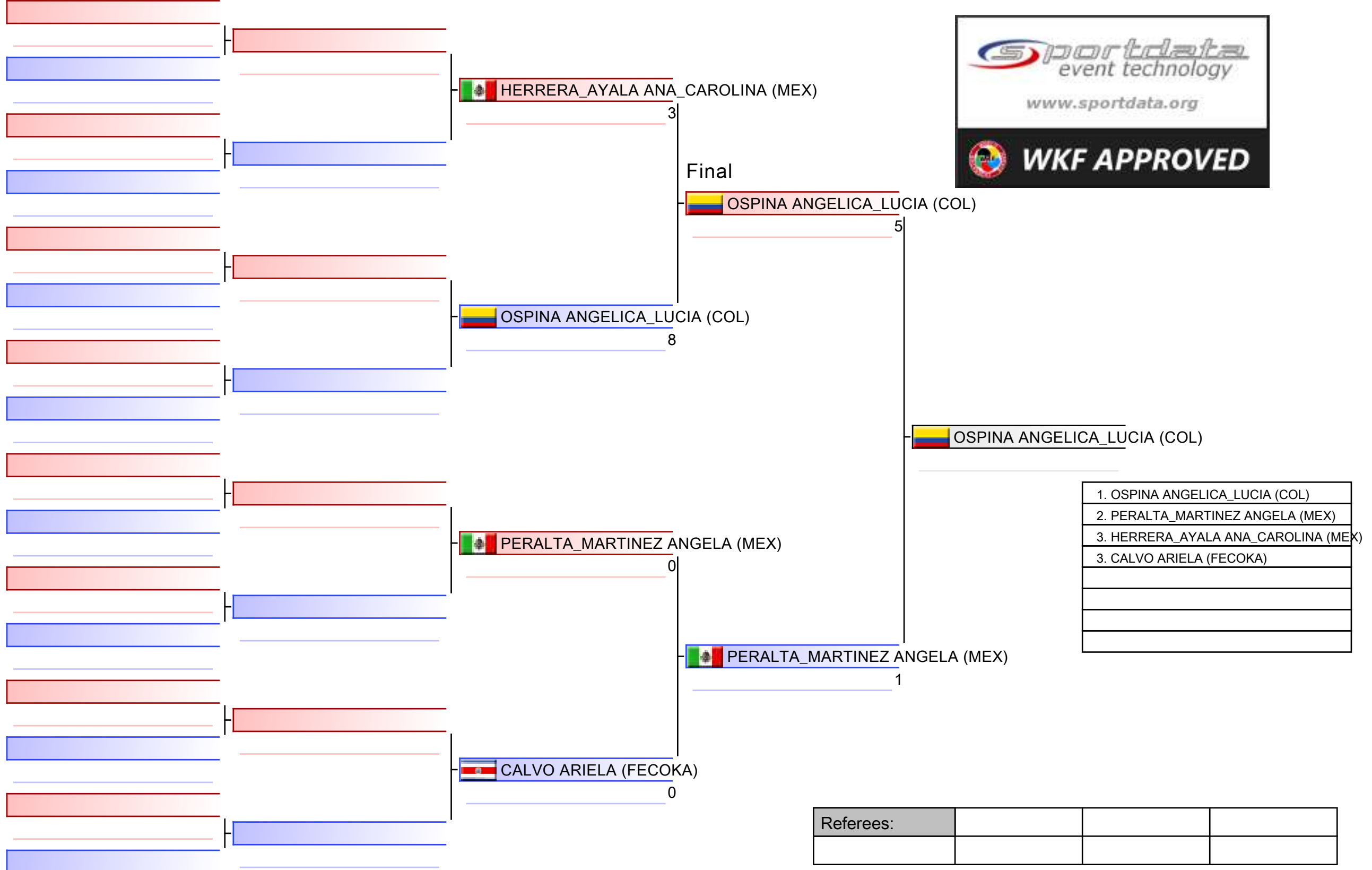

JUNIOR KUMITE FEMALE -53 KG

Campeonato Centroamericano y del Caribe de Karate 2023

Tatami

Pool
1

(c)sportdata GmbH & Co KG 2000-2023 (2023-03-04 17:55) v 10.0.0 build 1 (2023-02-10) License: Online_Event_ID-6936_CampeonatoCentroamericanoydelCaribedeKarate2023 (expire 2023-03-18)

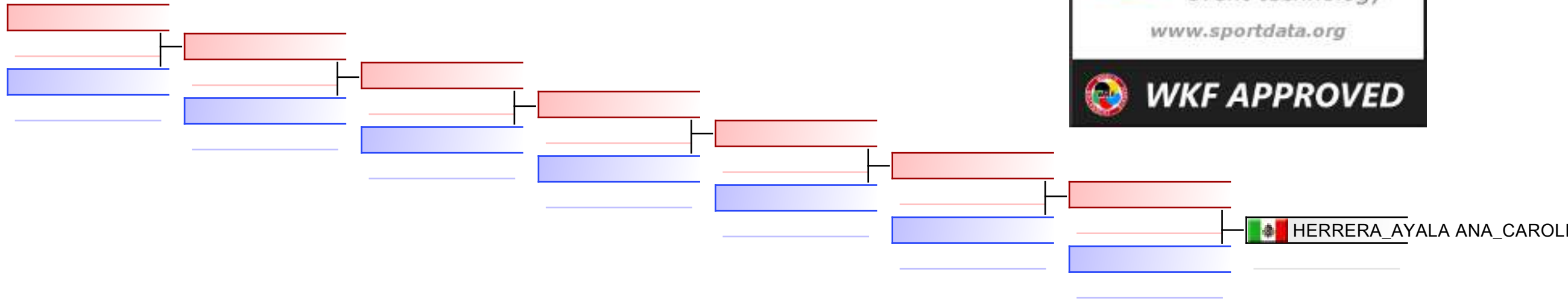

REPECHAGE: (1)

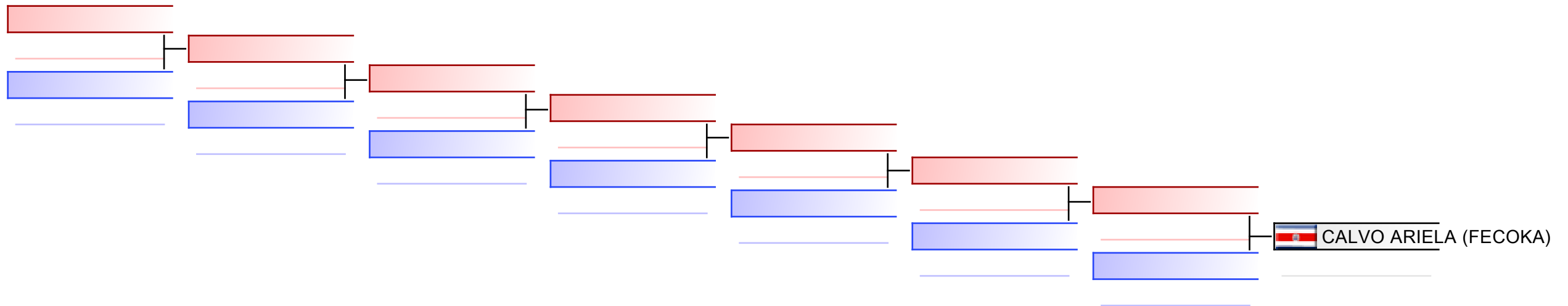

Referees:							
-----------	--	--	--	--	--	--	--

JUNIOR KUMITE FEMALE -59 KG

Campeonato Centroamericano y del Caribe de Karate 2023, Carretera Cocoyoc - Oaxtepec Km 2.5, Centro, 62738 Oaxtepec, MEX

2023-03-03

Tatami
1 11:40

Pool
1/1

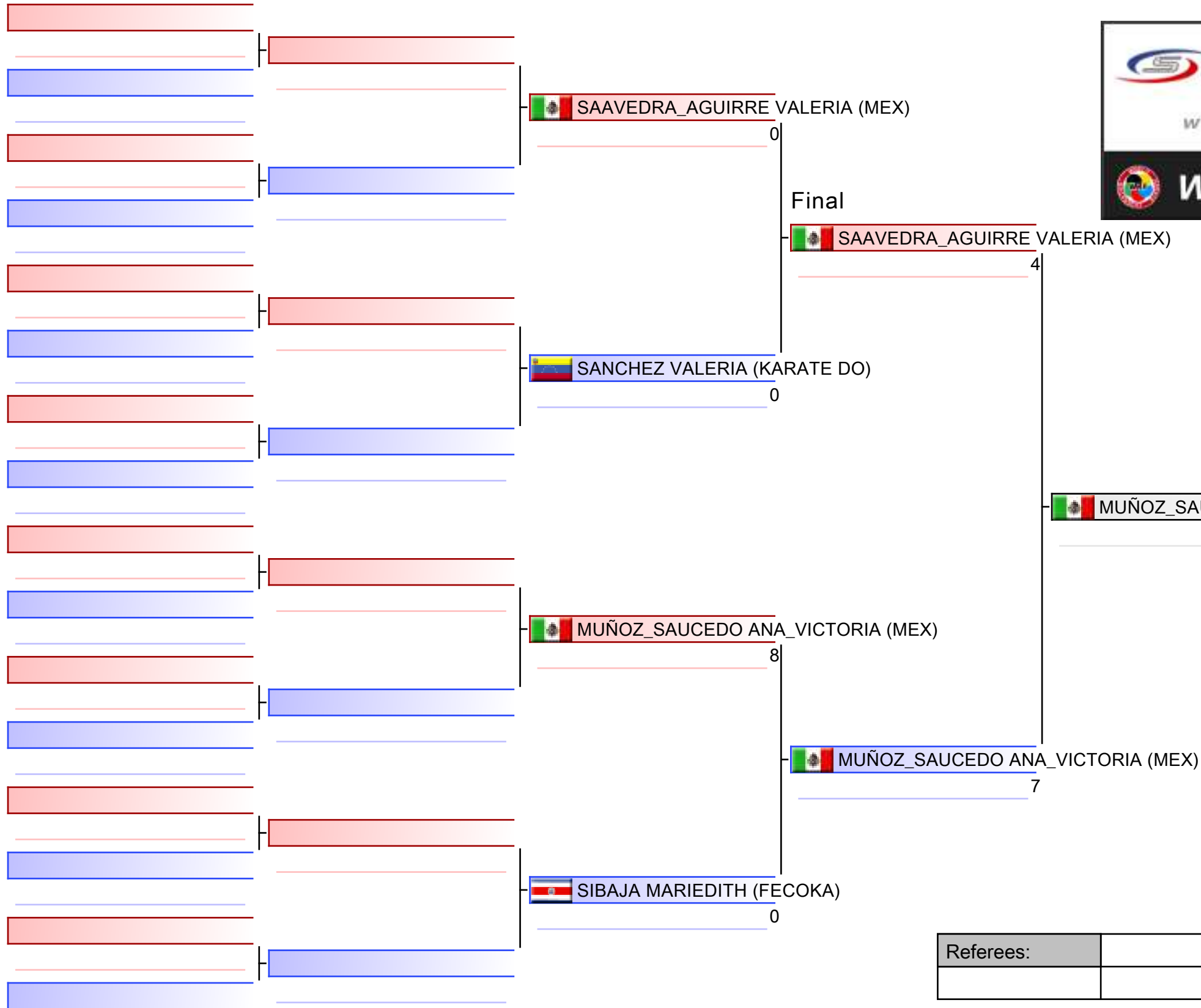

- | |
|-------------------------------------|
| 1. MUÑOZ_SAUCEDO ANA_VICTORIA (MEX) |
| 2. SAAVEDRA_AGUIRRE VALERIA (MEX) |
| 3. SANCHEZ VALERIA (KARATE DO) |
| 3. SIBAJA MARIEDITH (FECOKA) |
| |
| |
| |

Referees:			

JUNIOR KUMITE FEMALE -59 KG

Campeonato Centroamericano y del Caribe de Karate 2023

Tatami

Pool
1

(c)sportdata GmbH & Co KG 2000-2023 (2023-03-04 17:55) v 10.0.0 build 1 (2023-02-10) License: Online_Event_ID-6936_CampeonatoCentroamericanoydelCaribedeKarate2023 (expire 2023-03-18)

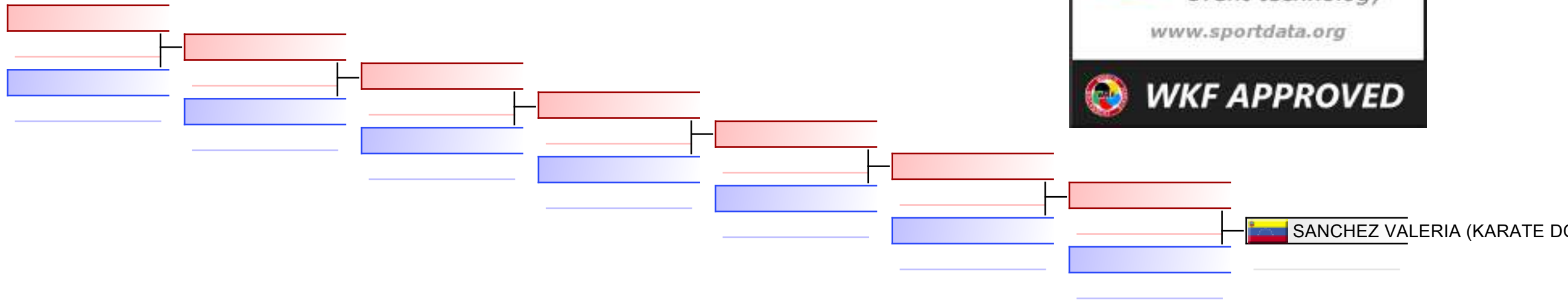

REPECHAGE: (1)

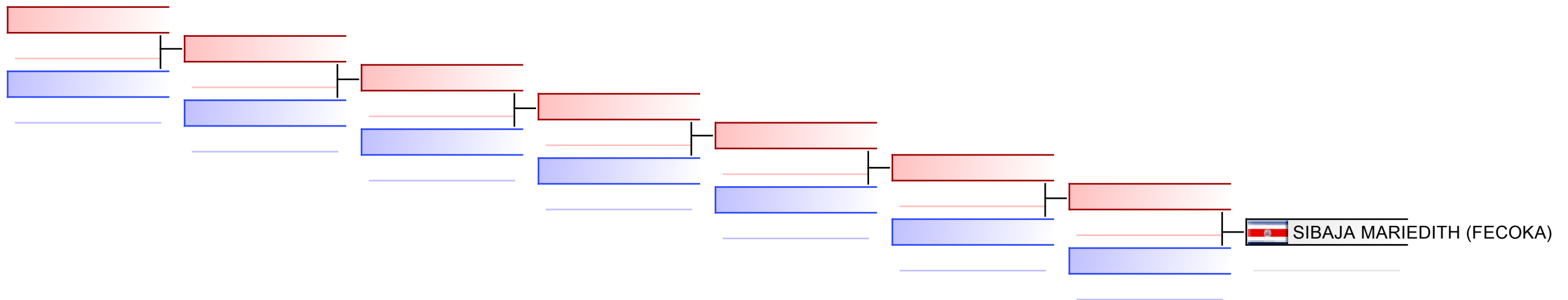

Referees:							
-----------	--	--	--	--	--	--	--

JUNIOR KUMITE FEMALE -66 KG

Campeonato Centroamericano y del Caribe de Karate 2023, Carretera Cocoyoc - Oaxtepec Km 2.5, Centro, 62738 Oaxtepec, MEX

2023-03-03

Tatami
2 11:40

Pool
1/1

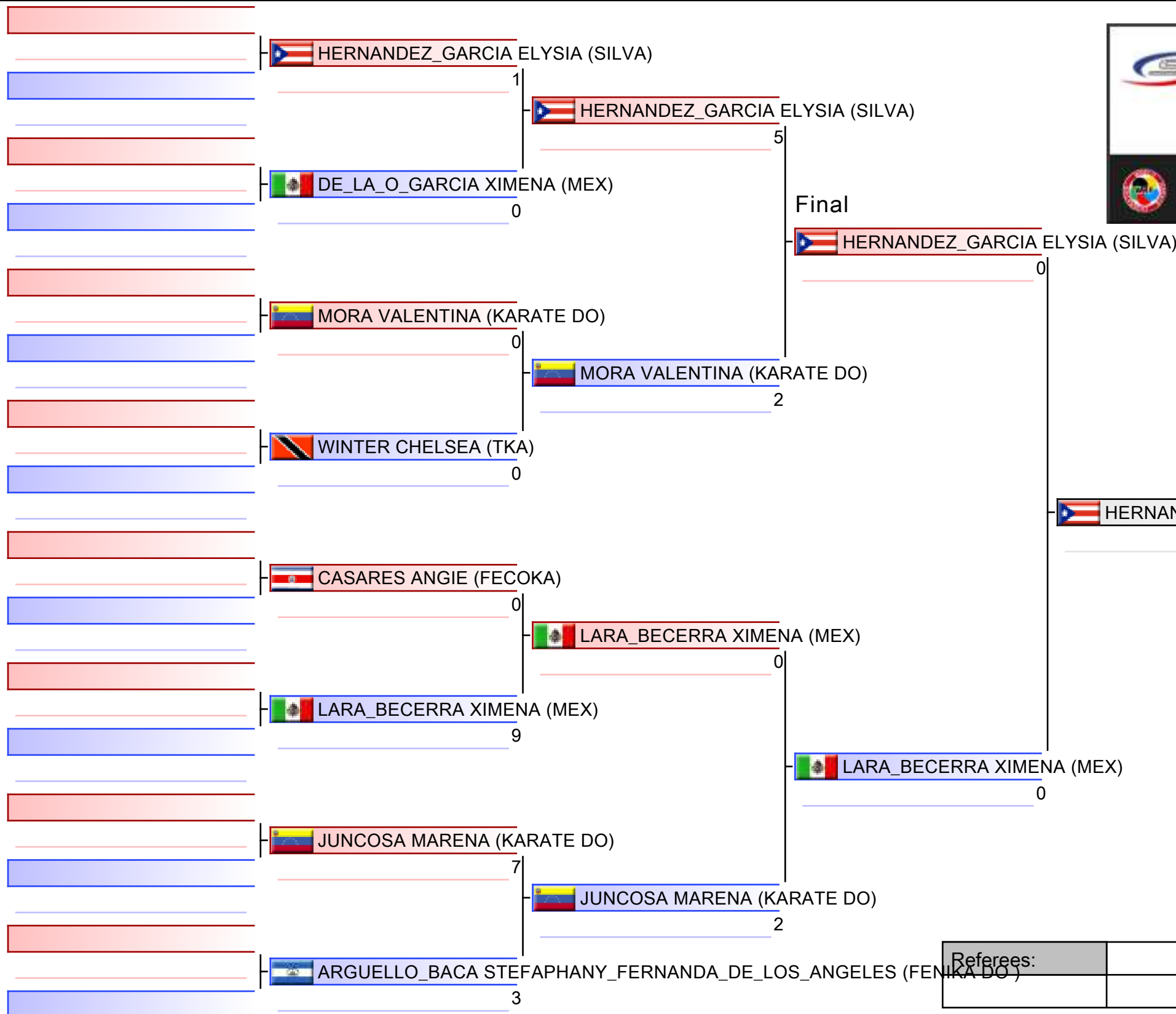

1. HERNANDEZ_GARCIA ELYSIA (SILVA)
2. LARA_BECERRA XIMENA (MEX)
3. MORA VALENTINA (KARATE DO)
3. JUNCOSA MARENA (KARATE DO)
5. DE_LA_O_GARCIA XIMENA (MEX)
5. CASARES ANGIE (FECOKA)

Referees:			

JUNIOR KUMITE FEMALE -66 KG

Campeonato Centroamericano y del Caribe de Karate 2023



2023-03-03

Tatami
2 12:10

Pool
1

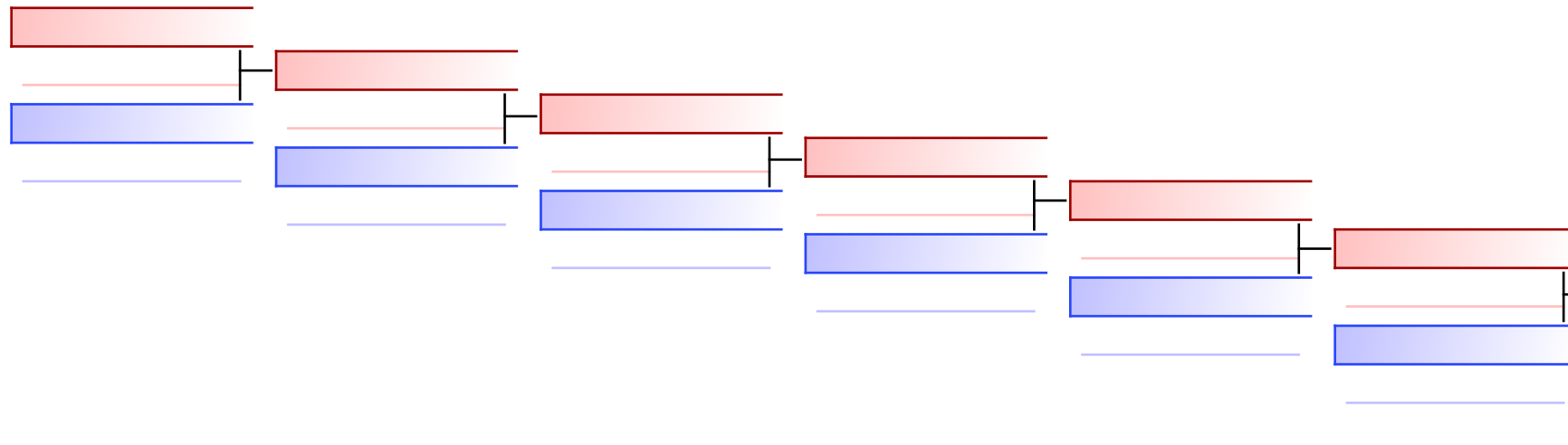
(c)sportdata GmbH & Co KG 2000-2023 (2023-03-04 17:55) v 10.0.0 build 1 (2023-02-10) License: Online_Event_ID-6936_CampeonatoCentroamericanoydelCaribedeKarate2023 (expire 2023-03-18)



 DE_LA_O_GARCIA XIMENA (MEX)
 4
 MORA VALENTINA (KARATE DO)
 MORA VALENTINA (KARATE DO)
 7

REPECHAGE: (1)

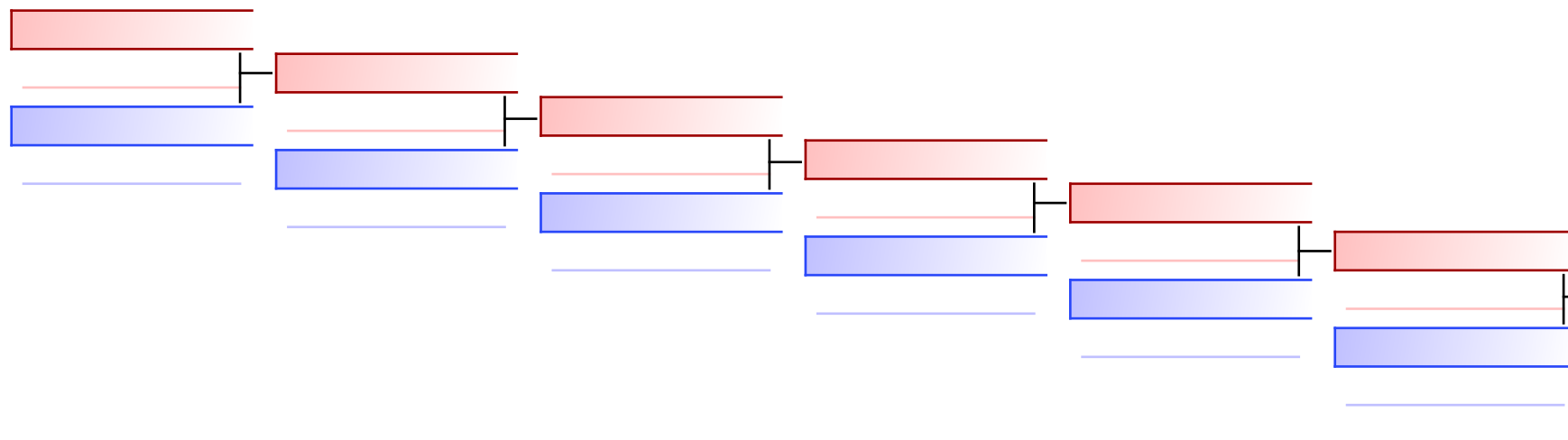

 CASARES ANGIE (FECOKA)
 2
 JUNCOSA MARENA (KARATE DO)
 JUNCOSA MARENA (KARATE DO)
 11

Referees:							
-----------	--	--	--	--	--	--	--

JUNIOR KUMITE FEMALE 66+ KG

Campeonato Centroamericano y del Caribe de Karate 2023, Carretera Cocoyoc - Oaxtepec Km 2.5, Centro, 62738 Oaxtepec, MEX

2023-03-03

Tatami
1 12:05

Pool
1/1

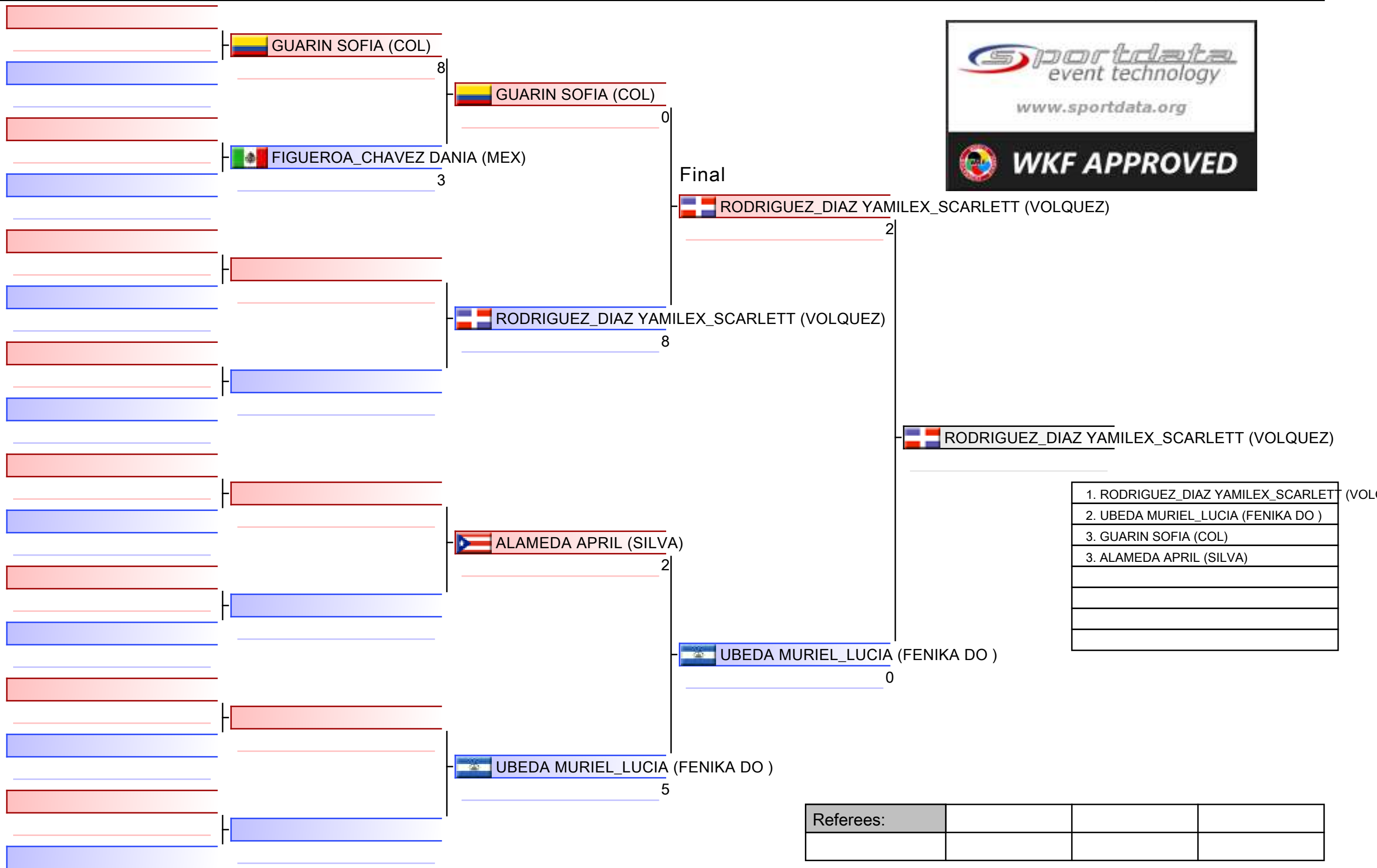

JUNIOR KUMITE FEMALE 66+ KG

Campeonato Centroamericano y del Caribe de Karate 2023

2023-03-03

Tatami
1 12:20

Pool
1

(c)sportdata GmbH & Co KG 2000-2023 (2023-03-04 17:55) v 10.0.0 build 1 (2023-02-10) License: Online_Event_ID-6936_CampeonatoCentroamericanoydelCaribedeKarate2023 (expire 2023-03-18)

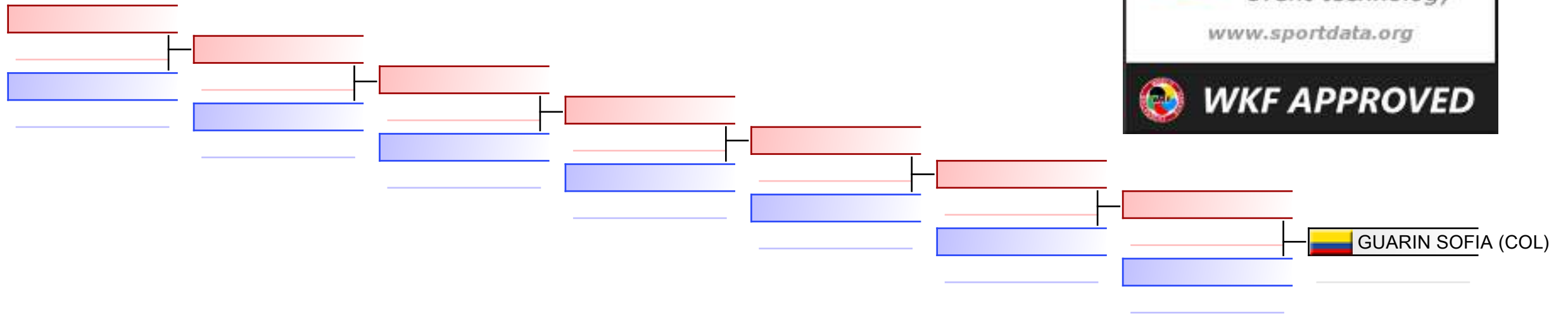

REPECHAGE: (1)

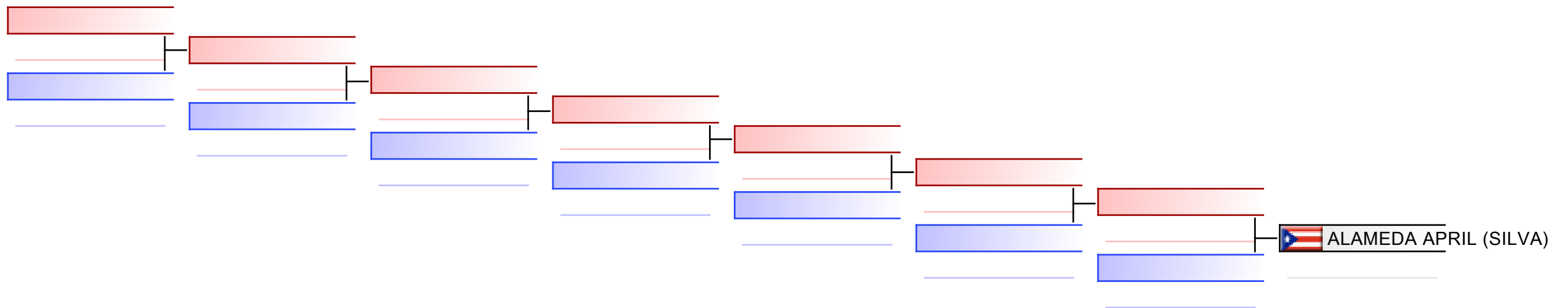

Referees:							
-----------	--	--	--	--	--	--	--

JUNIOR KUMITE MALE -55 KG

Campeonato Centroamericano y del Caribe de Karate 2023, Carretera Cocoyoc - Oaxtepec Km 2.5, Centro, 62738 Oaxtepec, MEX

2023-03-03

Tatami
3 11:15

Pool
1/1

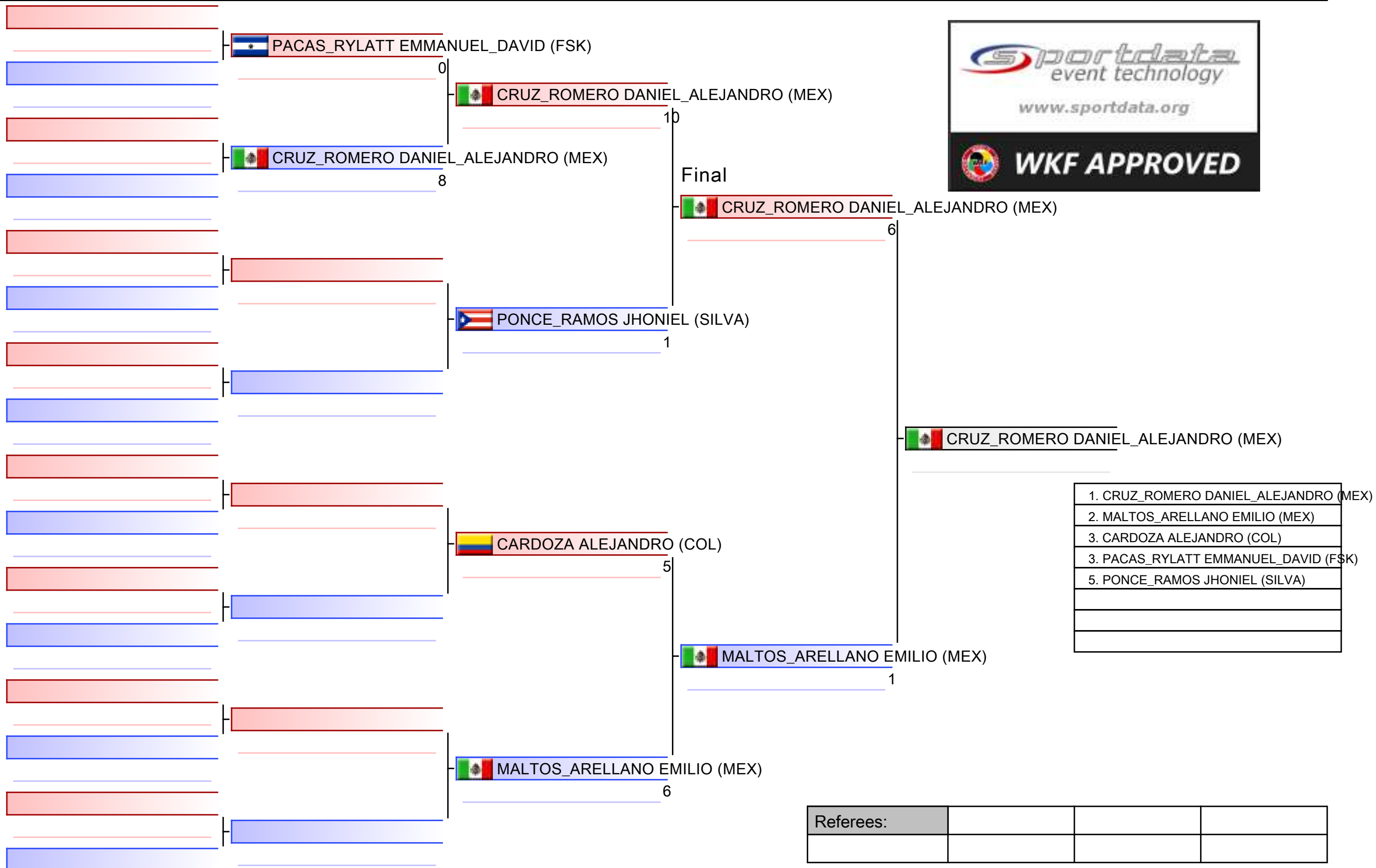

JUNIOR KUMITE MALE -55 KG

Campeonato Centroamericano y del Caribe de Karate 2023



2023-03-03

Tatami
3 11:30

Pool
1

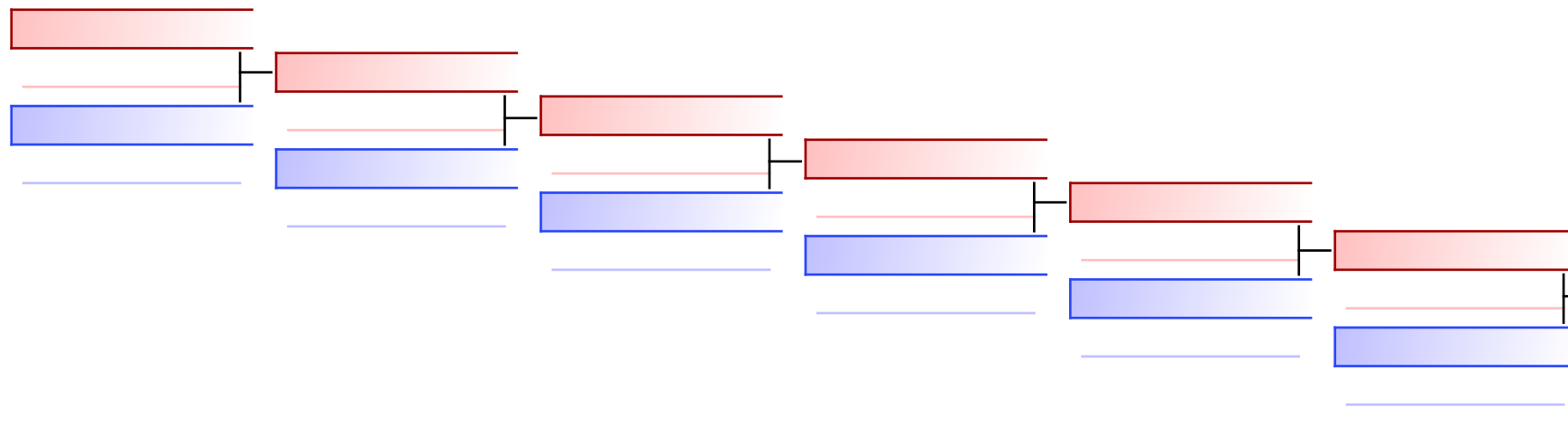
(c)sportdata GmbH & Co KG 2000-2023 (2023-03-04 17:55) v 10.0.0 build 1 (2023-02-10) License: Online_Event_ID-6936_CampeonatoCentroamericanoydelCaribedeKarate2023 (expire 2023-03-18)



 PACAS_RYLATT EMMANUEL_DAVID (FSK)
9
 PACAS_RYLATT EMMANUEL_DAVID
 PONCE_RAMOS JHONIEL (SILVA)
2

REPECHAGE: (1)

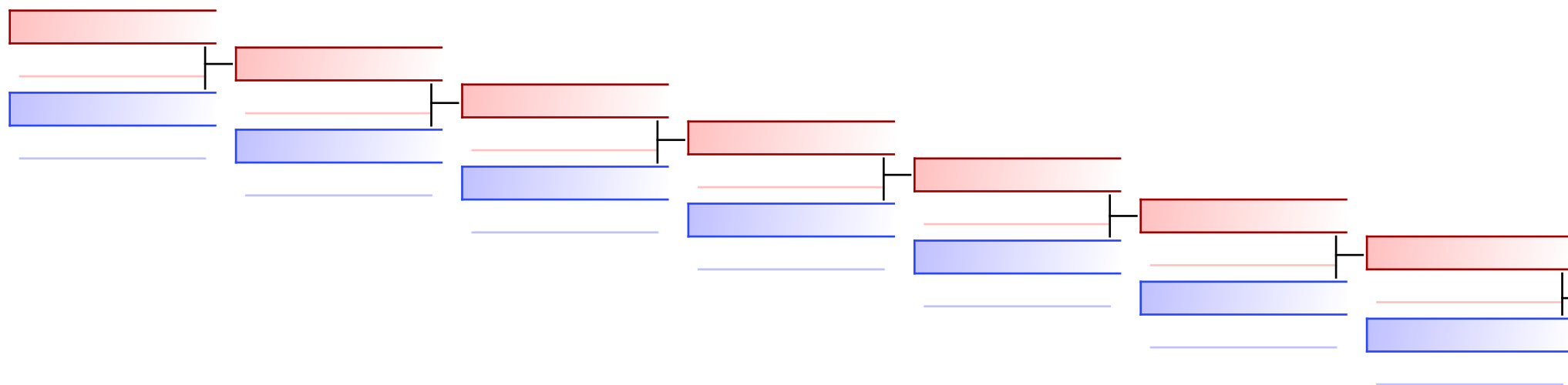

 CARDOZA ALEJANDRO (COL)

Referees:							
-----------	--	--	--	--	--	--	--

JUNIOR KUMITE MALE -61 KG

Campeonato Centroamericano y del Caribe de Karate 2023, Carretera Cocoyoc - Oaxtepec Km 2.5, Centro, 62738 Oaxtepec, MEX

2023-03-03

Tatami
3 11:50

Pool
1/1

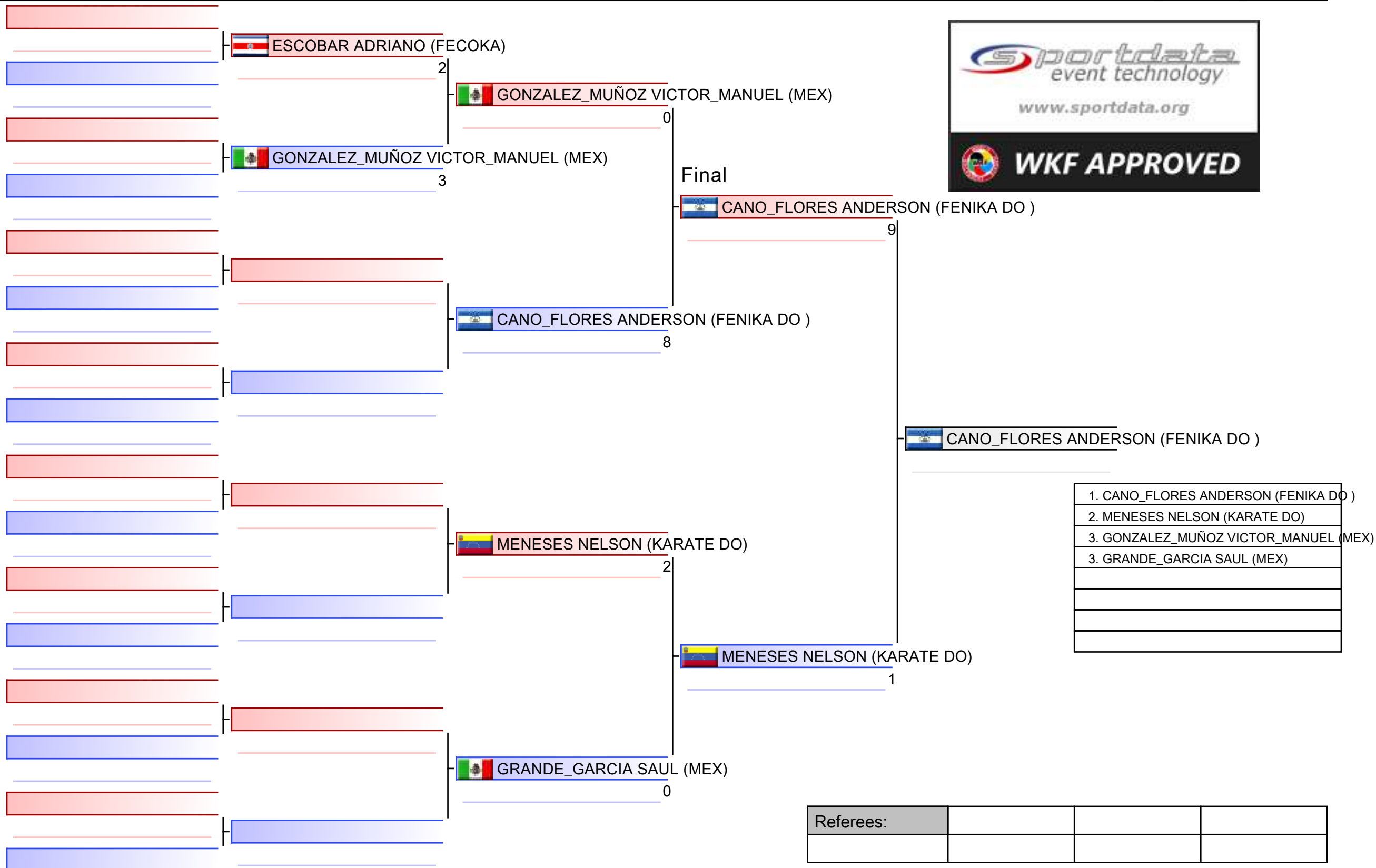

JUNIOR KUMITE MALE -61 KG

Campeonato Centroamericano y del Caribe de Karate 2023

2023-03-03

Tatami
3 12:05

Pool
1

(c)sportdata GmbH & Co KG 2000-2023 (2023-03-04 17:55) v 10.0.0 build 1 (2023-02-10) License: Online_Event_ID-6936_CampeonatoCentroamericanoydelCaribedeKarate2023 (expire 2023-03-18)

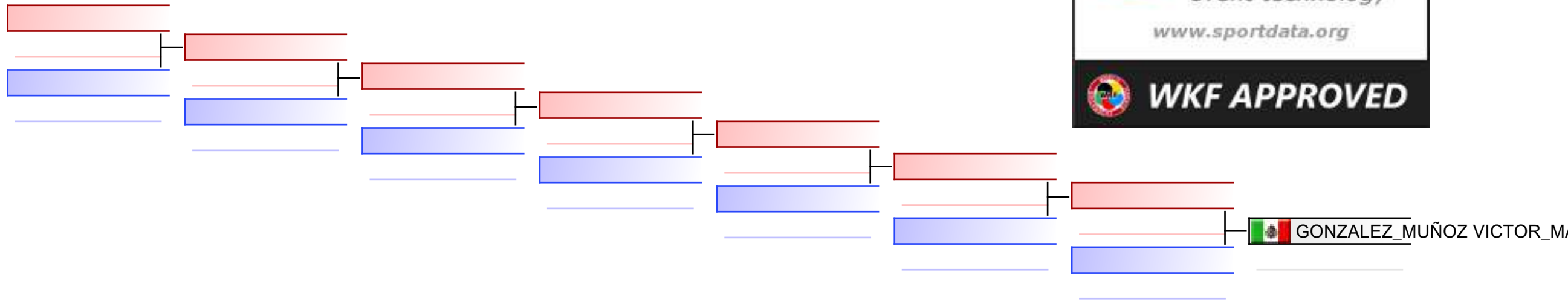

REPECHAGE: (1)

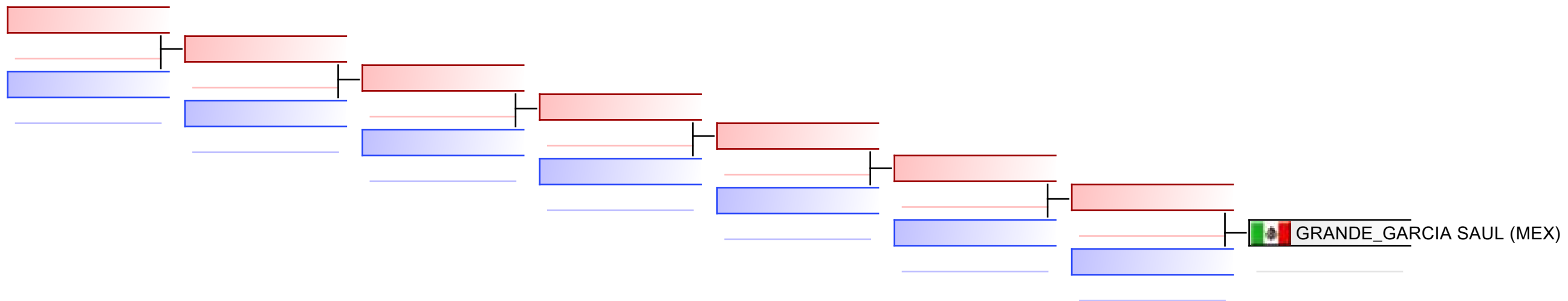

Referees:							
-----------	--	--	--	--	--	--	--

JUNIOR KUMITE MALE -68 KG

Campeonato Centroamericano y del Caribe de Karate 2023, Carretera Cocoyoc - Oaxtepec Km 2.5, Centro, 62738 Oaxtepec, MEX

2023-03-03

Tatami
3 12:25

Pool
1/1

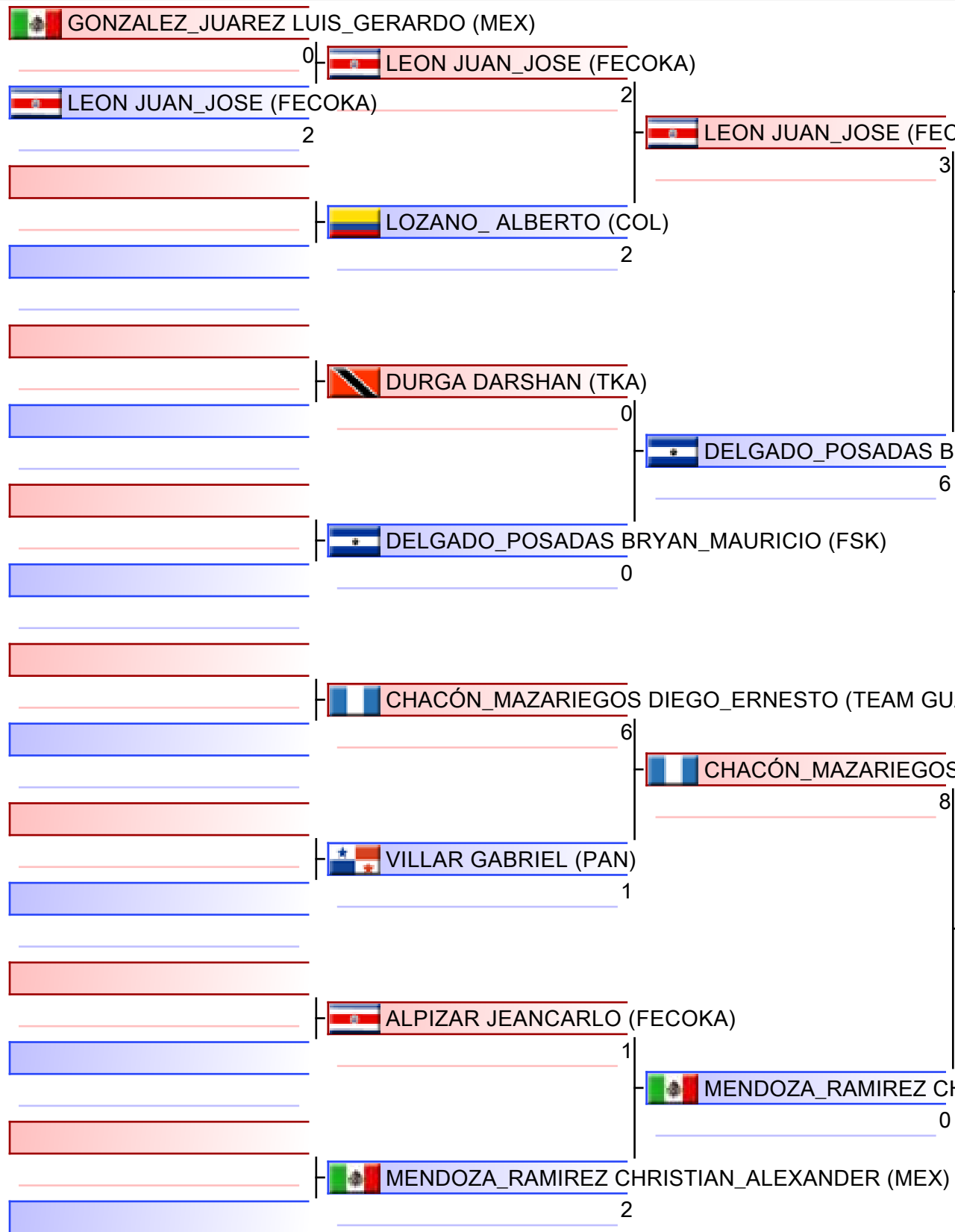

1. CHACÓN_MAZARIEGOS DIEGO ERNESTO (TEAM GUATEMALA)
2. DELGADO_POSADAS BRYAN MAURICIO (FSK)
3. LEON JUAN JOSE (FECOKA)
3. MENDOZA_RAMIREZ CHRISTIAN ALEXANDER (MEX)
5. DURGA DARSHAN (TKA)
5. VILLAR GABRIEL (PAN)

Referees:			

JUNIOR KUMITE MALE -68 KG

Campeonato Centroamericano y del Caribe de Karate 2023

2023-03-03

Tatami
3 12:55

Pool
1

(c)sportdata GmbH & Co KG 2000-2023 (2023-03-04 17:55) v 10.0.0 build 1 (2023-02-10) License: Online_Event_ID-6936_CampeonatoCentroamericanoydelCaribedeKarate2023 (expire 2023-03-18)

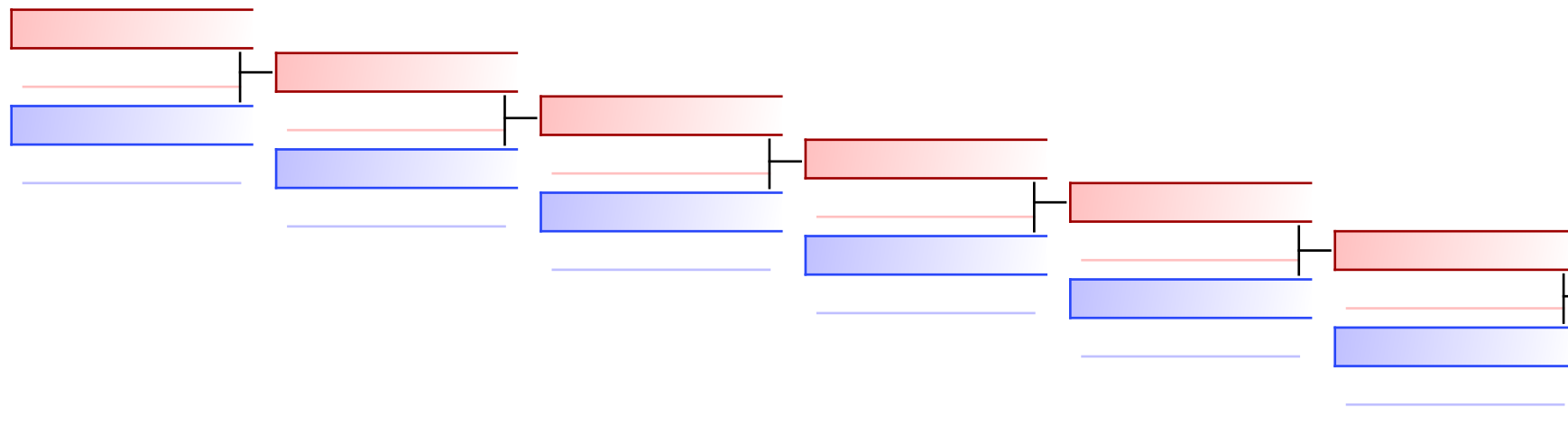

DURGA DARSHAN (TKA)
0
LEON JUAN JOSE (FECOKA)
0

REPECHAGE: (1)

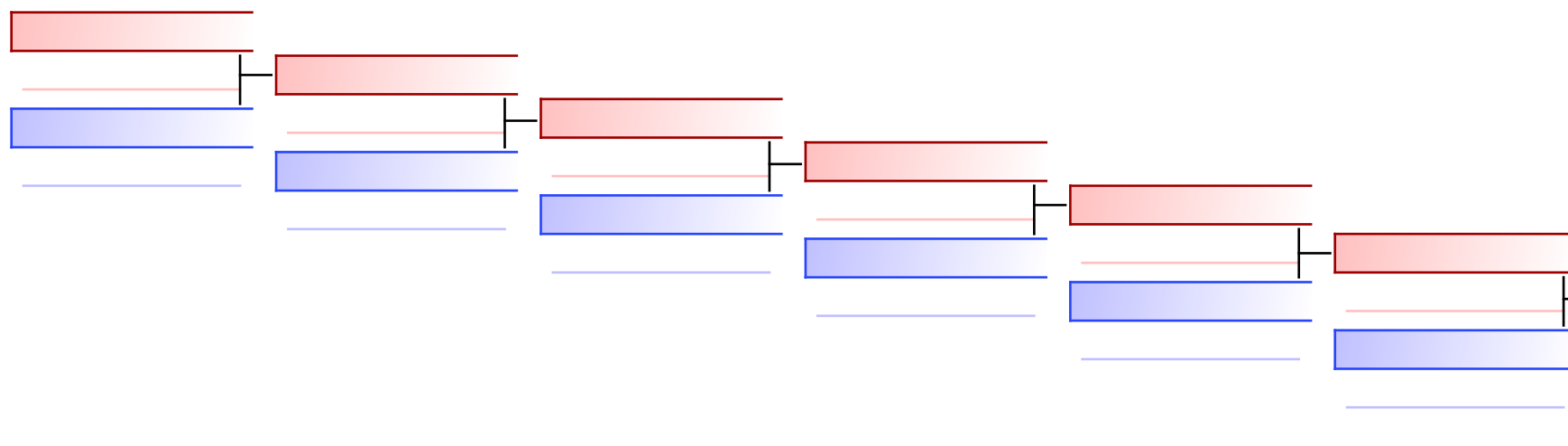

VILLAR GABRIEL (PAN)
0
MENDOZA RAMIREZ CHRISTIAN ALEXANDER (MEX)
2

Referees:							
-----------	--	--	--	--	--	--	--

JUNIOR KUMITE MALE -76 KG

Campeonato Centroamericano y del Caribe de Karate 2023, Carretera Cocoyoc - Oaxtepec Km 2.5, Centro, 62738 Oaxtepec, MEX

2023-03-03

Tatami
2 12:30

Pool
1/1

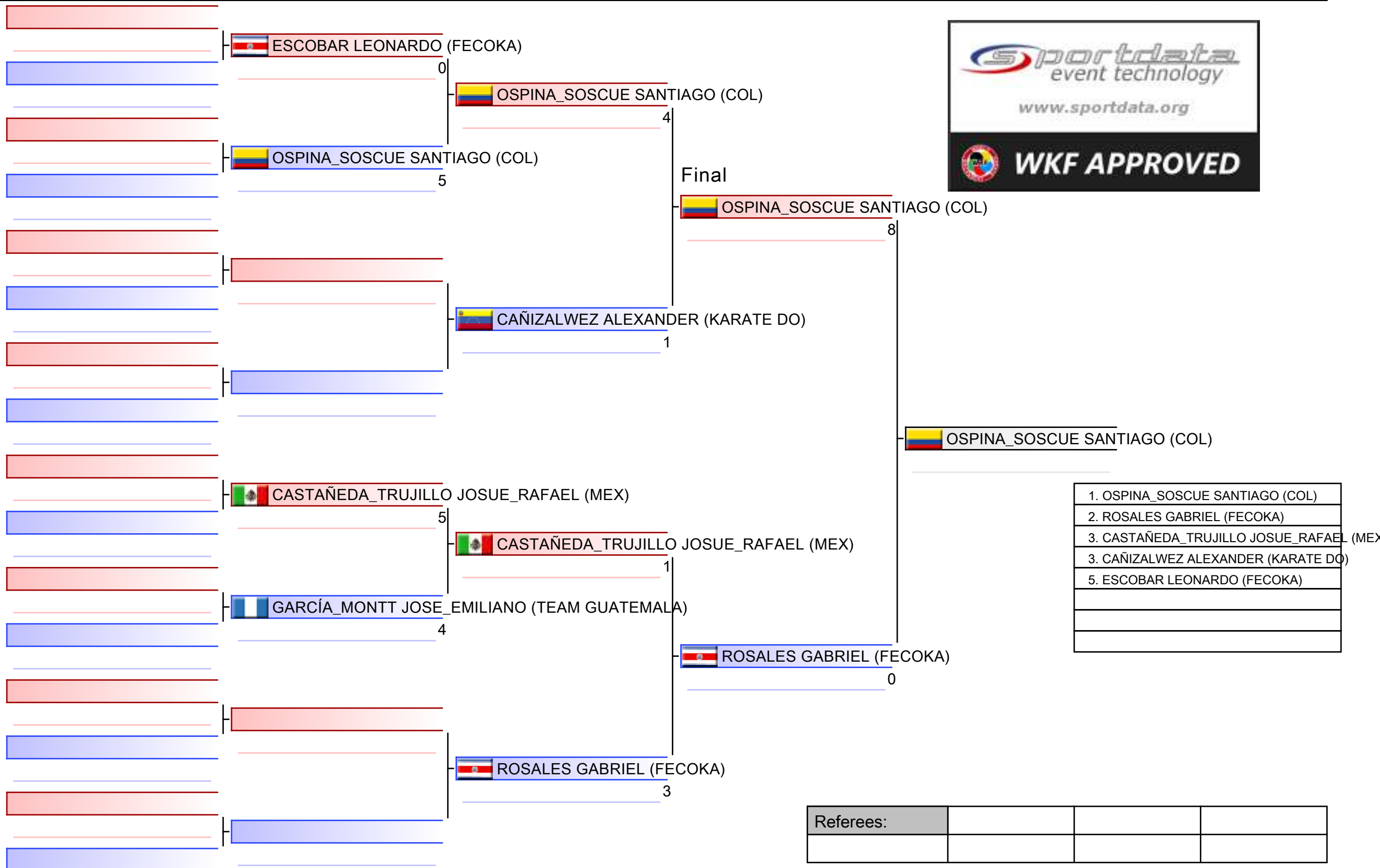

JUNIOR KUMITE MALE -76 KG

Campeonato Centroamericano y del Caribe de Karate 2023

2023-03-03

Tatami
2 12:50

Pool
1

(c)sportdata GmbH & Co KG 2000-2023 (2023-03-04 17:55) v 10.0.0 build 1 (2023-02-10) License: Online_Event_ID-6936_CampeonatoCentroamericanoydelCaribedeKarate2023 (expire 2023-03-18)

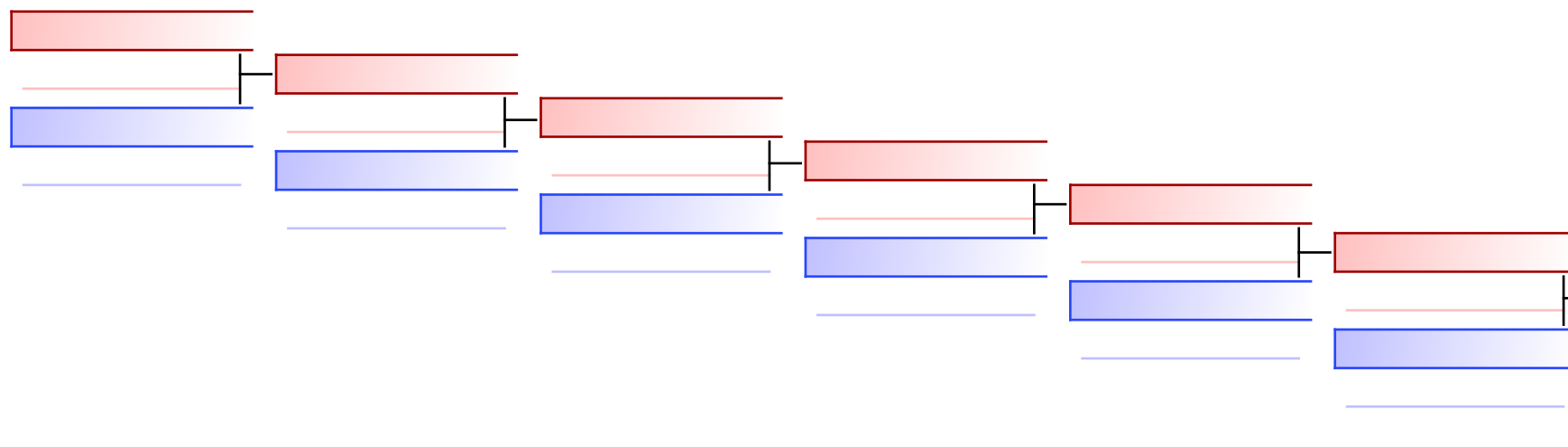

ESCOBAR LEONARDO (FECOKA)
1
 CAÑIZALWEZ ALEXANDER (KARATE DO)
4

REPECHAGE: (1)

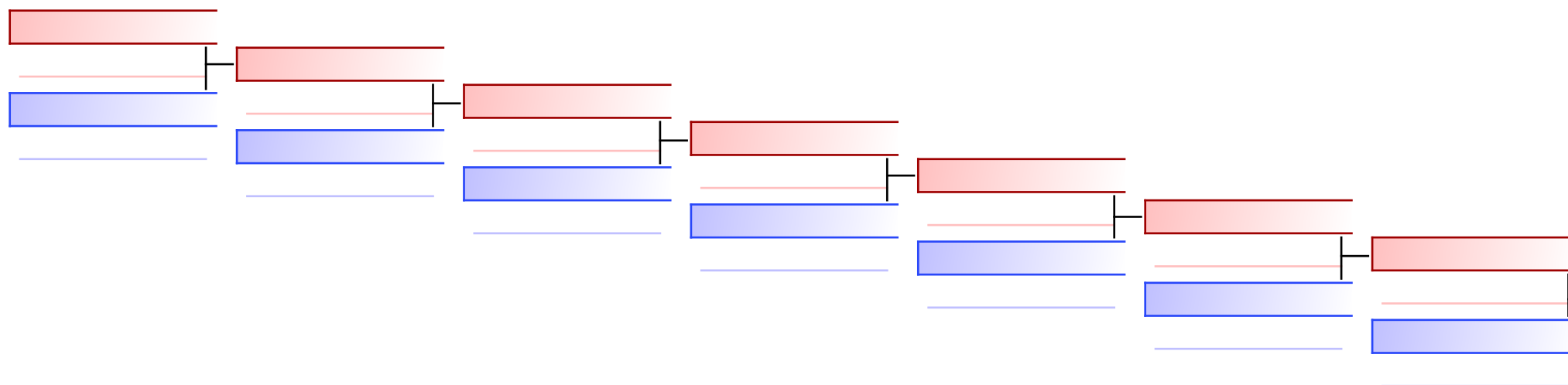

CASTAÑEDA_TRUJILLO JOSUE

Referees:							
-----------	--	--	--	--	--	--	--

JUNIOR KUMITE MALE 76+ KG

Campeonato Centroamericano y del Caribe de Karate 2023, Carretera Cocoyoc - Oaxtepec Km 2.5, Centro, 62738 Oaxtepec, MEX

2023-03-03

Tatami
1 12:40

Pool
1/1

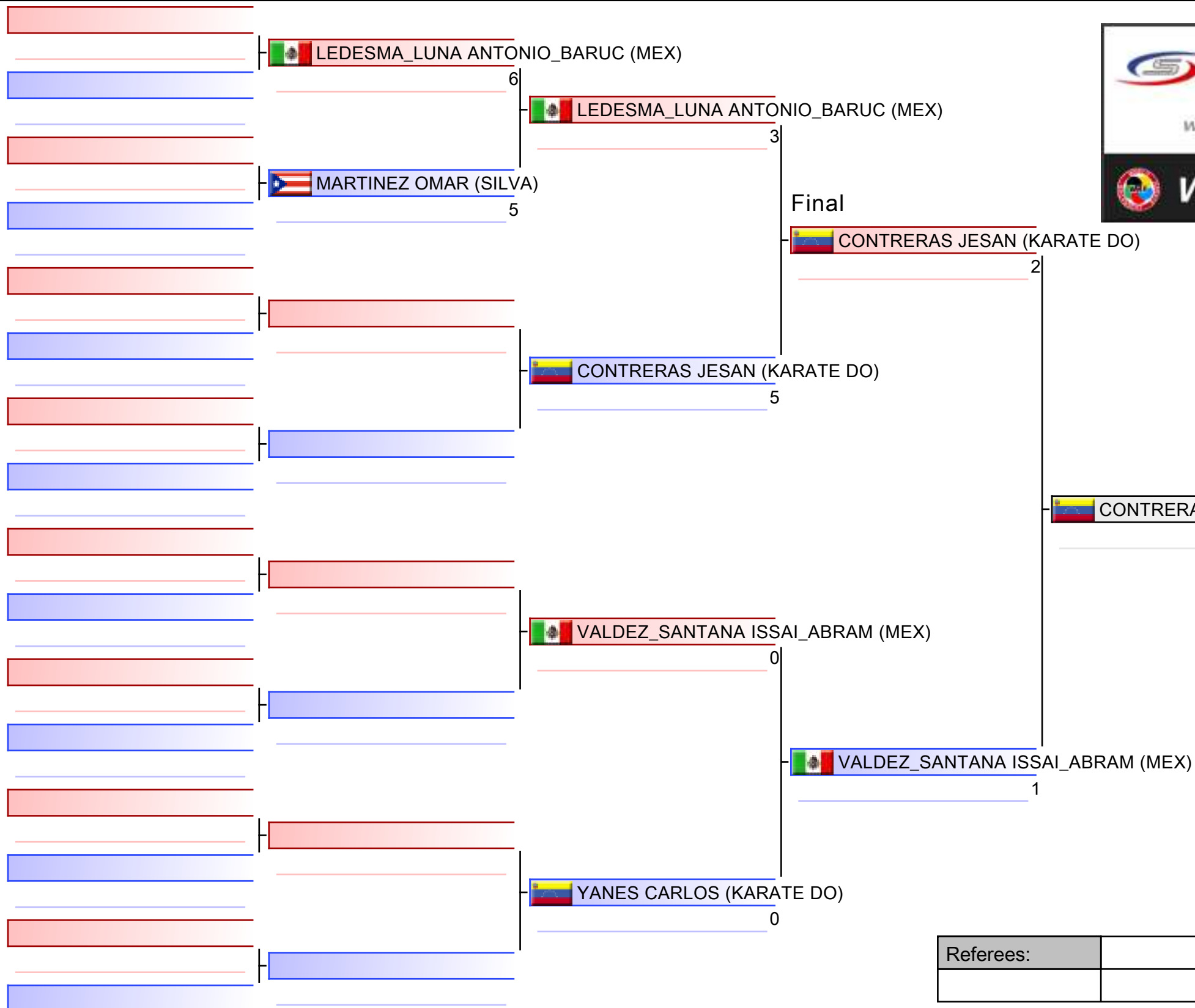

1. CONTRERAS JESAN (KARATE DO)
2. VALDEZ_SANTANA ISSAI_ABRAM (MEX)
3. LEDESMA_LUNA ANTONIO_BARUC (MEX)

Referees:			

JUNIOR KUMITE MALE 76+ KG

Campeonato Centroamericano y del Caribe de Karate 2023

2023-03-03

Tatami
1 12:55

Pool
1

(c)sportdata GmbH & Co KG 2000-2023 (2023-03-04 17:55) v 10.0.0 build 1 (2023-02-10) License: Online_Event_ID-6936_CampeonatoCentroamericanoydelCaribedeKarate2023 (expire 2023-03-18)

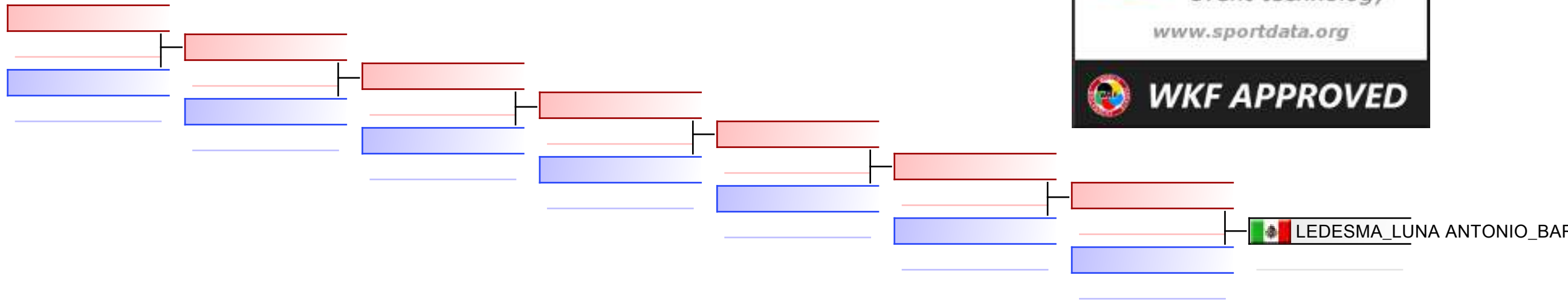

REPECHAGE: (1)

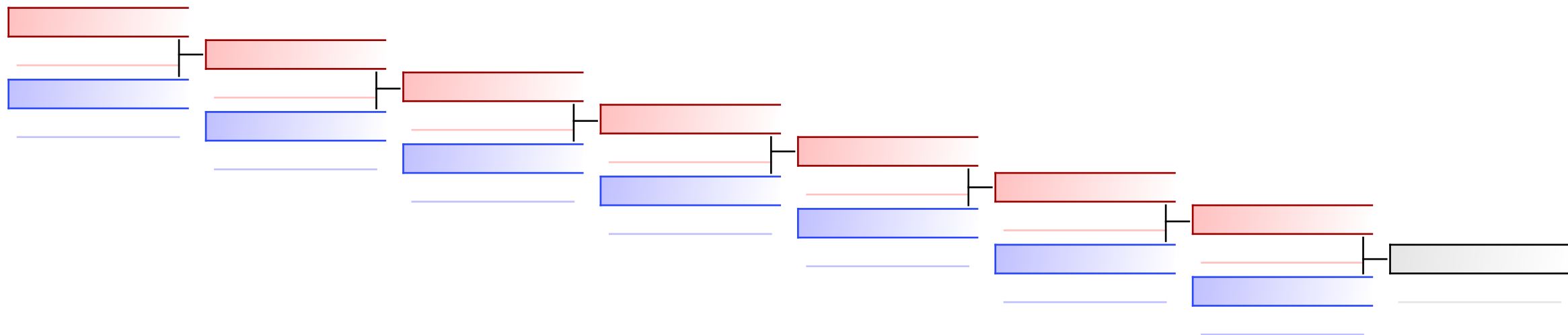

Referees:							
-----------	--	--	--	--	--	--	--

**Campeonato Centroamericano y del
Caribe de Karate 2023 - 2023-03-02**

Male kata

R1 G1/2 (10) Tatami 3 09:00(2023-03-04)

Competitors	Kata	1	2	3	4	5	6	7	TOTAL	Extra Total Rank
1 DAVID KERRON (TKA)	001 ANAN	7.2	7.4	7.2	(8.4)	(6.9)			21.8	21.8 10
2 RAMIREZ ALEJANDRO (COL)	099 UNSU	7.9	7.8	(7.1)	(8.6)	7.3			23.0	23.0 7
3 GALINDO MIGUEL (KARATE DO)	065 OYADOMARI NO PASSAI	8.2	8.2	7.8	(8.7)	(7.5)			24.2	24.2 1
4 ARMIJO ESTRADA KEVIN RICARDO (FEDERACIÓN DE KARATÉ DE HONDURAS)	008 CHATANYARA KUSHANKU	7.4	7.4	(7.0)	(8.3)	7.4			22.2	22.2 9
5 CENCION HECTOR (PAN)	021 GOJUSHIHO SHO	8.1	(8.3)	7.7	(7.5)	7.7			23.5	23.5 5
6 CANCEL NUNEZ ANGEL (SILVA)	002 ANAN DAI	7.7	(7.3)	7.5	(8.0)	7.4			22.6	22.6 8
7 TEPAL BRISEÑO AHXEL DANIEL (MEX)	001 ANAN	7.9	(8.0)	(7.7)	7.7	7.9			23.5	23.5 4
8 NÚÑEZ JOSHUA (FECOKA)	078 SANSAI	(8.0)	7.9	7.9	(7.6)	7.8			23.6	23.6 3
9 CALDERÓN ROCA FERNANDO (TEAM GUATEMALA)	002 ANAN DAI	7.9	(7.6)	(8.2)	7.9	7.6			23.4	23.4 6
10 TERUEL URAN JAIME ROBERTO (VOLQUEZ)	064 OHAN DAI	(8.1)	8.0	(7.6)	7.9	7.8			23.7	23.7 2

R1 G2/2 (10) Tatami 4 09:00(2023-03-04)

Competitors	Kata	1	2	3	4	5	6	7	TOTAL	Extra Total Rank
1 RODRIGUEZ CARLOS (FENIKA DO)	001 ANAN	7.3	7.3	7.4	(7.2)	(7.7)			22.0	22.0 7
2 VALDEZ SAGASTEGUI ALBERTO (MEX)	002 ANAN DAI	(7.5)	7.5	8.0	7.6	(8.1)			23.1	23.1 3
3 ARMIJO ALVAREZ DEYVID STUART (FEDERACIÓN DE KARATE DE HONDURAS)	002 ANAN DAI	7.3	7.3	(7.2)	7.4	(7.6)			22.0	22.0 8
4 BAUZA MAGAÑA CARLOS SAMUEL (TEAM)	099 UNSU	(7.2)	7.4	(7.5)	7.5	7.5			22.4	22.4 6
5 VAZQUEZ SANCHEZ ROBERTO (SILVA)	064 OHAN DAI	7.5	7.6	7.9	(7.4)	(8.0)			23.0	23.0 4
6 CASANOVA CLEIVER (KARATE DO)	091 SOCHIN	7.8	(7.4)	(8.2)	7.9	8.1			23.8	23.8 1
7 ARACENA DURAN LARRY GENARO (VOLQUEZ)										
8 MORALES MAGAÑA DOUGLAS OMAR (FSK)										
9 AMAYA GOMEZ HERNAN (COL)	068 PAPUREN	(7.6)	7.7	(8.1)	7.8	7.6			23.1	23.1 2
10 CAMBRONERO SERGIO (FECOKA)	021 GOJUSHIHO SHO	(7.5)	7.5	(7.7)	7.6	7.7			22.8	22.8 5

R2-G1 Tatami 3 09:45(2023-03-04)

Competitors	Kata	1	2	3	4	5	6	7	TOTAL	Extra Total Rank
1 TEPAL BRISEÑO AHXEL DANIEL (MEX)	002 ANAN DAI	(8.0)	7.9	7.9	7.7	(7.6)			23.5	23.5 3
2 GALINDO MIGUEL (KARATE DO)	068 PAPUREN	(8.3)	8.3	8.1	7.9	(7.8)			24.3	24.3 1
3 TERUEL URAN JAIME ROBERTO (VOLQUEZ)	008 CHATANYARA KUSHANKU	(8.5)	8.1	(7.7)	8.1	7.8			24.0	24.0 2
4 NÚÑEZ JOSHUA (FECOKA)	092 SUPARINPEI	(8.4)	8.0	(7.6)	7.8	7.6			23.4	23.4 4

R2-G2 Tatami 4 09:45(2023-03-04)

Competitors	Kata	1	2	3	4	5	6	7	TOTAL	Extra Total Rank
1 VALDEZ SAGASTEGUI ALBERTO (MEX)	008 CHATANYARA KUSHANKU	(7.5)	7.6	(7.9)	7.6	7.5			22.7	22.7 3
2 CASANOVA CLEIVER (KARATE DO)	021 GOJUSHIHO SHO	7.9	(7.7)	(8.1)	7.9	7.7			23.5	23.5 1
3 VAZQUEZ SANCHEZ ROBERTO (SILVA)	008 CHATANYARA KUSHANKU	7.6	(7.8)	7.5	(7.4)	7.6			22.7	22.7 4
4 AMAYA GOMEZ HERNAN (COL)	002 ANAN DAI	7.7	(7.6)	7.8	7.7	(8.0)			23.2	23.2 2

R3 Bronze Medal Match 1 Tatami 3 10:05(2023-03-04)

Competitors	Kata	1	2	3	4	5	6	7	TOTAL	Extra Total Rank
1 TERUEL URAN JAIME ROBERTO (VOLQUEZ)	092 SUPARINPEI	(8.3)	8.0	8.0	8.2	(7.7)			24.2	24.2 1
2 VALDEZ SAGASTEGUI ALBERTO (MEX)	092 SUPARINPEI	8.1	7.9	7.9	(8.3)	(7.5)			23.9	23.9 2

R3 Bronze Medal Match 2 Tatami 4 10:05(2023-03-04)

Competitors	Kata	1	2	3	4	5	6	7	TOTAL	Extra Total Rank
1 TEPAL BRISEÑO AHXEL DANIEL (MEX)	064 OHAN DAI	(7.6)	7.8	(8.3)	7.7	7.6			23.1	23.1 2
2 AMAYA GOMEZ HERNAN (COL)	092 SUPARINPEI	(7.7)	8.1	(8.5)	7.9	7.9			23.9	23.9 1

R3 Gold Medal Match Tatami 4 10:15(2023-03-04)



















Competitors	Kata	1	2	3	4	5	6	7	TOTAL	Extra Total Rank
-------------	------	---	---	---	---	---	---	---	-------	------------------

**Campeonato Centroamericano y del
Caribe de Karate 2023 - 2023-03-02**

Male kata

1	GALINDO MIGUEL (KARATE DO)	052 MATSUMURA BASSAI	(7.8)	8.0	(8.4)	7.8	8.0						23.8			23.8	2
2	CASANOVA CLEIVER (KARATE DO)	099 UNSU	8.0	8.2	(8.6)	(7.9)	8.2						24.4			24.4	1

Results

1	CASANOVA CLEIVER	KARATE DO		VENEZUELA
2	GALINDO MIGUEL	KARATE DO		VENEZUELA
3	TERUEL URAN JAIME ROBERTO	VOLQUEZ		DOMINICAN REPUBLIC
3	AMAYA GOMEZ HERNAN	COLOMBIA		COLOMBIA
5	VALDEZ SAGASTEGUI ALBERTO	MEXICO		MEXICO
5	TEPAL BRISENO AHXEL DANIEL	MEXICO		MEXICO
7	NUNEZ JOSHUA	FEDERACION COSTARRICENSE DE KARATE		COSTA RICA
7	VAZQUEZ SANCHEZ ROBERTO	SILVA		PUERTO RICO
9	CENCION HECTOR	PANAMA		PANAMA
9	CAMBRONERO SERGIO	FEDERACION COSTARRICENSE DE KARATE		COSTA RICA
11	CALDERÓN ROCA FERNANDO	TEAM GUATEMALA		GUATEMALA
11	BAUZA MAGAÑA CARLOS SAMUEL	TEAM		CUBA
13	RAMIREZ ALEJANDRO	COLOMBIA		COLOMBIA
13	RODRIGUEZ CARLOS	FEDERACION NICARAGUENSE DE KARATE		NICARAGUA
15	CANCEL NUNEZ ANGEL	SILVA		PUERTO RICO
15	ARMIJO ALVAREZ DEYVID STUART	FEDERACIÓN DE KARATE DE HONDURAS		HONDURAS
17	ARMIJO ESTRADA KEVIN RICARDO	FEDERACIÓN DE KARATE DE HONDURAS		HONDURAS
19	DAVID KERRON	TRINIDAD KARATE ASSOCIATION		TRINIDAD AND TOBAGO

**Campeonato Centroamericano y del
Caribe de Karate 2023 - 2023-03-02**

MALE KATA TEAM

R1 G1/2 (2) Tatami 3 10:30(2023-03-04)

Competitors	Kata	1	2	3	4	5	6	7	TOTAL	Extra Total Rank
1 VOLQUEZ (ARACENA DURAN, DE CASTRO ESPAILLAT, TERUEL URAN) (VOLQUEZ)	064 OHAN DAI	7.9	7.8	(7.6)	7.7	(8.3)			23.4	23.4 2
2 FEDERACION COSTARRICENSE DE KARATE (CAMBRONERO, NUÑEZ, PORTILLO) (FECOKA)	041 KANKU SHO	8.1	(8.4)	(7.9)	8.0	8.2			24.3	24.3 1





R1 G2/2 (2) Tatami 4 10:30(2023-03-04)

Competitors	Kata	1	2	3	4	5	6	7	TOTAL	Extra Total Rank
1 DESCIDERIO (FLORES BALDERAS, PONCE VALDEZ, TEPAL BRISEÑO) (MEX)	001 ANAN	(7.4)	(7.8)	7.5	7.8	7.7			23.0	23.0 2
2 COLOMBIA (DIAZ, GIRALDO, RAMIREZ) (COL)	041 KANKU SHO	7.7	(7.9)	(7.6)	7.8	7.9			23.4	23.4 1

R2 Gold Medal Match Tatami 4 10:40(2023-03-04)

Competitors	Kata	1	2	3	4	5	6	7	TOTAL	Extra Total Rank
1 FEDERACION COSTARRICENSE DE KARATE (CAMBRONERO, NUÑEZ, PORTILLO) (FECOKA)	099 UNSU	(7.4)	7.5	(7.8)	7.4	7.6			22.5	22.5 2
2 COLOMBIA (DIAZ, GIRALDO, RAMIREZ) (COL)	099 UNSU	(7.8)	7.8	(8.0)	7.8	7.8			23.4	23.4 1

Results

1	COLOMBIA - RAMIREZ ALEJANDRO - GIRALDO SAMUEL - DIAZ DANNY_ALEJANDRO	COLOMBIA		COLOMBIA
2	FEDERACION COSTARRICENSE DE KARATE - CAMBRONERO SERGIO - NUÑEZ JOSHUA - PORTILLO MATIAS	FEDERACION COSTARRICENSE DE KARATE		COSTA RICA
3	VOLQUEZ - ARACENA DURAN LARRY_GENARO - DE CASTRO ESPAILLAT HERIBERTO_DE_JESUS - TERUEL URAN JAIME_ROBERTO	VOLQUEZ		DOMINICAN REPUBLIC
3	DESCIDERIO - FLORES BALDERAS ARTURO - PONCE VALDEZ FERNANDO - TEPAL BRISEÑO AHXEL DANIEL	MEXICO		MEXICO

Male Kumite -60 kg

Campeonato Centroamericano y del Caribe de Karate 2023, Carretera Cocoyoc - Oaxtepec Km 2.5, Centro, 62738 Oaxtepec, MEX

2023-03-04

Tatami
2 14:45

Pool
1/1

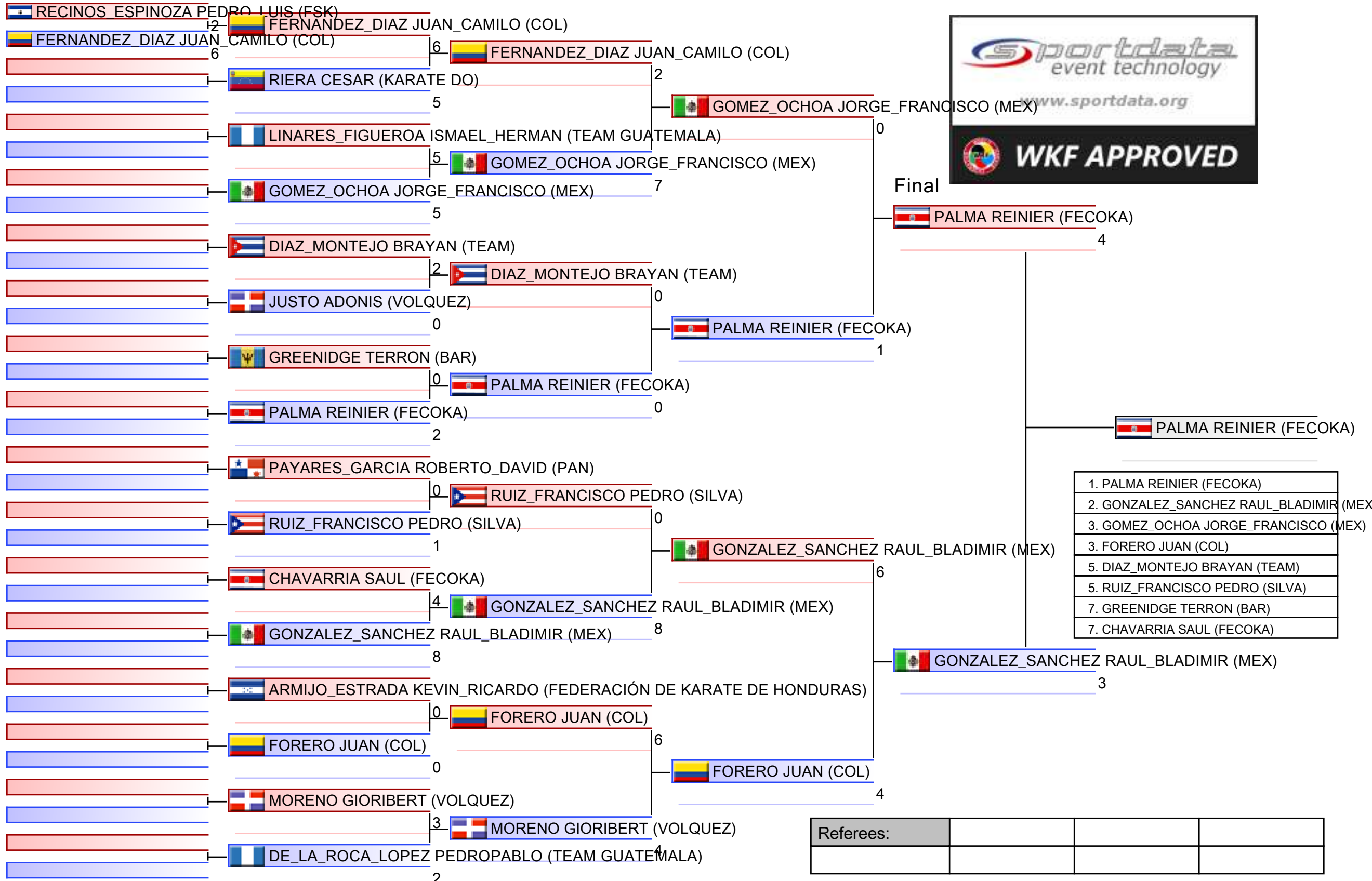

Referees:			

Male Kumite -60 kg

Campeonato Centroamericano y del Caribe de Karate 2023

2023-03-04

Tatami
2 16:15

Pool
1

(c)sportdata GmbH & Co KG 2000-2023 (2023-03-04 17:55) v 10.0.0 build 1 (2023-02-10) License: Online_Event_ID-6936_CampeonatoCentroamericanoydelCaribedeKarate2023 (expire 2023-03-18)

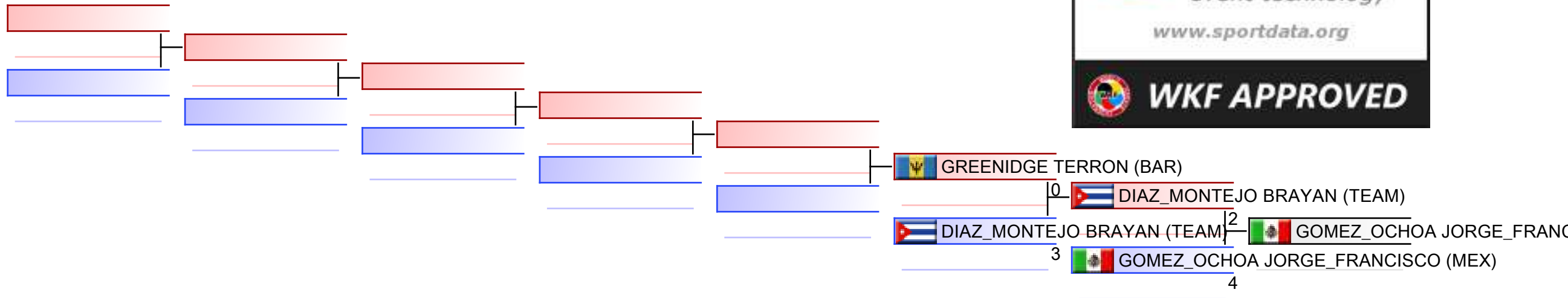

REPECHAGE: (1)

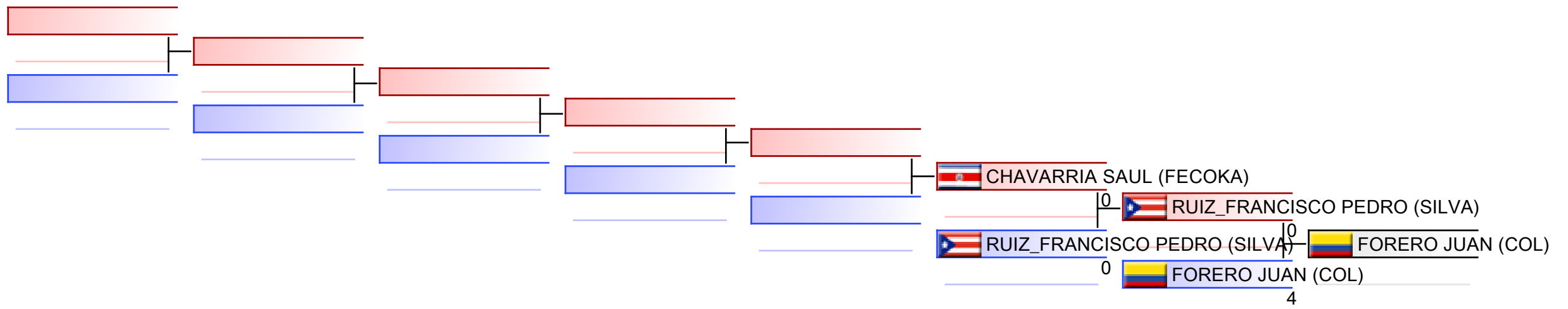

Referees:							
-----------	--	--	--	--	--	--	--

Male Kumite -67 kg

Campeonato Centroamericano y del Caribe de Karate 2023, Carretera Cocoyoc - Oaxtepec Km 2.5, Centro, 62738 Oaxtepec, MEX

2023-03-04

Tatami
3 13:15

Pool
1/1

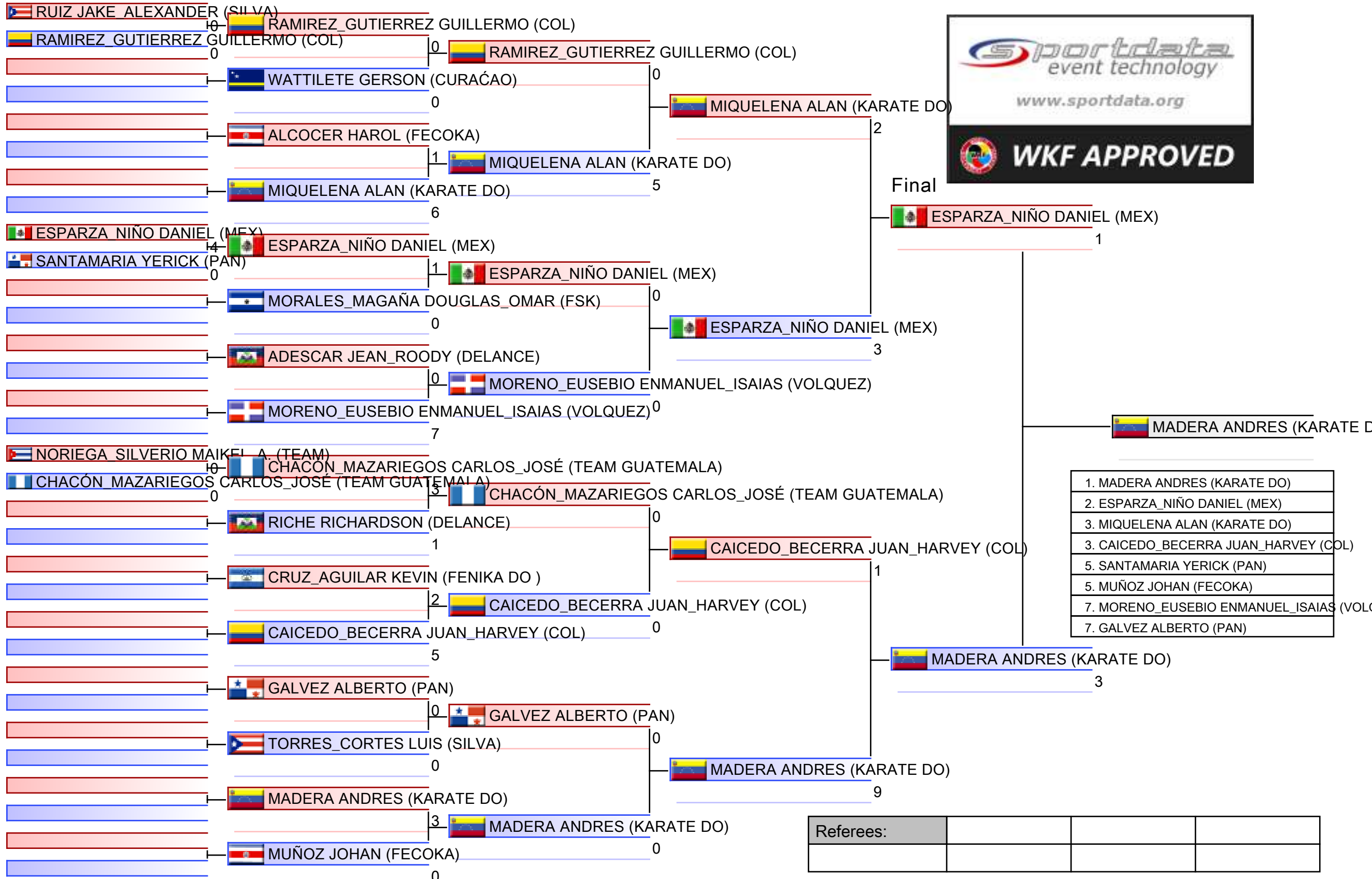

Referees:			

Male Kumite -67 kg

Campeonato Centroamericano y del Caribe de Karate 2023

2023-03-04

Tatami
3 15:00

Pool
1

(c)sportdata GmbH & Co KG 2000-2023 (2023-03-04 17:55) v 10.0.0 build 1 (2023-02-10) License: Online_Event_ID-6936_CampeonatoCentroamericanoydelCaribedeKarate2023 (expire 2023-03-18)

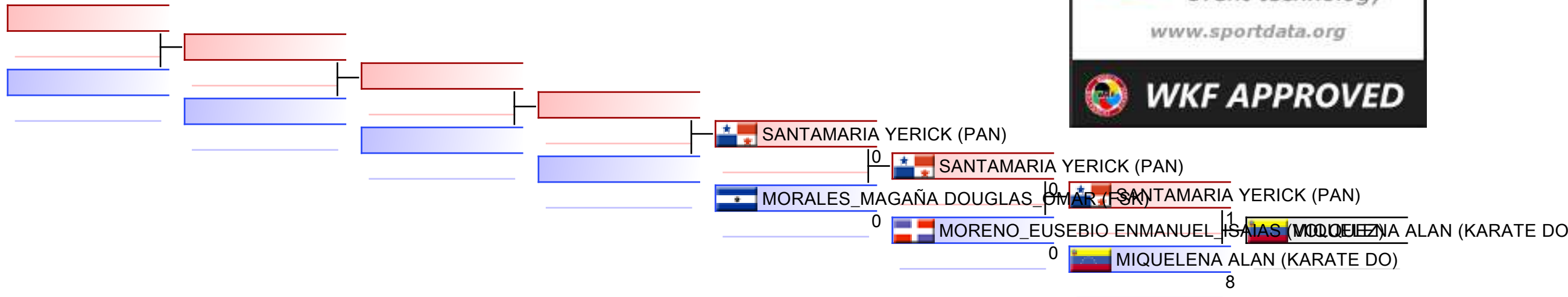

REPECHAGE: (1)

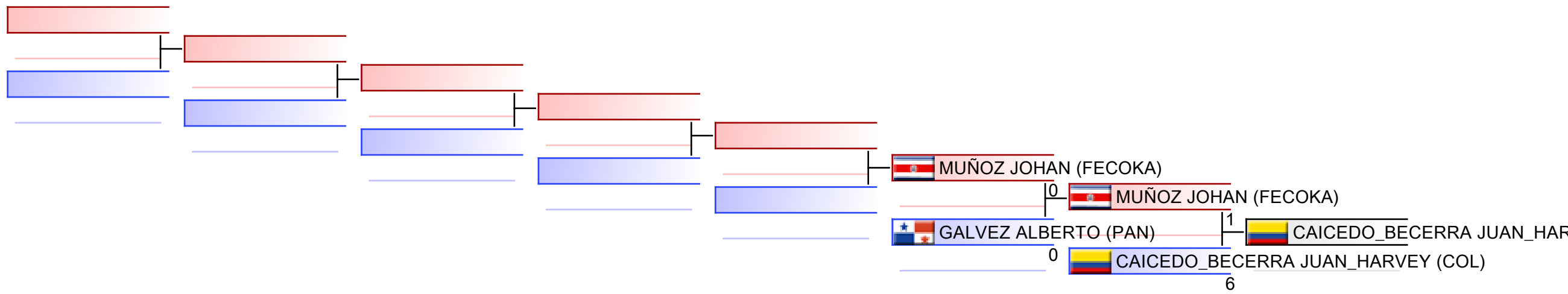

Referees:							
-----------	--	--	--	--	--	--	--

Male Kumite -75 kg

Campeonato Centroamericano y del Caribe de Karate 2023, Carretera Cocoyoc - Oaxtepec Km 2.5, Centro, 62738 Oaxtepec, MEX

2023-03-04

Tatami
1 14:20

Pool
1/1

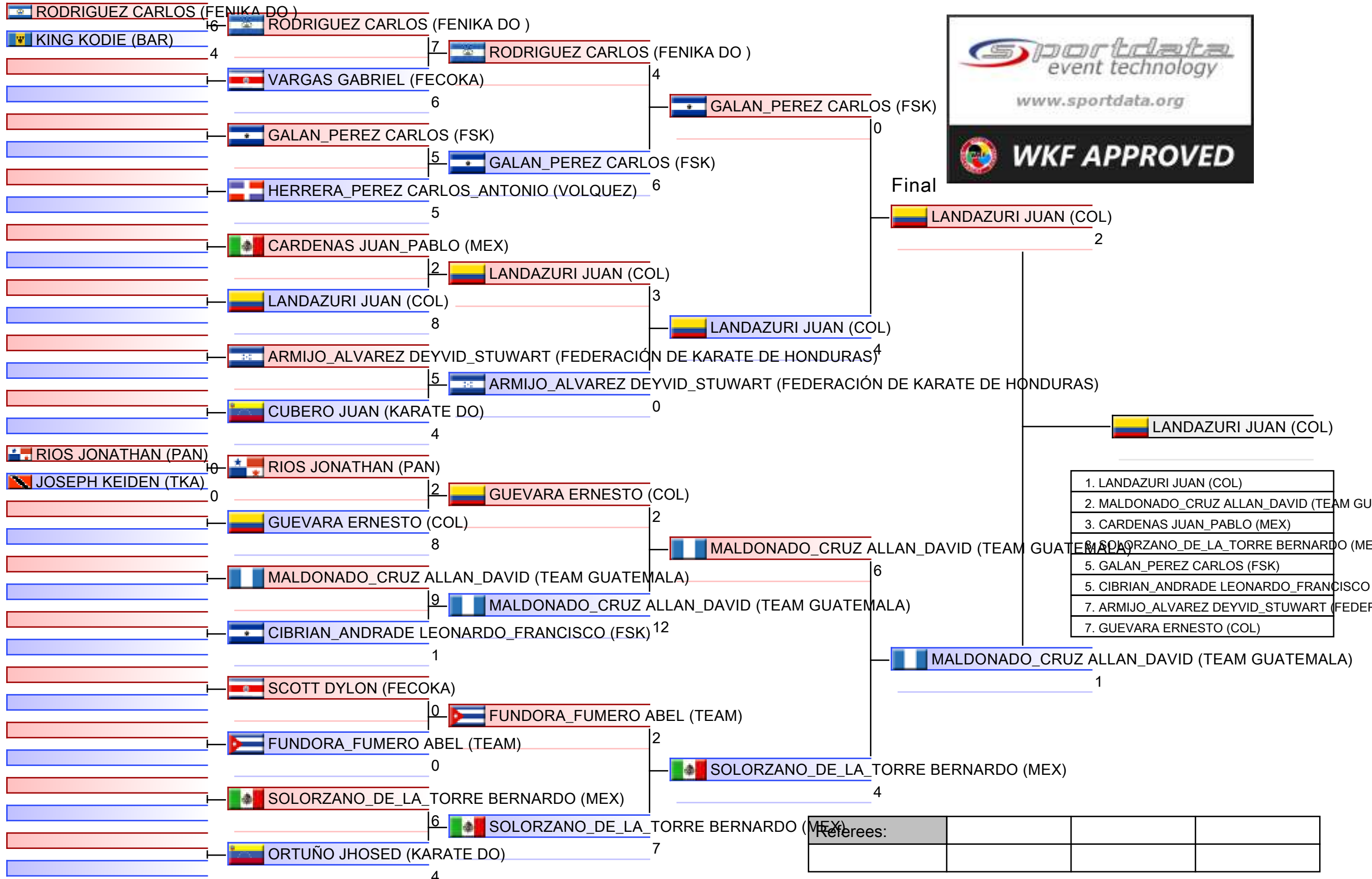

Male Kumite -75 kg

Campeonato Centroamericano y del Caribe de Karate 2023

2023-03-04

Tatami
1 15:55

Pool
1

(c)sportdata GmbH & Co KG 2000-2023 (2023-03-04 17:55) v 10.0.0 build 1 (2023-02-10) License: Online_Event_ID-6936_CampeonatoCentroamericanoydelCaribedeKarate2023 (expire 2023-03-18)

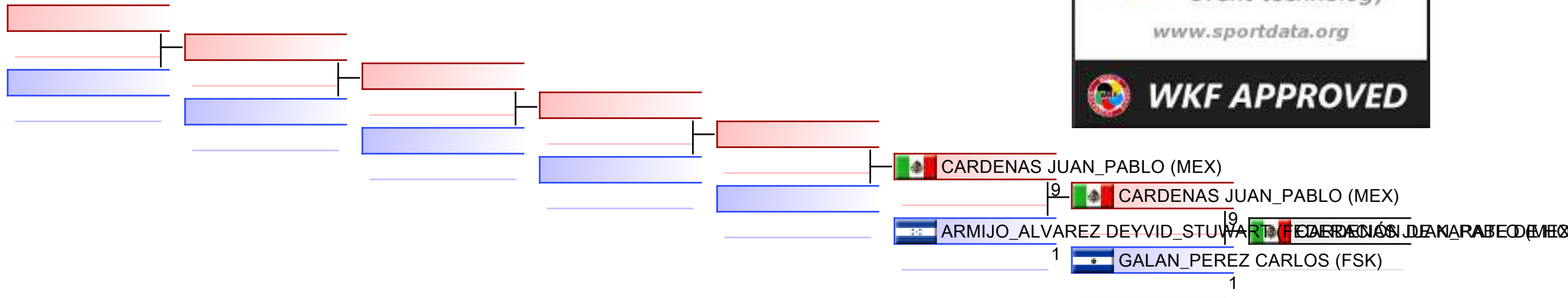

REPECHAGE: (1)

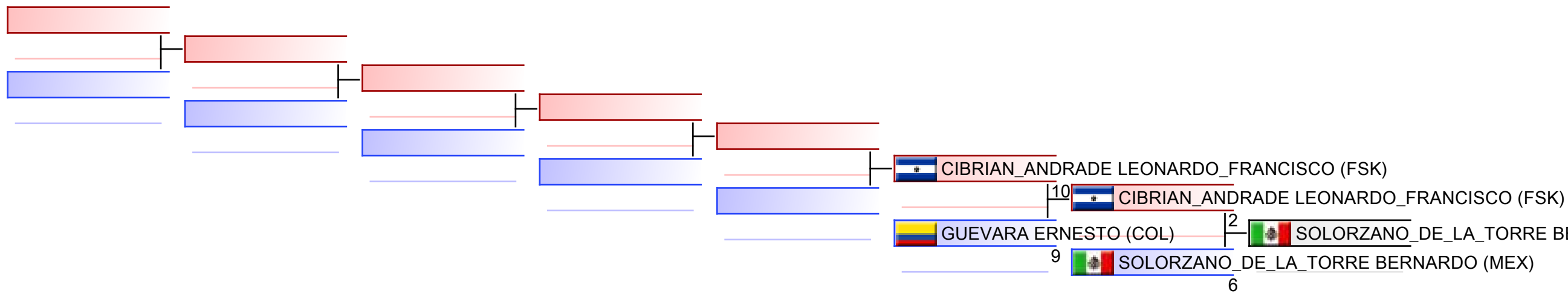

Referees:							
-----------	--	--	--	--	--	--	--

MALE KUMITE -84 KG

Campeonato Centroamericano y del Caribe de Karate 2023, Carretera Cocoyoc - Oaxtepec Km 2.5, Centro, 62738 Oaxtepec, MEX

2023-03-04

Tatami
3 15:45

Pool
1/1

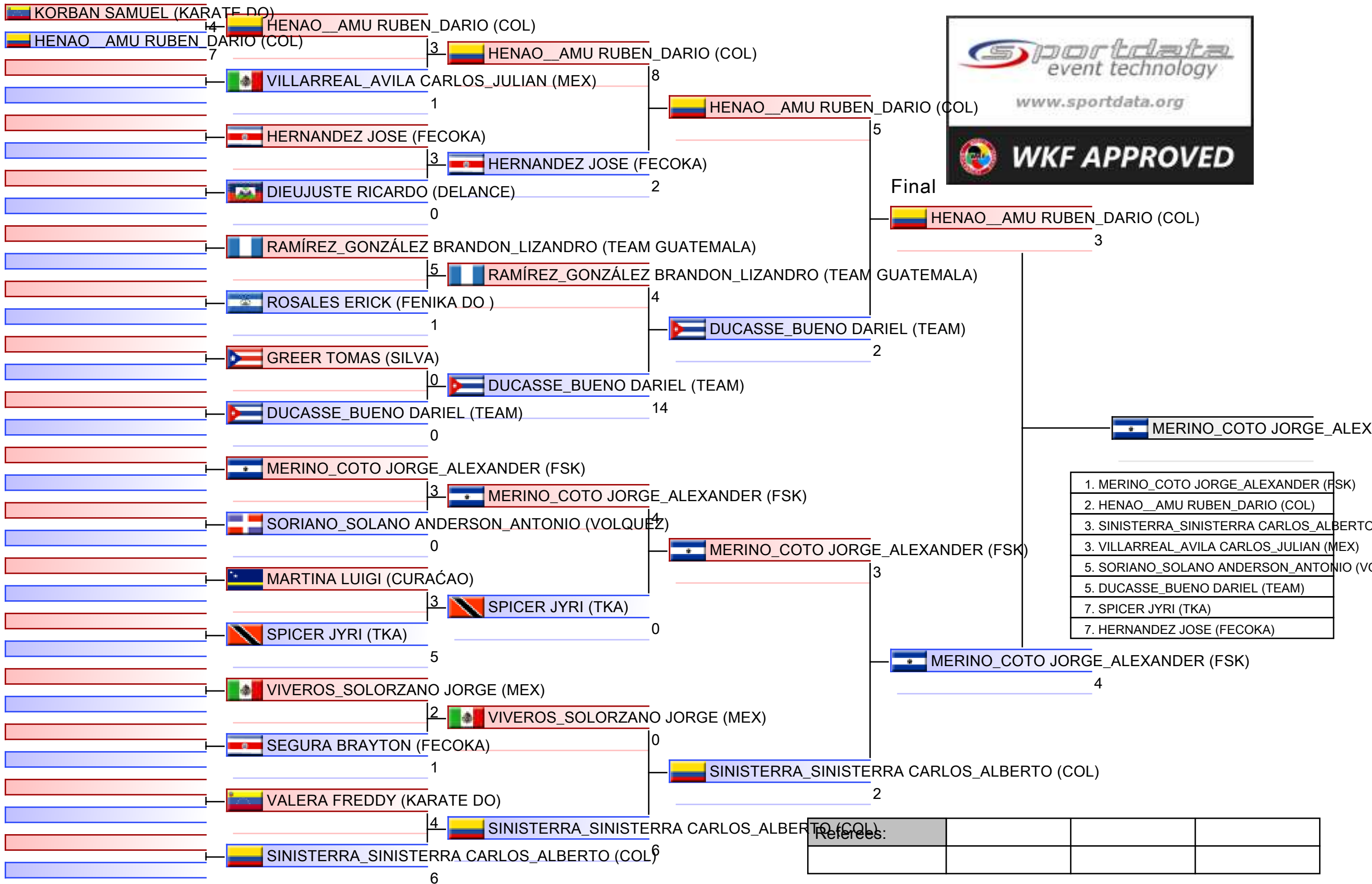

MALE KUMITE -84 KG

Campeonato Centroamericano y del Caribe de Karate 2023

2023-03-04

Tatami
3 17:15

Pool
1

(c)sportdata GmbH & Co KG 2000-2023 (2023-03-04 17:55) v 10.0.0 build 1 (2023-02-10) License: Online_Event_ID-6936_CampeonatoCentroamericanoydelCaribedeKarate2023 (expire 2023-03-18)

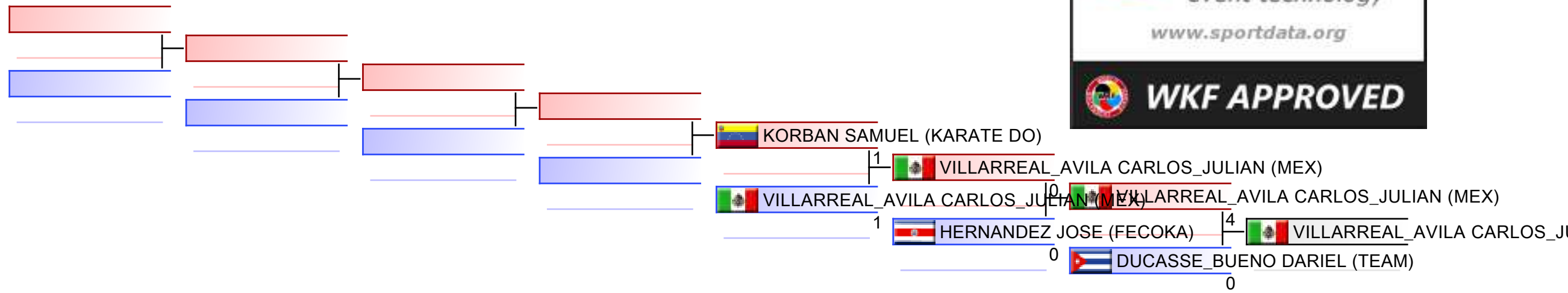

REPECHAGE: (1)

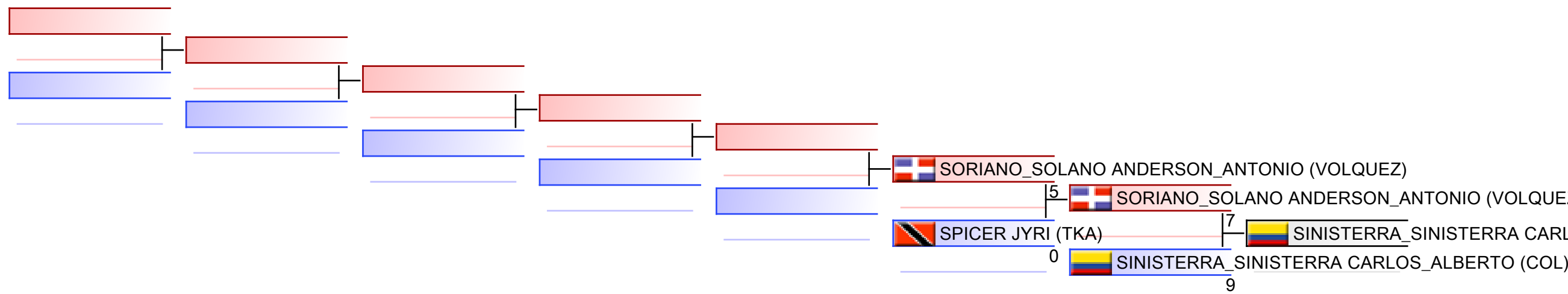

Referees:							
-----------	--	--	--	--	--	--	--

MALE KUMITE 84+ KG

Campeonato Centroamericano y del Caribe de Karate 2023, Carretera Cocoyoc - Oaxtepec Km 2.5, Centro, 62738 Oaxtepec, MEX

2023-03-04

Tatami
1 16:30

Pool
1/1



- | |
|--|
| 1. CASTILLO_PICHARDO ANEL (VOLQUEZ) |
| 2. MONTERO ADONI (VOLQUEZ) |
| 3. GUZMAN CRIXON (KARATE DO) |
| 3. BENAVIDES_PALOMINO PABLO_ANDRES (MEX) |
| 5. OPORTA MELVIN_RODRIGO (FENIKA DO) |
| 5. VARGAS_HERNANDEZ ALEXANDER (FECOKA) |
| 7. BASILIO_MUÑOZ ANGEL_YAEL (MEX) |
| 7. VRUTAAL EVERON (BONAIRE) |

Referees:			

MALE KUMITE 84+ KG

Campeonato Centroamericano y del Caribe de Karate 2023

2023-03-04

Tatami
1 17:55

Pool
1

(c)sportdata GmbH & Co KG 2000-2023 (2023-03-04 17:55) v 10.0.0 build 1 (2023-02-10) License: Online_Event_ID-6936_CampeonatoCentroamericanoydelCaribedeKarate2023 (expire 2023-03-18)

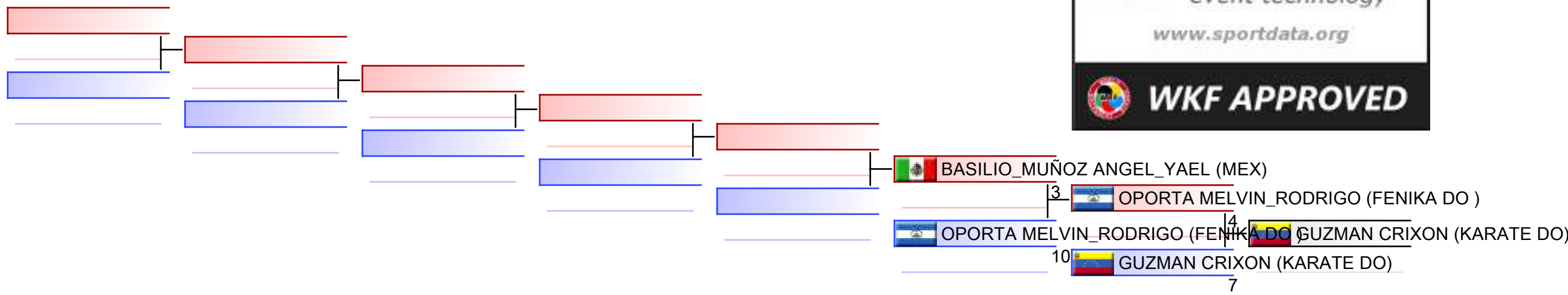

REPECHAGE: (1)

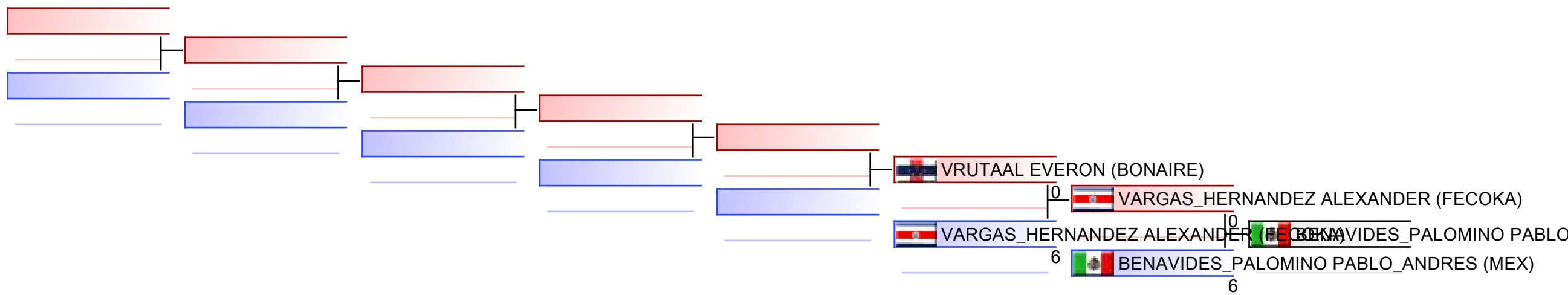

Referees:							
-----------	--	--	--	--	--	--	--

Male Kumite Team

Campeonato Centroamericano y del Caribe de Karate 2023, Carretera Cocoyoc - Oaxtepec Km 2.5, Centro, 62738 Oaxtepec, MEX

Tatami

Pool
1/1

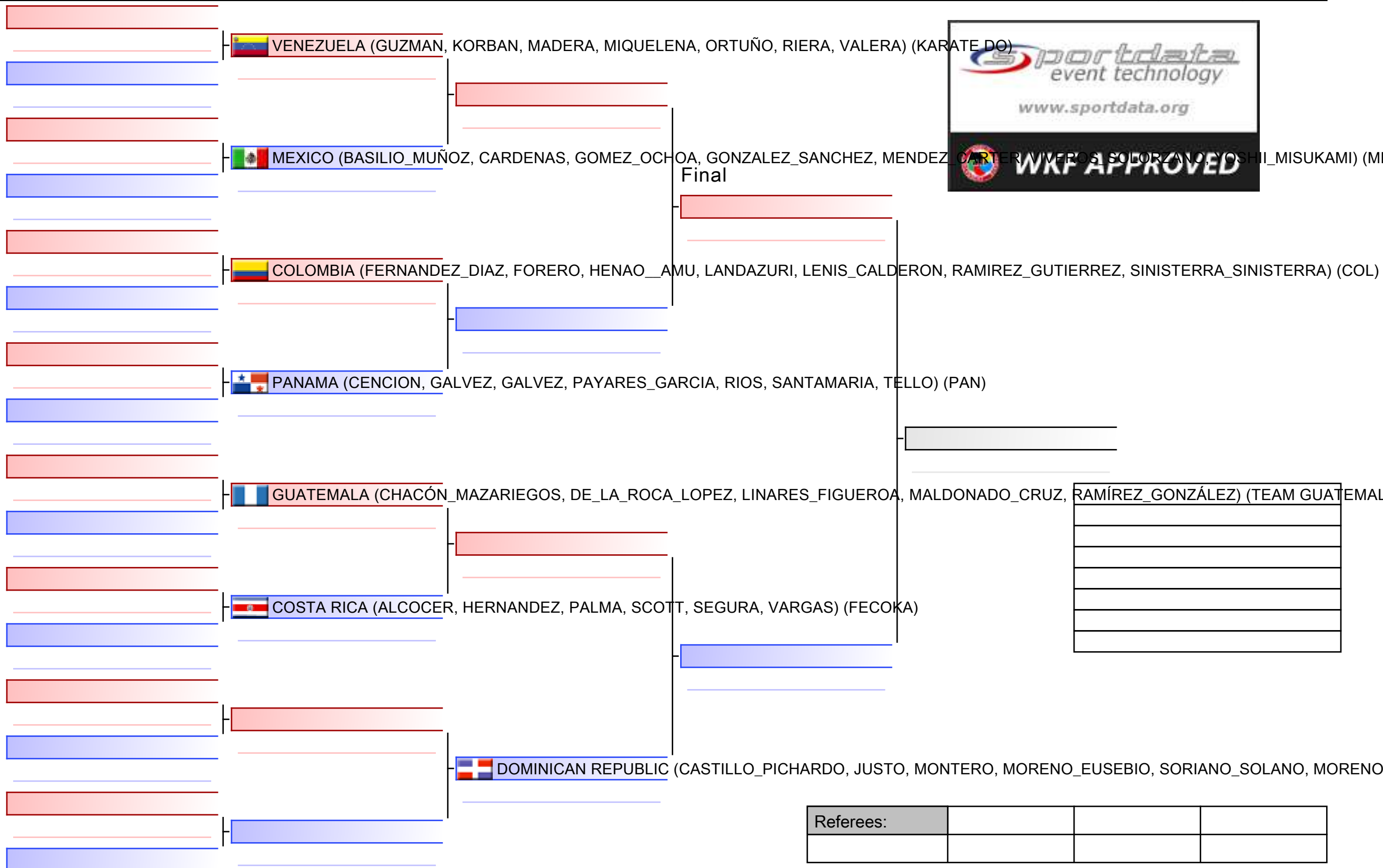

**Campeonato Centroamericano y del
Caribe de Karate 2023 - 2023-03-02**

U14 Kata Female

R1 G1/2 (5) Tatami 2 09:00(2023-03-02)

Competitors	Kata	1	2	3	4	5	6	7	TOTAL	Extra Total Rank
1 GUZMAN VERGARA BELEN (VOLQUEZ)	002 ANAN DAI	7.4	7.5	7.5	(7.8)	(6.6)			22.4	22.4 1
2 LOPEZ SASHA (FECOKA)	020 GOJUSHIHO DAI	(7.2)	7.3	(7.4)	7.4	7.3			22.0	22.0 2
3 CEVASCO BARRIENTOS LUCIANA VICTORIA (TEAM GUATEMALA)	006 BASSAI DAI	7.0	(7.1)	6.7	(6.0)	6.5			20.2	20.2 5
4 CARDOZA MARIA ANTONIA (COL)	020 GOJUSHIHO DAI	(7.4)	7.2	(6.9)	7.2	7.0			21.4	21.4 4
5 HERNANDEZ CAMACHO ELIAM SIMEI HERNANDEZ CAMACHO (MEX)	008 CHATANYARA KUSHANKU	(7.1)	(7.4)	7.3	7.1	7.4			21.8	21.8 3

R1 G2/2 (5) Tatami 2 09:20(2023-03-02)

Competitors	Kata	1	2	3	4	5	6	7	TOTAL	Extra Total Rank
1 FRIAS ROSARIO DESSIRE NIKOLE (PAN)	002 ANAN DAI	7.2	7.5	(7.7)	7.6	(6.4)			22.3	22.3 2
2 ONTIVEROS DURAN ANDREA ISABELLA (MEX)	008 CHATANYARA KUSHANKU	7.4	7.3	7.3	(7.5)	(7.1)			22.0	22.0 3
3 MOSQUERA RENATA (KARATE DO)	064 OHAN DAI	7.5	(7.7)	7.6	7.7	(7.2)			22.8	22.8 1
4 VASQUEZ AMY (FECOKA)	068 PAPUREN	7.2	(7.3)	7.0	7.3	(6.7)			21.5	21.5 4
5 ROJAS SERMENO MARIA FERNANDA (TEAM GUATEMALA)	006 BASSAI DAI	(6.6)	(7.5)	7.2	6.9	7.0			21.1	21.1 5

R2 Bronze Medal Match 1 Tatami 2 09:45(2023-03-02)

Competitors	Kata	1	2	3	4	5	6	7	TOTAL	Extra Total Rank
1 LOPEZ SASHA (FECOKA)	021 GOJUSHIHO SHO	(8.0)	(7.4)	7.7	7.4	7.5			22.6	22.6 2
2 ONTIVEROS DURAN ANDREA ISABELLA (MEX)	068 PAPUREN	(8.3)	7.5	7.6	7.6	(7.3)			22.7	22.7 1











R2 Bronze Medal Match 2 Tatami 2 09:55(2023-03-02)

Competitors	Kata	1	2	3	4	5	6	7	TOTAL	Extra Total Rank
1 HERNANDEZ CAMACHO ELIAM SIMEI HERNANDEZ CAMACHO (MEX)	098 UNSHU	6.8	(7.8)	7.1	7.6	(6.6)			21.5	21.5 2
2 FRIAS ROSARIO DESSIRE NIKOLE (PAN)	008 CHATANYARA KUSHANKU	(6.9)	(8.0)	7.5	7.7	7.2			22.4	22.4 1

R2 Gold Medal Match Tatami 2 10:05(2023-03-02)

Competitors	Kata	1	2	3	4	5	6	7	TOTAL	Extra Total Rank
1 GUZMAN VERGARA BELEN (VOLQUEZ)	001 ANAN	7.6	(8.0)	7.6	7.8	(7.4)			23.0	23.0 2
2 MOSQUERA RENATA (KARATE DO)	092 SUPARINPEI	(7.5)	(8.5)	7.7	7.7	7.6			23.0	23.0 1

Results

1	MOSQUERA RENATA	KARATE DO		VENEZUELA
2	GUZMAN VERGARA BELEN	VOLQUEZ		DOMINICAN REPUBLIC
3	ONTIVEROS DURAN ANDREA ISABELLA	MEXICO		MEXICO
3	FRIAS ROSARIO DESSIRE NIKOLE	PANAMA		PANAMA
5	LOPEZ SASHA	FEDERACION COSTARRICENSE DE KARATE		COSTA RICA
5	HERNANDEZ CAMACHO ELIAM SIMEI HERNANDEZ CAMACHO	MEXICO		MEXICO
7	CARDOZA MARIA ANTONIA	COLOMBIA		COLOMBIA
7	VASQUEZ AMY	FEDERACION COSTARRICENSE DE KARATE		COSTA RICA
9	CEVASCO BARRIENTOS LUCIANA VICTORIA	TEAM GUATEMALA		GUATEMALA
9	ROJAS SERMENO MARIA FERNANDA	TEAM GUATEMALA		GUATEMALA

**Campeonato Centroamericano y del
Caribe de Karate 2023 - 2023-03-02**

U14 Kata Male

R1 G1/2 (5) Tatami 1 09:00(2023-03-02)

Competitors	Kata	1	2	3	4	5	6	7	TOTAL	Extra Total Rank
1 VERA_BISONO EMIR (VOLQUEZ)	046 KOUSOUKUN SHO	7.1	(6.8)	7.2	(7.8)	7.5			21.8	21.8 2
2 RUZ LUIS (KARATE DO)	065 OYADOMARI NO PASSAI	(7.2)	7.4	7.5	(8.2)	7.8			22.7	22.7 1
3 ESCOBAR MAXIMO (FECOKA)	015 GANKAKU	(7.0)	7.1	7.0	7.0	(7.2)			21.1	21.1 5
4 QUINTERO_POBLANO GAEL_ERNESTO (MEX)	092 SUPARINPEI	7.3	7.0	7.1	(6.8)	(7.6)			21.4	21.4 3
5 CAMELO SAMUEL_ESTEBAN (COL)	021 GOJUSHIHO SHO	(7.2)	7.2	6.9	(6.7)	7.2			21.3	21.3 4

R1 G2/2 (5) Tatami 1 09:20(2023-03-02)

Competitors	Kata	1	2	3	4	5	6	7	TOTAL	Extra Total Rank
1 SEGURA SEBASTIAN (FECOKA)	078 SANSAI	7.2	7.3	(8.1)	(6.6)	6.7			21.2	21.2 4
2 GALMICHE_VEGA ANGEL_YERIK (MEX)	009 CHIBANA NO KUSHANKU	7.5	(7.4)	7.7	(7.9)	7.7			22.9	22.9 2
3 QUINTANA ENZO (KARATE DO)	099 UNSU	7.7	7.6	(7.3)	(8.1)	8.0			23.3	23.3 1
4 DURAN_FERNANDEZ GERARD (VOLQUEZ)	064 OHAN DAI	(7.4)	7.7	7.5	(7.9)	7.4			22.6	22.6 3
5 EVANS RASANDRE (TEAM VALY 2020)	047 KURURUNFA	7.3	(7.4)	6.7	6.9	(6.6)			20.9	20.9 5

R2 Bronze Medal Match 1 Tatami 1 09:45(2023-03-02)

Competitors	Kata	1	2	3	4	5	6	7	TOTAL	Extra Total Rank
1 VERA_BISONO EMIR (VOLQUEZ)	009 CHIBANA NO KUSHANKU	7.5	(6.8)	7.4	(7.6)	7.2			22.1	22.1 2
2 DURAN_FERNANDEZ GERARD (VOLQUEZ)	002 ANAN DAI	(8.0)	(7.2)	7.6	8.0	7.5			23.1	23.1 1







R2 Bronze Medal Match 2 Tatami 1 09:55(2023-03-02)

Competitors	Kata	1	2	3	4	5	6	7	TOTAL	Extra Total Rank
1 QUINTERO_POBLANO GAEL_ERNESTO (MEX)	068 PAPUREN	(7.1)	(8.0)	7.7	7.5	7.4			22.6	22.6 2
2 GALMICHE_VEGA ANGEL_YERIK (MEX)	008 CHATANYARA KUSHANKU	7.7	(8.2)	8.1	7.9	(7.6)			23.7	23.7 1

R2 Gold Medal Match Tatami 1 10:05(2023-03-02)

Competitors	Kata	1	2	3	4	5	6	7	TOTAL	Extra Total Rank
1 RUZ LUIS (KARATE DO)	064 OHAN DAI	7.8	(7.5)	7.8	7.7	(8.2)			23.3	23.3 2
2 QUINTANA ENZO (KARATE DO)	020 GOJUSHIHO DAI	7.9	7.8	(7.5)	7.9	(8.5)			23.6	23.6 1

Results

1	QUINTANA ENZO	KARATE DO		VENEZUELA
2	RUZ LUIS	KARATE DO		VENEZUELA
3	DURAN FERNANDEZ GERARD	VOLQUEZ		DOMINICAN REPUBLIC
3	GALMICHE VEGA ANGEL YERIK	MEXICO		MEXICO
5	VERA BISONO EMIR	VOLQUEZ		DOMINICAN REPUBLIC
5	QUINTERO POBLANO GAEL ERNESTO	MEXICO		MEXICO
7	CAMELO SAMUEL ESTEBAN	COLOMBIA		COLOMBIA
7	SEGURA SEBASTIAN	FEDERACION COSTARRICENSE DE KARATE		COSTA RICA
9	ESCOBAR MAXIMO	FEDERACION COSTARRICENSE DE KARATE		COSTA RICA
9	EVANS RASANDRE	TEAM VALY 2020		JAMAICA

U14 KUMITE FEMALE -42 KG

Campeonato Centroamericano y del Caribe de Karate 2023, Carretera Cocoyoc - Oaxtepec Km 2.5, Centro, 62738 Oaxtepec, MEX

2023-03-02

Tatami
1 11:00

Pool
1/1

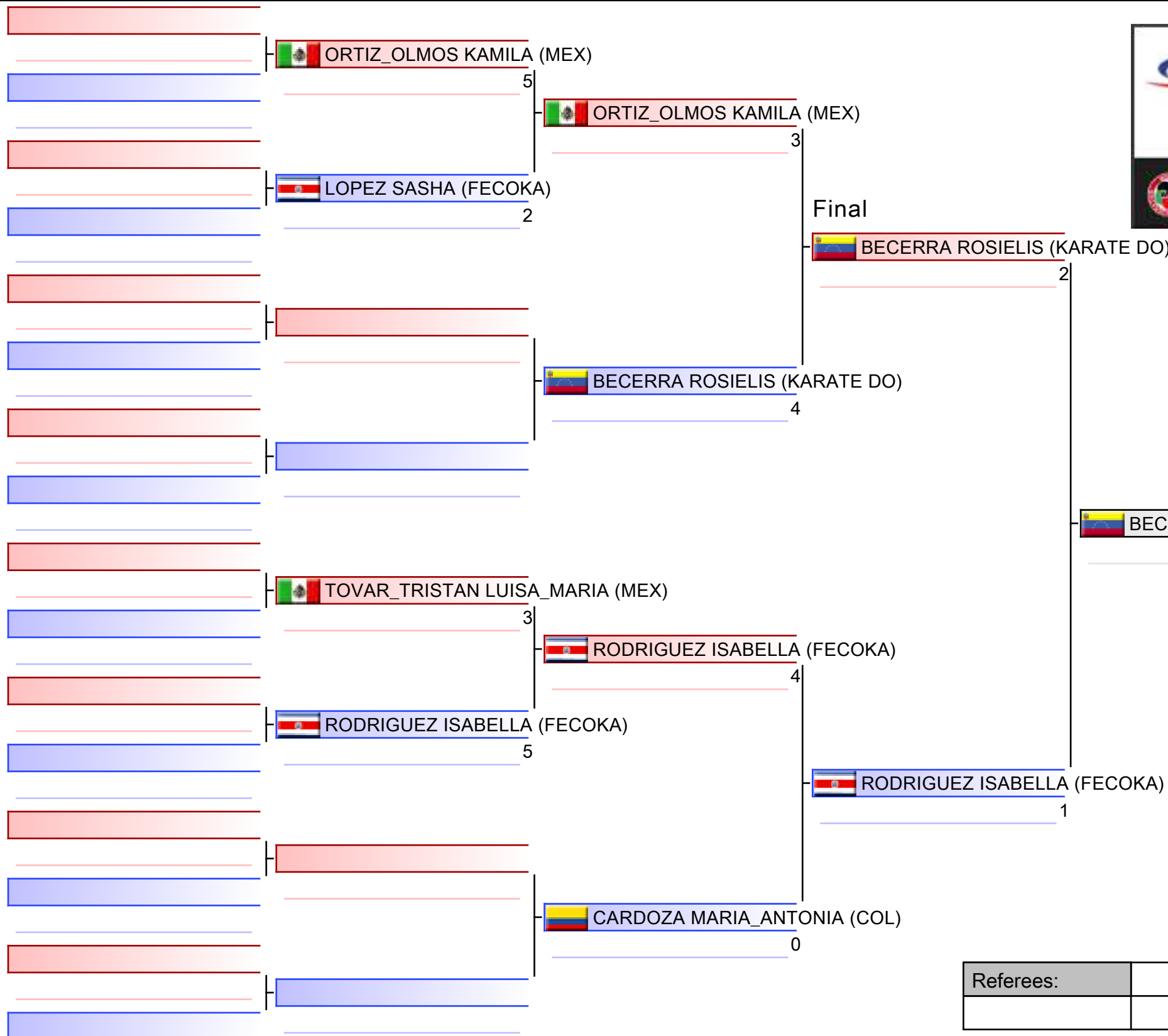

1. BECERRA ROSIELIS (KARATE DO)
2. RODRIGUEZ ISABELLA (FECOKA)
3. ORTIZ_OLMOS KAMILA (MEX)
3. CARDOZA MARIA_ANTONIA (COL)
5. TOVAR_TRISTAN LUISA_MARIA (MEX)

Referees:			

U14 KUMITE FEMALE -42 KG

Campeonato Centroamericano y del Caribe de Karate 2023

2023-03-02

Tatami
1 11:15

Pool
1

(c)sportdata GmbH & Co KG 2000-2023 (2023-03-04 17:55) v 10.0.0 build 1 (2023-02-10) License: Online_Event_ID-6936_CampeonatoCentroamericanoydelCaribedeKarate2023 (expire 2023-03-18)

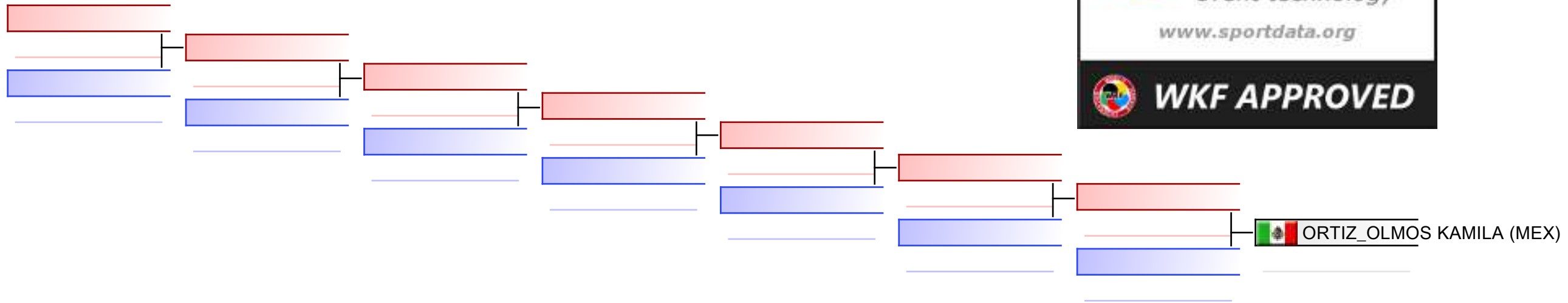

REPECHAGE: (1)

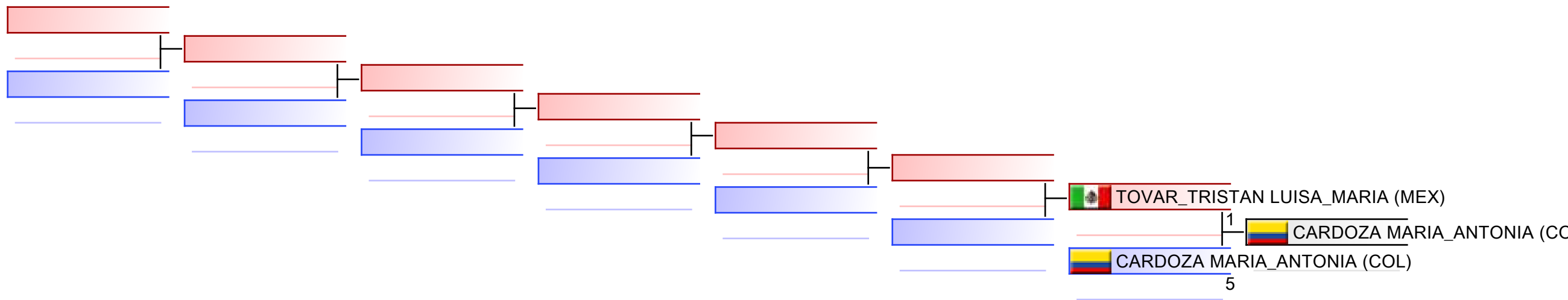

Referees:							
-----------	--	--	--	--	--	--	--

U14 KUMITE FEMALE -47 KG

Campeonato Centroamericano y del Caribe de Karate 2023, Carretera Cocoyoc - Oaxtepec Km 2.5, Centro, 62738 Oaxtepec, MEX

2023-03-02

Tatami
2 11:00

Pool
1/1

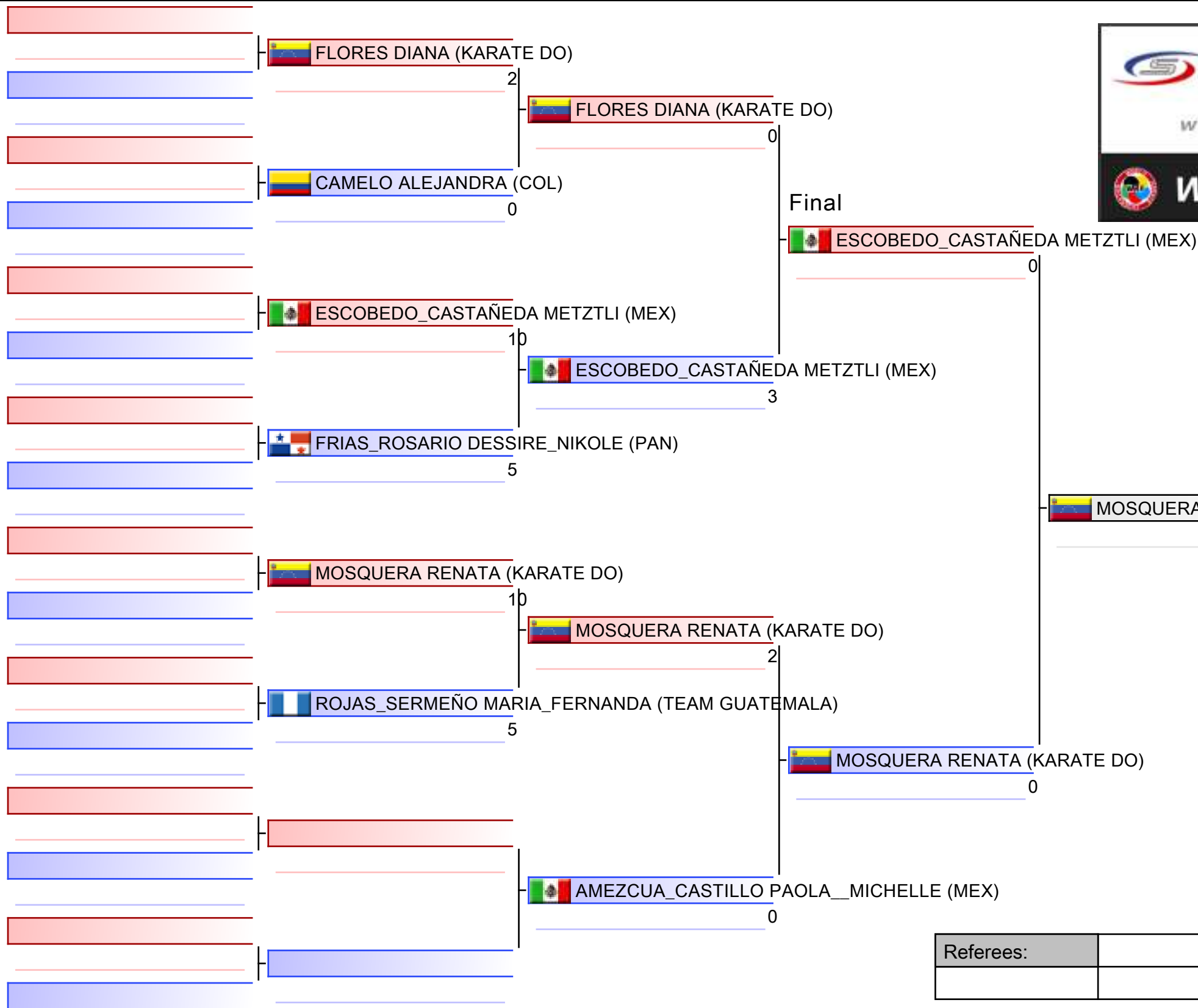

1. MOSQUERA RENATA (KARATE DO)
2. ESCOBEDO_CASTAÑEDA METZTLI (MEX)
3. FLORES DIANA (KARATE DO)
3. ROJAS_SERMEÑO MARIA_FERNANDA (TEAM GUATEMALA)
5. FRIAS_ROSARIO DESSIRE_NIKOLE (PAN)
5. AMEZCUA_CASTILLO PAOLA_MICHELLE (MEX)

Referees:			

U14 KUMITE FEMALE -47 KG

Campeonato Centroamericano y del Caribe de Karate 2023

2023-03-02

Tatami
2 11:20

Pool
1

(c)sportdata GmbH & Co KG 2000-2023 (2023-03-04 17:55) v 10.0.0 build 1 (2023-02-10) License: Online_Event_ID-6936_CampeonatoCentroamericanoydelCaribedeKarate2023 (expire 2023-03-18)

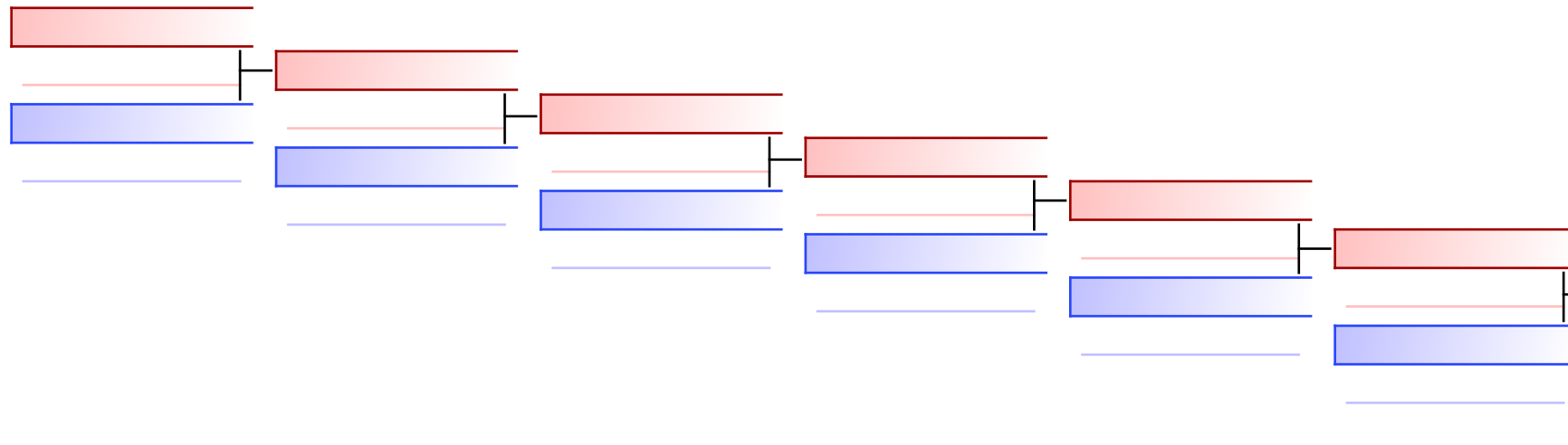

FRIAS_ROSARIO DESSIRE_NIKOLE (PAN)
 0
FLORES DIANA (KARATE DO)
 2

REPECHAGE: (1)

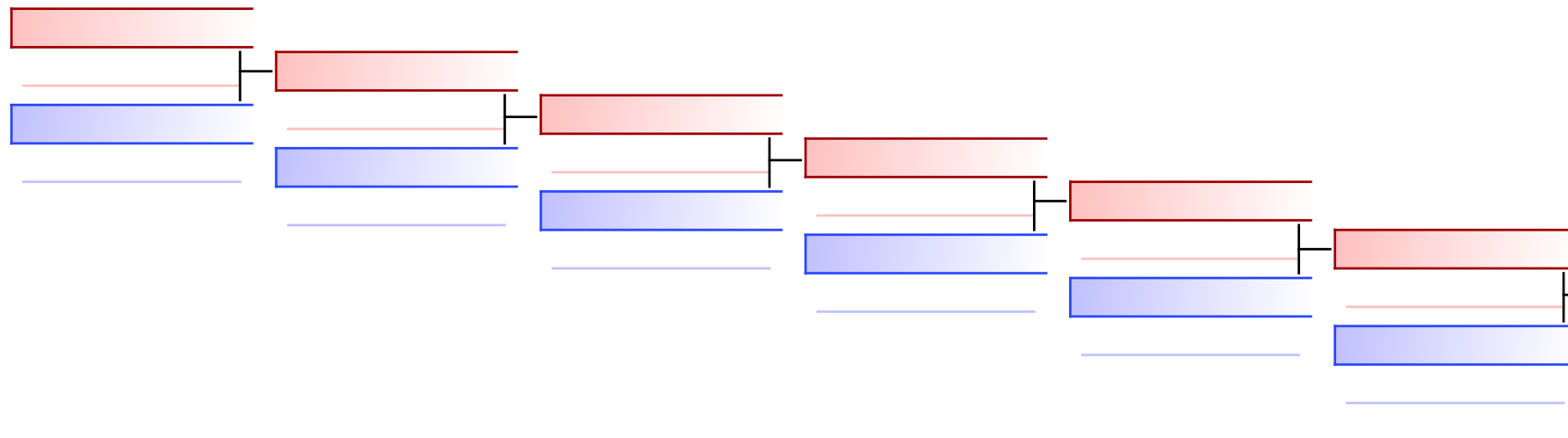

ROJAS_SERMEÑO MARIA_FERNANDA (TEAM GUATEMALA)
 5
AMEZCUA_CASTILLO PAOLA_MICHELLE (MEX)
 1

Referees:							
-----------	--	--	--	--	--	--	--

U14 KUMITE FEMALE -52 KG

Campeonato Centroamericano y del Caribe de Karate 2023, Carretera Cocoyoc - Oaxtepec Km 2.5, Centro, 62738 Oaxtepec, MEX

2023-03-02

Tatami
1 11:35

Pool
1/1

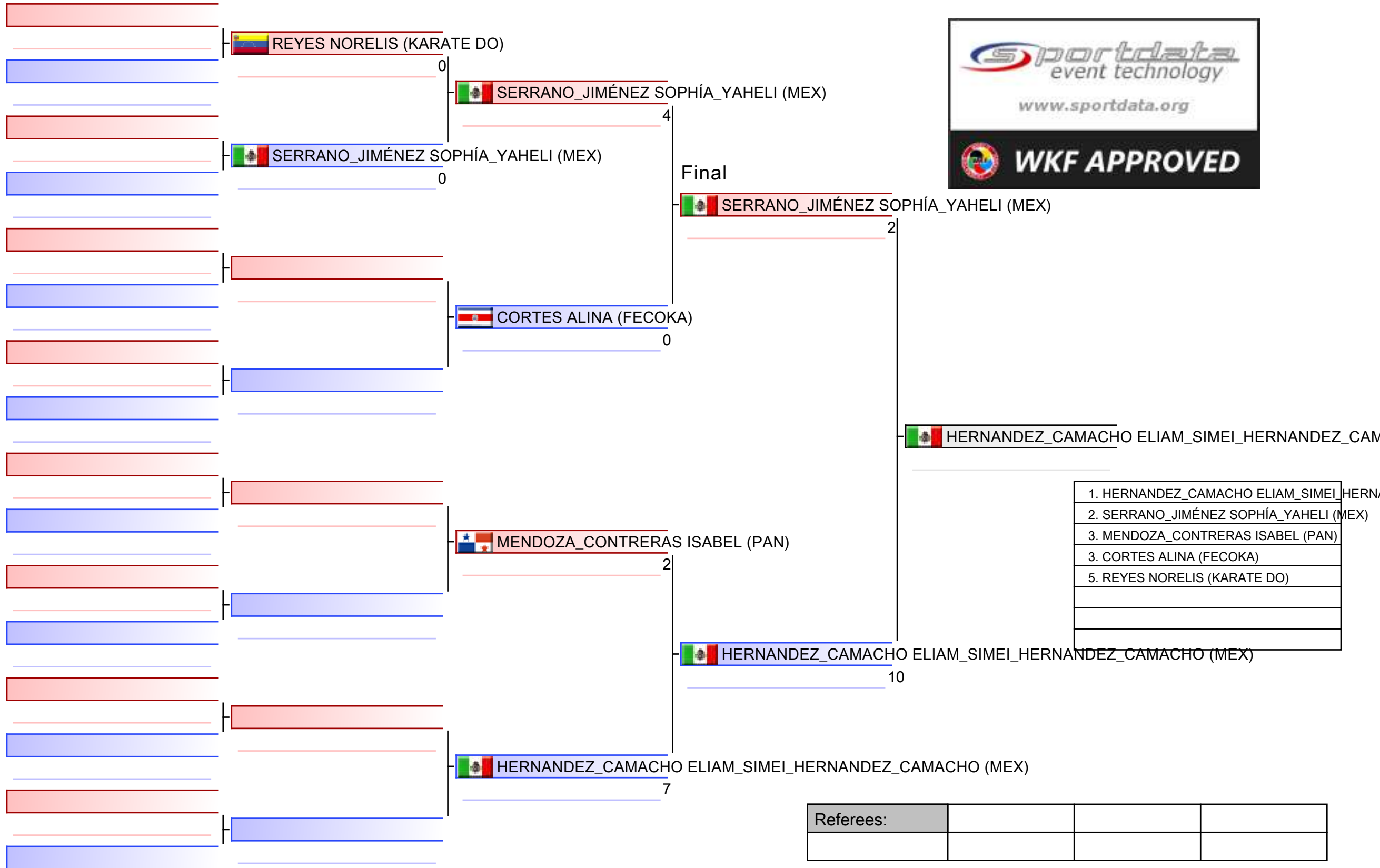

U14 KUMITE FEMALE -52 KG

Campeonato Centroamericano y del Caribe de Karate 2023

2023-03-02

Tatami
1 11:50

Pool
1

(c)sportdata GmbH & Co KG 2000-2023 (2023-03-04 17:55) v 10.0.0 build 1 (2023-02-10) License: Online_Event_ID-6936_CampeonatoCentroamericanoydelCaribedeKarate2023 (expire 2023-03-18)

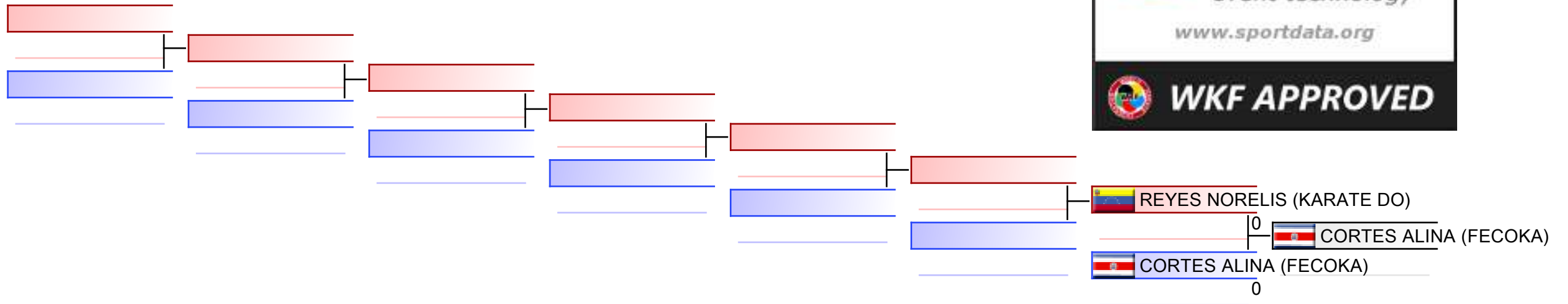

REPECHAGE: (1)

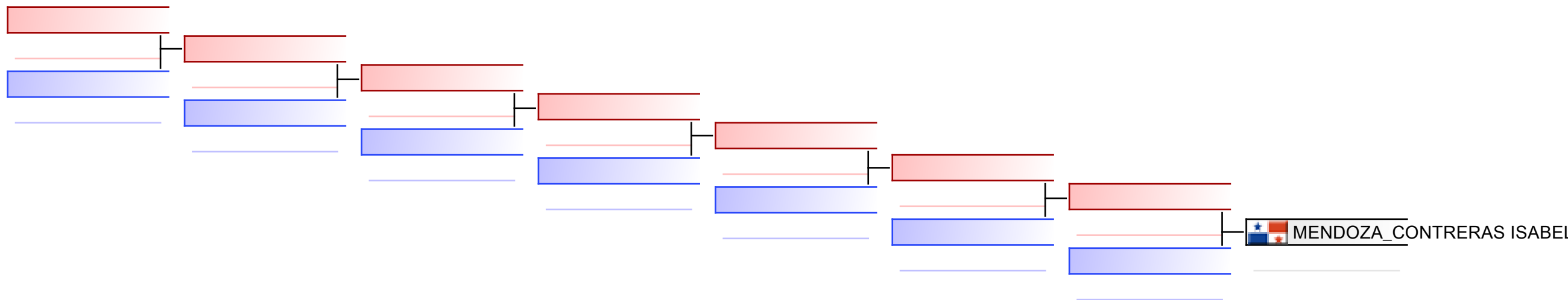

Referees:							
-----------	--	--	--	--	--	--	--

U14 KUMITE FEMALE 52+ KG

Campeonato Centroamericano y del Caribe de Karate 2023, Carretera Cocoyoc - Oaxtepec Km 2.5, Centro, 62738 Oaxtepec, MEX

2023-03-02

Tatami
2 11:40

Pool
1/1

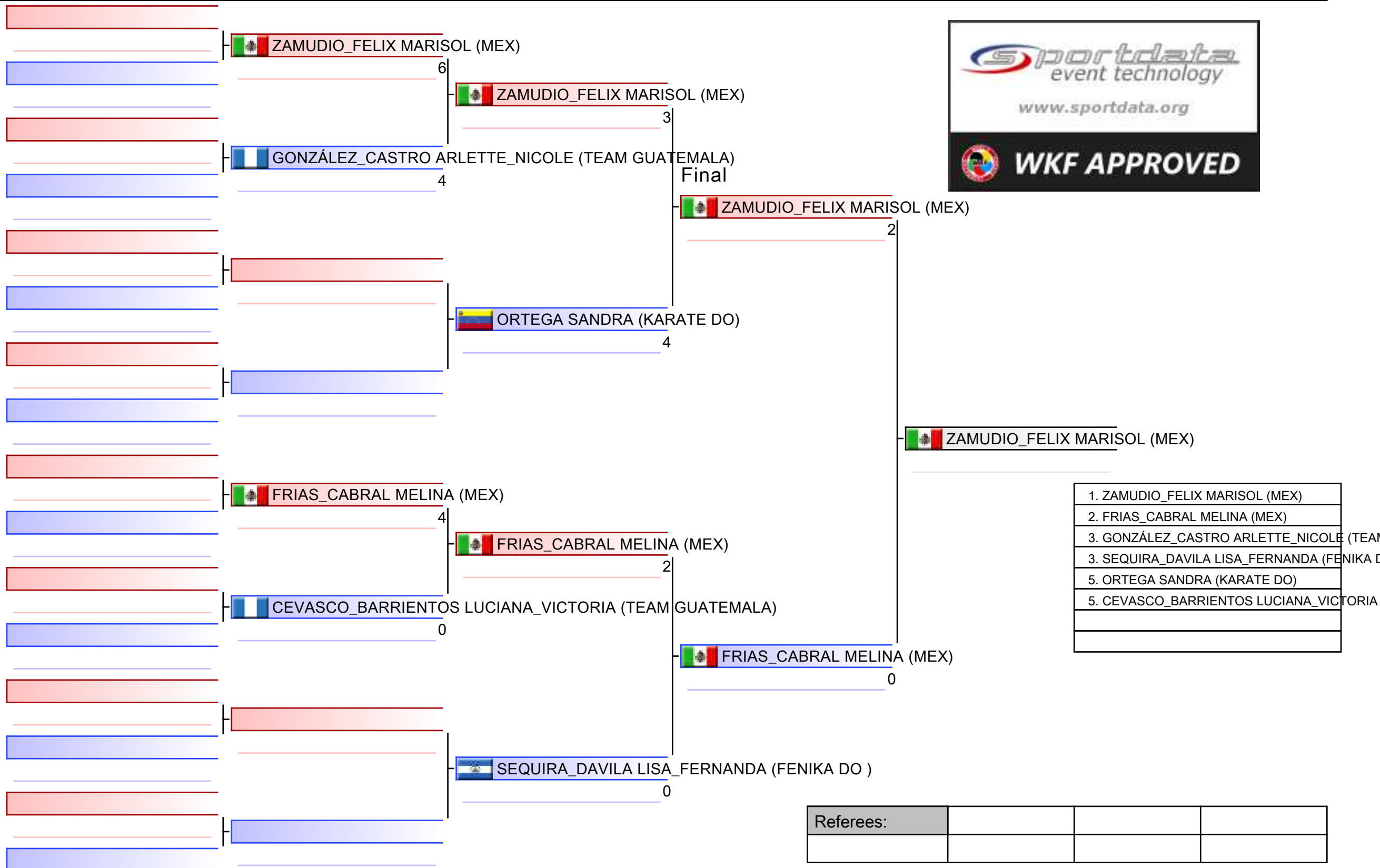

1. ZAMUDIO_FELIX MARISOL (MEX)
2. FRIAS_CABRAL MELINA (MEX)
3. GONZÁLEZ_CASTRO ARLETTE_NICOLE (TEAM GUATEMALA)
3. SEQUIRA_DAVILA LISA_FERNANDA (FENIKA DO)
5. ORTEGA SANDRA (KARATE DO)
5. CEVASCO_BARRIENTOS LUCIANA_VICTORIA (TEAM GUATEMALA)

Referees:			

U14 KUMITE FEMALE 52+ KG

Campeonato Centroamericano y del Caribe de Karate 2023



2023-03-02

Tatami
2 11:55

Pool
1

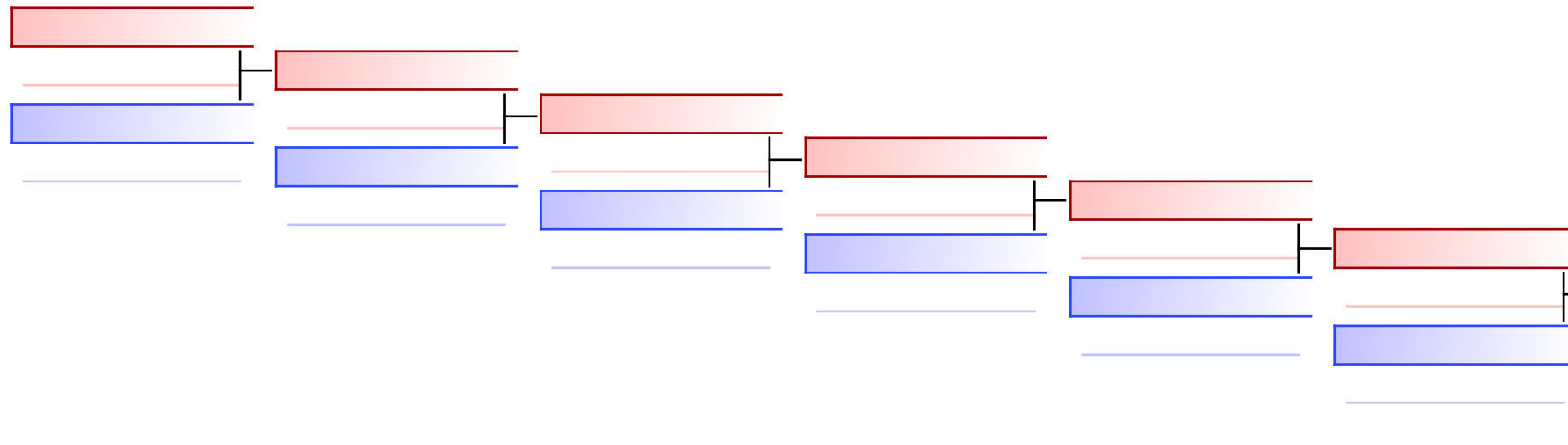

(c)sportdata GmbH & Co KG 2000-2023 (2023-03-04 17:55) v 10.0.0 build 1 (2023-02-10) License: Online_Event_ID-6936_CampeonatoCentroamericanoydelCaribedeKarate2023 (expire 2023-03-18)

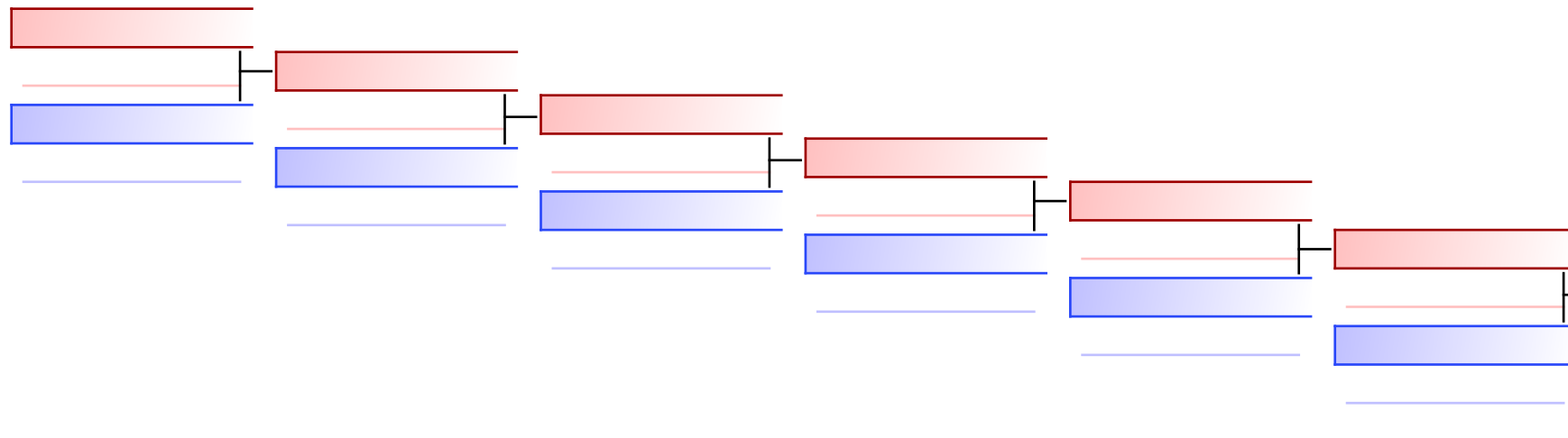

 GONZÁLEZ_CASTRO ARLETTE_NICOLE (TEAM GUA)
4
 GONZÁLEZ_CASTRO ARLETTE_
 ORTEGA SANDRA (KARATE DO)
3

REPECHAGE: (1)



 CEVASCO_BARRIENTOS LUCIANA_VICTORIA (TEAM GUA)
3
 SEQUIRA_DAVILA LISA_FERNAN
 SEQUIRA_DAVILA LISA_FERNANDA (FENIKA DO)
4

Referees:							
-----------	--	--	--	--	--	--	--

U14 KUMITE MALE -40 KG

Campeonato Centroamericano y del Caribe de Karate 2023, Carretera Cocoyoc - Oaxtepec Km 2.5, Centro, 62738 Oaxtepec, MEX

2023-03-02

Tatami
3 11:00

Pool
1/1

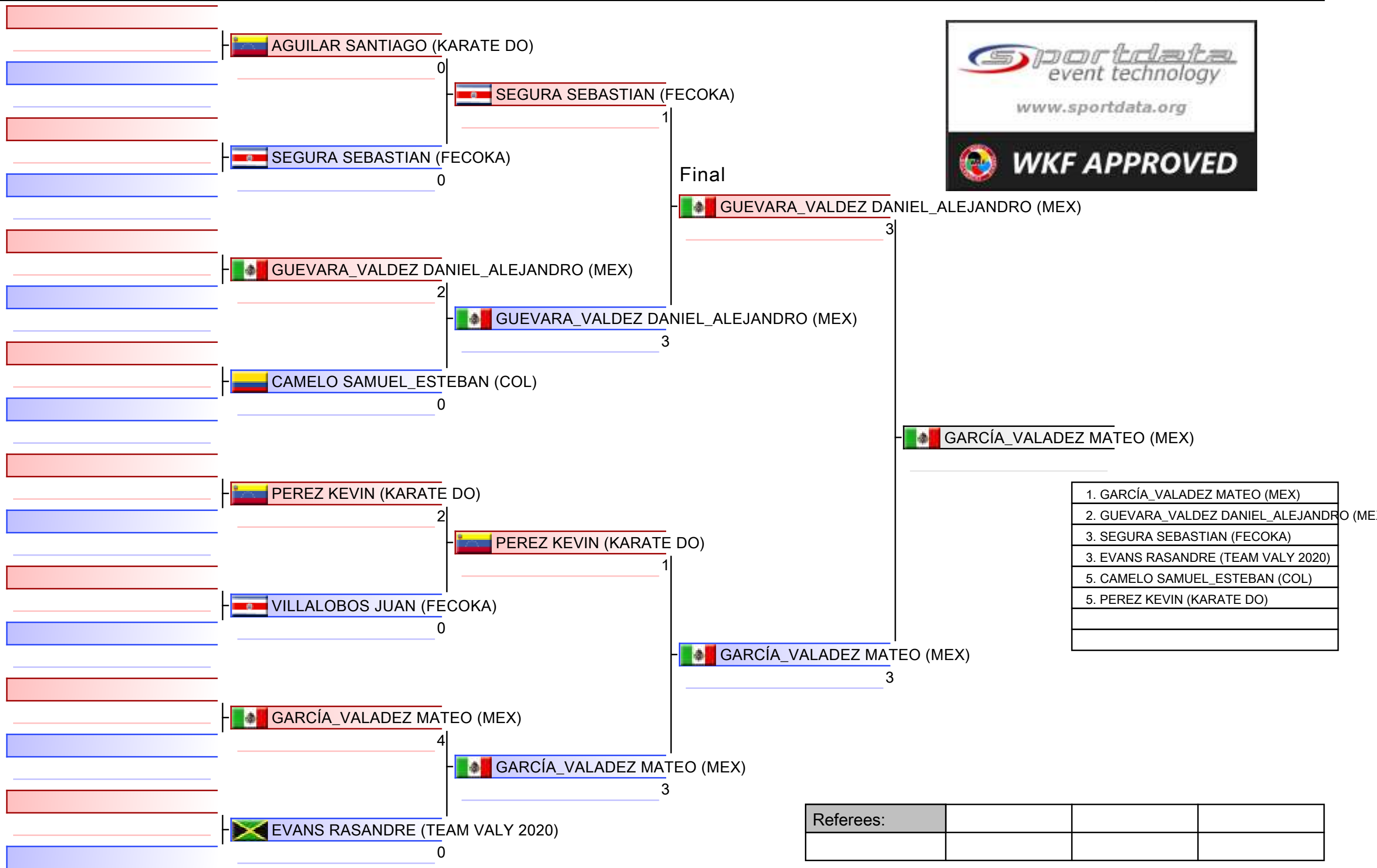

U14 KUMITE MALE -40 KG

Campeonato Centroamericano y del Caribe de Karate 2023

2023-03-02

Tatami
3 11:25

Pool
1

(c)sportdata GmbH & Co KG 2000-2023 (2023-03-04 17:55) v 10.0.0 build 1 (2023-02-10) License: Online_Event_ID-6936_CampeonatoCentroamericanoydelCaribedeKarate2023 (expire 2023-03-18)

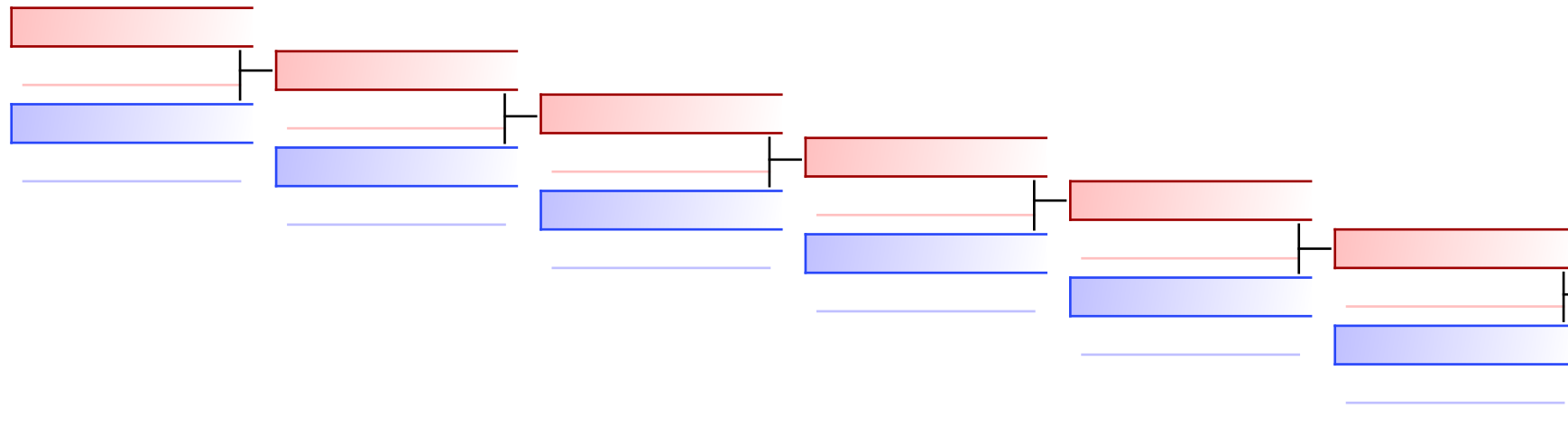

CAMELO SAMUEL_ESTEBAN (COL)
2
 SEGURA SEBASTIAN (FECOKA)
2

REPECHAGE: (1)

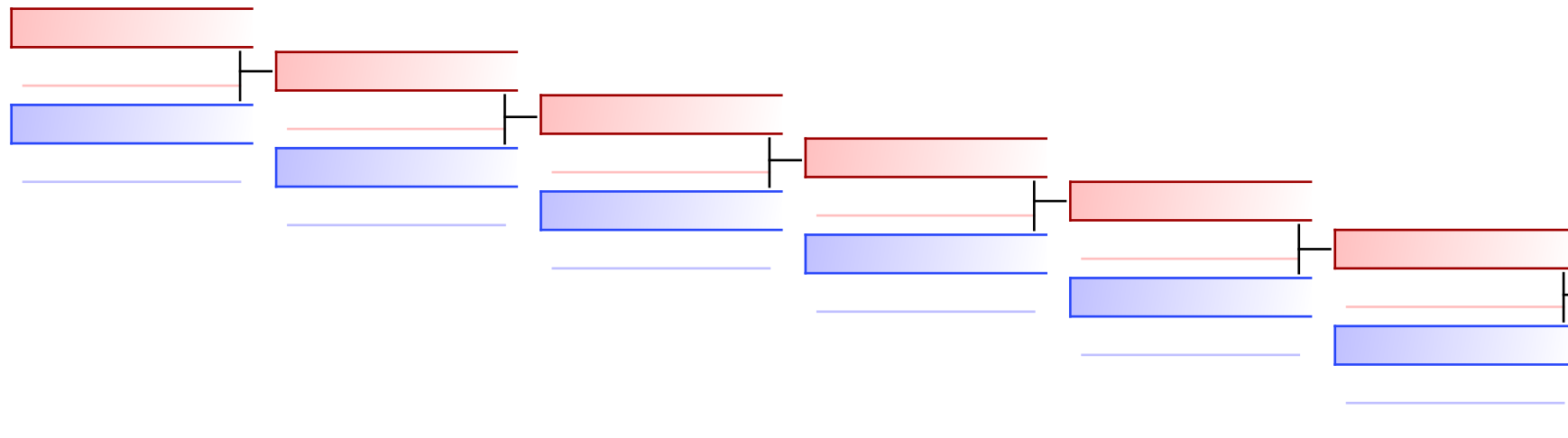

EVANS RASANDRE (TEAM VALY 2020)
8
 PEREZ KEVIN (KARATE DO)
0

Referees:							
-----------	--	--	--	--	--	--	--

U14 KUMITE MALE -45 KG

Campeonato Centroamericano y del Caribe de Karate 2023, Carretera Cocoyoc - Oaxtepec Km 2.5, Centro, 62738 Oaxtepec, MEX

2023-03-02

Tatami
4 11:00

Pool
1/1

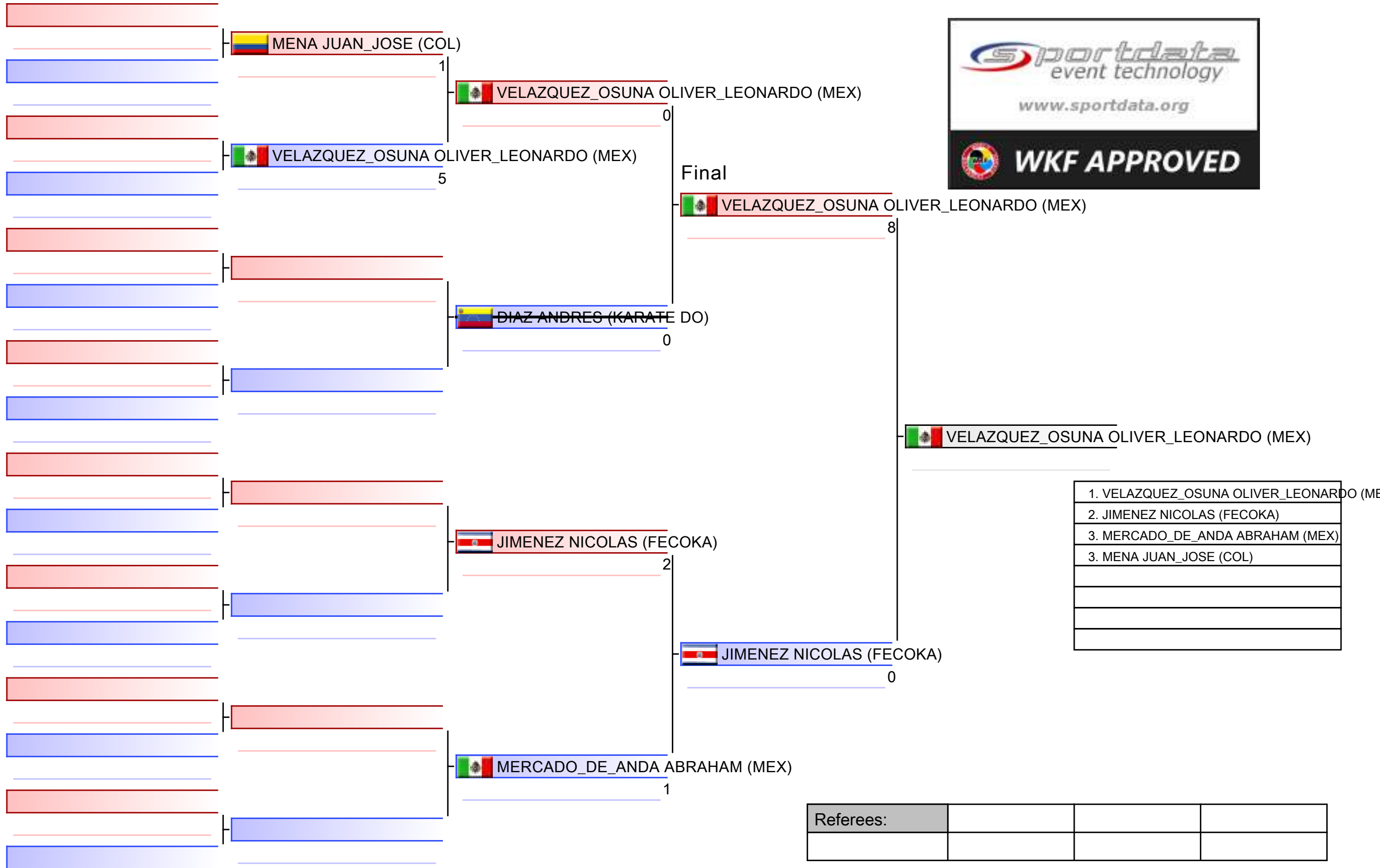

U14 KUMITE MALE -45 KG

Campeonato Centroamericano y del Caribe de Karate 2023

2023-03-02

Tatami
4 11:15

Pool
1

(c)sportdata GmbH & Co KG 2000-2023 (2023-03-04 17:55) v 10.0.0 build 1 (2023-02-10) License: Online_Event_ID-6936_CampeonatoCentroamericanoydelCaribedeKarate2023 (expire 2023-03-18)

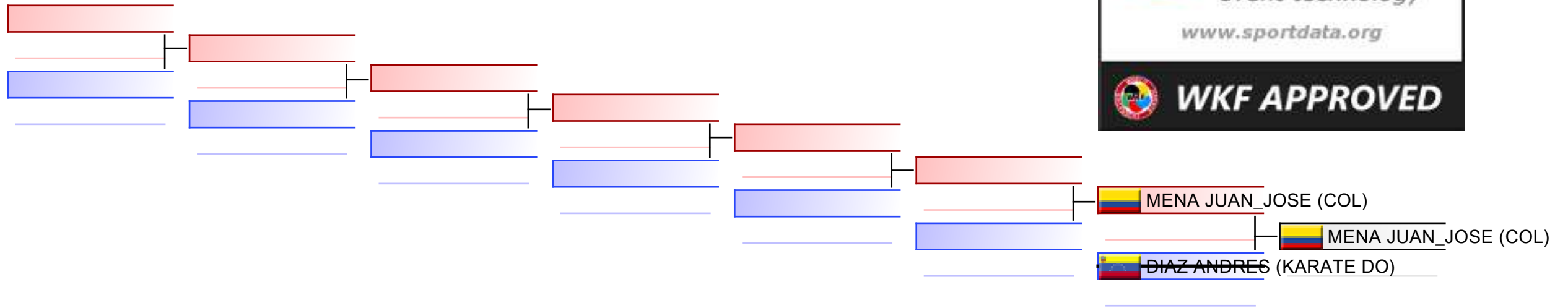

REPECHAGE: (1)

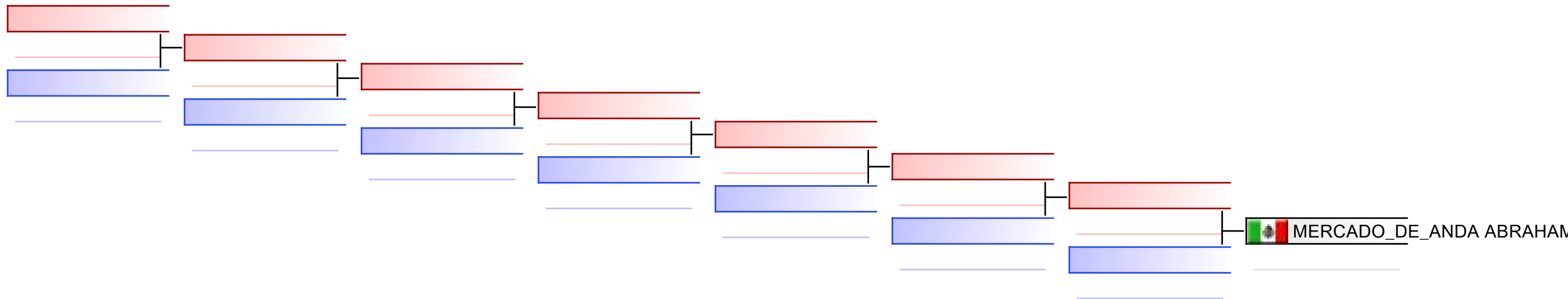

Referees:							
-----------	--	--	--	--	--	--	--

U14 KUMITE MALE -50 KG

Campeonato Centroamericano y del Caribe de Karate 2023, Carretera Cocoyoc - Oaxtepec Km 2.5, Centro, 62738 Oaxtepec, MEX

2023-03-02

Tatami
3 11:45

Pool
1/1

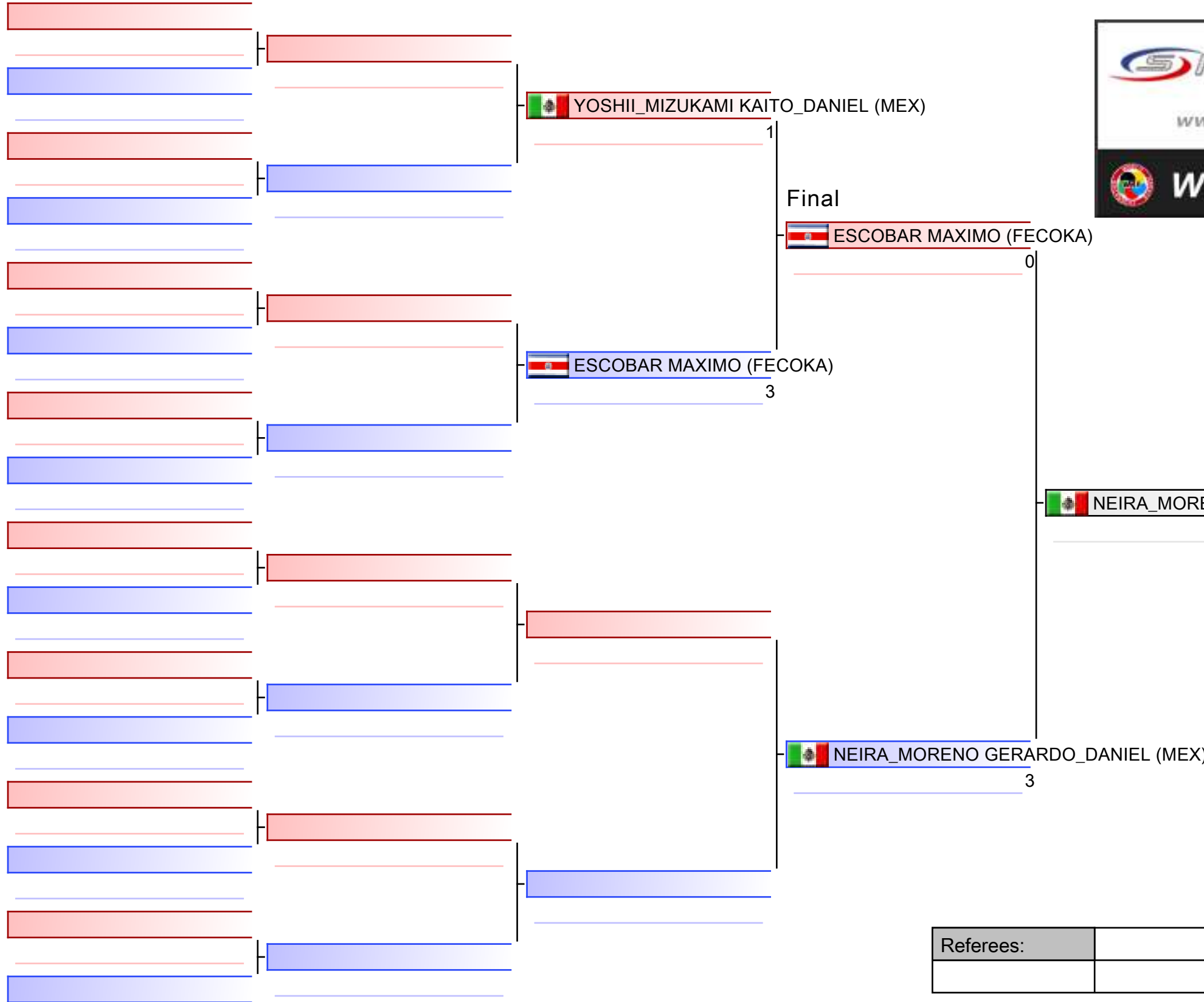

- | |
|---------------------------------------|
| 1. NEIRA_MORENO GERARDO_DANIEL (MEX) |
| 2. ESCOBAR MAXIMO (FECOKA) |
| 3. YOSHII_MIZUKAMI KAITO_DANIEL (MEX) |
| |
| |
| |
| |

Referees:			

U14 KUMITE MALE -50 KG

Campeonato Centroamericano y del Caribe de Karate 2023

Tatami

Pool
1

(c)sportdata GmbH & Co KG 2000-2023 (2023-03-04 17:55) v 10.0.0 build 1 (2023-02-10) License: Online_Event_ID-6936_CampeonatoCentroamericanoydelCaribedeKarate2023 (expire 2023-03-18)

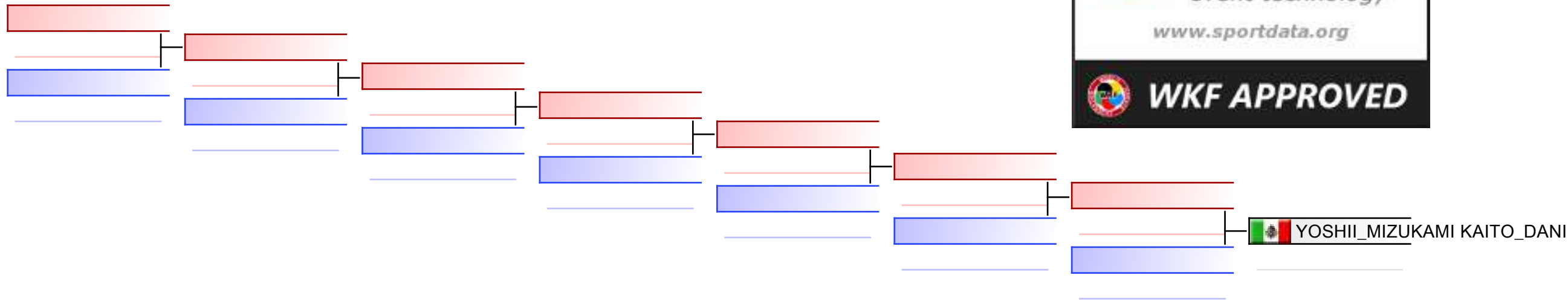

REPECHAGE: (1)

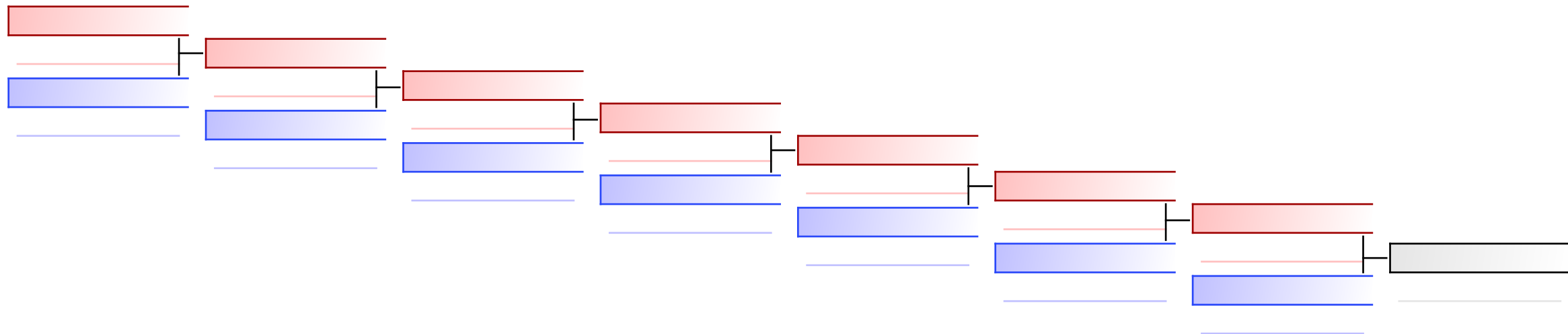

Referees:							
-----------	--	--	--	--	--	--	--

U14 KUMITE MALE -55 KG

Campeonato Centroamericano y del Caribe de Karate 2023, Carretera Cocoyoc - Oaxtepec Km 2.5, Centro, 62738 Oaxtepec, MEX

2023-03-02

Tatami
4 11:35

Pool
1/1

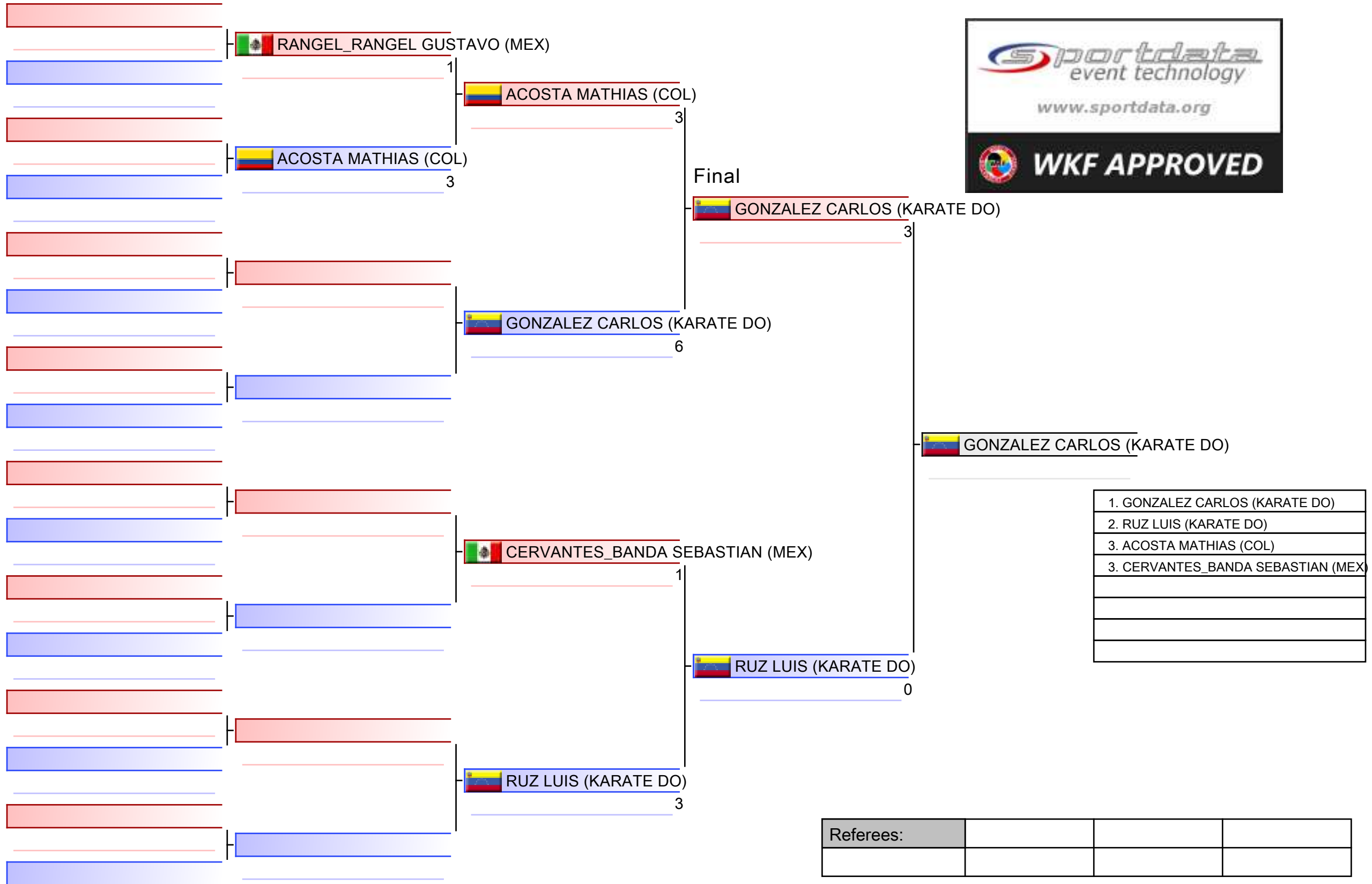

U14 KUMITE MALE -55 KG

Campeonato Centroamericano y del Caribe de Karate 2023

2023-03-02

Tatami
4 11:50

Pool
1

(c)sportdata GmbH & Co KG 2000-2023 (2023-03-04 17:55) v 10.0.0 build 1 (2023-02-10) License: Online_Event_ID-6936_CampeonatoCentroamericanoydelCaribedeKarate2023 (expire 2023-03-18)

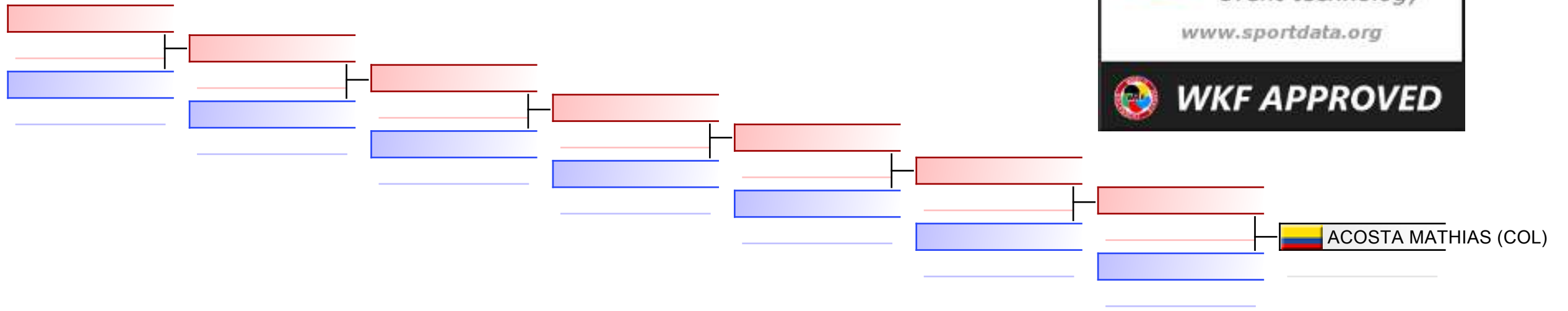

REPECHAGE: (1)

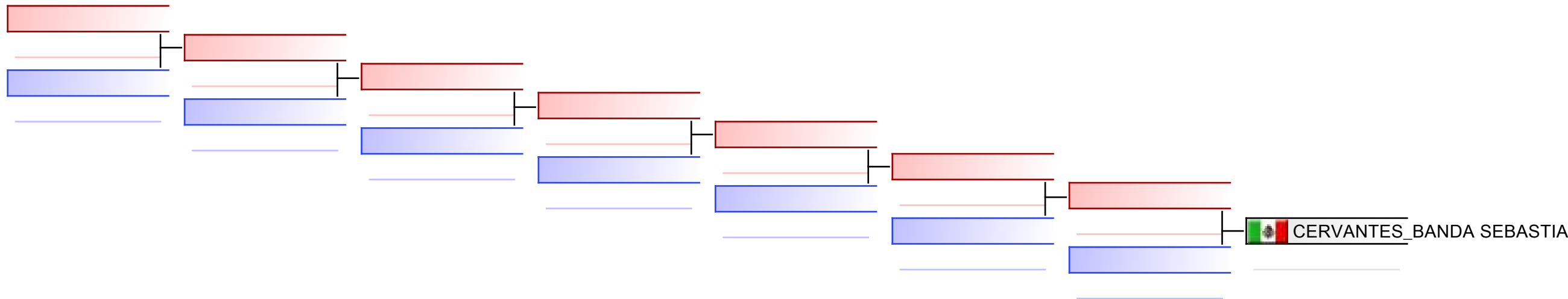

Referees:							
-----------	--	--	--	--	--	--	--

U14 KUMITE MALE 55+ KG

Campeonato Centroamericano y del Caribe de Karate 2023, Carretera Cocoyoc - Oaxtepec Km 2.5, Centro, 62738 Oaxtepec, MEX

2023-03-02

Tatami
3 12:00

Pool
1/1

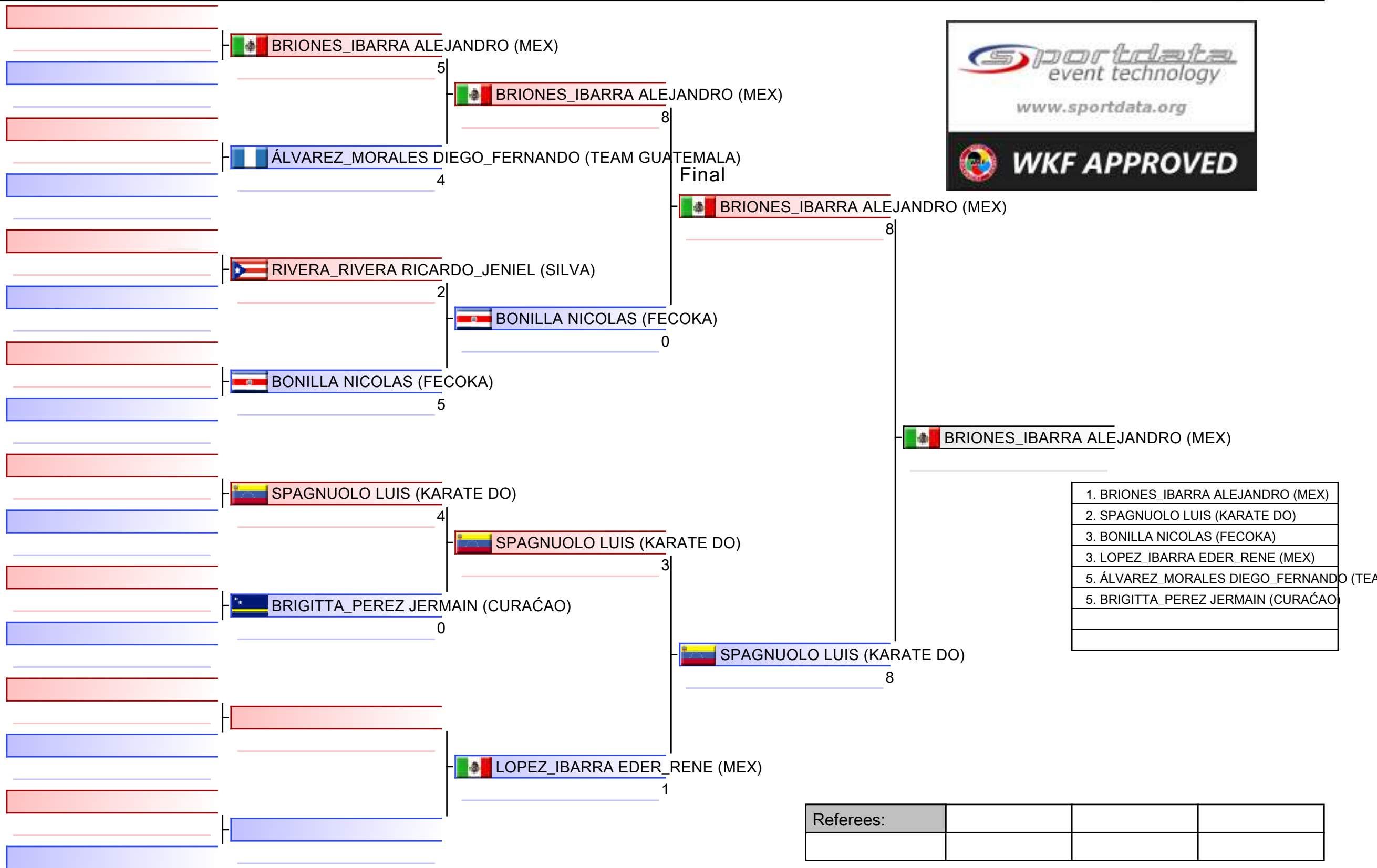

U14 KUMITE MALE 55+ KG

Campeonato Centroamericano y del Caribe de Karate 2023

2023-03-02

Tatami
3 12:20

Pool
1

(c)sportdata GmbH & Co KG 2000-2023 (2023-03-04 17:55) v 10.0.0 build 1 (2023-02-10) License: Online_Event_ID-6936_CampeonatoCentroamericanoydelCaribedeKarate2023 (expire 2023-03-18)

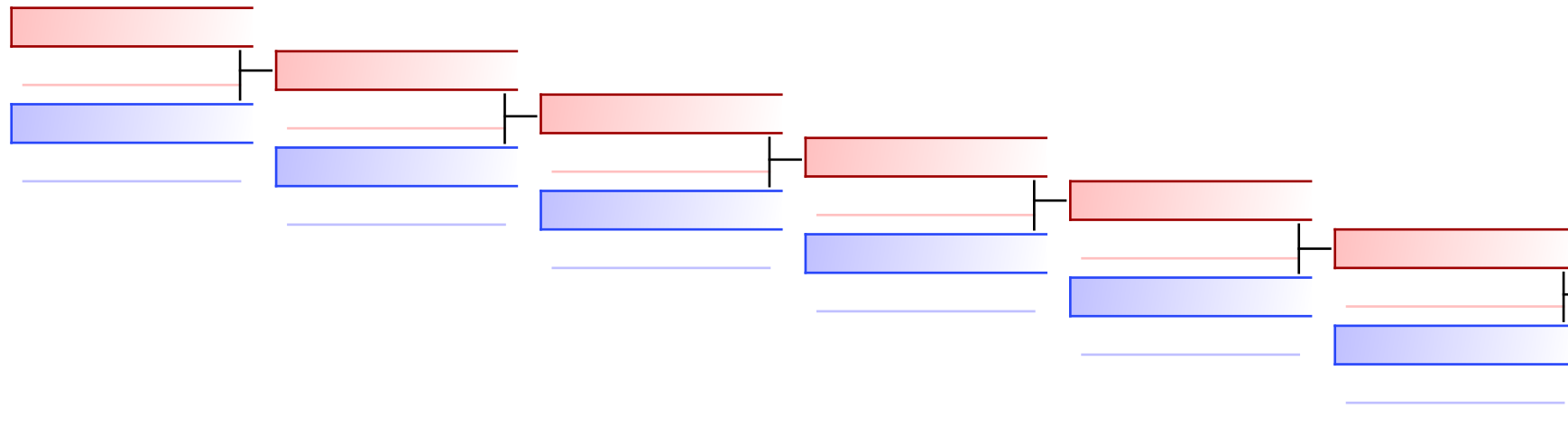

ÁLVAREZ_MORALES DIEGO_FERNANDO (TEAM GU)
0
 BONILLA NICOLAS (FECOKA)
 BONILLA NICOLAS (FECOKA)
3

REPECHAGE: (1)

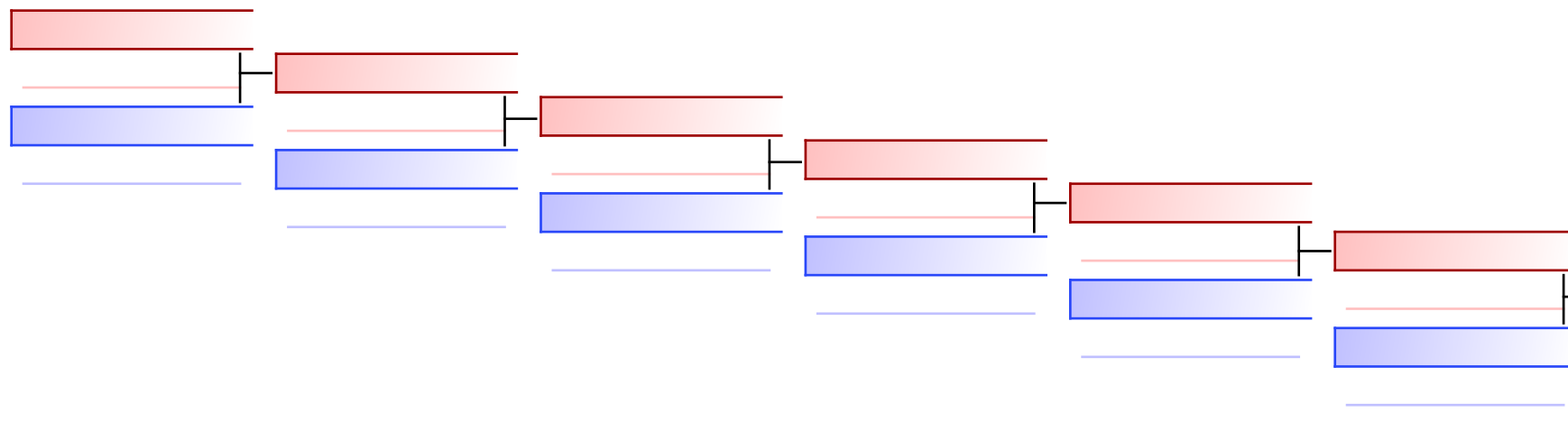

BRIGITTA_PEREZ JERMAIN (CURAÇAO)
1
 LOPEZ_IBARRA EDER_RENE (MEX)
 LOPEZ_IBARRA EDER_RENE (MEX)
5

Referees:							
-----------	--	--	--	--	--	--	--

**Campeonato Centroamericano y del
Caribe de Karate 2023 - 2023-03-02**

U21 Kata Female

R1 G1/2 (6) Tatami 4 09:00(2023-03-03)

Competitors	Kata	1	2	3	4	5	6	7	TOTAL	Extra Total Rank
1 GALAN_CRUZ HELEN_GEORGINA (FSK)	092 SUPARINPEI	(7.2)	7.3	(7.6)	7.4	7.4			22.1	22.1 2
2 DE_LA_MORA_SUSTAITA PENELOPE_LILIE (MEX)	068 PAPUREN	(7.0)	7.4	7.4	(7.6)	7.2			22.0	22.0 4
3 SANDOVAL_COELLO GRACIA_MARIA (FEDERACIÓN DE KARATE DE HONDURAS)	008 CHATANYARA KUSHANKU	6.9	7.1	(7.2)	6.8	(6.7)			20.8	20.8 6
4 MONGE VALERIA (FECOKA)	099 UNSU	7.3	7.3	7.5	(7.8)	(7.0)			22.1	22.1 3
5 OLIVERO GENESIS (KARATE DO)	092 SUPARINPEI	(7.2)	7.3	7.5	(7.9)				22.4	22.4 1
6 BAEZ_CAMACHO SOFIA (VOLQUEZ)	001 ANAN	(7.2)	7.2	7.3	(7.5)	7.3			21.8	21.8 5

R1 G2/2 (5) Tatami 4 09:25(2023-03-03)

Competitors	Kata	1	2	3	4	5	6	7	TOTAL	Extra Total Rank
1 CONEJO JIMENA (FECOKA)	021 GOJUSHIHO SHO	7.4	(6.9)	7.4	(7.8)	7.5			22.3	22.3 3
2 SALINAS_HERNANDEZ EMILIA (MEX)	092 SUPARINPEI	(6.1)	7.0	(7.6)	7.3	7.2			21.5	21.5 5
3 ZAPATA_MACHADO VALENTINA (COL)	092 SUPARINPEI	7.5	(7.3)	7.7	(8.3)	7.7			22.9	22.9 1
4 IZAGUIRRE_GALDAMEZ ESTEFANY_RACHEL (FSK)	068 PAPUREN	7.3	(7.2)	7.5	(8.0)	7.3			22.1	22.1 4
5 VELASQUEZ VICTORIA (KARATE DO)	092 SUPARINPEI	7.3	(7.2)	7.5	(8.1)	7.5			22.3	22.3 2

R2-G1 Tatami 4 09:50(2023-03-03)

Competitors	Kata	1	2	3	4	5	6	7	TOTAL	Extra Total Rank
1 MONGE VALERIA (FECOKA)	021 GOJUSHIHO SHO	(7.3)	7.3	(7.5)	7.3	7.3			21.9	21.9 4
2 OLIVERO GENESIS (KARATE DO)	068 PAPUREN	(7.2)	7.5	7.6	(7.7)	7.4			22.5	22.5 1
3 GALAN_CRUZ HELEN_GEORGINA (FSK)	008 CHATANYARA KUSHANKU	7.3	(7.6)	7.4	7.5	(7.2)			22.2	22.2 2
4 DE_LA_MORA_SUSTAITA PENELOPE_LILIE (MEX)	009 CHIBANA NO KUSHANKU	(7.1)	7.4	(7.9)	7.4	7.3			22.1	22.1 3

R2-G2 Tatami 4 10:05(2023-03-03)

Competitors	Kata	1	2	3	4	5	6	7	TOTAL	Extra Total Rank
1 VELASQUEZ VICTORIA (KARATE DO)	068 PAPUREN	7.5	(7.6)	7.6	7.6	(7.3)			22.7	22.7 2
2 IZAGUIRRE_GALDAMEZ ESTEFANY_RACHEL (FSK)	008 CHATANYARA KUSHANKU	(7.2)	(7.5)	7.4	7.3	7.4			22.1	22.1 4
3 CONEJO JIMENA (FECOKA)	020 GOJUSHIHO DAI	(7.3)	7.3	(8.1)	7.5	7.4			22.2	22.2 3
4 ZAPATA_MACHADO VALENTINA (COL)	068 PAPUREN	(7.5)	7.5	(8.0)	7.8	7.6			22.9	22.9 1

R3 Bronze Medal Match 1 Tatami 4 10:25(2023-03-03)

Competitors	Kata	1	2	3	4	5	6	7	TOTAL	Extra Total Rank
1 GALAN_CRUZ HELEN_GEORGINA (FSK)	068 PAPUREN	(7.2)	7.7	(7.9)	7.4	7.5			22.6	22.6 1
2 CONEJO JIMENA (FECOKA)	015 GANKAKU	(7.0)	7.4	(7.5)	7.2	7.2			21.8	21.8 2







R3 Bronze Medal Match 2 Tatami 4 10:35(2023-03-03)

Competitors	Kata	1	2	3	4	5	6	7	TOTAL	Extra Total Rank
1 DE_LA_MORA_SUSTAITA PENELOPE_LILIE (MEX)	043 KISHIMOTO NO KUSHANKU	7.5	(7.9)	(7.3)	7.3	7.3			22.1	22.1 2
2 VELASQUEZ VICTORIA (KARATE DO)	002 ANAN DAI	(7.7)	7.5	7.5	(7.4)	7.5			22.5	22.5 1





R3 Gold Medal Match Tatami 4 10:45(2023-03-03)

Competitors	Kata	1	2	3	4	5	6	7	TOTAL	Extra Total Rank
1 OLIVERO GENESIS (KARATE DO)	065 OYADOMARI NO PASSAI	7.5	(8.0)	7.4	(7.3)	7.5			22.4	22.4 2
2 ZAPATA_MACHADO VALENTINA (COL)	052 MATSUMURA BASSAI	7.6	(8.2)	7.6	(7.5)	7.7			22.9	22.9 1

Results

1	ZAPATA MACHADO VALENTINA	COLOMBIA		COLOMBIA
2	OLIVERO GENESIS	KARATE DO		VENEZUELA
3	GALAN CRUZ HELEN GEORGINA	FSK		EL SALVADOR
3	VELASQUEZ VICTORIA	KARATE DO		VENEZUELA
5	CONEJO JIMENA	FEDERACION COSTARRICENSE DE KARATE		COSTA RICA
5	DE LA MORA SUSTAITA PENELOPE LILIE	MEXICO		MEXICO

**Campeonato Centroamericano y del
Caribe de Karate 2023 - 2023-03-02
U21 Kata Female**

7	MONGE VALERIA	FEDERACION COSTARRICENSE DE KARATE		COSTA RICA
7	IZAGUIRRE GALDAMEZ ESTEFANY RACHEL	FSK		EL SALVADOR
9	BAEZ CAMACHO SOFIA	VOLQUEZ		DOMINICAN REPUBLIC
9	SALINAS HERNANDEZ EMILIA	MEXICO		MEXICO
11	SANDOVAL COELLO GRACIA MARIA	FEDERACIÓN DE KARATE DE HONDURAS		HONDURAS

**Campeonato Centroamericano y del
Caribe de Karate 2023 - 2023-03-02**

U21 Kata Male

R1 G1/2 (6) Tatami 3 09:00(2023-03-03)

Competitors	Kata	1	2	3	4	5	6	7	TOTAL	Extra Total Rank
1 VALDEZ_SAGASTEGUI ALBERTO (MEX)	064 OHAN DAI	(7.2)	7.8	(8.0)	7.8	7.5			23.1	23.1 4
2 DE_CASTRO_ESPAILLAT HERIBERTO_DE_JESUS (VOLQUEZ)	064 OHAN DAI	(7.4)	7.8	(8.1)	8.0	7.6			23.4	23.4 2
3 PEREZ RICARDO (KARATE DO)	001 ANAN	(7.7)	8.0	(8.3)	8.2	7.7			23.9	23.9 1
4 DELGADO_MACA SERGIO_ALEJANDRO (COL)	078 SANSI	(7.6)	7.6	(7.9)	7.9	7.6			23.1	23.1 3
5 NUNEZ_JOSHUA (FECOKA)	021 GOJUSHIHO SHO	(7.3)	7.5	7.8	(8.0)	7.5			22.8	22.8 5
6 MORALES_MAGANA DOUGLAS_OMAR (FSK)	068 PAPUREN	(6.8)	7.4	7.5	(8.1)	7.4			22.3	22.3 6

R1 G2/2 (6) Tatami 3 09:25(2023-03-03)

Competitors	Kata	1	2	3	4	5	6	7	TOTAL	Extra Total Rank
1 ZAMBRANO FERNANDO (KARATE DO)	002 ANAN DAI	7.3	(8.4)	7.8	(7.0)	7.8			22.9	22.9 2
2 CALDERÓN_ROCA FERNANDO (TEAM GUATEMALA)										
3 MEDINA DAVID_SANTIAGO (COL)	002 ANAN DAI	(7.1)	(8.1)	7.1	7.2	7.6			21.9	21.9 4
4 CASTILLO_RAMOS RODRIGO (MEX)	041 KANKU SHO	7.4	(8.0)	7.3	(6.9)	7.4			22.1	22.1 3
5 PORTILLO MATIAS (FECOKA)	021 GOJUSHIHO SHO	7.1	(7.9)	(6.9)	7.3	7.5			21.9	21.9 5
6 TORRES ROBERT (SILVA)	047 KURURUNFA	7.6	(7.9)	7.6	7.7	(7.2)			22.9	22.9 1

R2-G1 Tatami 3 09:55(2023-03-03)

Competitors	Kata	1	2	3	4	5	6	7	TOTAL	Extra Total Rank
1 VALDEZ_SAGASTEGUI ALBERTO (MEX)	068 PAPUREN	(7.3)	(8.4)	7.8	7.4	7.8			23.0	23.0 3
2 DE_CASTRO_ESPAILLAT HERIBERTO_DE_JESUS (VOLQUEZ)	002 ANAN DAI	(7.5)	(8.2)	7.6	7.8	7.7			23.1	23.1 2
3 DELGADO_MACA SERGIO_ALEJANDRO (COL)	099 UNSU	(7.0)	(8.3)	7.5	7.6	7.6			22.7	22.7 4
4 PEREZ RICARDO (KARATE DO)	064 OHAN DAI	(7.8)	(8.6)	8.0	8.0	8.1			24.1	24.1 1

R2-G2 Tatami 3 10:10(2023-03-03)

Competitors	Kata	1	2	3	4	5	6	7	TOTAL	Extra Total Rank
1 CASTILLO_RAMOS RODRIGO (MEX)	099 UNSU	7.5	7.6	(8.0)	7.5	(7.0)			22.6	22.6 4
2 MEDINA DAVID_SANTIAGO (COL)	008 CHATANYARA KUSHANKU	7.3	7.8	(7.9)	7.7	(7.2)			22.8	22.8 3
3 TORRES ROBERT (SILVA)	002 ANAN DAI	(7.6)	7.8	(8.1)	7.8	7.7			23.3	23.3 2
4 ZAMBRANO FERNANDO (KARATE DO)	092 SUPARINPEI	7.8	8.1	(8.3)	8.0	(7.4)			23.9	23.9 1

R3 Bronze Medal Match 1 Tatami 3 10:30(2023-03-03)

Competitors	Kata	1	2	3	4	5	6	7	TOTAL	Extra Total Rank
1 DE_CASTRO_ESPAILLAT HERIBERTO_DE_JESUS (VOLQUEZ)	063 OHAN	(8.1)	7.8	7.8	7.8	(7.7)			23.4	23.4 2
2 MEDINA DAVID_SANTIAGO (COL)	068 PAPUREN	(8.4)	8.0	(7.7)	8.0	7.8			23.8	23.8 1







R3 Bronze Medal Match 2 Tatami 3 10:40(2023-03-03)

Competitors	Kata	1	2	3	4	5	6	7	TOTAL	Extra Total Rank
1 VALDEZ_SAGASTEGUI ALBERTO (MEX)	008 CHATANYARA KUSHANKU	7.8	(8.1)	(7.6)	7.8	8.0			23.6	23.6 2
2 TORRES ROBERT (SILVA)	064 OHAN DAI	(7.6)	7.9	7.8	8.0	(8.2)			23.7	23.7 1





R3 Gold Medal Match Tatami 3 10:50(2023-03-03)

Competitors	Kata	1	2	3	4	5	6	7	TOTAL	Extra Total Rank
1 PEREZ RICARDO (KARATE DO)	092 SUPARINPEI	8.1	8.5	(7.9)	8.5	(8.7)			25.1	25.1 1
2 ZAMBRANO FERNANDO (KARATE DO)	008 CHATANYARA KUSHANKU	7.9	8.1	(7.6)	8.0	(8.6)			24.0	24.0 2

Results

1 PEREZ RICARDO	KARATE DO		VENEZUELA
2 ZAMBRANO FERNANDO	KARATE DO		VENEZUELA
3 MEDINA DAVID SANTIAGO	COLOMBIA		COLOMBIA
3 TORRES ROBERT	SILVA		PUERTO RICO
5 DE CASTRO ESPAILLAT HERIBERTO DE JESUS	VOLQUEZ		DOMINICAN REPUBLIC
5 VALDEZ SAGASTEGUI ALBERTO	MEXICO		MEXICO
7 DELGADO MACA SERGIO ALEJANDRO	COLOMBIA		COLOMBIA

**Campeonato Centroamericano y del
Caribe de Karate 2023 - 2023-03-02**
U21 Kata Male

7	CASTILLO RAMOS RODRIGO	MEXICO		MEXICO
9	NUNEZ JOSHUA	FEDERACION COSTARRICENSE DE KARATE		COSTA RICA
9	PORTILLO MATIAS	FEDERACION COSTARRICENSE DE KARATE		COSTA RICA
11	MORALES MAGAÑA DOUGLAS OMAR	FSK		EL SALVADOR

**Campeonato Centroamericano y del
Caribe de Karate 2023 - 2023-03-02
U21 Kata Team Female**

R1 G1/1 (1) Tatami 4 11:00(2023-03-03)

	Competitors	Kata	1	2	3	4	5	6	7	TOTAL	Extra Total Rank
1	DESCIDERIO DE_LA_MORA_SUSTAITA, GAYTAN_SUSTAITA, JIMENEZ_RODRIGUEZ) (MEX)	001 ANAN	(7.1)	7.6	(7.7)	7.4	7.3			22.3	22.3 1

Results

1	DESCIDERIO - DE_LA_MORA_SUSTAITA PENELOPE_LILIE - GAYTAN_SUSTAITA JOHANA_LETICIA - JIMENEZ_RODRIGUEZ DANIELA_CAROLINA	MEXICO		MEXICO
---	--	--------	---	--------

**Campeonato Centroamericano y del
Caribe de Karate 2023 - 2023-03-02
U21 Kata Team Male**

R1 G1/1 (1) Tatami 3 11:05(2023-03-03)

Competitors		Kata	1	2	3	4	5	6	7	TOTAL	Extra Total	Rank
1	DESCIDERIO (CASTILLO_RAMOS, NUÑEZ_SANCHEZ, PEREZ_AGUILERA) (MEX)	099 UNSU	7.4	(8.2)	8.2	7.8	(7.2)			23.4	23.4	1

Results

1	DESCIDERIO - CASTILLO_RAMOS RODRIGO - NUÑEZ_SANCHEZ RICARDO_YAEL - PEREZ_AGUILERA ANGEL_GABRIEL	MEXICO		MEXICO
---	--	--------	---	--------

U21 KUMITE FEMALE -50 KG

Campeonato Centroamericano y del Caribe de Karate 2023, Carretera Cocoyoc - Oaxtepec Km 2.5, Centro, 62738 Oaxtepec, MEX

2023-03-03

Tatami
1 13:25

Pool
1/1

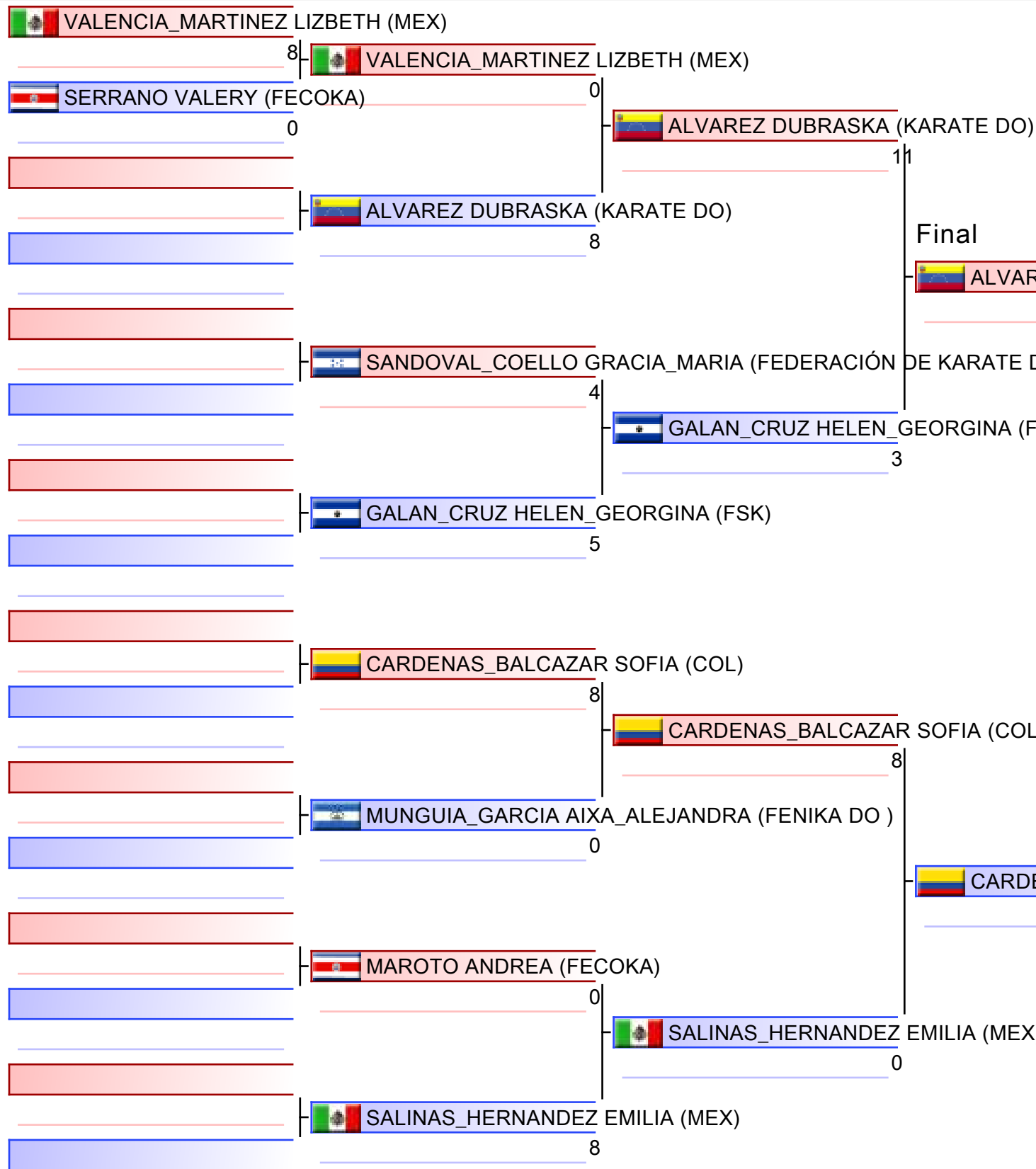

1. CARDENAS_BALCAZAR SOFIA (COL)
2. ALVAREZ DUBRASKA (KARATE DO)
3. VALENCIA_MARTINEZ LIZBETH (MEX)
3. SALINAS_HERNANDEZ EMILIA (MEX)
5. GALAN_CRUZ HELEN_GEORGINA (FSK)
5. MUNGUIA_GARCIA AIXA_ALEJANDRA (FENIKA DO)

Referees:			

U21 KUMITE FEMALE -50 KG

Campeonato Centroamericano y del Caribe de Karate 2023

2023-03-03

Tatami
1 14:10

Pool
1

(c)sportdata GmbH & Co KG 2000-2023 (2023-03-04 17:55) v 10.0.0 build 1 (2023-02-10) License: Online_Event_ID-6936_CampeonatoCentroamericanoydelCaribedeKarate2023 (expire 2023-03-18)

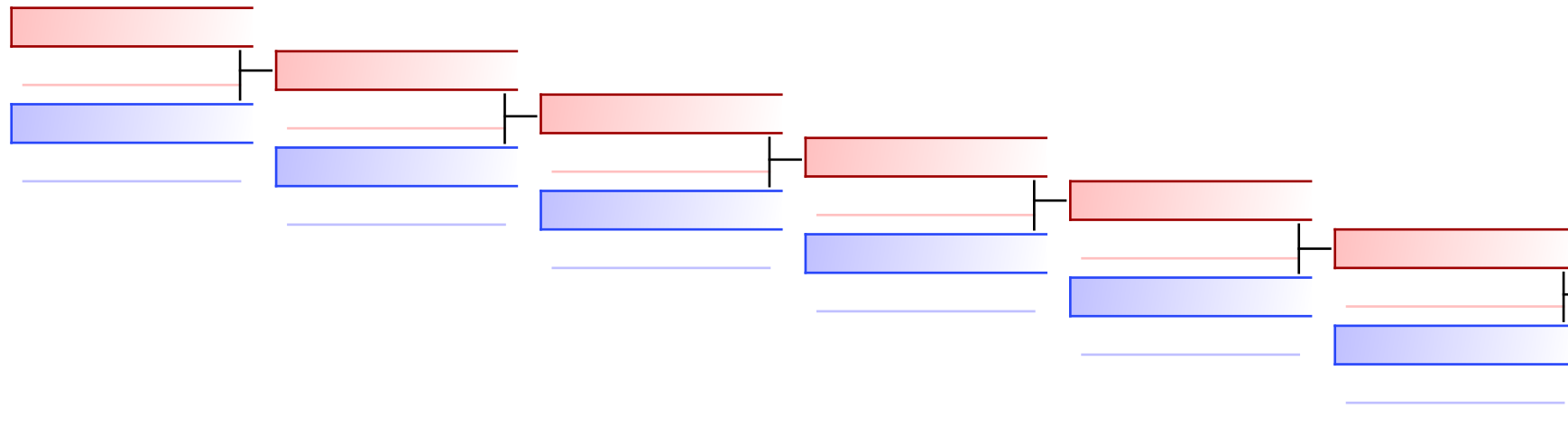

VALENCIA_MARTINEZ LIZBETH (MEX) 5
 GALAN_CRUZ HELEN_GEORGINA (FSK) 2

REPECHAGE: (1)

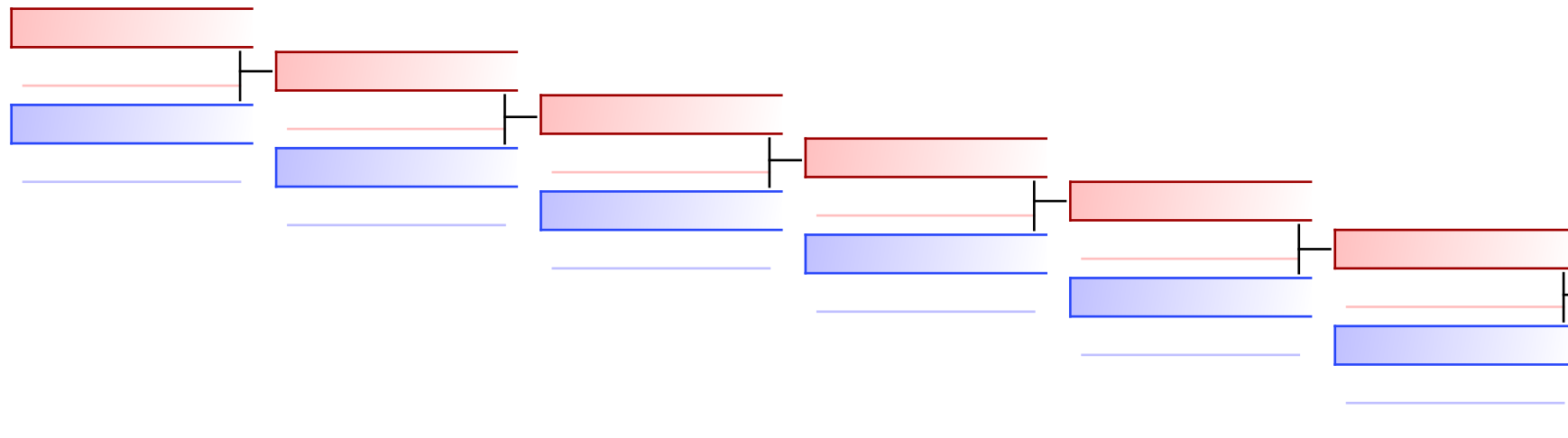

MUNGUIA_GARCIA AIXA_ALEJANDRA (FENIKA DO) 1
 SALINAS_HERNANDEZ EMILIA (MEX) 9

Referees:							
-----------	--	--	--	--	--	--	--

U21 KUMITE FEMALE -55 KG

Campeonato Centroamericano y del Caribe de Karate 2023, Carretera Cocoyoc - Oaxtepec Km 2.5, Centro, 62738 Oaxtepec, MEX

2023-03-03

Tatami
2 13:25

Pool
1/1

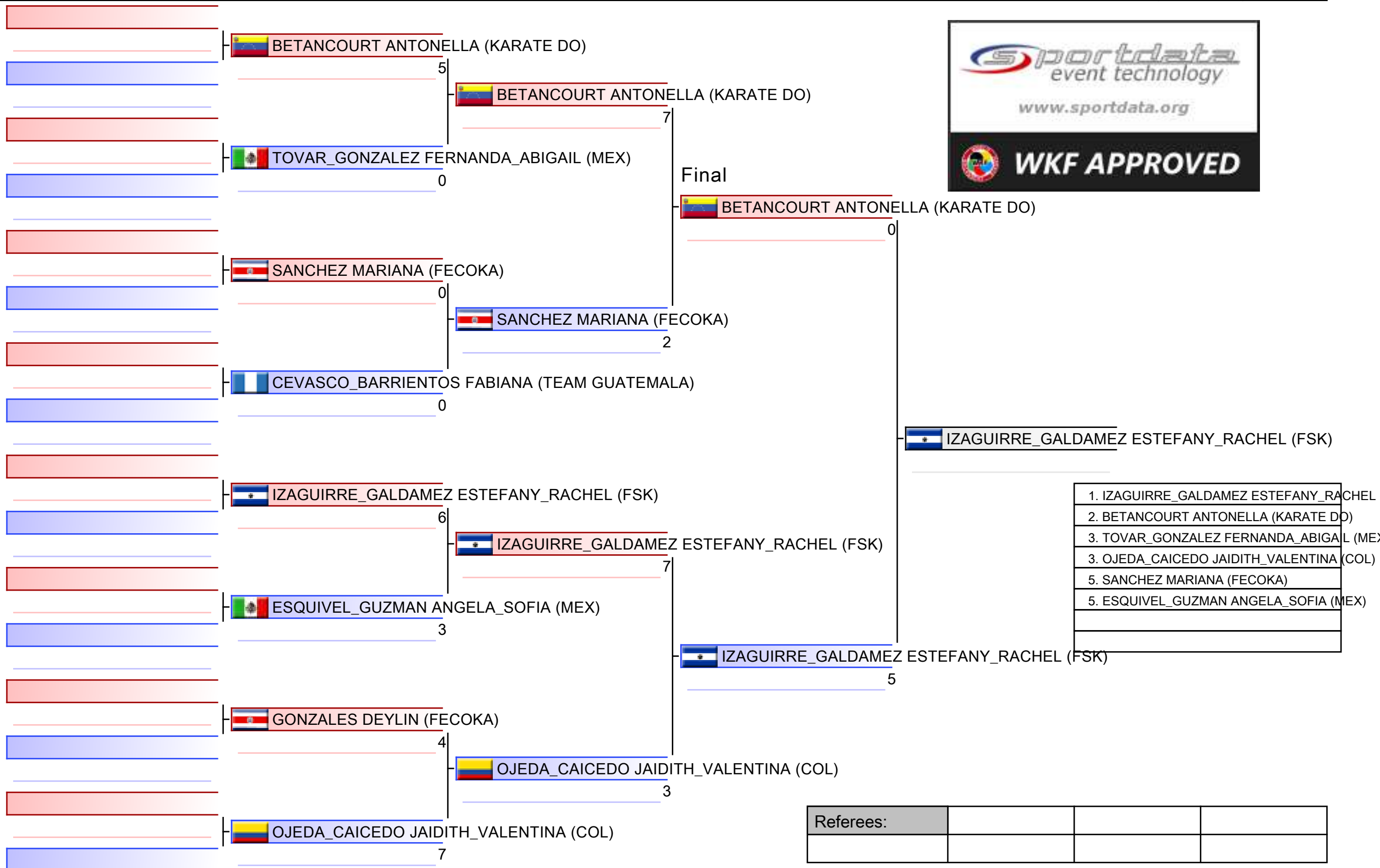

Referees:			

U21 KUMITE FEMALE -55 KG

Campeonato Centroamericano y del Caribe de Karate 2023

2023-03-03

Tatami
2 14:00

Pool
1

(c)sportdata GmbH & Co KG 2000-2023 (2023-03-04 17:55) v 10.0.0 build 1 (2023-02-10) License: Online_Event_ID-6936_CampeonatoCentroamericanoydelCaribedeKarate2023 (expire 2023-03-18)

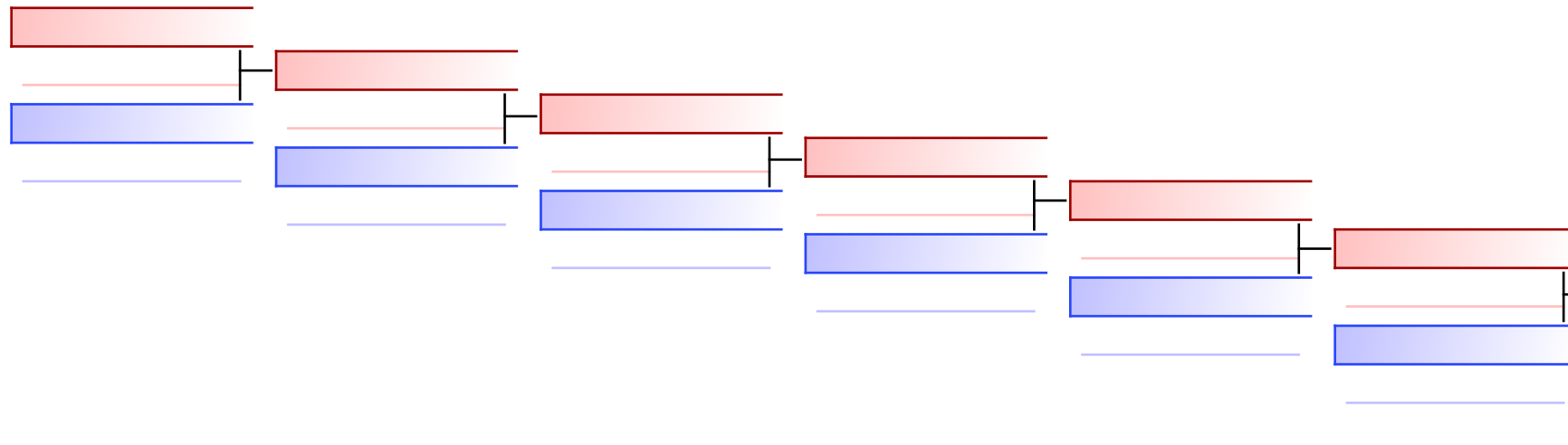

TOVAR_GONZALEZ FERNANDA_ABIGAIL (MEX)
 | 10
 TOVAR_GONZALEZ FERNANDA
 SANCHEZ MARIANA (FECOKA)
 | 2

REPECHAGE: (1)

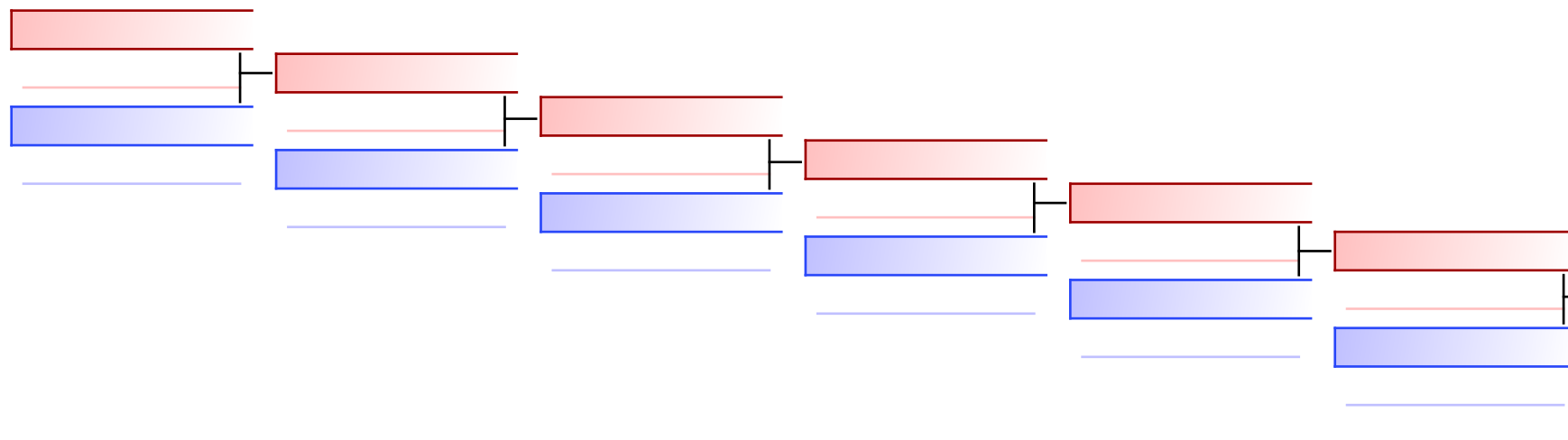

ESQUIVEL_GUZMAN ANGELA_SOFIA (MEX)
 | 6
 OJEDA_CAICEDO JAIDITH_VALERIA
 OJEDA_CAICEDO JAIDITH VALENTINA (COL)
 | 6

Referees:							
-----------	--	--	--	--	--	--	--

U21 KUMITE FEMALE -61 KG

Campeonato Centroamericano y del Caribe de Karate 2023, Carretera Cocoyoc - Oaxtepec Km 2.5, Centro, 62738 Oaxtepec, MEX

2023-03-03

Tatami
1 14:45

Pool
1/1

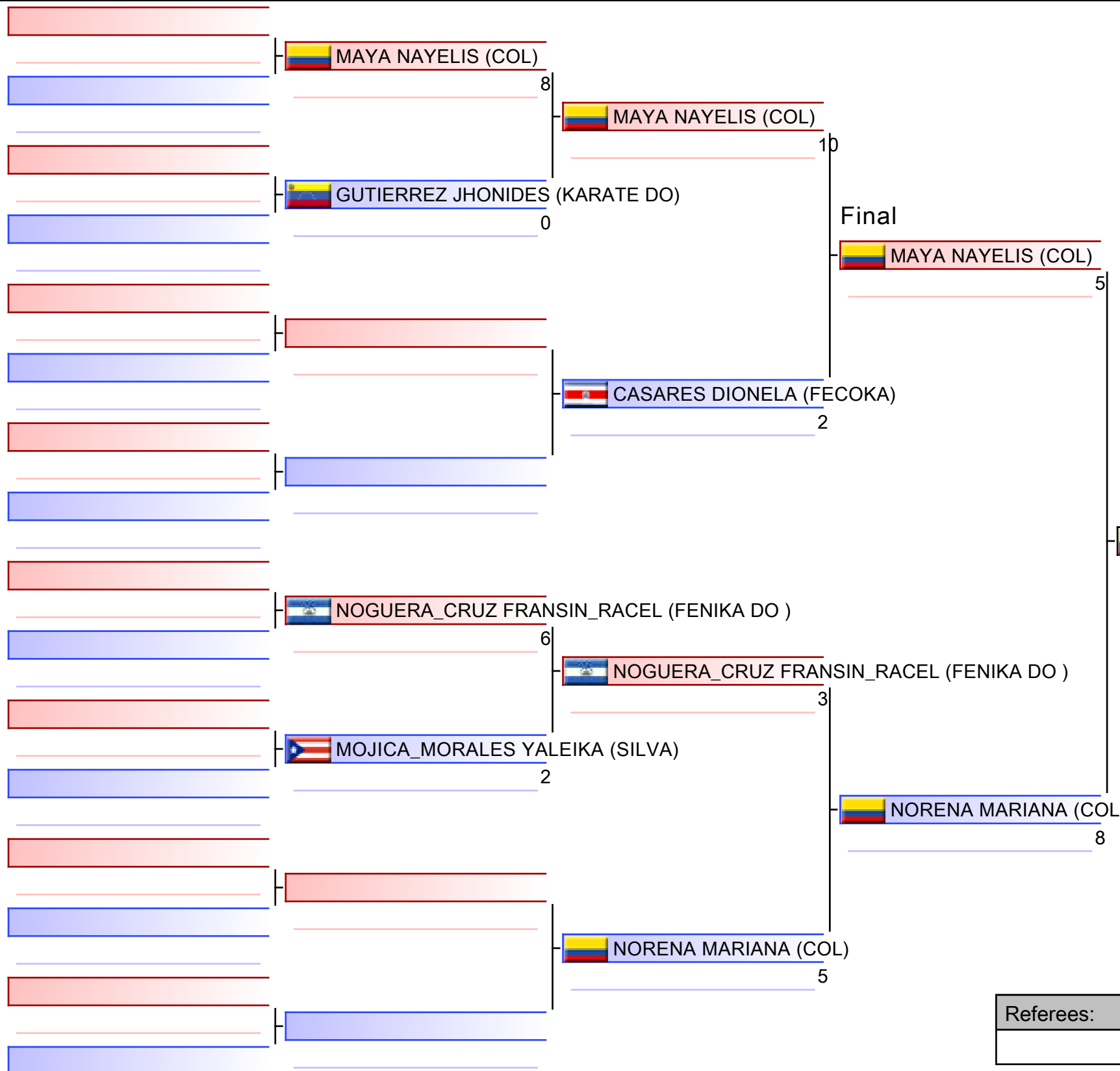

NORENA MARIANA (COL)

1. NORENA MARIANA (COL)
2. MAYA NAYELIS (COL)
3. NOGUERA_CRUZ FRANSIN_RACEL (FENIKA DO)
3. GUTIERREZ JHONIDES (KARATE DO)
5. CASARES DIONELA (FECOKA)

Referees:			

U21 KUMITE FEMALE -61 KG

Campeonato Centroamericano y del Caribe de Karate 2023

2023-03-03

Tatami
1 15:10

Pool
1

(c)sportdata GmbH & Co KG 2000-2023 (2023-03-04 17:55) v 10.0.0 build 1 (2023-02-10) License: Online_Event_ID-6936_CampeonatoCentroamericanoydelCaribedeKarate2023 (expire 2023-03-18)



 GUTIERREZ JHONIDES (KARATE DO)
5
 GUTIERREZ JHONIDES (KARATE DO)
 CASARES DIONELA (FECOKA)
0

REPECHAGE: (1)

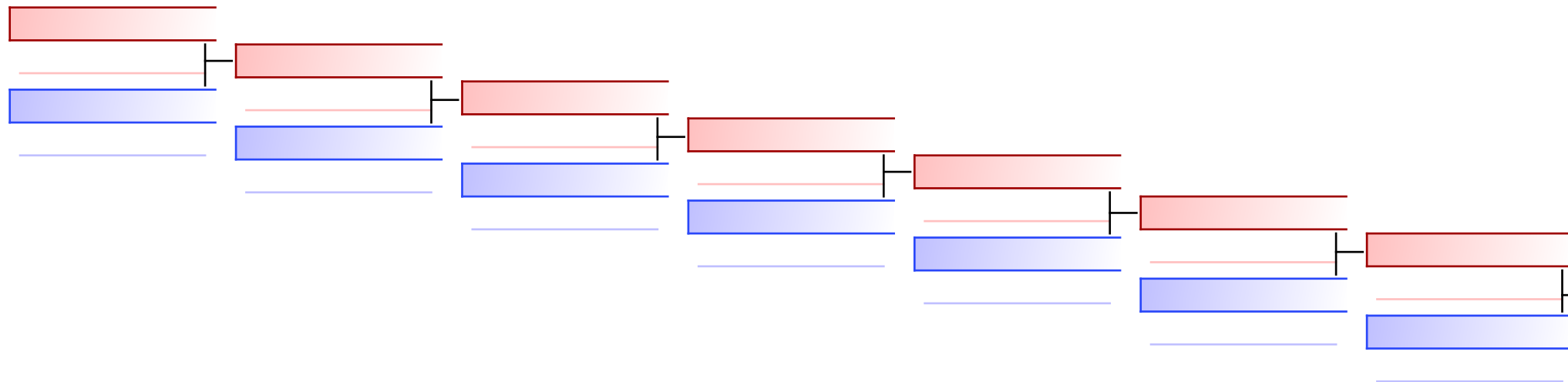

 NOGUERA_CRUZ FRANSIN_RAC

Referees:							
-----------	--	--	--	--	--	--	--

U21 KUMITE FEMALE -68 KG

Campeonato Centroamericano y del Caribe de Karate 2023, Carretera Cocoyoc - Oaxtepec Km 2.5, Centro, 62738 Oaxtepec, MEX

2023-03-03

Tatami
2 14:25

Pool
1/1

 AGUDELO MARIA_ALEJANDRA (COL)

3 |  AGUDELO MARIA_ALEJANDRA (COL)

 VALENCIA_ALONSO AVRIL (MEX)

0

 AGUDELO MARIA_ALEJANDRA (COL)

3

 VASQUEZ_ALVARADO MARIA_JOSE (FSK)

0

Final

 BARRETO ELENA (KARATE DO)

5

 VERGARA DESTINY (SILVA)

2

 BARRETO ELENA (KARATE DO)

4

 BARRETO ELENA (KARATE DO)

5

 PALENCIA_GALVEZ LUISA_FERNANDA (TEAM GUATEMALA)

0

 CASTILLO KEYLA (PAN)

0

 CASTILLO KEYLA (PAN)

0

 MADERA_RODRIGUEZ KAREN_VIOLEYMI (VOLQUEZ)

0

 MADERA_RODRIGUEZ KAREN_VIOLEYMI (VOLQUEZ)

8

 MADERA_RODRIGUEZ KAREN_VIOLEYMI (VOLQUEZ)

4

 MENDEZ_MAYEN ALONDRA_ELIZABETH (MEX)

4

 MENDEZ_MAYEN ALONDRA_ELIZABETH (MEX)

0

 GIRALDO SAMANTHA (COL)

3



1. BARRETO ELENA (KARATE DO)
2. MADERA_RODRIGUEZ KAREN_VIOLEYMI (VOLQUEZ)
3. VERGARA DESTINY (SILVA)
3. MENDEZ_MAYEN ALONDRA_ELIZABETH (MEX)
5. AGUDELO MARIA_ALEJANDRA (COL)
5. CASTILLO KEYLA (PAN)

Referees:			

U21 KUMITE FEMALE -68 KG

Campeonato Centroamericano y del Caribe de Karate 2023

2023-03-03

Tatami
2 15:15

Pool
1

(c)sportdata GmbH & Co KG 2000-2023 (2023-03-04 17:55) v 10.0.0 build 1 (2023-02-10) License: Online_Event_ID-6936_CampeonatoCentroamericanoydelCaribedeKarate2023 (expire 2023-03-18)

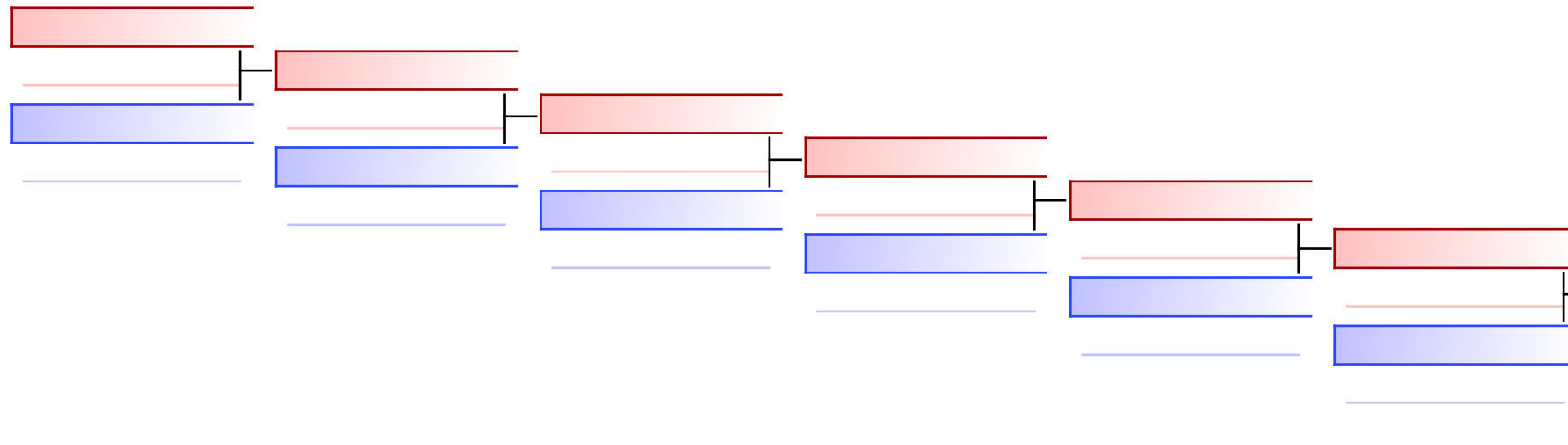

VERGARA DESTINY (SILVA) 9
 VERGARA DESTINY (SILVA)
 AGUDELO MARIA_ALEJANDRA (COL) 3

REPECHAGE: (1)

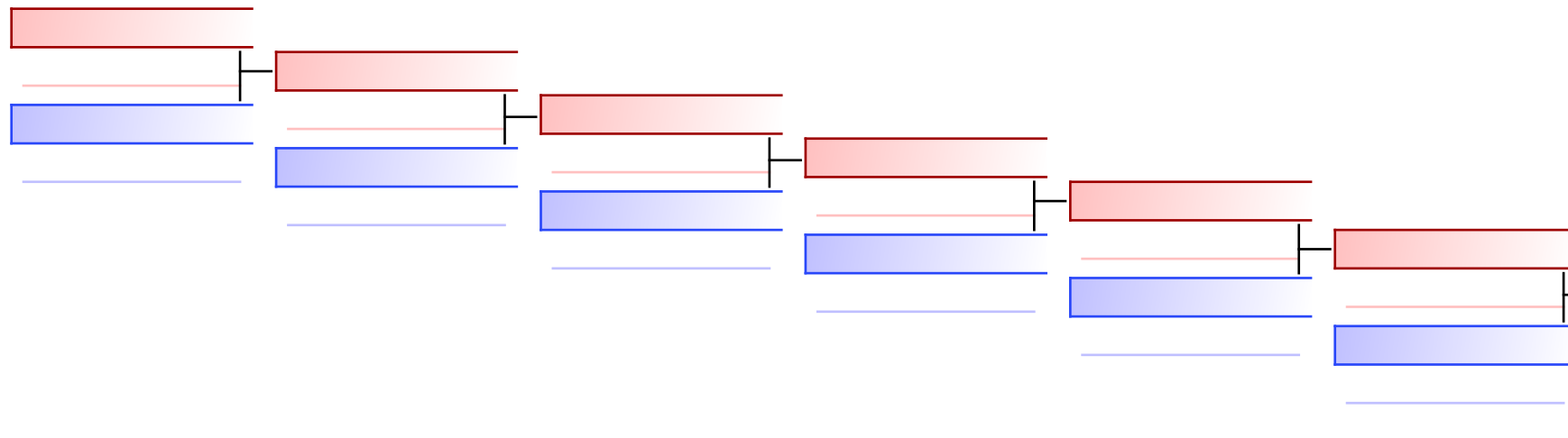

CASTILLO KEYLA (PAN) 0
 MENDEZ_MAYEN ALONDRA_ELIZABETH (MEX) 4

Referees:							
-----------	--	--	--	--	--	--	--

U21 KUMITE FEMALE 68+ KG

Campeonato Centroamericano y del Caribe de Karate 2023, Carretera Cocoyoc - Oaxtepec Km 2.5, Centro, 62738 Oaxtepec, MEX

2023-03-03

Tatami
1 15:35

Pool
1/1

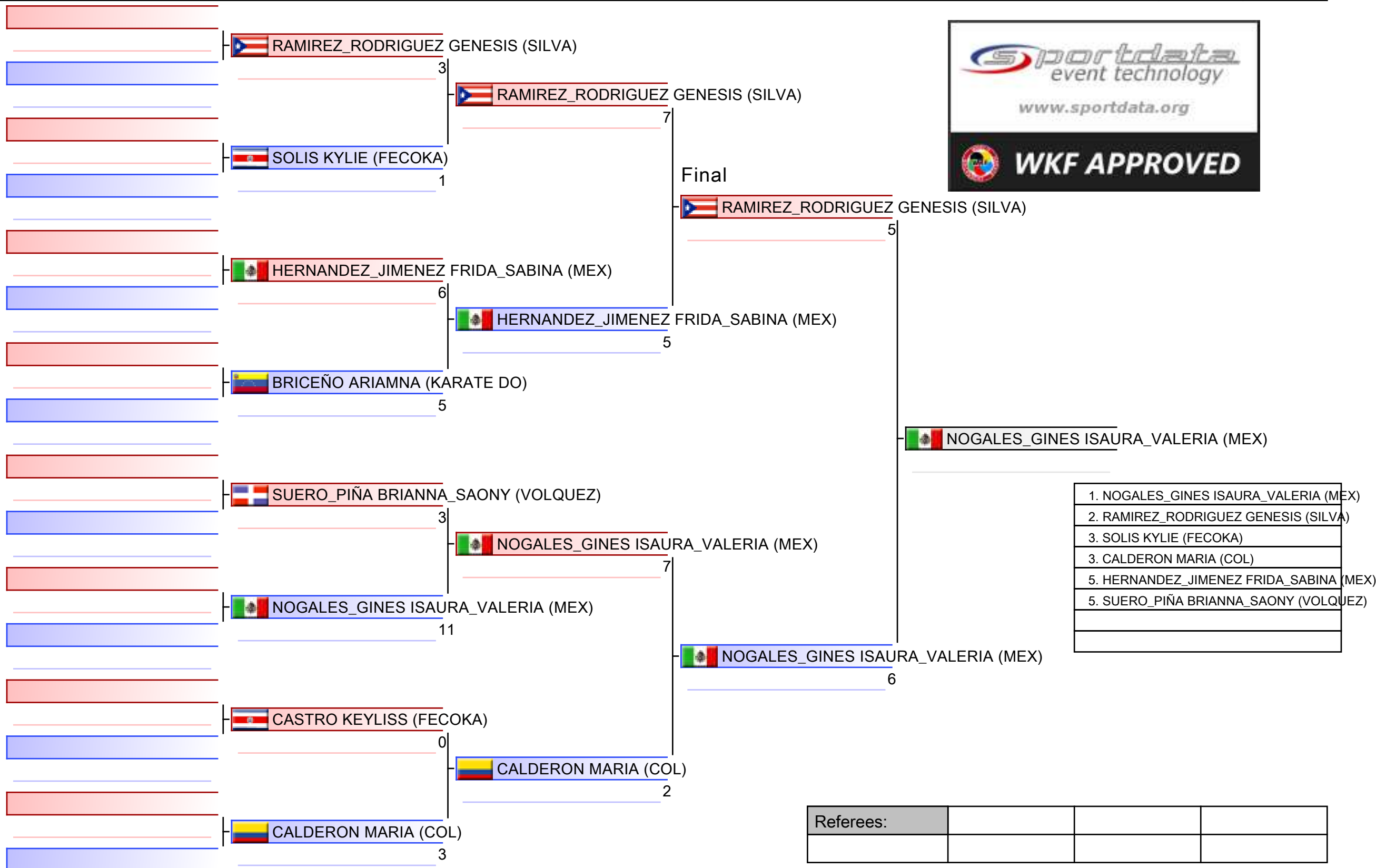

1. NOGALES_GINES ISAURA_VALERIA (MEX)
2. RAMIREZ_RODRIGUEZ GENESIS (SILVA)
3. SOLIS KYLIE (FECOKA)
3. CALDERON MARIA (COL)
5. HERNANDEZ_JIMENEZ FRIDA_SABINA (MEX)
5. SUERO_PIÑA BRIANNA_SAONY (VOLQUEZ)

Referees:			

U21 KUMITE FEMALE 68+ KG

Campeonato Centroamericano y del Caribe de Karate 2023

2023-03-03

Tatami
1 16:10

Pool
1

(c)sportdata GmbH & Co KG 2000-2023 (2023-03-04 17:55) v 10.0.0 build 1 (2023-02-10) License: Online_Event_ID-6936_CampeonatoCentroamericanoydelCaribedeKarate2023 (expire 2023-03-18)

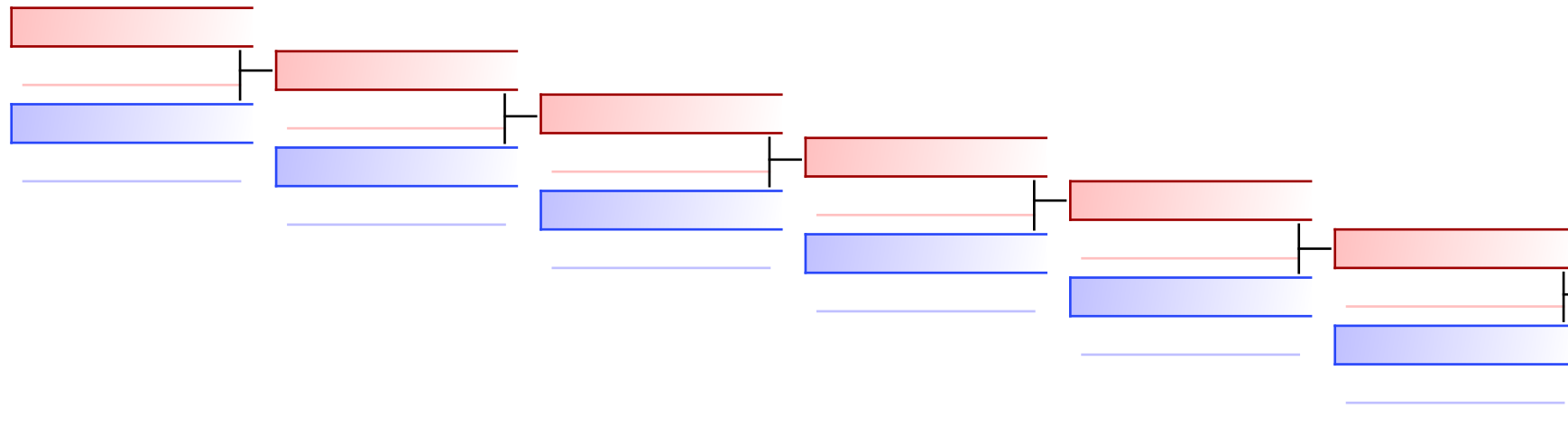

 SOLIS KYLIE (FECOKA) 9
 HERNANDEZ_JIMENEZ FRIDA_SABINA (MEX) 0

REPECHAGE: (1)

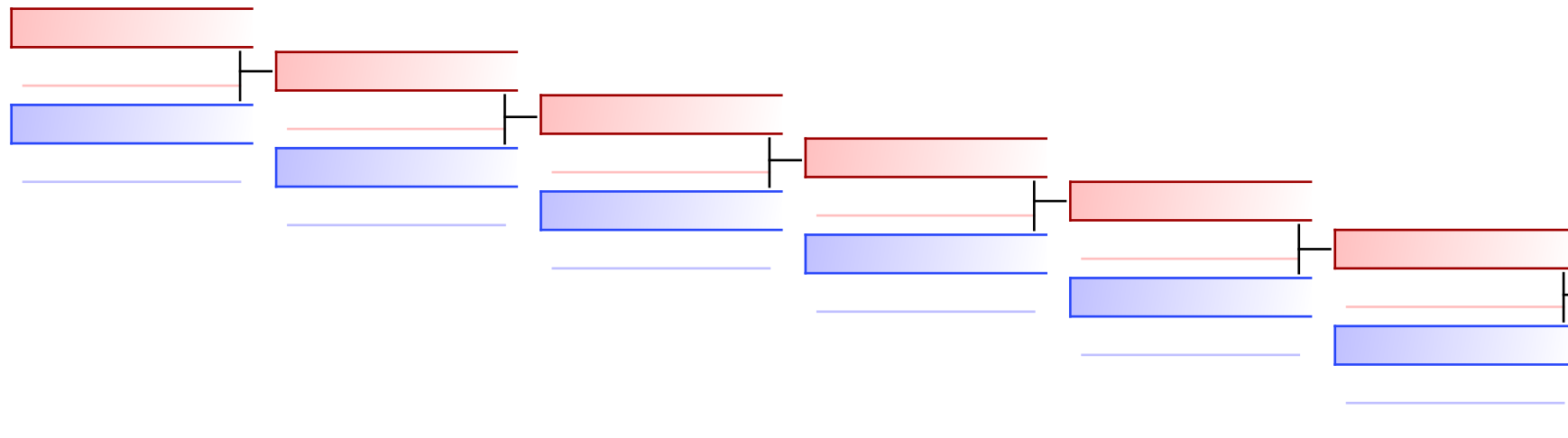

 SUERO_PIÑA BRIANNA_SAONY (VOLQUEZ) 3
 CALDERON MARIA (COL) 8

Referees:							
-----------	--	--	--	--	--	--	--

U21 KUMITE MALE -60 KG

Campeonato Centroamericano y del Caribe de Karate 2023, Carretera Cocoyoc - Oaxtepec Km 2.5, Centro, 62738 Oaxtepec, MEX

2023-03-03

Tatami
3 13:25

Pool
1/1

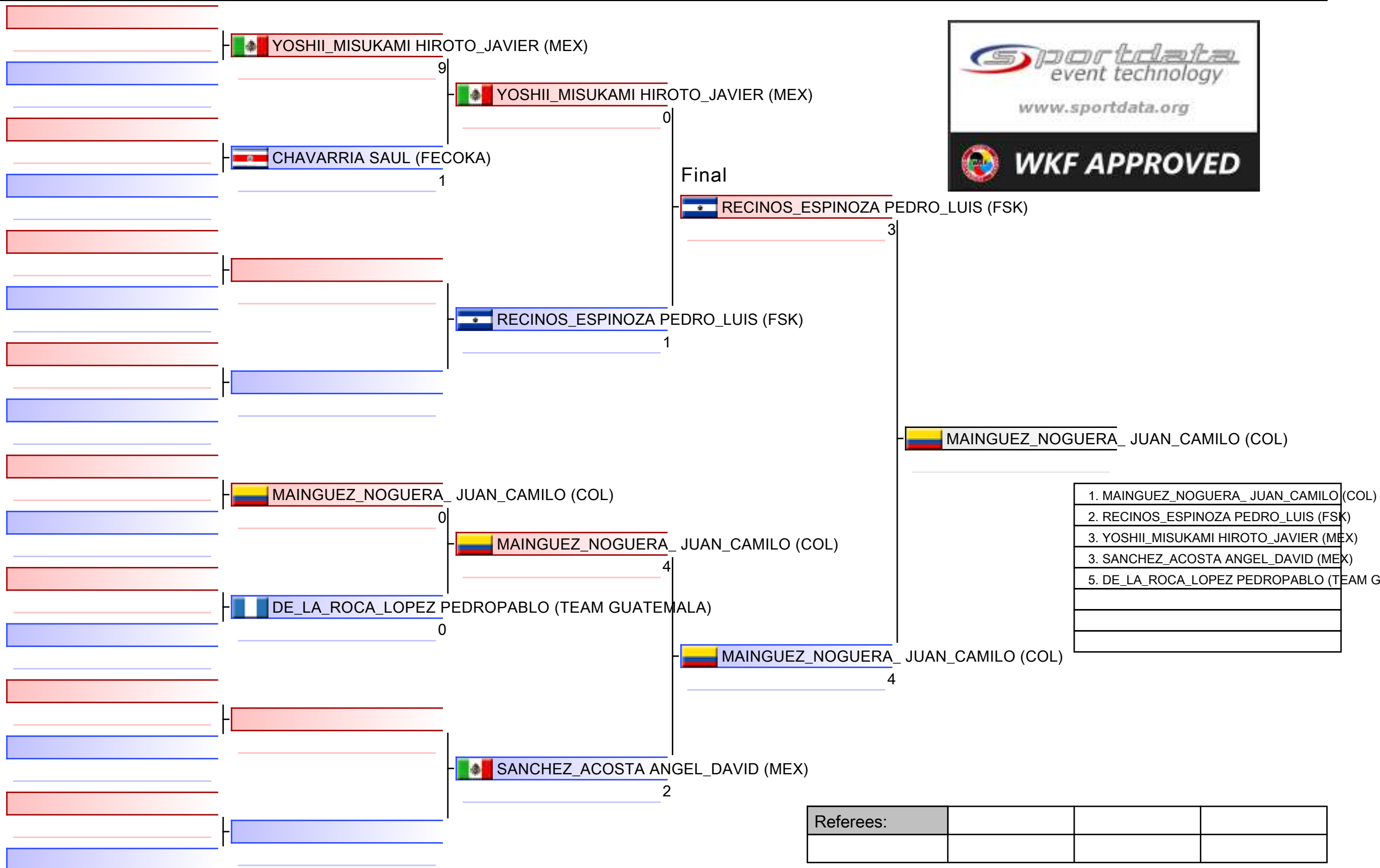

U21 KUMITE MALE -60 KG

Campeonato Centroamericano y del Caribe de Karate 2023

2023-03-03

Tatami
3 13:50

Pool
1

(c)sportdata GmbH & Co KG 2000-2023 (2023-03-04 17:55) v 10.0.0 build 1 (2023-02-10) License: Online_Event_ID-6936_CampeonatoCentroamericanoydelCaribedeKarate2023 (expire 2023-03-18)

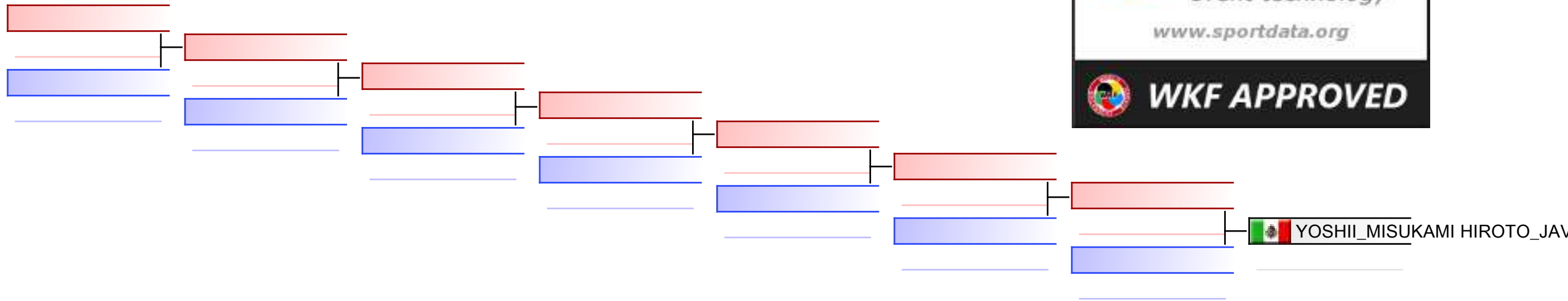

REPECHAGE: (1)

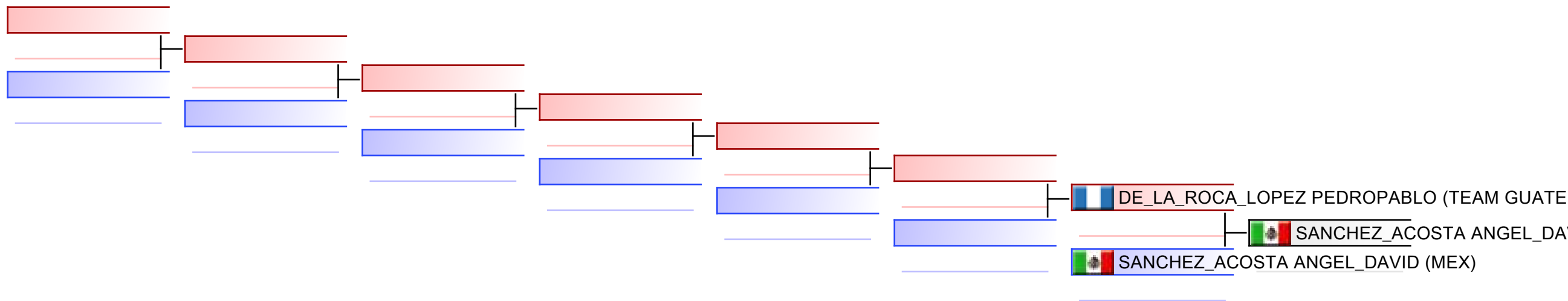

Referees:							
-----------	--	--	--	--	--	--	--

U21 KUMITE MALE -67 KG

Campeonato Centroamericano y del Caribe de Karate 2023, Carretera Cocoyoc - Oaxtepec Km 2.5, Centro, 62738 Oaxtepec, MEX

2023-03-03

Tatami
3 14:15

Pool
1/1

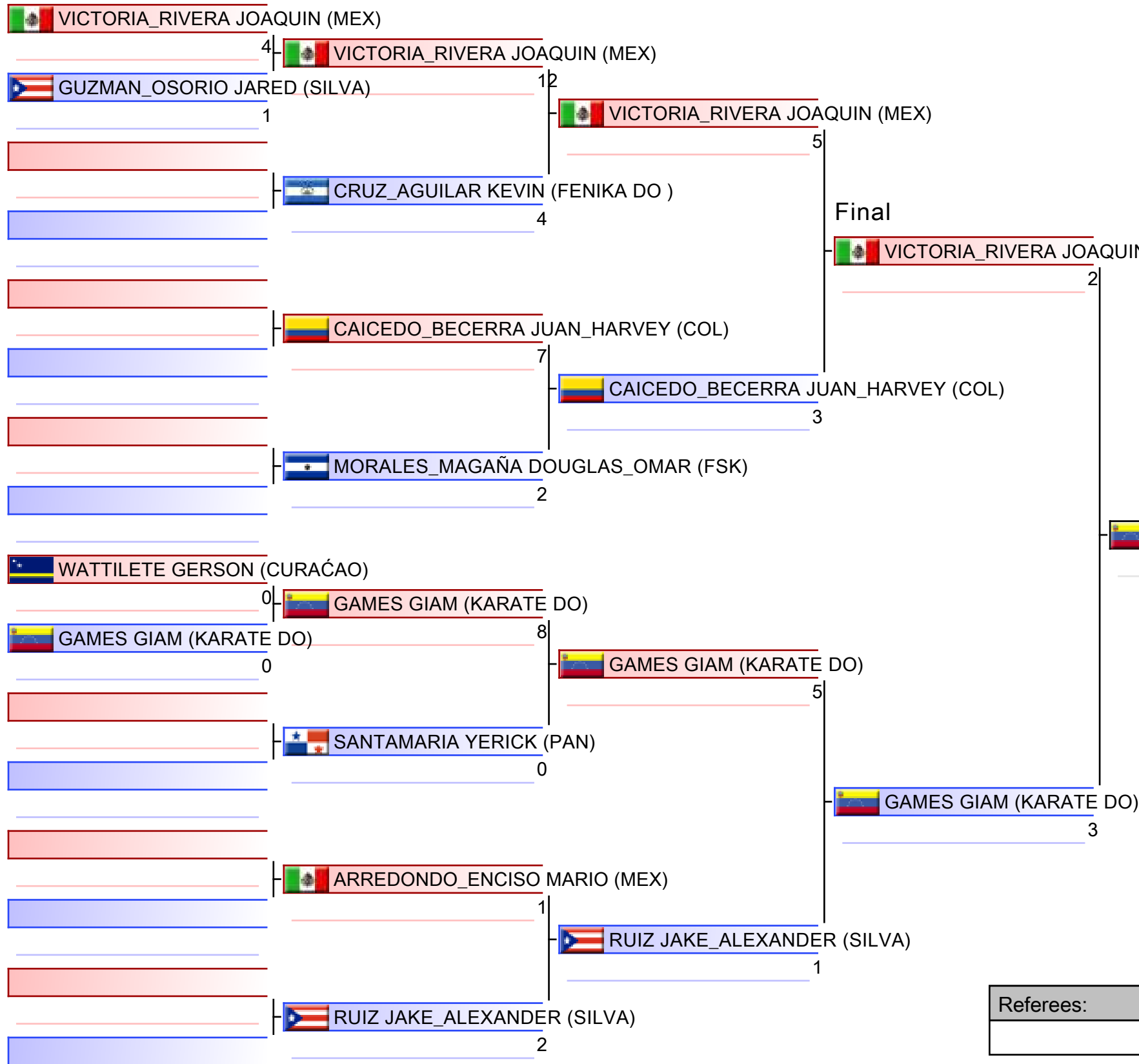

1. GAMES GIAM (KARATE DO)
2. VICTORIA_RIVERA JOAQUIN (MEX)
3. CRUZ_AGUILAR KEVIN (FENIKA DO)
3. SANTAMARIA YERICK (PAN)
5. CAICEDO_BECERRA JUAN_HARVEY (COL)
5. RUIZ JAKE_ALEXANDER (SILVA)
7. GUZMAN_OSORIO JARED (SILVA)
7. WATTILETE GERSON (CURAÇAO)

Referees:			

U21 KUMITE MALE -67 KG

Campeonato Centroamericano y del Caribe de Karate 2023

2023-03-03

Tatami
3 15:05

Pool
1

(c)sportdata GmbH & Co KG 2000-2023 (2023-03-04 17:55) v 10.0.0 build 1 (2023-02-10) License: Online_Event_ID-6936_CampeonatoCentroamericanoydelCaribedeKarate2023 (expire 2023-03-18)

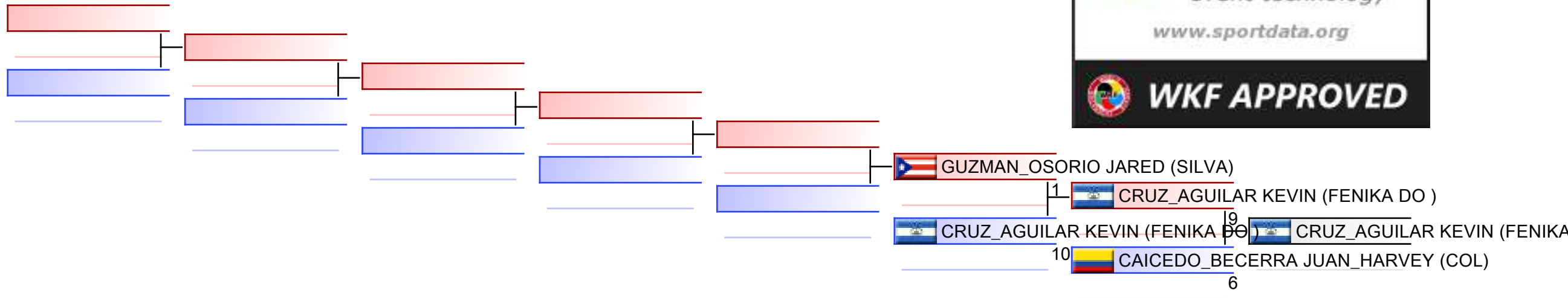

REPECHAGE: (1)

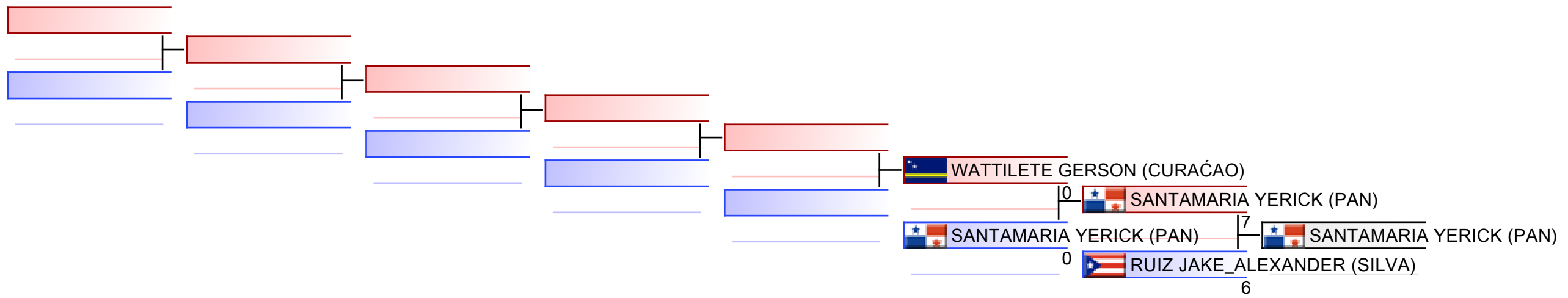

Referees:							
-----------	--	--	--	--	--	--	--

U21 KUMITE MALE -75 KG

Campeonato Centroamericano y del Caribe de Karate 2023, Carretera Cocoyoc - Oaxtepec Km 2.5, Centro, 62738 Oaxtepec, MEX

2023-03-03

Tatami
3 15:40

Pool
1/1

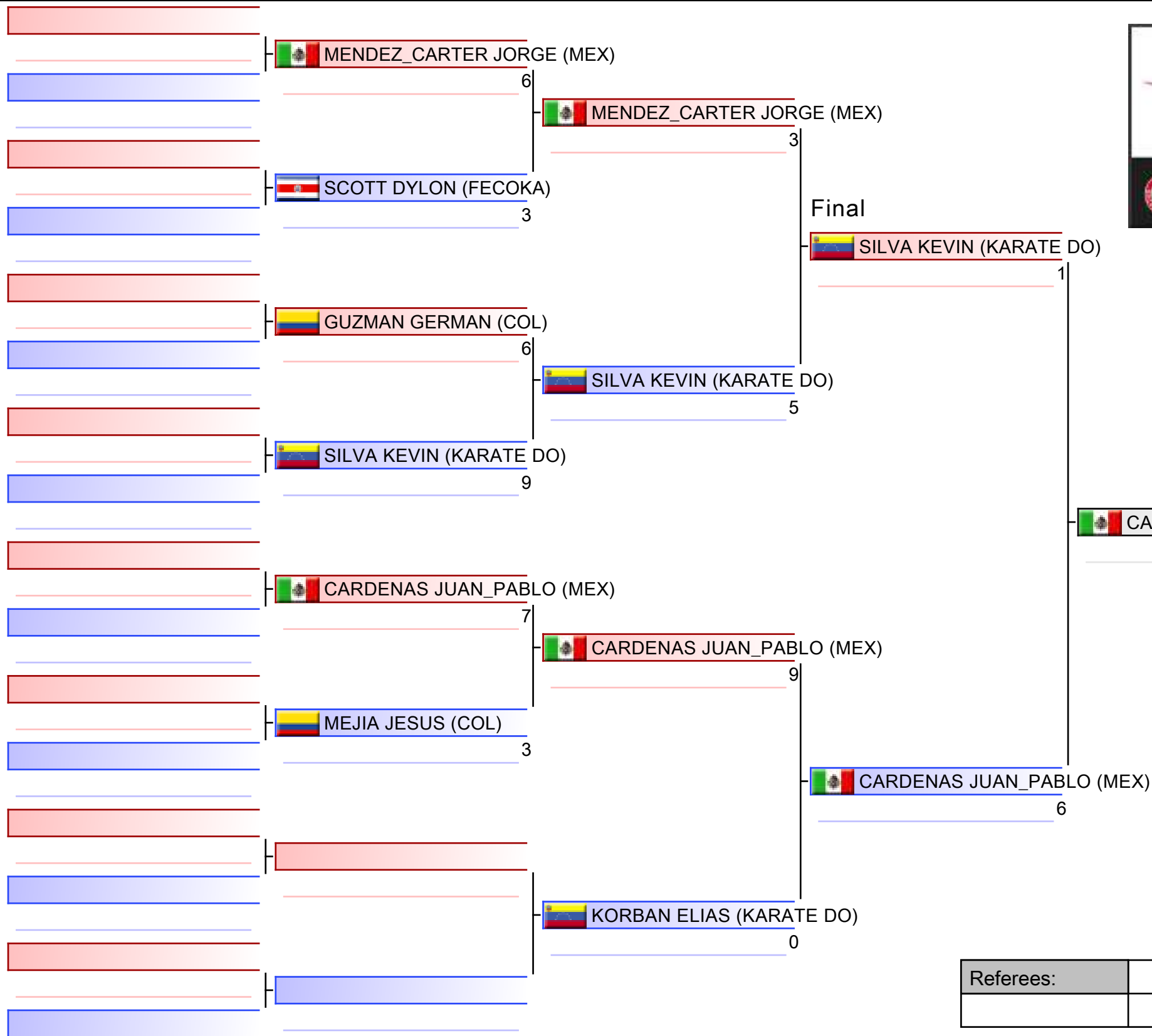

1. CARDENAS JUAN_PABLO (MEX)
2. SILVA KEVIN (KARATE DO)
3. MENDEZ_CARTER JORGE (MEX)
3. KORBAN ELIAS (KARATE DO)
5. GUZMAN GERMAN (COL)
5. MEJIA JESUS (COL)

Referees:			

U21 KUMITE MALE -75 KG

Campeonato Centroamericano y del Caribe de Karate 2023

2023-03-03

Tatami
3 16:10

Pool
1

(c)sportdata GmbH & Co KG 2000-2023 (2023-03-04 17:55) v 10.0.0 build 1 (2023-02-10) License: Online_Event_ID-6936_CampeonatoCentroamericanoydelCaribedeKarate2023 (expire 2023-03-18)

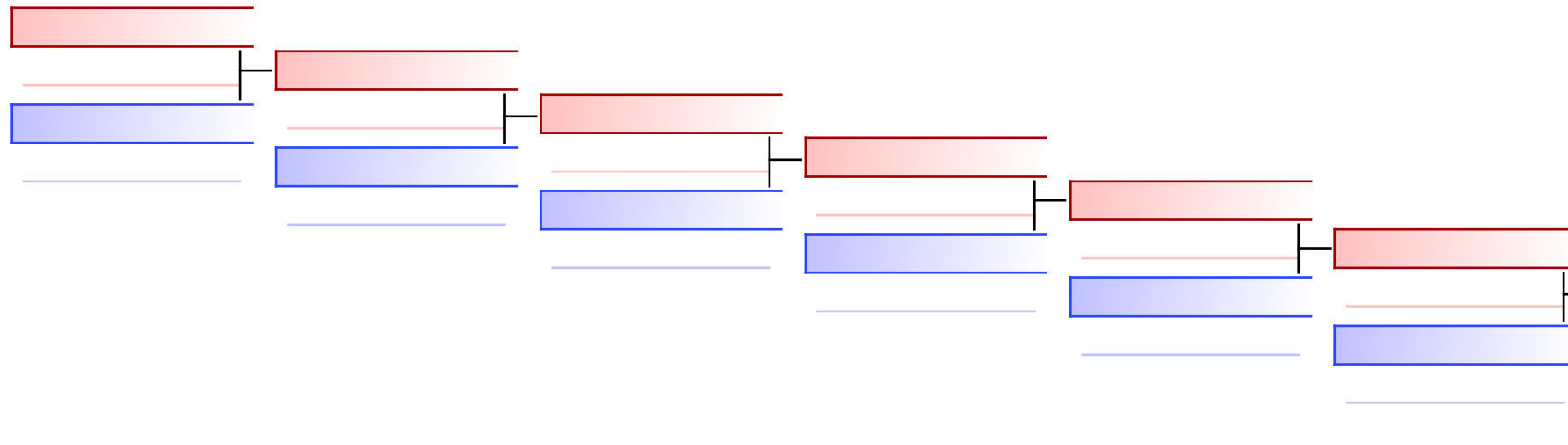

 GUZMAN GERMAN (COL)

8

 MENDEZ CARTER JORGE (MEX)

 MENDEZ CARTER JORGE (MEX)

9

REPECHAGE: (1)

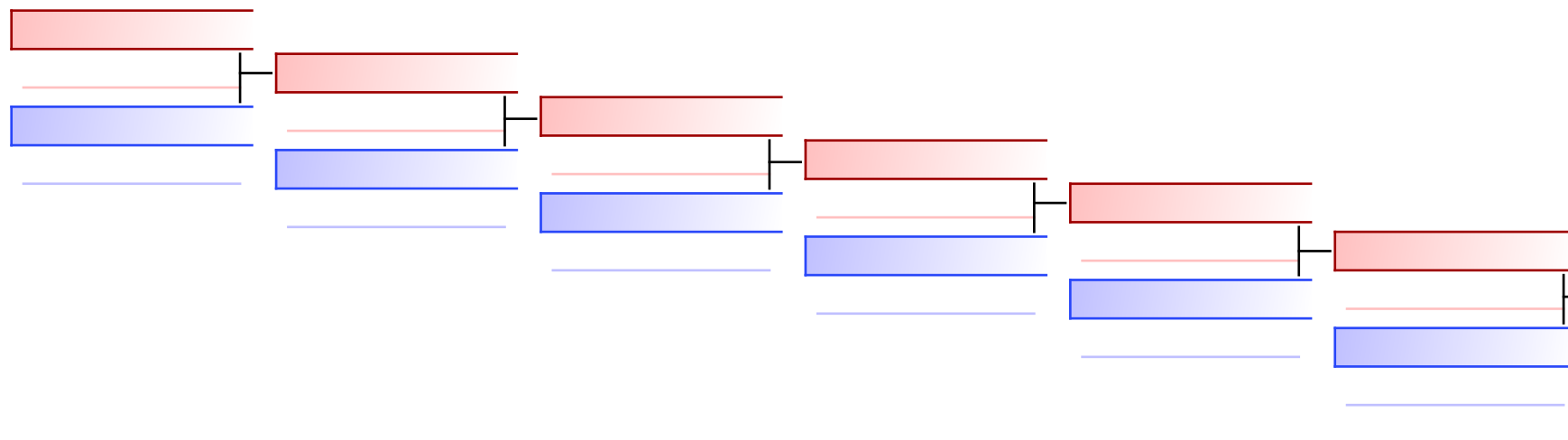

 MEJIA JESUS (COL)

3

 KORBAN ELIAS (KARATE DO)

 KORBAN ELIAS (KARATE DO)

12

Referees:							
-----------	--	--	--	--	--	--	--

U21 KUMITE MALE -84 KG

Campeonato Centroamericano y del Caribe de Karate 2023, Carretera Cocoyoc - Oaxtepec Km 2.5, Centro, 62738 Oaxtepec, MEX

2023-03-03

Tatami
2 15:50

Pool
1/1

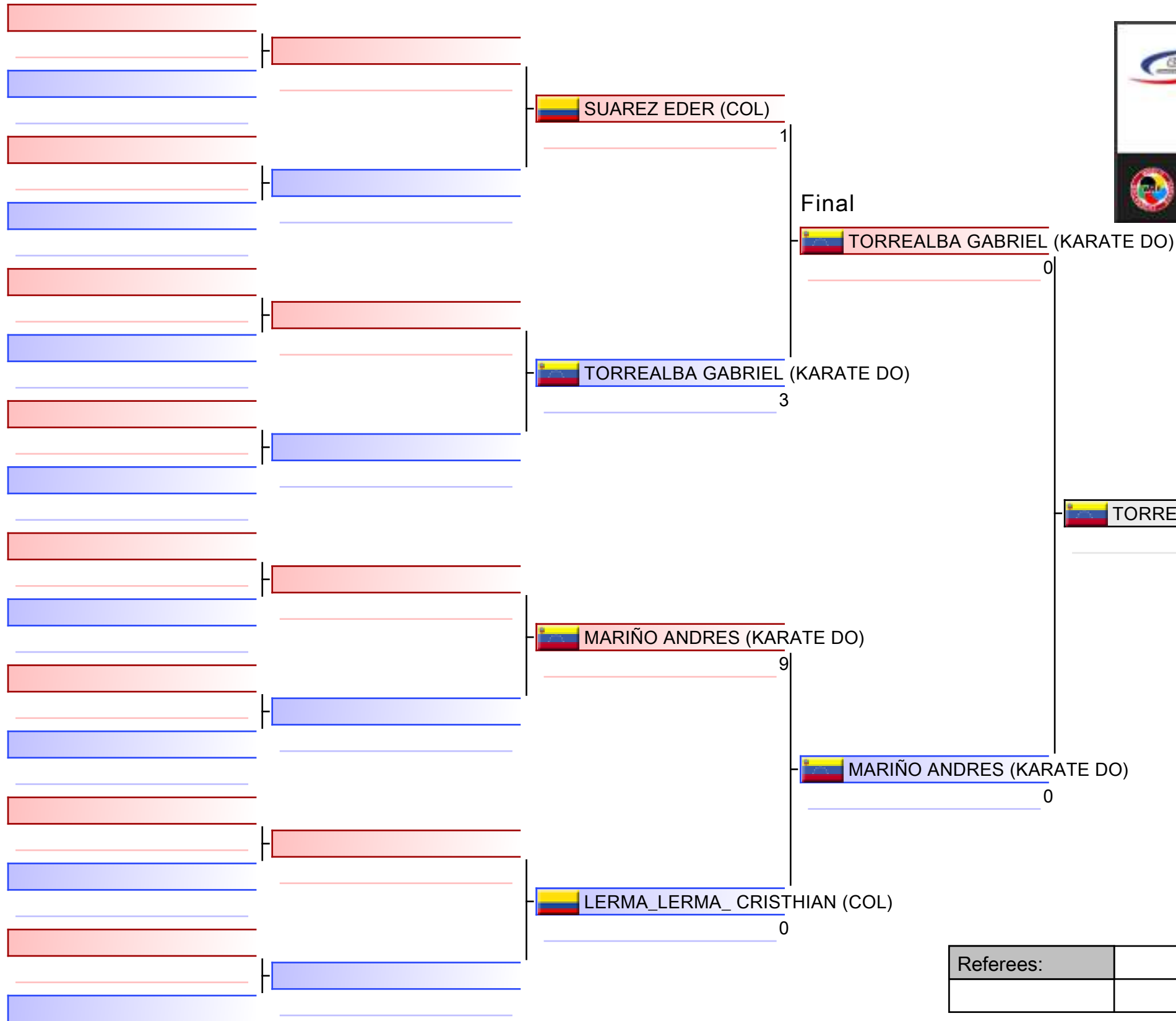

1. TORREALBA GABRIEL (KARATE DO)
2. MARIÑO ANDRES (KARATE DO)
3. SUAREZ EDER (COL)
3. LERMA_LERMA_CRISTHIAN (COL)

Referees:			

U21 KUMITE MALE -84 KG

Campeonato Centroamericano y del Caribe de Karate 2023

(c)sportdata GmbH & Co KG 2000-2023 (2023-03-04 17:55) v 10.0.0 build 1 (2023-02-10) License: Online_Event_ID-6936_CampeonatoCentroamericanoydelCaribedeKarate2023 (expire 2023-03-18)

Tatami

Pool
1

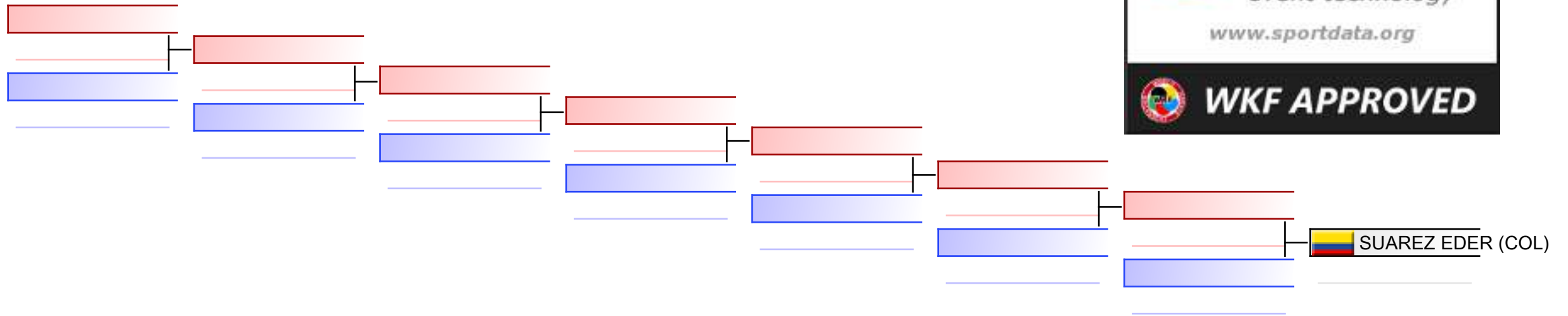

REPECHAGE: (1)

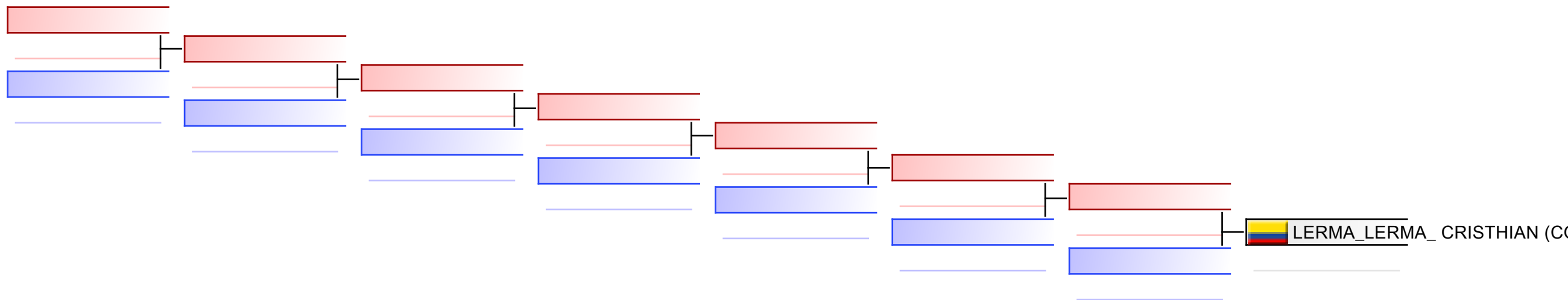

Referees:							
-----------	--	--	--	--	--	--	--

U21 KUMITE MALE 84+ KG

Campeonato Centroamericano y del Caribe de Karate 2023, Carretera Cocoyoc - Oaxtepec Km 2.5, Centro, 62738 Oaxtepec, MEX

Tatami

Pool
1/1

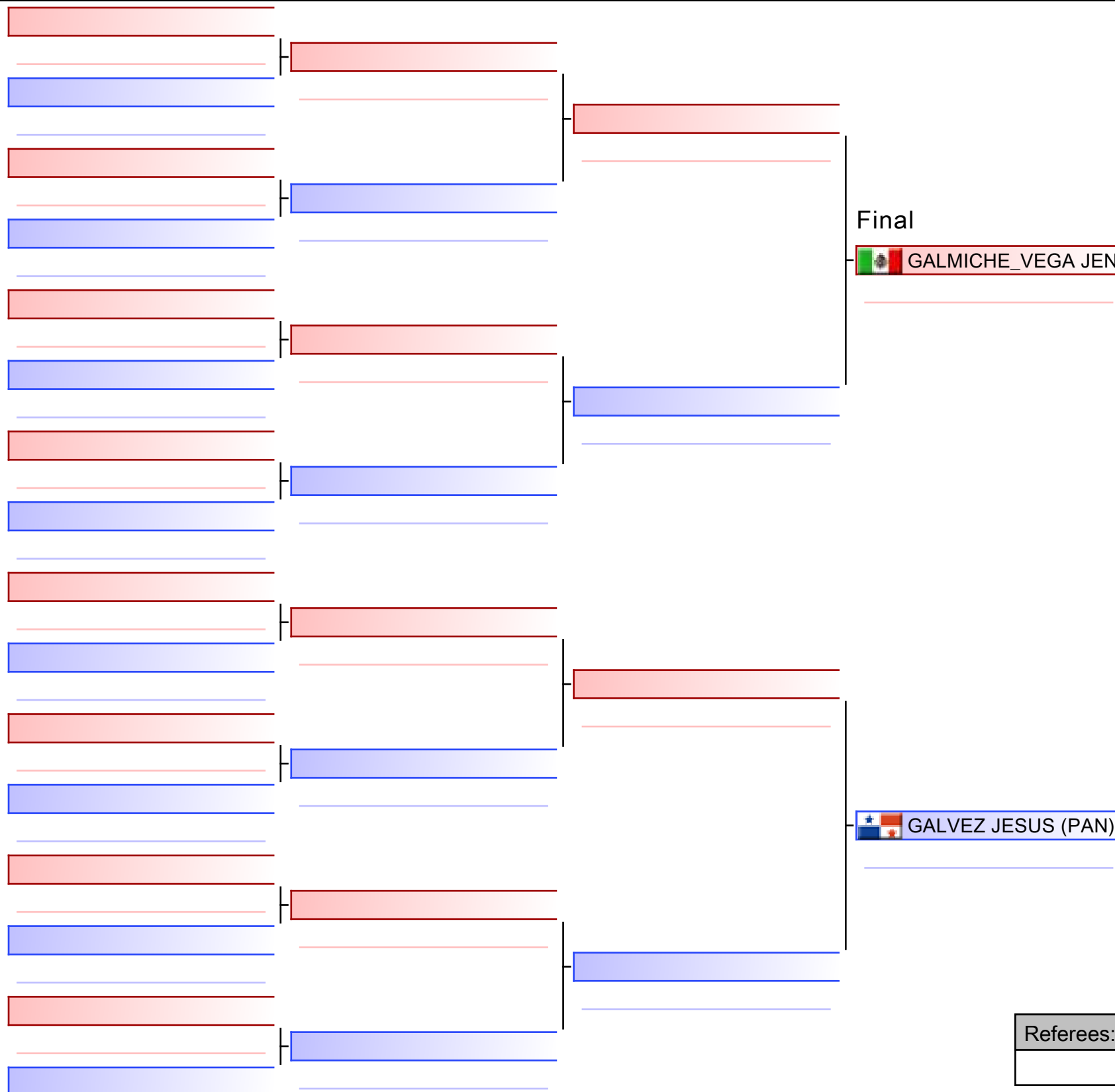

Final

GALMICHE_VEGA JENNER_HIROSHI (MEX)

3

GALMICHE_VEGA JENNER_HIROSHI (MEX)

GALVEZ JESUS (PAN)

8

1. GALMICHE_VEGA JENNER_HIROSHI (MEX)
2. GALVEZ JESUS (PAN)

Referees:			